

1-1 Determine the resultant internal normal force acting on the cross section through point A in each column. In (a), segment BC weighs 180 lb/ft and segment CD weighs 250 lb/ft. In (b), the column has a mass of 200 kg/m.

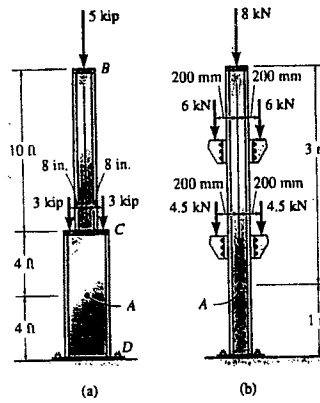

(a)

$$+\uparrow \Sigma F_y = 0; \quad F_A - 1.0 - 3 - 3 - 1.8 - 5 = 0$$

$$F_A = 13.8 \text{ kip} \quad \text{Ans}$$

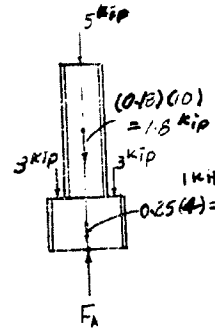

(b)

$$+\uparrow \Sigma F_y = 0; \quad F_A - 4.5 - 4.5 - 5.89 - 6 - 6 - 8 = 0$$

$$F_A = 34.9 \text{ kN} \quad \text{Ans}$$

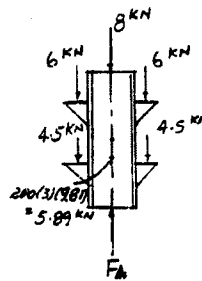

From *Mechanics of Materials*, Sixth Edition by R. C. Hibbeler, ISBN 0-13-191345-X.

© 2005 R. C. Hibbeler. Published by Pearson Prentice Hall,

Pearson Education, Inc., Upper Saddle River, NJ. All rights reserved.

This material is protected under all copyright laws as they currently exist. No portion of this material may be reproduced, in any form or by any means, without permission in writing from the publisher.

1-2 Determine the resultant internal torque acting on the cross sections through points *C* and *D*. The support bearings at *A* and *B* allow free turning of the shaft.

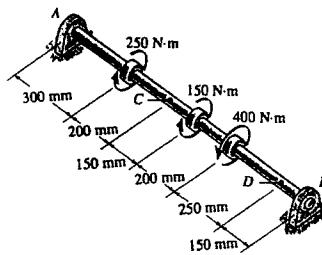

$$\Sigma M_x = 0; \quad T_C - 250 = 0$$

$$T_C = 250 \text{ N} \cdot \text{m} \quad \text{Ans}$$

$$\Sigma M_x = 0; \quad T_D = 0 \quad \text{Ans}$$

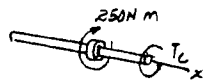

From *Mechanics of Materials*, Sixth Edition by R. C. Hibbeler, ISBN 0-13-191345-X.
 © 2005 R. C. Hibbeler. Published by Pearson Prentice Hall,
 Pearson Education, Inc., Upper Saddle River, NJ. All rights reserved.
 This material is protected under all copyright laws as they currently exist. No portion of this material may be reproduced, in any form or by any means, without permission in writing from the publisher.

1-3 Determine the resultant internal torque acting on the cross sections through points *B* and *C*.

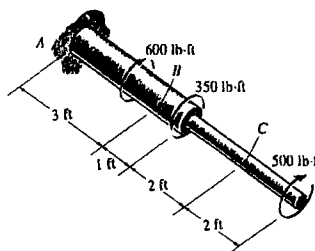

$$\Sigma M_x = 0; \quad T_B + 350 - 500 = 0$$

$$T_B = 150 \text{ lb} \cdot \text{ft} \quad \text{Ans}$$

$$\Sigma M_x = 0; \quad T_C - 500 = 0$$

$$T_C = 500 \text{ lb} \cdot \text{ft} \quad \text{Ans}$$

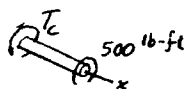
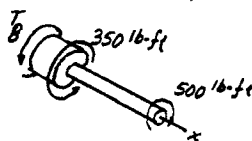

From *Mechanics of Materials*, Sixth Edition by R. C. Hibbeler, ISBN 0-13-191345-X.
 © 2005 R. C. Hibbeler. Published by Pearson Prentice Hall,
 Pearson Education, Inc., Upper Saddle River, NJ. All rights reserved.
 This material is protected under all copyright laws as they currently exist. No portion of this material may be reproduced, in any form or by any means, without permission in writing from the publisher.

*1-4 Determine the resultant internal normal and shear force in the member at (a) section $a-a$ and (b) section $b-b$, each of which passes through point A . The 500-lb load is applied along the centroidal axis of the member.

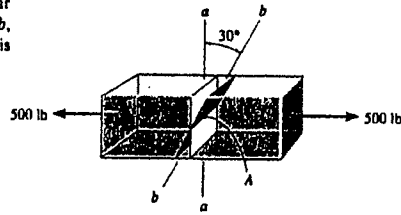

(a)

$$\rightarrow \Sigma F_x = 0; \quad N_a - 500 = 0$$

$$N_a = 500 \text{ lb} \quad \text{Ans}$$

$$+\downarrow \Sigma F_y = 0; \quad V_a = 0 \quad \text{Ans}$$

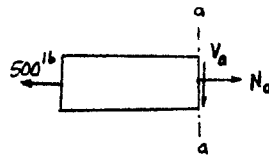

(b)

$$\rightarrow \Sigma F_x = 0; \quad N_b - 500 \cos 30^\circ = 0$$

$$N_b = 433 \text{ lb} \quad \text{Ans}$$

$$+\nearrow \Sigma F_y = 0; \quad V_b - 500 \sin 30^\circ = 0$$

$$V_b = 250 \text{ lb} \quad \text{Ans}$$

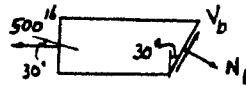

From *Mechanics of Materials*, Sixth Edition by R. C. Hibbeler, ISBN 0-13-191345-X.

© 2005 R. C. Hibbeler. Published by Pearson Prentice Hall,

Pearson Education, Inc., Upper Saddle River, NJ. All rights reserved.

This material is protected under all copyright laws as they currently exist. No portion of this material may be reproduced, in any form or by any means, without permission in writing from the publisher.

1-5 Determine the resultant internal loadings acting on the cross section through point D of member AB.

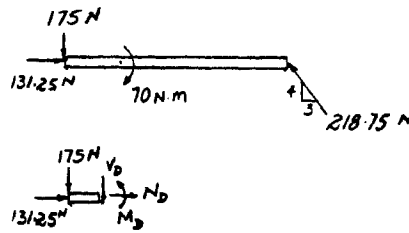
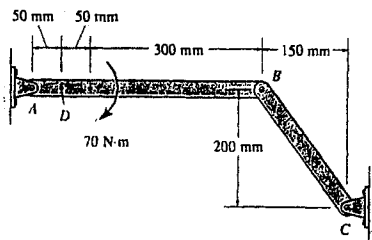

Segment AD :

$$\rightarrow \Sigma F_x = 0; \quad N_D + 131.25 = 0; \quad N_D = -131 \text{ N} \quad \text{Ans}$$

$$+ \downarrow \Sigma F_y = 0; \quad V_D + 175 = 0; \quad V_D = -175 \text{ N} \quad \text{Ans}$$

$$\curvearrowright \Sigma M_D = 0; \quad M_D + 175(0.05) = 0; \quad M_D = -8.75 \text{ N} \cdot \text{m} \quad \text{Ans}$$

From *Mechanics of Materials*, Sixth Edition by R. C. Hibbeler, ISBN 0-13-191345-X.

© 2005 R. C. Hibbeler. Published by Pearson Prentice Hall,

Pearson Education, Inc., Upper Saddle River, NJ. All rights reserved.

This material is protected under all copyright laws as they currently exist. No portion of this material may be reproduced, in any form or by any means, without permission in writing from the publisher.

1-6 The beam AB is pin supported at A and supported by a cable BC . Determine the resultant internal loadings acting on the cross section at point D .

$$\theta = \tan^{-1}\left(\frac{6}{8}\right) = 36.87^\circ$$

$$\phi = \tan^{-1}\left(\frac{10}{8}\right) - 36.87^\circ = 14.47^\circ$$

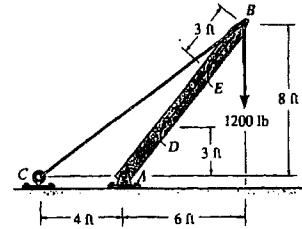

Member AB :

$$\curvearrowleft + \Sigma M_A = 0; \quad F_{BC} \sin 14.47^\circ (10) - 1200(6) = 0$$

$$F_{BC} = 2881.46 \text{ lb}$$

Segment BD :

$$\rightarrow \Sigma F_x = 0; \quad -N_D - 2881.46 \cos 14.47^\circ - 1200 \cos 36.87^\circ = 0$$

$$N_D = -3750 \text{ lb} = -3.75 \text{ kip} \quad \text{Ans}$$

$$\uparrow \Sigma F_y = 0; \quad V_D + 2881.46 \sin 14.47^\circ - 1200 \sin 36.87^\circ = 0$$

$$V_D = 0 \quad \text{Ans}$$

$$\curvearrowleft + \Sigma M_D = 0; \quad 2881.46 \sin 14.47^\circ (6.25) - 1200 \sin 36.87^\circ (6.25) - M_D = 0$$

$$M_D = 0 \quad \text{Ans}$$

Notice that member AB is the two-force member; therefore the shear force and moment are zero.

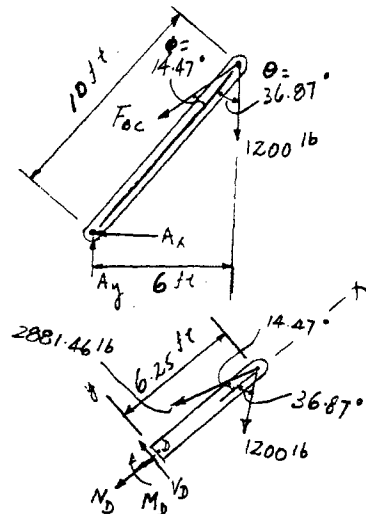

From *Mechanics of Materials*, Sixth Edition by R. C. Hibbeler, ISBN 0-13-191345-X.

© 2005 R. C. Hibbeler. Published by Pearson Prentice Hall,

Pearson Education, Inc., Upper Saddle River, NJ. All rights reserved.

This material is protected under all copyright laws as they currently exist. No portion of this material may be reproduced, in any form or by any means, without permission in writing from the publisher.

1-7 Solve Prob. 1-6 for the resultant internal loadings acting at point E.

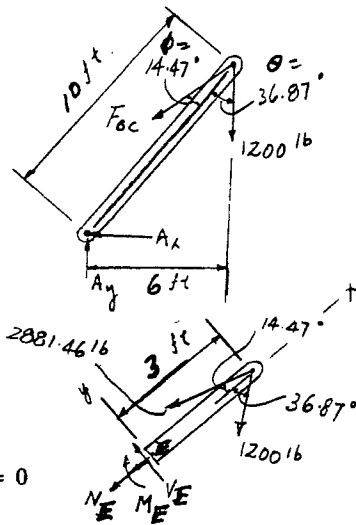
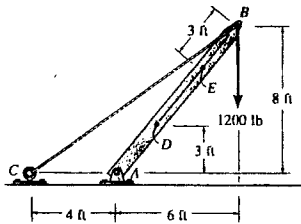

$$\theta = \tan^{-1}\left(\frac{6}{8}\right) = 36.87^\circ$$

$$\phi = \tan^{-1}\left(\frac{10}{8}\right) - 36.87^\circ = 14.47^\circ$$

Member AB :

$$\curvearrowright + \Sigma M_A = 0; \quad F_{BC} \sin 14.47^\circ(10) - 1200(6) = 0$$

$$F_{BC} = 2881.46 \text{ lb}$$

Segment BE :

$$\rightarrow + \Sigma F_x = 0; \quad -N_E - 2881.46 \cos 14.47^\circ - 1200 \cos 36.87^\circ = 0$$

$$N_E = -3750 \text{ lb} = -3.75 \text{ kip} \quad \text{Ans}$$

$$\uparrow + \Sigma F_y = 0; \quad V_E + 2881.46 \sin 14.47^\circ - 1200 \sin 36.87^\circ = 0$$

$$V_E = 0 \quad \text{Ans}$$

$$\curvearrowright + \Sigma M_E = 0; \quad 2881.46 \sin 14.47^\circ(3) - 1200 \sin 36.87^\circ(3) - M_E = 0$$

$$M_E = 0 \quad \text{Ans}$$

Notice that member AB is the two-force member ; therefore the shear force and moment are zero.

From *Mechanics of Materials*, Sixth Edition by R. C. Hibbeler, ISBN 0-13-191345-X.
 © 2005 R. C. Hibbeler. Published by Pearson Prentice Hall,
 Pearson Education, Inc., Upper Saddle River, NJ. All rights reserved.
 This material is protected under all copyright laws as they currently exist. No portion of this material may be reproduced, in any form or by any means, without permission in writing from the publisher.

***1-8.** The beam AB is fixed to the wall and has a uniform weight of 80 lb/ft . If the trolley supports a load of 1500 lb , determine the resultant internal loadings acting on the cross sections through points C and D .

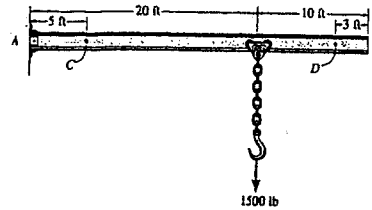

Segment BC :

$$\leftarrow \Sigma F_x = 0; \quad N_C = 0 \quad \text{Ans}$$

$$+\uparrow \Sigma F_y = 0; \quad V_C - 2.0 - 1.5 = 0$$

$$V_C = 3.50 \text{ kip} \quad \text{Ans}$$

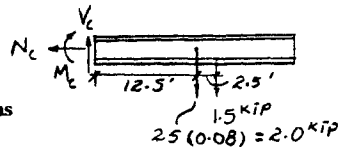

$$\leftarrow + \Sigma M_C = 0; \quad -M_C - 2(12.5) - 1.5(15) = 0$$

$$M_C = -47.5 \text{ kip} \cdot \text{ft} \quad \text{Ans}$$

Segment BD :

$$\leftarrow \Sigma F_x = 0; \quad N_D = 0 \quad \text{Ans}$$

$$+\uparrow \Sigma F_y = 0; \quad V_D - 0.24 = 0$$

$$V_D = 0.240 \text{ kip} \quad \text{Ans}$$

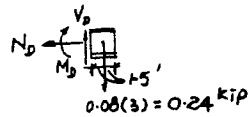

$$\leftarrow + \Sigma M_D = 0; \quad -M_D - 0.24(1.5) = 0$$

$$M_D = -0.360 \text{ kip} \cdot \text{ft} \quad \text{Ans}$$

From *Mechanics of Materials*, Sixth Edition by R. C. Hibbeler, ISBN 0-13-191345-X.

© 2005 R. C. Hibbeler. Published by Pearson Prentice Hall,

Pearson Education, Inc., Upper Saddle River, NJ. All rights reserved.

This material is protected under all copyright laws as they currently exist. No portion of this material may be reproduced, in any form or by any means, without permission in writing from the publisher.

1-9. Determine the resultant internal loadings acting on the cross section at point C. The cooling unit has a total weight of 52 kip and a center of gravity at G.

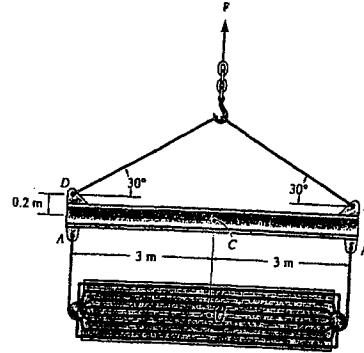

From FBD (a)

$$\left(+ \sum M_A = 0; \quad T_B(6) - 52(3) = 0; \quad T_B = 26 \text{ kip} \right.$$

From FBD (b)

$$\left(+ \sum M_D = 0; \quad T_E \sin 30^\circ(6) - 26(6) = 0; \quad T_E = 52 \text{ kip} \right.$$

From FBD (c)

$$\rightarrow \sum F_x = 0; \quad -N_C - 52 \cos 30^\circ = 0; \quad N_C = -45.0 \text{ kip} \quad \text{Ans}$$

$$+ \uparrow \sum F_y = 0; \quad V_C + 52 \sin 30^\circ - 26 = 0; \quad V_C = 0 \quad \text{Ans}$$

$$\left(+ \sum M_C = 0; \quad 52 \cos 30^\circ(0.2) + 52 \sin 30^\circ(3) - 26(3) - M_C = 0 \right. \\ \left. M_C = 9.00 \text{ kip} \cdot \text{ft} \quad \text{Ans} \right.$$

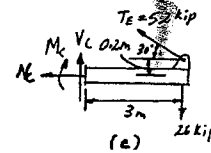
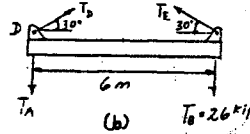
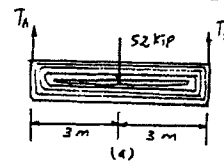

From *Mechanics of Materials*, Sixth Edition by R. C. Hibbeler, ISBN 0-13-191345-X.

© 2005 R. C. Hibbeler. Published by Pearson Prentice Hall,

Pearson Education, Inc., Upper Saddle River, NJ. All rights reserved.

This material is protected under all copyright laws as they currently exist. No portion of this material may be reproduced, in any form or by any means, without permission in writing from the publisher.

1-10 Determine the resultant internal loadings acting on the cross sections through points *D* and *E* of the frame.

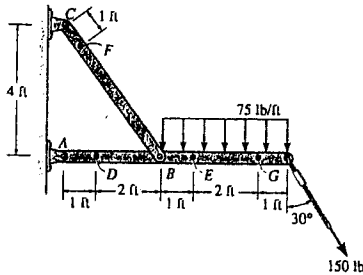

Member *AG* :

$$\left(+ \sum M_A = 0; \frac{4}{5} F_{BC} (3) - 75(4)(5) - 150 \cos 30^\circ (7) = 0; F_{BC} = 1003.89 \text{ lb} \right.$$

$$\left(+ \sum M_B = 0; A_y (3) - 75(4)(2) - 150 \cos 30^\circ (4) = 0; A_y = 373.20 \text{ lb} \right.$$

$$\rightarrow \sum F_x = 0; A_x - \frac{3}{5} (1003.89) + 150 \sin 30^\circ = 0; A_x = 527.33 \text{ lb}$$

For point *D* :

$$\rightarrow \sum F_x = 0; N_D + 527.33 = 0$$

$$N_D = -527 \text{ lb}$$

Ans

$$+ \uparrow \sum F_y = 0; -373.20 - V_D = 0$$

$$V_D = -373 \text{ lb}$$

Ans

$$\left(+ \sum M_D = 0; M_D + 373.20(1) = 0 \right.$$

$$M_D = -373 \text{ lb} \cdot \text{ft}$$

Ans

For point *E* :

$$\rightarrow \sum F_x = 0; 150 \sin 30^\circ - N_E = 0$$

$$N_E = 75.0 \text{ lb}$$

Ans

$$+ \uparrow \sum F_y = 0; V_E - 75(3) - 150 \cos 30^\circ = 0$$

$$V_E = 355 \text{ lb}$$

Ans

$$\left(+ \sum M_E = 0; -M_E - 75(3)(1.5) - 150 \cos 30^\circ (3) = 0; \right.$$

$$M_E = -727 \text{ lb} \cdot \text{ft}$$

Ans

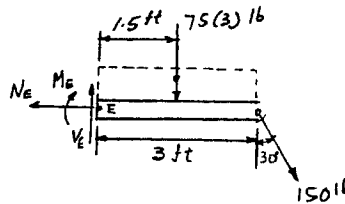
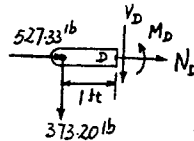
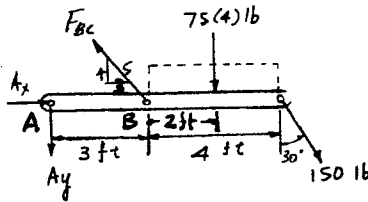

From *Mechanics of Materials*, Sixth Edition by R. C. Hibbeler, ISBN 0-13-191345-X.

© 2005 R. C. Hibbeler. Published by Pearson Prentice Hall,

Pearson Education, Inc., Upper Saddle River, NJ. All rights reserved.

This material is protected under all copyright laws as they currently exist. No portion of this material may be reproduced, in any form or by any means, without permission in writing from the publisher.

1-11 Determine the resultant internal loadings acting on the cross sections through points *F* and *G* of the frame.

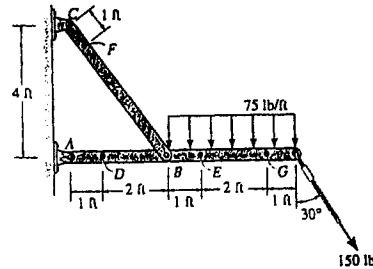

Member *AG* :

$$\curvearrowleft + \Sigma M_A = 0; \quad \frac{4}{5} F_{BF}(3) - 300(5) - 150 \cos 30^\circ (7) = 0$$

$$F_{BF} = 1003.9 \text{ lb}$$

For point *F* :

$$\rightarrow + \Sigma F_x = 0; \quad V_F = 0 \quad \text{Ans}$$

$$\uparrow + \Sigma F_y = 0; \quad N_F - 1003.9 = 0$$

$$N_F = 1004 \text{ lb} \quad \text{Ans}$$

$$\curvearrowleft + \Sigma M_F = 0; \quad M_F = 0 \quad \text{Ans}$$

For point *G* :

$$\leftarrow + \Sigma F_x = 0; \quad N_G - 150 \sin 30^\circ = 0$$

$$N_G = 75.0 \text{ lb} \quad \text{Ans}$$

$$+ \uparrow \Sigma F_y = 0; \quad V_G - 75(1) - 150 \cos 30^\circ = 0$$

$$V_G = 205 \text{ lb} \quad \text{Ans}$$

$$\curvearrowleft + \Sigma M_G = 0; \quad -M_G - 75(1)(0.5) - 150 \cos 30^\circ (1) = 0$$

$$M_G = -167 \text{ lb} \cdot \text{ft} \quad \text{Ans}$$

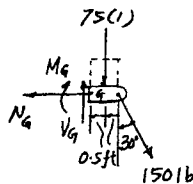
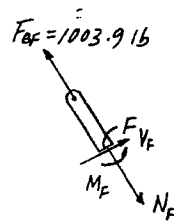
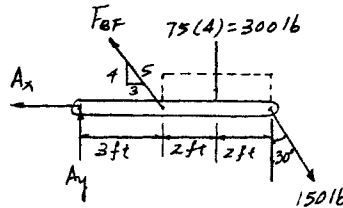

From *Mechanics of Materials*, Sixth Edition by R. C. Hibbeler, ISBN 0-13-191345-X.
 © 2005 R. C. Hibbeler. Published by Pearson Prentice Hall,
 Pearson Education, Inc., Upper Saddle River, NJ. All rights reserved.
 This material is protected under all copyright laws as they currently exist. No portion of this material may be reproduced, in any form or by any means, without permission in writing from the publisher.

*1-12 Determine the resultant internal loadings acting on (a) section a-a and (b) section b-b. Each section is located through the centroid, point C.

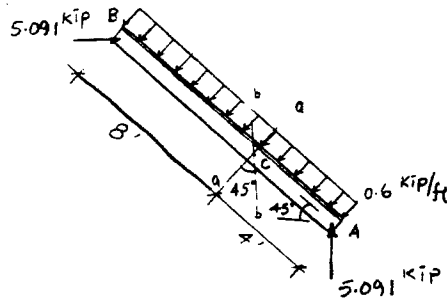
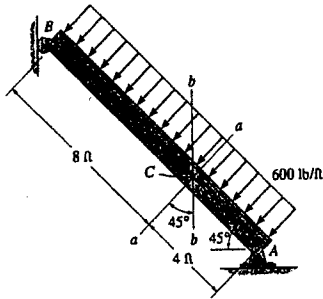

(a)

$$\begin{aligned} \rightarrow \Sigma F_x = 0; & \quad N_C + 5.091 \sin 45^\circ = 0 \\ & \quad N_C = -3.60 \text{ kip} \quad \text{Ans} \\ \nearrow \Sigma F_y = 0; & \quad V_C + 5.091 \cos 45^\circ - 2.4 = 0 \\ & \quad V_C = -1.20 \text{ kip} \quad \text{Ans} \\ \curvearrowright \Sigma M_C = 0; & \quad -M_C - 2.4(2) + 5.091 \cos 45^\circ(4) = 0 \\ & \quad M_C = 9.60 \text{ kip} \cdot \text{ft} \quad \text{Ans} \end{aligned}$$

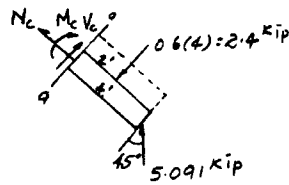

(b)

$$\begin{aligned} \leftarrow \Sigma F_x = 0; & \quad N_C + 2.4 \cos 45^\circ = 0 \\ & \quad N_C = -1.70 \text{ kip} \quad \text{Ans} \\ + \uparrow \Sigma F_y = 0; & \quad V_C + 5.091 - 2.4 \sin 45^\circ = 0 \\ & \quad V_C = -3.39 \text{ kip} \quad \text{Ans} \\ \curvearrowright \Sigma M_C = 0; & \quad -M_C - 2.4(2) + 5.091 \cos 45^\circ(4) = 0 \\ & \quad M_C = 9.60 \text{ kip} \cdot \text{ft} \quad \text{Ans} \end{aligned}$$

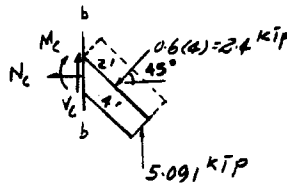

From *Mechanics of Materials*, Sixth Edition by R. C. Hibbeler, ISBN 0-13-191345-X.
 © 2005 R. C. Hibbeler. Published by Pearson Prentice Hall,
 Pearson Education, Inc., Upper Saddle River, NJ. All rights reserved.
 This material is protected under all copyright laws as they currently exist. No portion of this material may be reproduced, in any form or by any means, without permission in writing from the publisher.

1-13 Determine the resultant internal loadings acting on the cross section through point C in the beam. The load D has a mass of 300 kg and is being hoisted by the motor M with constant velocity.

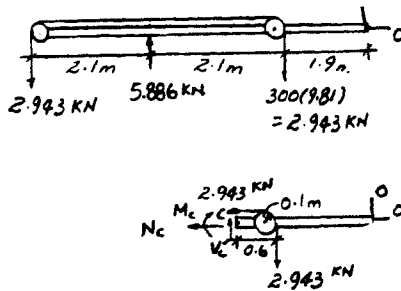
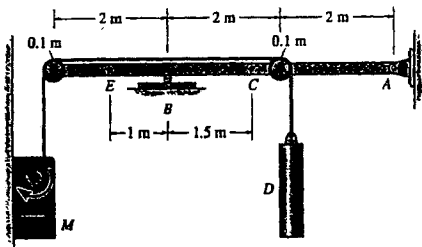

$$\leftarrow \Sigma F_x = 0; \quad N_C + 2.943 = 0; \quad N_C = -2.94 \text{ kN} \quad \text{Ans}$$

$$+\uparrow \Sigma F_y = 0; \quad V_C - 2.943 = 0; \quad V_C = 2.94 \text{ kN} \quad \text{Ans}$$

$$\curvearrowright \Sigma M_C = 0; \quad -M_C - 2.943(0.6) + 2.943(0.1) = 0$$

$$M_C = -1.47 \text{ kN} \cdot \text{m} \quad \text{Ans}$$

From *Mechanics of Materials*, Sixth Edition by R. C. Hibbeler, ISBN 0-13-191345-X.

© 2005 R. C. Hibbeler. Published by Pearson Prentice Hall,

Pearson Education, Inc., Upper Saddle River, NJ. All rights reserved.

This material is protected under all copyright laws as they currently exist. No portion of this material may be reproduced, in any form or by any means, without permission in writing from the publisher.

1-14 Determine the resultant internal loadings acting on the cross section through point E of the beam in Prob. 1-13.

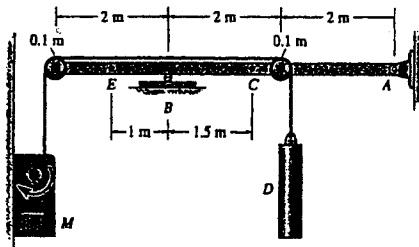

$$\rightarrow \Sigma F_x = 0; \quad N_E + 2943 = 0$$

$$N_E = -2.94 \text{ kN} \quad \text{Ans}$$

$$+\uparrow \Sigma F_y = 0; \quad -2943 - V_E = 0$$

$$V_E = -2.94 \text{ kN} \quad \text{Ans}$$

$$\curvearrow + \Sigma M_E = 0; \quad M_E + 2943(1) = 0$$

$$M_E = -2.94 \text{ kN} \cdot \text{m} \quad \text{Ans}$$

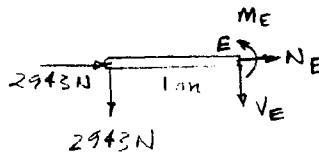

From *Mechanics of Materials*, Sixth Edition by R. C. Hibbeler, ISBN 0-13-191345-X.
 © 2005 R. C. Hibbeler. Published by Pearson Prentice Hall,
 Pearson Education, Inc., Upper Saddle River, NJ. All rights reserved.
 This material is protected under all copyright laws as they currently exist. No portion of this material may be reproduced, in any form or by any means, without permission in writing from the publisher.

1-15 The 800-lb load is being hoisted at a constant speed using the motor M , which has a weight of 90 lb. Determine the resultant internal loadings acting on the cross section through point B in the beam. The beam has a weight of 40 lb/ft and is fixed to the wall at A .

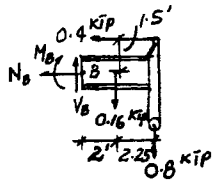
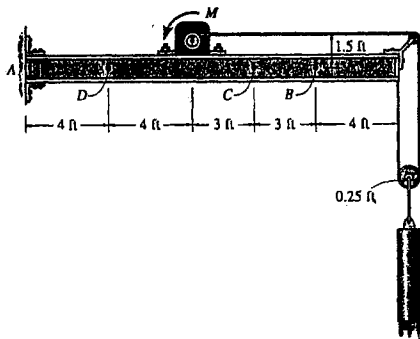

$$\rightarrow \Sigma F_x = 0; \quad -N_B - 0.4 = 0$$

$$N_B = -0.4 \text{ kip} \quad \text{Ans}$$

$$+\uparrow \Sigma F_y = 0; \quad V_B - 0.8 - 0.16 = 0$$

$$V_B = 0.960 \text{ kip} \quad \text{Ans}$$

$$\curvearrowright \Sigma M_B = 0; \quad -M_B - 0.16(2) - 0.8(4.25) + 0.4(1.5) = 0$$

$$M_B = -3.12 \text{ kip} \cdot \text{ft} \quad \text{Ans}$$

From *Mechanics of Materials*, Sixth Edition by R. C. Hibbeler, ISBN 0-13-191345-X.

© 2005 R. C. Hibbeler. Published by Pearson Prentice Hall,

Pearson Education, Inc., Upper Saddle River, NJ. All rights reserved.

This material is protected under all copyright laws as they currently exist. No portion of this material may be reproduced, in any form or by any means, without permission in writing from the publisher.

***1-16.** Determine the resultant internal loadings acting on the cross section through points *C* and *D* of the beam in Prob. 1-15.

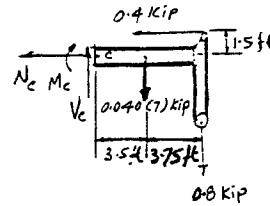
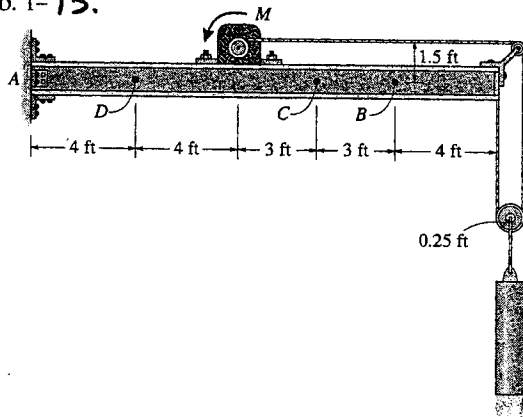

For point *C* :

$$\leftarrow \Sigma F_x = 0; \quad N_C + 0.4 = 0; \quad N_C = -0.4 \text{ kip} \quad \text{Ans}$$

$$+\uparrow \Sigma F_y = 0; \quad V_C - 0.8 - 0.04(7) = 0; \quad V_C = 1.08 \text{ kip} \quad \text{Ans}$$

$$\begin{aligned} (+\Sigma M_C = 0; \quad -M_C - 0.8(7.25) - 0.04(7)(3.5) + 0.4(1.5) = 0 \\ M_C = -6.18 \text{ kip} \cdot \text{ft} \quad \text{Ans} \end{aligned}$$

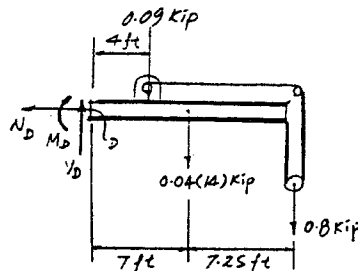

For point *D* :

$$\leftarrow \Sigma F_x = 0; \quad N_D = 0 \quad \text{Ans}$$

$$+\uparrow \Sigma F_y = 0; \quad V_D - 0.09 - 0.04(14) - 0.8 = 0; \quad V_D = 1.45 \text{ kip} \quad \text{Ans}$$

$$\begin{aligned} (+\Sigma M_D = 0; \quad -M_D - 0.09(4) - 0.04(14)(7) - 0.8(14.25) = 0 \\ M_D = -15.7 \text{ kip} \cdot \text{ft} \quad \text{Ans} \end{aligned}$$

From *Mechanics of Materials*, Sixth Edition by R. C. Hibbeler, ISBN 0-13-191345-X.

© 2005 R. C. Hibbeler. Published by Pearson Prentice Hall,

Pearson Education, Inc., Upper Saddle River, NJ. All rights reserved.

This material is protected under all copyright laws as they currently exist. No portion of this material may be reproduced, in any form or by any means, without permission in writing from the publisher.

1-17. Determine the resultant internal loadings acting on the cross section at point *B*.

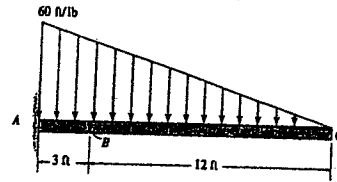

$$\rightarrow \Sigma F_x = 0; \quad N_B = 0 \quad \text{Ans}$$

$$+\uparrow \Sigma F_y = 0; \quad V_B - \frac{1}{2}(48)(12) = 0$$

$$V_B = 288 \text{ lb} \quad \text{Ans}$$

$$\curvearrowright \Sigma M_B = 0; \quad -M_B - \frac{1}{2}(48)(12)(4) = 0$$

$$M_B = -1152 \text{ lb} \cdot \text{ft} = -1.15 \text{ kip} \cdot \text{ft} \quad \text{Ans}$$

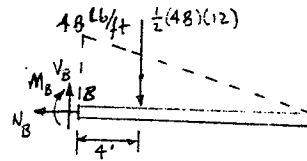

From *Mechanics of Materials*, Sixth Edition by R. C. Hibbeler, ISBN 0-13-191345-X.
 © 2005 R. C. Hibbeler. Published by Pearson Prentice Hall,
 Pearson Education, Inc., Upper Saddle River, NJ. All rights reserved.
 This material is protected under all copyright laws as they currently exist. No portion of this material may be reproduced, in any form or by any means, without permission in writing from the publisher.

1-18 The beam supports the distributed load shown. Determine the resultant internal loadings acting on the cross section through point C. Assume the reactions at the supports A and B are vertical.

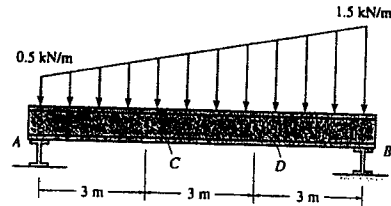

$$\rightarrow \Sigma F_x = 0; \quad N_C = 0 \quad \text{Ans}$$

$$+\downarrow \Sigma F_y = 0; \quad V_C + 0.5 + 1.5 - 3.75 = 0$$

$$V_C = 1.75 \text{ kN} \quad \text{Ans}$$

$$\curvearrowright \Sigma M_C = 0; \quad M_C + 0.5(1) + 1.5(1.5) - 3.75(3) = 0$$

$$M_C = 8.50 \text{ kN} \cdot \text{m} \quad \text{Ans}$$

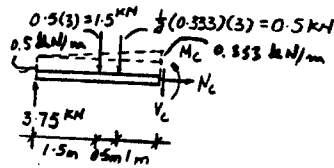

From *Mechanics of Materials*, Sixth Edition by R. C. Hibbeler, ISBN 0-13-191345-X.

© 2005 R. C. Hibbeler. Published by Pearson Prentice Hall,

Pearson Education, Inc., Upper Saddle River, NJ. All rights reserved.

This material is protected under all copyright laws as they currently exist. No portion of this material may be reproduced, in any form or by any means, without permission in writing from the publisher.

1-19 Determine the resultant internal loadings acting on the cross section through point *D* in Prob. 1-18.

$$\rightarrow \Sigma F_x = 0; \quad N_D = 0 \quad \text{Ans}$$

$$+\uparrow \Sigma F_y = 0; \quad 3.75 - 3 - 2 - V_D = 0$$

$$V_D = -1.25 \text{ kN} \quad \text{Ans}$$

$$\curvearrow + \Sigma M_D = 0; \quad M_D + 2(2) + 3(3) - 3.75(6) = 0$$

$$M_D = 9.50 \text{ kN} \cdot \text{m} \quad \text{Ans}$$

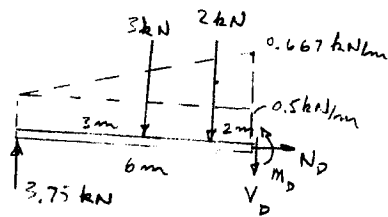
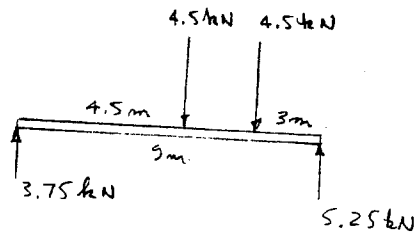
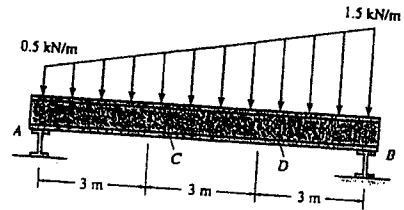

From *Mechanics of Materials*, Sixth Edition by R. C. Hibbeler, ISBN 0-13-191345-X.

© 2005 R. C. Hibbeler. Published by Pearson Prentice Hall,

Pearson Education, Inc., Upper Saddle River, NJ. All rights reserved.

This material is protected under all copyright laws as they currently exist. No portion of this material may be reproduced, in any form or by any means, without permission in writing from the publisher.

***1-20.** The serving tray T used on an airplane is supported on *each side* by an arm. The tray is pin connected to the arm at A , and at B there is a smooth pin. (The pin can move within the slot in the arms to permit folding the tray against the front passenger seat when not in use.) Determine the resultant internal loadings acting on the cross section of the arm through point C when the tray arm supports the loads shown.

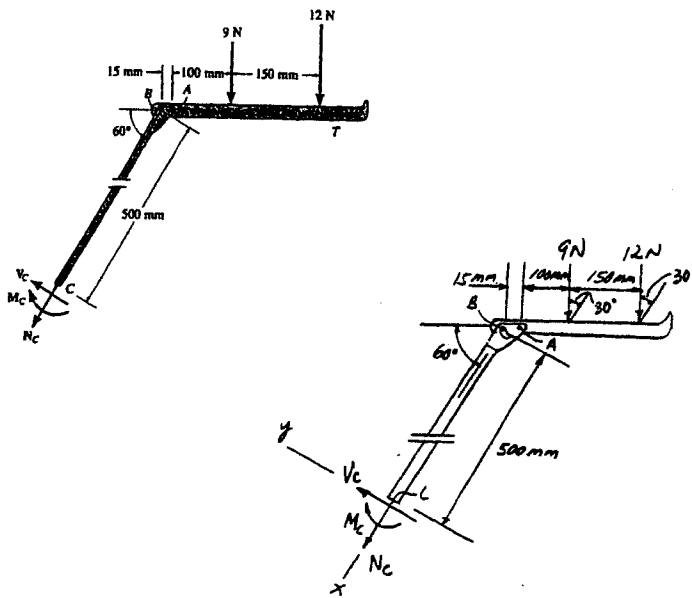

$$\sum F_x = 0; \quad N_C + 9 \cos 30^\circ + 12 \cos 30^\circ = 0; \quad N_C = -18.2 \text{ N} \quad \text{Ans}$$

$$\sum F_y = 0; \quad V_C - 9 \sin 30^\circ - 12 \sin 30^\circ = 0; \quad V_C = 10.5 \text{ N} \quad \text{Ans}$$

$$\sum M_C = 0; \quad -M_C - 9(0.5 \cos 60^\circ + 0.115) - 12(0.5 \cos 60^\circ + 0.265) = 0$$

$$M_C = -9.46 \text{ N}\cdot\text{m} \quad \text{Ans}$$

From *Mechanics of Materials*, Sixth Edition by R. C. Hibbeler, ISBN 0-13-191345-X.

© 2005 R. C. Hibbeler. Published by Pearson Prentice Hall,

Pearson Education, Inc., Upper Saddle River, NJ. All rights reserved.

This material is protected under all copyright laws as they currently exist. No portion of this material may be reproduced, in any form or by any means, without permission in writing from the publisher.

1-21. The metal stud punch is subjected to a force of 120 N on the handle. Determine the magnitude of the reactive force at the pin *A* and in the short link *BC*. Also, determine the internal resultant loadings acting on the cross section passing through the handle arm at *D*.

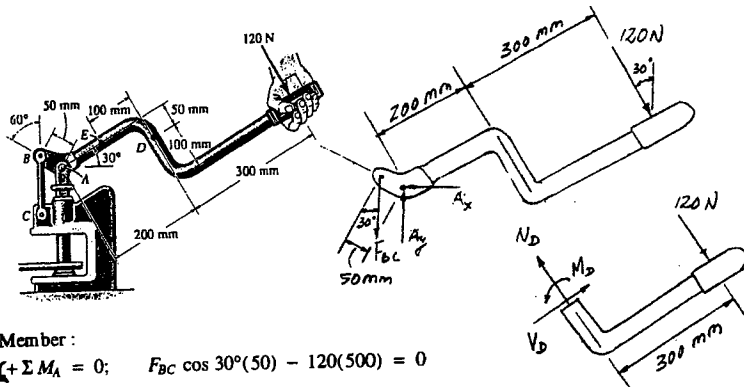

Member :

$$\zeta + \Sigma M_A = 0; \quad F_{BC} \cos 30^\circ (50) - 120(500) = 0$$

$$F_{BC} = 1385.6 \text{ N} = 1.39 \text{ kN} \quad \text{Ans}$$

$$+ \uparrow \Sigma F_y = 0; \quad A_y - 1385.6 - 120 \cos 30^\circ = 0$$

$$A_y = 1489.56 \text{ N}$$

$$\leftarrow \Sigma F_x = 0; \quad A_x - 120 \sin 30^\circ = 0; \quad A_x = 60 \text{ N}$$

$$F_A = \sqrt{1489.56^2 + 60^2} \\ = 1490 \text{ N} = 1.49 \text{ kN} \quad \text{Ans}$$

Segment :

$$\swarrow + \Sigma F_x = 0; \quad N_D - 120 = 0$$

$$N_D = 120 \text{ N} = 0.12 \text{ kN} \quad \text{Ans}$$

$$\nearrow + \Sigma F_y = 0; \quad V_D = 0 \quad \text{Ans}$$

$$\zeta + \Sigma M_D = 0; \quad M_D - 120(0.3) = 0$$

$$M_D = 36.0 \text{ N} \cdot \text{m} \quad \text{Ans}$$

From *Mechanics of Materials*, Sixth Edition by R. C. Hibbeler, ISBN 0-13-191345-X.

© 2005 R. C. Hibbeler. Published by Pearson Prentice Hall,

Pearson Education, Inc., Upper Saddle River, NJ. All rights reserved.

This material is protected under all copyright laws as they currently exist. No portion of this material may be reproduced, in any form or by any means, without permission in writing from the publisher.

1-22. Solve Prob. 1-21 for the resultant internal loadings acting on the cross section passing through the handle arm at E and at a cross section of the short link BC .

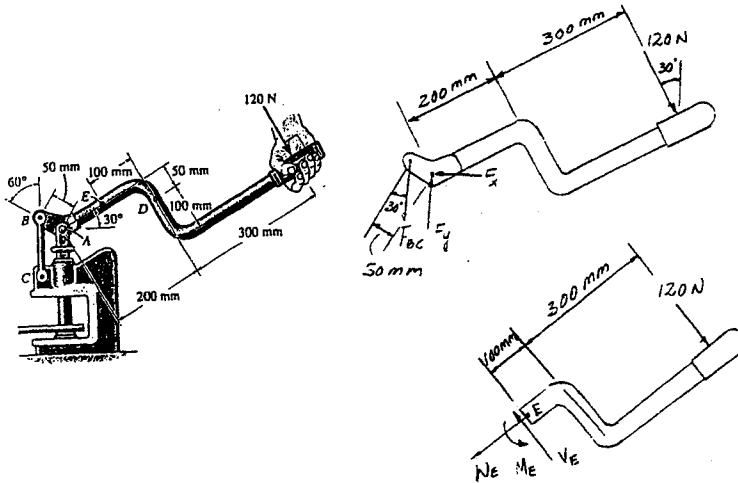

Member :

$$\curvearrowleft \Sigma M_A = 0; \quad F_{BC} \cos 30^\circ (50) - 120(500) = 0$$

$$F_{BC} = 1385.6 \text{ N} = 1.3856 \text{ kN}$$

Segment :

$$\nearrow \Sigma F_x = 0; \quad N_E = 0 \quad \text{Ans}$$

$$\nabla \Sigma F_y = 0; \quad V_E - 120 = 0; \quad V_E = 120 \text{ N} \quad \text{Ans}$$

$$\curvearrowleft \Sigma M_E = 0; \quad M_E - 120(0.4) = 0; \quad M_E = 48.0 \text{ N}\cdot\text{m} \quad \text{Ans}$$

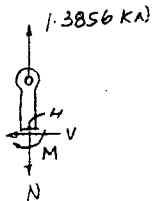

Short link :

$$\rightarrow \Sigma F_x = 0; \quad V = 0 \quad \text{Ans}$$

$$+\uparrow \Sigma F_y = 0; \quad 1.3856 - N = 0; \quad N = 1.39 \text{ kN} \quad \text{Ans}$$

$$\curvearrowleft \Sigma M_H = 0; \quad M = 0 \quad \text{Ans}$$

From *Mechanics of Materials*, Sixth Edition by R. C. Hibbeler, ISBN 0-13-191345-X.

© 2005 R. C. Hibbeler. Published by Pearson Prentice Hall,

Pearson Education, Inc., Upper Saddle River, NJ. All rights reserved.

This material is protected under all copyright laws as they currently exist. No portion of this material may be reproduced, in any form or by any means, without permission in writing from the publisher.

1-23 The pipe has a mass of 12 kg/m. If it is fixed to the wall at A, determine the resultant internal loadings acting on the cross section at B. Neglect the weight of the wrench CD.

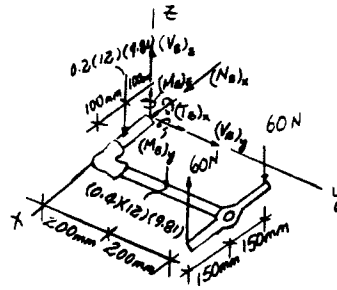
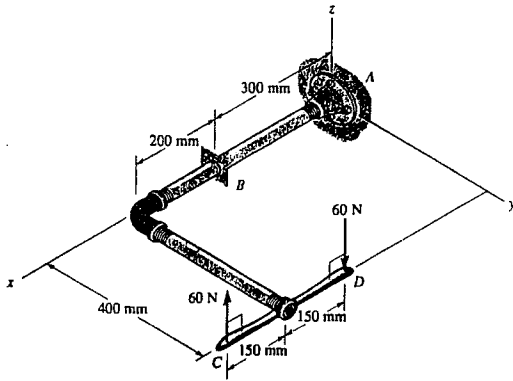

$$\Sigma F_x = 0; \quad (N_B)_x = 0 \quad \text{Ans}$$

$$\Sigma F_y = 0; \quad (V_B)_y = 0 \quad \text{Ans}$$

$$\Sigma F_z = 0; \quad (V_B)_z - 60 + 60 - (0.2)(12)(9.81) - (0.4)(12)(9.81) = 0$$

$$(V_B)_z = 70.6 \text{ N} \quad \text{Ans}$$

$$\Sigma M_x = 0; \quad (T_B)_x + 60(0.4) - 60(0.4) - (0.4)(12)(9.81)(0.2) = 0$$

$$(T_B)_x = 9.42 \text{ N} \cdot \text{m} \quad \text{Ans}$$

$$\Sigma M_y = 0; \quad (M_B)_y + (0.2)(12)(9.81)(0.1) + (0.4)(12)(9.81)(0.2) - 60(0.3) = 0$$

$$(M_B)_y = 6.23 \text{ N} \cdot \text{m} \quad \text{Ans}$$

$$\Sigma M_z = 0; \quad (M_B)_z = 0 \quad \text{Ans}$$

From *Mechanics of Materials*, Sixth Edition by R. C. Hibbeler, ISBN 0-13-191345-X.

© 2005 R. C. Hibbeler. Published by Pearson Prentice Hall,

Pearson Education, Inc., Upper Saddle River, NJ. All rights reserved.

This material is protected under all copyright laws as they currently exist. No portion of this material may be reproduced, in any form or by any means, without permission in writing from the publisher.

*1-24 The main beam AB supports the load on the wing of the airplane. The loads consist of the wheel reaction of 35 000 lb at C , the 1200-lb weight of fuel in the tank of the wing, having a center of gravity at D , and the 400-lb weight of the wing, having a center of gravity at E . If it is fixed to the fuselage at A , determine the resultant internal loadings on the beam at this point. Assume that the wing does not transfer any of the loads to the fuselage, except through the beam.

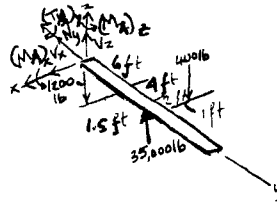
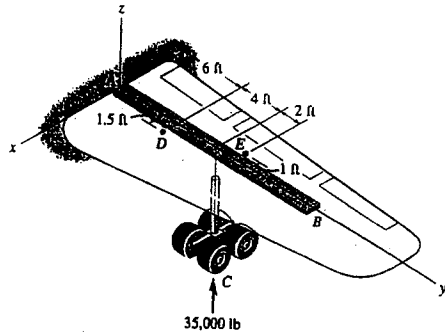

$$\Sigma F_x = 0; \quad (V_A)_x = 0$$

Ans

$$\Sigma F_y = 0; \quad (N_A)_y = 0$$

Ans

$$\Sigma F_z = 0; \quad (V_A)_z - 1200 - 400 + 35000 = 0$$

$$(V_A)_z = -33.4 \text{ kip} \quad \text{Ans}$$

$$\Sigma M_x = 0; \quad (M_A)_x - 1200(6) + 35000(10) - 400(12) = 0$$

$$(M_A)_x = 338 \text{ kip} \cdot \text{ft} \quad \text{Ans}$$

$$\Sigma M_y = 0; \quad (T_A)_y + 1200(1.5) - 400(1) = 0$$

$$(T_A)_y = -1.40 \text{ kip} \cdot \text{ft} \quad \text{Ans}$$

$$\Sigma M_z = 0; \quad (M_A)_z = 0$$

Ans

From *Mechanics of Materials*, Sixth Edition by R. C. Hibbeler, ISBN 0-13-191345-X.

© 2005 R. C. Hibbeler. Published by Pearson Prentice Hall,

Pearson Education, Inc., Upper Saddle River, NJ. All rights reserved.

This material is protected under all copyright laws as they currently exist. No portion of this material may be reproduced, in any form or by any means, without permission in writing from the publisher.

1-25 Determine the resultant internal loadings acting on the cross section through point B of the signpost. The post is fixed to the ground and a uniform pressure of 7 lb/ft^2 acts perpendicular to the face of the sign.

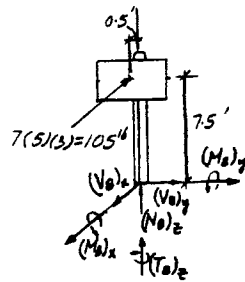
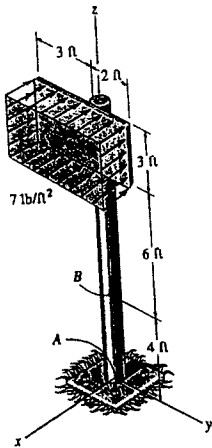

$$\Sigma F_x = 0; \quad (V_B)_x - 105 = 0; \quad (V_B)_x = 105 \text{ lb} \quad \text{Ans}$$

$$\Sigma F_y = 0; \quad (V_B)_y = 0 \quad \text{Ans}$$

$$\Sigma F_z = 0; \quad (N_B)_z = 0 \quad \text{Ans}$$

$$\Sigma M_x = 0; \quad (M_B)_x = 0 \quad \text{Ans}$$

$$\Sigma M_y = 0; \quad (M_B)_y - 105(7.5) = 0; \quad (M_B)_y = 788 \text{ lb} \cdot \text{ft} \quad \text{Ans}$$

$$\Sigma M_z = 0; \quad (T_B)_z - 105(0.5) = 0; \quad (T_B)_z = 52.5 \text{ lb} \cdot \text{ft} \quad \text{Ans}$$

From *Mechanics of Materials*, Sixth Edition by R. C. Hibbeler, ISBN 0-13-191345-X.

© 2005 R. C. Hibbeler. Published by Pearson Prentice Hall,

Pearson Education, Inc., Upper Saddle River, NJ. All rights reserved.

This material is protected under all copyright laws as they currently exist. No portion of this material may be reproduced, in any form or by any means, without permission in writing from the publisher.

1-26. The shaft is supported at its ends by two bearings *A* and *B* and is subjected to the forces applied to the pulleys fixed to the shaft. Determine the resultant internal loadings acting on the cross section located at point *C*. The 300-N forces act in the $-z$ direction and the 500-N forces act in the $+x$ direction. The journal bearings at *A* and *B* exert only x and z components of force on the shaft.

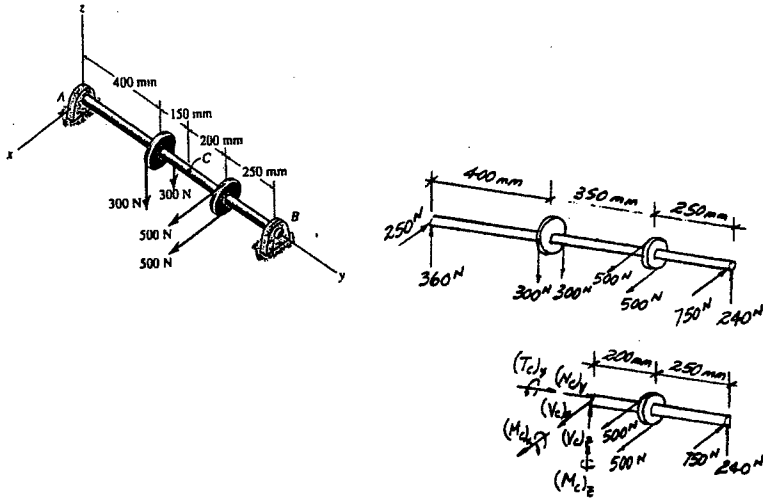

$$\Sigma F_x = 0; \quad (V_C)_x + 1000 - 750 = 0; \quad (V_C)_x = -250 \text{ N} \quad \text{Ans}$$

$$\Sigma F_y = 0; \quad (N_C)_y = 0 \quad \text{Ans}$$

$$\Sigma F_z = 0; \quad (V_C)_z + 240 = 0; \quad (V_C)_z = -240 \text{ N} \quad \text{Ans}$$

$$\Sigma M_x = 0; \quad (M_C)_x + 240(0.45) = 0; \quad (M_C)_x = -108 \text{ N} \cdot \text{m} \quad \text{Ans}$$

$$\Sigma M_y = 0; \quad (T_C)_y = 0 \quad \text{Ans}$$

$$\Sigma M_z = 0; \quad (M_C)_z - 1000(0.2) + 750(0.45) = 0; \quad (M_C)_z = -138 \text{ N} \cdot \text{m} \quad \text{Ans}$$

From *Mechanics of Materials*, Sixth Edition by R. C. Hibbeler, ISBN 0-13-191345-X.

© 2005 R. C. Hibbeler. Published by Pearson Prentice Hall,

Pearson Education, Inc., Upper Saddle River, NJ. All rights reserved.

This material is protected under all copyright laws as they currently exist. No portion of this material may be reproduced, in any form or by any means, without permission in writing from the publisher.

1-27 A hand crank that is used in a press has the dimensions shown. Determine the resultant internal loadings acting on the cross section at A if a vertical force of 50 lb is applied to the handle as shown. Assume the crank is fixed to the shaft at B .

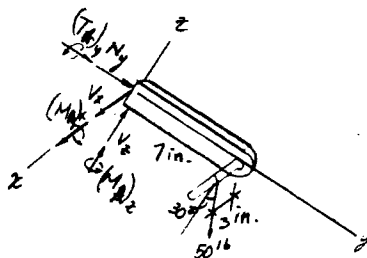
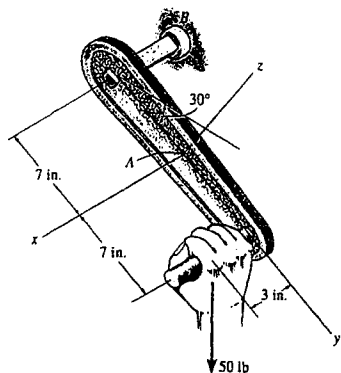

$$\Sigma F_x = 0; \quad (V_A)_x = 0 \quad \text{Ans}$$

$$\Sigma F_y = 0; \quad (N_A)_y + 50 \sin 30^\circ = 0; \quad (N_A)_y = -25 \text{ lb} \quad \text{Ans}$$

$$\Sigma F_z = 0; \quad (V_A)_z - 50 \cos 30^\circ = 0; \quad (V_A)_z = 43.3 \text{ lb} \quad \text{Ans}$$

$$\Sigma M_x = 0; \quad (M_A)_x - 50 \cos 30^\circ(7) = 0; \quad (M_A)_x = 303 \text{ lb} \cdot \text{in.} \quad \text{Ans}$$

$$\Sigma M_y = 0; \quad (T_A)_y + 50 \cos 30^\circ(3) = 0; \quad (T_A)_y = -130 \text{ lb} \cdot \text{in.} \quad \text{Ans}$$

$$\Sigma M_z = 0; \quad (M_A)_z + 50 \sin 30^\circ(3) = 0; \quad (M_A)_z = -75 \text{ lb} \cdot \text{in.} \quad \text{Ans}$$

From *Mechanics of Materials*, Sixth Edition by R. C. Hibbeler, ISBN 0-13-191345-X.

© 2005 R. C. Hibbeler. Published by Pearson Prentice Hall,

Pearson Education, Inc., Upper Saddle River, NJ. All rights reserved.

This material is protected under all copyright laws as they currently exist. No portion of this material may be reproduced, in any form or by any means, without permission in writing from the publisher.

*1-28 Determine the resultant internal loadings acting on the cross section of the frame at points F and G . The contact at E is smooth.

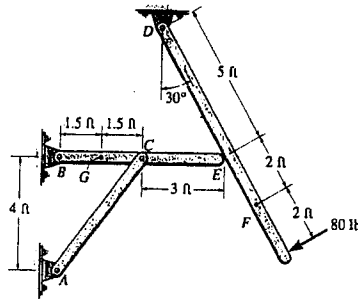

Member DEF :

$$\curvearrowleft + \Sigma M_D = 0; \quad N_E (5) - 80 (9) = 0$$

$$N_E = 144 \text{ lb}$$

Member BCE :

$$\curvearrowleft + \Sigma M_B = 0; \quad F_{AC} \left(\frac{4}{5}\right)(3) - 144 \sin 30^\circ (6) = 0$$

$$F_{AC} = 180 \text{ lb}$$

$$\rightarrow \Sigma F_x = 0; \quad B_x + 180 \left(\frac{3}{5}\right) - 144 \cos 30^\circ = 0$$

$$B_x = 16.708 \text{ lb}$$

$$+\uparrow \Sigma F_y = 0; \quad -B_y + 180 \left(\frac{4}{5}\right) - 144 \sin 30^\circ = 0$$

$$B_y = 72.0 \text{ lb}$$

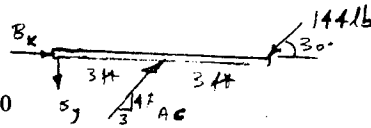
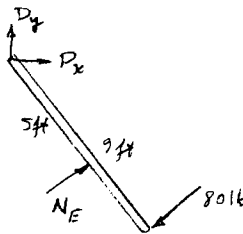

For point F :

$$\rightarrow \Sigma F_x = 0; \quad N_F = 0$$

$$+\uparrow \Sigma F_y = 0; \quad V_F - 80 = 0; \quad V_F = 80 \text{ lb}$$

$$\curvearrowleft + \Sigma M_F = 0; \quad M_F - 80 (2) = 0; \quad M_F = 160 \text{ lb} \cdot \text{ft} \quad \text{Ans}$$

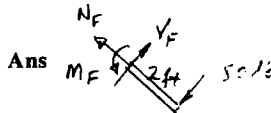

Ans

For point G :

$$\rightarrow \Sigma F_x = 0; \quad 16.708 - N_G = 0; \quad N_G = 16.7 \text{ lb} \quad \text{Ans}$$

$$+\uparrow \Sigma F_y = 0; \quad V_G - 72.0 = 0; \quad V_G = 72.0 \text{ lb} \quad \text{Ans}$$

$$\curvearrowleft + \Sigma M_G = 0; \quad 72 (1.5) - M_G = 0; \quad M_G = 108 \text{ lb} \cdot \text{ft} \quad \text{Ans}$$

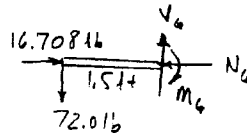

From *Mechanics of Materials*, Sixth Edition by R. C. Hibbeler, ISBN 0-13-191345-X.

© 2005 R. C. Hibbeler. Published by Pearson Prentice Hall,

Pearson Education, Inc., Upper Saddle River, NJ. All rights reserved.

This material is protected under all copyright laws as they currently exist. No portion of this material may be reproduced, in any form or by any means, without permission in writing from the publisher.

1-29 The bolt shank is subjected to a tension of 80 lb. Determine the resultant internal loadings acting on the cross section at point C.

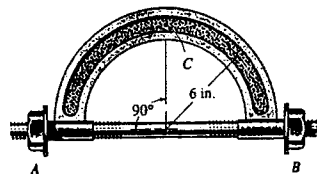

Segment AC :

$$\rightarrow \Sigma F_x = 0; \quad N_C + 80 = 0; \quad N_C = -80 \text{ lb} \quad \text{Ans}$$

$$+ \uparrow \Sigma F_y = 0; \quad V_C = 0 \quad \text{Ans}$$

$$\curvearrowleft + \Sigma M_C = 0; \quad M_C + 80(6) = 0; \quad M_C = -480 \text{ lb} \cdot \text{in.} \quad \text{Ans}$$

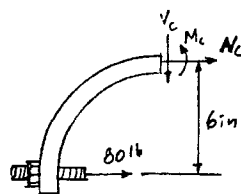

From *Mechanics of Materials*, Sixth Edition by R. C. Hibbeler, ISBN 0-13-191345-X.

© 2005 R. C. Hibbeler. Published by Pearson Prentice Hall,

Pearson Education, Inc., Upper Saddle River, NJ. All rights reserved.

This material is protected under all copyright laws as they currently exist. No portion of this material may be reproduced, in any form or by any means, without permission in writing from the publisher.

1-30 Determine the resultant internal loadings acting on the cross section at points *B* and *C* of the curved member.

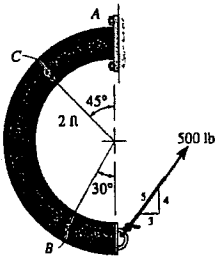

From FBD (a)

$$\sum F_x = 0; \quad 400 \cos 30^\circ + 300 \cos 60^\circ - V_B = 0$$

$$V_B = 496 \text{ lb} \quad \text{Ans}$$

$$\sum F_y = 0; \quad N_B + 400 \sin 30^\circ - 300 \sin 60^\circ = 0$$

$$N_B = 59.80 = 59.8 \text{ lb} \quad \text{Ans}$$

$$\sum M_O = 0; \quad 300(2) - 59.80(2) - M_B = 0$$

$$M_B = 480 \text{ lb} \cdot \text{ft} \quad \text{Ans}$$

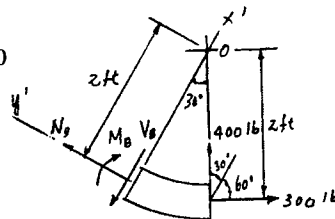

(a)

From FBD (b)

$$\sum F_x = 0; \quad 400 \cos 45^\circ + 300 \cos 45^\circ - N_C = 0$$

$$N_C = 495 \text{ lb} \quad \text{Ans}$$

$$\sum F_y = 0; \quad -V_C + 400 \sin 45^\circ - 300 \sin 45^\circ = 0$$

$$V_C = 70.7 \text{ lb} \quad \text{Ans}$$

$$\sum M_O = 0; \quad 300(2) + 495(2) - M_C = 0$$

$$M_C = 1590 \text{ lb} \cdot \text{ft} = 1.59 \text{ kip} \cdot \text{ft} \quad \text{Ans}$$

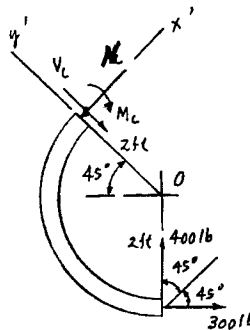

(b)

From *Mechanics of Materials*, Sixth Edition by R. C. Hibbeler, ISBN 0-13-191345-X.

© 2005 R. C. Hibbeler. Published by Pearson Prentice Hall,

Pearson Education, Inc., Upper Saddle River, NJ. All rights reserved.

This material is protected under all copyright laws as they currently exist. No portion of this material may be reproduced, in any form or by any means, without permission in writing from the publisher.

1-31 The curved rod AD of radius r has a weight per length of w . If it lies in the vertical plane, determine the resultant internal loadings acting on the cross section through point B . *Hint:* The distance from the centroid C of segment AB to point O is $OC = [2r \sin(\theta/2)]/\theta$.

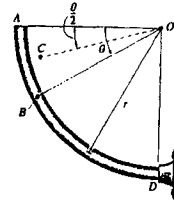

$$\leftarrow + \Sigma F_x = 0; \quad N_B + wr\theta \cos\theta = 0$$

$$N_B = -wr\theta \cos\theta \quad \text{Ans}$$

$$\uparrow + \Sigma F_y = 0; \quad -V_B - wr\theta \sin\theta = 0$$

$$V_B = -wr\theta \sin\theta \quad \text{Ans}$$

$$\leftarrow + \Sigma M_O = 0; \quad wr\theta \left(\cos \frac{\theta}{2}\right) \left(\frac{2r \sin(\theta/2)}{\theta}\right) + (N_B)r + M_B = 0$$

$$M_B = -N_B r = wr^2 2 \sin(\theta/2) \cos(\theta/2)$$

$$M_B = wr^2(\theta \cos\theta - \sin\theta) \quad \text{Ans}$$

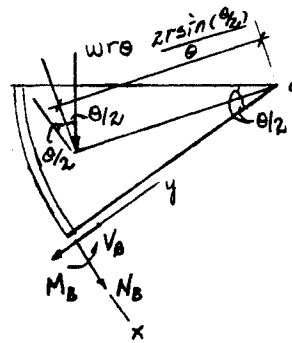

From *Mechanics of Materials*, Sixth Edition by R. C. Hibbeler, ISBN 0-13-191345-X.

© 2005 R. C. Hibbeler. Published by Pearson Prentice Hall,

Pearson Education, Inc., Upper Saddle River, NJ. All rights reserved.

This material is protected under all copyright laws as they currently exist. No portion of this material may be reproduced, in any form or by any means, without permission in writing from the publisher.

***1-32.** The curved rod AD of radius r has a weight per length of w . If it lies in the horizontal plane, determine the resultant internal loadings acting on the cross section through point B . *Hint:* The distance from the centroid C of segment AB to point O is $CO = 0.9745r$.

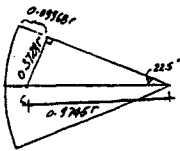
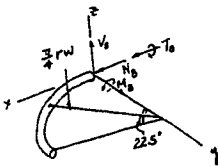
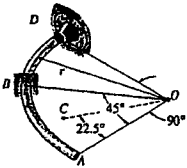

$$\Sigma F_x = 0; \quad V_B - \frac{\pi}{4} r w = 0; \quad V_B = 0.785 w r \quad \text{Ans}$$

$$\Sigma F_y = 0; \quad N_B = 0 \quad \text{Ans}$$

$$\Sigma M_x = 0; \quad T_B - \frac{\pi}{4} r w (0.09968r) = 0; \quad T_B = 0.0783 w r^2 \quad \text{Ans}$$

$$\Sigma M_y = 0; \quad M_B + \frac{\pi}{4} r w (0.3729 r) = 0; \quad M_B = -0.293 w r^2 \quad \text{Ans}$$

From *Mechanics of Materials*, Sixth Edition by R. C. Hibbeler, ISBN 0-13-191345-X.

© 2005 R. C. Hibbeler. Published by Pearson Prentice Hall,

Pearson Education, Inc., Upper Saddle River, NJ. All rights reserved.

This material is protected under all copyright laws as they currently exist. No portion of this material may be reproduced, in any form or by any means, without permission in writing from the publisher.

1-33. A differential element taken from a curved bar is shown in the figure. Show that $dN/d\theta = V$, $dV/d\theta = -N$, $dM/d\theta = -T$, and $dT/d\theta = M$.

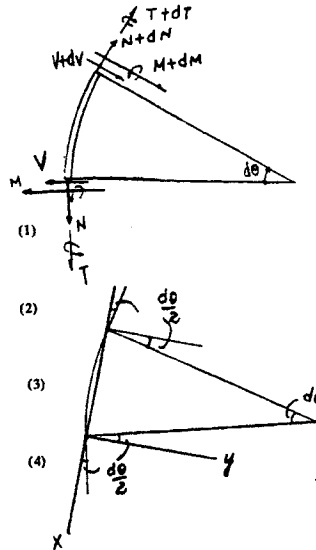
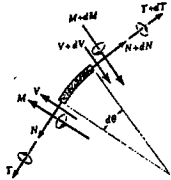

$$\Sigma F_x = 0;$$

$$N \cos \frac{d\theta}{2} + V \sin \frac{d\theta}{2} - (N + dN) \cos \frac{d\theta}{2} + (V + dV) \sin \frac{d\theta}{2} = 0 \quad (1)$$

$$\Sigma F_y = 0;$$

$$N \sin \frac{d\theta}{2} - V \cos \frac{d\theta}{2} + (N + dN) \sin \frac{d\theta}{2} + (V + dV) \cos \frac{d\theta}{2} = 0 \quad (2)$$

$$\Sigma M_x = 0;$$

$$T \cos \frac{d\theta}{2} + M \sin \frac{d\theta}{2} - (T + dT) \cos \frac{d\theta}{2} + (M + dM) \sin \frac{d\theta}{2} = 0 \quad (3)$$

$$\Sigma M_y = 0;$$

$$T \sin \frac{d\theta}{2} - M \cos \frac{d\theta}{2} + (T + dT) \sin \frac{d\theta}{2} + (M + dM) \cos \frac{d\theta}{2} = 0 \quad (4)$$

Since $\frac{d\theta}{2}$ is small, then $\sin \frac{d\theta}{2} = \frac{d\theta}{2}$, $\cos \frac{d\theta}{2} = 1$

$$\text{Eq. (1) becomes } Vd\theta - dN + \frac{dVd\theta}{2} = 0$$

Neglecting the second order term, $Vd\theta - dN = 0$

$$\frac{dN}{d\theta} = V \quad \text{QED}$$

$$\text{Eq. (2) becomes } Nd\theta + dV + \frac{dNd\theta}{2} = 0$$

Neglecting the second order term, $Nd\theta + dV = 0$

$$\frac{dV}{d\theta} = -N \quad \text{QED}$$

$$\text{Eq. (3) becomes } Md\theta - dT + \frac{dMd\theta}{2} = 0$$

Neglecting the second order term, $Md\theta - dT = 0$

$$\frac{dT}{d\theta} = M \quad \text{QED}$$

$$\text{Eq. (4) becomes } Td\theta + dM + \frac{dTd\theta}{2} = 0$$

Neglecting the second order term, $Td\theta + dM = 0$

$$\frac{dM}{d\theta} = -T \quad \text{QED}$$

From *Mechanics of Materials*, Sixth Edition by R. C. Hibbeler, ISBN 0-13-191345-X.

© 2005 R. C. Hibbeler. Published by Pearson Prentice Hall,

Pearson Education, Inc., Upper Saddle River, NJ. All rights reserved.

This material is protected under all copyright laws as they currently exist. No portion of this material may be reproduced, in any form or by any means, without permission in writing from the publisher.

1-34. The column is subjected to an axial force of 8 kN at its top. If the cross-sectional area has the dimensions shown in the figure, determine the average normal stress acting at section $a-a$. Show this distribution of stress acting over the area's cross section.

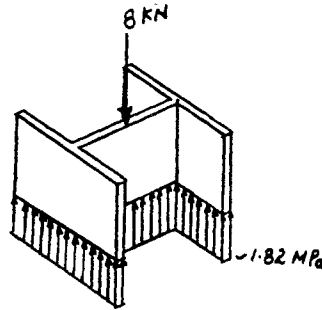
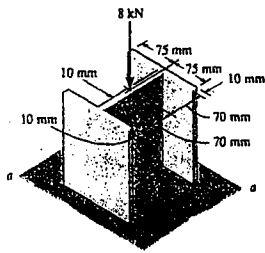

$$A = (2)(150)(10) + (140)(10) \\ = 4400 \text{ mm}^2 = 4.4 (10^{-3}) \text{ m}^2$$

$$\sigma = \frac{P}{A} = \frac{8 (10^3)}{4.4 (10^{-3})} = 1.82 \text{ MPa} \quad \text{Ans}$$

From *Mechanics of Materials*, Sixth Edition by R. C. Hibbeler, ISBN 0-13-191345-X.

© 2005 R. C. Hibbeler. Published by Pearson Prentice Hall,

Pearson Education, Inc., Upper Saddle River, NJ. All rights reserved.

This material is protected under all copyright laws as they currently exist. No portion of this material may be reproduced, in any form or by any means, without permission in writing from the publisher.

1-35 The anchor shackle supports a cable force of 600 lb. If the pin has a diameter of 0.25 in., determine the average shear stress in the pin.

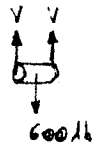
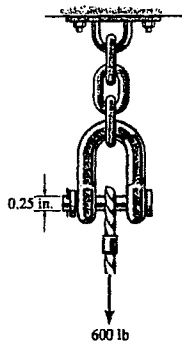

$$+\uparrow \Sigma F_y = 0; \quad 2V - 600 = 0$$

$$V = 300 \text{ lb}$$

$$\tau_{avg} = \frac{V}{A} = \frac{300}{\frac{\pi}{4}(0.25)^2} = 6.11 \text{ ksi} \quad \text{Ans}$$

From *Mechanics of Materials*, Sixth Edition by R. C. Hibbeler, ISBN 0-13-191345-X.

© 2005 R. C. Hibbeler. Published by Pearson Prentice Hall,

Pearson Education, Inc., Upper Saddle River, NJ. All rights reserved.

This material is protected under all copyright laws as they currently exist. No portion of this material may be reproduced, in any form or by any means, without permission in writing from the publisher.

*1-36 While running the foot of a 150-lb man is momentarily subjected to a force which is 5 times his weight. Determine the average normal stress developed in the tibia T of his leg at the mid section $a-a$. The cross section can be assumed circular, having an outer diameter of 1.75 in. and an inner diameter of 1 in. Assume the fibula F does not support a load.

$$P = 5(150 \text{ lb}) = 750 \text{ lb}$$

$$\sigma = \frac{P}{A} = \frac{750}{\frac{\pi}{4}((1.75)^2 - (1)^2)} = 463 \text{ psi} \quad \text{Ans}$$

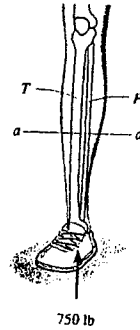

From *Mechanics of Materials*, Sixth Edition by R. C. Hibbeler, ISBN 0-13-191345-X.

© 2005 R. C. Hibbeler. Published by Pearson Prentice Hall,

Pearson Education, Inc., Upper Saddle River, NJ. All rights reserved.

This material is protected under all copyright laws as they currently exist. No portion of this material may be reproduced, in any form or by any means, without permission in writing from the publisher.

1-37 The small block has a thickness of 0.5 in. If the stress distribution at the support developed by the load varies as shown, determine the force F applied to the block, and the distance d to where it is applied.

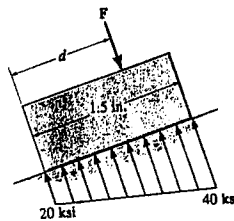

$$F = \int \sigma dA = \text{volume under load diagram}$$

$$F = 20(1.5)(0.5) + \frac{1}{2}(20)(1.5)(0.5) = 22.5 \text{ kip} \quad \text{Ans}$$

$$Fd = \int x(\sigma dA)$$

$$(22.5) d = (0.75)(20)(1.5)(0.5) + \frac{2}{3}(1.5)\left(\frac{1}{2}\right)(20)(1.5)(0.5)$$

$$(22.5) d = 18.75$$

$$d = 0.833 \text{ in.} \quad \text{Ans}$$

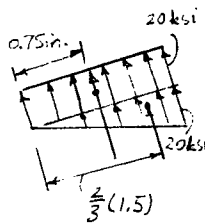

From *Mechanics of Materials*, Sixth Edition by R. C. Hibbeler, ISBN 0-13-191345-X.

© 2005 R. C. Hibbeler. Published by Pearson Prentice Hall,

Pearson Education, Inc., Upper Saddle River, NJ. All rights reserved.

This material is protected under all copyright laws as they currently exist. No portion of this material may be reproduced, in any form or by any means, without permission in writing from the publisher.

1-38. The small block has a thickness of 5 mm. If the stress distribution at the support developed by the load varies as shown, determine the force F applied to the block, and the distance d to where it is applied.

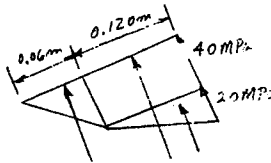
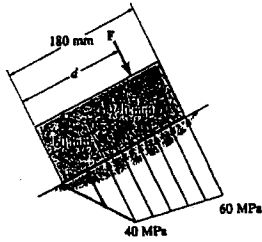

$$F = \int \sigma dA = \text{volume under stress diagram}$$

$$F = \frac{1}{2}(0.06)(40)(10^6)(0.005) + (0.120)(40)(10^6)(0.005) + \frac{1}{2}(0.120)(20)(10^6)(0.005)$$

$$F = 36 \text{ kN} \quad \text{Ans}$$

Require

$$Fd = \int x(\sigma dA)$$

$$36.0(10^3)d = \frac{2}{3}(0.06)\left(\frac{1}{2}\right)(0.06)(40)(10^6)(0.005) + (0.06 + \frac{1}{2}(0.120))(0.120)(40)(10^6)(0.005) +$$

$$(0.06 + \frac{2}{3}(0.120))\left(\frac{1}{2}\right)(0.120)(20)(10^6)(0.005)$$

$$36.0(10^3)d = 3960$$

$$d = 0.110 = 110 \text{ mm} \quad \text{Ans}$$

From *Mechanics of Materials*, Sixth Edition by R. C. Hibbeler, ISBN 0-13-191345-X.

© 2005 R. C. Hibbeler. Published by Pearson Prentice Hall,

Pearson Education, Inc., Upper Saddle River, NJ. All rights reserved.

This material is protected under all copyright laws as they currently exist. No portion of this material may be reproduced, in any form or by any means, without permission in writing from the publisher.

1-39 The lever is held to the fixed shaft using a tapered pin AB , which has a mean diameter of 6 mm. If a couple is applied to the lever, determine the average shear stress in the pin between the pin and lever.

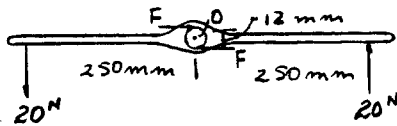
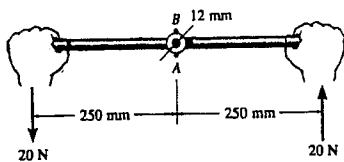

$$\sum M_O = 0; \quad F(12) - 20(500) = 0; \quad F = 833.33 \text{ N}$$

$$\tau_{avg} = \frac{V}{A} = \frac{833.33}{\frac{\pi}{4} \left(\frac{6}{1000} \right)^2} = 29.5 \text{ MPa} \quad \text{Ans}$$

From *Mechanics of Materials*, Sixth Edition by R. C. Hibbeler, ISBN 0-13-191345-X.

© 2005 R. C. Hibbeler. Published by Pearson Prentice Hall,

Pearson Education, Inc., Upper Saddle River, NJ. All rights reserved.

This material is protected under all copyright laws as they currently exist. No portion of this material may be reproduced, in any form or by any means, without permission in writing from the publisher.

***1-40.** The supporting wheel on a scaffold is held in place on the leg using a 4-mm-diameter pin as shown. If the wheel is subjected to a normal force of 3 kN, determine the average shear stress developed in the pin. Neglect friction between the inner scaffold puller leg and the tube used on the wheel.



$$+\uparrow \Sigma F_y = 0; \quad 3 \text{ kN} - 2V = 0; \quad V = 1.5 \text{ kN}$$

$$\tau_{avg} = \frac{V}{A} = \frac{1.5(10^3)}{\frac{\pi}{4}(0.004)^2} = 119 \text{ MPa} \quad \text{Ans}$$

From *Mechanics of Materials*, Sixth Edition by R. C. Hibbeler, ISBN 0-13-191345-X.

© 2005 R. C. Hibbeler. Published by Pearson Prentice Hall,

Pearson Education, Inc., Upper Saddle River, NJ. All rights reserved.

This material is protected under all copyright laws as they currently exist. No portion of this material may be reproduced, in any form or by any means, without permission in writing from the publisher.

1-41 A 175-lb woman stands on a vinyl floor wearing stiletto high-heel shoes. If the heel has the dimensions shown, determine the average normal stress she exerts on the floor and compare it with the average normal stress developed when a man having the same weight is wearing flat-heeled shoes. Assume the load is applied slowly, so that dynamic effects can be ignored. Also, assume the entire weight is supported only by the heel of one shoe.

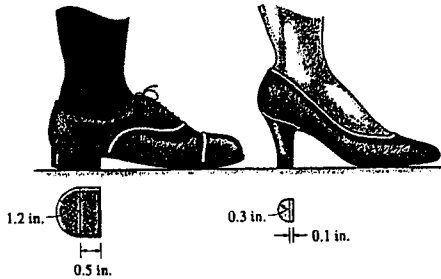

Stiletto shoes :

$$A = \frac{1}{2}(\pi)(0.3)^2 + (0.6)(0.1) = 0.2014 \text{ in}^2$$

$$\sigma = \frac{P}{A} = \frac{175 \text{ lb}}{0.2014 \text{ in}^2} = 869 \text{ psi} \quad \text{Ans}$$

Flat - heeled shoes :

$$A = \frac{1}{2}(\pi)(1.2)^2 + 2.4(0.5) = 3.462 \text{ in}^2$$

$$\sigma = \frac{P}{A} = \frac{175 \text{ lb}}{3.462 \text{ in}^2} = 50.5 \text{ psi} \quad \text{Ans}$$

From *Mechanics of Materials*, Sixth Edition by R. C. Hibbeler, ISBN 0-13-191345-X.

© 2005 R. C. Hibbeler. Published by Pearson Prentice Hall,

Pearson Education, Inc., Upper Saddle River, NJ. All rights reserved.

This material is protected under all copyright laws as they currently exist. No portion of this material may be reproduced, in any form or by any means, without permission in writing from the publisher.

1-42 The 50-lb lamp is supported by three steel rods connected by a ring at A. Determine which rod is subjected to the greater average normal stress and compute its value. Take $\theta = 30^\circ$. The diameter of each rod is given in the figure.

$$\begin{aligned} \rightarrow \Sigma F_x = 0; & \quad F_{AC} \cos 30^\circ - F_{AD} \cos 45^\circ = 0 \\ + \uparrow \Sigma F_y = 0; & \quad F_{AC} \sin 30^\circ + F_{AD} \sin 45^\circ - 50 = 0 \end{aligned}$$

$$F_{AC} = 36.60 \text{ lb}, \quad F_{AD} = 44.83 \text{ lb}$$

Rod AB :

$$\sigma_{AB} = \frac{50}{\frac{\pi}{4} (0.35)^2} = 520 \text{ psi}$$

Rod AD :

$$\sigma_{AD} = \frac{44.83}{\frac{\pi}{4} (0.3)^2} = 634 \text{ psi}$$

Rod AC :

$$\sigma_{AC} = \frac{36.60}{\frac{\pi}{4} (0.25)^2} = 746 \text{ psi} \quad \text{Ans}$$

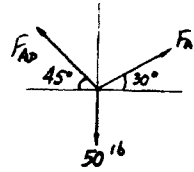
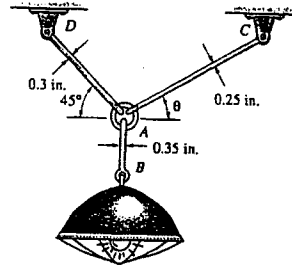

From *Mechanics of Materials*, Sixth Edition by R. C. Hibbeler, ISBN 0-13-191345-X.
 © 2005 R. C. Hibbeler. Published by Pearson Prentice Hall,
 Pearson Education, Inc., Upper Saddle River, NJ. All rights reserved.
 This material is protected under all copyright laws as they currently exist. No portion of this material may be reproduced, in any form or by any means, without permission in writing from the publisher.

1-43 Solve Prob. 1-42 for $\theta = 45^\circ$.

$$\rightarrow \Sigma F_x = 0; \quad F_{AC} \cos 45^\circ - F_{AD} \cos 45^\circ = 0$$

$$+ \uparrow \Sigma F_y = 0; \quad F_{AC} \sin 45^\circ + F_{AD} \sin 45^\circ - 50 = 0$$

$$F_{AC} = F_{AD} = 35.36 \text{ lb}$$

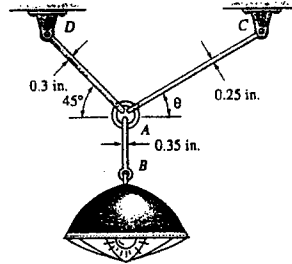

Rod AB :

$$\sigma_{AB} = \frac{50}{\frac{\pi}{4}(0.35)^2} = 520 \text{ psi}$$

Rod AC :

$$\sigma_{AC} = \frac{35.36}{\frac{\pi}{4}(0.25)^2} = 720 \text{ psi} \quad \text{Ans}$$

Rod AD :

$$\sigma_{AD} = \frac{35.36}{\frac{\pi}{4}(0.3)^2} = 500 \text{ psi}$$

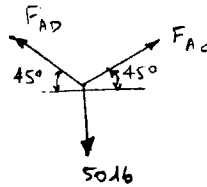

From *Mechanics of Materials*, Sixth Edition by R. C. Hibbeler, ISBN 0-13-191345-X.
 © 2005 R. C. Hibbeler. Published by Pearson Prentice Hall,
 Pearson Education, Inc., Upper Saddle River, NJ. All rights reserved.
 This material is protected under all copyright laws as they currently exist. No portion of this material may be reproduced, in any form or by any means, without permission in writing from the publisher.

*1-44 The 50-lb lamp is supported by three steel rods connected by a ring at A . Determine the angle of orientation θ of AC such that the average normal stress in rod AC is twice the average normal stress in rod AD . What is the magnitude of stress in each rod? The diameter of each rod is given in the figure.

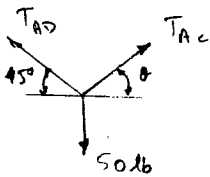
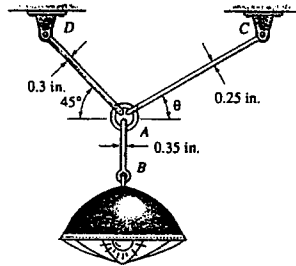

$$\sigma_{AD} = \frac{T_{AD}}{\frac{\pi}{4}(0.3)^2}; \quad T_{AD} = (0.070686)\sigma_{AD}$$

$$\sigma_{AC} = 2\sigma_{AD} = \frac{T_{AC}}{\frac{\pi}{4}(0.25)^2}; \quad T_{AC} = (0.098175)\sigma_{AD}$$

$$\rightarrow \Sigma F_x = 0; \quad -T_{AD} \cos 45^\circ + T_{AC} \cos \theta = 0 \quad (1)$$

$$+ \uparrow \Sigma F_y = 0; \quad T_{AC} \sin \theta + T_{AD} \sin 45^\circ - 50 = 0 \quad (2)$$

Thus

$$-(0.070686)\sigma_{AD}(\cos 45^\circ) + (0.098175)\sigma_{AD}(\cos \theta) = 0$$

$$\theta = 59.39^\circ = 59.4^\circ \quad \text{Ans}$$

From Eq. (2):

$$(0.098175)\sigma_{AD} \sin 59.39^\circ + (0.070686)\sigma_{AD} \sin 45^\circ - 50 = 0$$

$$\sigma_{AD} = 371.8 \text{ psi} = 372 \text{ psi} \quad \text{Ans}$$

Hence,

$$\sigma_{AC} = 2(371.8) = 744 \text{ psi} \quad \text{Ans}$$

And,

$$\sigma_{AB} = \frac{T_{AB}}{\frac{\pi}{4}(0.35)^2} = \frac{50}{\frac{\pi}{4}(0.35)^2} = 520 \text{ psi} \quad \text{Ans}$$

From *Mechanics of Materials*, Sixth Edition by R. C. Hibbeler, ISBN 0-13-191345-X.

© 2005 R. C. Hibbeler. Published by Pearson Prentice Hall,

Pearson Education, Inc., Upper Saddle River, NJ. All rights reserved.

This material is protected under all copyright laws as they currently exist. No portion of this material may be reproduced, in any form or by any means, without permission in writing from the publisher.

1-45. The pedestal has a triangular cross section as shown. If it is subjected to a compressive force of 500 lb, specify the x and y coordinates for the location of point $P(x, y)$, where the load must be applied on the cross section, so that the average normal stress is uniform. Compute the stress and sketch its distribution acting on the cross section at a location removed from the point of load application.

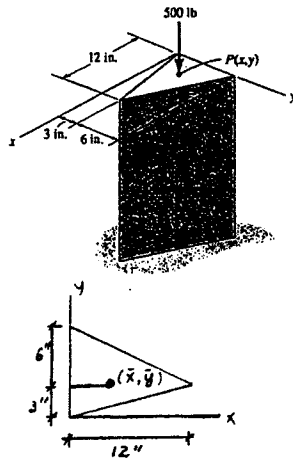

$$\bar{x} = \frac{\frac{1}{2}(3)(12)\left(\frac{12}{3}\right) + \frac{1}{2}(6)(12)\left(\frac{12}{3}\right)}{\frac{1}{2}(9)(12)} = 4 \text{ in.} \quad \text{Ans}$$

$$\bar{y} = \frac{\frac{1}{2}(3)(12)\left(3 + \frac{9}{3}\right) + \frac{1}{2}(6)(12)\left(3 + \frac{9}{3}\right)}{\frac{1}{2}(9)(12)} = 4 \text{ in.} \quad \text{Ans}$$

$$\sigma = \frac{P}{A} = \frac{500}{\frac{1}{2}(9)(12)} = 9.26 \text{ psi} \quad \text{Ans}$$

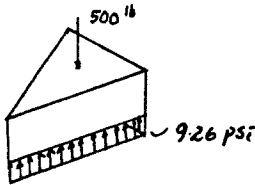

From *Mechanics of Materials*, Sixth Edition by R. C. Hibbeler, ISBN 0-13-191345-X.

© 2005 R. C. Hibbeler. Published by Pearson Prentice Hall,

Pearson Education, Inc., Upper Saddle River, NJ. All rights reserved.

This material is protected under all copyright laws as they currently exist. No portion of this material may be reproduced, in any form or by any means, without permission in writing from the publisher.

1-46 The two steel members are joined together using a 60° scarf weld. Determine the average normal and average shear stress resisted in the plane of the weld.

$$\rightarrow \Sigma F_x = 0; \quad N - 8 \sin 60^\circ = 0$$

$$N = 6.928 \text{ kN}$$

$$\downarrow \Sigma F_y = 0; \quad V - 8 \cos 60^\circ = 0$$

$$V = 4 \text{ kN}$$

$$A = (25) \left(\frac{30}{\sin 60^\circ} \right) = 866.03 \text{ mm}^2$$

$$\sigma = \frac{N}{A} = \frac{6.928 (10^3)}{0.8660 (10^{-3})} = 8 \text{ MPa} \quad \text{Ans}$$

$$\tau_{\text{avg}} = \frac{V}{A} = \frac{4 (10^3)}{0.8660 (10^{-3})} = 4.62 \text{ MPa} \quad \text{Ans}$$

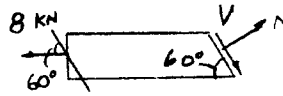
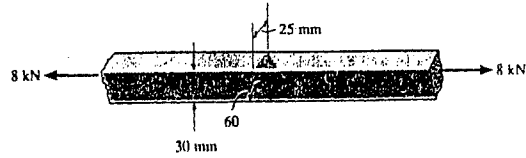

From *Mechanics of Materials*, Sixth Edition by R. C. Hibbeler, ISBN 0-13-191345-X.

© 2005 R. C. Hibbeler. Published by Pearson Prentice Hall,

Pearson Education, Inc., Upper Saddle River, NJ. All rights reserved.

This material is protected under all copyright laws as they currently exist. No portion of this material may be reproduced, in any form or by any means, without permission in writing from the publisher.

1-47. The built-up shaft consists of a pipe AB and solid rod BC . The pipe has an inner diameter of 20 mm and outer diameter of 28 mm. The rod has a diameter of 12 mm. Determine the average normal stress at points D and E and represent the stress on a volume element located at each of these points.

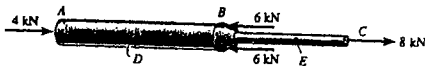

At D :

$$\sigma_D = \frac{P}{A} = \frac{4(10^3)}{\frac{\pi}{4}(0.028^2 - 0.02^2)} = 13.3 \text{ MPa (C) Ans}$$

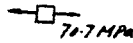
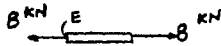
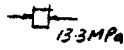
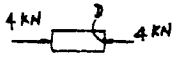

At E :

$$\sigma_E = \frac{P}{A} = \frac{8(10^3)}{\frac{\pi}{4}(0.012^2)} = 70.7 \text{ MPa (T) Ans}$$

From *Mechanics of Materials*, Sixth Edition by R. C. Hibbeler, ISBN 0-13-191345-X.
 © 2005 R. C. Hibbeler. Published by Pearson Prentice Hall,
 Pearson Education, Inc., Upper Saddle River, NJ. All rights reserved.
 This material is protected under all copyright laws as they currently exist. No portion of this material may be reproduced, in any form or by any means, without permission in writing from the publisher.

*1-48 The board is subjected to a tensile force of 85 lb. Determine the average normal and average shear stress developed in the wood fibers that are oriented along section a-a at 15° with the axis of the board.

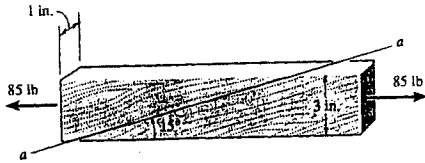

$$+\nearrow \Sigma F_x = 0; \quad V - 85 \cos 15^\circ = 0$$

$$V = 82.10 \text{ lb}$$

$$+\searrow \Sigma F_y = 0; \quad N - 85 \sin 15^\circ = 0$$

$$N = 22.00 \text{ lb}$$

$$A = (1) \left(\frac{3}{\sin 15^\circ} \right) = 11.591 \text{ in}^2$$

$$\sigma = \frac{N}{A} = \frac{22.0}{11.591} = 1.90 \text{ psi} \quad \text{Ans}$$

$$\tau_{avg} = \frac{V}{A} = \frac{82.10}{11.591} = 7.08 \text{ psi} \quad \text{Ans}$$

From *Mechanics of Materials*, Sixth Edition by R. C. Hibbeler, ISBN 0-13-191345-X.

© 2005 R. C. Hibbeler. Published by Pearson Prentice Hall,

Pearson Education, Inc., Upper Saddle River, NJ. All rights reserved.

This material is protected under all copyright laws as they currently exist. No portion of this material may be reproduced, in any form or by any means, without permission in writing from the publisher.

1-49. The plastic block is subjected to an axial compressive force of 600 N. Assuming that the caps at the top and bottom distribute the load uniformly throughout the block, determine the average normal and average shear stress acting along section $a-a$.

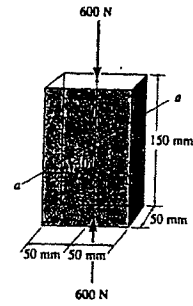
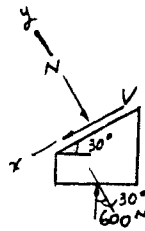

Along $a-a$:

$$\uparrow \Sigma F_x = 0; \quad V - 600 \sin 30^\circ = 0$$

$$V = 300 \text{ N}$$

$$\rightarrow \Sigma F_y = 0; \quad -N + 600 \cos 30^\circ = 0$$

$$N = 519.6 \text{ N}$$

$$\sigma_{a-a} = \frac{519.6}{(0.05)\left(\frac{0.1}{\cos 30^\circ}\right)} = 90.0 \text{ kPa} \quad \text{Ans}$$

$$\tau_{a-a} = \frac{300}{(0.05)\left(\frac{0.1}{\cos 30^\circ}\right)} = 52.0 \text{ kPa} \quad \text{Ans}$$

From *Mechanics of Materials*, Sixth Edition by R. C. Hibbeler, ISBN 0-13-191345-X.

© 2005 R. C. Hibbeler. Published by Pearson Prentice Hall,

Pearson Education, Inc., Upper Saddle River, NJ. All rights reserved.

This material is protected under all copyright laws as they currently exist. No portion of this material may be reproduced, in any form or by any means, without permission in writing from the publisher.

1-50 The specimen failed in a tension test at an angle of 52° when the axial load was 19.80 kip. If the diameter of the specimen is 0.5 in., determine the average normal and average shear stress acting on the area of the inclined failure plane. Also, what is the average normal stress acting on the cross section when failure occurs?

$$+\nearrow \Sigma F_x = 0; \quad V - 19.80 \cos 52^\circ = 0$$

$$V = 12.19 \text{ kip}$$

$$+\searrow \Sigma F_y = 0; \quad N - 19.80 \sin 52^\circ = 0$$

$$N = 15.603 \text{ kip}$$



Inclined plane :

$$\sigma' = \frac{P}{A}; \quad \sigma' = \frac{15.603}{\frac{\pi(0.25)^2}{\sin 52^\circ}} = 62.6 \text{ ksi} \quad \text{Ans}$$

$$\tau_{avg} = \frac{V}{A}; \quad \tau_{avg} = \frac{12.19}{\frac{\pi(0.25)^2}{\sin 52^\circ}} = 48.9 \text{ ksi} \quad \text{Ans}$$

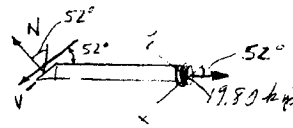

Cross section :

$$\sigma = \frac{P}{A}; \quad \sigma = \frac{19.80}{\pi(0.25)^2} = 101 \text{ ksi} \quad \text{Ans}$$

$$\tau_{avg} = \frac{V}{A}; \quad \tau_{avg} = 0 \quad \text{Ans}$$

From *Mechanics of Materials*, Sixth Edition by R. C. Hibbeler, ISBN 0-13-191345-X.

© 2005 R. C. Hibbeler. Published by Pearson Prentice Hall,

Pearson Education, Inc., Upper Saddle River, NJ. All rights reserved.

This material is protected under all copyright laws as they currently exist. No portion of this material may be reproduced, in any form or by any means, without permission in writing from the publisher.

1-51 A tension specimen having a cross-sectional area A is subjected to an axial force P . Determine the maximum average shear stress in the specimen and indicate the orientation θ of a section on which it occurs.

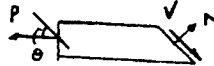

$$\sum F_y = 0; \quad V - P \cos \theta = 0; \quad V = P \cos \theta$$

$$\tau = \frac{P \cos \theta}{A / \sin \theta} = \frac{P \cos \theta \sin \theta}{A} = \frac{P \sin 2\theta}{2A}$$

$$\frac{d\tau}{d\theta} = \frac{P \cos 2\theta}{A} = 0$$

$$\cos 2\theta = 0$$

$$2\theta = 90^\circ$$

$$\theta = 45^\circ \quad \mathbf{Ans}$$

$$\tau_{\max} = \frac{P}{2A} \sin 90^\circ = \frac{P}{2A} \quad \mathbf{Ans}$$

From *Mechanics of Materials*, Sixth Edition by R. C. Hibbeler, ISBN 0-13-191345-X.

© 2005 R. C. Hibbeler. Published by Pearson Prentice Hall,

Pearson Education, Inc., Upper Saddle River, NJ. All rights reserved.

This material is protected under all copyright laws as they currently exist. No portion of this material may be reproduced, in any form or by any means, without permission in writing from the publisher.

*1-52 The joint is subjected to the axial member force of 5 kN. Determine the average normal stress acting on sections AB and BC . Assume the member is smooth and is 50 mm thick.

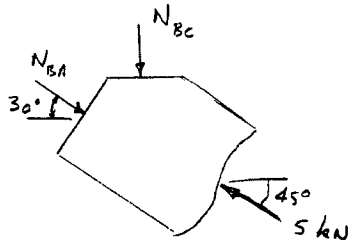
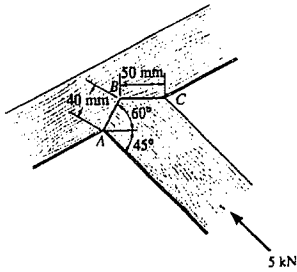

$$\rightarrow \Sigma F_x = 0; \quad N_{BA} \cos 30^\circ - 5 \cos 45^\circ = 0$$

$$N_{BA} = 4.082 \text{ kN}$$

$$+\uparrow \Sigma F_y = 0; \quad -N_{BC} - 4.082 \sin 30^\circ + 5 \sin 45^\circ = 0$$

$$N_{BC} = 1.494 \text{ kN}$$

$$\sigma_{BA} = \frac{N_{BA}}{A_{BA}} = \frac{4.082(10^3)}{(0.04)(0.05)} = 2.04 \text{ MPa} \quad \text{Ans}$$

$$\sigma_{BC} = \frac{N_{BC}}{A_{BC}} = \frac{1.494(10^3)}{(0.05)(0.05)} = 0.598 \text{ MPa} \quad \text{Ans}$$

From *Mechanics of Materials*, Sixth Edition by R. C. Hibbeler, ISBN 0-13-191345-X.

© 2005 R. C. Hibbeler. Published by Pearson Prentice Hall,

Pearson Education, Inc., Upper Saddle River, NJ. All rights reserved.

This material is protected under all copyright laws as they currently exist. No portion of this material may be reproduced, in any form or by any means, without permission in writing from the publisher.

1-53. The joint in subjected to the axial member force of 6 kip. Determine the average normal stress acting on sections AB and BC . Assume the member is smooth and is 1.5 in. thick.

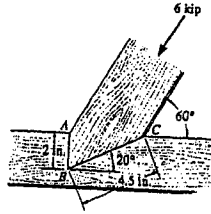

$$+\uparrow \Sigma F_y = 0; \quad -6 \sin 60^\circ + N_{BC} \cos 20^\circ = 0$$

$$N_{BC} = 5.530 \text{ kip}$$

$$\rightarrow \Sigma F_x = 0; \quad N_{AB} - 6 \cos 60^\circ - 5.530 \sin 20^\circ = 0$$

$$N_{AB} = 4.891 \text{ kip}$$

$$\sigma_{AB} = \frac{N_{AB}}{A_{AB}} = \frac{4.891}{(1.5)(2)} = 1.63 \text{ ksi} \quad \text{Ans}$$

$$\sigma_{BC} = \frac{N_{BC}}{A_{BC}} = \frac{5.530}{(1.5)(4.5)} = 0.819 \text{ ksi} \quad \text{Ans}$$

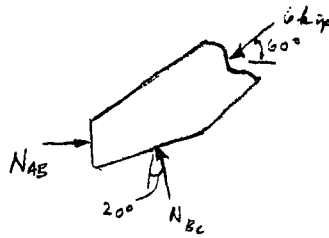

From *Mechanics of Materials*, Sixth Edition by R. C. Hibbeler, ISBN 0-13-191345-X.

© 2005 R. C. Hibbeler. Published by Pearson Prentice Hall,

Pearson Education, Inc., Upper Saddle River, NJ. All rights reserved.

This material is protected under all copyright laws as they currently exist. No portion of this material may be reproduced, in any form or by any means, without permission in writing from the publisher.

1-54 The two members used in the construction of an aircraft fuselage are joined together using a 30° fish-mouth weld. Determine the average normal and average shear stress on the plane of each weld. Assume each inclined plane supports a horizontal force of 400 lb.

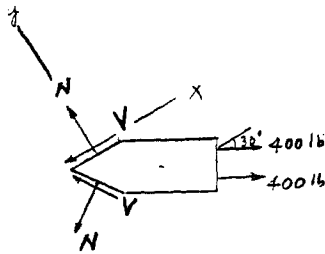
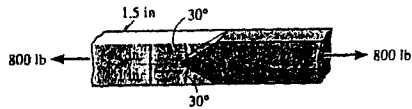

$$N - 400 \sin 30^\circ = 0; \quad N = 200 \text{ lb}$$

$$400 \cos 30^\circ - V = 0; \quad V = 346.41 \text{ lb}$$

$$A' = \frac{1.5(1)}{\sin 30^\circ} = 3 \text{ in}^2$$

$$\sigma = \frac{N}{A'} = \frac{200}{3} = 66.7 \text{ psi} \quad \text{Ans}$$

$$\tau = \frac{V}{A'} = \frac{346.41}{3} = 115 \text{ psi} \quad \text{Ans}$$

From *Mechanics of Materials*, Sixth Edition by R. C. Hibbeler, ISBN 0-13-191345-X.

© 2005 R. C. Hibbeler. Published by Pearson Prentice Hall,

Pearson Education, Inc., Upper Saddle River, NJ. All rights reserved.

This material is protected under all copyright laws as they currently exist. No portion of this material may be reproduced, in any form or by any means, without permission in writing from the publisher.

1-55. The driver of the sports car applies his rear brakes and causes the tires to slip. If the normal force on each rear tire is 400 lb and the coefficient of kinetic friction between the tires and the pavement is $\mu_k = 0.5$, determine the average shear stress developed by the friction force on the tires. Assume the rubber of the tires is flexible and each tire is filled with an air pressure of 32 psi.

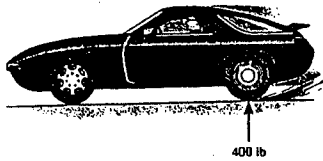

$$F = \mu_k N = 0.5 (400) = 200 \text{ lb}$$

$$p = \frac{N}{A}; \quad A = \frac{400}{32} = 12.5 \text{ in}^2$$

$$\tau_{avg} = \frac{F}{A} = \frac{200}{12.5} = 16 \text{ psi} \quad \text{Ans}$$

From *Mechanics of Materials*, Sixth Edition by R. C. Hibbeler, ISBN 0-13-191345-X.

© 2005 R. C. Hibbeler. Published by Pearson Prentice Hall,

Pearson Education, Inc., Upper Saddle River, NJ. All rights reserved.

This material is protected under all copyright laws as they currently exist. No portion of this material may be reproduced, in any form or by any means, without permission in writing from the publisher.

*1-56 Rods AB and BC have diameters of 4 mm and 6 mm, respectively. If the load of 8 kN is applied to the ring at B , determine the average normal stress in each rod if $\theta = 60^\circ$.

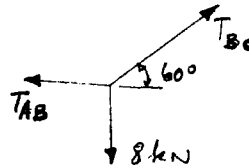
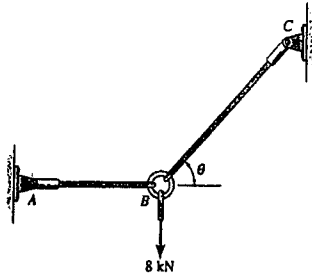

$$+\uparrow \Sigma F_y = 0; \quad T_{BC} \sin 60^\circ - 8 = 0$$

$$T_{BC} = 9.2376 \text{ kN}$$

$$\rightarrow \Sigma F_x = 0; \quad 9.2376 \cos 60^\circ - T_{AB} = 0$$

$$T_{AB} = 4.6188 \text{ kN}$$

$$\sigma_{AB} = \frac{T_{AB}}{A_{AB}} = \frac{4.6188(10^3)}{\frac{\pi}{4}(0.004)^2} = 368 \text{ MPa} \quad \text{Ans}$$

$$\sigma_{BC} = \frac{T_{BC}}{A_{BC}} = \frac{9.2376(10^3)}{\frac{\pi}{4}(0.006)^2} = 327 \text{ MPa} \quad \text{Ans}$$

From *Mechanics of Materials*, Sixth Edition by R. C. Hibbeler, ISBN 0-13-191345-X.

© 2005 R. C. Hibbeler. Published by Pearson Prentice Hall,

Pearson Education, Inc., Upper Saddle River, NJ. All rights reserved.

This material is protected under all copyright laws as they currently exist. No portion of this material may be reproduced, in any form or by any means, without permission in writing from the publisher.

1-57 Rods AB and BC have diameters of 4 mm and 6 mm, respectively. If the vertical load of 8 kN is applied to the ring at B , determine the angle θ of rod BC so that the average normal stress in each rod is equivalent. What is this stress?

$$F_{AB} = \sigma A_{AB} = \sigma(\pi)(0.002)^2$$

$$F_{BC} = \sigma A_{BC} = \sigma(\pi)(0.003)^2$$

$$\rightarrow \Sigma F_x = 0; \quad \sigma(\pi)(0.003^2)\cos \theta - \sigma\pi(0.002^2) = 0 \quad (1)$$

$$+ \uparrow \Sigma F_y = 0; \quad \sigma\pi(0.003^2)\sin \theta - 8(10^3) = 0 \quad (2)$$

From Eq. (1) :

$$\cos \theta = \left(\frac{0.002}{0.003}\right)^2$$

$$\theta = 63.6^\circ \quad \text{Ans}$$

From Eq. (2) :

$$\sigma = \frac{8(10^3)}{\pi(0.003)^2 \sin 63.6^\circ} = 316 \text{ MPa} \quad \text{Ans}$$

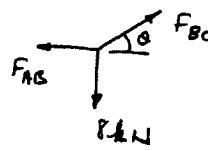
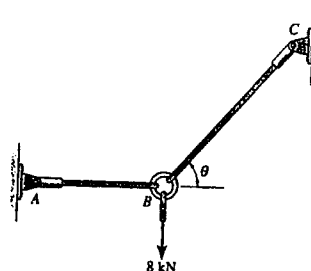

From *Mechanics of Materials*, Sixth Edition by R. C. Hibbeler, ISBN 0-13-191345-X.

© 2005 R. C. Hibbeler. Published by Pearson Prentice Hall,

Pearson Education, Inc., Upper Saddle River, NJ. All rights reserved.

This material is protected under all copyright laws as they currently exist. No portion of this material may be reproduced, in any form or by any means, without permission in writing from the publisher.

1-58. The bars of the truss each have a cross-sectional area of 1.25 in². Determine the average normal stress in each member due to the loading $P = 8$ kip. State whether the stress is tensile or compressive.

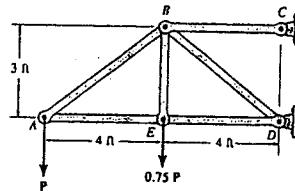

Joint A :

$$\sigma_{AB} = \frac{F_{AB}}{A_{AB}} = \frac{13.33}{1.25} = 10.7 \text{ ksi (T) Ans}$$

$$\sigma_{AE} = \frac{F_{AE}}{A_{AE}} = \frac{10.67}{1.25} = 8.53 \text{ ksi (C) Ans}$$

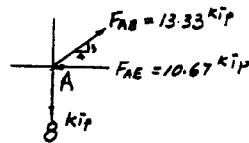

Joint E :

$$\sigma_{ED} = \frac{F_{ED}}{A_{ED}} = \frac{10.67}{1.25} = 8.53 \text{ ksi (C) Ans}$$

$$\sigma_{EB} = \frac{F_{EB}}{A_{EB}} = \frac{6.0}{1.25} = 4.80 \text{ ksi (T) Ans}$$

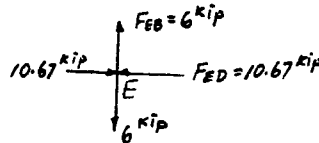

Joint B :

$$\sigma_{BC} = \frac{F_{BC}}{A_{BC}} = \frac{29.33}{1.25} = 23.5 \text{ ksi (T) Ans}$$

$$\sigma_{BD} = \frac{F_{BD}}{A_{BD}} = \frac{23.33}{1.25} = 18.7 \text{ ksi (C) Ans}$$

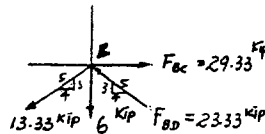

From *Mechanics of Materials*, Sixth Edition by R. C. Hibbeler, ISBN 0-13-191345-X.

© 2005 R. C. Hibbeler. Published by Pearson Prentice Hall,

Pearson Education, Inc., Upper Saddle River, NJ. All rights reserved.

This material is protected under all copyright laws as they currently exist. No portion of this material may be reproduced, in any form or by any means, without permission in writing from the publisher.

1-59. The bars of the truss each have a cross-sectional area of 1.25 in^2 . If the maximum average normal stress in any bar is not to exceed 20 ksi, determine the maximum magnitude P of the loads that can be applied to the truss.

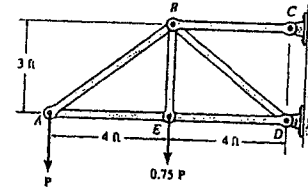

Joint A :

$$+\uparrow \Sigma F_y = 0; \quad -P + \left(\frac{3}{5}\right)F_{AB} = 0$$

$$F_{AB} = (1.667)P$$

$$\rightarrow \Sigma F_x = 0; \quad -F_{AE} + (1.667)P\left(\frac{4}{5}\right) = 0$$

$$F_{AE} = (1.333)P$$

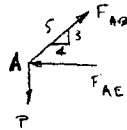

Joint E :

$$+\uparrow \Sigma F_y = 0; \quad F_{EB} - (0.75)P = 0$$

$$F_{EB} = (0.75)P$$

$$\rightarrow \Sigma F_x = 0; \quad (1.333)P - F_{ED} = 0$$

$$F_{ED} = (1.333)P$$

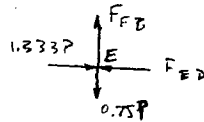

Joint B :

$$+\uparrow \Sigma F_y = 0; \quad \left(\frac{3}{5}\right)F_{BD} - (0.75)P - (1.667)P\left(\frac{3}{5}\right) = 0$$

$$F_{BD} = (2.9167)P$$

$$\rightarrow \Sigma F_x = 0; \quad F_{BC} - (2.9167)P\left(\frac{4}{5}\right) - (1.667)P\left(\frac{4}{5}\right) = 0$$

$$F_{BC} = (3.67)P$$

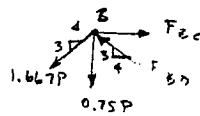

The highest stressed member is BC :

$$\sigma_{BC} = \frac{(3.67)P}{1.25} = 20$$

$$P = 6.82 \text{ kip} \quad \text{Ans}$$

From *Mechanics of Materials*, Sixth Edition by R. C. Hibbeler, ISBN 0-13-191345-X.

© 2005 R. C. Hibbeler. Published by Pearson Prentice Hall,

Pearson Education, Inc., Upper Saddle River, NJ. All rights reserved.

This material is protected under all copyright laws as they currently exist. No portion of this material may be reproduced, in any form or by any means, without permission in writing from the publisher.

***1-60.** The truss is made from three pin-connected members having the cross-sectional areas shown in the figure. Determine the average normal stress developed in each member when the truss is subjected to the load shown. State whether the stress is tensile or compressive.

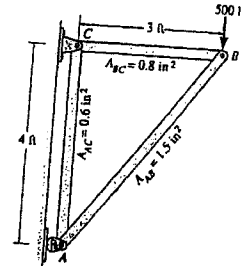

Joint B :

$$\sigma_{AB} = \frac{F_{AB}}{A_{AB}} = \frac{625}{1.5} = 417 \text{ psi (C) Ans}$$

$$\sigma_{BC} = \frac{F_{BC}}{A_{BC}} = \frac{375}{0.8} = 469 \text{ psi (T) Ans}$$

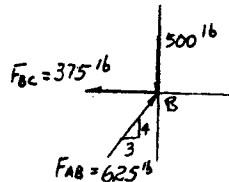

Joint A :

$$\sigma_{AC} = \frac{F_{AC}}{A_{AC}} = \frac{500}{0.6} = 833 \text{ psi (T) Ans}$$

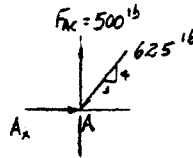

From *Mechanics of Materials*, Sixth Edition by R. C. Hibbeler, ISBN 0-13-191345-X.

© 2005 R. C. Hibbeler. Published by Pearson Prentice Hall,

Pearson Education, Inc., Upper Saddle River, NJ. All rights reserved.

This material is protected under all copyright laws as they currently exist. No portion of this material may be reproduced, in any form or by any means, without permission in writing from the publisher.

1-61 The uniform beam is supported by two rods AB and CD that have cross-sectional areas of 12 mm^2 and 8 mm^2 , respectively. If $d = 1 \text{ m}$, determine the average normal stress in each rod.

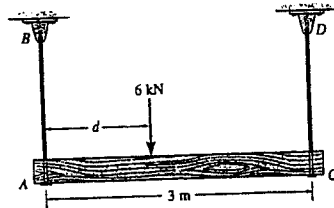

$$\left(\uparrow \Sigma M_A = 0; \quad F_{CD}(3) - 6(1) = 0 \right.$$

$$F_{CD} = 2 \text{ kN}$$

$$+ \uparrow \Sigma F_y = 0; \quad F_{AB} - 6 + 2 = 0$$

$$F_{AB} = 4 \text{ kN}$$

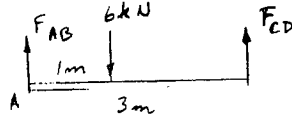

$$\sigma_{AB} = \frac{F_{AB}}{A_{AB}} = \frac{4(10^3)}{12(10^{-6})} = 333 \text{ MPa} \quad \text{Ans}$$

$$\sigma_{CD} = \frac{F_{CD}}{A_{CD}} = \frac{2(10^3)}{8(10^{-6})} = 250 \text{ MPa} \quad \text{Ans}$$

From *Mechanics of Materials*, Sixth Edition by R. C. Hibbeler, ISBN 0-13-191345-X.

© 2005 R. C. Hibbeler. Published by Pearson Prentice Hall,

Pearson Education, Inc., Upper Saddle River, NJ. All rights reserved.

This material is protected under all copyright laws as they currently exist. No portion of this material may be reproduced, in any form or by any means, without permission in writing from the publisher.

1-62 The uniform beam is supported by two rods AB and CD that have cross-sectional areas of 12 mm^2 and 8 mm^2 , respectively. Determine the position d of the 6-kN load so that the average normal stress in each rod is the same.

$$\left(+ \sum M_O = 0; \quad F_{CD} (3 - d) - F_{AB} (d) = 0 \quad (1) \right.$$

$$\sigma = \frac{F_{AB}}{12} = \frac{F_{CD}}{8}$$

$$F_{AB} = 1.5 F_{CD} \quad (2)$$

From Eqs. (1) and (2),

$$F_{CD} (3 - d) - 1.5 F_{CD} (d) = 0$$

$$F_{CD} (3 - d - 1.5 d) = 0$$

$$3 - 2.5 d = 0$$

$$d = 1.20 \text{ m} \quad \text{Ans}$$

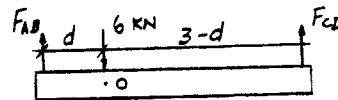
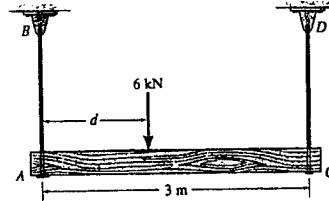

From *Mechanics of Materials*, Sixth Edition by R. C. Hibbeler, ISBN 0-13-191345-X.
 © 2005 R. C. Hibbeler. Published by Pearson Prentice Hall,
 Pearson Education, Inc., Upper Saddle River, NJ. All rights reserved.
 This material is protected under all copyright laws as they currently exist. No portion of this material may be reproduced, in any form or by any means, without permission in writing from the publisher.

1-63 The railcar docklight is supported by the $\frac{1}{8}$ -in.-diameter pin at A. If the lamp weighs 4 lb, and the extension arm AB has a weight of 0.5 lb/ft, determine the average shear stress in the pin needed to support the lamp. *Hint:* The shear force in the pin is caused by the couple moment required for equilibrium at A.

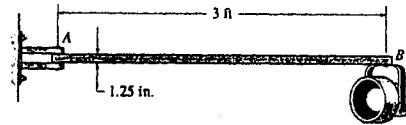

$$\sum M_A = 0; \quad V(1.25) - 1.5(18) - 4(36) = 0$$

$$V = 136.8 \text{ lb}$$

$$\tau_{\text{avg}} = \frac{V}{A} = \frac{136.8}{\frac{\pi}{4}\left(\frac{1}{8}\right)^2} = 11.1 \text{ ksi} \quad \text{Ans}$$

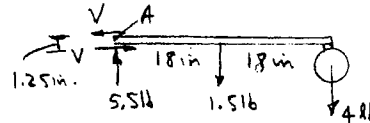

From *Mechanics of Materials*, Sixth Edition by R. C. Hibbeler, ISBN 0-13-191345-X.

© 2005 R. C. Hibbeler. Published by Pearson Prentice Hall,

Pearson Education, Inc., Upper Saddle River, NJ. All rights reserved.

This material is protected under all copyright laws as they currently exist. No portion of this material may be reproduced, in any form or by any means, without permission in writing from the publisher.

*1-64 The two-member frame is subjected to the distributed loading shown. Determine the average normal stress and average shear stress acting at sections $a-a$ and $b-b$. Member CB has a square cross section of 35 mm on each side. Take $w = 8 \text{ kN/m}$.

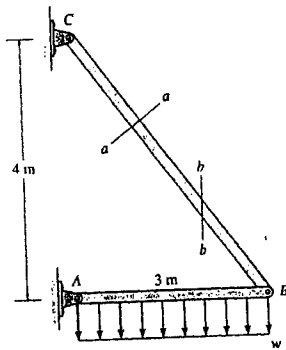

At section $a-a$:

$$\sigma_{a-a} = \frac{15(10^3)}{(0.035)^2} = 12.2 \text{ MPa} \quad \text{Ans}$$

$$\tau_{a-a} = 0 \quad \text{Ans}$$

At section $b-b$:

$$\rightarrow \Sigma F_x = 0; \quad N - 15(3/5) = 0; \quad N = 9 \text{ kN}$$

$$+ \downarrow \Sigma F_y = 0; \quad V - 15(4/5) = 0; \quad V = 12 \text{ kN}$$

$$\sigma_{b-b} = \frac{9(10^3)}{(0.035)(0.035/0.6)} = 4.41 \text{ MPa} \quad \text{Ans}$$

$$\tau_{b-b} = \frac{12(10^3)}{(0.035)(0.035/0.6)} = 5.88 \text{ MPa} \quad \text{Ans}$$

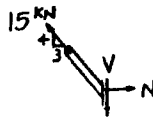
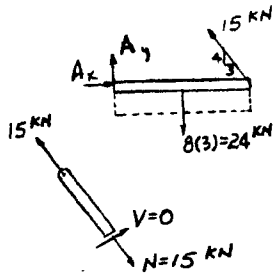

From *Mechanics of Materials*, Sixth Edition by R. C. Hibbeler, ISBN 0-13-191345-X.

© 2005 R. C. Hibbeler. Published by Pearson Prentice Hall,

Pearson Education, Inc., Upper Saddle River, NJ. All rights reserved.

This material is protected under all copyright laws as they currently exist. No portion of this material may be reproduced, in any form or by any means, without permission in writing from the publisher.

1-65 The two-member frame is subjected to the distributed loading shown. Determine the intensity w of the largest uniform loading that can be applied to the frame without causing either the average normal stress or the average shear stress at section $b-b$ to exceed $\sigma = 15 \text{ MPa}$ and $\tau = 16 \text{ MPa}$, respectively. Member CB has a square cross section of 35 mm on each side.

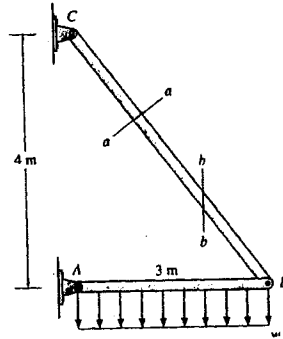

$$\begin{aligned} \left(+ \sum M_A = 0; \quad (4/5)F_{BC}(3) - 3w(1.5) = 0 \right. \\ \left. 2.4 F_{BC} - 4.5w = 0 \quad (1) \right. \end{aligned}$$

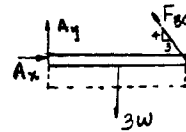

$$\rightarrow \sum F_x = 0; \quad N - (3/5)F_{BC} = 0; \quad N = 0.6F_{BC}$$

$$\downarrow \sum F_y = 0; \quad V - (4/5)F_{BC} = 0; \quad V = 0.8F_{BC}$$

$$\sigma = 15(10^6) = \frac{0.6F_{BC}}{(0.035)(0.035/0.6)}$$

$$F_{BC} = 51.04 \text{ kN}$$

$$\tau = 16(10^6) = \frac{0.8F_{BC}}{(0.035)(0.035/0.6)}$$

$$F_{BC} = 40.83 \text{ kN} \quad (\text{controls})$$

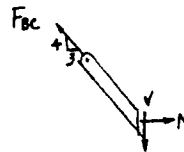

From Eq. (1),

$$2.4(40.83) - 4.5w = 0$$

$$w = 21.8 \text{ kN/m} \quad \text{Ans}$$

From *Mechanics of Materials*, Sixth Edition by R. C. Hibbeler, ISBN 0-13-191345-X.

© 2005 R. C. Hibbeler. Published by Pearson Prentice Hall,

Pearson Education, Inc., Upper Saddle River, NJ. All rights reserved.

This material is protected under all copyright laws as they currently exist. No portion of this material may be reproduced, in any form or by any means, without permission in writing from the publisher.

Because of the number and variety of potential correct solutions to this problem, no solution is being given.

From *Mechanics of Materials*, Sixth Edition by R. C. Hibbeler, ISBN 0-13-191345-X.

© 2005 R. C. Hibbeler. Published by Pearson Prentice Hall,

Pearson Education, Inc, Upper Saddle River, NJ. All rights reserved.

This material is protected under all copyright laws as they currently exist. No portion of this material may be reproduced, in any form or by any means, without permission in writing from the publisher.

1-67. The beam is supported by a pin at A and a short link BC. If $P = 15$ kN, determine the average shear stress developed in the pins at A, B, and C. All pins are in double shear as shown, and each has a diameter of 18 mm.

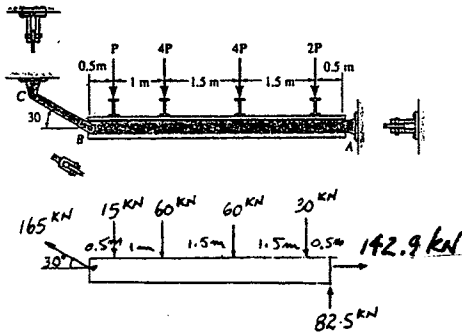

For pins B and C:

$$\tau_B = \tau_C = \frac{V}{A} = \frac{82.5 (10^3)}{\frac{\pi}{4} (18)^2} = 324 \text{ MPa} \quad \text{Ans}$$



For pin A:

$$F_A = \sqrt{(82.5)^2 + (142.9)^2} = 165 \text{ kN}$$

$$\tau_A = \frac{V}{A} = \frac{82.5 (10^3)}{\frac{\pi}{4} (18)^2} = 324 \text{ MPa} \quad \text{Ans}$$

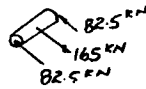

From *Mechanics of Materials*, Sixth Edition by R. C. Hibbeler, ISBN 0-13-191345-X.

© 2005 R. C. Hibbeler. Published by Pearson Prentice Hall,

Pearson Education, Inc., Upper Saddle River, NJ. All rights reserved.

This material is protected under all copyright laws as they currently exist. No portion of this material may be reproduced, in any form or by any means, without permission in writing from the publisher.

*1-68. The beam is supported by a pin at A and a short link BC . Determine the maximum magnitude P of the loads the beam will support if the average shear stress in each pin is not to exceed 80 MPa. All pins are in double shear as shown, and each has a diameter of 18 mm.

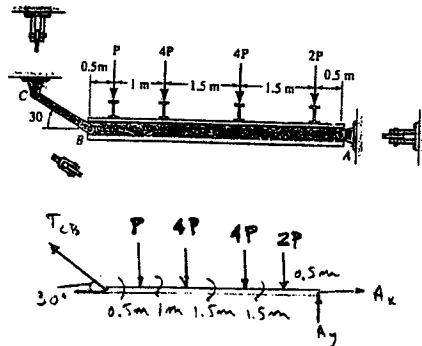

$$\begin{aligned} \curvearrowleft + \Sigma M_A = 0; & \quad 2P(0.5) + 4P(2) + 4P(3.5) + P(4.5) - (T_{CB} \sin 30^\circ)(5) = 0 \\ & \quad T_{CB} = 11P \end{aligned}$$

$$\begin{aligned} \rightarrow \Sigma F_x = 0; & \quad A_x - 11P \cos 30^\circ = 0 \\ & \quad A_x = 9.5263P \end{aligned}$$

$$\begin{aligned} + \uparrow \Sigma F_y = 0; & \quad A_y - 11P + 11P \sin 30^\circ = 0 \\ & \quad A_y = 5.5P \end{aligned}$$

$$F_A = \sqrt{(9.5263P)^2 + (5.5P)^2} = 11P$$

Require;

$$\tau = \frac{V}{A}; \quad 80(10^6) = \frac{11P/2}{\frac{\pi}{4}(0.018)^2}$$

$$P = 3.70 \text{ kN} \quad \mathbf{Ans}$$

From *Mechanics of Materials*, Sixth Edition by R. C. Hibbeler, ISBN 0-13-191345-X.

© 2005 R. C. Hibbeler. Published by Pearson Prentice Hall,

Pearson Education, Inc., Upper Saddle River, NJ. All rights reserved.

This material is protected under all copyright laws as they currently exist. No portion of this material may be reproduced, in any form or by any means, without permission in writing from the publisher.

1-69 When the hand is holding the 5-lb stone, the humerus H , assumed to be smooth, exerts normal forces F_C and F_A on the radius C and ulna A , respectively, as shown. If the smallest cross-sectional area of the ligament at B is 0.30 in^2 , determine the greatest average tensile stress to which it is subjected.

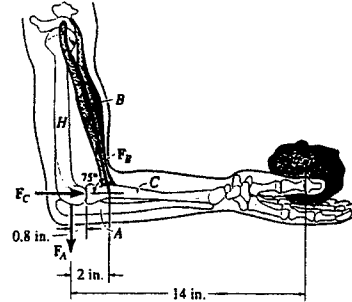

$$\left(+ \right) \Sigma M_O = 0; \quad F_B \sin 75^\circ (2) - 5(14) = 0$$

$$F_B = 36.235 \text{ lb}$$

$$\sigma = \frac{P}{A} = \frac{36.235}{0.30} = 121 \text{ psi} \quad \text{Ans}$$

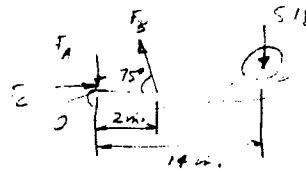

From *Mechanics of Materials*, Sixth Edition by R. C. Hibbeler, ISBN 0-13-191345-X.

© 2005 R. C. Hibbeler. Published by Pearson Prentice Hall,

Pearson Education, Inc., Upper Saddle River, NJ. All rights reserved.

This material is protected under all copyright laws as they currently exist. No portion of this material may be reproduced, in any form or by any means, without permission in writing from the publisher.

1-70 The jib crane is pinned at A and supports a chain hoist that can travel along the bottom flange of the beam, $1 \text{ ft} \leq x \leq 12 \text{ ft}$. If the hoist is rated to support a maximum of 1500 lb , determine the maximum average normal stress in the $\frac{3}{4}$ -in.-diameter tie rod BC and the maximum average shear stress in the $\frac{5}{8}$ -in.-diameter pin at B .

$$\left(+ \sum M_A = 0; \quad T_{BC} \sin 30^\circ (10) - 1500(x) = 0 \right.$$

Maximum T_{BC} occurs when $x = 12 \text{ ft}$

$$T_{BC} = 3600 \text{ lb}$$

$$\sigma = \frac{P}{A} = \frac{3600}{\frac{\pi}{4}(0.75)^2} = 8.15 \text{ ksi} \quad \text{Ans}$$

$$\tau = \frac{V}{A} = \frac{3600/2}{\frac{\pi}{4}(5/8)^2} = 5.87 \text{ ksi} \quad \text{Ans}$$

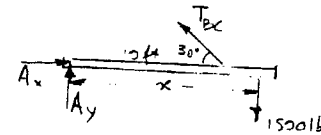
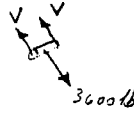
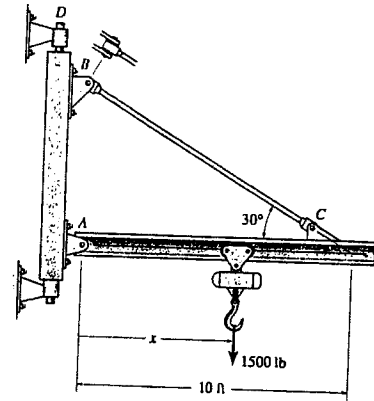

From *Mechanics of Materials*, Sixth Edition by R. C. Hibbeler, ISBN 0-13-191345-X.

© 2005 R. C. Hibbeler. Published by Pearson Prentice Hall,

Pearson Education, Inc., Upper Saddle River, NJ. All rights reserved.

This material is protected under all copyright laws as they currently exist. No portion of this material may be reproduced, in any form or by any means, without permission in writing from the publisher.

1-71 Determine the average normal stress developed in links AB and CD of the two-tine grapple that supports the log having a mass of 3 Mg. The cross-sectional area of each link is 400 mm^2 .

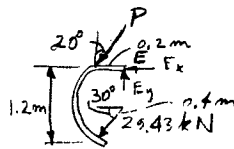
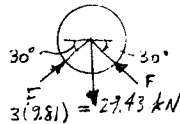
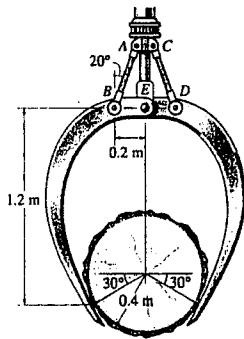

$$+\uparrow \Sigma F_y = 0; \quad 2(F \sin 30^\circ) - 29.43 = 0$$

$$F = 29.43 \text{ kN}$$

$$\curvearrowleft \Sigma M_E = 0; \quad P \cos 20^\circ (0.2) - (29.43 \cos 30^\circ)(1.2) + (29.43 \sin 30^\circ)(0.4 \cos 30^\circ) = 0$$

$$P = 135.61 \text{ kN}$$

$$\sigma = \frac{P}{A} = \frac{135.61(10^3)}{400(10^{-6})} = 339 \text{ MPa} \quad \text{Ans}$$

From *Mechanics of Materials*, Sixth Edition by R. C. Hibbeler, ISBN 0-13-191345-X.

© 2005 R. C. Hibbeler. Published by Pearson Prentice Hall,

Pearson Education, Inc., Upper Saddle River, NJ. All rights reserved.

This material is protected under all copyright laws as they currently exist. No portion of this material may be reproduced, in any form or by any means, without permission in writing from the publisher.

*1-72 Determine the average shear stress developed in pins *A* and *B* of the two-tine grapple that supports the log having a mass of 3 Mg. Each pin has a diameter of 25 mm and is subjected to double shear.

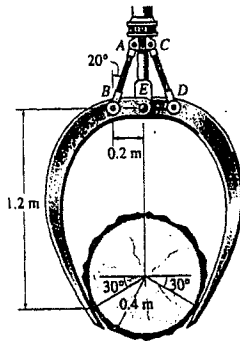

Prob. 1-72

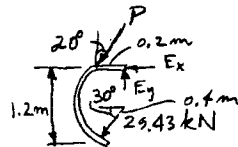
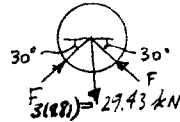

$$+\uparrow \Sigma F_y = 0; \quad 2(F \sin 30^\circ) - 29.43 = 0$$

$$F = 29.43 \text{ kN}$$

$$\curvearrowleft \Sigma M_E = 0; \quad P \cos 20^\circ (0.2) - (29.43 \cos 30^\circ)(1.2) + (29.43 \sin 30^\circ)(0.4 \cos 30^\circ) = 0$$

$$P = 135.61 \text{ kN}$$

$$\tau_A = \tau_B = \frac{V}{A} = \frac{\frac{135.61(10^3)}{2}}{\frac{\pi}{4}(0.025)^2} = 138 \text{ MPa} \quad \text{Ans}$$



From *Mechanics of Materials*, Sixth Edition by R. C. Hibbeler, ISBN 0-13-191345-X.

© 2005 R. C. Hibbeler. Published by Pearson Prentice Hall,

Pearson Education, Inc., Upper Saddle River, NJ. All rights reserved.

This material is protected under all copyright laws as they currently exist. No portion of this material may be reproduced, in any form or by any means, without permission in writing from the publisher.

1-73 The pedestal in the shape of a frustum of a cone is made of concrete having a specific weight of 150 lb/ft³. Determine the average normal stress acting in the pedestal at its base. *Hint:* The volume of a cone of radius r and height h is $V = \frac{1}{3}\pi r^2 h$.

$$\frac{h}{1.5} = \frac{h-8}{1}, \quad h = 24 \text{ ft}$$

$$V = \frac{1}{3}\pi(1.5)^2(24) - \frac{1}{3}\pi(1)^2(16); \quad V = 39.794 \text{ ft}^3$$

$$W = 150(39.794) = 5.969 \text{ kip}$$

$$\sigma = \frac{P}{A} = \frac{5.969}{\pi(1.5)^2} = 844 \text{ psf} = 5.86 \text{ psi} \quad \text{Ans}$$

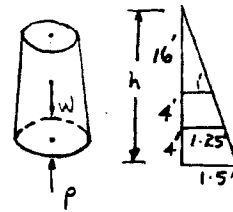
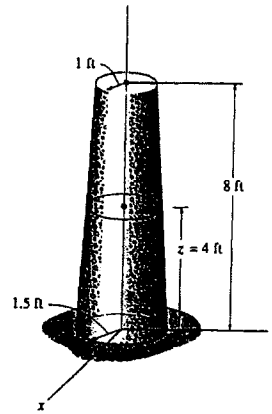

From *Mechanics of Materials*, Sixth Edition by R. C. Hibbeler, ISBN 0-13-191345-X.

© 2005 R. C. Hibbeler. Published by Pearson Prentice Hall,

Pearson Education, Inc., Upper Saddle River, NJ. All rights reserved.

This material is protected under all copyright laws as they currently exist. No portion of this material may be reproduced, in any form or by any means, without permission in writing from the publisher.

1-74 The pedestal in the shape of a frustum of a cone is made of concrete having a specific weight of 150 lb/ft^3 . Determine the average normal stress acting in the pedestal at its midheight, $z = 4 \text{ ft}$. *Hint:* The volume of a cone of radius r and height h is $V = \frac{1}{3}\pi r^2 h$.

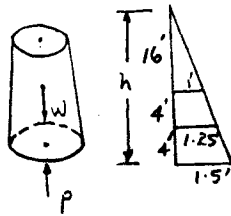
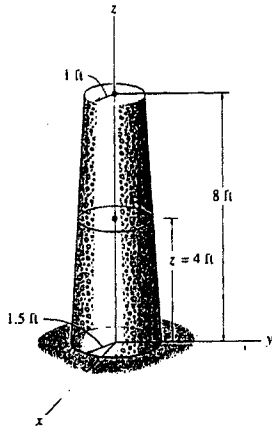

$$W = \left[\frac{1}{3} \pi (1.25)^2 (20) - \frac{1}{3} (\pi) (1^2) (16) \right] (150) = 2395.5 \text{ lb}$$

$$\frac{h}{1.5} = \frac{h-8}{1}, \quad h = 24 \text{ ft}$$

$$+\uparrow \Sigma F_y = 0; \quad P - 2395.5 = 0$$

$$P = 2395.5 \text{ lb}$$

$$\sigma = \frac{P}{A} = \frac{2395.5}{\pi (1.25)^2} = 488 \text{ psf} = 3.39 \text{ psi} \quad \text{Ans}$$

From *Mechanics of Materials*, Sixth Edition by R. C. Hibbeler, ISBN 0-13-191345-X.

© 2005 R. C. Hibbeler. Published by Pearson Prentice Hall,

Pearson Education, Inc., Upper Saddle River, NJ. All rights reserved.

This material is protected under all copyright laws as they currently exist. No portion of this material may be reproduced, in any form or by any means, without permission in writing from the publisher.

1-75. The column is made of concrete having a density of 2.30 Mg/m^3 . At its top B it is subjected to an axial compressive force of 15 kN . Determine the average normal stress in the column as a function of the distance z measured from its base. *Note:* The result will be useful only for finding the average normal stress at a section removed from the ends of the column, because of localized deformation at the ends.

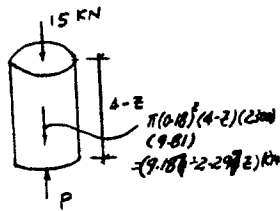
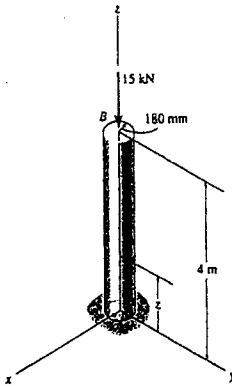

$$+\uparrow \Sigma F_y = 0 \quad P - 15 - 9.187 + 2.297z = 0$$

$$P = 24.187 - 2.297z$$

$$\sigma = \frac{P}{A} = \frac{24.187 - 2.297z}{\pi(0.18)^2} = (238 - 22.6z) \text{ kPa} \quad \text{Ans}$$

From *Mechanics of Materials*, Sixth Edition by R. C. Hibbeler, ISBN 0-13-191345-X.

© 2005 R. C. Hibbeler. Published by Pearson Prentice Hall,

Pearson Education, Inc., Upper Saddle River, NJ. All rights reserved.

This material is protected under all copyright laws as they currently exist. No portion of this material may be reproduced, in any form or by any means, without permission in writing from the publisher.

*1-76 The pier is made of material having a specific weight γ . If it has a square cross section, determine its width w as a function of z so that the average normal stress in the pier remains constant. The pier supports a constant load P at its top where its width is w_1 .

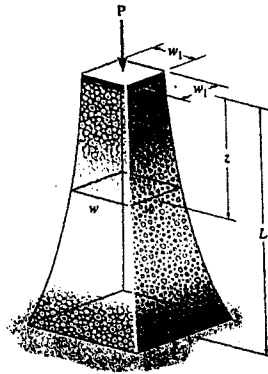

Assume constant stress σ_1 , then at the top,

$$\sigma_1 = \frac{P}{w_1^2} \quad (1)$$

For an increase in z the area must increase,

$$dA = \frac{dW}{\sigma_1} = \frac{\gamma A dz}{\sigma_1} \quad \text{or} \quad \frac{dA}{A} = \frac{\gamma}{\sigma_1} dz$$

For the top section :

$$\int_{A_1}^A \frac{dA}{A} = \frac{\gamma}{\sigma_1} \int_0^z dz$$

$$\ln \frac{A}{A_1} = \frac{\gamma}{\sigma_1} z$$

$$A = A_1 e^{\left(\frac{\gamma}{\sigma_1}\right)z}$$

$$A = w^2$$

$$A_1 = w_1^2$$

$$w = w_1 e^{\left(\frac{\gamma}{2\sigma_1}\right)z}$$

From Eq. (1),

$$w = w_1 e^{\left[\frac{w_1^2 \gamma}{2P}\right]z} \quad \text{Ans}$$

Also see the method used in Prob. 1 - 77.

From *Mechanics of Materials*, Sixth Edition by R. C. Hibbeler, ISBN 0-13-191345-X.

© 2005 R. C. Hibbeler. Published by Pearson Prentice Hall,

Pearson Education, Inc., Upper Saddle River, NJ. All rights reserved.

This material is protected under all copyright laws as they currently exist. No portion of this material may be reproduced, in any form or by any means, without permission in writing from the publisher.

1-77. The pedestal supports a load P at its center. If the material has a mass density ρ , determine the radial dimension r as a function of z so that the average normal stress in the pedestal remains constant. The cross section is circular.

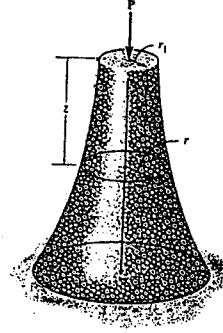

Require :

$$\sigma = \frac{P + W_1}{A} = \frac{P + W_1 + dW}{A + dA}$$

$$P dA + W_1 dA = A dW$$

$$\frac{dW}{dA} = \frac{P + W_1}{A} = \sigma \quad (1)$$

$$dA = \pi(r + dr)^2 - \pi r^2 = 2\pi r dr$$

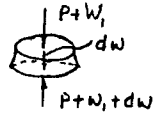

$$dW = \pi r^2(\rho g) dz$$

From Eq. (1),

$$\frac{\pi r^2(\rho g) dz}{2\pi r dr} = \sigma$$

$$\frac{r \rho g dz}{2 dr} = \sigma$$

$$\frac{\rho g}{2\sigma} \int_0^z dz = \int_{r_1}^r \frac{dr}{r}$$

$$\frac{\rho g z}{2\sigma} = \ln \frac{r}{r_1}; \quad r = r_1 e^{(\frac{\rho g}{2\sigma})z}$$

However, $\sigma = \frac{P}{\pi r_1^2}$

$$r = r_1 e^{(\frac{\pi r_1^2 \rho g}{2P})z}$$

Ans

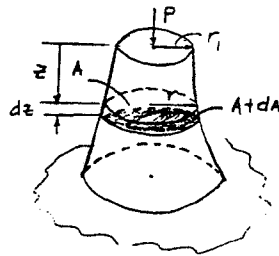

From *Mechanics of Materials*, Sixth Edition by R. C. Hibbeler, ISBN 0-13-191345-X.

© 2005 R. C. Hibbeler. Published by Pearson Prentice Hall,

Pearson Education, Inc., Upper Saddle River, NJ. All rights reserved.

This material is protected under all copyright laws as they currently exist. No portion of this material may be reproduced, in any form or by any means, without permission in writing from the publisher.

1-78. The radius of the pedestal is defined by $r = (0.5e^{-0.08y^2})$ m, where y is given in meters. If the material has a density of 2.5 Mg/m^3 , determine the average normal stress at the support.

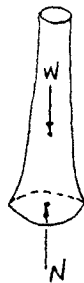
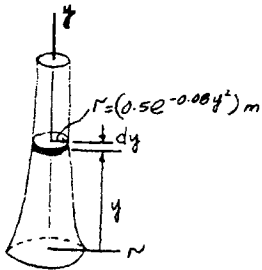
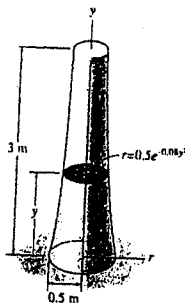

$$A = \pi (0.5)^2 = 0.7854 \text{ m}^2$$

$$dV = \pi (r^2) dy = \pi (0.5)^2 (e^{-0.08y^2})^2$$

$$V = \int_0^3 \pi (0.5)^2 (e^{-0.08y^2})^2 dy = 0.7854 \int_0^3 (e^{-0.08y^2})^2 dy$$

$$W = \rho g V = (2500)(9.81)(0.7854) \int_0^3 (e^{-0.08y^2})^2 dy$$

$$W = 19.262(10^3) \int_0^3 (e^{-0.08y^2})^2 dy = 38.849 \text{ kN}$$

$$\sigma = \frac{W}{A} = \frac{38.849}{0.7854} = 49.5 \text{ kPa} \quad \text{Ans}$$

From *Mechanics of Materials*, Sixth Edition by R. C. Hibbeler, ISBN 0-13-191345-X.

© 2005 R. C. Hibbeler. Published by Pearson Prentice Hall,

Pearson Education, Inc., Upper Saddle River, NJ. All rights reserved.

This material is protected under all copyright laws as they currently exist. No portion of this material may be reproduced, in any form or by any means, without permission in writing from the publisher.

1-79 Determine the greatest constant angular velocity ω of the flywheel so that the average normal stress in its rim does not exceed $\sigma = 15 \text{ MPa}$. Assume the rim is a thin ring having a thickness of 3 mm, width of 20 mm, and a mass of 30 kg/m. Rotation occurs in the horizontal plane. Neglect the effect of the spokes in the analysis. *Hint:* Consider a free-body diagram of a semicircular portion of the ring. The center of mass for a semicircular segment is located at $\bar{r} = 2r/\pi$ from the diameter.

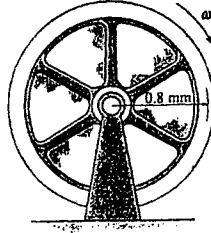

$$+\downarrow \Sigma F_n = m(a_G)_n; \quad 2T = m(\bar{r})\omega^2$$

$$2\sigma A = m\left(\frac{2r}{\pi}\right)\omega^2$$

$$2(15(10^6))(0.003)(0.020) = \pi(0.8)(30)\left(\frac{2(0.8)}{\pi}\right)\omega^2$$

$$\omega = 6.85 \text{ rad/s} \quad \text{Ans}$$



From *Mechanics of Materials*, Sixth Edition by R. C. Hibbeler, ISBN 0-13-191345-X.
 © 2005 R. C. Hibbeler. Published by Pearson Prentice Hall,
 Pearson Education, Inc., Upper Saddle River, NJ. All rights reserved.
 This material is protected under all copyright laws as they currently exist. No portion of this material may be reproduced, in any form or by any means, without permission in writing from the publisher.

*1-80. Member B is subjected to a compressive force of 800 lb. If A and B are both made of wood and are $\frac{3}{8}$ in. thick, determine to the nearest $\frac{1}{4}$ in. the smallest dimension h of the support so that the average shear stress does not exceed $\tau_{\text{allow}} = 300$ psi.

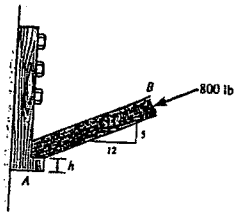

$$\tau_{\text{allow}} = 300 = \frac{307.7}{\left(\frac{3}{8}\right)h}$$

$$h = 2.74 \text{ in.}$$

$$\text{Use } h = 2 \frac{3}{4} \text{ in.} \quad \text{Ans}$$

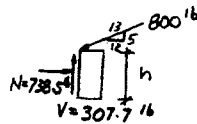

From *Mechanics of Materials*, Sixth Edition by R. C. Hibbeler, ISBN 0-13-191345-X.
 © 2005 R. C. Hibbeler. Published by Pearson Prentice Hall,
 Pearson Education, Inc., Upper Saddle River, NJ. All rights reserved.
 This material is protected under all copyright laws as they currently exist. No portion of this material may be reproduced, in any form or by any means, without permission in writing from the publisher.

1-81 The 60 mm × 60 mm oak post is supported on the pine block. If the allowable bearing stresses for these materials are $\sigma_{\text{oak}} = 43 \text{ MPa}$ and $\sigma_{\text{pine}} = 25 \text{ MPa}$, determine the greatest load P that can be supported. If a rigid bearing plate is used between these materials, determine its required area so that the maximum load P can be supported. What is this load?

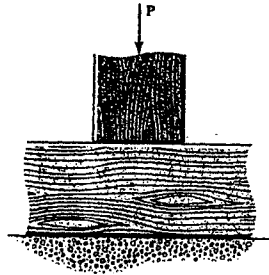

For failure of pine block :

$$\sigma = \frac{P}{A}; \quad 25(10^6) = \frac{P}{(0.06)(0.06)}$$

$$P = 90 \text{ kN} \quad \text{Ans}$$

For failure of oak post :

$$\sigma = \frac{P}{A}; \quad 43(10^6) = \frac{P}{(0.06)(0.06)}$$

$$P = 154.8 \text{ kN}$$

Area of plate based on strength of pine block :

$$\sigma = \frac{P}{A}; \quad 25(10^6) = \frac{154.8(10)^3}{A}$$

$$A = 6.19(10^{-3}) \text{ m}^2 \quad \text{Ans}$$

$$P_{\text{max}} = 155 \text{ kN} \quad \text{Ans}$$

From *Mechanics of Materials*, Sixth Edition by R. C. Hibbeler, ISBN 0-13-191345-X.

© 2005 R. C. Hibbeler. Published by Pearson Prentice Hall,

Pearson Education, Inc., Upper Saddle River, NJ. All rights reserved.

This material is protected under all copyright laws as they currently exist. No portion of this material may be reproduced, in any form or by any means, without permission in writing from the publisher.

1-82 The joint is fastened together using two bolts. Determine the required diameter of the bolts if the allowable shear stress for the bolts is $\tau_{\text{allow}} = 110 \text{ MPa}$. Assume each bolt supports an equal portion of the load.

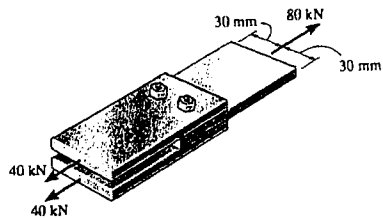

$$\tau_{\text{allow}} = 110 (10^6) = \frac{20 (10^3)}{\frac{\pi}{4} d^2}$$

$$d = 0.0152 \text{ m} = 15.2 \text{ mm} \quad \text{Ans}$$

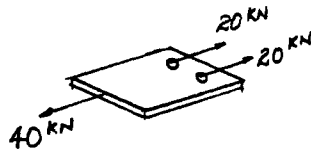

From *Mechanics of Materials*, Sixth Edition by R. C. Hibbeler, ISBN 0-13-191345-X.

© 2005 R. C. Hibbeler. Published by Pearson Prentice Hall,

Pearson Education, Inc., Upper Saddle River, NJ. All rights reserved.

This material is protected under all copyright laws as they currently exist. No portion of this material may be reproduced, in any form or by any means, without permission in writing from the publisher.

1-83 The lever is attached to the shaft A using a key that has a width d and length of 25 mm. If the shaft is fixed and a vertical force of 200 N is applied perpendicular to the handle, determine the dimension d if the allowable shear stress for the key is $\tau_{\text{allow}} = 35 \text{ MPa}$.

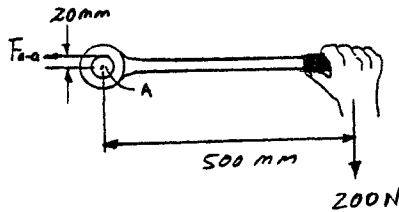
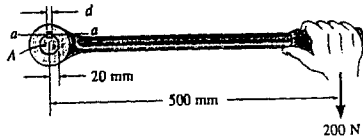

$$\sum M_A = 0; \quad F_{a-a} (20) - 200 (500) = 0$$

$$F_{a-a} = 5000 \text{ N}$$

$$\tau_{\text{allow}} = \frac{F_{a-a}}{A_{a-a}}; \quad 35 (10^6) = \frac{5000}{d (0.025)}$$

$$d = 0.00571 \text{ m} = 5.71 \text{ mm} \quad \text{Ans}$$

From *Mechanics of Materials*, Sixth Edition by R. C. Hibbeler, ISBN 0-13-191345-X.

© 2005 R. C. Hibbeler. Published by Pearson Prentice Hall,

Pearson Education, Inc., Upper Saddle River, NJ. All rights reserved.

This material is protected under all copyright laws as they currently exist. No portion of this material may be reproduced, in any form or by any means, without permission in writing from the publisher.

*1-84. The fillet weld size a is determined by computing the average shear stress along the shaded plane, which has the smallest cross section. Determine the smallest size a of the two welds if the force applied to the plate is $P = 20$ kip. The allowable shear stress for the weld material is $\tau_{\text{allow}} = 14$ ksi.

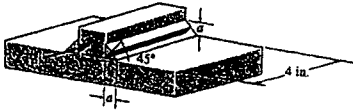

$$\text{Shear plane } A = a \sin 45^\circ(4) = 2.8284 a$$

$$\tau_{\text{allow}} = \frac{V}{A}; \quad 14(10^3) = \frac{20(10^3)}{2.8284 a}$$

$$a = 0.253 \text{ in.}$$

Ans

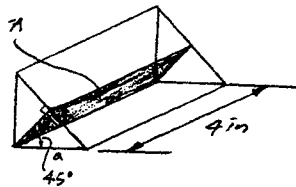

From *Mechanics of Materials*, Sixth Edition by R. C. Hibbeler, ISBN 0-13-191345-X.

© 2005 R. C. Hibbeler. Published by Pearson Prentice Hall,

Pearson Education, Inc., Upper Saddle River, NJ. All rights reserved.

This material is protected under all copyright laws as they currently exist. No portion of this material may be reproduced, in any form or by any means, without permission in writing from the publisher.

1-85. The fillet weld size $a = 0.25$ in. If the joint is assumed to fail by shear on both sides of the block along the shaded plane, which is the smallest cross section, determine the largest force P that can be applied to the plate. The allowable shear stress for the weld material is $\tau_{\text{allow}} = 14$ ksi.

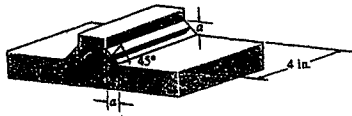

$$\text{Area} = (2)[(4)(0.707)(0.25)] = 1.414 \text{ in}^2$$

$$\tau_{\text{allow}} = \frac{V}{A}; \quad 14 = \frac{P}{1.414}$$

$$P = 19.8 \text{ kip} \quad \text{Ans}$$

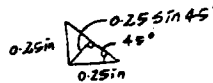

From *Mechanics of Materials*, Sixth Edition by R. C. Hibbeler, ISBN 0-13-191345-X.
 © 2005 R. C. Hibbeler. Published by Pearson Prentice Hall,
 Pearson Education, Inc., Upper Saddle River, NJ. All rights reserved.
 This material is protected under all copyright laws as they currently exist. No portion of this material may be reproduced, in any form or by any means, without permission in writing from the publisher.

1-86 The tension member is fastened together using two bolts, one on each side of the member as shown. Each bolt has a diameter of 0.3 in. Determine the maximum load P that can be applied to the member if the allowable shear stress for the bolts is $\tau_{\text{allow}} = 12$ ksi and the allowable average normal stress is $\sigma_{\text{allow}} = 20$ ksi.

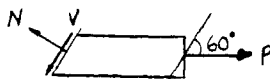

$$\begin{aligned} \uparrow + \Sigma F_y = 0; \quad N - P \sin 60^\circ &= 0 \\ P &= 1.1547 N \quad (1) \end{aligned}$$

$$\begin{aligned} \rightarrow + \Sigma F_x = 0; \quad V - P \cos 60^\circ &= 0 \\ P &= 2V \quad (2) \end{aligned}$$

Assume failure due to shear :

$$\begin{aligned} \tau_{\text{allow}} = 12 &= \frac{V}{(2) \frac{\pi}{4} (0.3)^2} \\ V &= 1.696 \text{ kip} \end{aligned}$$

From Eq. (2),

$$P = 3.39 \text{ kip}$$

Assume failure due to normal force :

$$\sigma_{\text{allow}} = 20 = \frac{N}{(2) \frac{\pi}{4} (0.3)^2}$$

$$N = 2.827 \text{ kip}$$

From Eq. (1),

$$P = 3.26 \text{ kip} \quad (\text{controls}) \quad \mathbf{Ans}$$

From *Mechanics of Materials*, Sixth Edition by R. C. Hibbeler, ISBN 0-13-191345-X.

© 2005 R. C. Hibbeler. Published by Pearson Prentice Hall,

Pearson Education, Inc., Upper Saddle River, NJ. All rights reserved.

This material is protected under all copyright laws as they currently exist. No portion of this material may be reproduced, in any form or by any means, without permission in writing from the publisher.

1-87 The steel swivel bushing in the elevator control of an airplane is held in place using a nut and washer as shown in Fig. (a). Failure of the washer *A* can cause the push rod to separate as shown in Fig. (b). If the maximum average normal stress for the washer is $\sigma_{max} = 60$ ksi and the maximum average shear stress is $\tau_{max} = 21$ ksi, determine the force *F* that must be applied to the bushing that will cause this to happen. The washer is $\frac{1}{16}$ in. thick.

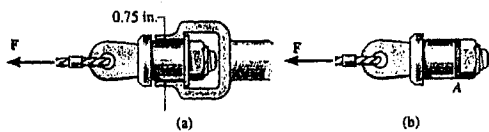

$$\tau_{avg} = \frac{V}{A}; \quad 21(10^3) = \frac{F}{2\pi(0.375)(\frac{1}{16})}$$

$$F = 3,092.5 \text{ lb} = 3.09 \text{ kip} \quad \text{Ans}$$

From *Mechanics of Materials*, Sixth Edition by R. C. Hibbeler, ISBN 0-13-191345-X.

© 2005 R. C. Hibbeler. Published by Pearson Prentice Hall,

Pearson Education, Inc., Upper Saddle River, NJ. All rights reserved.

This material is protected under all copyright laws as they currently exist. No portion of this material may be reproduced, in any form or by any means, without permission in writing from the publisher.

*1-88 The two steel wires AB and AC are used to support the load. If both wires have an allowable tensile stress of $\sigma_{\text{allow}} = 200 \text{ MPa}$, determine the required diameter of each wire if the applied load is $P = 5 \text{ kN}$.

$$\rightarrow \Sigma F_x = 0; \quad \frac{4}{5}F_{AC} - F_{AB} \sin 60^\circ = 0 \quad (1)$$

$$+ \uparrow \Sigma F_y = 0; \quad \frac{3}{5}F_{AC} + F_{AB} \cos 60^\circ - 5 = 0 \quad (2)$$

Solving Eqs. (1) and (2) yields :

$$F_{AB} = 4.3496 \text{ kN}; \quad F_{AC} = 4.7086 \text{ kN}$$

$$\text{Applying } \sigma_{\text{allow}} = \frac{P}{A}$$

For wire AB ,

$$200(10^6) = \frac{4.3496(10^3)}{\frac{\pi}{4}(d_{AB})^2}$$

$$d_{AB} = 0.00526 \text{ m} = 5.26 \text{ mm} \quad \text{Ans}$$

For wire AC ,

$$200(10^6) = \frac{4.7086(10^3)}{\frac{\pi}{4}(d_{AC})^2}$$

$$d_{AC} = 0.00548 \text{ m} = 5.48 \text{ mm} \quad \text{Ans}$$

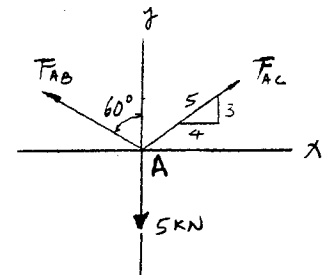
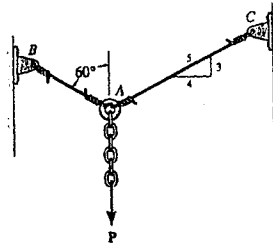

From *Mechanics of Materials*, Sixth Edition by R. C. Hibbeler, ISBN 0-13-191345-X.

© 2005 R. C. Hibbeler. Published by Pearson Prentice Hall,

Pearson Education, Inc., Upper Saddle River, NJ. All rights reserved.

This material is protected under all copyright laws as they currently exist. No portion of this material may be reproduced, in any form or by any means, without permission in writing from the publisher.

1-89 The two steel wires AB and AC are used to support the load. If both wires have an allowable tensile stress of $\sigma_{\text{allow}} = 180 \text{ MPa}$, and wire AB has a diameter of 6 mm and AC has a diameter of 4 mm, determine the greatest force P that can be applied to the chain before one of the wires fails.

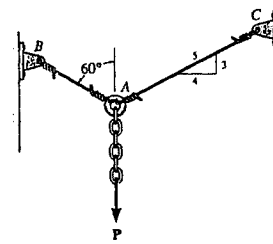

$$\rightarrow \Sigma F_x = 0; \quad \frac{4}{5}F_{AC} - F_{AB} \sin 60^\circ = 0 \quad (1)$$

$$+ \uparrow \Sigma F_y = 0; \quad \frac{3}{5}F_{AC} + F_{AB} \cos 60^\circ - P = 0 \quad (2)$$

Assume failure of AB :

$$\sigma_{\text{allow}} = \frac{F_{AB}}{A_{AB}}; \quad 180(10^6) = \frac{F_{AB}}{\frac{\pi}{4}(0.006)^2}$$

$$F_{AB} = 5089.38 \text{ N} = 5.089 \text{ kN}$$

Solving Eqs.(1) and (2) yields :

$$F_{AC} = 5.509 \text{ kN}; \quad P = 5.85 \text{ kN}$$

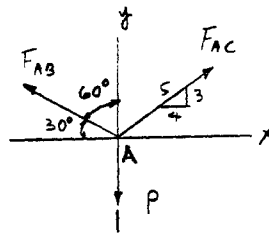

Assume failure of AC :

$$\sigma_{\text{allow}} = \frac{F_{AC}}{A_{AC}}; \quad 180(10^6) = \frac{F_{AC}}{\frac{\pi}{4}(0.004)^2}$$

$$F_{AC} = 2261.94 \text{ N} = 2.262 \text{ kN}$$

Solving Eqs. (1) and (2) yields :

$$F_{AB} = 2.089 \text{ kN}; \quad P = 2.40 \text{ kN}$$

Choose the smallest value

$$P = 2.40 \text{ kN} \quad \text{Ans}$$

From *Mechanics of Materials*, Sixth Edition by R. C. Hibbeler, ISBN 0-13-191345-X.

© 2005 R. C. Hibbeler. Published by Pearson Prentice Hall,

Pearson Education, Inc., Upper Saddle River, NJ. All rights reserved.

This material is protected under all copyright laws as they currently exist. No portion of this material may be reproduced, in any form or by any means, without permission in writing from the publisher.

1-90 The boom is supported by the winch cable that has a diameter of 0.25 in. and an allowable normal stress of $\sigma_{\text{allow}} = 24 \text{ ksi}$. Determine the greatest load that can be supported without causing the cable to fail when $\theta = 30^\circ$. Neglect the size of the winch.

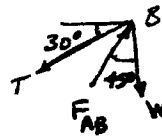
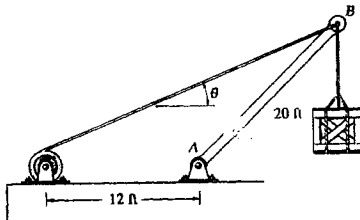

$$\sigma = \frac{P}{A}; \quad 24(10^3) = \frac{T}{\frac{\pi}{4}(0.25)^2};$$

$$T = 1178.10 \text{ lb}$$

$$\rightarrow \Sigma F_x = 0; \quad -1178.10 \cos 30^\circ + F_{AB} \sin 45^\circ = 0$$

$$+\uparrow \Sigma F_y = 0; \quad -W + F_{AB} \cos 45^\circ - 1178.10 \sin 30^\circ = 0$$

$$W = 431 \text{ lb} \quad \text{Ans}$$

$$F_{AB} = 1442.9 \text{ lb}$$

From *Mechanics of Materials*, Sixth Edition by R. C. Hibbeler, ISBN 0-13-191345-X.

© 2005 R. C. Hibbeler. Published by Pearson Prentice Hall,

Pearson Education, Inc., Upper Saddle River, NJ. All rights reserved.

This material is protected under all copyright laws as they currently exist. No portion of this material may be reproduced, in any form or by any means, without permission in writing from the publisher.

1-91 The boom is supported by the winch cable that has an allowable normal stress of $\sigma_{\text{allow}} = 24 \text{ ksi}$. If it is required that it be able to slowly lift 5000 lb, from $\theta = 20^\circ$ to $\theta = 50^\circ$, determine the smallest diameter of the cable to the nearest $\frac{1}{16}$ in. The boom AB has a length of 20 ft. Neglect the size of the winch.

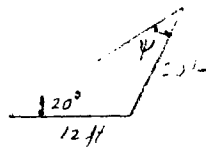
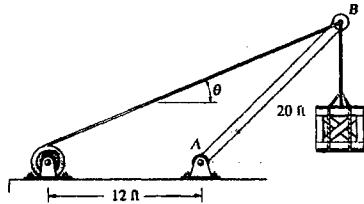

Maximum tension in cable occurs when $\theta = 20^\circ$,

$$\frac{\sin 20^\circ}{20} = \frac{\sin \psi}{12}$$

$$\psi = 11.842^\circ$$

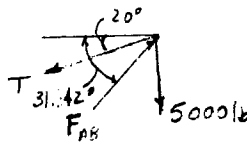

$$\rightarrow \Sigma F_x = 0; \quad -T \cos 20^\circ + F_{AB} \cos 31.842^\circ = 0$$

$$+ \uparrow \Sigma F_y = 0; \quad F_{AB} \sin 31.842^\circ - T \sin 20^\circ - 5000 = 0$$

$$T = 20\,698.3 \text{ lb}$$

$$F_{AB} = 22\,896 \text{ lb}$$

$$\sigma = \frac{P}{A}; \quad 24(10^3) = \frac{20\,698.3}{\frac{\pi}{4}(d)^2}$$

$$d = 1.048 \text{ in.}$$

Use $d = 1\frac{1}{16} \text{ in.}$ **Ans**

From *Mechanics of Materials*, Sixth Edition by R. C. Hibbeler, ISBN 0-13-191345-X.

© 2005 R. C. Hibbeler. Published by Pearson Prentice Hall,

Pearson Education, Inc., Upper Saddle River, NJ. All rights reserved.

This material is protected under all copyright laws as they currently exist. No portion of this material may be reproduced, in any form or by any means, without permission in writing from the publisher.

*1-92 The truss is used to support the loading shown. Determine the required cross-sectional area of member BC if the allowable normal stress is $\sigma_{\text{allow}} = 24 \text{ ksi}$.

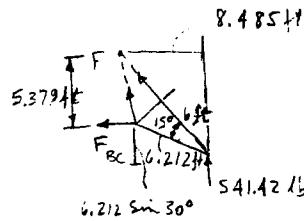
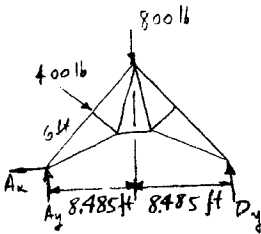
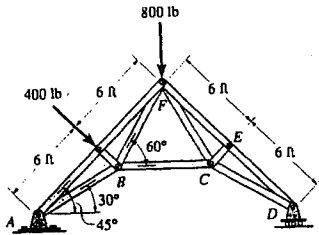

$$+\Sigma M_A = 0; \quad -400(6) - 800(8.485) + 2(8.485)(D_y) = 0$$

$$D_y = 541.42 \text{ lb}$$

$$+\Sigma M_F = 0; \quad 541.42(8.485) - F_{BC}(5.379 \sin 30^\circ) = 0$$

$$F_{BC} = 853.98 \text{ lb}$$

$$\sigma = \frac{P}{A}; \quad 24000 = \frac{853.98}{A}$$

$$A = 0.0356 \text{ in}^2 \quad \text{Ans}$$

From *Mechanics of Materials*, Sixth Edition by R. C. Hibbeler, ISBN 0-13-191345-X.

© 2005 R. C. Hibbeler. Published by Pearson Prentice Hall,

Pearson Education, Inc., Upper Saddle River, NJ. All rights reserved.

This material is protected under all copyright laws as they currently exist. No portion of this material may be reproduced, in any form or by any means, without permission in writing from the publisher.

1-93 The beam is made from southern pine and is supported at its ends by base plates resting on brick work. If the allowable bearing stresses for the materials are $(\sigma_{\text{pine}})_{\text{allow}} = 2.81 \text{ ksi}$ $(\sigma_{\text{brick}})_{\text{allow}} = 6.70 \text{ ksi}$, determine the required length of the base plates at A and B to the nearest $\frac{1}{8}$ inch in order to support the load shown. The plates are 3 in. wide.

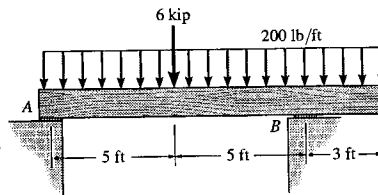

Prob. 1-93

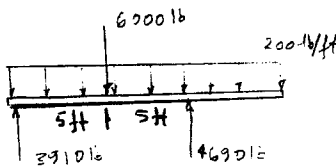

The design must be based on strength of the pine.

At A :

$$\sigma = \frac{P}{A}; \quad 2810 = \frac{3910}{h(3)}$$

$$h_A = 0.464 \text{ in.}$$

$$\text{Use } h_A = \frac{1}{2} \text{ in.} \quad \text{Ans}$$

At B :

$$\sigma = \frac{P}{A}; \quad 2810 = \frac{4690}{h(3)}$$

$$h_B = 0.556 \text{ in.}$$

$$\text{Use } h_B = \frac{3}{4} \text{ in.} \quad \text{Ans}$$

From *Mechanics of Materials*, Sixth Edition by R. C. Hibbeler, ISBN 0-13-191345-X.

© 2005 R. C. Hibbeler. Published by Pearson Prentice Hall,

Pearson Education, Inc., Upper Saddle River, NJ. All rights reserved.

This material is protected under all copyright laws as they currently exist. No portion of this material may be reproduced, in any form or by any means, without permission in writing from the publisher.

1-94 If the allowable bearing stress for the material under the supports at *A* and *B* is $(\sigma_b)_{\text{allow}} = 400$ psi, determine the size of *square* bearing plates *A'* and *B'* required to support the loading. Take $P = 1.5$ kip. Dimension the plates to the nearest $\frac{1}{2}$ in. The reactions at the supports are vertical.

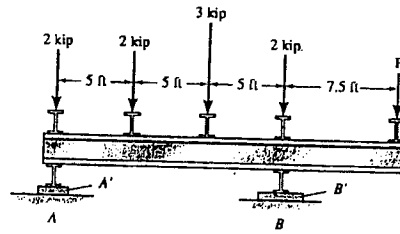

For Plate *A* :

$$\sigma_{\text{allow}} = 400 = \frac{3.583 (10^3)}{a_A^2}$$

$$a_A = 2.99 \text{ in.}$$

Use a 3 in. x 3 in. plate **Ans**

For Plate *B* :

$$\sigma_{\text{allow}} = 400 = \frac{6.917 (10^3)}{a_B^2}$$

$$a_B = 4.16 \text{ in.}$$

Use a $4\frac{1}{2}$ in. x $4\frac{1}{2}$ in. plate **Ans**

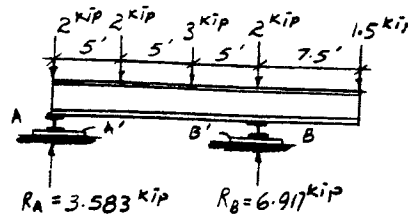

From *Mechanics of Materials*, Sixth Edition by R. C. Hibbeler, ISBN 0-13-191345-X.

© 2005 R. C. Hibbeler. Published by Pearson Prentice Hall,

Pearson Education, Inc., Upper Saddle River, NJ. All rights reserved.

This material is protected under all copyright laws as they currently exist. No portion of this material may be reproduced, in any form or by any means, without permission in writing from the publisher.

1-95 If the allowable bearing stress for the material under the supports at A and B is $(\sigma_b)_{\text{allow}} = 400$ psi, determine the maximum load P that can be applied to the beam. The bearing plates A' and B' have square cross sections of 2 in. \times 2 in. and 4 in. \times 4 in., respectively.

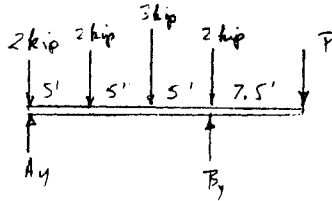
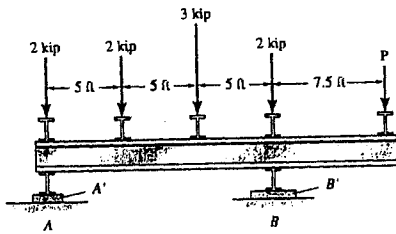

$$+\circlearrowleft \Sigma M_A = 0; \quad B_y(15) - 2(5) - 3(10) - 2(15) - P(22.5) = 0$$

$$B_y = 1.5P + 4.667$$

$$+\uparrow \Sigma F_y = 0; \quad A_y + 1.5P + 4.667 - 9 - P = 0$$

$$A_y = 4.333 - 0.5P$$

At A :

$$0.400 = \frac{4.333 - 0.5P}{2(2)}$$

$$P = 5.47 \text{ kip}$$

At B :

$$0.400 = \frac{1.5P + 4.667}{4(4)}$$

$$P = 1.16 \text{ kip}$$

Thus,

$$P_{\text{allow}} = 1.16 \text{ kip} \quad \text{Ans}$$

From *Mechanics of Materials*, Sixth Edition by R. C. Hibbeler, ISBN 0-13-191345-X.

© 2005 R. C. Hibbeler. Published by Pearson Prentice Hall,

Pearson Education, Inc., Upper Saddle River, NJ. All rights reserved.

This material is protected under all copyright laws as they currently exist. No portion of this material may be reproduced, in any form or by any means, without permission in writing from the publisher.

*1-96. Determine the required cross-sectional area of member BC and the diameter of the pins at A and B if the allowable normal stress is $\sigma_{\text{allow}} = 3 \text{ ksi}$ and the allowable shear stress is $\tau_{\text{allow}} = 4 \text{ ksi}$.

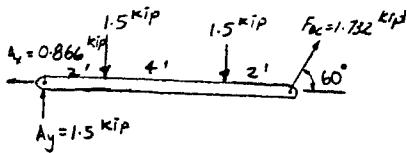
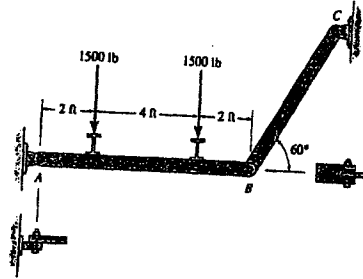

Member BC :

$$\sigma_{\text{allow}} = 3 (10^3) = \frac{1.732 (10^3)}{A_{BC}}$$

$$A_{BC} = 0.577 \text{ in}^2 \quad \text{Ans}$$

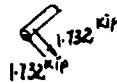

Pin A :

$$F_A = \sqrt{(0.866)^2 + (1.5)^2} = 1.732 \text{ kip}$$

$$\tau_{\text{allow}} = 4 (10^3) = \frac{1.732 (10^3)}{\frac{\pi}{4} (d_A)^2}$$

$$d_A = 0.743 \text{ in.} \quad \text{Ans}$$

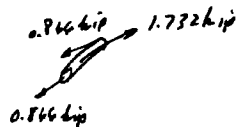

Pin B :

$$\tau_{\text{allow}} = 4 (10^3) = \frac{0.866 (10^3)}{\frac{\pi}{4} (d_B)^2}$$

$$d_B = 0.525 \text{ in.} \quad \text{Ans}$$

From *Mechanics of Materials*, Sixth Edition by R. C. Hibbeler, ISBN 0-13-191345-X.

© 2005 R. C. Hibbeler. Published by Pearson Prentice Hall,

Pearson Education, Inc., Upper Saddle River, NJ. All rights reserved.

This material is protected under all copyright laws as they currently exist. No portion of this material may be reproduced, in any form or by any means, without permission in writing from the publisher.

1-97 The two aluminum rods support the vertical force of $P = 20 \text{ kN}$. Determine their required diameters if the allowable tensile stress for the aluminum is $\sigma_{\text{allow}} = 150 \text{ MPa}$.

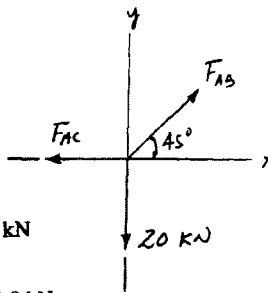
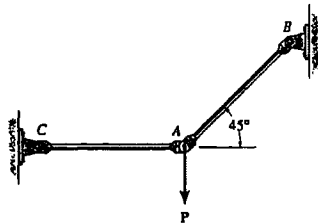

$$\begin{aligned}
 +\uparrow \Sigma F_y = 0; & \quad F_{AB} \sin 45^\circ - 20 = 0; & \quad F_{AB} = 28.284 \text{ kN} \\
 +\rightarrow \Sigma F_x = 0; & \quad 28.284 \cos 45^\circ - F_{AC} = 0; & \quad F_{AC} = 20.0 \text{ kN}
 \end{aligned}$$

For rod AB :

$$\sigma_{\text{allow}} = \frac{F_{AB}}{A_{AB}}; \quad 150(10^6) = \frac{28.284(10^3)}{\frac{\pi}{4}d_{AB}^2}$$

$$d_{AB} = 0.0155 \text{ m} = 15.5 \text{ mm} \quad \text{Ans}$$

For rod AC :

$$\sigma_{\text{allow}} = \frac{F_{AC}}{A_{AC}}; \quad 150(10^6) = \frac{20.0(10^3)}{\frac{\pi}{4}d_{AC}^2}$$

$$d_{AC} = 0.0130 \text{ m} = 13.0 \text{ mm} \quad \text{Ans}$$

From *Mechanics of Materials*, Sixth Edition by R. C. Hibbeler, ISBN 0-13-191345-X.

© 2005 R. C. Hibbeler. Published by Pearson Prentice Hall,

Pearson Education, Inc., Upper Saddle River, NJ. All rights reserved.

This material is protected under all copyright laws as they currently exist. No portion of this material may be reproduced, in any form or by any means, without permission in writing from the publisher.

1-98 The two aluminum rods AB and AC have diameters of 10 mm and 8 mm, respectively. Determine the largest vertical force P that can be supported. The allowable tensile stress for the aluminum is $\sigma_{\text{allow}} = 150 \text{ MPa}$.

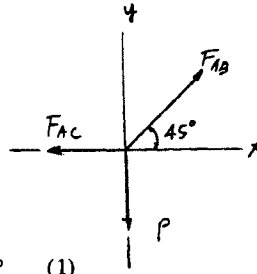
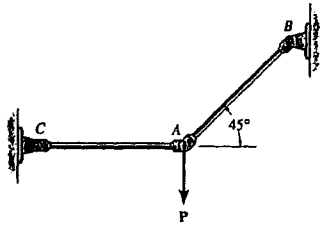

$$+\uparrow \Sigma F_y = 0; \quad F_{AB} \sin 45^\circ - P = 0; \quad P = F_{AB} \sin 45^\circ \quad (1)$$

$$+\rightarrow \Sigma F_x = 0; \quad F_{AB} \cos 45^\circ - F_{AC} = 0 \quad (2)$$

Assume failure of rod AB :

$$\sigma_{\text{allow}} = \frac{F_{AB}}{A_{AB}}; \quad 150(10^6) = \frac{F_{AB}}{\frac{\pi}{4}(0.01)^2}$$

$$F_{AB} = 11.78 \text{ kN}$$

From Eq. (1),

$$P = 8.33 \text{ kN}$$

Assume failure of rod AC :

$$\sigma_{\text{allow}} = \frac{F_{AC}}{A_{AC}}; \quad 150(10^6) = \frac{F_{AC}}{\frac{\pi}{4}(0.008)^2}$$

$$F_{AC} = 7.540 \text{ kN}$$

Solving Eqs. (1) and (2) yields :

$$F_{AB} = 10.66 \text{ kN}; \quad P = 7.54 \text{ kN}$$

Choose the smallest value

$$P = 7.54 \text{ kN} \quad \mathbf{Ans}$$

From *Mechanics of Materials*, Sixth Edition by R. C. Hibbeler, ISBN 0-13-191345-X.
 © 2005 R. C. Hibbeler. Published by Pearson Prentice Hall,
 Pearson Education, Inc., Upper Saddle River, NJ. All rights reserved.
 This material is protected under all copyright laws as they currently exist. No portion of this material may be reproduced, in any form or by any means, without permission in writing from the publisher.

1-99. The hangers support the joist uniformly, so that it is assumed the four nails on each hanger carry an equal portion of the load. If the joist is subjected to the loading shown, determine the average shear stress in each nail of the hanger at ends *A* and *B*. Each nail has a diameter of 0.25 in. The hangers only support vertical loads.

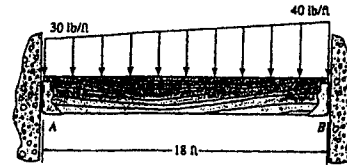

$$\left(+ \right) \Sigma M_A = 0; \quad F_B(18) - 540(9) - 90(12) = 0; \quad F_B = 330 \text{ lb}$$

$$+ \uparrow \Sigma F_y = 0; \quad F_A + 330 - 540 - 90 = 0; \quad F_A = 300 \text{ lb}$$

For nails at *A*,

$$\tau_{avg} = \frac{F_A}{A_A} = \frac{300}{4\left(\frac{\pi}{4}\right)(0.25)^2} = 1528 \text{ psi} = 1.53 \text{ ksi} \quad \text{Ans}$$

For nails at *B*,

$$\tau_{avg} = \frac{F_B}{A_B} = \frac{330}{4\left(\frac{\pi}{4}\right)(0.25)^2} = 1681 \text{ psi} = 1.68 \text{ ksi} \quad \text{Ans}$$

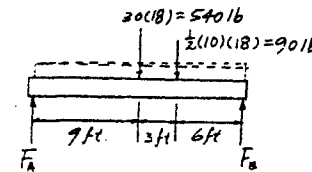

From *Mechanics of Materials*, Sixth Edition by R. C. Hibbeler, ISBN 0-13-191345-X.

© 2005 R. C. Hibbeler. Published by Pearson Prentice Hall,

Pearson Education, Inc., Upper Saddle River, NJ. All rights reserved.

This material is protected under all copyright laws as they currently exist. No portion of this material may be reproduced, in any form or by any means, without permission in writing from the publisher.

***1-100.** The hangers support the joists uniformly, so that it is assumed the four nails on each hanger carry an equal portion of the load. Determine the smallest diameter of the nails at A and at B if the allowable shear stress for the nails is $\tau_{\text{allow}} = 4$ ksi. The hangers only support vertical loads.

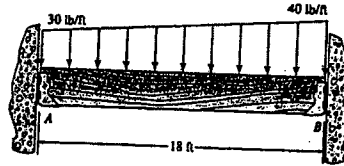

$$\left(+ \sum M_A = 0; \quad F_B(18) - 540(9) - 90(18) = 0; \quad F_B = 330 \text{ lb} \right.$$

$$\left. + \uparrow \sum F_y = 0; \quad F_A + 330 - 540 - 90 = 0; \quad F_A = 300 \text{ lb} \right.$$

For nails at A ,

$$\tau_{\text{allow}} = \frac{F_A}{A_A}; \quad 4(10^3) = \frac{300}{4\left(\frac{\pi}{4}\right)d_A^2}$$

$$d_A = 0.155 \text{ in.} \quad \text{Ans}$$

For nails at B ,

$$\tau_{\text{allow}} = \frac{F_B}{A_B}; \quad 4(10^3) = \frac{330}{4\left(\frac{\pi}{4}\right)d_B^2}$$

$$d_B = 0.162 \text{ in.} \quad \text{Ans}$$

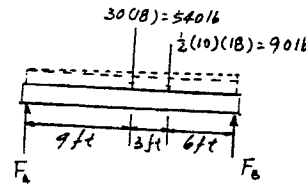

From *Mechanics of Materials*, Sixth Edition by R. C. Hibbeler, ISBN 0-13-191345-X.

© 2005 R. C. Hibbeler. Published by Pearson Prentice Hall,

Pearson Education, Inc., Upper Saddle River, NJ. All rights reserved.

This material is protected under all copyright laws as they currently exist. No portion of this material may be reproduced, in any form or by any means, without permission in writing from the publisher.

1-101. The hanger assembly is used to support a distributed loading of $w = 0.8$ kip/ft. Determine the average shear stress in the 0.40-in.-diameter bolt at A and the average tensile stress in rod AB , which has a diameter of 0.5 in. If the yield shear stress for the bolt is $\tau_y = 25$ ksi, and the yield tensile stress for the rod is $\sigma_y = 38$ ksi, determine the factor of safety with respect to yielding in each case.

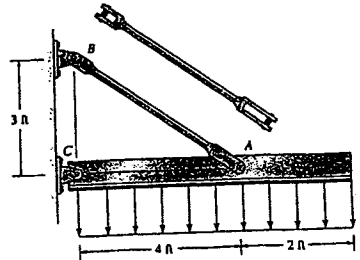

For bolt A :

$$\tau = \frac{V}{A} = \frac{3}{\frac{\pi}{4}(0.4^2)} = 23.9 \text{ ksi} \quad \text{Ans}$$

$$\text{F. S.} = \frac{\tau_y}{\tau} = \frac{25}{23.9} = 1.05 \quad \text{Ans}$$

For rod AB :

$$\sigma = \frac{P}{A} = \frac{6}{\frac{\pi}{4}(0.5^2)} = 30.6 \text{ ksi} \quad \text{Ans}$$

$$\text{F. S.} = \frac{\sigma_y}{\sigma} = \frac{38}{30.6} = 1.24 \quad \text{Ans}$$

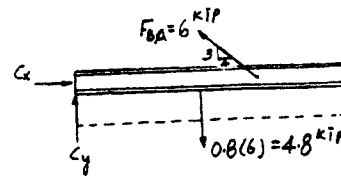

From *Mechanics of Materials*, Sixth Edition by R. C. Hibbeler, ISBN 0-13-191345-X.

© 2005 R. C. Hibbeler. Published by Pearson Prentice Hall,

Pearson Education, Inc., Upper Saddle River, NJ. All rights reserved.

This material is protected under all copyright laws as they currently exist. No portion of this material may be reproduced, in any form or by any means, without permission in writing from the publisher.

1-102 Determine the intensity w of the maximum distributed load that can be supported by the hanger assembly so that an allowable shear stress of $\tau_{\text{allow}} = 13.5$ ksi is not exceeded in the 0.40-in.-diameter bolts at A and B , and an allowable tensile stress of $\sigma_{\text{allow}} = 22$ ksi is not exceeded in the 0.5-in.-diameter rod AB .

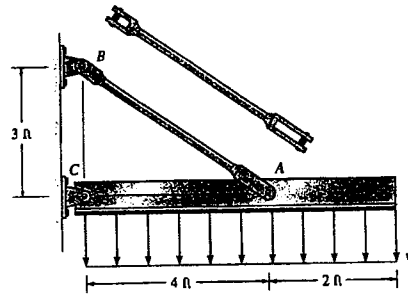

Assume failure of pin A or B :

$$\tau_{\text{allow}} = 13.5 = \frac{3.75w}{\frac{\pi}{4}(0.4^2)}$$

$$w = 0.452 \text{ kip/ft (controls) } \quad \text{Ans}$$

Assuming failure of rod AB :

$$\sigma_{\text{allow}} = 22 = \frac{7.5w}{\frac{\pi}{4}(0.5^2)}$$

$$w = 0.576 \text{ kip/ft}$$

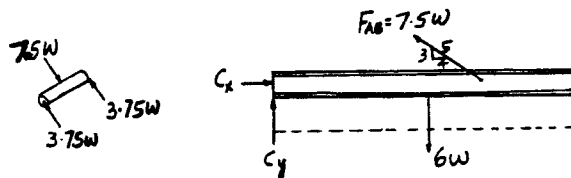

From *Mechanics of Materials*, Sixth Edition by R. C. Hibbeler, ISBN 0-13-191345-X.

© 2005 R. C. Hibbeler. Published by Pearson Prentice Hall,

Pearson Education, Inc., Upper Saddle River, NJ. All rights reserved.

This material is protected under all copyright laws as they currently exist. No portion of this material may be reproduced, in any form or by any means, without permission in writing from the publisher.

1-103. The assembly is used to support the distributed loading of $w = 500 \text{ lb/ft}$. Determine the factor of safety with respect to yielding for the steel rod BC and the pins at B and C if the yield stress for the steel in tension is $\sigma_y = 36 \text{ ksi}$ and in shear $\tau_y = 18 \text{ ksi}$. The rod has a diameter of 0.4 in. , and the pins each have a diameter of 0.30 in.

For rod BC :

$$\sigma = \frac{P}{A} = \frac{1.667}{\frac{\pi}{4}(0.4^2)} = 13.26 \text{ ksi}$$

$$\text{F. S.} = \frac{\sigma_y}{\sigma} = \frac{36}{13.26} = 2.71 \quad \text{Ans}$$

For pins B and C :

$$\tau = \frac{V}{A} = \frac{0.8333}{\frac{\pi}{4}(0.3^2)} = 11.79 \text{ ksi}$$

$$\text{F. S.} = \frac{\tau_y}{\tau} = \frac{18}{11.79} = 1.53 \quad \text{Ans}$$

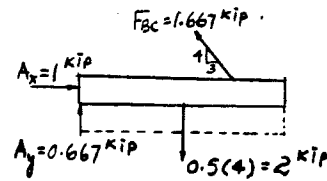
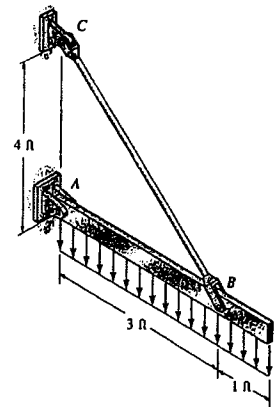

From *Mechanics of Materials*, Sixth Edition by R. C. Hibbeler, ISBN 0-13-191345-X.
 © 2005 R. C. Hibbeler. Published by Pearson Prentice Hall,
 Pearson Education, Inc., Upper Saddle River, NJ. All rights reserved.
 This material is protected under all copyright laws as they currently exist. No portion of this material may be reproduced, in any form or by any means, without permission in writing from the publisher.

*1-104 If the allowable shear stress for each of the 0.3-in.-diameter steel pins at A , B , and C is $\tau_{\text{allow}} = 12.5$ ksi, and the allowable normal stress for the 0.40-in.-diameter rod is $\sigma_{\text{allow}} = 22$ ksi, determine the largest intensity w of the uniform distributed load that can be suspended from the beam.

Assume failure of pins B and C :

$$\tau_{\text{allow}} = 12.5 = \frac{1.667w}{\frac{\pi}{4}(0.3^2)}$$

$$w = 0.530 \text{ kip/ft} \quad (\text{controls}) \quad \text{Ans}$$

Assume failure of pin A :

$$F_A = \sqrt{(2w)^2 + (1.333w)^2} = 2.404w$$

$$\tau_{\text{allow}} = 12.5 = \frac{1.202w}{\frac{\pi}{4}(0.3^2)}$$

$$w = 0.735 \text{ kip/ft}$$

Assume failure of rod BC :

$$\sigma_{\text{allow}} = 22 = \frac{3.333w}{\frac{\pi}{4}(0.4^2)}$$

$$w = 0.829 \text{ kip/ft}$$

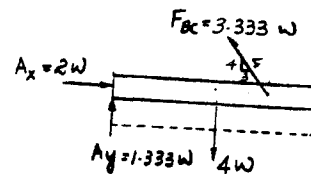
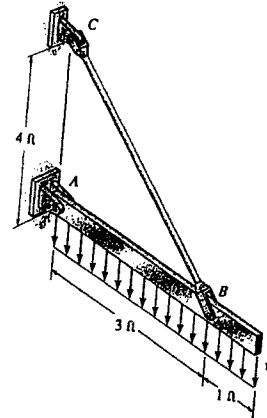
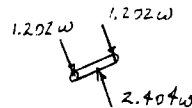

From *Mechanics of Materials*, Sixth Edition by R. C. Hibbeler, ISBN 0-13-191345-X.

© 2005 R. C. Hibbeler. Published by Pearson Prentice Hall,

Pearson Education, Inc., Upper Saddle River, NJ. All rights reserved.

This material is protected under all copyright laws as they currently exist. No portion of this material may be reproduced, in any form or by any means, without permission in writing from the publisher.

1-105. The compound wooden beam is connected together by a bolt at B . Assuming that the connections at A , B , C , and D exert only vertical forces on the beam, determine the required diameter of the bolt at B and the required outer diameter of its washers if the allowable tensile stress for the bolt is $(\sigma_t)_{\text{allow}} = 150 \text{ MPa}$ and the allowable bearing stress for the wood is $(\sigma_b)_{\text{allow}} = 28 \text{ MPa}$. Assume that the hole in the washers has the same diameter as the bolt.

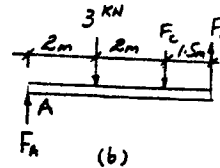
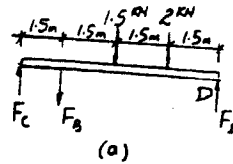
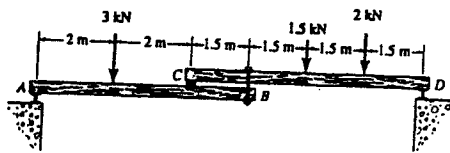

From FBD (a) :

$$\begin{aligned} (+ \Sigma M_D = 0; \quad F_B(4.5) + 1.5(3) + 2(1.5) - F_C(6) = 0 \\ 4.5 F_B - 6 F_C = -7.5 \end{aligned} \quad (1)$$

From FBD (b) :

$$\begin{aligned} (+ \Sigma M_A = 0; \quad F_B(5.5) - F_C(4) - 3(2) = 0 \\ 5.5 F_B - 4 F_C = 6 \end{aligned} \quad (2)$$

Solving Eqs. (1) and (2) yields

$$F_B = 4.40 \text{ kN}; \quad F_C = 4.55 \text{ kN}$$

For bolt :

$$\sigma_{\text{allow}} = 150 (10^6) = \frac{4.40(10^3)}{\frac{\pi}{4}(d_B)^2}$$

$$d_B = 0.00611 \text{ m}$$

$$= 6.11 \text{ mm} \quad \text{Ans}$$

For washer :

$$\sigma_{\text{allow}} = 28 (10^6) = \frac{4.40(10^3)}{\frac{\pi}{4}(d_w^2 - 0.00611^2)}$$

$$d_w = 0.0154 \text{ m} = 15.4 \text{ mm} \quad \text{Ans}$$



From *Mechanics of Materials*, Sixth Edition by R. C. Hibbeler, ISBN 0-13-191345-X.

© 2005 R. C. Hibbeler. Published by Pearson Prentice Hall,

Pearson Education, Inc., Upper Saddle River, NJ. All rights reserved.

This material is protected under all copyright laws as they currently exist. No portion of this material may be reproduced, in any form or by any means, without permission in writing from the publisher.

1-106 The bar is held in equilibrium by the pin supports at *A* and *B*. Note that the support at *A* has a single leaf and therefore it involves single shear in the pin, and the support at *B* has a double leaf and therefore it involves double shear. The allowable shear stress for both pins is $\tau_{allow} = 150 \text{ MPa}$. If a uniform distributed load of $w = 8 \text{ kN/m}$ is placed on the bar, determine its minimum allowable position x from *B*. Pins *A* and *B* each have a diameter of 8 mm. Neglect any axial force in the bar.

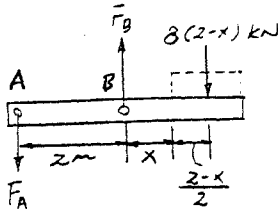
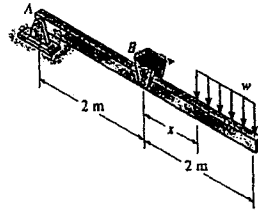

$$\begin{aligned} \left(\sum M_A = 0; \quad F_B(2) - 8(2-x)\left(3 + \frac{x}{2}\right) = 0 \right. \\ \left. 2F_B - 48 + 16x + 4x^2 = 0 \right) \quad (1) \end{aligned}$$

$$\begin{aligned} \left(\sum M_B = 0; \quad F_A(2) - 8(2-x)\left(\frac{x}{2} + 1\right) = 0 \right. \\ \left. 2F_A - 16 + 4x^2 = 0 \right) \quad (2) \end{aligned}$$

Assume failure of pin *A*

$$\tau_{allow} = \frac{F_A}{A_A}; \quad 150(10^6) = \frac{F_A}{\frac{\pi}{4}(0.008)^2}$$

$$F_A = 7539.8 \text{ N} = 7.5398 \text{ kN}$$

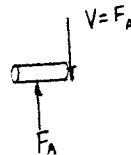

Substitute $F_A = 7.5398 \text{ kN}$ into Eq. (2), $x = 0.480 \text{ m}$

Assume failure of pin *B*

$$\tau_{allow} = \frac{F_B}{A_B}; \quad 150(10^6) = \frac{F_B}{\frac{\pi}{4}(0.008)^2}$$

$$F_B = 15079.6 \text{ N} = 15.0796 \text{ kN}$$

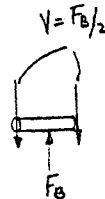

Substitute $F_B = 15.0796 \text{ kN}$ into Eq. (1), $x = 0.909 \text{ m}$

Choose the larger $x = 0.909 \text{ m}$ **Ans**

From *Mechanics of Materials*, Sixth Edition by R. C. Hibbeler, ISBN 0-13-191345-X.

© 2005 R. C. Hibbeler. Published by Pearson Prentice Hall,

Pearson Education, Inc., Upper Saddle River, NJ. All rights reserved.

This material is protected under all copyright laws as they currently exist. No portion of this material may be reproduced, in any form or by any means, without permission in writing from the publisher.

1-107 The bar is held in equilibrium by the pin supports at *A* and *B*. Note that the support at *A* has a single leaf and therefore it involves single shear in the pin, and the support at *B* has a double leaf and therefore it involves double shear. The allowable shear stress for both pins is $\tau_{\text{allow}} = 125 \text{ MPa}$. If $x = 1 \text{ m}$, determine the maximum distributed load w the bar will support. Pins *A* and *B* each have a diameter of 8 mm. Neglect any axial force in the bar.

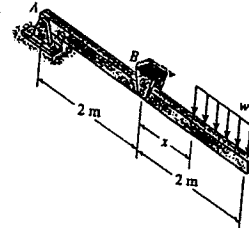

$$\curvearrowleft + \Sigma M_A = 0; \quad F_B(2) - w(3.5) = 0; \quad F_B = 1.75w$$

$$+ \uparrow \Sigma F_y = 0; \quad 1.75w - w - F_A = 0; \quad F_A = 0.75w$$

For pin *A*,

$$\tau_{\text{allow}} = \frac{F_A}{A_A}; \quad 125(10^6) = \frac{0.75w}{\frac{\pi}{4}(0.008)^2}$$

$$w = 8377 \text{ N/m} = 8.38 \text{ kN/m}$$

For pin *B*,

$$\tau_{\text{allow}} = \frac{F_B}{2}; \quad 125(10^6) = \frac{1.75w}{2}$$

$$w = 7181 \text{ N/m} = 7.18 \text{ kN/m} \quad (\text{controls})$$

Ans

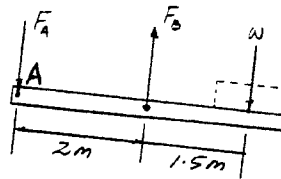

From *Mechanics of Materials*, Sixth Edition by R. C. Hibbeler, ISBN 0-13-191345-X.

© 2005 R. C. Hibbeler. Published by Pearson Prentice Hall,

Pearson Education, Inc., Upper Saddle River, NJ. All rights reserved.

This material is protected under all copyright laws as they currently exist. No portion of this material may be reproduced, in any form or by any means, without permission in writing from the publisher.

*1-108 The bar is held in equilibrium by the pin supports at A and B . Note that the support at A has a single leaf and therefore it involves single shear in the pin, and the support at B has a double leaf and therefore it involves double shear. The allowable shear stress for both pins is $\tau_{\text{allow}} = 125 \text{ MPa}$. If $x = 1 \text{ m}$ and $w = 12 \text{ kN/m}$, determine the smallest required diameter of pins A and B . Neglect any axial force in the bar.

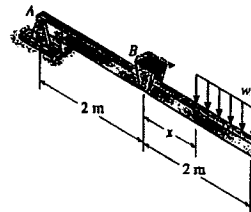

$$\left(+ \sum M_A = 0; \quad F_B(2) - 12(3.5) = 0; \quad F_B = 21 \text{ kN} \right.$$

$$\left. + \uparrow \sum F_y = 0; \quad 21 - 12 - F_A = 0; \quad F_A = 9 \text{ kN} \right.$$

For pin A ,

$$\tau_{\text{allow}} = \frac{F_A}{A_A}; \quad 125(10^6) = \frac{9(10^3)}{\frac{\pi}{4}(d_A)^2}$$

$$d_A = 0.00957 \text{ m} = 9.57 \text{ mm} \quad \text{Ans}$$

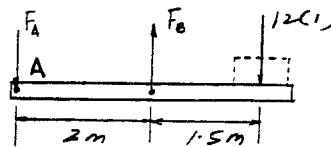

For pin B ,

$$\tau_{\text{allow}} = \frac{F_B}{2}; \quad 125(10^6) = \frac{21(10^3)}{\frac{\pi}{4}(d_B)^2}$$

$$d_B = 0.0103 \text{ m} = 10.3 \text{ mm} \quad \text{Ans}$$

From *Mechanics of Materials*, Sixth Edition by R. C. Hibbeler, ISBN 0-13-191345-X.

© 2005 R. C. Hibbeler. Published by Pearson Prentice Hall,

Pearson Education, Inc., Upper Saddle River, NJ. All rights reserved.

This material is protected under all copyright laws as they currently exist. No portion of this material may be reproduced, in any form or by any means, without permission in writing from the publisher.

1-109 The pin is subjected to double shear since it is used to connect the three links together. Due to wear, the load is distributed over the top and bottom of the pin as shown on the free-body diagram. Determine the diameter d of the pin if the allowable shear stress is $\tau_{\text{allow}} = 10$ ksi and the load $P = 8$ kip. Also, determine the load intensities w_1 and w_2 .

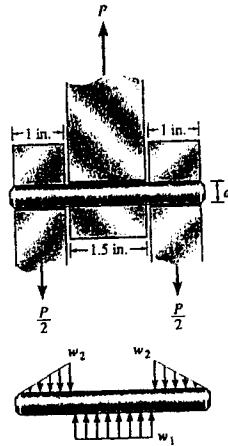
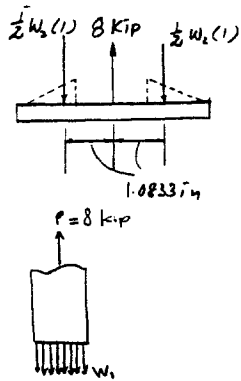

Pin :

$$+\uparrow \Sigma F_y = 0; \quad 8 - 1.5 w_1 = 0$$

$$w_1 = 5.33 \text{ kip / in.} \quad \text{Ans}$$

Link :

$$+\uparrow \Sigma F_y = 0; \quad -2\left(\frac{1}{2}w_2\right)(1) + 8 = 0$$

$$w_2 = 8 \text{ kip / in.} \quad \text{Ans}$$

Shear stress

$$\tau_{\text{allow}} = \frac{P}{\frac{\pi}{4}(d)^2}; \quad 10 = \frac{8}{\frac{\pi}{4}(d)^2}$$

$$d = 0.714 \text{ in.} \quad \text{Ans}$$

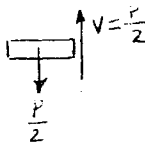

From *Mechanics of Materials*, Sixth Edition by R. C. Hibbeler, ISBN 0-13-191345-X.

© 2005 R. C. Hibbeler. Published by Pearson Prentice Hall,

Pearson Education, Inc., Upper Saddle River, NJ. All rights reserved.

This material is protected under all copyright laws as they currently exist. No portion of this material may be reproduced, in any form or by any means, without permission in writing from the publisher.

1-110. The pin is subjected to double shear since it is used to connect the three links together. Due to wear, the load is distributed over the top and bottom of the pin as shown on the free-body diagram. Determine the maximum load P the connection can support if the allowable shear stress for the material is $\tau_{\text{allow}} = 8 \text{ ksi}$ and the diameter of the pin is 0.5 in. Also, determine the load intensities w_1 and w_2 .

$$\tau_{\text{allow}} = \frac{P}{A}$$

$$V = \frac{P}{2}$$

$$8 (10^3) = \frac{\frac{P}{2}}{\frac{\pi}{4}(0.5)^2}$$

$$P = 3.1416 = 3.14 \text{ kip}$$

$$3.1416 \text{ kip} = w_1 (1.5)$$

$$w_1 = 2.09 \text{ kip/in.}$$

$$\frac{3.1416}{2} = \frac{1}{2} w_2 (1)$$

$$w_2 = 3.14 \text{ kip/in.}$$

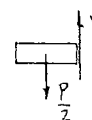
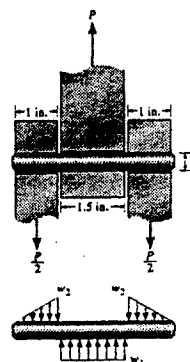

Ans

Ans

Ans

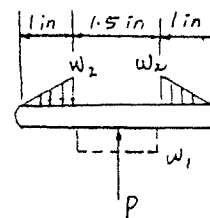

From *Mechanics of Materials*, Sixth Edition by R. C. Hibbeler, ISBN 0-13-191345-X.

© 2005 R. C. Hibbeler. Published by Pearson Prentice Hall,

Pearson Education, Inc., Upper Saddle River, NJ. All rights reserved.

This material is protected under all copyright laws as they currently exist. No portion of this material may be reproduced, in any form or by any means, without permission in writing from the publisher.

1-111. The thrust bearing consists of a circular collar *A* fixed to the shaft *B*. Determine the maximum axial force *P* that can be applied to the shaft so that it does not cause the shear stress along a cylindrical surface *a* or *b* to exceed an allowable shear stress of $\tau_{\text{allow}} = 170 \text{ MPa}$.

Assume failure along *a* :

$$\tau_{\text{allow}} = 170(10^6) = \frac{P}{\pi(0.03)(0.035)}$$

$$P = 561 \text{ kN (controls) \quad Ans}$$

Assume failure along *b* :

$$\tau_{\text{allow}} = 170(10^6) = \frac{P}{\pi(0.058)(0.02)}$$

$$P = 620 \text{ kN}$$

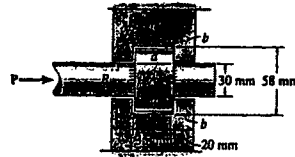

From *Mechanics of Materials*, Sixth Edition by R. C. Hibbeler, ISBN 0-13-191345-X.

© 2005 R. C. Hibbeler. Published by Pearson Prentice Hall,

Pearson Education, Inc., Upper Saddle River, NJ. All rights reserved.

This material is protected under all copyright laws as they currently exist. No portion of this material may be reproduced, in any form or by any means, without permission in writing from the publisher.

*1-112 The long bolt passes through the 30-mm-thick plate. If the force in the bolt shank is 8 kN, determine the average normal stress in the shank, the average shear stress along the cylindrical area of the plate defined by the section lines $a - a$, and the average shear stress in the bolt head along the cylindrical area defined by the section lines $b - b$.

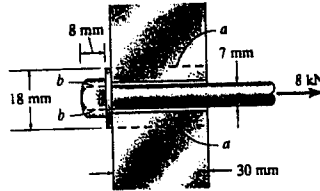

$$\sigma_x = \frac{P}{A} = \frac{8 (10^3)}{\frac{\pi}{4} (0.007)^2} = 208 \text{ MPa} \quad \text{Ans}$$

$$(\tau_{avg})_a = \frac{V}{A} = \frac{8 (10^3)}{\pi (0.018)(0.030)} = 4.72 \text{ MPa} \quad \text{Ans}$$

$$(\tau_{avg})_b = \frac{V}{A} = \frac{8 (10^3)}{\pi (0.007)(0.008)} = 45.5 \text{ MPa} \quad \text{Ans}$$

From *Mechanics of Materials*, Sixth Edition by R. C. Hibbeler, ISBN 0-13-191345-X.

© 2005 R. C. Hibbeler. Published by Pearson Prentice Hall,

Pearson Education, Inc., Upper Saddle River, NJ. All rights reserved.

This material is protected under all copyright laws as they currently exist. No portion of this material may be reproduced, in any form or by any means, without permission in writing from the publisher.

1-113 The two-member frame is subjected to the loading shown. Determine the average normal stress and the average shear stress acting at sections *a-a* and *b-b*. Member *CB* has a square cross section of 2 in. on each side.

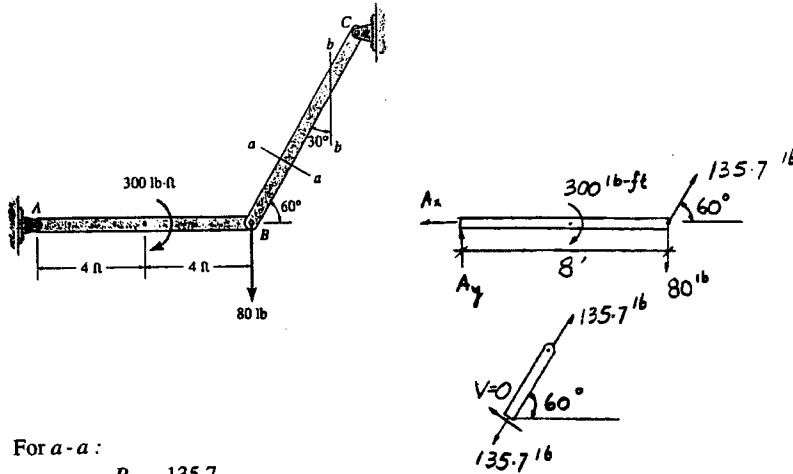

For *a-a* :

$$\sigma_{a-a} = \frac{P}{A} = \frac{135.7}{2(2)} = 33.9 \text{ psi} \quad \text{Ans}$$

$$\tau_{a-a} = 0 \quad \text{Ans}$$

For *b-b* :

$$\leftarrow \Sigma F_x = 0 \quad N - 135.7 \sin 30^\circ = 0$$

$$N = 67.84 \text{ lb}$$

$$+\downarrow \Sigma F_y = 0 \quad V - 135.7 \cos 30^\circ = 0$$

$$V = 117.5 \text{ lb}$$

$$\sigma_{b-b} = \frac{67.84}{2\left(\frac{2}{\sin 30^\circ}\right)} = 8.48 \text{ psi} \quad \text{Ans}$$

$$\tau_{b-b} = \frac{117.5}{2\left(\frac{2}{\sin 30^\circ}\right)} = 14.7 \text{ psi} \quad \text{Ans}$$

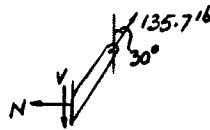

From *Mechanics of Materials*, Sixth Edition by R. C. Hibbeler, ISBN 0-13-191345-X.

© 2005 R. C. Hibbeler. Published by Pearson Prentice Hall,

Pearson Education, Inc., Upper Saddle River, NJ. All rights reserved.

This material is protected under all copyright laws as they currently exist. No portion of this material may be reproduced, in any form or by any means, without permission in writing from the publisher.

1-114 Determine the resultant internal loadings acting on the cross sections located through points *D* and *E* of the frame.

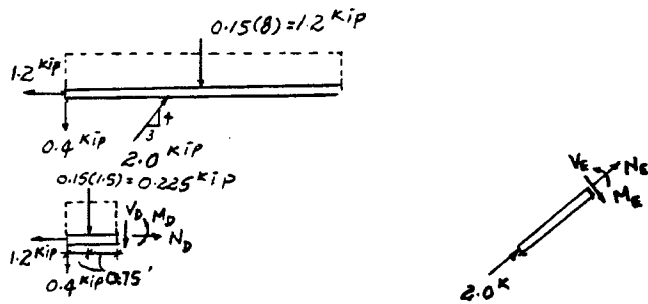
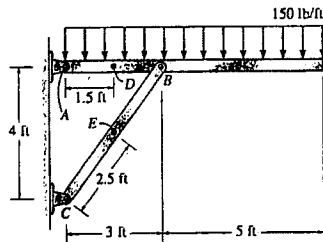

Segment *AD* :

$$\rightarrow \Sigma F_x = 0; \quad N_D - 1.2 = 0; \quad N_D = 1.20 \text{ kip} \quad \text{Ans}$$

$$+\downarrow \Sigma F_y = 0; \quad V_D + 0.225 + 0.4 = 0; \quad V_D = -0.625 \text{ kip} \quad \text{Ans}$$

$$\curvearrowright \Sigma M_D = 0; \quad M_D + 0.225(0.75) + 0.4(1.5) = 0$$

$$M_D = -0.769 \text{ kip} \cdot \text{ft} \quad \text{Ans}$$

Segment *CE* :

$$\nearrow \Sigma F_x = 0; \quad N_E + 2.0 = 0; \quad N_E = -2.00 \text{ kip} \quad \text{Ans}$$

$$\searrow \Sigma F_y = 0; \quad V_E = 0 \quad \text{Ans}$$

$$\curvearrowright \Sigma M_E = 0; \quad M_E = 0 \quad \text{Ans}$$

From *Mechanics of Materials*, Sixth Edition by R. C. Hibbeler, ISBN 0-13-191345-X.

© 2005 R. C. Hibbeler. Published by Pearson Prentice Hall,

Pearson Education, Inc., Upper Saddle River, NJ. All rights reserved.

This material is protected under all copyright laws as they currently exist. No portion of this material may be reproduced, in any form or by any means, without permission in writing from the publisher.

1-115 The rod BC is made of steel having an allowable tensile stress of $\sigma_{\text{allow}} = 155 \text{ MPa}$. Determine its smallest diameter so that it can support the load shown. The beam is assumed to be pin-connected at A .

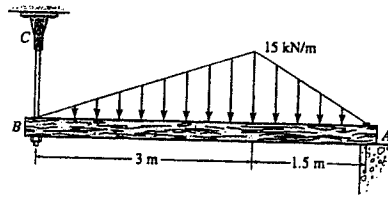

$$\sigma_{\text{allow}} = 155 (10^6) = \frac{15 (10^3)}{\frac{\pi}{4}(d_{BC})^2}$$

$$d_{BC} = 0.0111 \text{ m} = 11.1 \text{ mm} \quad \text{Ans}$$

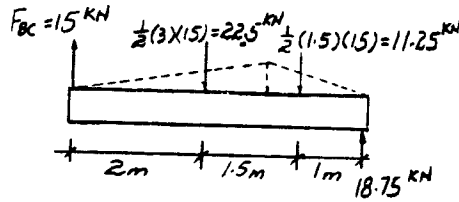

From *Mechanics of Materials*, Sixth Edition by R. C. Hibbeler, ISBN 0-13-191345-X.

© 2005 R. C. Hibbeler. Published by Pearson Prentice Hall,

Pearson Education, Inc., Upper Saddle River, NJ. All rights reserved.

This material is protected under all copyright laws as they currently exist. No portion of this material may be reproduced, in any form or by any means, without permission in writing from the publisher.

*1-116 The column has a cross-sectional area of $12(10^3)$ mm². It is subjected to an axial force of 50 kN. If the base plate to which the column is attached has a length of 250 mm, determine its width d so that the average bearing stress under the plate at the ground is one-third of the average compressive stress in the column. Sketch the stress distributions acting over the column's cross-sectional area and at the bottom of the base plate.

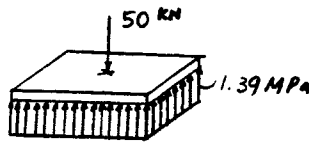
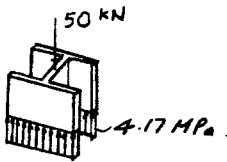
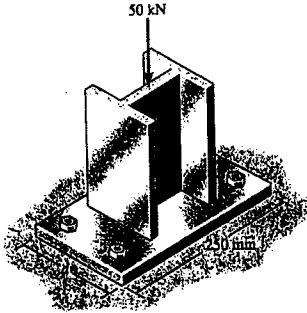

$$\sigma_c = \frac{P}{A} = \frac{50 (10^3)}{\frac{12 (10^3)}{(1000)^2}} = 4.167 \text{ MPa}$$

$$\frac{1}{3} \sigma_c = \sigma_b$$

$$\frac{4.167 (10^6)}{3} = \frac{50 (10^3)}{(0.25) d}$$

$$d = 0.144 \text{ m} = 144 \text{ mm} \quad \text{Ans}$$

$$\sigma_b = \frac{1}{3} (4.167) = 1.39 \text{ MPa}$$

From *Mechanics of Materials*, Sixth Edition by R. C. Hibbeler, ISBN 0-13-191345-X.

© 2005 R. C. Hibbeler. Published by Pearson Prentice Hall,

Pearson Education, Inc., Upper Saddle River, NJ. All rights reserved.

This material is protected under all copyright laws as they currently exist. No portion of this material may be reproduced, in any form or by any means, without permission in writing from the publisher.

1-117. The beam AB is pin supported at A and supported by a cable BC . A separate cable CG is used to hold up the frame. If AB weighs 120 lb/ft and the column FC has a weight of 180 lb/ft , determine the resultant internal loadings acting on cross sections located at points D and E . Neglect the thickness of both the beam and column in the calculation.

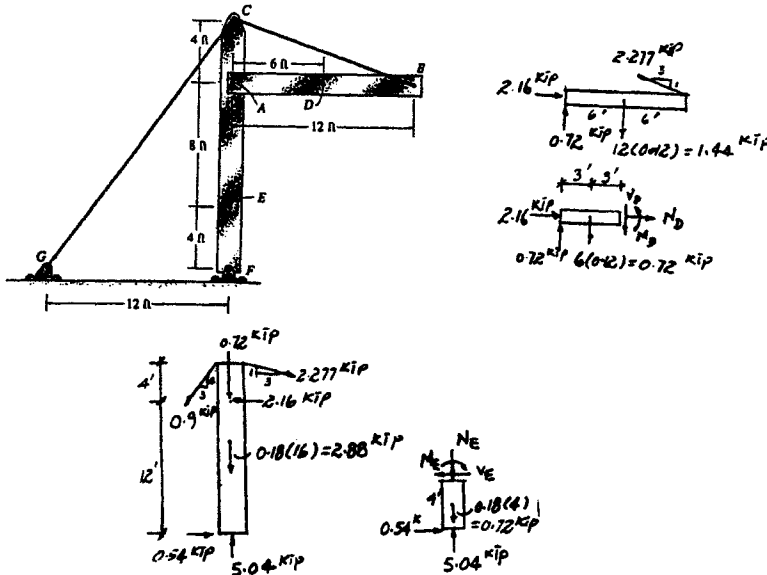

Segment BD :

$$\rightarrow \Sigma F_x = 0; \quad N_D + 2.16 = 0; \quad N_D = -2.16 \text{ kip} \quad \text{Ans}$$

$$+\downarrow \Sigma F_y = 0; \quad V_D + 0.72 - 0.72 = 0; \quad V_D = 0 \quad \text{Ans}$$

$$\curvearrowright + \Sigma M_D = 0; \quad M_D - 0.72(3) = 0; \quad M_D = 2.16 \text{ kip} \cdot \text{ft} \quad \text{Ans}$$

Segment FE :

$$\leftarrow \Sigma F_x = 0; \quad V_E - 0.54 = 0; \quad V_E = 0.540 \text{ kip} \quad \text{Ans}$$

$$+\downarrow \Sigma F_y = 0; \quad N_E + 0.72 - 5.04 = 0; \quad N_E = 4.32 \text{ kip} \quad \text{Ans}$$

$$\curvearrowleft + \Sigma M_E = 0; \quad -M_E + 0.54(4) = 0; \quad M_E = 2.16 \text{ kip} \cdot \text{ft} \quad \text{Ans}$$

From *Mechanics of Materials*, Sixth Edition by R. C. Hibbeler, ISBN 0-13-191345-X.

© 2005 R. C. Hibbeler. Published by Pearson Prentice Hall,

Pearson Education, Inc., Upper Saddle River, NJ. All rights reserved.

This material is protected under all copyright laws as they currently exist. No portion of this material may be reproduced, in any form or by any means, without permission in writing from the publisher.

1-118. The pulley is held fixed to the 20-mm-diameter shaft using a key that fits within a groove cut into the pulley and shaft. If the suspended load has a mass of 50 kg, determine the average shear stress in the key along section $a-a$. The key is 5 mm by 5 mm square and 12 mm long.

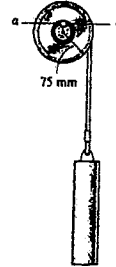
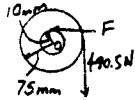

$$(+\Sigma M_O = 0; \quad F(10) - 490.5(75) = 0$$

$$F = 3678.75 \text{ N}$$

$$\tau_{avg} = \frac{V}{A} = \frac{3678.75}{(0.005)(0.012)} = 61.3 \text{ MPa} \quad \text{Ans}$$

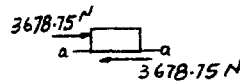

From *Mechanics of Materials*, Sixth Edition by R. C. Hibbeler, ISBN 0-13-191345-X.

© 2005 R. C. Hibbeler. Published by Pearson Prentice Hall,

Pearson Education, Inc., Upper Saddle River, NJ. All rights reserved.

This material is protected under all copyright laws as they currently exist. No portion of this material may be reproduced, in any form or by any means, without permission in writing from the publisher.

1-119 The yoke-and-rod connection is subjected to a tensile force of 5 kN. Determine the average normal stress in each rod and the average shear stress in the pin A between the members.

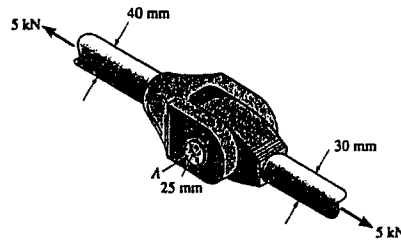

For the 40-mm-dia. rod :

$$\sigma_{40} = \frac{P}{A} = \frac{5 (10^3)}{\frac{\pi}{4} (0.04)^2} = 3.98 \text{ MPa} \quad \text{Ans}$$

For the 30-mm-dia. rod :

$$\sigma_{30} = \frac{V}{A} = \frac{5 (10^3)}{\frac{\pi}{4} (0.03)^2} = 7.07 \text{ MPa} \quad \text{Ans}$$



Average shear stress for pin A :

$$\tau_{avg} = \frac{P}{A} = \frac{2.5 (10^3)}{\frac{\pi}{4} (0.025)^2} = 5.09 \text{ MPa} \quad \text{Ans}$$

From *Mechanics of Materials*, Sixth Edition by R. C. Hibbeler, ISBN 0-13-191345-X.

© 2005 R. C. Hibbeler. Published by Pearson Prentice Hall,

Pearson Education, Inc., Upper Saddle River, NJ. All rights reserved.

This material is protected under all copyright laws as they currently exist. No portion of this material may be reproduced, in any form or by any means, without permission in writing from the publisher.

2-1 An air filled rubber ball has a diameter of 6 in. If the air pressure within it is increased until the ball's diameter becomes 7 in., determine the average normal strain in the rubber.

$$d_0 = 6 \text{ in.}$$

$$d = 7 \text{ in.}$$

$$\epsilon = \frac{\pi d - \pi d_0}{\pi d_0} = \frac{7 - 6}{6} = 0.167 \text{ in./in.} \quad \text{Ans}$$

From *Mechanics of Materials*, Sixth Edition by R. C. Hibbeler, ISBN 0-13-191345-X.

© 2005 R. C. Hibbeler. Published by Pearson Prentice Hall,

Pearson Education, Inc., Upper Saddle River, NJ. All rights reserved.

This material is protected under all copyright laws as they currently exist. No portion of this material may be reproduced, in any form or by any means, without permission in writing from the publisher.

2-2 A thin strip of rubber has an unstretched length of 15 in. If it is stretched around a pipe having an outer diameter of 5 in., determine the average normal strain in the strip.

$$L_0 = 15 \text{ in.}$$

$$L = \pi(5 \text{ in.})$$

$$\epsilon = \frac{L - L_0}{L_0} = \frac{5\pi - 15}{15} = 0.0472 \text{ in./in.} \quad \mathbf{Ans}$$

From *Mechanics of Materials*, Sixth Edition by R. C. Hibbeler, ISBN 0-13-191345-X.

© 2005 R. C. Hibbeler. Published by Pearson Prentice Hall,

Pearson Education, Inc., Upper Saddle River, NJ. All rights reserved.

This material is protected under all copyright laws as they currently exist. No portion of this material may be reproduced, in any form or by any means, without permission in writing from the publisher.

2-3 The rigid beam is supported by a pin at *A* and wires *BD* and *CE*. If the load *P* on the beam causes the end *C* to be displaced 10 mm downward, determine the normal strain developed in wires *CE* and *BD*.

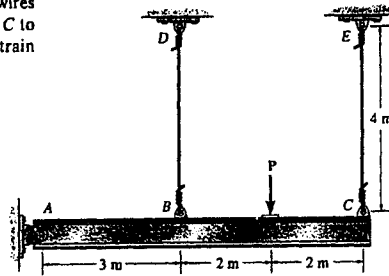

$$\frac{\Delta L_{BD}}{3} = \frac{\Delta L_{CE}}{7}$$

$$\Delta L_{BD} = \frac{3(10)}{7} = 4.286 \text{ mm}$$

$$\epsilon_{CE} = \frac{\Delta L_{CE}}{L} = \frac{10}{4000} = 0.00250 \text{ mm/mm} \quad \text{Ans}$$

$$\epsilon_{BD} = \frac{\Delta L_{BD}}{L} = \frac{4.286}{4000} = 0.00107 \text{ mm/mm} \quad \text{Ans}$$

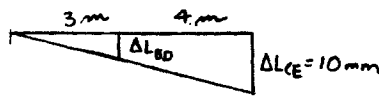

From *Mechanics of Materials*, Sixth Edition by R. C. Hibbeler, ISBN 0-13-191345-X.

© 2005 R. C. Hibbeler. Published by Pearson Prentice Hall,

Pearson Education, Inc., Upper Saddle River, NJ. All rights reserved.

This material is protected under all copyright laws as they currently exist. No portion of this material may be reproduced, in any form or by any means, without permission in writing from the publisher.

*2-4 Nylon strips are fused to glass plates. When moderately heated the nylon will become soft while the glass stays approximately rigid. Determine the average shear strain in the nylon due to the load P when the assembly deforms as indicated.

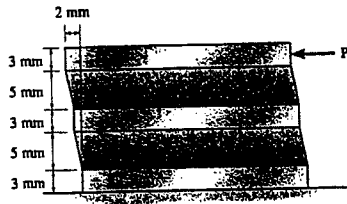

$$\gamma = \tan^{-1} \left(\frac{2}{10} \right) = 11.31^\circ = 0.197 \text{ rad} \quad \text{Ans}$$

From *Mechanics of Materials*, Sixth Edition by R. C. Hibbeler, ISBN 0-13-191345-X.

© 2005 R. C. Hibbeler. Published by Pearson Prentice Hall,

Pearson Education, Inc., Upper Saddle River, NJ. All rights reserved.

This material is protected under all copyright laws as they currently exist. No portion of this material may be reproduced, in any form or by any means, without permission in writing from the publisher.

2-5 The wire AB is unstretched when $\theta = 45^\circ$. If a load is applied to the bar AC , which causes $\theta = 47^\circ$, determine the normal strain in the wire.

$$L^2 = L^2 + L_{AB}^2 - 2LL_{AB} \cos 43^\circ$$

$$L_{AB} = 2L \cos 43^\circ$$

$$\begin{aligned} \epsilon_{AB} &= \frac{L'_{AB} - L_{AB}}{L_{AB}} \\ &= \frac{2L \cos 43^\circ - \sqrt{2}L}{\sqrt{2}L} \end{aligned}$$

$$= 0.0343 \quad \text{Ans}$$

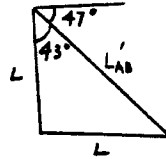
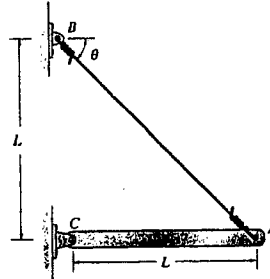

From *Mechanics of Materials*, Sixth Edition by R. C. Hibbeler, ISBN 0-13-191345-X.
 © 2005 R. C. Hibbeler. Published by Pearson Prentice Hall,
 Pearson Education, Inc., Upper Saddle River, NJ. All rights reserved.
 This material is protected under all copyright laws as they currently exist. No portion of this material may be reproduced, in any form or by any means, without permission in writing from the publisher.

2-6 If a load applied to bar AC causes point A to be displaced to the right by an amount ΔL , determine the normal strain in wire AB . Originally, $\theta = 45^\circ$.

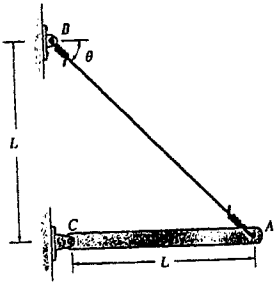

$$L'_{AB} = \sqrt{(\sqrt{2}L)^2 + \Delta L^2 - 2(\sqrt{2}L)(\Delta L) \cos 135^\circ}$$

$$= \sqrt{2L^2 + \Delta L^2 + 2L\Delta L}$$

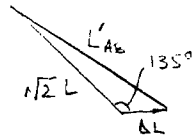

$$\epsilon_{AB} = \frac{L'_{AB} - L_{AB}}{L_{AB}}$$

$$= \frac{\sqrt{2L^2 + \Delta L^2 + 2L\Delta L} - \sqrt{2}L}{\sqrt{2}L}$$

$$= \sqrt{1 + \frac{\Delta L^2}{2L^2} + \frac{\Delta L}{L}} - 1$$

Neglecting the higher-order terms,

$$\epsilon_{AB} = \left(1 + \frac{\Delta L}{L}\right)^{\frac{1}{2}} - 1$$

$$= 1 + \frac{1}{2} \frac{\Delta L}{L} + \dots - 1 \quad (\text{binomial theorem})$$

$$= \frac{0.5\Delta L}{L} \quad \text{Ans}$$

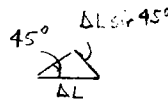

Also,

$$\epsilon_{AB} = \frac{\Delta L \sin 45^\circ}{\sqrt{2}L} = \frac{0.5 \Delta L}{L} \quad \text{Ans}$$

From *Mechanics of Materials*, Sixth Edition by R. C. Hibbeler, ISBN 0-13-191345-X.

© 2005 R. C. Hibbeler. Published by Pearson Prentice Hall,

Pearson Education, Inc., Upper Saddle River, NJ. All rights reserved.

This material is protected under all copyright laws as they currently exist. No portion of this material may be reproduced, in any form or by any means, without permission in writing from the publisher.

2-7 The two wires are connected together at A. If the force P causes point A to be displaced horizontally 2 mm, determine the normal strain developed in each wire.

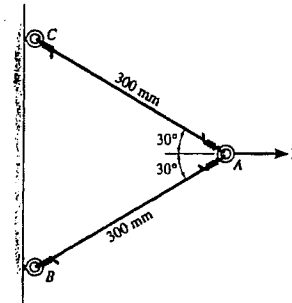
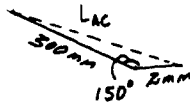

$$L'_{AC} = \sqrt{300^2 + 2^2 - 2(300)(2) \cos 150^\circ} = 301.734 \text{ mm}$$

$$\epsilon_{AC} = \epsilon_{AB} = \frac{L'_{AC} - L_{AC}}{L_{AC}} = \frac{301.734 - 300}{300} = 0.00578 \text{ mm/mm} \quad \text{Ans}$$

From *Mechanics of Materials*, Sixth Edition by R. C. Hibbeler, ISBN 0-13-191345-X.

© 2005 R. C. Hibbeler. Published by Pearson Prentice Hall,

Pearson Education, Inc., Upper Saddle River, NJ. All rights reserved.

This material is protected under all copyright laws as they currently exist. No portion of this material may be reproduced, in any form or by any means, without permission in writing from the publisher.

*2-8 Part of a control linkage for an airplane consists of a rigid member CBD and a flexible cable AB . If a force is applied to the end D of the member and causes it to rotate by $\theta = 0.3^\circ$, determine the normal strain in the cable. Originally the cable is unstretched.

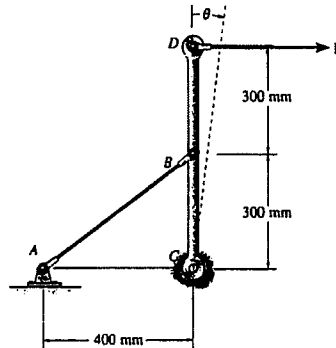

$$AB = \sqrt{400^2 + 300^2} = 500 \text{ mm}$$

$$AB' = \sqrt{400^2 + 300^2 - 2(400)(300) \cos 90.3^\circ}$$

$$= 501.255 \text{ mm}$$

$$\epsilon_{AB} = \frac{AB' - AB}{AB} = \frac{501.255 - 500}{500}$$

$$= 0.00251 \text{ mm/mm} \quad \text{Ans}$$

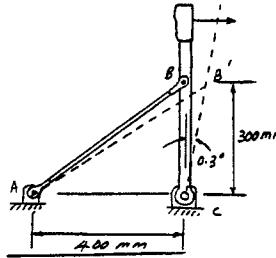

From *Mechanics of Materials*, Sixth Edition by R. C. Hibbeler, ISBN 0-13-191345-X.

© 2005 R. C. Hibbeler. Published by Pearson Prentice Hall,

Pearson Education, Inc., Upper Saddle River, NJ. All rights reserved.

This material is protected under all copyright laws as they currently exist. No portion of this material may be reproduced, in any form or by any means, without permission in writing from the publisher.

2-9 Part of a control linkage for an airplane consists of a rigid member CBD and a flexible cable AB . If a force is applied to the end D of the member and causes a normal strain in the cable of 0.0035 mm/mm, determine the displacement of point D . Originally the cable is unstretched.

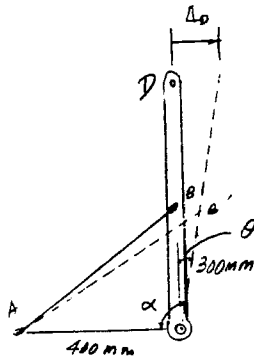
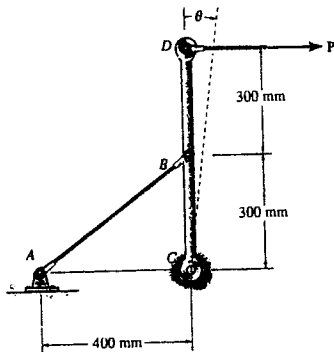

$$AB = \sqrt{300^2 + 400^2} = 500 \text{ mm}$$

$$\begin{aligned} AB' &= AB + \epsilon_{AB}AB \\ &= 500 + 0.0035(500) = 501.75 \text{ mm} \end{aligned}$$

$$501.75^2 = 300^2 + 400^2 - 2(300)(400) \cos \alpha$$

$$\alpha = 90.4185^\circ$$

$$\theta = 90.4185^\circ - 90^\circ = 0.4185^\circ = \frac{\pi}{180^\circ}(0.4185) \text{ rad}$$

$$\Delta_D = 600(\theta) = 600\left(\frac{\pi}{180^\circ}\right)(0.4185) = 4.38 \text{ mm} \quad \text{Ans}$$

From *Mechanics of Materials*, Sixth Edition by R. C. Hibbeler, ISBN 0-13-191345-X.

© 2005 R. C. Hibbeler. Published by Pearson Prentice Hall,

Pearson Education, Inc., Upper Saddle River, NJ. All rights reserved.

This material is protected under all copyright laws as they currently exist. No portion of this material may be reproduced, in any form or by any means, without permission in writing from the publisher.

2-10 The wire AB is unstretched when $\theta = 45^\circ$. If a vertical load is applied to bar AC , which causes $\theta = 47^\circ$, determine the normal strain in the wire.

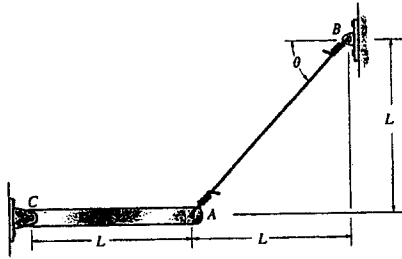

$$AB = \sqrt{L^2 + L^2} = \sqrt{2} L$$

$$CB = \sqrt{(2L)^2 + L^2} = \sqrt{5} L$$

From triangle ABC ,

$$\frac{\sin \alpha}{L} = \frac{\sin 135^\circ}{\sqrt{5} L}$$

$$\alpha = 18.435^\circ$$

$$\beta = 18.435^\circ + 2^\circ = 20.435^\circ$$

From triangle $A'BC$,

$$\frac{\sin \theta}{\sqrt{5} L} = \frac{\sin 20.435^\circ}{L}$$

$$\theta = 128.674^\circ$$

$$\phi = 180^\circ - 128.674^\circ - 20.435^\circ = 30.891^\circ$$

$$\frac{A'B}{\sin 30.891^\circ} = \frac{L}{\sin 20.435^\circ}$$

$$A'B = 1.47047L$$

$$\epsilon_{AB} = \frac{A'B - AB}{AB} = \frac{1.47047L - \sqrt{2} L}{\sqrt{2} L} = 0.0398 \quad \text{Ans}$$

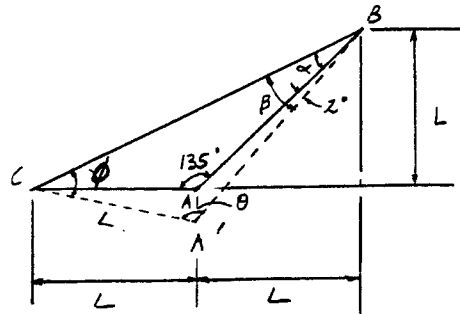
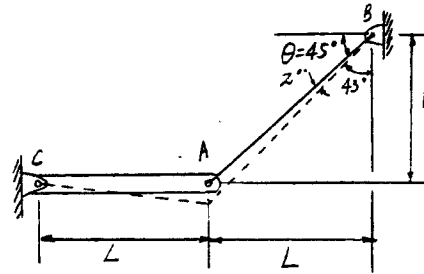

From *Mechanics of Materials*, Sixth Edition by R. C. Hibbeler, ISBN 0-13-191345-X.

© 2005 R. C. Hibbeler. Published by Pearson Prentice Hall,

Pearson Education, Inc., Upper Saddle River, NJ. All rights reserved.

This material is protected under all copyright laws as they currently exist. No portion of this material may be reproduced, in any form or by any means, without permission in writing from the publisher.

2-11 If a load applied to bar AC causes point A to be displaced to the left by an amount ΔL , determine the normal strain in wire AB. Originally, $\theta = 45^\circ$.

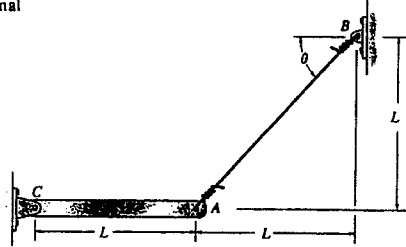

$$AB = \sqrt{L^2 + L^2} = \sqrt{2} L$$

From triangle $A'AB$,

$$A'B = \sqrt{\Delta L^2 + (\sqrt{2}L)^2 - 2(\Delta L)\sqrt{2}L \cos 135^\circ}$$

$$= \sqrt{\Delta L^2 + 2L^2 + 2L \Delta L}$$

$$\epsilon_{AB} = \frac{A'B - AB}{AB}$$

$$= \frac{\sqrt{\Delta L^2 + 2L^2 + 2L \Delta L} - \sqrt{2}L}{\sqrt{2}L}$$

$$= \sqrt{\frac{\Delta L^2}{2L^2} + 1 + \frac{\Delta L}{L}} - 1$$

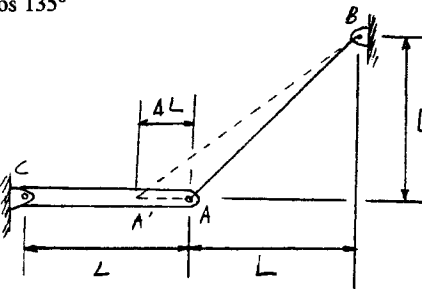

Neglecting the higher order terms,

$$\epsilon_{AB} = \left(1 + \frac{\Delta L}{L}\right)^{\frac{1}{2}} - 1$$

$$= 1 + \frac{1}{2} \frac{\Delta L}{L} + \dots - 1 \quad (\text{Binomial theorem})$$

$$= \frac{0.5 \Delta L}{L}$$

Ans

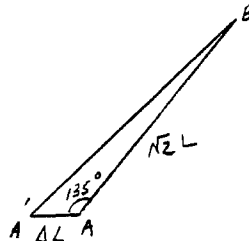

Also,

$$\epsilon_{AB} = \frac{\Delta L \sin 45^\circ}{\sqrt{2}L}$$

$$= \frac{0.5 \Delta L}{L}$$

Ans

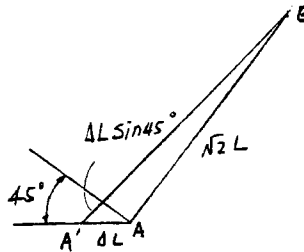

From *Mechanics of Materials*, Sixth Edition by R. C. Hibbeler, ISBN 0-13-191345-X.

© 2005 R. C. Hibbeler. Published by Pearson Prentice Hall,

Pearson Education, Inc., Upper Saddle River, NJ. All rights reserved.

This material is protected under all copyright laws as they currently exist. No portion of this material may be reproduced, in any form or by any means, without permission in writing from the publisher.

*2-12 The triangular plate is fixed at its base, and its apex A is given a horizontal displacement of 5 mm. Determine the shear strain γ_{xy} at A .

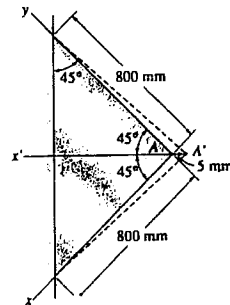

$$L = \sqrt{800^2 + 5^2 - 2(800)(5) \cos 135^\circ} = 803.54 \text{ mm}$$

$$\frac{\sin 135^\circ}{803.54} = \frac{\sin \theta}{800}; \quad \theta = 44.75^\circ = 0.7810 \text{ rad}$$

$$\begin{aligned} \gamma_{xy} &= \frac{\pi}{2} - 2\theta = \frac{\pi}{2} - 2(0.7810) \\ &= 0.00880 \text{ rad} \quad \text{Ans} \end{aligned}$$

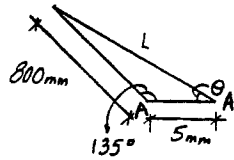

From *Mechanics of Materials*, Sixth Edition by R. C. Hibbeler, ISBN 0-13-191345-X.
 © 2005 R. C. Hibbeler. Published by Pearson Prentice Hall,
 Pearson Education, Inc., Upper Saddle River, NJ. All rights reserved.
 This material is protected under all copyright laws as they currently exist. No portion of this material may be reproduced, in any form or by any means, without permission in writing from the publisher.

2-13 The triangular plate is fixed at its base, and its apex A is given a horizontal displacement of 5 mm. Determine the average normal strain ϵ_x along the x axis.

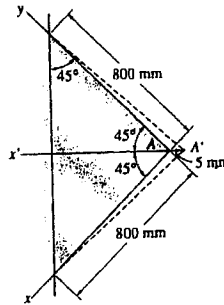
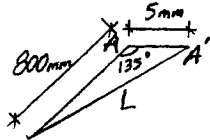

$$L = \sqrt{800^2 + 5^2 - 2(800)(5) \cos 135^\circ} = 803.54 \text{ mm}$$

$$\epsilon_x = \frac{803.54 - 800}{800} = 0.00443 \text{ mm/mm} \quad \text{Ans}$$

From *Mechanics of Materials*, Sixth Edition by R. C. Hibbeler, ISBN 0-13-191345-X.

© 2005 R. C. Hibbeler. Published by Pearson Prentice Hall,

Pearson Education, Inc., Upper Saddle River, NJ. All rights reserved.

This material is protected under all copyright laws as they currently exist. No portion of this material may be reproduced, in any form or by any means, without permission in writing from the publisher.

2-14 The triangular plate is fixed at its base, and its apex A is given a horizontal displacement of 5 mm. Determine the average normal strain $\epsilon_{x'}$ along the x' axis.

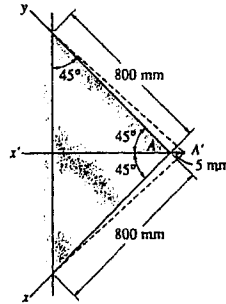
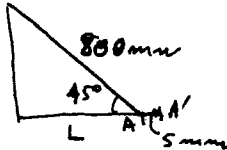

$$L = 800 \cos 45^\circ = 565.69 \text{ mm}$$

$$\epsilon_{x'} = \frac{5}{565.69} = 0.00884 \text{ mm/mm} \quad \text{Ans}$$

From *Mechanics of Materials*, Sixth Edition by R. C. Hibbeler, ISBN 0-13-191345-X.

© 2005 R. C. Hibbeler. Published by Pearson Prentice Hall,

Pearson Education, Inc., Upper Saddle River, NJ. All rights reserved.

This material is protected under all copyright laws as they currently exist. No portion of this material may be reproduced, in any form or by any means, without permission in writing from the publisher.

2-15 The corners of the square plate are given the displacements indicated. Determine the average normal strains ϵ_x and ϵ_y along the x and y axes.

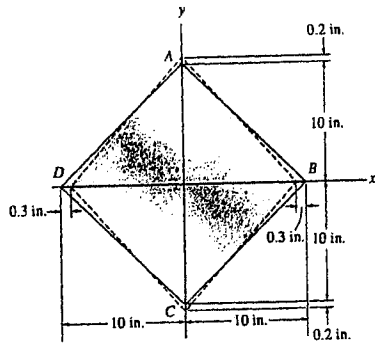

$$\epsilon_x = \frac{-0.3}{10} = -0.03 \text{ in./in.} \quad \text{Ans}$$

$$\epsilon_y = \frac{0.2}{10} = 0.02 \text{ in./in.} \quad \text{Ans}$$

From *Mechanics of Materials*, Sixth Edition by R. C. Hibbeler, ISBN 0-13-191345-X.

© 2005 R. C. Hibbeler. Published by Pearson Prentice Hall,

Pearson Education, Inc., Upper Saddle River, NJ. All rights reserved.

This material is protected under all copyright laws as they currently exist. No portion of this material may be reproduced, in any form or by any means, without permission in writing from the publisher.

*2-16 The corners of the square plate are given the displacements indicated. Determine the shear strain along the edges of the plate at *A* and *B*.

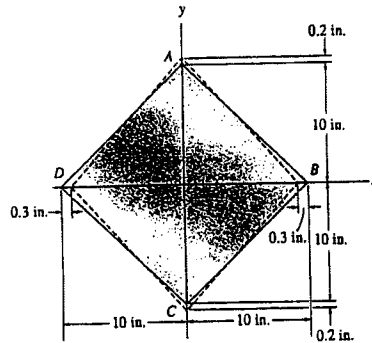

At *A* :

$$\frac{\theta'}{2} = \tan^{-1} \left(\frac{9.7}{10.2} \right) = 43.561^\circ$$

$$\theta' = 1.52056 \text{ rad}$$

$$(\gamma_A)_{nr} = \frac{\pi}{2} - 1.52056$$

$$= 0.0502 \text{ rad} \quad \text{Ans}$$

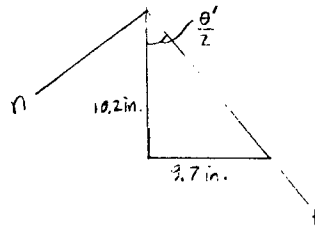

At *B* :

$$\frac{\phi'}{2} = \tan^{-1} \left(\frac{10.2}{9.7} \right) = 46.439^\circ$$

$$\phi' = 1.62104 \text{ rad}$$

$$(\gamma_B)_{nr} = \frac{\pi}{2} - 1.62104$$

$$= -0.0502 \text{ rad} \quad \text{Ans}$$

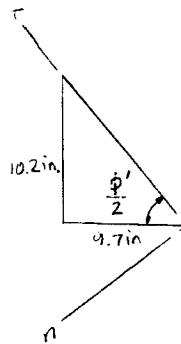

From *Mechanics of Materials*, Sixth Edition by R. C. Hibbeler, ISBN 0-13-191345-X.

© 2005 R. C. Hibbeler. Published by Pearson Prentice Hall,

Pearson Education, Inc., Upper Saddle River, NJ. All rights reserved.

This material is protected under all copyright laws as they currently exist. No portion of this material may be reproduced, in any form or by any means, without permission in writing from the publisher.

2-17 The corners of the square plate are given the displacements indicated. Determine the average normal strains along side AB and diagonals AC and DB .

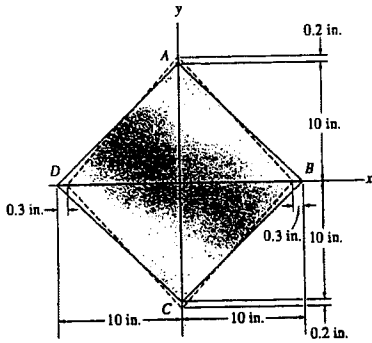

For AB :

$$A'B' = \sqrt{(10.2)^2 + (9.7)^2} = 14.0759 \text{ in.}$$

$$AB = \sqrt{(10)^2 + (10)^2} = 14.14214 \text{ in.}$$

$$\epsilon_{AB} = \frac{14.0759 - 14.14214}{14.14214} = -0.00469 \text{ in./in.} \quad \text{Ans}$$

For AC :

$$\epsilon_{AC} = \frac{20.4 - 20}{20} = 0.0200 \text{ in./in.} \quad \text{Ans}$$

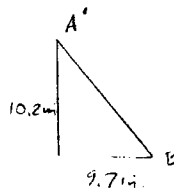

For DB :

$$\epsilon_{DB} = \frac{19.4 - 20}{20} = -0.0300 \text{ in./in.} \quad \text{Ans}$$

From *Mechanics of Materials*, Sixth Edition by R. C. Hibbeler, ISBN 0-13-191345-X.
 © 2005 R. C. Hibbeler. Published by Pearson Prentice Hall,
 Pearson Education, Inc., Upper Saddle River, NJ. All rights reserved.
 This material is protected under all copyright laws as they currently exist. No portion of this material may be reproduced, in any form or by any means, without permission in writing from the publisher.

2-18 The nylon cord has an original length L and is tied to a fixed bolt at A and a roller at B . If a force P is applied to the roller, determine the normal strain in the cord when the roller is at C , ϵ_C , and D , ϵ_D . If the cord was originally unstrained when it was at C , determine the normal strain ϵ_{CD} when the roller moves to D . Show that if the displacements Δ_C and Δ_D are small, then $\epsilon_{CD} = \epsilon_D - \epsilon_C$.

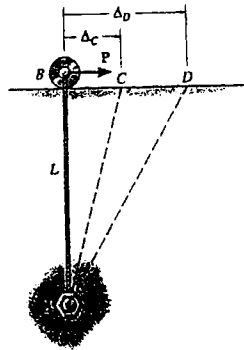

$$L_C = \sqrt{L^2 + \Delta_C^2}$$

$$\epsilon_C = \frac{\sqrt{L^2 + \Delta_C^2} - L}{L}$$

$$= \frac{L\sqrt{1 + \left(\frac{\Delta_C}{L}\right)^2} - L}{L} = \sqrt{1 + \left(\frac{\Delta_C}{L}\right)^2} - 1$$

For small Δ_C ,

$$\epsilon_C = 1 + \frac{1}{2}\left(\frac{\Delta_C^2}{L^2}\right) - 1 = \frac{1}{2}\frac{\Delta_C^2}{L^2} \quad \text{Ans}$$

In the same manner,

$$\epsilon_D = \frac{1}{2}\frac{\Delta_D^2}{L^2} \quad \text{Ans}$$

$$\epsilon_{CD} = \frac{\sqrt{L^2 + \Delta_D^2} - \sqrt{L^2 + \Delta_C^2}}{\sqrt{L^2 + \Delta_C^2}} = \frac{\sqrt{1 + \frac{\Delta_D^2}{L^2}} - \sqrt{1 + \frac{\Delta_C^2}{L^2}}}{\sqrt{1 + \frac{\Delta_C^2}{L^2}}}$$

For small Δ_C and Δ_D ,

$$\epsilon_{CD} = \frac{\left(1 + \frac{1}{2}\frac{\Delta_D^2}{L^2}\right) - \left(1 + \frac{1}{2}\frac{\Delta_C^2}{L^2}\right)}{\left(1 + \frac{1}{2}\frac{\Delta_C^2}{L^2}\right)} = \frac{\frac{1}{2L^2}(\Delta_D^2 - \Delta_C^2)}{\frac{1}{2L^2}(2L^2 + \Delta_C^2)}$$

$$\epsilon_{CD} = \frac{\Delta_D^2 - \Delta_C^2}{2L^2 - \Delta_C^2} = \frac{1}{2L^2}(\Delta_D^2 - \Delta_C^2) = \epsilon_D - \epsilon_C \quad \text{QED}$$

Also this problem can be solved as follows:

$$A_C = L \sec \theta_C; \quad A_D = L \sec \theta_D$$

$$\epsilon_C = \frac{L \sec \theta_C - L}{L} = \sec \theta_C - 1$$

$$\epsilon_D = \frac{L \sec \theta_D - L}{L} = \sec \theta_D - 1$$

Expanding $\sec \theta$

$$\sec \theta = 1 + \frac{\theta^2}{2!} + \frac{5\theta^4}{4!} \dots$$

For small θ neglect the higher order terms

$$\sec \theta = 1 + \frac{\theta^2}{2}$$

Hence,

$$\epsilon_C = 1 + \frac{\theta_C^2}{2} - 1 = \frac{\theta_C^2}{2}$$

$$\epsilon_D = 1 + \frac{\theta_D^2}{2} - 1 = \frac{\theta_D^2}{2}$$

$$\epsilon_{CD} = \frac{L \sec \theta_D - L \sec \theta_C}{L \sec \theta_C} = \frac{\sec \theta_D}{\sec \theta_C} - 1 = \sec \theta_D \cos \theta_C - 1$$

$$\text{Since } \cos \theta = 1 - \frac{\theta^2}{2!} + \frac{\theta^4}{4!} \dots$$

$$\sec \theta_D \cos \theta_C = \left(1 + \frac{\theta_D^2}{2} \dots\right) \left(1 - \frac{\theta_C^2}{2} \dots\right)$$

$$= 1 - \frac{\theta_C^2}{2} + \frac{\theta_D^2}{2} - \frac{\theta_C^2 \theta_D^2}{4}$$

Neglecting the higher order terms

$$\sec \theta_D \cos \theta_C = 1 + \frac{\theta_D^2}{2} - \frac{\theta_C^2}{2}$$

$$\epsilon_{CD} = \left[1 + \frac{\theta_D^2}{2} - \frac{\theta_C^2}{2}\right] - 1 = \frac{\theta_D^2}{2} - \frac{\theta_C^2}{2}$$

$$= \epsilon_D - \epsilon_C \quad \text{QED}$$

From *Mechanics of Materials*, Sixth Edition by R. C. Hibbeler, ISBN 0-13-191345-X.

© 2005 R. C. Hibbeler. Published by Pearson Prentice Hall,

Pearson Education, Inc., Upper Saddle River, NJ. All rights reserved.

This material is protected under all copyright laws as they currently exist. No portion of this material may be reproduced, in any form or by any means, without permission in writing from the publisher.

2-19 The three cords are attached to the ring at B . When a force is applied to the ring it moves it to point B' , such that the normal strain in AB is ϵ_{AB} and the normal strain in CB is ϵ_{CB} . Provided these strains are small, determine the normal strain in DB . Note that AB and CB remain horizontal and vertical, respectively, due to the roller guides at A and C .

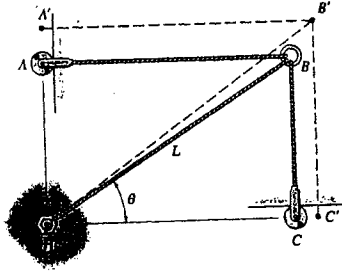

Coordinates of B ($L \cos \theta$, $L \sin \theta$)

Coordinates of B' ($L \cos \theta + \epsilon_{AB} L \cos \theta$, $L \sin \theta + \epsilon_{CB} L \sin \theta$)

$$L_{DB'} = \sqrt{(L \cos \theta + \epsilon_{AB} L \cos \theta)^2 + (L \sin \theta + \epsilon_{CB} L \sin \theta)^2}$$

$$L_{DB'} = L \sqrt{\cos^2 \theta (1 + 2\epsilon_{AB} + \epsilon_{AB}^2) + \sin^2 \theta (1 + 2\epsilon_{CB} + \epsilon_{CB}^2)}$$

Since ϵ_{AB} and ϵ_{CB} are small,

$$L_{DB'} = L \sqrt{1 + (2\epsilon_{AB} \cos^2 \theta + 2\epsilon_{CB} \sin^2 \theta)}$$

Use the binomial theorem,

$$\begin{aligned} L_{DB'} &= L \left(1 + \frac{1}{2} (2\epsilon_{AB} \cos^2 \theta + 2\epsilon_{CB} \sin^2 \theta) \right) \\ &= L (1 + \epsilon_{AB} \cos^2 \theta + \epsilon_{CB} \sin^2 \theta) \end{aligned}$$

$$\text{Thus, } \epsilon_{DB} = \frac{L(1 + \epsilon_{AB} \cos^2 \theta + \epsilon_{CB} \sin^2 \theta) - L}{L}$$

$$\epsilon_{DB} = \epsilon_{AB} \cos^2 \theta + \epsilon_{CB} \sin^2 \theta \quad \text{Ans}$$

From *Mechanics of Materials*, Sixth Edition by R. C. Hibbeler, ISBN 0-13-191345-X.

© 2005 R. C. Hibbeler. Published by Pearson Prentice Hall,

Pearson Education, Inc., Upper Saddle River, NJ. All rights reserved.

This material is protected under all copyright laws as they currently exist. No portion of this material may be reproduced, in any form or by any means, without permission in writing from the publisher.

*2-20 The rectangular plate is subjected to the deformation shown by the dashed lines. Determine the shear strains γ_{xy} and $\gamma_{x'y'}$ developed at point A.

Since the right angle of an element along the x, y axes does not distort, then

$$\gamma_{xy} = 0 \quad \text{Ans}$$

$$\tan \theta = \frac{5.02}{4.99}$$

$$\theta = 45.17^\circ = 0.7884 \text{ rad}$$

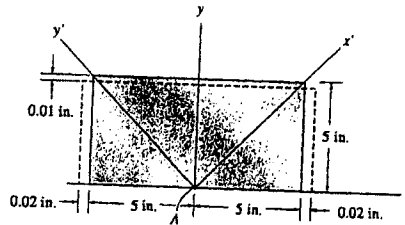
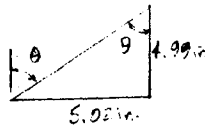

$$\begin{aligned} \gamma_{x'y'} &= \frac{\pi}{2} - 2\theta \\ &= \frac{\pi}{2} - 2(0.7884) \\ &= -0.00599 \text{ rad} \quad \text{Ans} \end{aligned}$$

From *Mechanics of Materials*, Sixth Edition by R. C. Hibbeler, ISBN 0-13-191345-X.

© 2005 R. C. Hibbeler. Published by Pearson Prentice Hall,

Pearson Education, Inc., Upper Saddle River, NJ. All rights reserved.

This material is protected under all copyright laws as they currently exist. No portion of this material may be reproduced, in any form or by any means, without permission in writing from the publisher.

2-21 A thin wire, lying along the x axis, is strained such that each point on the wire is displaced $\Delta x = kx^2$ along the x axis. If k is constant, what is the normal strain at any point P along the wire?

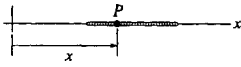

$$\epsilon = \frac{d(\Delta x)}{dx} = 2 k x \quad \text{Ans}$$

From *Mechanics of Materials*, Sixth Edition by R. C. Hibbeler, ISBN 0-13-191345-X.

© 2005 R. C. Hibbeler. Published by Pearson Prentice Hall,

Pearson Education, Inc., Upper Saddle River, NJ. All rights reserved.

This material is protected under all copyright laws as they currently exist. No portion of this material may be reproduced, in any form or by any means, without permission in writing from the publisher.

2-22 The wire is subjected to a normal strain that is defined by $\epsilon = \frac{x}{L} e^{-x^2/L^2}$, where x is in millimeters. If the wire has an initial length L , determine the increase in its length.

$$\Delta L = \frac{1}{L} \int_0^L x e^{-(x/L)^2} dx$$

$$= -L \left[\frac{e^{-(x/L)^2}}{2} \right]_0^L = \frac{L}{2} [1 - (1/e)]$$

$$= \frac{L}{2e} [e - 1]$$

Ans.

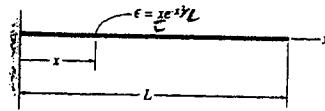

From *Mechanics of Materials*, Sixth Edition by R. C. Hibbeler, ISBN 0-13-191345-X.
 © 2005 R. C. Hibbeler. Published by Pearson Prentice Hall,
 Pearson Education, Inc., Upper Saddle River, NJ. All rights reserved.
 This material is protected under all copyright laws as they currently exist. No portion of this material may be reproduced, in any form or by any means, without permission in writing from the publisher.

2-23 The rectangular plate is subjected to the deformation shown by the dashed lines. Determine the average shear strain γ_{xy} of the plate.

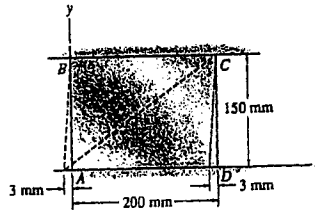

$$\gamma_{xy} = \tan \gamma_{xy} = \frac{3}{150} = 0.02 \text{ rad} \quad \text{Ans}$$

From *Mechanics of Materials*, Sixth Edition by R. C. Hibbeler, ISBN 0-13-191345-X.

© 2005 R. C. Hibbeler. Published by Pearson Prentice Hall,

Pearson Education, Inc., Upper Saddle River, NJ. All rights reserved.

This material is protected under all copyright laws as they currently exist. No portion of this material may be reproduced, in any form or by any means, without permission in writing from the publisher.

*2-24 The rectangular plate is subjected to the deformation shown by the dashed lines. Determine the average normal strains along the diagonal AC and side AB .

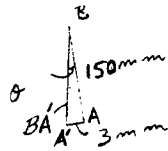
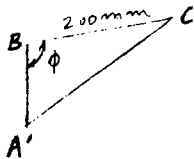
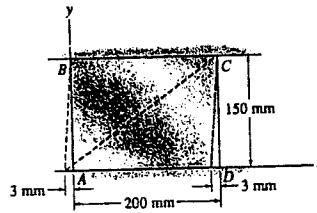

For AC :

$$\theta = \tan^{-1} \left(\frac{3}{150} \right)$$

$$\theta = 1.1458^\circ$$

$$\phi = 90^\circ + 1.1458^\circ = 91.1458^\circ$$

$$BA' = \sqrt{(150)^2 + (3)^2} = 150.0300 \text{ mm}$$

$$A'C' = \sqrt{(150.0300)^2 + (200)^2 - 2(150.0300)(200)\cos 91.1458^\circ}$$

$$A'C' = 252.4064 \text{ mm}$$

$$AC = \sqrt{(200)^2 + (150)^2} = 250 \text{ mm}$$

$$\epsilon_{AC} = \frac{252.4064 - 250}{250} = 0.00963 \text{ mm/mm} \quad \text{Ans}$$

For AB :

$$\epsilon_{AB} = \frac{150.0300 - 150}{150} = 0.000200 \text{ mm/mm} \quad \text{Ans}$$

From *Mechanics of Materials*, Sixth Edition by R. C. Hibbeler, ISBN 0-13-191345-X.

© 2005 R. C. Hibbeler. Published by Pearson Prentice Hall,

Pearson Education, Inc., Upper Saddle River, NJ. All rights reserved.

This material is protected under all copyright laws as they currently exist. No portion of this material may be reproduced, in any form or by any means, without permission in writing from the publisher.

2-25 The piece of rubber is originally rectangular. Determine the average shear strain γ_{xy} if the corners B and D are subjected to the displacements that cause the rubber to distort as shown by the dashed lines.

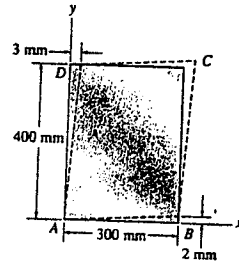

$$\theta_1 = \tan \theta_1 = \frac{2}{300} = 0.006667 \text{ rad}$$

$$\theta_2 = \tan \theta_2 = \frac{3}{400} = 0.0075 \text{ rad}$$

$$\gamma_{xy} = \theta_1 + \theta_2$$

$$= 0.006667 + 0.0075 = 0.0142 \text{ rad} \quad \text{Ans}$$

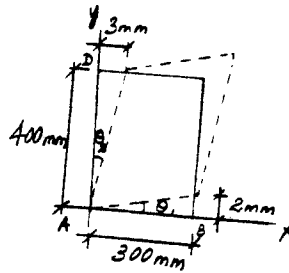

From *Mechanics of Materials*, Sixth Edition by R. C. Hibbeler, ISBN 0-13-191345-X.

© 2005 R. C. Hibbeler. Published by Pearson Prentice Hall,

Pearson Education, Inc., Upper Saddle River, NJ. All rights reserved.

This material is protected under all copyright laws as they currently exist. No portion of this material may be reproduced, in any form or by any means, without permission in writing from the publisher.

2-26 The piece of rubber is originally rectangular and subjected to the deformation shown by the dashed lines. Determine the average normal strain along the diagonal DB and side AD .

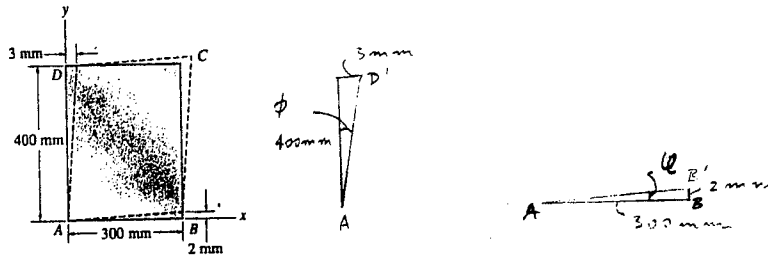

$$AD' = \sqrt{(400)^2 + (3)^2} = 400.01125 \text{ mm}$$

$$\phi = \tan^{-1} \left(\frac{3}{400} \right) = 0.42971^\circ$$

$$AB' = \sqrt{(300)^2 + (2)^2} = 300.00667$$

$$\phi = \tan^{-1} \left(\frac{2}{300} \right) = 0.381966^\circ$$

$$\alpha = 90^\circ - 0.42971^\circ - 0.381966^\circ = 89.18832^\circ$$

$$D'B' = \sqrt{(400.01125)^2 + (300.00667)^2 - 2(400.01125)(300.00667) \cos(89.18832^\circ)}$$

$$D'B' = 496.6014 \text{ mm}$$

$$DB = \sqrt{(300)^2 + (400)^2} = 500 \text{ mm}$$

$$\epsilon_{DB} = \frac{496.6014 - 500}{500} = -0.00680 \text{ mm/mm} \quad \text{Ans}$$

$$\epsilon_{AD} = \frac{400.01125 - 400}{400} = 0.0281(10^{-3}) \text{ mm/mm} \quad \text{Ans}$$

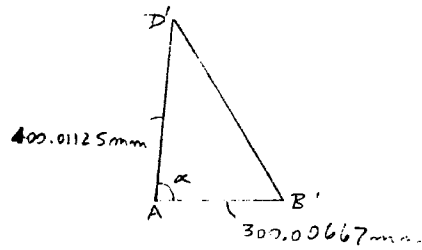

From *Mechanics of Materials*, Sixth Edition by R. C. Hibbeler, ISBN 0-13-191345-X.

© 2005 R. C. Hibbeler. Published by Pearson Prentice Hall,

Pearson Education, Inc., Upper Saddle River, NJ. All rights reserved.

This material is protected under all copyright laws as they currently exist. No portion of this material may be reproduced, in any form or by any means, without permission in writing from the publisher.

2-27 The material distorts into the dashed position shown. Determine (a) the average normal strains ϵ_x , ϵ_y and the shear strain γ_{xy} , and (b) the average normal strain along line BE .

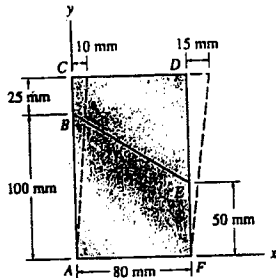

Since there is no deformation occurring along the y and x axes,

$$\epsilon_x = 0 \quad \text{Ans.}$$

$$\epsilon_y = \frac{\sqrt{(125)^2 + (10)^2} - 125}{125} = 0.00319 \quad \text{Ans.}$$

$$\tan \gamma_{xy} = \frac{10}{125}$$

$$\gamma_{xy} = 0.0798 \text{ rad} \quad \text{Ans}$$

From geometry :

$$\frac{BB'}{100} = \frac{10}{125}; \quad BB' = 8 \text{ mm}$$

$$\frac{EE'}{50} = \frac{15}{125}; \quad EE' = 6 \text{ mm}$$

$$BE = \sqrt{50^2 + 80^2} = \sqrt{8900} \text{ mm}$$

$$x' = 80 + EE' - BB' = 80 + 6 - 8 = 78 \text{ mm}$$

$$B'E' = \sqrt{50^2 + 78^2} = \sqrt{8584} \text{ mm}$$

$$\epsilon_{BE} = \frac{B'E' - BE}{BE} = \frac{\sqrt{8584} - \sqrt{8900}}{\sqrt{8900}}$$

$$= -0.0179 \text{ mm/mm} \quad \text{Ans}$$

Negative sign indicates shortening of BE .

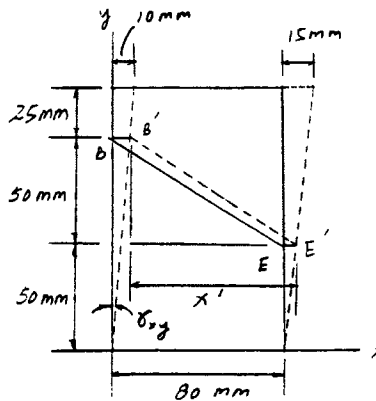

From *Mechanics of Materials*, Sixth Edition by R. C. Hibbeler, ISBN 0-13-191345-X.

© 2005 R. C. Hibbeler. Published by Pearson Prentice Hall,

Pearson Education, Inc., Upper Saddle River, NJ. All rights reserved.

This material is protected under all copyright laws as they currently exist. No portion of this material may be reproduced, in any form or by any means, without permission in writing from the publisher.

*2-28 The material distorts into the dashed position shown. Determine the average normal strain that occurs along the diagonals AD and CF .

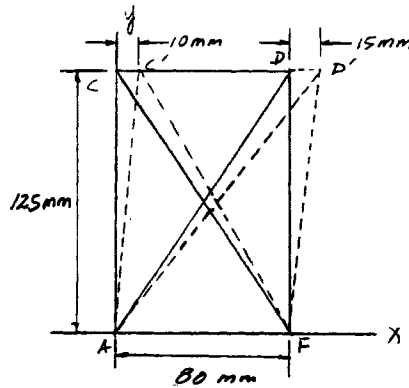
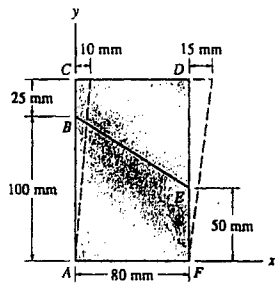

$$AD = CF = \sqrt{(80)^2 + (125)^2} = \sqrt{22025} \text{ mm}$$

$$C'F = \sqrt{(70)^2 + (125)^2} = \sqrt{20525} \text{ mm}$$

$$AD' = \sqrt{(95)^2 + (125)^2} = \sqrt{24650} \text{ mm}$$

$$\begin{aligned} \epsilon_{AD} &= \frac{AD' - AD}{AD} \\ &= \frac{\sqrt{24650} - \sqrt{22025}}{\sqrt{22025}} \\ &= 0.0579 \text{ mm/mm} \quad \text{Ans} \end{aligned}$$

$$\begin{aligned} \epsilon_{CF} &= \frac{C'F - CF}{CF} = \frac{\sqrt{20525} - \sqrt{22025}}{\sqrt{22025}} \\ &= -0.0347 \text{ mm/mm} \quad \text{Ans} \end{aligned}$$

From *Mechanics of Materials*, Sixth Edition by R. C. Hibbeler, ISBN 0-13-191345-X.

© 2005 R. C. Hibbeler. Published by Pearson Prentice Hall,

Pearson Education, Inc., Upper Saddle River, NJ. All rights reserved.

This material is protected under all copyright laws as they currently exist. No portion of this material may be reproduced, in any form or by any means, without permission in writing from the publisher.

2-29 The nonuniform loading causes a normal strain in the shaft that can be expressed as $\epsilon_x = kx^2$, where k is a constant. Determine the displacement of the end B . Also, what is the average normal strain in the rod?

$$\frac{d(\Delta x)}{dx} = \epsilon_x = kx^2$$

$$(\Delta x)_B = \int_0^L kx^2 dx = \frac{kL^3}{3}$$

Ans

$$(\epsilon_x)_{avg} = \frac{(\Delta x)_B}{L} = \frac{\frac{kL^3}{3}}{L} = \frac{kL^2}{3}$$

Ans

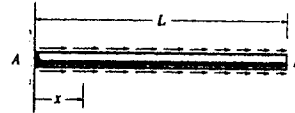

From *Mechanics of Materials*, Sixth Edition by R. C. Hibbeler, ISBN 0-13-191345-X.

© 2005 R. C. Hibbeler. Published by Pearson Prentice Hall,

Pearson Education, Inc., Upper Saddle River, NJ. All rights reserved.

This material is protected under all copyright laws as they currently exist. No portion of this material may be reproduced, in any form or by any means, without permission in writing from the publisher.

2-30 The nonuniform loading causes a normal strain in the shaft that can be expressed as $\epsilon_x = k \sin\left(\frac{\pi}{L}x\right)$, where k is a constant. Determine the displacement of the center C and the average normal strain in the entire rod.

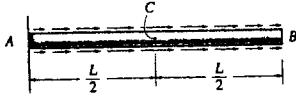

$$\epsilon_x = k \sin\left(\frac{\pi}{L}x\right)$$

$$\begin{aligned} (\Delta x)_C &= \int_0^{L/2} \epsilon_x dx = \int_0^{L/2} k \sin\left(\frac{\pi}{L}x\right) dx \\ &= -k\left(\frac{L}{\pi}\right) \cos\left(\frac{\pi}{L}x\right) \Big|_0^{L/2} = -k\left(\frac{L}{\pi}\right) \left(\cos\frac{\pi}{2} - \cos 0\right) \\ &= \frac{kL}{\pi} \quad \text{Ans} \end{aligned}$$

$$\begin{aligned} (\Delta x)_B &= \int_0^L k \sin\left(\frac{\pi}{L}x\right) dx \\ &= -k\left(\frac{L}{\pi}\right) \cos\left(\frac{\pi}{L}x\right) \Big|_0^L = -k\left(\frac{L}{\pi}\right) (\cos \pi - \cos 0) = \frac{2kL}{\pi} \end{aligned}$$

$$\epsilon_{avg} = \frac{(\Delta x)_B}{L} = \frac{2k}{\pi} \quad \text{Ans}$$

From *Mechanics of Materials*, Sixth Edition by R. C. Hibbeler, ISBN 0-13-191345-X.

© 2005 R. C. Hibbeler. Published by Pearson Prentice Hall,

Pearson Education, Inc., Upper Saddle River, NJ. All rights reserved.

This material is protected under all copyright laws as they currently exist. No portion of this material may be reproduced, in any form or by any means, without permission in writing from the publisher.

2-31 The curved pipe has an original radius of 2 ft. If it is heated nonuniformly, so that the normal strain along its length is $\epsilon = 0.05 \cos \theta$, determine the increase in length of the pipe.

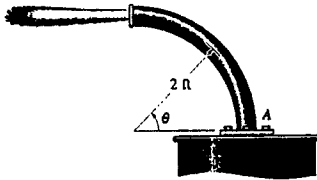

$$\epsilon = 0.05 \cos \theta$$

$$\Delta L = \int \epsilon dL$$

$$= \int_0^{90^\circ} (0.05 \cos \theta)(2 d\theta)$$

$$= 0.1 \int_0^{90^\circ} \cos \theta d\theta = 0.1 [\sin \theta]_0^{90^\circ} = 0.10 \text{ ft} \quad \text{Ans}$$

From *Mechanics of Materials*, Sixth Edition by R. C. Hibbeler, ISBN 0-13-191345-X.

© 2005 R. C. Hibbeler. Published by Pearson Prentice Hall,

Pearson Education, Inc., Upper Saddle River, NJ. All rights reserved.

This material is protected under all copyright laws as they currently exist. No portion of this material may be reproduced, in any form or by any means, without permission in writing from the publisher.

*2-32 Solve Prob. 2-31 if $\epsilon = 0.08 \sin \theta$.

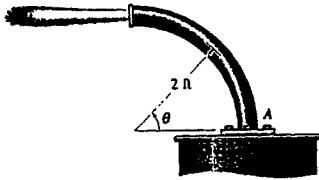

$$dL = 2 d\theta$$

$$\epsilon = 0.08 \sin \theta$$

$$\begin{aligned} \Delta L &= \int \epsilon dL \\ &= \int_0^{90^\circ} (0.08 \sin \theta)(2 d\theta) \\ &= 0.16 \int_0^{90^\circ} \sin \theta d\theta = 0.16[-\cos \theta]_0^{90^\circ} = 0.16 \text{ ft} \quad \mathbf{Ans} \end{aligned}$$

From *Mechanics of Materials*, Sixth Edition by R. C. Hibbeler, ISBN 0-13-191345-X.

© 2005 R. C. Hibbeler. Published by Pearson Prentice Hall,

Pearson Education, Inc., Upper Saddle River, NJ. All rights reserved.

This material is protected under all copyright laws as they currently exist. No portion of this material may be reproduced, in any form or by any means, without permission in writing from the publisher.

2-33 The Polysulfone block is glued at its top and bottom to the rigid plates. If a tangential force, applied to the top plate, causes the material to deform so that its sides are described by the equation $y = 3.56x^{1/4}$, determine the shear strain in the material at its corners A and B.

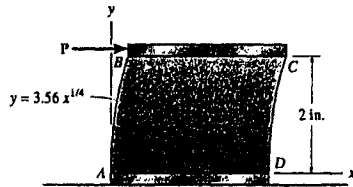

Prob. 2-33

$$y = 3.56 x^{1/4}$$

$$\frac{dy}{dx} = 0.890 x^{-3/4}$$

$$\frac{dx}{dy} = 1.123 x^{3/4}$$

At A, $x = 0$

$$\gamma_A = \frac{dx}{dy} = 0 \quad \text{Ans}$$

At B,

$$2 = 3.56 x^{1/4}$$

$$x = 0.0996 \text{ in.}$$

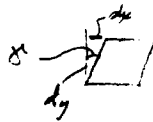

$$\gamma_B = \frac{dx}{dy} = 1.123(0.0996)^{3/4} = 0.199 \text{ rad} \quad \text{Ans}$$

From *Mechanics of Materials*, Sixth Edition by R. C. Hibbeler, ISBN 0-13-191345-X.

© 2005 R. C. Hibbeler. Published by Pearson Prentice Hall,

Pearson Education, Inc., Upper Saddle River, NJ. All rights reserved.

This material is protected under all copyright laws as they currently exist. No portion of this material may be reproduced, in any form or by any means, without permission in writing from the publisher.

2-34. The fiber AB has a length L and orientation θ . If its ends A and B undergo very small displacements u_A and v_B , respectively, determine the normal strain in the fiber when it is in position $A'B'$.

Geometry :

$$L_{A'B'} = \sqrt{(L \cos \theta - u_A)^2 + (L \sin \theta + v_B)^2}$$

$$= \sqrt{L^2 + u_A^2 + v_B^2 + 2L(v_B \sin \theta - u_A \cos \theta)}$$

Average Normal strain :

$$\epsilon_{AB} = \frac{L_{A'B'} - L}{L}$$

$$= \sqrt{1 + \frac{u_A^2 + v_B^2}{L^2} + \frac{2(v_B \sin \theta - u_A \cos \theta)}{L}} - 1$$

Neglecting higher terms u_A^2 and v_B^2

$$\epsilon_{AB} = \left[1 + \frac{2(v_B \sin \theta - u_A \cos \theta)}{L} \right]^{\frac{1}{2}} - 1$$

Using the binomial theorem :

$$\epsilon_{AB} = 1 + \frac{1}{2} \left(\frac{2v_B \sin \theta}{L} - \frac{2u_A \cos \theta}{L} \right) + \dots - 1$$

$$= \frac{v_B \sin \theta}{L} - \frac{u_A \cos \theta}{L}$$

Ans

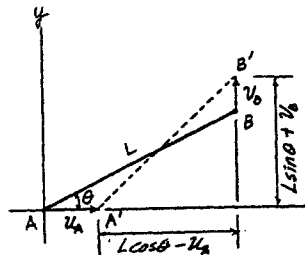

From *Mechanics of Materials*, Sixth Edition by R. C. Hibbeler, ISBN 0-13-191345-X.

© 2005 R. C. Hibbeler. Published by Pearson Prentice Hall,

Pearson Education, Inc., Upper Saddle River, NJ. All rights reserved.

This material is protected under all copyright laws as they currently exist. No portion of this material may be reproduced, in any form or by any means, without permission in writing from the publisher.

2-35. If the normal strain is defined in reference to the final length, that is,

$$\epsilon'_n = \lim_{p \rightarrow p'} \left(\frac{\Delta S' - \Delta S}{\Delta S'} \right)$$

instead of in reference to the original length, Eq. 2-2, show that the difference in these strains is represented as a second-order term, namely, $\epsilon_n - \epsilon'_n = \epsilon_n \epsilon'_n$.

$$\epsilon_n = \frac{\Delta S' - \Delta S}{\Delta S}$$

$$\begin{aligned} \epsilon_n - \epsilon'_n &= \frac{\Delta S' - \Delta S}{\Delta S} - \frac{\Delta S' - \Delta S}{\Delta S'} \\ &= \frac{\Delta S'^2 - \Delta S \Delta S' - \Delta S' \Delta S + \Delta S^2}{\Delta S \Delta S'} \\ &= \frac{\Delta S'^2 + \Delta S^2 - 2\Delta S' \Delta S}{\Delta S \Delta S'} \\ &= \frac{(\Delta S' - \Delta S)^2}{\Delta S \Delta S'} = \left(\frac{\Delta S' - \Delta S}{\Delta S} \right) \left(\frac{\Delta S' - \Delta S}{\Delta S'} \right) \\ &= \epsilon_n \epsilon'_n \quad (Q.E.D) \end{aligned}$$

From *Mechanics of Materials*, Sixth Edition by R. C. Hibbeler, ISBN 0-13-191345-X.

© 2005 R. C. Hibbeler. Published by Pearson Prentice Hall,

Pearson Education, Inc., Upper Saddle River, NJ. All rights reserved.

This material is protected under all copyright laws as they currently exist. No portion of this material may be reproduced, in any form or by any means, without permission in writing from the publisher.

3-1 A tension test was performed on a steel specimen having an original diameter of 0.503 in. and a gauge length of 2.00 in. The data is listed in the table. Plot the stress-strain diagram and determine approximately the modulus of elasticity, the ultimate stress, and the rupture stress. Use a scale of 1 in. = 15 ksi and 1 in. = 0.05 in./in. Redraw the linear-elastic region, using the same stress scale but a strain scale of 1 in. = 0.001 in.

Load (kip)	Elongation (in.)
0	0
2.50	0.0009
6.50	0.0025
8.50	0.0040
9.20	0.0065
9.80	0.0098
12.0	0.0400
14.0	0.1200
14.5	0.2500
14.0	0.3500
13.2	0.4700

$$A = \frac{1}{4}\pi(0.503)^2 = 0.19871 \text{ in}^2$$

$$L = 2.00 \text{ in.}$$

$$\sigma = \frac{P}{A} \text{ (ksi)} \quad \epsilon = \frac{\Delta L}{L} \text{ (in./in.)}$$

0	0
12.58	0.00045
32.71	0.00125
42.78	0.0020
46.30	0.00325
49.32	0.0049
60.39	0.02
70.45	0.06
73.00	0.125
70.45	0.175
66.42	0.235

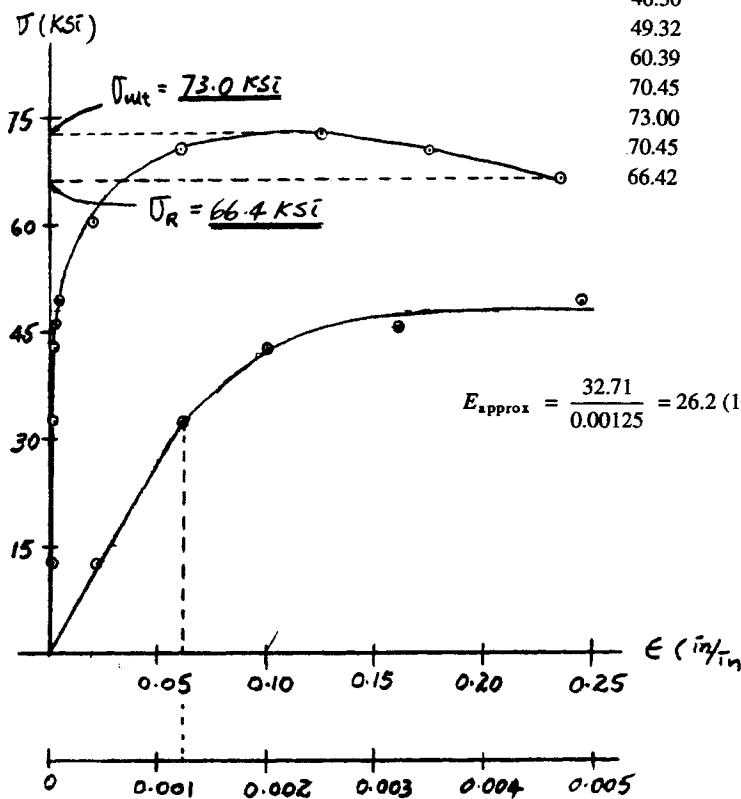

From *Mechanics of Materials*, Sixth Edition by R. C. Hibbeler, ISBN 0-13-191345-X.

© 2005 R. C. Hibbeler. Published by Pearson Prentice Hall,

Pearson Education, Inc., Upper Saddle River, NJ. All rights reserved.

This material is protected under all copyright laws as they currently exist. No portion of this material may be reproduced, in any form or by any means, without permission in writing from the publisher.

3-2 A tension test was performed on a steel specimen having an original diameter of 0.503 in. and gauge length of 2.00 in. Using the data listed in the table, plot the stress-strain diagram and determine approximately the modulus of toughness.

Load (kip)	Elongation (in.)
0	0
2.50	0.0009
6.50	0.0025
8.50	0.0040
9.20	0.0065
9.80	0.0098
12.0	0.0400
14.0	0.1200
14.5	0.2500
14.0	0.3500
13.2	0.4700

Modulus of toughness (approx)

$$u_t = \text{total area under the curve}$$

$$= 87 (7.5) (0.025) \quad (1)$$

$$= 16.3 \frac{\text{in.} \cdot \text{kip}}{\text{in}^3} \quad \text{Ans}$$

In Eq.(1), 87 is the number of squares under the curve.

$\sigma = \frac{P}{A}$ (ksi)	$\epsilon = \frac{\Delta L}{L}$ (in./in.)
0	0
12.58	0.00045
32.71	0.00125
42.78	0.0020
46.30	0.00325
49.32	0.0049
60.39	0.02
70.45	0.06
73.00	0.125
70.45	0.175
66.42	0.235

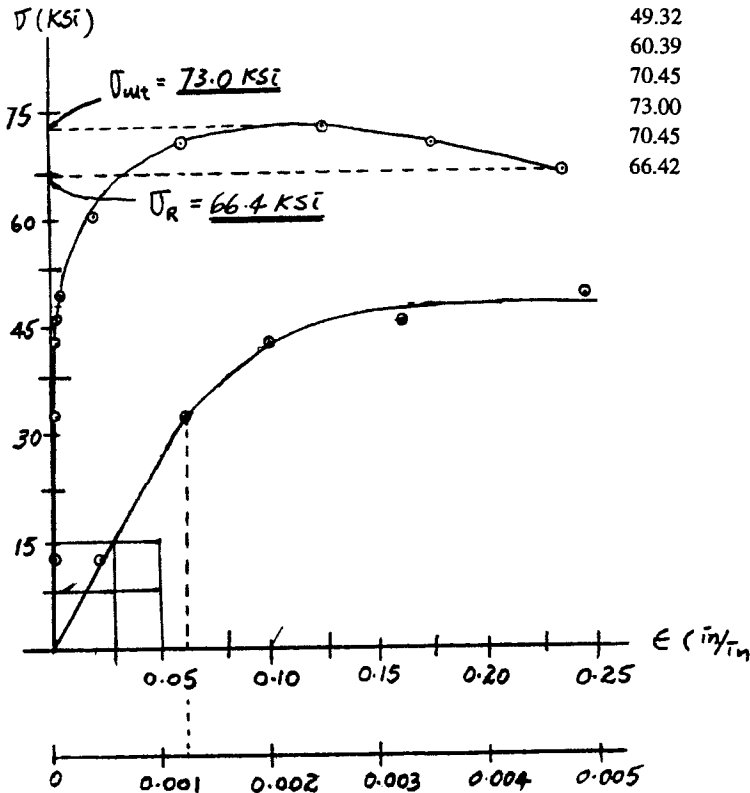

From *Mechanics of Materials*, Sixth Edition by R. C. Hibbeler, ISBN 0-13-191345-X.
 © 2005 R. C. Hibbeler. Published by Pearson Prentice Hall,
 Pearson Education, Inc., Upper Saddle River, NJ. All rights reserved.
 This material is protected under all copyright laws as they currently exist. No portion of this material may be reproduced, in any form or by any means, without permission in writing from the publisher.

3-3 Data taken from a stress-strain test for a ceramic is given in the table. The curve is linear between the origin and the first point. Plot the curve, and determine the modulus of elasticity and the modulus of resilience.

σ (MPa)	ϵ (mm/mm)
0	0
229	0.0008
314	0.0012
341	0.0016
355	0.0020
368	0.0024

$$E = \frac{229(10^6)}{0.0008} = 286 \text{ GPa} \quad \text{Ans}$$

$$u_r = \frac{1}{2}(229)(10^6) \text{ N/m}^2(0.0008) \text{ mm/mm}$$

$$= 91.6 \text{ kJ/m}^3 \quad \text{Ans}$$

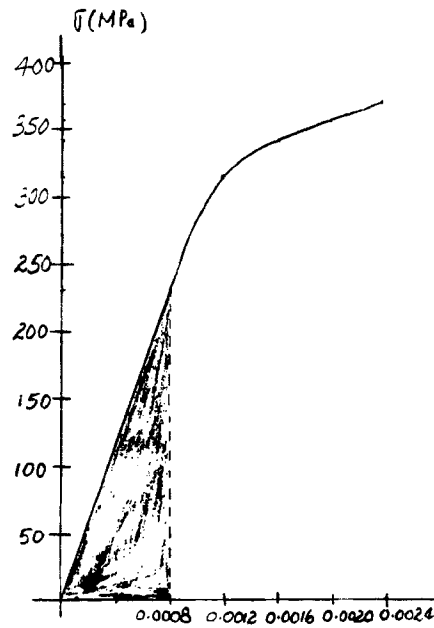

From *Mechanics of Materials*, Sixth Edition by R. C. Hibbeler, ISBN 0-13-191345-X.

© 2005 R. C. Hibbeler. Published by Pearson Prentice Hall,

Pearson Education, Inc., Upper Saddle River, NJ. All rights reserved.

This material is protected under all copyright laws as they currently exist. No portion of this material may be reproduced, in any form or by any means, without permission in writing from the publisher.

*3-4 A tension test was performed on a steel specimen having an original diameter of 0.503 in. and gauge length of 2.00 in. The data is listed in the table. Plot the stress-strain diagram and determine approximately the modulus of elasticity, the yield stress, the ultimate stress, and the rupture stress. Use a scale of 1 in. = 20 ksi and 1 in. = 0.05 in./in. Redraw the elastic region, using the same stress scale but a strain scale of 1 in. = 0.001 in./in.

$$A = \frac{1}{4}\pi(0.503)^2 = 0.1987 \text{ in}^2$$

$$L = 2.00 \text{ in.}$$

Load (kip)	Elongation (in.)
0	0
1.50	0.0005
4.60	0.0015
8.00	0.0025
11.00	0.0035
11.80	0.0050
11.80	0.0080
12.00	0.0200
16.60	0.0400
20.00	0.1000
21.50	0.2800
19.50	0.4000
18.50	0.4600

σ (ksi)	ϵ (in./in.)
0	0
7.55	0.00025
23.15	0.00075
40.26	0.00125
55.36	0.00175
59.38	0.0025
59.38	0.0040
60.39	0.010
83.54	0.020
100.65	0.050
108.20	0.140
98.13	0.200
93.10	0.230

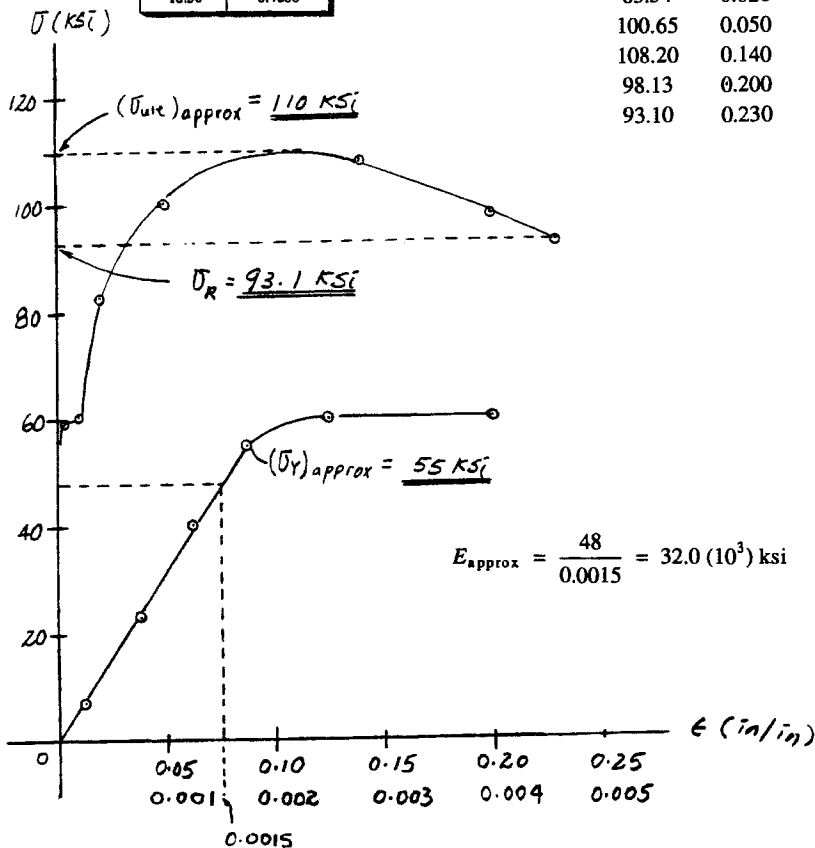

From *Mechanics of Materials*, Sixth Edition by R. C. Hibbeler, ISBN 0-13-191345-X.

© 2005 R. C. Hibbeler. Published by Pearson Prentice Hall,

Pearson Education, Inc., Upper Saddle River, NJ. All rights reserved.

This material is protected under all copyright laws as they currently exist. No portion of this material may be reproduced, in any form or by any means, without permission in writing from the publisher.

3-5. The stress-strain diagram for a steel alloy having an original diameter of 0.5 in. and a gauge length of 2 in. is given in the figure. Determine approximately the modulus of elasticity for the material, the load on the specimen that causes yielding, and the ultimate load the specimen will support.

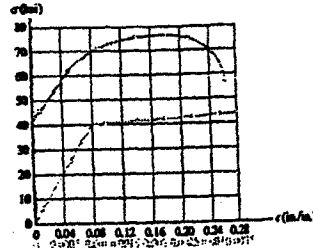

Modulus of Elasticity : From the stress - strain diagram,
 $\sigma = 40$ ksi when $\epsilon = 0.001$ in./in.

$$E_{\text{approx}} = \frac{40 - 0}{0.001 - 0} = 40.0 (10^3) \text{ ksi} \quad \text{Ans}$$

Yield Load : From the stress - strain diagram, $\sigma_y = 40.0$ ksi.

$$P_y = \sigma_y A = 40.0 \left[\left(\frac{\pi}{4} \right) (0.5^2) \right] = 7.85 \text{ kip} \quad \text{Ans}$$

Ultimate Load : From the stress - strain diagram, $\sigma_u = 76.25$ ksi.

$$P_u = \sigma_u A = 76.25 \left[\left(\frac{\pi}{4} \right) (0.5^2) \right] = 15.0 \text{ kip} \quad \text{Ans}$$

From *Mechanics of Materials*, Sixth Edition by R. C. Hibbeler, ISBN 0-13-191345-X.

© 2005 R. C. Hibbeler. Published by Pearson Prentice Hall,

Pearson Education, Inc., Upper Saddle River, NJ. All rights reserved.

This material is protected under all copyright laws as they currently exist. No portion of this material may be reproduced, in any form or by any means, without permission in writing from the publisher.

3-6. The stress-strain diagram for a steel alloy having an original diameter of 0.5 in. and a gauge length of 2 in. is given in the figure. If the specimen is loaded until it is stressed to 70 ksi, determine the approximate amount of elastic recovery and the increase in the gauge length after it is unloaded.

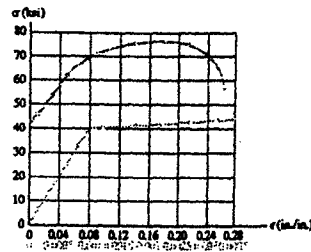

Modulus of Elasticity : From the stress – strain diagram,
 $\sigma = 40$ ksi when $\epsilon = 0.001$ in./in.

$$E = \frac{40 - 0}{0.001 - 0} = 40.0(10^3) \text{ ksi}$$

Elastic Recovery :

$$\text{Elastic recovery} = \frac{\sigma}{E} = \frac{70}{40.0(10^3)} = 0.00175 \text{ in./in.}$$

Thus,

$$\text{The amount of Elastic Recovery} = 0.00175(2) = 0.00350 \text{ in.} \quad \text{Ans}$$

Permanent Set :

$$\text{Permanent set} = 0.08 - 0.00175 = 0.07825 \text{ in./in.}$$

Thus,

$$\text{Permanent elongation} = 0.07825(2) = 0.1565 \text{ in.} \quad \text{Ans}$$

From *Mechanics of Materials*, Sixth Edition by R. C. Hibbeler, ISBN 0-13-191345-X.

© 2005 R. C. Hibbeler. Published by Pearson Prentice Hall,

Pearson Education, Inc., Upper Saddle River, NJ. All rights reserved.

This material is protected under all copyright laws as they currently exist. No portion of this material may be reproduced, in any form or by any means, without permission in writing from the publisher.

3-7. The stress–strain diagram for a steel alloy having an original diameter of 0.5 in. and a gauge length of 2 in. is given in the figure. Determine approximately the modulus of resilience and the modulus of toughness for the material.

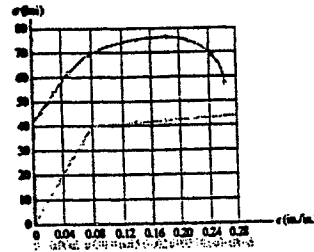

Modulus of Resilience : The modulus of resilience is equal to the area under the *linear portion* of the stress – strain diagram.

$$(u_r)_{\text{approx}} = \frac{1}{2} (40.0) \left(10^3 \right) \left(\frac{\text{lb}}{\text{in}^2} \right) \left(0.001 \frac{\text{in.}}{\text{in.}} \right) = 20.0 \frac{\text{in} \cdot \text{lb}}{\text{in}^3} \quad \mathbf{Ans.}$$

Modulus of Toughness : The modulus of toughness is equal to the total area under the stress – strain diagram and can be approximated by counting the number of squares. The total number of squares is 45.

$$(u_t)_{\text{approx}} = 45 \left(10 \frac{\text{kip}}{\text{in}^2} \right) \left(0.04 \frac{\text{in.}}{\text{in.}} \right) = 18.0 \frac{\text{in} \cdot \text{kip}}{\text{in}^3} \quad \mathbf{Ans}$$

From *Mechanics of Materials*, Sixth Edition by R. C. Hibbeler, ISBN 0-13-191345-X.

© 2005 R. C. Hibbeler. Published by Pearson Prentice Hall,

Pearson Education, Inc., Upper Saddle River, NJ. All rights reserved.

This material is protected under all copyright laws as they currently exist. No portion of this material may be reproduced, in any form or by any means, without permission in writing from the publisher.

***3-8** The stress-strain diagram for a steel bar is shown in the figure. Determine approximately the modulus of elasticity, the proportional limit, the ultimate stress, and the modulus of resilience. If the bar is loaded until it is stressed to 450 MPa, determine the amount of elastic strain recovery and the permanent set or strain in the bar when it is unloaded.

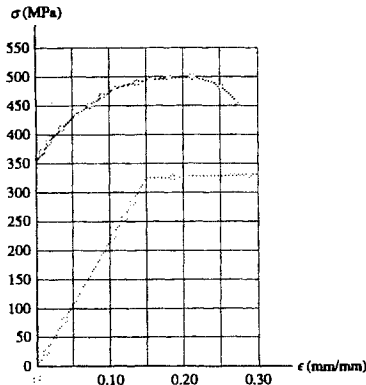

Prob. 3-8

$\sigma_{pl} = 325 \text{ MPa}$ **Ans**

$\sigma_{ult} = 500 \text{ MPa}$ **Ans**

Modulus of elasticity :

$$E = \frac{325(10^6)}{0.0015} = 217 \text{ GPa}$$

Ans

Modulus of resilience

$$u_r = \frac{1}{2}(0.0015 \text{ mm/mm})(325)(10^6) \text{ N/m}^2$$

$$= 244 \text{ kJ/m}^3$$

Ans

$$\text{Elastic recovery} = \frac{450(10^6)}{E} = \frac{450(10^6)}{217(10^9)}$$

$$= 0.00207 \text{ mm/mm}$$

Ans

$$\text{Permanent set} = 0.0750 - 0.00207$$

$$= 0.0729 \text{ mm/mm}$$

Ans

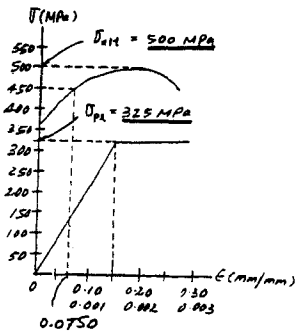

From *Mechanics of Materials*, Sixth Edition by R. C. Hibbeler, ISBN 0-13-191345-X.

© 2005 R. C. Hibbeler. Published by Pearson Prentice Hall,

Pearson Education, Inc., Upper Saddle River, NJ. All rights reserved.

This material is protected under all copyright laws as they currently exist. No portion of this material may be reproduced, in any form or by any means, without permission in writing from the publisher.

3-9 The σ - ϵ diagram for elastic fibers that make up human skin and muscle is shown. Determine the modulus of elasticity of the fibers and estimate their modulus of toughness and modulus of resilience.

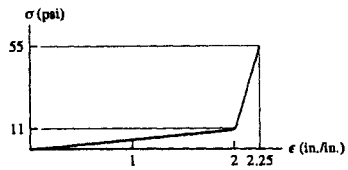

$$E = \frac{11}{2} = 5.5 \text{ psi} \quad \text{Ans}$$

$$u_t = \frac{1}{2}(2)(11) + \frac{1}{2}(55 + 11)(2.25 - 2) = 19.25 \text{ psi} \quad \text{Ans}$$

$$u_r = \frac{1}{2}(2)(11) = 11 \text{ psi} \quad \text{Ans}$$

From *Mechanics of Materials*, Sixth Edition by R. C. Hibbeler, ISBN 0-13-191345-X.

© 2005 R. C. Hibbeler. Published by Pearson Prentice Hall,

Pearson Education, Inc., Upper Saddle River, NJ. All rights reserved.

This material is protected under all copyright laws as they currently exist. No portion of this material may be reproduced, in any form or by any means, without permission in writing from the publisher.

3-10 The stress-strain diagram for a bone is shown, and can be described by the equation $\epsilon = 0.45(10^{-6})\sigma + 0.36(10^{-12})\sigma^3$, where σ is in kPa. Determine the yield strength assuming a 0.3% offset.

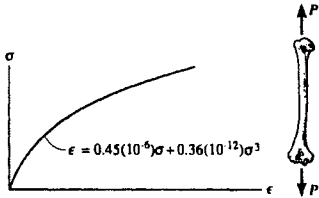

$$\epsilon = 0.45(10^{-6})\sigma + 0.36(10^{-12})\sigma^3$$

For 0.3% = 0.003 mm/mm offset

$$3000 = 0.45\sigma + 0.36(10^{-6})\sigma^3$$

Solving for the real root yields

$$\sigma = 1.82 \text{ MPa} \quad \text{Ans}$$

From *Mechanics of Materials*, Sixth Edition by R. C. Hibbeler, ISBN 0-13-191345-X.

© 2005 R. C. Hibbeler. Published by Pearson Prentice Hall,

Pearson Education, Inc., Upper Saddle River, NJ. All rights reserved.

This material is protected under all copyright laws as they currently exist. No portion of this material may be reproduced, in any form or by any means, without permission in writing from the publisher.

3-11 The stress-strain diagram for a bone is shown and can be described by the equation $\epsilon = 0.45(10^{-6})\sigma + 0.36(10^{-12})\sigma^3$, where σ is in kPa. Determine the modulus of toughness and the amount of elongation of a 200-mm-long region just before it fractures if failure occurs at $\epsilon = 0.12$ mm/mm.

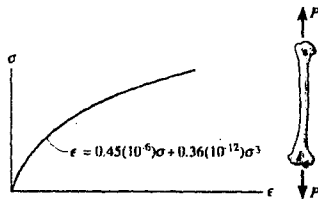

When $\epsilon = 0.12$

$$120(10^{-3}) = 0.45 \sigma + 0.36(10^{-6})\sigma^3$$

Solving for the real root :

$$\sigma = 6873.52 \text{ kPa}$$

$$u_t = \int_A dA = \int_0^{6873.52} (0.12 - \epsilon) d\sigma$$

$$u_t = \int_0^{6873.52} (0.12 - 0.45(10^{-6})\sigma - 0.36(10^{-12})\sigma^3) d\sigma$$

$$= 0.12\sigma - 0.225(10^{-6})\sigma^2 - 0.09(10^{-12})\sigma^4 \Big|_0^{6873.52}$$

$$= 613 \text{ kPa} \quad \text{Ans}$$

$$\delta = \epsilon L = 0.12(200) = 24 \text{ mm} \quad \text{Ans}$$

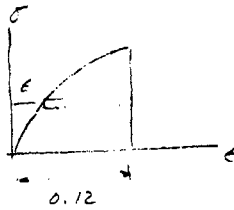

From *Mechanics of Materials*, Sixth Edition by R. C. Hibbeler, ISBN 0-13-191345-X.

© 2005 R. C. Hibbeler. Published by Pearson Prentice Hall,

Pearson Education, Inc., Upper Saddle River, NJ. All rights reserved.

This material is protected under all copyright laws as they currently exist. No portion of this material may be reproduced, in any form or by any means, without permission in writing from the publisher.

***3-12** Fiberglass has a stress-strain diagram as shown. If a 50-mm-diameter bar of length 2 m made from this material is subjected to an axial tensile load of 60 kN, determine its elongation.

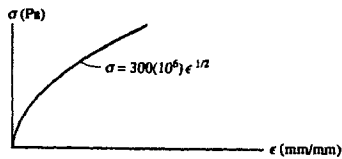

$$\sigma = \frac{P}{A} = \frac{60(10^3)}{\pi(0.025)^2} = 30.558 \text{ MPa}$$

$$\sigma = 300(10^6)\epsilon^{1/2}$$

$$30.558(10^6) = 300(10^6)\epsilon^{1/2}$$

$$\epsilon = 0.010375 \text{ mm/mm}$$

$$\delta = L\epsilon = 2(0.010375) = 0.0208 \text{ m}$$

$$\delta = 20.8 \text{ mm} \quad \text{Ans}$$

From *Mechanics of Materials*, Sixth Edition by R. C. Hibbeler, ISBN 0-13-191345-X.

© 2005 R. C. Hibbeler. Published by Pearson Prentice Hall,

Pearson Education, Inc., Upper Saddle River, NJ. All rights reserved.

This material is protected under all copyright laws as they currently exist. No portion of this material may be reproduced, in any form or by any means, without permission in writing from the publisher.

3-13 Acetal plastic has a stress-strain diagram as shown. If a bar of this material has a length of 3 ft and cross-sectional area of 0.875 in^2 , and is subjected to an axial load of 2.5 kip, determine its elongation.

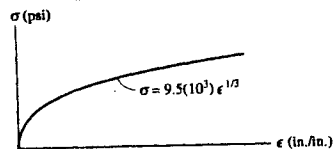

$$\sigma = \frac{P}{A} = \frac{2.5}{0.875} = 2.857 \text{ ksi}$$

$$\sigma = 9.5(10^3) \epsilon^{1/3}$$

$$2.857(10^3) = 9.5(10^3) \epsilon^{1/3}$$

$$\epsilon = 0.0272 \text{ in./in.}$$

$$\delta = L\epsilon = 3(12)(0.0272) = 0.979 \text{ in.} \quad \mathbf{Ans}$$

From *Mechanics of Materials*, Sixth Edition by R. C. Hibbeler, ISBN 0-13-191345-X.

© 2005 R. C. Hibbeler. Published by Pearson Prentice Hall,

Pearson Education, Inc., Upper Saddle River, NJ. All rights reserved.

This material is protected under all copyright laws as they currently exist. No portion of this material may be reproduced, in any form or by any means, without permission in writing from the publisher.

3-14 A specimen is originally 1 ft long, has a diameter of 0.5 in., and is subjected to a force of 500 lb. When the force is increased to 1800 lb, the specimen elongates 0.9 in. Determine the modulus of elasticity for the material if it remains elastic.

$$\sigma_1 = \frac{P}{A} = \frac{500}{\frac{\pi}{4}(0.5)^2} = 2.546 \text{ ksi}$$

$$\sigma_2 = \frac{P}{A} = \frac{1800}{\frac{\pi}{4}(0.5)^2} = 9.167 \text{ ksi}$$

$$\Delta \epsilon = \frac{0.9}{12} = 0.075 \text{ in./in.}$$

$$E = \frac{\Delta \sigma}{\Delta \epsilon} = \frac{9.167 - 2.546}{0.075} = 88.3 \text{ ksi}$$

From *Mechanics of Materials*, Sixth Edition by R. C. Hibbeler, ISBN 0-13-191345-X.

© 2005 R. C. Hibbeler. Published by Pearson Prentice Hall,

Pearson Education, Inc., Upper Saddle River, NJ. All rights reserved.

This material is protected under all copyright laws as they currently exist. No portion of this material may be reproduced, in any form or by any means, without permission in writing from the publisher.

3-15 A structural member in a nuclear reactor is made from a zirconium alloy. If an axial load of 4 kip is to be supported by the member, determine its required cross-sectional area. Use a factor of safety of 3 with respect to yielding. What is the load on the member if it is 3 ft long and its elongation is 0.02 in.? $E_{Zr} = 14(10^3)$ ksi, $\sigma_Y = 57.5$ ksi. The material has elastic behavior.

$$\text{F.S.} = 3 = \frac{\sigma_Y}{\sigma_{\text{allow}}}$$

$$\sigma_{\text{allow}} = \frac{57.5}{3} = 19.17 \text{ ksi}$$

$$\sigma_{\text{allow}} = 19.17 = \frac{4}{A}$$

$$A = 0.209 \text{ in}^2 \quad \text{Ans}$$

$$\epsilon = \frac{\delta}{L} = \frac{0.02}{3(12)} = 0.000555$$

$$\sigma = E\epsilon = 14(10^3)(0.000555) = 7.78 \text{ ksi}$$

$$P = \sigma A = 7.78(0.209) = 1.62 \text{ kip} \quad \text{Ans}$$

From *Mechanics of Materials*, Sixth Edition by R. C. Hibbeler, ISBN 0-13-191345-X.

© 2005 R. C. Hibbeler. Published by Pearson Prentice Hall,

Pearson Education, Inc., Upper Saddle River, NJ. All rights reserved.

This material is protected under all copyright laws as they currently exist. No portion of this material may be reproduced, in any form or by any means, without permission in writing from the publisher.

*3-16 The pole is supported by a pin at C and an A-36 steel guy wire AB. If the wire has a diameter of 0.2 in., determine how much it stretches when a horizontal force of 2.5 kip acts on the pole.

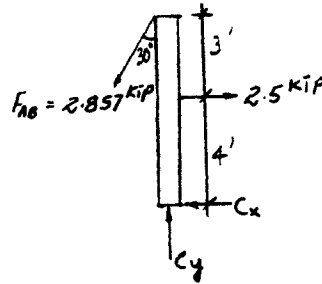
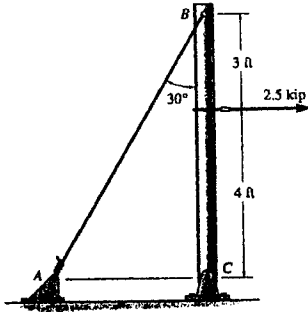

$$\sigma_{AB} = \frac{F_{AB}}{A_{AB}} = \frac{2.857}{\frac{\pi}{4}(0.2^2)} = 90.94 \text{ ksi}$$

$$\epsilon_{AB} = \frac{\sigma_{AB}}{E} = \frac{90.94}{29(10^3)} = 0.003136$$

$$\delta_{AB} = \epsilon_{AB} L_{AB} = 0.003136 \left(\frac{7(12)}{\cos 30^\circ} \right)$$

$$= 0.304 \text{ in.} \quad \text{Ans}$$

From *Mechanics of Materials*, Sixth Edition by R. C. Hibbeler, ISBN 0-13-191345-X.

© 2005 R. C. Hibbeler. Published by Pearson Prentice Hall,

Pearson Education, Inc., Upper Saddle River, NJ. All rights reserved.

This material is protected under all copyright laws as they currently exist. No portion of this material may be reproduced, in any form or by any means, without permission in writing from the publisher.

3-17 The bar DA is rigid and is originally held in the horizontal position when the weight W is supported from C . If the weight causes B to be displaced downward 0.025 in., determine the strain in wires DE and BC . Also, if the wires are made of A-36 steel and have a cross-sectional area of 0.002 in², determine the weight W .

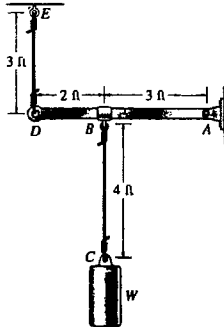

$$\frac{3}{0.025} = \frac{7}{\delta}$$

$$\delta = 0.0417 \text{ in.}$$

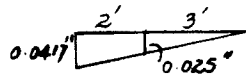

$$\epsilon_{DE} = \frac{\delta}{L} = \frac{0.0417}{3(12)} = 0.00116 \text{ in./in.} \quad \text{Ans}$$

$$\sigma_{DE} = E\epsilon_{DE} = 29(10^3)(0.00116) = 33.56 \text{ ksi}$$

$$F_{DE} = \sigma_{DE}A_{DE} = 33.56(0.002) = 0.0672 \text{ kip}$$

$$\left(\sum M_A = 0; \quad -(0.0672)(5) + 3(W) = 0 \right.$$

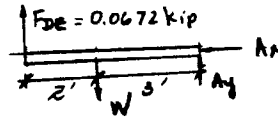

$$W = 0.112 \text{ kip} = 112 \text{ lb} \quad \text{Ans}$$

$$\sigma_{BC} = \frac{W}{A_{BC}} = \frac{0.112}{0.002} = 55.94 \text{ ksi}$$

$$\epsilon_{BC} = \frac{\sigma_{BC}}{E} = \frac{55.94}{29(10^3)} = 0.00193 \text{ in./in.} \quad \text{Ans}$$

From *Mechanics of Materials*, Sixth Edition by R. C. Hibbeler, ISBN 0-13-191345-X.

© 2005 R. C. Hibbeler. Published by Pearson Prentice Hall,

Pearson Education, Inc., Upper Saddle River, NJ. All rights reserved.

This material is protected under all copyright laws as they currently exist. No portion of this material may be reproduced, in any form or by any means, without permission in writing from the publisher.

3-18 The σ - ϵ diagram for a collagen fiber bundle from which a human tendon is composed is shown. If a segment of the Achilles tendon at A has a length of 6.5 in. and an approximate cross-sectional area of 0.229 in², determine its elongation if the foot supports a load of 125 lb, which causes a tension in the tendon of 343.75 lb.

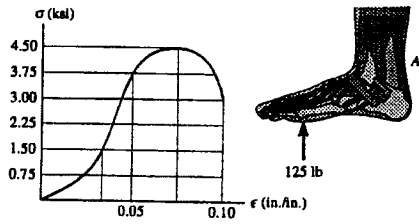

$$\sigma = \frac{P}{A} = \frac{343.75}{0.229} = 1.50 \text{ ksi}$$

From the graph $\epsilon \approx 0.025$ in./in.

$$\delta = \epsilon L = 0.025(6.5) = 0.162 \text{ in.} \quad \text{Ans}$$

From *Mechanics of Materials*, Sixth Edition by R. C. Hibbeler, ISBN 0-13-191345-X.

© 2005 R. C. Hibbeler. Published by Pearson Prentice Hall,

Pearson Education, Inc., Upper Saddle River, NJ. All rights reserved.

This material is protected under all copyright laws as they currently exist. No portion of this material may be reproduced, in any form or by any means, without permission in writing from the publisher.

3-19. The two bars are made of polystyrene, which has the stress-strain diagram shown. If the cross-sectional area of bar AB is 1.5 in^2 and BC is 4 in^2 , determine the largest force P that can be supported before any member ruptures. Assume that buckling does not occur.

$$+\uparrow \Sigma F_y = 0; \quad \frac{3}{5}F_{AB} - P = 0; \quad F_{AB} = 1.6667 P \quad [1]$$

$$+\leftarrow \Sigma F_x = 0; \quad F_{BC} - \frac{4}{5}(1.6667P) = 0; \quad F_{BC} = 1.333 P \quad [2]$$

Assuming failure of bar BC :

From the stress - strain diagram $(\sigma_R)_t = 5 \text{ ksi}$

$$\sigma = \frac{F_{BC}}{A_{BC}}; \quad 5 = \frac{F_{BC}}{4}; \quad F_{BC} = 20.0 \text{ kip}$$

From Eq. [2], $P = 15.0 \text{ kip}$

Assuming failure of bar AB :

From stress - strain diagram $(\sigma_R)_c = 25.0 \text{ ksi}$

$$\sigma = \frac{F_{AB}}{A_{AB}}; \quad 25.0 = \frac{F_{AB}}{1.5}; \quad F_{AB} = 37.5 \text{ kip}$$

From Eq. [1], $P = 22.5 \text{ kip}$

Choose the smallest value

$P = 15.0 \text{ kip}$ **Ans**

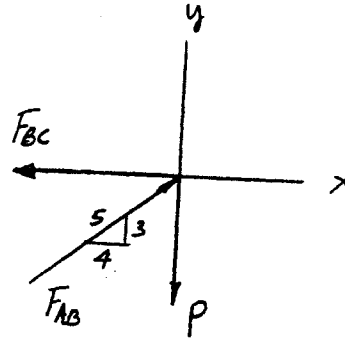

From *Mechanics of Materials*, Sixth Edition by R. C. Hibbeler, ISBN 0-13-191345-X.

© 2005 R. C. Hibbeler. Published by Pearson Prentice Hall,

Pearson Education, Inc., Upper Saddle River, NJ. All rights reserved.

This material is protected under all copyright laws as they currently exist. No portion of this material may be reproduced, in any form or by any means, without permission in writing from the publisher.

***3-20.** The two bars are made of polystyrene, which has the stress-strain diagram shown. Determine the cross-sectional area of each bar so that the bars rupture simultaneously when the load $P = 3$ kip. Assume that buckling does not occur.

$$+\uparrow \Sigma F_y = 0; \quad F_{BA} \left(\frac{3}{5}\right) - 3 = 0; \quad F_{BA} = 5 \text{ kip}$$

$$\rightarrow \Sigma F_x = 0; \quad -F_{BC} + 5\left(\frac{4}{5}\right) = 0; \quad F_{BC} = 4 \text{ kip}$$

For member BC :

$$(\sigma_{\max})_t = \frac{F_{BC}}{A_{BC}}; \quad A_{BC} = \frac{4 \text{ kip}}{5 \text{ ksi}} = 0.8 \text{ in}^2 \quad \text{Ans}$$

For member BA :

$$(\sigma_{\max})_c = \frac{F_{BA}}{A_{BA}}; \quad A_{BA} = \frac{5 \text{ kip}}{25 \text{ ksi}} = 0.2 \text{ in}^2 \quad \text{Ans}$$

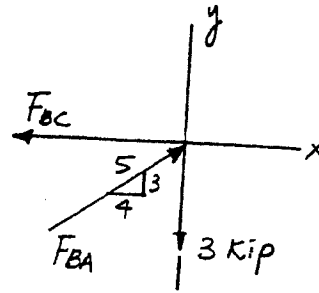

From *Mechanics of Materials*, Sixth Edition by R. C. Hibbeler, ISBN 0-13-191345-X.

© 2005 R. C. Hibbeler. Published by Pearson Prentice Hall,

Pearson Education, Inc., Upper Saddle River, NJ. All rights reserved.

This material is protected under all copyright laws as they currently exist. No portion of this material may be reproduced, in any form or by any means, without permission in writing from the publisher.

3-21 The stress-strain diagram for a polyester resin is given in the figure. If the rigid beam is supported by a strut AB and post CD , both made from this material, and subjected to a load of $P = 80$ kN, determine the angle of tilt of the beam when the load is applied. The diameter of the strut is 40 mm and the diameter of the post is 80 mm.

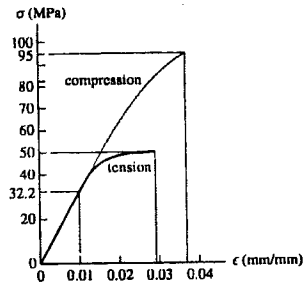
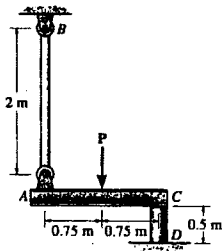

From the stress - strain diagram,

$$E = \frac{32.2(10)^6}{0.01} = 3.22(10^9) \text{ Pa}$$

Thus,

$$\sigma_{AB} = \frac{F_{AB}}{A_{AB}} = \frac{40(10^3)}{\frac{\pi}{4}(0.04)^2} = 31.83 \text{ MPa}$$

$$\epsilon_{AB} = \frac{\sigma_{AB}}{E} = \frac{31.83(10^6)}{3.22(10^9)} = 0.009885 \text{ mm/mm}$$

$$\sigma_{CD} = \frac{F_{CD}}{A_{CD}} = \frac{40(10^3)}{\frac{\pi}{4}(0.08)^2} = 7.958 \text{ MPa}$$

$$\epsilon_{CD} = \frac{\sigma_{CD}}{E} = \frac{7.958(10^6)}{3.22(10^9)} = 0.002471 \text{ mm/mm}$$

$$\delta_{AB} = \epsilon_{AB}L_{AB} = 0.009885(2000) = 19.77 \text{ mm}$$

$$\delta_{CD} = \epsilon_{CD}L_{CD} = 0.002471(500) = 1.236 \text{ mm}$$

Angle of tilt α :

$$\tan \alpha = \frac{18.534}{1500}; \quad \alpha = 0.708^\circ \quad \text{Ans}$$

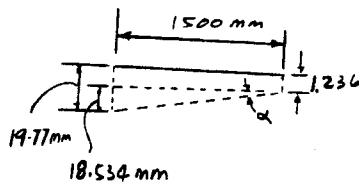
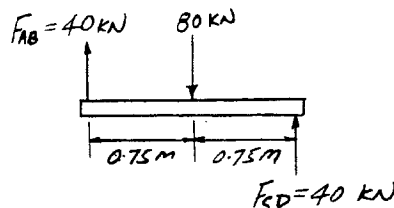

From *Mechanics of Materials*, Sixth Edition by R. C. Hibbeler, ISBN 0-13-191345-X.

© 2005 R. C. Hibbeler. Published by Pearson Prentice Hall,

Pearson Education, Inc., Upper Saddle River, NJ. All rights reserved.

This material is protected under all copyright laws as they currently exist. No portion of this material may be reproduced, in any form or by any means, without permission in writing from the publisher.

3-22 The stress-strain diagram for a polyester resin is given in the figure. If the rigid beam is supported by a strut AB and post CD made from this material, determine the largest load P that can be applied to the beam before it ruptures. The diameter of the strut is 12 mm and the diameter of the post is 40 mm.

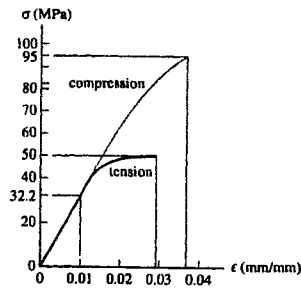
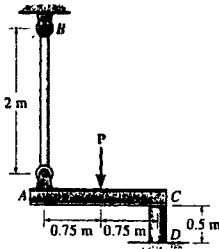

Rupture of strut AB :

$$\sigma_R = \frac{F_{AB}}{A_{AB}}; \quad 50(10^6) = \frac{P/2}{\frac{\pi}{4}(0.012)^2};$$

$$P = 11.3 \text{ kN (controls)}$$

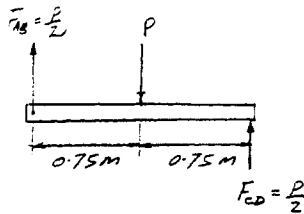

Ans

Rupture of post CD :

$$\sigma_R = \frac{F_{CD}}{A_{CD}}; \quad 95(10^6) = \frac{P/2}{\frac{\pi}{4}(0.04)^2}$$

$$P = 239 \text{ kN}$$

From *Mechanics of Materials*, Sixth Edition by R. C. Hibbeler, ISBN 0-13-191345-X.

© 2005 R. C. Hibbeler. Published by Pearson Prentice Hall,

Pearson Education, Inc., Upper Saddle River, NJ. All rights reserved.

This material is protected under all copyright laws as they currently exist. No portion of this material may be reproduced, in any form or by any means, without permission in writing from the publisher.

3-23 The pipe is supported by a pin at C and an A-36 steel guy wire AB. If the wire has a diameter of 0.2 in., determine how much it stretches when a distributed load of $w = 100 \text{ lb/ft}$ acts on the pipe. The material remains elastic.

$$+\Sigma M_C = 0; \quad F_{AB} \sin 30^\circ (10) - 0.1(10)(5) = 0;$$

$$F_{AB} = 1.0 \text{ kip}$$

$$\sigma_{AB} = \frac{F_{AB}}{A_{AB}} = \frac{1.0}{\frac{\pi}{4}(0.2)^2} = 31.83 \text{ ksi}$$

$$\sigma = E \epsilon; \quad 31.83 = 29(10^3) \epsilon_{AB}; \quad \epsilon_{AB} = 0.0010981 \text{ in./in.}$$

$$\delta_{AB} = \epsilon_{AB} L_{AB} = 0.0010981 \left(\frac{120}{\cos 30^\circ} \right) = 0.152 \text{ in.} \quad \text{Ans}$$

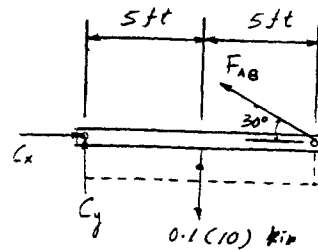
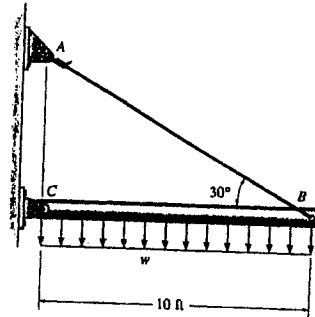

From *Mechanics of Materials*, Sixth Edition by R. C. Hibbeler, ISBN 0-13-191345-X.

© 2005 R. C. Hibbeler. Published by Pearson Prentice Hall,

Pearson Education, Inc., Upper Saddle River, NJ. All rights reserved.

This material is protected under all copyright laws as they currently exist. No portion of this material may be reproduced, in any form or by any means, without permission in writing from the publisher.

*3-24 The pipe is supported by a pin at C and an A-36 steel guy wire AB. If the wire has a diameter of 0.2 in., determine the distributed load w if the end B is displaced 0.75 in. downward.

$$\sin \theta = \frac{0.0625}{10}; \quad \theta = 0.3581^\circ$$

$$\alpha = 90 + 0.3581^\circ = 90.3581^\circ$$

$$AB = \frac{10}{\cos 30^\circ} = 11.5470 \text{ ft}$$

$$AB' = \sqrt{10^2 + 5.7735^2 - 2(10)(5.7735)\cos 90.3581^\circ} = 11.5782 \text{ ft}$$

$$\epsilon_{AB} = \frac{AB' - AB}{AB} = \frac{11.5782 - 11.5470}{11.5470} = 0.002703 \text{ in./in.}$$

$$\sigma_{AB} = E \epsilon_{AB} = 29(10^3)(0.002703) = 78.38 \text{ ksi}$$

$$F_{AB} = \sigma_{AB} A_{AB} = 78.38 \left(\frac{\pi}{4}\right)(0.2)^2 = 2.462 \text{ kip}$$

$$+\Sigma M_C = 0; \quad 2.462 \sin 30^\circ(10) - 10w(5) = 0;$$

$$w = 0.246 \text{ kip/ft} \quad \text{Ans}$$

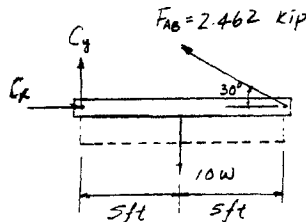
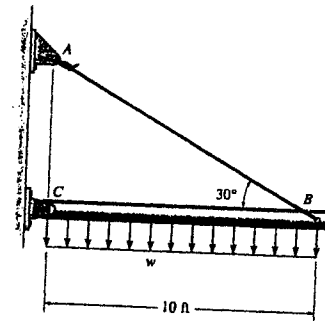
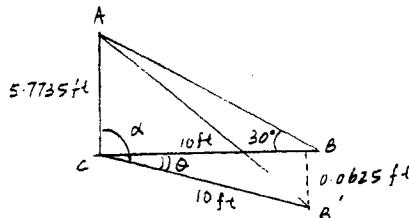

From *Mechanics of Materials*, Sixth Edition by R. C. Hibbeler, ISBN 0-13-191345-X.

© 2005 R. C. Hibbeler. Published by Pearson Prentice Hall,

Pearson Education, Inc., Upper Saddle River, NJ. All rights reserved.

This material is protected under all copyright laws as they currently exist. No portion of this material may be reproduced, in any form or by any means, without permission in writing from the publisher.

3-25 The stress-strain diagram for many metal alloys can be described analytically using the Ramberg-Osgood three parameter equation $\epsilon = \sigma/E + k\sigma^n$, where E , k , and n are determined from measurements taken from the diagram. Using the stress-strain diagram shown in the figure, take $E = 30(10^3)$ ksi and determine the other two parameters k and n and thereby obtain an analytical expression for the curve.

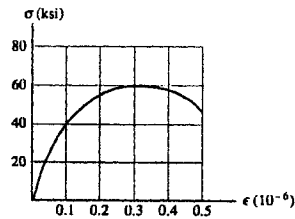

Choose,

$$\sigma = 40 \text{ ksi}, \quad \epsilon = 0.1$$

$$\sigma = 60 \text{ ksi}, \quad \epsilon = 0.3$$

$$0.1 = \frac{40}{30(10^3)} + k(40)^n$$

$$0.3 = \frac{60}{30(10^3)} + k(60)^n$$

$$0.098667 = k(40)^n$$

$$0.29800 = k(60)^n$$

$$0.3310962 = (0.6667)^n$$

$$\ln(0.3310962) = n \ln(0.6667)$$

$$n = 2.73 \quad \text{Ans}$$

$$k = 4.23(10^{-6}) \quad \text{Ans}$$

From *Mechanics of Materials*, Sixth Edition by R. C. Hibbeler, ISBN 0-13-191345-X.

© 2005 R. C. Hibbeler. Published by Pearson Prentice Hall,

Pearson Education, Inc., Upper Saddle River, NJ. All rights reserved.

This material is protected under all copyright laws as they currently exist. No portion of this material may be reproduced, in any form or by any means, without permission in writing from the publisher.

3-26 The acrylic plastic rod is 200 mm long and 15 mm in diameter. If an axial load of 300 N is applied to it, determine the change in its length and the change in its diameter. $E_p = 2.70$ GPa, $\nu_p = 0.4$.

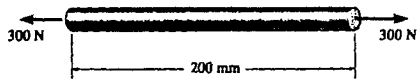

$$\sigma = \frac{P}{A} = \frac{300}{\frac{\pi}{4}(0.015)^2} = 1.697 \text{ MPa}$$

$$\epsilon_{\text{long}} = \frac{\sigma}{E} = \frac{1.697(10^6)}{2.70(10^9)} = 0.0006288$$

$$\delta = \epsilon_{\text{long}} L = 0.0006288 (200) = 0.126 \text{ mm} \quad \mathbf{Ans}$$

$$\epsilon_{\text{lat}} = -\nu \epsilon_{\text{long}} = -0.4 (0.0006288) = -0.0002515$$

$$\Delta d = \epsilon_{\text{lat}} d = -0.0002515 (15) = -0.00377 \text{ mm} \quad \mathbf{Ans}$$

From *Mechanics of Materials*, Sixth Edition by R. C. Hibbeler, ISBN 0-13-191345-X.

© 2005 R. C. Hibbeler. Published by Pearson Prentice Hall,

Pearson Education, Inc., Upper Saddle River, NJ. All rights reserved.

This material is protected under all copyright laws as they currently exist. No portion of this material may be reproduced, in any form or by any means, without permission in writing from the publisher.

3-27 The short cylindrical block of 2014-T6 aluminum, having an original diameter of 0.5 in. and a length of 1.5 in., is placed in the smooth jaws of a vise and squeezed until the axial load applied is 800 lb. Determine (a) the decrease in its length and (b) its new diameter.

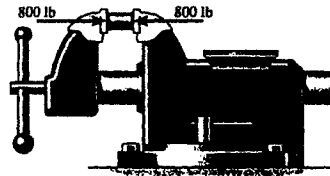

a)

$$\sigma = \frac{P}{A} = \frac{800}{\frac{\pi}{4}(0.5)^2} = 4074.37 \text{ psi}$$

$$\epsilon_{\text{long}} = \frac{\sigma}{E} = \frac{-4074.37}{10.6(10^6)} = -0.0003844$$

$$\delta = \epsilon_{\text{long}} L = -0.0003844 (1.5) = -0.577 (10^{-3}) \text{ in.} \quad \text{Ans}$$

b)

$$\nu = \frac{-\epsilon_{\text{lat}}}{\epsilon_{\text{long}}} = 0.35$$

$$\epsilon_{\text{lat}} = -0.35 (-0.0003844) = 0.00013453$$

$$\Delta d = \epsilon_{\text{lat}} d = 0.00013453 (0.5) = 0.00006727$$

$$d' = d + \Delta d = 0.5000673 \text{ in.} \quad \text{Ans}$$

From *Mechanics of Materials*, Sixth Edition by R. C. Hibbeler, ISBN 0-13-191345-X.

© 2005 R. C. Hibbeler. Published by Pearson Prentice Hall,

Pearson Education, Inc., Upper Saddle River, NJ. All rights reserved.

This material is protected under all copyright laws as they currently exist. No portion of this material may be reproduced, in any form or by any means, without permission in writing from the publisher.

***3-28** A short cylindrical block of bronze C86100, having an original diameter of 1.5 in. and a length of 3 in., is placed in a compression machine and squeezed until its length becomes 2.98 in. Determine the new diameter of the block.

$$\epsilon_{\text{long}} = \frac{-0.02}{3} = -0.0066667 \text{ in./in.}$$

$$\epsilon_{\text{lat}} = -\nu\epsilon_{\text{long}} = -0.34(-0.0066667) = 0.0022667 \text{ in./in.}$$

$$\Delta d = \epsilon_{\text{lat}}d = 0.0022667(1.5) = 0.0034 \text{ in.}$$

$$d' = d + \Delta d = 1.5 + 0.0034 = 1.5034 \text{ in.} \quad \mathbf{Ans}$$

From *Mechanics of Materials*, Sixth Edition by R. C. Hibbeler, ISBN 0-13-191345-X.

© 2005 R. C. Hibbeler. Published by Pearson Prentice Hall,

Pearson Education, Inc., Upper Saddle River, NJ. All rights reserved.

This material is protected under all copyright laws as they currently exist. No portion of this material may be reproduced, in any form or by any means, without permission in writing from the publisher.

3-29. The support consists of three rigid plates, which are connected together using two symmetrically placed rubber pads. If a vertical force of 50 N is applied to plate A, determine the approximate vertical displacement of this plate due to shear strains in the rubber. Each pad has cross-sectional dimensions of 30 mm and 20 mm. $G_r = 0.20$ MPa.

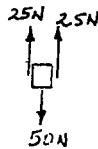
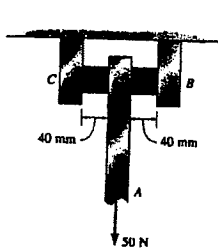

$$\tau_{\text{avg}} = \frac{V}{A} = \frac{25}{(0.03)(0.02)} = 41666.67 \text{ Pa}$$

$$\gamma = \frac{\tau}{G} = \frac{41666.67}{0.2 (10^6)} = 0.2083 \text{ rad}$$

$$\delta = 40 (0.2083) = 8.33 \text{ mm} \quad \text{Ans}$$

From *Mechanics of Materials*, Sixth Edition by R. C. Hibbeler, ISBN 0-13-191345-X.

© 2005 R. C. Hibbeler. Published by Pearson Prentice Hall,

Pearson Education, Inc., Upper Saddle River, NJ. All rights reserved.

This material is protected under all copyright laws as they currently exist. No portion of this material may be reproduced, in any form or by any means, without permission in writing from the publisher.

3-30. A shear spring is made from two blocks of rubber, each having a height h , width b , and thickness a . The blocks are bonded to three plates as shown. If the plates are rigid and the shear modulus of the rubber is G , determine the displacement of plate A if a vertical load \mathbf{P} is applied to this plate. Assume that the displacement is small so that $\delta = a \tan \gamma \approx a\gamma$.

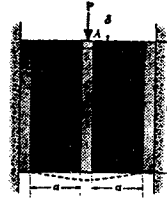

Average Shear Stress : The rubber block is subjected to a shear force of $V = \frac{P}{2}$.

$$\tau = \frac{V}{A} = \frac{\frac{P}{2}}{bh} = \frac{P}{2bh}$$

Shear Strain : Applying Hooke's law for shear

$$\gamma = \frac{\tau}{G} = \frac{\frac{P}{2bh}}{G} = \frac{P}{2bhG}$$

Thus,

$$\delta = a\gamma = \frac{Pa}{2bhG}$$

Ans

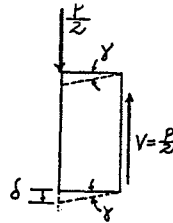

From *Mechanics of Materials*, Sixth Edition by R. C. Hibbeler, ISBN 0-13-191345-X.
 © 2005 R. C. Hibbeler. Published by Pearson Prentice Hall,
 Pearson Education, Inc., Upper Saddle River, NJ. All rights reserved.
 This material is protected under all copyright laws as they currently exist. No portion of this material may be reproduced, in any form or by any means, without permission in writing from the publisher.

3-31. A shear spring is made by bonding the rubber annulus to a rigid fixed ring and a plug. When an axial load P is placed on the plug, show that the slope at point y in the rubber is $dy/dr = -\tan\gamma = -\tan(P/(2\pi hGr))$. For small angles we can write $dy/dr = -P/(2\pi hGr)$. Integrate this expression and evaluate the constant of integration using the condition that $y = 0$ at $r = r_o$. From the result compute the deflection $y = \delta$ of the plug.

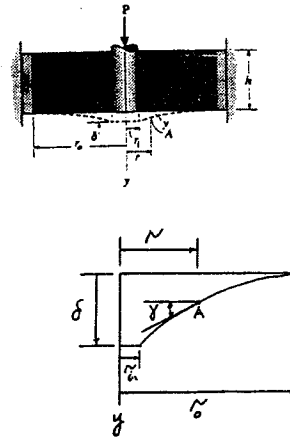

Shear Stress - Strain Relationship : Applying Hooke's law with

$$\tau_A = \frac{P}{2\pi r h}$$

$$\gamma = \frac{\tau_A}{G} = \frac{P}{2\pi h G r}$$

$$\frac{dy}{dr} = -\tan\gamma = -\tan\left(\frac{P}{2\pi h G r}\right) \quad (Q. E. D)$$

If γ is small, then $\tan\gamma = \gamma$. Therefore,

$$\begin{aligned} \frac{dy}{dr} &= -\frac{P}{2\pi h G r} \\ y &= -\frac{P}{2\pi h G} \int \frac{dr}{r} \\ y &= -\frac{P}{2\pi h G} \ln r + C \end{aligned}$$

$$\text{At } r = r_o, \quad y = 0$$

$$0 = -\frac{P}{2\pi h G} \ln r_o + C$$

$$C = \frac{P}{2\pi h G} \ln r_o$$

$$\text{Then,} \quad y = \frac{P}{2\pi h G} \ln \frac{r_o}{r}$$

$$\text{At } r = r_i, \quad y = \delta$$

$$\delta = \frac{P}{2\pi h G} \ln \frac{r_o}{r_i}$$

Ans

From *Mechanics of Materials*, Sixth Edition by R. C. Hibbeler, ISBN 0-13-191345-X.

© 2005 R. C. Hibbeler. Published by Pearson Prentice Hall,

Pearson Education, Inc., Upper Saddle River, NJ. All rights reserved.

This material is protected under all copyright laws as they currently exist. No portion of this material may be reproduced, in any form or by any means, without permission in writing from the publisher.

*3-32 The aluminum block has a rectangular cross section and is subjected to an axial compressive force of 8 kip. If the 1.5-in. side changed its length to 1.500132 in., determine Poisson's ratio and the new length of the 2-in. side. $E_{al} = 10(10^3)$ ksi.

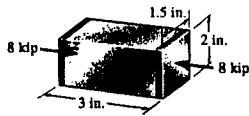

$$\sigma = \frac{P}{A} = \frac{8}{(2)(1.5)} = 2.667 \text{ ksi}$$

$$\epsilon_{\text{long}} = \frac{\sigma}{E} = \frac{-2.667}{10(10^3)} = -0.0002667$$

$$\epsilon_{\text{lat}} = \frac{1.500132 - 1.5}{1.5} = 0.0000880$$

$$\nu = \frac{-0.0000880}{-0.0002667} = 0.330 \quad \text{Ans}$$

$$h' = 2 + 0.0000880(2) = 2.000176 \text{ in.} \quad \text{Ans}$$

From *Mechanics of Materials*, Sixth Edition by R. C. Hibbeler, ISBN 0-13-191345-X.

© 2005 R. C. Hibbeler. Published by Pearson Prentice Hall,

Pearson Education, Inc., Upper Saddle River, NJ. All rights reserved.

This material is protected under all copyright laws as they currently exist. No portion of this material may be reproduced, in any form or by any means, without permission in writing from the publisher.

3-33 The plug, has a diameter of 30 mm and fits within a rigid sleeve having an inner diameter of 32 mm. Both the plug and the sleeve are 50 mm long. Determine the axial pressure p that must be applied to the top of the plug to cause it to contact the sides of the sleeve. Also, how far must the plug be compressed downward in order to do this? The plug is made from a material for which $E = 5 \text{ MPa}$, $\nu = 0.45$.

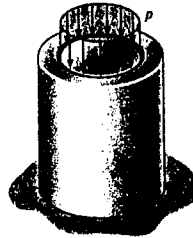

$$\epsilon_{\text{lat}} = \frac{d' - d}{d} = \frac{32 - 30}{30} = 0.06667 \text{ mm/mm}$$

$$\nu = -\frac{\epsilon_{\text{lat}}}{\epsilon_{\text{long}}}; \quad \epsilon_{\text{long}} = -\frac{\epsilon_{\text{lat}}}{\nu} = -\frac{0.06667}{0.45} = -0.1481 \text{ mm/mm}$$

$$p = \sigma = E \epsilon_{\text{long}} = 5(10^6)(0.1481) = 741 \text{ kPa} \quad \text{Ans}$$

$$\delta = |\epsilon_{\text{long}} L| = |-0.1481(50)| = 7.41 \text{ mm} \quad \text{Ans}$$

From *Mechanics of Materials*, Sixth Edition by R. C. Hibbeler, ISBN 0-13-191345-X.

© 2005 R. C. Hibbeler. Published by Pearson Prentice Hall,

Pearson Education, Inc., Upper Saddle River, NJ. All rights reserved.

This material is protected under all copyright laws as they currently exist. No portion of this material may be reproduced, in any form or by any means, without permission in writing from the publisher.

3-34 The rubber block is subjected to an elongation of 0.03 in. along the x axis, and its vertical faces are given a tilt so that $\theta = 89.3^\circ$. Determine the strains ϵ_x , ϵ_y and γ_{xy} . Take $\nu_r = 0.5$.

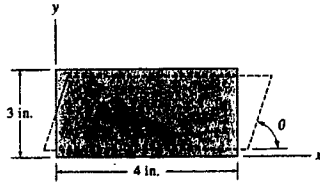

$$\epsilon_x = \frac{\delta L}{L} = \frac{0.03}{4} = 0.0075 \text{ in./in.} \quad \text{Ans}$$

$$\epsilon_y = -\nu \epsilon_x = -0.5(0.0075) = -0.00375 \text{ in./in.} \quad \text{Ans}$$

$$\gamma_{xy} = \frac{\pi}{2} - \theta = \frac{\pi}{2} - 89.3^\circ \left(\frac{\pi}{180^\circ} \right) = 0.0122 \text{ rad} \quad \text{Ans}$$

From *Mechanics of Materials*, Sixth Edition by R. C. Hibbeler, ISBN 0-13-191345-X.

© 2005 R. C. Hibbeler. Published by Pearson Prentice Hall,

Pearson Education, Inc., Upper Saddle River, NJ. All rights reserved.

This material is protected under all copyright laws as they currently exist. No portion of this material may be reproduced, in any form or by any means, without permission in writing from the publisher.

3-35 The elastic portion of the tension stress-strain diagram for an aluminum alloy is shown in the figure. The specimen used for the test has a gauge length of 2 in. and a diameter of 0.5 in. When the applied load is 9 kip, the new diameter of the specimen is 0.49935 in. Compute the shear modulus G_{al} for the aluminum.

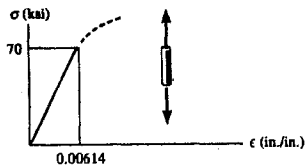

From the stress - strain diagram,

$$E_{al} = \frac{\sigma}{\epsilon} = \frac{70}{0.00614} = 11400.65 \text{ ksi}$$

When specimen is loaded with a 9 - kip load,

$$\sigma = \frac{P}{A} = \frac{9}{\frac{\pi}{4}(0.5)^2} = 45.84 \text{ ksi}$$

$$\epsilon_{long} = \frac{\sigma}{E} = \frac{45.84}{11400.65} = 0.0040208 \text{ in./in.}$$

$$\epsilon_{lat} = \frac{d' - d}{d} = \frac{0.49935 - 0.5}{0.5} = -0.0013 \text{ in./in.}$$

$$\nu = -\frac{\epsilon_{lat}}{\epsilon_{long}} = -\frac{-0.0013}{0.0040208} = 0.32332$$

$$G_{al} = \frac{E_{al}}{2(1 + \nu)} = \frac{11.4(10^3)}{2(1 + 0.32332)} = 4.31(10^3) \text{ ksi} \quad \mathbf{Ans}$$

From *Mechanics of Materials*, Sixth Edition by R. C. Hibbeler, ISBN 0-13-191345-X.

© 2005 R. C. Hibbeler. Published by Pearson Prentice Hall,

Pearson Education, Inc., Upper Saddle River, NJ. All rights reserved.

This material is protected under all copyright laws as they currently exist. No portion of this material may be reproduced, in any form or by any means, without permission in writing from the publisher.

*3-36 The elastic portion of the tension stress-strain diagram for an aluminum alloy is shown in the figure. The specimen used for the test has a gauge length of 2 in. and a diameter of 0.5 in. If the applied load is 10 kip determine the new diameter of the specimen. The shear modulus is $G_M = 3.8(10^3)$ ksi.

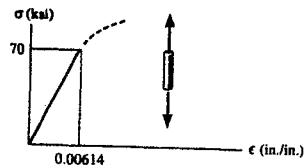

$$\sigma = \frac{P}{A} = \frac{10}{\frac{\pi}{4}(0.5)^2} = 50.9296 \text{ ksi}$$

From the stress - strain diagram

$$E = \frac{70}{0.00614} = 11400.65 \text{ ksi}$$

$$\epsilon_{\text{long}} = \frac{\sigma}{E} = \frac{50.9296}{11400.65} = 0.0044673 \text{ in./in.}$$

$$G = \frac{E}{2(1 + \nu)}; \quad 3.8(10^3) = \frac{11400.65}{2(1 + \nu)}; \quad \nu = 0.500$$

$$\epsilon_{\text{lat}} = -\nu\epsilon_{\text{long}} = -0.500(0.0044673) = -0.002234 \text{ in./in.}$$

$$\Delta d = \epsilon_{\text{lat}}d = -0.002234(0.5) = -0.001117 \text{ in.}$$

$$d' = d + \Delta d = 0.5 - 0.001117 = 0.4989 \text{ in.} \quad \text{Ans}$$

From *Mechanics of Materials*, Sixth Edition by R. C. Hibbeler, ISBN 0-13-191345-X.

© 2005 R. C. Hibbeler. Published by Pearson Prentice Hall,

Pearson Education, Inc., Upper Saddle River, NJ. All rights reserved.

This material is protected under all copyright laws as they currently exist. No portion of this material may be reproduced, in any form or by any means, without permission in writing from the publisher.

3-37 The rigid beam rests in the horizontal position on two 2014-T6 aluminum cylinders having the *unloaded* lengths shown. If each cylinder has a diameter of 30 mm, determine the placement x of the applied 80-kN load so that the beam remains horizontal. What is the new diameter of cylinder A after the load is applied? $\nu_{al} = 0.35$.

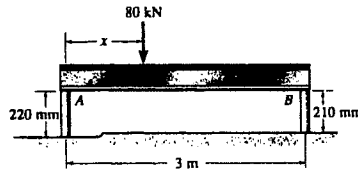

$$\left(+ \sum M_A = 0; \quad F_B(3) - 80(x) = 0; \quad F_B = \frac{80x}{3} \quad (1) \right.$$

$$\left(+ \sum M_B = 0; \quad -F_A(3) + 80(3-x) = 0; \quad F_A = \frac{80(3-x)}{3} \quad (2) \right.$$

Since the beam is held horizontally, $\delta_A = \delta_B$

$$\sigma = \frac{P}{A}; \quad \epsilon = \frac{\sigma}{E} = \frac{P}{EA}$$

$$\delta = \epsilon L = \left(\frac{P}{EA} \right) L = \frac{PL}{AE}$$

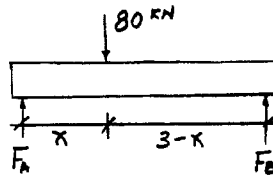

$$\delta_A = \delta_B; \quad \frac{80(3-x)(220)}{3AE} = \frac{80x(210)}{3AE}$$

$$80(3-x)(220) = 80x(210)$$

$$x = 1.53 \text{ m}$$

Ans

From Eq. (2),

$$F_A = 39.07 \text{ kN}$$

$$\sigma_A = \frac{F_A}{A} = \frac{39.07(10^3)}{\frac{\pi}{4}(0.03^2)} = 55.27 \text{ MPa}$$

$$\epsilon_{\text{long}} = \frac{\sigma_A}{E} = \frac{55.27(10^6)}{73.1(10^9)} = -0.000756$$

$$\epsilon_{\text{lat}} = -\nu \epsilon_{\text{long}} = -0.35(-0.000756) = 0.0002646$$

$$d'_A = d_A + d \epsilon_{\text{lat}} = 30 + 30(0.0002646) = 30.008 \text{ mm} \quad \text{Ans}$$

From *Mechanics of Materials*, Sixth Edition by R. C. Hibbeler, ISBN 0-13-191345-X.

© 2005 R. C. Hibbeler. Published by Pearson Prentice Hall,

Pearson Education, Inc., Upper Saddle River, NJ. All rights reserved.

This material is protected under all copyright laws as they currently exist. No portion of this material may be reproduced, in any form or by any means, without permission in writing from the publisher.

3-38 A short cylindrical block of 6061-T6 aluminum, having an original diameter of 20 mm and a length of 75 mm, is placed in a compression machine and squeezed until the axial load applied is 5 kN. Determine (a) the decrease in its length and (b) its new diameter.

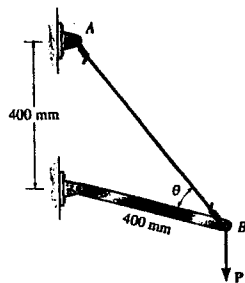

$$a) \quad \sigma = \frac{P}{A} = \frac{-5(10^3)}{\frac{\pi}{4}(0.02)^2} = -15.915 \text{ MPa}$$

$$\sigma = E \epsilon_{\text{long}}; \quad -15.915(10^6) = 68.9(10^9)\epsilon_{\text{long}}$$

$$\epsilon_{\text{long}} = -0.0002310 \text{ mm/mm}$$

$$\delta = \epsilon_{\text{long}} L = -0.0002310(75) = -0.0173 \text{ mm} \quad \text{Ans}$$

$$b) \quad \nu = -\frac{\epsilon_{\text{lat}}}{\epsilon_{\text{long}}}; \quad 0.35 = -\frac{\epsilon_{\text{lat}}}{-0.0002310}$$

$$\epsilon_{\text{lat}} = 0.00008085 \text{ mm/mm}$$

$$\Delta d = \epsilon_{\text{lat}} d = 0.00008085(20) = 0.0016 \text{ mm}$$

$$d' = d + \Delta d = 20 + 0.0016 = 20.0016 \text{ mm} \quad \text{Ans}$$

From *Mechanics of Materials*, Sixth Edition by R. C. Hibbeler, ISBN 0-13-191345-X.

© 2005 R. C. Hibbeler. Published by Pearson Prentice Hall,

Pearson Education, Inc., Upper Saddle River, NJ. All rights reserved.

This material is protected under all copyright laws as they currently exist. No portion of this material may be reproduced, in any form or by any means, without permission in writing from the publisher.

3-39 The A-36 steel wire AB has a cross-sectional area of 10 mm^2 and is unstretched when $\theta = 45.0^\circ$. Determine the applied load P needed to cause $\theta = 44.9^\circ$.

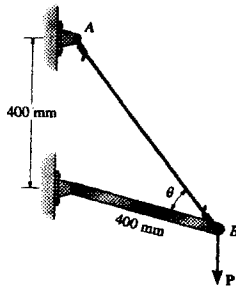

$$\frac{L'_{AB}}{\sin 90.2^\circ} = \frac{400}{\sin 44.9^\circ}$$

$$L'_{AB} = 566.67 \text{ mm}$$

$$L_{AB} = \frac{400}{\sin 45^\circ} = 565.69$$

$$\epsilon = \frac{L'_{AB} - L_{AB}}{L_{AB}} = \frac{566.67 - 565.69}{565.69} = 0.001744$$

$$\sigma = E\epsilon = 200(10^9)(0.001744) = 348.76 \text{ MPa}$$

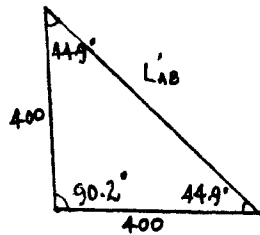

$$\curvearrowleft + \Sigma M_A = 0$$

$$P(400 \cos 0.2^\circ) - F_{AB} \sin 44.9^\circ (400) = 0 \quad (1)$$

However,

$$F_{AB} = \sigma A = 348.76 (10^6)(10)(10^{-6}) = 3.488 \text{ kN}$$

From Eq. (1),

$$P = 2.46 \text{ kN} \quad \text{Ans}$$

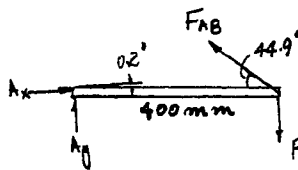

From *Mechanics of Materials*, Sixth Edition by R. C. Hibbeler, ISBN 0-13-191345-X.

© 2005 R. C. Hibbeler. Published by Pearson Prentice Hall,

Pearson Education, Inc., Upper Saddle River, NJ. All rights reserved.

This material is protected under all copyright laws as they currently exist. No portion of this material may be reproduced, in any form or by any means, without permission in writing from the publisher.

***3-40** While undergoing a tension test, a copper-alloy specimen having a gauge length of 2 in. is subjected to a strain of 0.40 in./in. when the stress is 70 ksi. If $\sigma_Y = 45$ ksi when $\epsilon_Y = 0.0025$ in./in., determine the distance between the gauge points when the load is released.

$$\text{Elastic recovery} = 70 \frac{(0.0025)}{45} = 0.0038889 \text{ in./in.}$$

$$\text{Permanent set} = 0.4 - 0.0038889 = 0.3961 \text{ in./in.}$$

$$\delta = 0.3961(2) = 0.792 \text{ in.}$$

$$L = 2 + 0.792 = 2.792 \text{ in.} \quad \mathbf{Ans}$$

From *Mechanics of Materials*, Sixth Edition by R. C. Hibbeler, ISBN 0-13-191345-X.

© 2005 R. C. Hibbeler. Published by Pearson Prentice Hall,

Pearson Education, Inc., Upper Saddle River, NJ. All rights reserved.

This material is protected under all copyright laws as they currently exist. No portion of this material may be reproduced, in any form or by any means, without permission in writing from the publisher.

3-41 The stress-strain diagram for polyethylene, which is used to sheath coaxial cables, is determined from testing a specimen that has a gauge length of 10 in. If a load P on the specimen develops a strain of $\epsilon = 0.024$ in./in., determine the approximate length of the specimen, measured between the gauge points, when the load is removed. Assume the specimen recovers elastically.

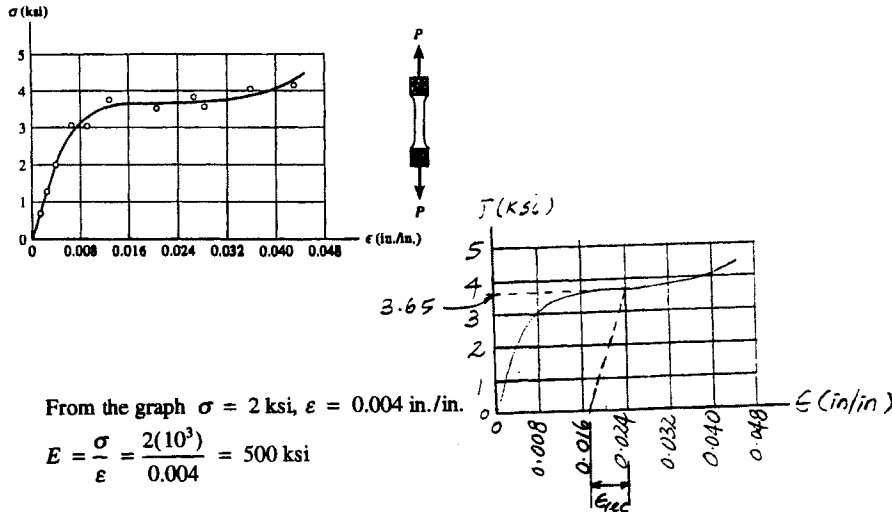

From the graph $\sigma = 2$ ksi, $\epsilon = 0.004$ in./in.

$$E = \frac{\sigma}{\epsilon} = \frac{2(10^3)}{0.004} = 500 \text{ ksi}$$

$$\epsilon = 0.024 \text{ in./in.}, \sigma \approx 3.65 \text{ ksi}$$

$$L' = 10 \text{ in.} + 0.024(10) = 10.24 \text{ in.}$$

Elastic strain recovery :

$$\epsilon_{rec} = \frac{\sigma}{E} = \frac{3.65 \text{ ksi}}{500 \text{ ksi}} = 0.0073 \text{ in./in.}$$

$$\delta = L \epsilon_{rec} = 10(0.0073) = 0.073 \text{ in.}$$

$$L = L' - \delta = 10.24 \text{ in.} - 0.073 \text{ in.} = 10.17 \text{ in.} \quad \text{Ans}$$

From *Mechanics of Materials*, Sixth Edition by R. C. Hibbeler, ISBN 0-13-191345-X.

© 2005 R. C. Hibbeler. Published by Pearson Prentice Hall,

Pearson Education, Inc., Upper Saddle River, NJ. All rights reserved.

This material is protected under all copyright laws as they currently exist. No portion of this material may be reproduced, in any form or by any means, without permission in writing from the publisher.

3-42 A tension test was performed on a steel specimen having an original diameter of 12.5 mm and a gauge length of 50 mm. The data is listed in the table. Plot the stress-strain diagram and determine approximately the modulus of elasticity, the ultimate stress, and the rupture stress. Use a scale of 20 mm = 50 MPa and 20 mm = 0.05 mm/mm. Redraw the linear-elastic region, using the same stress scale but a strain scale of 20 mm = 0.001 mm/mm.

Load (kN)	Elongation (mm)
0	0
11.1	0.0175
31.9	0.0600
37.8	0.1020
40.9	0.1650
43.6	0.2490
33.4	1.0160
62.3	3.0480
64.5	6.3500
62.3	8.8900
58.8	11.9380

$$A = \frac{1}{4}\pi(0.0125)^2 = 0.12272(10)^{-3} \text{ m}^2$$

$$E_{\text{approx}} = \frac{125(10^6)}{0.0005} = 250 \text{ GPa} \quad \text{Ans}$$

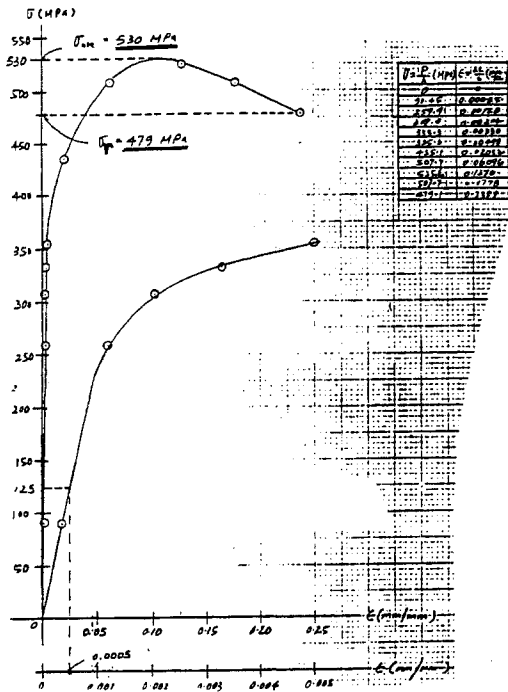

From *Mechanics of Materials*, Sixth Edition by R. C. Hibbeler, ISBN 0-13-191345-X.
 © 2005 R. C. Hibbeler. Published by Pearson Prentice Hall,
 Pearson Education, Inc., Upper Saddle River, NJ. All rights reserved.
 This material is protected under all copyright laws as they currently exist. No portion of this material may be reproduced, in any form or by any means, without permission in writing from the publisher.

3-43 A tension test was performed on a steel specimen having an original diameter of 12.5 mm and a gauge length of 50 mm. Using the data listed in the table, plot the stress-strain diagram and determine approximately the modulus of toughness. Use a scale of 20 mm = 50 MPa and 20 mm = 0.05 mm/mm.

Load (kN)	Elongation (mm)
0	0
11.1	0.0175
31.9	0.0600
37.8	0.1020
40.9	0.1650
43.6	0.2490
53.4	1.0160
62.3	3.0480
64.5	6.3500
62.3	8.8900
58.8	11.9380

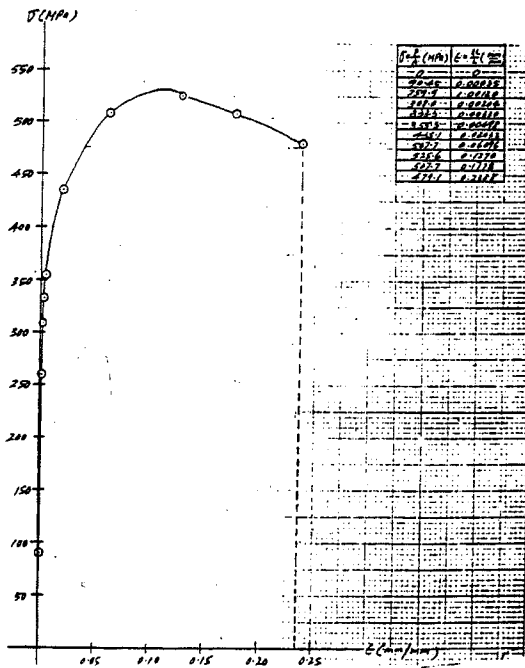

The modulus of toughness = Total area under the curve. By counting squares we have (approximately)

$$u_t = (188.5 \text{ squares}) \left(25 \times 10^6 \frac{\text{N}}{\text{m}^2} \right) \left(0.025 \frac{\text{m}}{\text{m}} \right) = 118(10^6) \frac{\text{N}}{\text{m}^2}$$

From *Mechanics of Materials*, Sixth Edition by R. C. Hibbeler, ISBN 0-13-191345-X.
 © 2005 R. C. Hibbeler. Published by Pearson Prentice Hall,
 Pearson Education, Inc., Upper Saddle River, NJ. All rights reserved.
 This material is protected under all copyright laws as they currently exist. No portion of this material may be reproduced, in any form or by any means, without permission in writing from the publisher.

***3-44** An 8-mm-diameter brass rod has a modulus of elasticity of $E_{br} = 100$ GPa. If it is 3 m long and subjected to an axial load of 2 kN, determine its elongation. What is its elongation under the same load if its diameter is 6 mm?

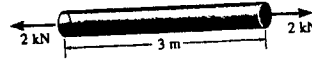

$$\sigma = \frac{P}{A} = \frac{2(10^3)}{\frac{\pi}{4}(0.008^2)} = 39.789 \text{ MPa}$$

$$\epsilon = \frac{\sigma}{E} = \frac{39.789(10^6)}{100(10^9)} = 0.00039789$$

$$\delta = \epsilon L = 0.00039789(3000) = 1.19 \text{ mm} \quad \text{Ans}$$

$$\sigma' = \frac{P}{A} = \frac{2(10^3)}{\frac{\pi}{4}(0.006^2)} = 70.735 \text{ MPa}$$

$$\epsilon' = \frac{\sigma}{E} = \frac{70.735(10^6)}{100(10^9)} = 0.00070735$$

$$\delta' = \epsilon' L = 0.00070735(3000) = 2.12 \text{ mm} \quad \text{Ans}$$

From *Mechanics of Materials*, Sixth Edition by R. C. Hibbeler, ISBN 0-13-191345-X.

© 2005 R. C. Hibbeler. Published by Pearson Prentice Hall,

Pearson Education, Inc., Upper Saddle River, NJ. All rights reserved.

This material is protected under all copyright laws as they currently exist. No portion of this material may be reproduced, in any form or by any means, without permission in writing from the publisher.

4-1 The assembly consists of a steel rod CB and an aluminum rod BA , each having a diameter of 12 mm. If the rod is subjected to the axial loadings at A and at the coupling B , determine the displacement of the coupling B and the end A . The unstretched length of each segment is shown in the figure. Neglect the size of the connections at B and C , and assume that they are rigid. $E_{st} = 200$ GPa, $E_{al} = 70$ GPa.

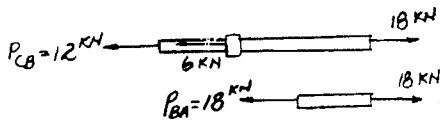
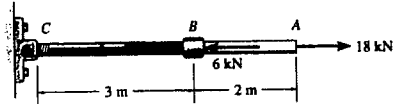

$$\delta_B = \frac{PL}{AE} = \frac{12(10^3)(3)}{\frac{\pi}{4}(0.012)^2(200)(10^9)} = 0.00159 \text{ m} = 1.59 \text{ mm} \quad \text{Ans}$$

$$\delta_A = \sum \frac{PL}{AE} = \frac{12(10^3)(3)}{\frac{\pi}{4}(0.012)^2(200)(10^9)} + \frac{18(10^3)(2)}{\frac{\pi}{4}(0.012)^2(70)(10^9)}$$

$$= 0.00614 \text{ m} = 6.14 \text{ mm} \quad \text{Ans}$$

From *Mechanics of Materials*, Sixth Edition by R. C. Hibbeler, ISBN 0-13-191345-X.

© 2005 R. C. Hibbeler. Published by Pearson Prentice Hall,

Pearson Education, Inc., Upper Saddle River, NJ. All rights reserved.

This material is protected under all copyright laws as they currently exist. No portion of this material may be reproduced, in any form or by any means, without permission in writing from the publisher.

4-2 The composite shaft, consisting of aluminum, copper, and steel sections, is subjected to the loading shown. Determine the displacement of end *A* with respect to end *D* and the normal stress in each section. The cross-sectional area and modulus of elasticity for each section are shown in the figure. Neglect the size of the collars at *B* and *C*.

$$\sigma_{AB} = \frac{P_{AB}}{A_{AB}} = \frac{2}{0.09} = 22.2 \text{ ksi} \quad (\text{T}) \quad \text{Ans}$$

$$\sigma_{BC} = \frac{P_{BC}}{A_{BC}} = \frac{5}{0.12} = 41.7 \text{ ksi} \quad (\text{C}) \quad \text{Ans}$$

$$\sigma_{CD} = \frac{P_{BC}}{A_{BC}} = \frac{1.5}{0.06} = 25.0 \text{ ksi} \quad (\text{C}) \quad \text{Ans}$$

$$\delta_{A/D} = \sum \frac{PL}{AE} = \frac{2(18)}{(0.09)(10)(10^3)} + \frac{(-5)(12)}{(0.12)(18)(10^3)} + \frac{(-1.5)(16)}{(0.06)(29)(10^3)}$$

$$= -0.00157 \text{ in.} \quad \text{Ans}$$

The negative sign indicates end *A* moves towards end *D*.

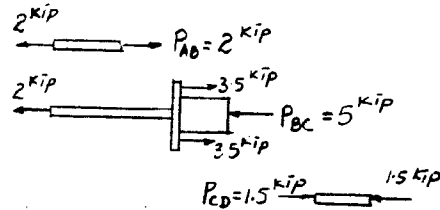
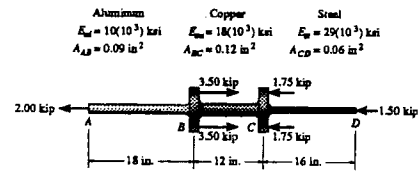

From *Mechanics of Materials*, Sixth Edition by R. C. Hibbeler, ISBN 0-13-191345-X.
 © 2005 R. C. Hibbeler. Published by Pearson Prentice Hall,
 Pearson Education, Inc., Upper Saddle River, NJ. All rights reserved.
 This material is protected under all copyright laws as they currently exist. No portion of this material may be reproduced, in any form or by any means, without permission in writing from the publisher.

4-3 Determine the displacement of *B* with respect to *C* of the composite shaft in Prob. 4-2.

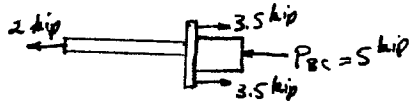
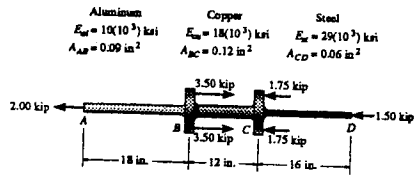

$$\delta_{B/C} = \frac{PL}{AE} = \frac{(-5)(12)}{(0.12)(18)(10^3)} = -0.0278 \text{ in.} \quad \text{Ans}$$

The negative sign indicates end *B* moves towards end *C*.

From *Mechanics of Materials*, Sixth Edition by R. C. Hibbeler, ISBN 0-13-191345-X.
 © 2005 R. C. Hibbeler. Published by Pearson Prentice Hall,
 Pearson Education, Inc., Upper Saddle River, NJ. All rights reserved.
 This material is protected under all copyright laws as they currently exist. No portion of this material may be reproduced, in any form or by any means, without permission in writing from the publisher.

*4-4 The copper shaft is subjected to the axial loads shown. Determine the displacement of end A with respect to end D if the diameters of each segment are $d_{AB} = 0.75$ in., $d_{BC} = 1$ in., and $d_{CD} = 0.5$ in. Take $E_{cu} = 18(10^3)$ ksi.

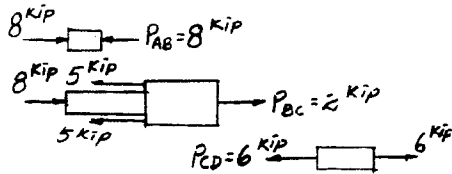
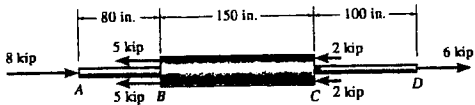

$$\delta_{AD} = \sum \frac{PL}{AE} = \frac{-8(80)}{\frac{\pi}{4}(0.75)^2(18)(10^3)} + \frac{2(150)}{\frac{\pi}{4}(1)^2(18)(10^3)} + \frac{6(100)}{\frac{\pi}{4}(0.5)^2(18)(10^3)}$$

$$= 0.111 \text{ in.} \quad \text{Ans}$$

The positive sign indicates that end A moves away from end D.

From *Mechanics of Materials*, Sixth Edition by R. C. Hibbeler, ISBN 0-13-191345-X.

© 2005 R. C. Hibbeler. Published by Pearson Prentice Hall,

Pearson Education, Inc., Upper Saddle River, NJ. All rights reserved.

This material is protected under all copyright laws as they currently exist. No portion of this material may be reproduced, in any form or by any means, without permission in writing from the publisher.

4-5 The A-36 steel rod is subjected to the loading shown. If the cross-sectional area of the rod is 60 mm^2 , determine the displacement of B and A . Neglect the size of the couplings at B , C , and D .

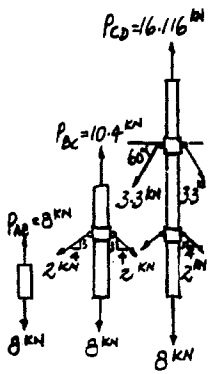
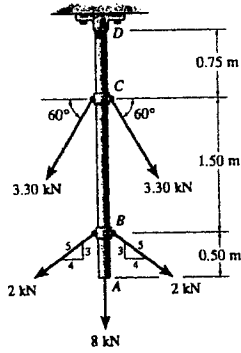

$$\delta_B = \sum \frac{PL}{AE} = \frac{16.116 (10^3)(0.75)}{60 (10^{-6})(200)(10^9)} + \frac{10.4 (10^3)(1.50)}{60(10^{-6})(200)(10^9)}$$

$$= 0.00231 \text{ m} = 2.31 \text{ mm} \quad \text{Ans}$$

$$\delta_A = \delta_B + \frac{8 (10^3)(0.5)}{60(10^{-6})(200)(10^9)} = 0.00264 \text{ m} = 2.64 \text{ mm} \quad \text{Ans}$$

From *Mechanics of Materials*, Sixth Edition by R. C. Hibbeler, ISBN 0-13-191345-X.

© 2005 R. C. Hibbeler. Published by Pearson Prentice Hall,

Pearson Education, Inc., Upper Saddle River, NJ. All rights reserved.

This material is protected under all copyright laws as they currently exist. No portion of this material may be reproduced, in any form or by any means, without permission in writing from the publisher.

4-6 The 2014-T6 aluminum rod has a diameter of 30 mm and supports the load shown. Determine the displacement of A with respect to E. Neglect the size of the couplings.

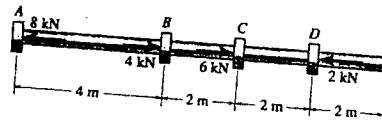

$$\delta_{A/E} = \sum \frac{PL}{AE} = \frac{1}{AE} [8(4) + 4(2) - 2(2) + 0(2)] (10^3)$$

$$= \frac{36(10^3)}{\frac{\pi}{4}(0.03)^2(73.1)(10^9)} = 0.697 (10^{-3}) = 0.697 \text{ mm}$$

Ans

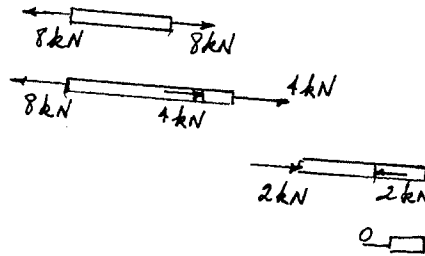

From *Mechanics of Materials*, Sixth Edition by R. C. Hibbeler, ISBN 0-13-191345-X.
 © 2005 R. C. Hibbeler. Published by Pearson Prentice Hall,
 Pearson Education, Inc., Upper Saddle River, NJ. All rights reserved.
 This material is protected under all copyright laws as they currently exist. No portion of this material may be reproduced, in any form or by any means, without permission in writing from the publisher.

4-7 The steel bar has the original dimensions shown in the figure. If it is subjected to an axial load of 50 kN, determine the change in its length and its new cross-sectional dimensions at section $a-a$. $E_{st} = 200$ GPa, $\nu_{st} = 0.29$.

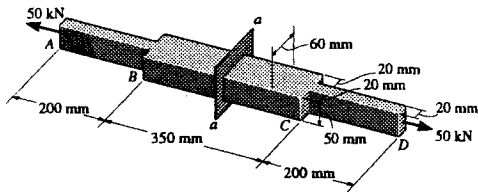

$$\delta_{AD} = \sum \frac{PL}{AE} = \frac{2(50)(10^3)(200)}{(0.02)(0.05)(200)(10^9)} + \frac{50(10^3)(350)}{(0.06)(0.05)(200)(10^9)}$$

$$= 0.129 \text{ mm} \quad \text{Ans}$$

$$\delta_{B/C} = \frac{PL}{AE} = \frac{50(10^3)(350)}{(0.06)(0.05)(200)(10^9)} = 0.02917 \text{ mm}$$

$$\epsilon_{BC} = \frac{\delta_{B/C}}{L_{BC}} = \frac{0.02917}{350} = 0.00008333$$

$$\epsilon_{lat} = -\nu \epsilon_{long} = -(0.29)(0.00008333) = -0.00002417$$

$$h = 50 - 50(0.00002417) = 49.9988 \text{ mm} \quad \text{Ans}$$

$$w = 60 - 60(0.00002417) = 59.9986 \text{ mm} \quad \text{Ans}$$

From *Mechanics of Materials*, Sixth Edition by R. C. Hibbeler, ISBN 0-13-191345-X.

© 2005 R. C. Hibbeler. Published by Pearson Prentice Hall,

Pearson Education, Inc., Upper Saddle River, NJ. All rights reserved.

This material is protected under all copyright laws as they currently exist. No portion of this material may be reproduced, in any form or by any means, without permission in writing from the publisher.

***4-8.** The assembly consists of two rigid bars that are originally horizontal. They are supported by pins and 0.25-in.-diameter A-36 steel rods. If the vertical load of 5 kip is applied to the bottom bar AB , determine the displacement at C , B , and E .

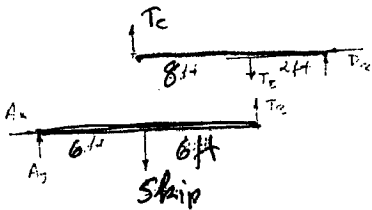
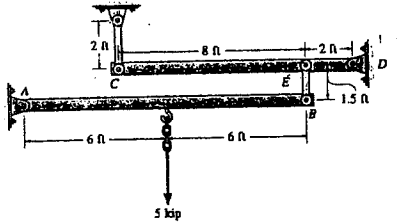

$$(+ \Sigma M_A = 0; \quad T_B(12) - 5(6) = 0$$

$$T_B = 2.5 \text{ kip}$$

$$(+ \Sigma M_D = 0; \quad 2.5(2) - T_C(10) = 0$$

$$T_C = 0.5 \text{ kip}$$

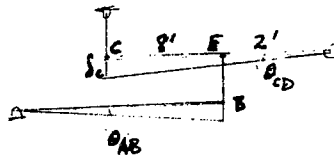

$$\delta_{B/E} = \frac{PL}{AE} = \frac{2.5(1.5)(12)}{\frac{\pi}{4}(0.25)^2(29)(10^3)} = 0.0316 \text{ in.}$$

$$\delta_C = \frac{PL}{AE} = \frac{0.5(2)(12)}{\frac{\pi}{4}(0.25)^2(29)(10^3)} = 0.0084297 \text{ in.} = 0.00843 \text{ in.} \quad \text{Ans}$$

$$\delta_E = \left(\frac{2}{10}\right) \delta_C = \frac{2}{10}(0.0084297) = 0.00169 \text{ in.} \quad \text{Ans}$$

$$\delta_B = \delta_E + \delta_{B/E} = 0.00169 + 0.0316 = 0.0333 \text{ in.} \quad \text{Ans}$$

From *Mechanics of Materials*, Sixth Edition by R. C. Hibbeler, ISBN 0-13-191345-X.

© 2005 R. C. Hibbeler. Published by Pearson Prentice Hall,

Pearson Education, Inc., Upper Saddle River, NJ. All rights reserved.

This material is protected under all copyright laws as they currently exist. No portion of this material may be reproduced, in any form or by any means, without permission in writing from the publisher.

4-9 The coupling is subjected to a force of 5 kip. Determine the distance d between C and E accounting for the compression of the spring and the deformation of the vertical segments of the bolts. When no load is applied the spring is unstretched and $d = 10$ in. The material is A-36 steel and each bolt has a diameter of 0.25 in. The plates at A , B , and C are rigid and the spring has a stiffness of $k = 12$ kip/in.

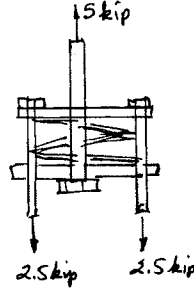
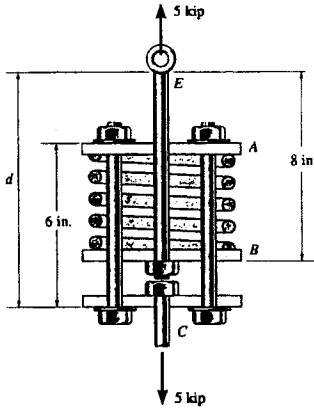

$$\delta_{\text{center bolt}} = \frac{PL}{AE} = \frac{5(10^3)(8)}{\frac{\pi}{4}(0.25)^2(29)(10^6)} = 0.028099 \text{ in. } \uparrow$$

$$\delta_{\text{side bolts}} = \frac{PL}{AE} = \frac{2.5(10^3)(6)}{\frac{\pi}{4}(0.25)^2(29)(10^6)} = 0.010537 \text{ in. } \downarrow$$

$$\delta_{sp} = \frac{P}{k} = \frac{5}{12} = 0.41667 \text{ in. } \uparrow$$

$$\delta d = 0.41667 + 0.028099 + 0.010537$$

$$\delta d = 0.455 \text{ in.}$$

$$d = 10 + 0.455 = 10.455 \text{ in.} \quad \text{Ans}$$

From *Mechanics of Materials*, Sixth Edition by R. C. Hibbeler, ISBN 0-13-191345-X.

© 2005 R. C. Hibbeler. Published by Pearson Prentice Hall,

Pearson Education, Inc., Upper Saddle River, NJ. All rights reserved.

This material is protected under all copyright laws as they currently exist. No portion of this material may be reproduced, in any form or by any means, without permission in writing from the publisher.

4-10 The bar has a cross-sectional area of $A = 3 \text{ in}^2$, and $E = 35(10^6) \text{ ksi}$. Determine the displacement of its end A when it is subjected to the distributed loading.

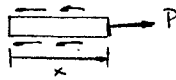
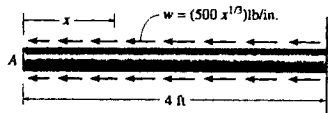

$$P(x) = \int_0^x w \, dx = 500 \int_0^x x^{1/3} \, dx = \frac{1500}{4} x^{4/3}$$

$$\delta_A = \int_0^L \frac{P(x) \, dx}{AE} = \frac{1}{(3)(35)(10^6)} \int_0^{4(12)} \frac{1500}{4} x^{4/3} \, dx = \left(\frac{1500}{(3)(35)(10^6)(4)} \right) \left(\frac{3}{7} \right) (48)^{7/3}$$

$$\delta_A = 0.0128 \text{ in.} \quad \text{Ans}$$

From *Mechanics of Materials*, Sixth Edition by R. C. Hibbeler, ISBN 0-13-191345-X.

© 2005 R. C. Hibbeler. Published by Pearson Prentice Hall,

Pearson Education, Inc., Upper Saddle River, NJ. All rights reserved.

This material is protected under all copyright laws as they currently exist. No portion of this material may be reproduced, in any form or by any means, without permission in writing from the publisher.

4-11 The truss is made of three A-36 steel members, each having a cross-sectional area of 400 mm^2 . Determine the horizontal displacement of the roller at C when $P = 8 \text{ kN}$.

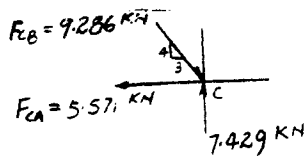
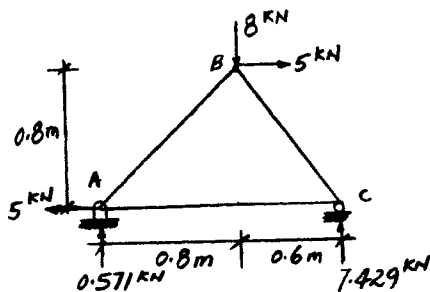
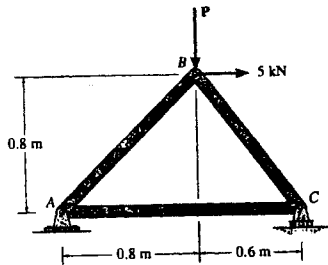

By observation the horizontal displacement of roller C is equal to the displacement of point C obtained from member AC.

$$F_{CA} = 5.571 \text{ kN}$$

$$\delta_{C_x} = \frac{F_{CA}L}{AE} = \frac{5.571(10^3)(1.40)}{(400)(10^{-6})(200)(10^6)} = 0.0975 \text{ mm} \quad \text{Ans}$$

From *Mechanics of Materials*, Sixth Edition by R. C. Hibbeler, ISBN 0-13-191345-X.

© 2005 R. C. Hibbeler. Published by Pearson Prentice Hall,

Pearson Education, Inc., Upper Saddle River, NJ. All rights reserved.

This material is protected under all copyright laws as they currently exist. No portion of this material may be reproduced, in any form or by any means, without permission in writing from the publisher.

*4-12 The truss is made of three A-36 steel members, each having a cross-sectional area of 400 mm^2 . Determine the magnitude P required to displace the roller to the right 0.2 mm .

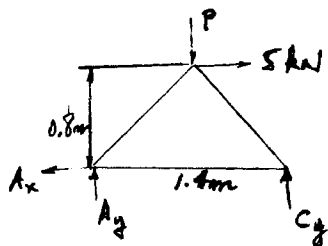
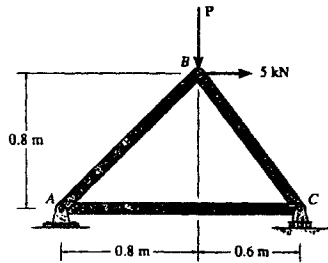

$$\begin{aligned} \sum M_A = 0; \quad & -P(0.8) - 5(0.8) + C_y(1.4) = 0 \\ & C_y = 0.5714P + 2.857 \end{aligned}$$

$$\begin{aligned} + \uparrow \sum F_y = 0; \quad & C_y - F_{BC} \left(\frac{4}{5}\right) = 0 \\ & F_{BC} = 1.25 C_y \end{aligned}$$

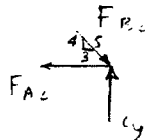

$$\begin{aligned} \rightarrow \sum F_x = 0; \quad & -F_{AC} + 1.25 C_y(0.6) = 0 \\ & F_{AC} = 0.75 C_y = 0.4286P + 2.14286 \end{aligned}$$

Require,

$$\delta_{C_A} = 0.0002 = \frac{(0.4286P + 2.14286)(10^3)(1.4)}{(400)(10^{-6})(200)(10^9)}$$

$$P = 21.7 \text{ kN} \quad \text{Ans}$$

From *Mechanics of Materials*, Sixth Edition by R. C. Hibbeler, ISBN 0-13-191345-X.

© 2005 R. C. Hibbeler. Published by Pearson Prentice Hall,

Pearson Education, Inc., Upper Saddle River, NJ. All rights reserved.

This material is protected under all copyright laws as they currently exist. No portion of this material may be reproduced, in any form or by any means, without permission in writing from the publisher.

4-13. The truss consists of three members, each made from A-36 steel and having a cross-sectional area of 0.75 in^2 . Determine the greatest load P that can be applied so that the roller support at B is not displaced more than 0.03 in .

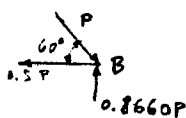
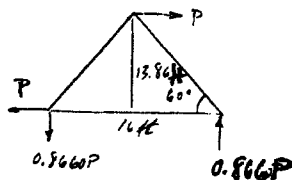
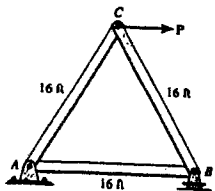

$$\delta_{B_x} = 0.03 \text{ in.} = \frac{(0.5)P(16)(12)}{(0.75)(29)(10^6)}$$

$$P = 6.80 \text{ kip} \quad \text{Ans}$$

From *Mechanics of Materials*, Sixth Edition by R. C. Hibbeler, ISBN 0-13-191345-X.

© 2005 R. C. Hibbeler. Published by Pearson Prentice Hall,

Pearson Education, Inc., Upper Saddle River, NJ. All rights reserved.

This material is protected under all copyright laws as they currently exist. No portion of this material may be reproduced, in any form or by any means, without permission in writing from the publisher.

4-14. Solve Prob. 4-13 when the load P acts vertically downward at C .

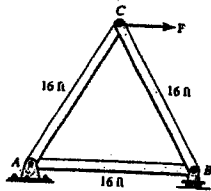

Require,

$$\delta_{B_x} = 0.03 \text{ in.} = \frac{0.2887 P(16)(12)}{(0.75)(29)(10^6)}$$

$$P = 11.8 \text{ kip} \quad \text{Ans}$$

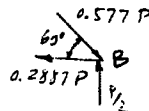
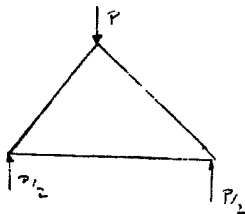

From *Mechanics of Materials*, Sixth Edition by R. C. Hibbeler, ISBN 0-13-191345-X.
 © 2005 R. C. Hibbeler. Published by Pearson Prentice Hall,
 Pearson Education, Inc., Upper Saddle River, NJ. All rights reserved.
 This material is protected under all copyright laws as they currently exist. No portion of this material may be reproduced, in any form or by any means, without permission in writing from the publisher.

4-15 The assembly consists of three titanium rods and a rigid bar AC. The cross-sectional area of each rod is given in the figure. If a vertical force of $P = 20$ kN is applied to the ring F , determine the vertical displacement of point F . $E_t = 350$ GPa.

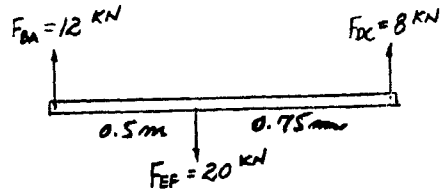
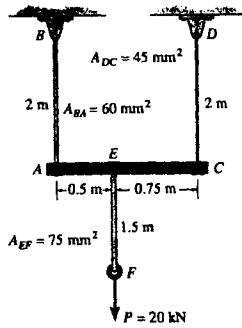

$$\delta_A = \frac{PL}{AE} = \frac{12(10^3)(2000)}{(60)(10^{-6})(350)(10^9)} = 1.1429 \text{ mm}$$

$$\delta_C = \frac{PL}{AE} = \frac{8(10^3)(2000)}{45(10^{-6})(350)(10^9)} = 1.0159 \text{ mm}$$

$$\delta_{F/E} = \frac{PL}{AE} = \frac{20(10^3)(1500)}{75(10^{-6})(350)(10^9)} = 1.1429 \text{ mm}$$

$$\delta_E = 1.0159 + \frac{0.75}{1.25}(0.1270) = 1.092 \text{ mm}$$

$$\delta_F = \delta_E + \delta_{F/E}$$

$$= 1.092 + 1.1429$$

$$= 2.23 \text{ mm} \quad \text{Ans}$$

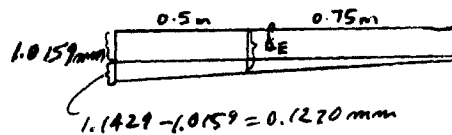

From *Mechanics of Materials*, Sixth Edition by R. C. Hibbeler, ISBN 0-13-191345-X.

© 2005 R. C. Hibbeler. Published by Pearson Prentice Hall,

Pearson Education, Inc., Upper Saddle River, NJ. All rights reserved.

This material is protected under all copyright laws as they currently exist. No portion of this material may be reproduced, in any form or by any means, without permission in writing from the publisher.

*4-16 The linkage is made of three pin-connected A-36 steel members, each having a cross-sectional area of 0.730 in^2 . If a vertical force of $P = 50 \text{ kip}$ is applied to the end B of member AB , determine the vertical displacement of point B .

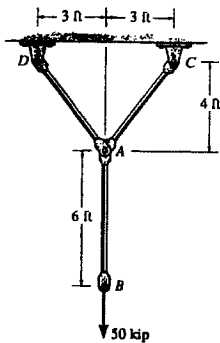

$$\delta_{AD} = \delta_{AC} = \frac{PL}{AE} = \frac{31.25(5)(12)}{(0.730)(29)(10^3)} = 0.08857 \text{ in.}$$

$$\delta_{B/A} = \frac{PL}{AE} = \frac{50(6)(12)}{(0.730)(29)(10^3)} = 0.17005 \text{ in.}$$

$$\phi = 90^\circ + \tan^{-1}\left(\frac{4}{3}\right) = 143.13^\circ$$

$$\frac{\sin \theta}{60} = \frac{\sin 143.13^\circ}{60.08857}; \theta = 36.806584^\circ$$

$$\beta = 180^\circ - 36.806584^\circ - 143.130102^\circ = 0.06331297^\circ$$

$$\frac{\delta_A}{\sin 0.06331297^\circ} = \frac{60}{\sin 36.806584^\circ}$$

$$\delta_A = 0.11066 \text{ in.}$$

$$\delta_B = \delta_A + \delta_{B/A} = 0.11066 + 0.17005 = 0.281 \text{ in.} \quad \text{Ans}$$

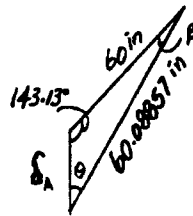
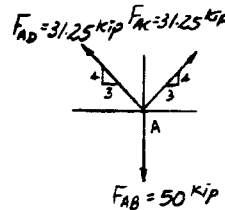

From *Mechanics of Materials*, Sixth Edition by R. C. Hibbeler, ISBN 0-13-191345-X.
 © 2005 R. C. Hibbeler. Published by Pearson Prentice Hall,
 Pearson Education, Inc., Upper Saddle River, NJ. All rights reserved.
 This material is protected under all copyright laws as they currently exist. No portion of this material may be reproduced, in any form or by any means, without permission in writing from the publisher.

4-17 The linkage is made of three pin-connected 304 stainless steel members, each having a cross-sectional area of 0.75 in^2 . Determine the magnitude of the force P needed to displace point B 0.10 in. downward.

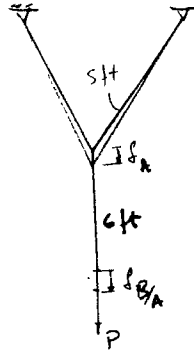
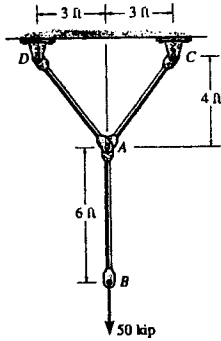

$$\delta_B = \delta_A + \delta_{B/A} = 0.10 \text{ in.} \quad (1)$$

$$\delta_{B/A} = \frac{PL}{AE} = \frac{P(6)(12)}{(0.75)(29)(10^3)} = 0.0033103P$$

$$+\uparrow \Sigma F_y = 0; \quad 2F\left(\frac{4}{5}\right) - P = 0$$

$$F = 0.625P$$

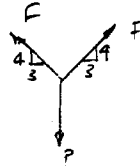

$$\delta_{NC} = \delta_{ND} = \frac{0.625P(5)(12)}{(0.75)(29)(10^3)} = 0.0017241P$$

$$\delta_A = \delta_{NC}\left(\frac{5}{4}\right) = 0.0021552P$$

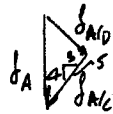

From Eq. (1),

$$0.0033103P + 0.0021552P = 0.10$$

$$P = 18.3 \text{ kip} \quad \text{Ans.}$$

From *Mechanics of Materials*, Sixth Edition by R. C. Hibbeler, ISBN 0-13-191345-X.

© 2005 R. C. Hibbeler. Published by Pearson Prentice Hall,

Pearson Education, Inc., Upper Saddle River, NJ. All rights reserved.

This material is protected under all copyright laws as they currently exist. No portion of this material may be reproduced, in any form or by any means, without permission in writing from the publisher.

Because of the number and variety of potential correct solutions to this problem, no solution is being given.

From *Mechanics of Materials*, Sixth Edition by R. C. Hibbeler, ISBN 0-13-191345-X.

© 2005 R. C. Hibbeler. Published by Pearson Prentice Hall,

Pearson Education, Inc, Upper Saddle River, NJ. All rights reserved.

This material is protected under all copyright laws as they currently exist. No portion of this material may be reproduced, in any form or by any means, without permission in writing from the publisher.

4-19 The rigid bar is supported by the pin-connected rod CB that has a cross-sectional area of 14 mm^2 and is made from 6061-T6 aluminum. Determine the vertical deflection of the bar at D when the distributed load is applied.

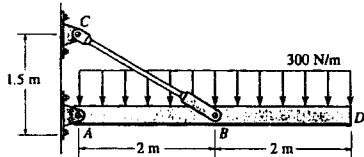

$$\left(+ \Sigma M_A = 0; \quad 1200(2) - T_{CB}(0.6)(2) = 0 \right.$$

$$T_{CB} = 2000 \text{ N}$$

$$\delta_{B/C} = \frac{PL}{AE} = \frac{(2000)(2.5)}{14(10^{-6})(68.9)(10^9)} = 0.0051835$$

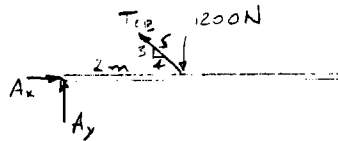

$$(2.5051835)^2 = (1.5)^2 + (2)^2 - 2(1.5)(2) \cos \theta$$

$$\theta = 90.248^\circ$$

$$\theta' = 90.248^\circ - 90^\circ = 0.2478^\circ = 0.004324 \text{ rad}$$

$$\delta_D = \theta r = 0.004324(4000) = 17.3 \text{ mm} \quad \text{Ans}$$

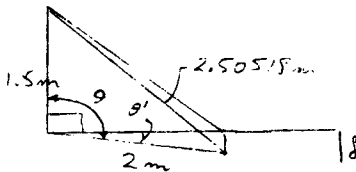

From *Mechanics of Materials*, Sixth Edition by R. C. Hibbeler, ISBN 0-13-191345-X.

© 2005 R. C. Hibbeler. Published by Pearson Prentice Hall,

Pearson Education, Inc., Upper Saddle River, NJ. All rights reserved.

This material is protected under all copyright laws as they currently exist. No portion of this material may be reproduced, in any form or by any means, without permission in writing from the publisher.

*4-20 The observation cage C has a weight of 250 kip and through a system of gears, travels upward at constant velocity along the A-36 steel column, which has a height of 200 ft. The column has an outer diameter of 3 ft and is made from steel plate having a thickness of 0.25 in. Neglect the weight of the column, and determine the average normal stress in the column at its base, B, as a function of the cage's position y. Also, determine the displacement of end A as a function of y.

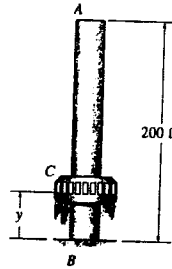

$$\sigma_B = \frac{P}{A} = \frac{250}{\frac{\pi}{4}(36^2 - 35.5^2)} = 8.90 \text{ ksi}$$

σ_B is independent of y.

$$\delta_A = \frac{PL}{AE} = \frac{250y}{\frac{\pi}{4}(36^2 - 35.5^2)(29)(10^3)} = [0.307(10^{-3})y] \text{ ft} \quad \text{Ans}$$

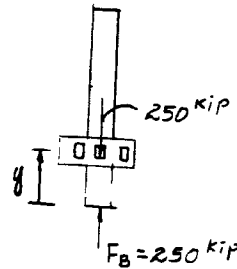

From *Mechanics of Materials*, Sixth Edition by R. C. Hibbeler, ISBN 0-13-191345-X.

© 2005 R. C. Hibbeler. Published by Pearson Prentice Hall,

Pearson Education, Inc., Upper Saddle River, NJ. All rights reserved.

This material is protected under all copyright laws as they currently exist. No portion of this material may be reproduced, in any form or by any means, without permission in writing from the publisher.

4-21 The bar has a length L and cross-sectional area A . Determine its elongation due to both the force P and its own weight. The material has a specific weight γ (weight/volume) and a modulus of elasticity E .

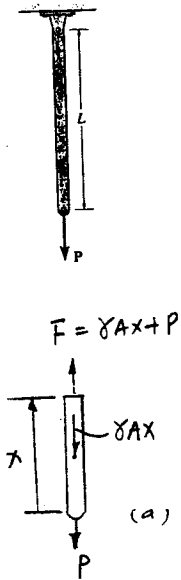

$$\delta = \int \frac{P(x) dx}{A(x) E} = \frac{1}{AE} \int_0^L (\gamma Ax + P) dx$$

$$= \frac{1}{AE} \left(\frac{\gamma AL^2}{2} + PL \right) = \frac{\gamma L^2}{2E} + \frac{PL}{AE} \quad \text{Ans}$$

From *Mechanics of Materials*, Sixth Edition by R. C. Hibbeler, ISBN 0-13-191345-X.

© 2005 R. C. Hibbeler. Published by Pearson Prentice Hall,

Pearson Education, Inc., Upper Saddle River, NJ. All rights reserved.

This material is protected under all copyright laws as they currently exist. No portion of this material may be reproduced, in any form or by any means, without permission in writing from the publisher.

4-22 The A-36 steel drill shaft of an oil well extends 12 000 ft into the ground. Assuming that the pipe used to drill the well is suspended freely from the derrick at *A*, determine the maximum average normal stress in each pipe segment and the elongation of its end *D* with respect to the fixed end at *A*. The shaft consists of three different sizes of pipe, *AB*, *BC*, and *CD*, each having the length, weight per unit length, and cross-sectional area indicated. *Hint:* Use the results of Prob. 4-21.

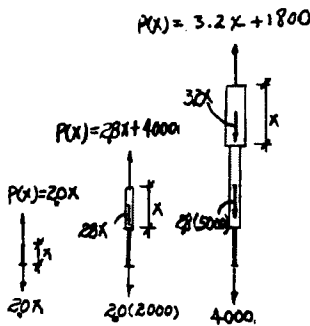
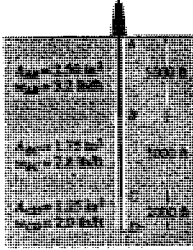

$$\sigma_A = \frac{P}{A} = \frac{3.2(5000) + 18000}{2.5} = 13.6 \text{ ksi} \quad \text{Ans}$$

$$\sigma_B = \frac{P}{A} = \frac{2.8(5000) + 4000}{1.75} = 10.3 \text{ ksi} \quad \text{Ans}$$

$$\sigma_C = \frac{P}{A} = \frac{2(2000)}{1.25} = 3.2 \text{ ksi} \quad \text{Ans}$$

$$\delta_D = \Sigma \int \frac{P(x) dx}{A(x) E} = \int_0^{2000} \frac{2x dx}{(1.25)(29)(10^6)} + \int_0^{5000} \frac{(2.8x + 4000) dx}{(1.75)(29)(10^6)} + \int_0^{5000} \frac{(3.2x + 18000) dx}{(2.5)(29)(10^6)}$$

$$= 2.99 \text{ ft} \quad \text{Ans}$$

From *Mechanics of Materials*, Sixth Edition by R. C. Hibbeler, ISBN 0-13-191345-X.

© 2005 R. C. Hibbeler. Published by Pearson Prentice Hall,

Pearson Education, Inc., Upper Saddle River, NJ. All rights reserved.

This material is protected under all copyright laws as they currently exist. No portion of this material may be reproduced, in any form or by any means, without permission in writing from the publisher.

4-23 The pipe is stuck in the ground so that when it is pulled upward the frictional force along its length varies linearly from zero at B to f_{max} (force/length) at C. Determine the initial force P required to pull the pipe out and the pipe's associated elongation just before it starts to slip. The pipe has a length L , cross-sectional area A , and the material from which it is made has a modulus of elasticity E .

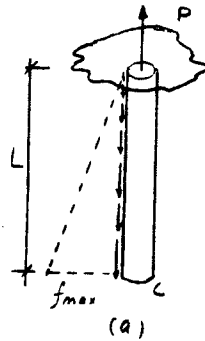
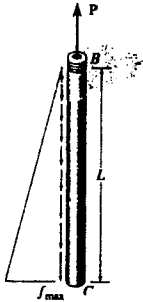

From FBD (a)

$$+\uparrow \Sigma F_y = 0; \quad P - \frac{1}{2}(f_{max} L) = 0$$

$$P = \frac{f_{max} L}{2} \quad \text{Ans}$$

From FBD (b)

$$+\downarrow \Sigma F_y = 0; \quad P(x) + \frac{1}{2}\left(\frac{f_{max} x}{L}\right)x - \frac{f_{max} L}{2} = 0$$

$$P(x) = \frac{f_{max} L}{2} - \frac{f_{max} x^2}{2L}$$

$$\delta = \int_0^L \frac{P(x) dx}{A(x)E} = \int_0^L \frac{f_{max} L}{2AE} dx - \int_0^L \frac{f_{max} x^2}{2AEL} dx$$

$$= \frac{f_{max} L^2}{3AE} \quad \text{Ans}$$

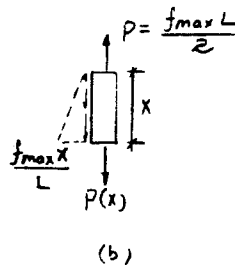

From *Mechanics of Materials*, Sixth Edition by R. C. Hibbeler, ISBN 0-13-191345-X.
 © 2005 R. C. Hibbeler. Published by Pearson Prentice Hall,
 Pearson Education, Inc., Upper Saddle River, NJ. All rights reserved.
 This material is protected under all copyright laws as they currently exist. No portion of this material may be reproduced, in any form or by any means, without permission in writing from the publisher.

*4-24 The rod has a slight taper and length L . It is suspended from the ceiling and supports a load P at its end. Show that the displacement of its end due to this load is $\delta = PL/(\pi E r_2 r_1)$. Neglect the weight of the material. The modulus of elasticity is E .

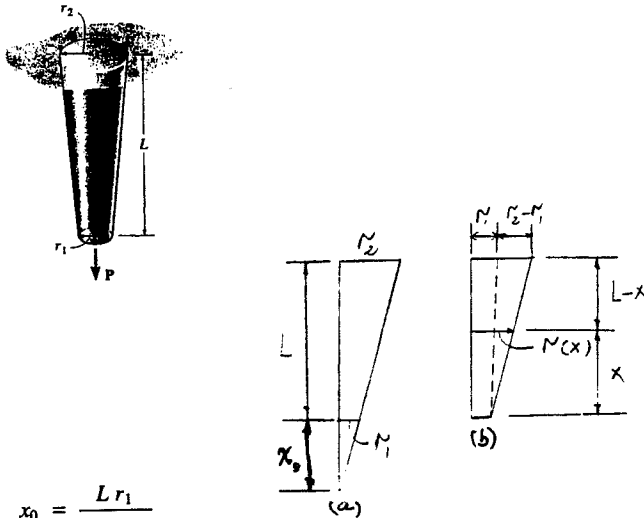

$$\frac{L + x_0}{r_2} = \frac{x_0}{r_1}; \quad x_0 = \frac{L r_1}{r_2 - r_1}$$

$$\text{Thus, } r(x) = r_1 + \frac{r_2 - r_1}{L} x = \frac{r_1 L + (r_2 - r_1)x}{L}$$

$$A(x) = \frac{\pi}{L^2} (r_1 L + (r_2 - r_1)x)^2$$

$$\begin{aligned} \delta &= \int \frac{P dx}{A(x)E} = \frac{PL^2}{\pi E} \int_0^L \frac{dx}{[r_1 L + (r_2 - r_1)x]^2} \\ &= -\frac{PL^2}{\pi E} \left[\frac{1}{(r_2 - r_1)(r_1 L + (r_2 - r_1)x)} \right]_0^L = -\frac{PL^2}{\pi E(r_2 - r_1)} \left[\frac{1}{r_1 L + (r_2 - r_1)L} - \frac{1}{r_1 L} \right] \\ &= -\frac{PL^2}{\pi E(r_2 - r_1)} \left[\frac{1}{r_2 L} - \frac{1}{r_1 L} \right] = -\frac{PL^2}{\pi E(r_2 - r_1)} \left[\frac{r_1 - r_2}{r_2 r_1 L} \right] \\ &= \frac{PL^2}{\pi E(r_2 - r_1)} \left[\frac{r_2 - r_1}{r_2 r_1 L} \right] = \frac{PL}{\pi E r_2 r_1} \quad \text{QED} \end{aligned}$$

From *Mechanics of Materials*, Sixth Edition by R. C. Hibbeler, ISBN 0-13-191345-X.

© 2005 R. C. Hibbeler. Published by Pearson Prentice Hall,

Pearson Education, Inc., Upper Saddle River, NJ. All rights reserved.

This material is protected under all copyright laws as they currently exist. No portion of this material may be reproduced, in any form or by any means, without permission in writing from the publisher.

4-25 Solve Prob. 4-24 by including the weight of the material, considering its specific weight to be γ (weight/volume).

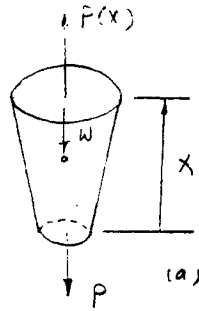
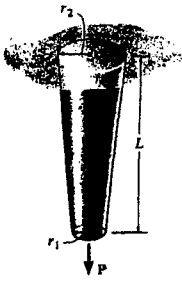

$$+\uparrow \Sigma F_x = 0; \quad P(x) - P - W = 0; \quad P(x) = P + W$$

From diagram (b)

$$\frac{L + x_0}{r_2} = \frac{x_0}{r_1}; \quad x_0 = \frac{L r_1}{r_2 - r_1}$$

From diagram (c)

$$r(x) = r_1 + \frac{r_2 - r_1}{L} x = \frac{r_1 L + (r_2 - r_1)x}{L}$$

$$A(x) = \frac{\pi}{L^2} (r_1 L + (r_2 - r_1)x)^2$$

$$W = \frac{\gamma \pi}{3L^2} [r_1 L + (r_2 - r_1)x]^2 \left[x + \frac{L r_1}{r_2 - r_1} \right] - \frac{\gamma \pi (r_1^2)}{3} \left(\frac{L r_1}{r_2 - r_1} \right)$$

$$= \frac{\gamma \pi}{3L^2 (r_2 - r_1)} \{ [r_1 L + (r_2 - r_1)x]^3 - r_1^3 L^3 \}$$

$$\delta = \int \frac{W dx}{A(x)E} = \frac{\gamma}{3E(r_2 - r_1)} \int_0^L \frac{[r_1 L + (r_2 - r_1)x]^3 - r_1^3 L^3}{[r_1 L + (r_2 - r_1)x]^2} dx$$

$$= \frac{\gamma}{3E(r_2 - r_1)} \int_0^L [r_1 L + (r_2 - r_1)x] dx - \frac{\gamma r_1^3 L^3}{3E(r_2 - r_1)} \int_0^L \frac{dx}{[r_1 L + (r_2 - r_1)x]^2}$$

$$= \frac{\gamma}{3E(r_2 - r_1)} \left[r_1 L x + \frac{(r_2 - r_1)x^2}{2} \right]_0^L + \frac{\gamma r_1^3 L^3}{3E(r_2 - r_1)^2} \left[\frac{1}{r_1 L + (r_2 - r_1)x} \right]_0^L$$

$$= \frac{\gamma}{3E(r_2 - r_1)} \left[r_1 L^2 + \frac{(r_2 - r_1)L^2}{2} \right] + \frac{\gamma r_1^3 L^3}{3E(r_2 - r_1)^2} \left[\frac{1}{r_2 L} - \frac{1}{r_1 L} \right]$$

$$= \frac{\gamma}{6E(r_2 - r_1)} [2r_1 L^2 + r_2 L^2 - r_1 L^2] + \frac{\gamma r_1^3 L^3}{3E(r_2 - r_1)^2} \left[\frac{-(r_2 - r_1)}{r_2 r_1 L} \right]$$

$$\delta = \frac{\gamma L^2 (r_2 + r_1)}{6E(r_2 - r_1)} - \frac{\gamma L^2 r_1^2}{3E r_2 (r_2 - r_1)}$$

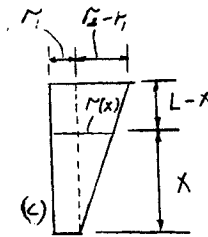
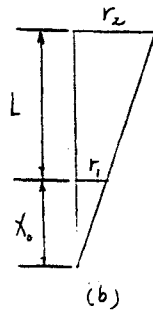

Therefore, adding the result of Prob. (4-24) we have

$$\delta = \frac{PL}{\pi E r_2 r_1} + \frac{\gamma L^2 (r_2 + r_1)}{6E(r_2 - r_1)} - \frac{\gamma L^2 r_1^2}{3E r_2 (r_2 - r_1)} \quad \text{Ans}$$

From *Mechanics of Materials*, Sixth Edition by R. C. Hibbeler, ISBN 0-13-191345-X.

© 2005 R. C. Hibbeler. Published by Pearson Prentice Hall,

Pearson Education, Inc., Upper Saddle River, NJ. All rights reserved.

This material is protected under all copyright laws as they currently exist. No portion of this material may be reproduced, in any form or by any means, without permission in writing from the publisher.

4-26 Determine the elongation of the tapered A-36 steel shaft when it is subjected to an axial force of 18 kip. *Hint:* Use the result of Prob. 4-24.

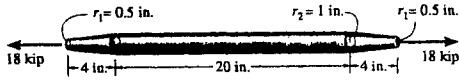

$$\delta = (2) \frac{PL_1}{\pi E r_2 r_1} + \frac{PL_2}{AE}$$

$$= \frac{(2)(18)(4)}{\pi(29)(10^3)(1)(0.5)} + \frac{18(20)}{\pi(1)^2(29)(10^3)}$$

$$= 0.00711 \text{ in.} \quad \text{Ans}$$

From *Mechanics of Materials*, Sixth Edition by R. C. Hibbeler, ISBN 0-13-191345-X.
 © 2005 R. C. Hibbeler. Published by Pearson Prentice Hall,
 Pearson Education, Inc., Upper Saddle River, NJ. All rights reserved.
 This material is protected under all copyright laws as they currently exist. No portion of this material may be reproduced, in any form or by any means, without permission in writing from the publisher.

4-27 Determine the relative displacement of one end of the tapered plate with respect to the other end when it is subjected to an axial load P .

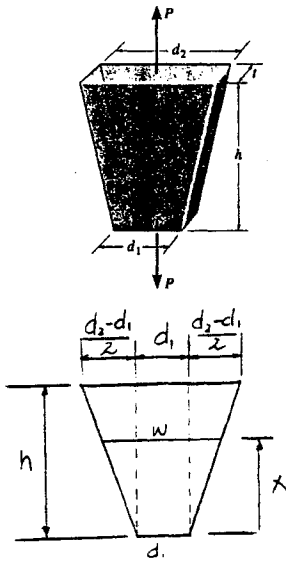

$$w = d_1 + \frac{d_2 - d_1}{h}x = \frac{d_1 h + (d_2 - d_1)x}{h}$$

$$\delta = \int \frac{P(x) dx}{A(x)E} = \frac{P}{E} \int_0^h \frac{dx}{\frac{[d_1 h + (d_2 - d_1)x]^2}{h}}$$

$$= \frac{Ph}{Et} \int_0^h \frac{dx}{d_1 h + (d_2 - d_1)x}$$

$$= \frac{Ph}{Et d_1 h} \int_0^h \frac{dx}{1 + \frac{d_2 - d_1}{d_1 h}x} = \frac{Ph}{Et d_1 h} \left(\frac{d_1 h}{d_2 - d_1} \right) \left[\ln \left(1 + \frac{d_2 - d_1}{d_1 h}x \right) \right]_0^h$$

$$= \frac{Ph}{Et(d_2 - d_1)} \left[\ln \left(1 + \frac{d_2 - d_1}{d_1} \right) \right] = \frac{Ph}{Et(d_2 - d_1)} \left[\ln \left(\frac{d_1 + d_2 - d_1}{d_1} \right) \right]$$

$$= \frac{Ph}{Et(d_2 - d_1)} \left[\ln \frac{d_2}{d_1} \right] \quad \text{Ans}$$

From *Mechanics of Materials*, Sixth Edition by R. C. Hibbeler, ISBN 0-13-191345-X.

© 2005 R. C. Hibbeler. Published by Pearson Prentice Hall,

Pearson Education, Inc., Upper Saddle River, NJ. All rights reserved.

This material is protected under all copyright laws as they currently exist. No portion of this material may be reproduced, in any form or by any means, without permission in writing from the publisher.

*4-28 Determine the elongation of the aluminum strap when it is subjected to an axial force of 30 kN. $E_{al} = 70 \text{ GPa}$.
Hint: Use the result of Prob. 4-27.

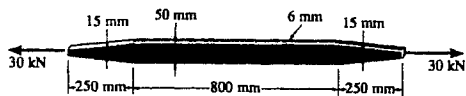

$$\delta = (2) \frac{Ph}{E(d_2 - d_1)} \ln \frac{d_2}{d_1} + \frac{PL}{AE}$$

$$= \frac{2(30)(10^3)(250)}{(70)(10^9)(0.006)(0.05 - 0.015)} \left(\ln \frac{50}{15} \right) + \frac{30(10^3)(800)}{(0.006)(0.05)(70)(10^9)}$$

$$= 2.37 \text{ mm} \quad \text{Ans}$$

From *Mechanics of Materials*, Sixth Edition by R. C. Hibbeler, ISBN 0-13-191345-X.

© 2005 R. C. Hibbeler. Published by Pearson Prentice Hall,

Pearson Education, Inc., Upper Saddle River, NJ. All rights reserved.

This material is protected under all copyright laws as they currently exist. No portion of this material may be reproduced, in any form or by any means, without permission in writing from the publisher.

4-29. Bone material has a stress-strain diagram that can be defined by the relation $\sigma = E[\epsilon/(1 + kE\epsilon)]$, where k and E are constants. Determine the compression within the length L of the bone, where it is assumed the cross-sectional area A of the bone is constant.

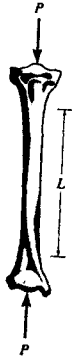

$$\sigma = \frac{P}{A}; \quad \epsilon = \frac{\delta x}{dx}$$

$$\sigma = E\left(\frac{\epsilon}{1 + kE\epsilon}\right); \quad \frac{P}{A} = \frac{E\left(\frac{\delta x}{dx}\right)}{1 + kE\left(\frac{\delta x}{dx}\right)}$$

$$\frac{P}{A} + \frac{PkE}{A}\left(\frac{\delta x}{dx}\right) = E\left(\frac{\delta x}{dx}\right)$$

$$\frac{P}{A} = \left(E - \frac{PkE}{A}\right)\left(\frac{\delta x}{dx}\right)$$

$$\int_0^{\delta} \delta x = \int_0^L \frac{P dx}{A\left(kE - \frac{Pk}{A}\right)}$$

$$\delta = \frac{\frac{PL}{AE}}{\left(1 - \frac{Pk}{A}\right)} = \frac{PL}{E(A - Pk)}$$

Ans.

From *Mechanics of Materials*, Sixth Edition by R. C. Hibbeler, ISBN 0-13-191345-X.

© 2005 R. C. Hibbeler. Published by Pearson Prentice Hall,

Pearson Education, Inc., Upper Saddle River, NJ. All rights reserved.

This material is protected under all copyright laws as they currently exist. No portion of this material may be reproduced, in any form or by any means, without permission in writing from the publisher.

4-30 The pedestal is made in a shape that has a radius defined by the function $r = 2/(2 + y^{1/2})$ ft, where y is in feet. If the modulus of elasticity for the material is $E = 14(10^3)$ ksi, determine the displacement of its top when it supports the 500-lb load.

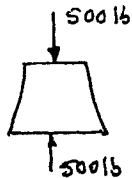
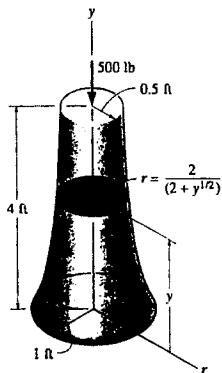

$$\begin{aligned} \delta &= \int \frac{P(y) dy}{A(y)E} \\ &= \frac{500}{14(10^3)(144)} \int_0^4 \frac{dy}{\pi \left(\frac{2}{2+y^{1/2}} \right)^2} \\ &= 0.01974(10^{-3}) \int_0^4 (4 + 4y^{1/2} + y) dy \\ &= 0.01974(10^{-3}) \left[4y + 4 \left(\frac{2}{3} y^{3/2} \right) + \frac{1}{2} y^2 \right]_0^4 \\ &= 0.01974(10^{-3}) (45.33) \\ &= 0.8947(10^{-3}) \text{ ft} = 0.0107 \text{ in.} \quad \text{Ans} \end{aligned}$$

From *Mechanics of Materials*, Sixth Edition by R. C. Hibbeler, ISBN 0-13-191345-X.

© 2005 R. C. Hibbeler. Published by Pearson Prentice Hall,

Pearson Education, Inc., Upper Saddle River, NJ. All rights reserved.

This material is protected under all copyright laws as they currently exist. No portion of this material may be reproduced, in any form or by any means, without permission in writing from the publisher.

4-31. The A-36 steel column, having a cross-sectional area of 18 in^2 , is encased in high-strength concrete as shown. If an axial force of 60 kip is applied to the column, determine the average compressive stress in the concrete and in the steel. How far does the column shorten? It has an original length of 8 ft.

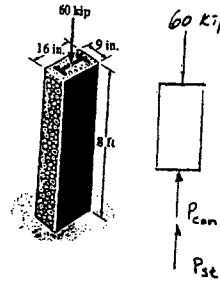

From *Mechanics of Materials*, Sixth Edition by R. C. Hibbeler, ISBN 0-13-191345-X.

© 2005 R. C. Hibbeler. Published by Pearson Prentice Hall,

Pearson Education, Inc., Upper Saddle River, NJ. All rights reserved.

This material is protected under all copyright laws as they currently exist. No portion of this material may be reproduced, in any form or by any means, without permission in writing from the publisher.

*4-32 The A-36 steel column is encased in high-strength concrete as shown. If an axial force of 60 kip is applied to the column, determine the required area of the steel so that the force is shared equally between the steel and concrete. How far does the column shorten? It has an original length of 8 ft.

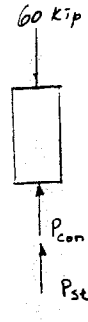
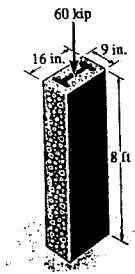

The force of 60 kip is shared equally by the concrete and steel. Hence

$$P_{st} = P_{con} = P = 30 \text{ kip}$$

$$\delta_{con} = \delta_{st} ; \quad \frac{PL}{A_{con}E_{con}} = \frac{PL}{A_{st}E_{st}}$$

$$A_{st} = \frac{A_{con}E_{con}}{E_{st}} = \frac{[9(16) - A_{st}] 4.20(10^3)}{29(10^3)} = 18.2 \text{ in}^2 \quad \text{Ans}$$

$$\delta = \frac{P_{st}L}{A_{st}E_{st}} = \frac{30(8)(12)}{18.2(29)(10^3)} = 0.00545 \text{ in.} \quad \text{Ans}$$

From *Mechanics of Materials*, Sixth Edition by R. C. Hibbeler, ISBN 0-13-191345-X.

© 2005 R. C. Hibbeler. Published by Pearson Prentice Hall,

Pearson Education, Inc., Upper Saddle River, NJ. All rights reserved.

This material is protected under all copyright laws as they currently exist. No portion of this material may be reproduced, in any form or by any means, without permission in writing from the publisher.

4-33 The steel pipe is filled with concrete and subjected to a compressive force of 80 kN. Determine the stress in the concrete and the steel due to this loading. The pipe has an outer diameter of 80 mm and an inner diameter of 70 mm. $E_{st} = 200 \text{ GPa}$, $E_c = 24 \text{ GPa}$.

$$+ \uparrow \Sigma F_y = 0; \quad P_{st} + P_{con} - 80 = 0 \quad (1)$$

$$\delta_{st} = \delta_{con}$$

$$\frac{P_{st} L}{\frac{\pi}{4} (0.08^2 - 0.07^2) (200) (10^9)} = \frac{P_{con} L}{\frac{\pi}{4} (0.07^2) (24) (10^9)}$$

$$P_{st} = 2.5510 P_{con} \quad (2)$$

Solving Eqs. (1) and (2) yields

$$P_{st} = 57.47 \text{ kN} \quad P_{con} = 22.53 \text{ kN}$$

$$\sigma_{st} = \frac{P_{st}}{A_{st}} = \frac{57.47 (10^3)}{\frac{\pi}{4} (0.08^2 - 0.07^2)} = 48.8 \text{ MPa} \quad \text{Ans}$$

$$\sigma_{con} = \frac{P_{con}}{A_{con}} = \frac{22.53 (10^3)}{\frac{\pi}{4} (0.07^2)} = 5.85 \text{ MPa} \quad \text{Ans}$$

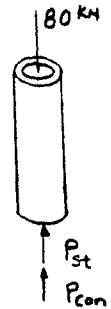
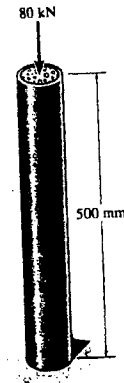

From *Mechanics of Materials*, Sixth Edition by R. C. Hibbeler, ISBN 0-13-191345-X.

© 2005 R. C. Hibbeler. Published by Pearson Prentice Hall,

Pearson Education, Inc., Upper Saddle River, NJ. All rights reserved.

This material is protected under all copyright laws as they currently exist. No portion of this material may be reproduced, in any form or by any means, without permission in writing from the publisher.

4-34. The concrete column is reinforced using four steel reinforcing rods, each having a diameter of 18 mm. Determine the stress in the concrete and the steel if the column is subjected to an axial load of 800 kN. $E_{st} = 200 \text{ GPa}$, $E_c = 25 \text{ GPa}$.

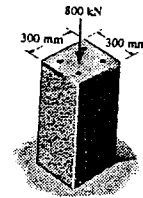

Equilibrium :

$$+\uparrow \Sigma F_y = 0; \quad P_{st} + P_{con} - 800 = 0 \quad [1]$$

Compatibility :

$$\frac{P_{st}(L)}{4\left(\frac{\pi}{4}\right)(0.018^2)(200)(10^9)} = \frac{P_{con}(L)}{\left[0.3^2 - 4\left(\frac{\pi}{4}\right)(0.018^2)\right](25)(10^9)}$$

$$P_{st} = 0.091513 P_{con} \quad [2]$$

Solving Eqs. [1] and [2] yields :

$$P_{st} = 67.072 \text{ kN} \quad P_{con} = 732.928 \text{ kN}$$

Average Normal Stress :

$$\sigma_{st} = \frac{67.072(10^3)}{4\left(\frac{\pi}{4}\right)(0.018^2)} = 65.9 \text{ MPa} \quad \text{Ans}$$

$$\sigma_{con} = \frac{732.928(10^3)}{\left[0.3^2 - 4\left(\frac{\pi}{4}\right)(0.018^2)\right]} = 8.24 \text{ MPa} \quad \text{Ans}$$

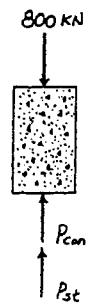

From *Mechanics of Materials*, Sixth Edition by R. C. Hibbeler, ISBN 0-13-191345-X.

© 2005 R. C. Hibbeler. Published by Pearson Prentice Hall,

Pearson Education, Inc., Upper Saddle River, NJ. All rights reserved.

This material is protected under all copyright laws as they currently exist. No portion of this material may be reproduced, in any form or by any means, without permission in writing from the publisher.

4-35. The column is constructed from high-strength concrete and four A-36 steel reinforcing rods. If it is subjected to an axial force of 800 kN, determine the required diameter of each rod so that one-fourth of the load is carried by the steel and three-fourths by the concrete. $E_{st} = 200 \text{ GPa}$, $E_c = 25 \text{ GPa}$.

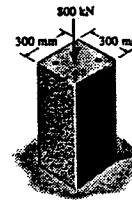

Equilibrium : Require $P_{st} = \frac{1}{4}(800) = 200 \text{ kN}$ and

$P_{con} = \frac{3}{4}(800) = 600 \text{ kN}$.

Compatibility :

$$\begin{aligned} \delta_{con} &= \delta_{st} \\ \frac{P_{con} L}{(0.3^2 - A_{st})(25.0 \times 10^9)} &= \frac{P_{st} L}{A_{st}(200)(10^9)} \\ A_{st} &= \frac{0.09 P_{st}}{8 P_{con} + P_{st}} \\ 4 \left[\left(\frac{\pi}{4} \right) d^2 \right] &= \frac{0.09(200)}{8(600) + 200} \\ d &= 0.03385 \text{ m} = 33.9 \text{ mm} \quad \text{Ans} \end{aligned}$$

From *Mechanics of Materials*, Sixth Edition by R. C. Hibbeler, ISBN 0-13-191345-X.

© 2005 R. C. Hibbeler. Published by Pearson Prentice Hall,

Pearson Education, Inc., Upper Saddle River, NJ. All rights reserved.

This material is protected under all copyright laws as they currently exist. No portion of this material may be reproduced, in any form or by any means, without permission in writing from the publisher.

*4-36 The A-36 steel pipe has an outer radius of 20 mm and an inner radius of 15 mm. If it fits snugly between the fixed walls before it is loaded, determine the reaction at the walls when it is subjected to the load shown.

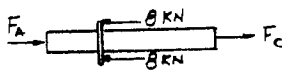
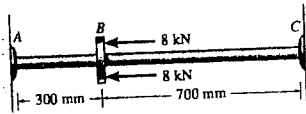

$$\rightarrow \Sigma F_x = 0; \quad F_A + F_C - 16 = 0 \quad (1)$$

By superposition :

$$(\rightarrow) \quad 0 = -\Delta_C + \delta_C$$

$$0 = \frac{-16(300)}{AE} + \frac{F_C(1000)}{AE}$$

$$F_C = 4.80 \text{ kN} \quad \text{Ans}$$

From Eq. (1),

$$F_A = 11.2 \text{ kN} \quad \text{Ans}$$

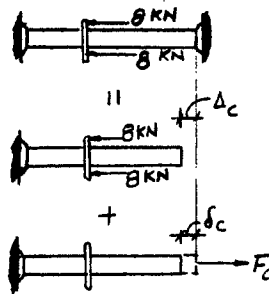

From *Mechanics of Materials*, Sixth Edition by R. C. Hibbeler, ISBN 0-13-191345-X.

© 2005 R. C. Hibbeler. Published by Pearson Prentice Hall,

Pearson Education, Inc., Upper Saddle River, NJ. All rights reserved.

This material is protected under all copyright laws as they currently exist. No portion of this material may be reproduced, in any form or by any means, without permission in writing from the publisher.

4-37 The composite bar consists of a 20-mm-diameter A-36 steel segment AB and 50-mm-diameter red brass C83400 end segments DA and CB . Determine the average normal stress in each segment due to the applied load.

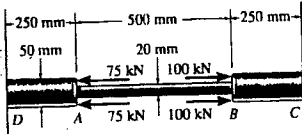

$$\uparrow + \Sigma F_x = 0; \quad F_C - F_D + 75 + 75 - 100 - 100 = 0$$

$$F_C - F_D - 50 = 0 \quad (1)$$

$$\uparrow + \quad 0 = \Delta_D - \delta_D$$

$$0 = \frac{150(0.5)}{\frac{\pi}{4}(0.02)^2(200)(10^9)} - \frac{50(0.25)}{\frac{\pi}{4}(0.05)^2(101)(10^9)} - \frac{F_D(0.5)}{\frac{\pi}{4}(0.05)^2(101)(10^9)} - \frac{F_D(0.5)}{\frac{\pi}{4}(0.02)^2(200)(10^9)}$$

$$F_D = 107.89 \text{ kN}$$

From Eq. (1), $F_C = 157.89 \text{ kN}$

$$\sigma_{AD} = \frac{P_{AD}}{A_{AD}} = \frac{107.89(10^3)}{\frac{\pi}{4}(0.05)^2} = 55.0 \text{ MPa} \quad \text{Ans}$$

$$\sigma_{AB} = \frac{P_{AB}}{A_{AB}} = \frac{42.11(10^3)}{\frac{\pi}{4}(0.02)^2} = 134 \text{ MPa} \quad \text{Ans}$$

$$\sigma_{BC} = \frac{P_{BC}}{A_{BC}} = \frac{157.89(10^3)}{\frac{\pi}{4}(0.05)^2} = 80.4 \text{ MPa} \quad \text{Ans}$$

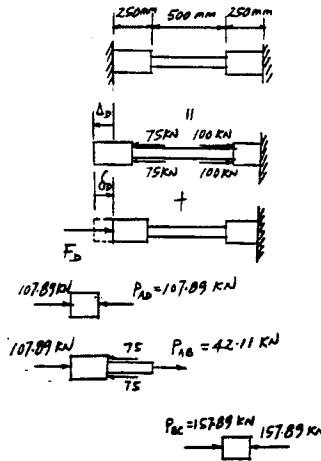

From *Mechanics of Materials*, Sixth Edition by R. C. Hibbeler, ISBN 0-13-191345-X.
 © 2005 R. C. Hibbeler. Published by Pearson Prentice Hall,
 Pearson Education, Inc., Upper Saddle River, NJ. All rights reserved.
 This material is protected under all copyright laws as they currently exist. No portion of this material may be reproduced, in any form or by any means, without permission in writing from the publisher.

4-38 The composite bar consists of a 20-mm-diameter A-36 steel segment AB and 50-mm-diameter red brass C83400 end segments DA and CB . Determine the displacement of A with respect to B due to the applied load.

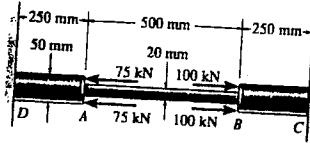

$$\uparrow \quad 0 = \Delta_D - \delta_D$$

$$0 = \frac{150(10^3)(500)}{\frac{\pi}{4}(0.02)^2(200)(10^9)} - \frac{50(10^3)(250)}{\frac{\pi}{4}(0.05)^2(101)(10^9)}$$

$$- \frac{F_D(500)}{\frac{\pi}{4}(0.05)^2(101)(10^9)} - \frac{F_D(500)}{\frac{\pi}{4}(0.02)^2(200)(10^9)}$$

$$F_D = 107.89 \text{ kN}$$

Displacement :

$$\delta_{A/B} = \frac{P_{AB}L_{AB}}{A_{AB}E_{st}} = \frac{42.11(10^3)(500)}{\frac{\pi}{4}(0.02)^2(200)(10^9)}$$

$$= 0.335 \text{ mm}$$

Ans

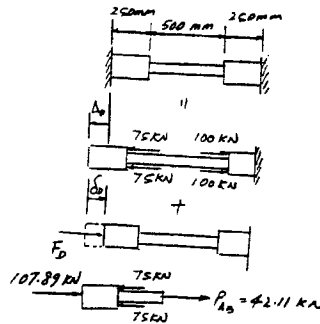

From *Mechanics of Materials*, Sixth Edition by R. C. Hibbeler, ISBN 0-13-191345-X.

© 2005 R. C. Hibbeler. Published by Pearson Prentice Hall,

Pearson Education, Inc., Upper Saddle River, NJ. All rights reserved.

This material is protected under all copyright laws as they currently exist. No portion of this material may be reproduced, in any form or by any means, without permission in writing from the publisher.

4-39 The load of 2800 lb is to be supported by the two essentially vertical A-36 steel wires. If originally wire AB is 60 in. long and wire AC is 40 in. long, determine the force developed in each wire after the load is suspended. Each wire has a cross-sectional area of 0.02 in^2 .

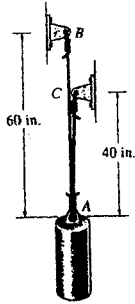

$$+\uparrow \Sigma F_y = 0; T_{AB} + T_{AC} - 2800 = 0$$

$$\delta_{AB} = \delta_{AC}$$

$$\frac{T_{AB}(60)}{AE} = \frac{T_{AC}(40)}{AE}$$

$$1.5T_{AB} = T_{AC}$$



Solving,

$$T_{AB} = 1.12 \text{ kip} \quad \text{Ans}$$

$$T_{AC} = 1.68 \text{ kip} \quad \text{Ans}$$

From *Mechanics of Materials*, Sixth Edition by R. C. Hibbeler, ISBN 0-13-191345-X.

© 2005 R. C. Hibbeler. Published by Pearson Prentice Hall,

Pearson Education, Inc., Upper Saddle River, NJ. All rights reserved.

This material is protected under all copyright laws as they currently exist. No portion of this material may be reproduced, in any form or by any means, without permission in writing from the publisher.

*4-40 The load of 2800 lb is to be supported by the two essentially vertical A-36 steel wires. If originally wire AB is 60 in. long and wire AC is 40 in. long, determine the cross-sectional area of AB if the load is to be shared equally between both wires. Wire AC has a cross-sectional area of 0.02 in^2 .

$$T_{AC} = T_{AB} = \frac{2800}{2} = 1400 \text{ lb}$$

$$\delta_{AC} = \delta_{AB}$$

$$\frac{1400(40)}{(0.02)(29)(10^6)} = \frac{1400(60)}{A_{AB}(29)(10^6)}$$

$$A_{AB} = 0.03 \text{ in}^2 \quad \text{Ans}$$

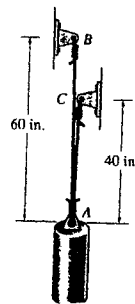

From *Mechanics of Materials*, Sixth Edition by R. C. Hibbeler, ISBN 0-13-191345-X.
 © 2005 R. C. Hibbeler. Published by Pearson Prentice Hall,
 Pearson Education, Inc., Upper Saddle River, NJ. All rights reserved.
 This material is protected under all copyright laws as they currently exist. No portion of this material may be reproduced, in any form or by any means, without permission in writing from the publisher.

4-41 The support consists of a solid red brass C83400 post surrounded by a 304 stainless steel tube. Before the load is applied the gap between these two parts is 1 mm. Given the dimensions shown, determine the greatest axial load that can be applied to the rigid cap A without causing yielding of any one of the materials.

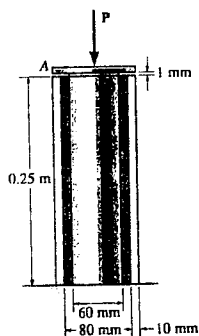

Require,

$$\delta_{st} = \delta_{br} + 0.001$$

$$\frac{F_{st}(0.25)}{\pi[(0.05)^2 - (0.04)^2]193(10^9)} = \frac{F_{br}(0.25)}{\pi(0.03)^2(101)(10^9)} + 0.001$$

$$0.45813 F_{st} = 0.87544 F_{br} + 10^6 \quad (1)$$

$$+\uparrow \Sigma F_y = 0; \quad F_{st} + F_{br} - P = 0 \quad (2)$$

Assume brass yields, then

$$(F_{br})_{max} = \sigma_Y A_{br} = 70(10^6)(\pi)(0.03)^2 = 197\,920.3 \text{ N}$$

$$(\epsilon_Y)_{br} = \sigma_Y/E = \frac{70.0(10^6)}{101(10^9)} = 0.6931(10^{-3}) \text{ mm/mm}$$

$$\delta_{br} = (\epsilon_Y)_{br} L = 0.6931(10^{-3})(0.25) = 0.1733 \text{ mm} < 1 \text{ mm}$$

Thus only the brass is loaded.

$$P = F_{br} = 198 \text{ kN} \quad \text{Ans}$$

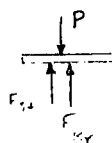
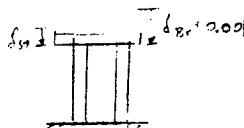

From *Mechanics of Materials*, Sixth Edition by R. C. Hibbeler, ISBN 0-13-191345-X.

© 2005 R. C. Hibbeler. Published by Pearson Prentice Hall,

Pearson Education, Inc., Upper Saddle River, NJ. All rights reserved.

This material is protected under all copyright laws as they currently exist. No portion of this material may be reproduced, in any form or by any means, without permission in writing from the publisher.

4-42 Two A-36 steel wires are used to support the 650-lb engine. Originally, AB is 32 in. long and $A'B'$ is 32.008 in. long. Determine the force supported by each wire when the engine is suspended from them. Each wire has a cross-sectional area of 0.01 in^2 .

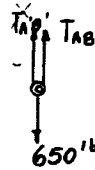
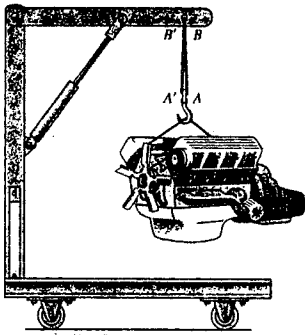

$$+\uparrow \Sigma F_y = 0; \quad T_{A'B'} + T_{AB} - 650 = 0 \quad (1)$$

$$\delta_{AB} = \delta_{A'B'} + 0.008$$

$$\frac{T_{AB}(32)}{(0.01)(29)(10^6)} = \frac{T_{A'B'}(32.008)}{(0.01)(29)(10^6)} + 0.008$$

$$32T_{AB} - 32.008T_{A'B'} = 2320$$

$$T_{AB} = 361 \text{ lb} \quad \text{Ans}$$

$$T_{A'B'} = 289 \text{ lb} \quad \text{Ans}$$

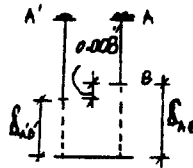

From *Mechanics of Materials*, Sixth Edition by R. C. Hibbeler, ISBN 0-13-191345-X.

© 2005 R. C. Hibbeler. Published by Pearson Prentice Hall,

Pearson Education, Inc., Upper Saddle River, NJ. All rights reserved.

This material is protected under all copyright laws as they currently exist. No portion of this material may be reproduced, in any form or by any means, without permission in writing from the publisher.

4-43. The center post B of the assembly has an original length of 124.7 mm, whereas posts A and C have a length of 125 mm. If the caps on the top and bottom can be considered rigid, determine the average normal stress in each post. The posts are made of aluminum and have a cross-sectional area of 400 mm^2 . $E_{al} = 70 \text{ GPa}$.

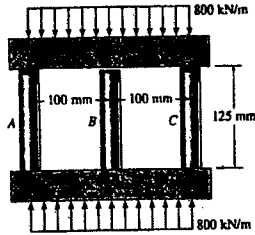

$$\curvearrowleft + \Sigma M_B = 0; \quad -F_A(100) + F_C(100) = 0$$

$$F_A = F_C = F \quad (1)$$

$$+ \uparrow \Sigma F_y = 0; \quad 2F + F_B - 160 = 0 \quad (2)$$

$$\delta_A = \delta_B + 0.0003$$

$$\frac{F(0.125)}{400(10^{-6})(70)(10^6)} = \frac{F_B(0.1247)}{400(10^{-6})(70)(10^6)} + 0.0003$$

$$0.125F - 0.1247F_B = 8.4 \quad (3)$$

Solving Eqs. (2) and (3)

$$F = 75.726 \text{ kN}$$

$$F_B = 8.547 \text{ kN}$$

$$\sigma_A = \sigma_C = \frac{75.726(10^3)}{400(10^{-6})} = 189 \text{ MPa} \quad \text{Ans}$$

$$\sigma_B = \frac{8.547(10^3)}{400(10^{-6})} = 21.4 \text{ MPa} \quad \text{Ans}$$

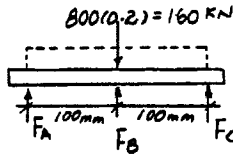

From *Mechanics of Materials*, Sixth Edition by R. C. Hibbeler, ISBN 0-13-191345-X.

© 2005 R. C. Hibbeler. Published by Pearson Prentice Hall,

Pearson Education, Inc., Upper Saddle River, NJ. All rights reserved.

This material is protected under all copyright laws as they currently exist. No portion of this material may be reproduced, in any form or by any means, without permission in writing from the publisher.

*4-44. The specimen represents a filament-reinforced matrix system made from plastic (matrix) and glass (fiber). If there are n fibers, each having a cross-sectional area of A_f and modulus of E_f , embedded in a matrix having a cross-sectional area of A_m and modulus of E_m , determine the stress in the matrix and each fiber when the force P is imposed on the specimen.

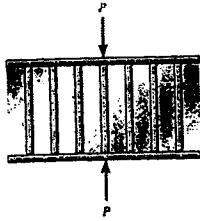

$$+\uparrow \Sigma F_y = 0; \quad P - P_m - P_f = 0 \quad (1)$$

$$\delta_m = \delta_f$$

$$\frac{P_m L}{A_m E_m} = \frac{P_f L}{n A_f E_f}; \quad P_m = \frac{A_m E_m}{n A_f E_f} P_f \quad (2)$$

Solving Eqs. (1) and (2) yields

$$P_m = \frac{A_m E_m}{n A_f E_f + A_m E_m} P; \quad P_f = \frac{n A_f E_f}{n A_f E_f + A_m E_m} P$$

Normal stress :

$$\sigma_m = \frac{P_m}{A_m} = \frac{\left(\frac{A_m E_m}{n A_f E_f + A_m E_m} P\right)}{A_m} = \frac{E_m}{n A_f E_f + A_m E_m} P \quad \text{Ans}$$

$$\sigma_f = \frac{P_f}{n A_f} = \frac{\left(\frac{n A_f E_f}{n A_f E_f + A_m E_m} P\right)}{n A_f} = \frac{E_f}{n A_f E_f + A_m E_m} P \quad \text{Ans}$$

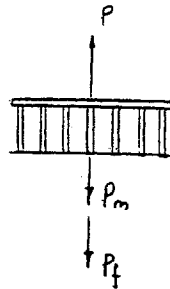

From *Mechanics of Materials*, Sixth Edition by R. C. Hibbeler, ISBN 0-13-191345-X.

© 2005 R. C. Hibbeler. Published by Pearson Prentice Hall,

Pearson Education, Inc., Upper Saddle River, NJ. All rights reserved.

This material is protected under all copyright laws as they currently exist. No portion of this material may be reproduced, in any form or by any means, without permission in writing from the publisher.

4-45 The distributed loading is supported by the three suspender bars. AB and EF are made from aluminum and CD is made from steel. If each bar has a cross-sectional area of 450 mm^2 , determine the maximum intensity w of the distributed loading so that an allowable stress of $(\sigma_{\text{allow}})_{st} = 180 \text{ MPa}$ in the steel, and $(\sigma_{\text{allow}})_{al} = 94 \text{ MPa}$ in the aluminum is not exceeded. $E_{st} = 200 \text{ GPa}$, $E_{al} = 70 \text{ GPa}$.

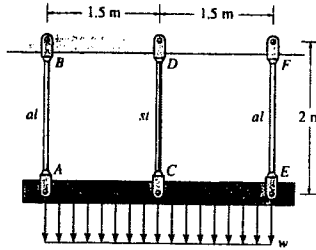

$$\zeta + \sum M_C = 0; \quad F_{EF}(1.5) - F_{AB}(1.5) = 0$$

$$F_{EF} = F_{AB} = F$$

$$+\uparrow \sum F_y = 0; \quad 2F + F_{CD} - 3w = 0 \quad (1)$$

Compatibility condition :

$$\delta_A = \delta_C$$

$$\frac{FL}{A(70)(10^9)} = \frac{F_{CD}L}{A(200)(10^9)}; \quad F = 0.35 F_{CD} \quad (2)$$

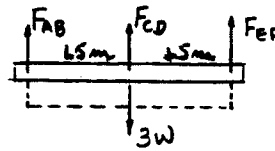

Assume failure of AB and EF :

$$F = (\sigma_{\text{allow}})_{al}A$$

$$= 94(10^6)(450)(10^{-6})$$

$$= 42300 \text{ N}$$

From Eq. (2) $F_{CD} = 120857.14 \text{ N}$

From Eq. (1) $w = 68.5 \text{ kN/m}$

Assume failure of CD :

$$F_{CD} = (\sigma_{\text{allow}})_{st}A$$

$$= 180(10^6)(450)(10^{-6})$$

$$= 81000 \text{ N}$$

From Eq. (2) $F = 28350 \text{ N}$

From Eq. (1) $w = 45.9 \text{ kN/m}$ (controls) **Ans**

From *Mechanics of Materials*, Sixth Edition by R. C. Hibbeler, ISBN 0-13-191345-X.
 © 2005 R. C. Hibbeler. Published by Pearson Prentice Hall,
 Pearson Education, Inc., Upper Saddle River, NJ. All rights reserved.
 This material is protected under all copyright laws as they currently exist. No portion of this material may be reproduced, in any form or by any means, without permission in writing from the publisher.

4-46 The beam is pinned at A and supported by two aluminum rods, each having a diameter of 1 in. and a modulus of elasticity $E_{al} = 10(10^3)$ ksi. If the beam is assumed to be rigid and initially horizontal, determine the displacement of the end B when the force of 5 kip is applied.

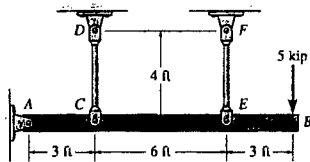

$$(+\Sigma M_A = 0; \quad F_{CD}(3) + F_{EF}(9) - 5(12) = 0$$

$$3F_{CD} + 9F_{EF} = 60 \quad (1)$$

$$\frac{\delta_C}{3} = \frac{\delta_E}{9}$$

$$\frac{F_{CD}(L)}{3AE} = \frac{F_{EF}(L)}{9AE}$$

$$F_{EF} = 3F_{CD} \quad (2)$$

Solving Eqs. (1) and (2) yields

$$F_{CD} = 2 \text{ kip}$$

$$F_{EF} = 6 \text{ kip}$$

$$\delta_E = \frac{F_{EF}L}{AE} = \frac{6(4)(12)}{\frac{\pi}{4}(1)^2(10)(10^3)} = 0.03667 \text{ in.}$$

$$\frac{\delta_B}{12} = \frac{\delta_E}{9}$$

$$\delta_B = \left(\frac{12}{9}\right)(0.03667) = 0.0489 \text{ in.} \quad \text{Ans}$$

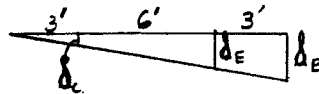
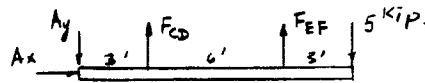

From *Mechanics of Materials*, Sixth Edition by R. C. Hibbeler, ISBN 0-13-191345-X.

© 2005 R. C. Hibbeler. Published by Pearson Prentice Hall,

Pearson Education, Inc., Upper Saddle River, NJ. All rights reserved.

This material is protected under all copyright laws as they currently exist. No portion of this material may be reproduced, in any form or by any means, without permission in writing from the publisher.

4-47 The bar is pinned at A and supported by two aluminum rods, each having a diameter of 1 in. and a modulus of elasticity $E_{al} = 10(10^3)$ ksi. If the bar is assumed to be rigid and initially horizontal, determine the force in each rod when the 5-kip load is applied.

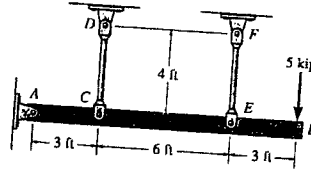

$$\curvearrowleft \Sigma M_A = 0; \quad F_{CD}(3) + F_{EF}(9) - 5(12) = 0 \quad (1)$$

$$\frac{\delta_C}{3} = \frac{\delta_E}{9}; \quad \delta_E = 3 \delta_C$$

$$\frac{F_{EF}L}{AE} = \frac{3F_{CD}L}{AE}$$

$$F_{EF} = 3F_{CD}$$

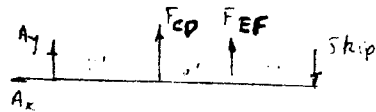

From Eq. (1),

$$F_{CD} = 2 \text{ kip} \quad \text{Ans}$$

$$F_{EF} = 6 \text{ kip} \quad \text{Ans}$$

From *Mechanics of Materials*, Sixth Edition by R. C. Hibbeler, ISBN 0-13-191345-X.

© 2005 R. C. Hibbeler. Published by Pearson Prentice Hall,

Pearson Education, Inc., Upper Saddle River, NJ. All rights reserved.

This material is protected under all copyright laws as they currently exist. No portion of this material may be reproduced, in any form or by any means, without permission in writing from the publisher.

*4-48 The horizontal beam is assumed to be rigid and supports the distributed load shown. Determine the vertical reactions at the supports. Each support consists of a wooden post having a diameter of 120 mm and an unloaded (original) length of 1.40 m. Take $E_w = 12$ GPa.

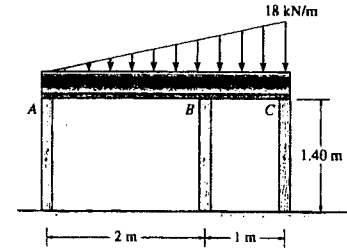

$$\left(\uparrow \Sigma M_B = 0; \quad F_C(1) - F_A(2) = 0 \quad (1) \right.$$

$$+ \uparrow \Sigma F_y = 0; \quad F_A + F_B + F_C - 27 = 0 \quad (2)$$

$$\frac{\delta_B - \delta_A}{2} = \frac{\delta_C - \delta_A}{3}; \quad 3\delta_B - \delta_A = 2\delta_C$$

$$\frac{3F_B L}{AE} - \frac{F_A L}{AE} = \frac{2F_C L}{AE}; \quad 3F_B - F_A = 2F_C \quad (3)$$

Solving Eqs. (1) - (3) yields :

$$F_A = 5.79 \text{ kN} \quad \text{Ans}$$

$$F_B = 9.64 \text{ kN} \quad \text{Ans}$$

$$F_C = 11.6 \text{ kN} \quad \text{Ans}$$

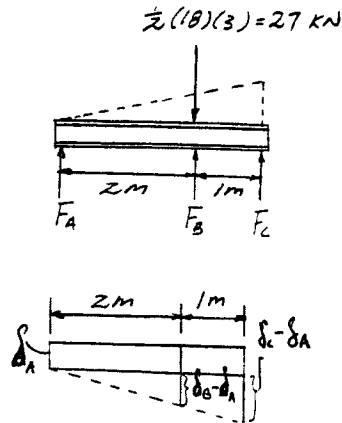

From *Mechanics of Materials*, Sixth Edition by R. C. Hibbeler, ISBN 0-13-191345-X.

© 2005 R. C. Hibbeler. Published by Pearson Prentice Hall,

Pearson Education, Inc., Upper Saddle River, NJ. All rights reserved.

This material is protected under all copyright laws as they currently exist. No portion of this material may be reproduced, in any form or by any means, without permission in writing from the publisher.

4-49 The horizontal beam is assumed to be rigid and supports the distributed load shown. Determine the angle of tilt of the beam after the load is applied. Each support consists of a wooden post having a diameter of 120 mm and an unloaded (original) length of 1.40 m. Take $E_w = 12$ GPa.

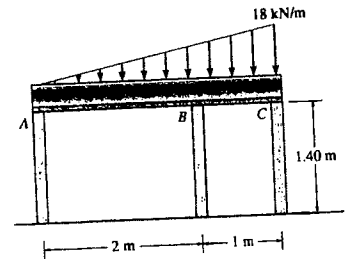

$$\curvearrowleft + \Sigma M_B = 0; \quad F_C(1) - F_A(2) = 0 \quad (1)$$

$$\uparrow + \Sigma F_y = 0; \quad F_A + F_B + F_C - 27 = 0 \quad (2)$$

$$\frac{\delta_B - \delta_A}{2} = \frac{\delta_C - \delta_A}{3}; \quad 3\delta_B - \delta_A = 2\delta_C$$

$$\frac{3F_B L}{AE} - \frac{F_A L}{AE} = \frac{2F_C L}{AE}; \quad 3F_B - F_A = 2F_C \quad (3)$$

Solving Eqs. (1) - (3) yields :

$$F_A = 5.7857 \text{ kN}; \quad F_B = 9.6428 \text{ kN}; \quad F_C = 11.5714 \text{ kN}$$

$$\delta_A = \frac{F_A L}{AE} = \frac{5.7857(10^3)(1.40)}{\frac{\pi}{4}(0.12^2)12(10^9)} = 0.0597(10^{-3}) \text{ m}$$

$$\delta_C = \frac{F_C L}{AE} = \frac{11.5714(10^3)(1.40)}{\frac{\pi}{4}(0.12^2)12(10^9)} = 0.1194(10^{-3}) \text{ m}$$

$$\tan \theta = \frac{0.1194 - 0.0597}{3}(10^{-3})$$

$$\theta = 0.0199(10^{-3}) \text{ rad} = 1.14(10^{-3})^\circ \quad \text{Ans}$$

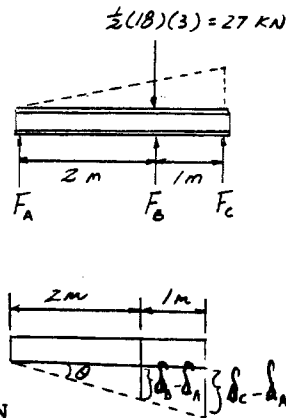

From *Mechanics of Materials*, Sixth Edition by R. C. Hibbeler, ISBN 0-13-191345-X.
 © 2005 R. C. Hibbeler. Published by Pearson Prentice Hall,
 Pearson Education, Inc., Upper Saddle River, NJ. All rights reserved.
 This material is protected under all copyright laws as they currently exist. No portion of this material may be reproduced, in any form or by any means, without permission in writing from the publisher.

4-50. The three suspender bars are made of the same material and have equal cross-sectional areas A . Determine the average normal stress in each bar if the rigid beam ACE is subjected to the force P .

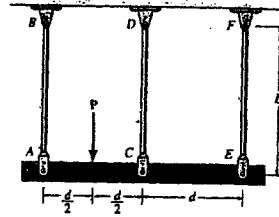

$$\begin{aligned} \curvearrowright + \Sigma M_A = 0; \quad F_{CD}(d) + F_{EF}(2d) - P\left(\frac{d}{2}\right) &= 0 \\ F_{CD} + 2F_{EF} &= \frac{P}{2} \quad (1) \end{aligned}$$

$$+\uparrow \Sigma F_y = 0; \quad F_{AB} + F_{CD} + F_{EF} - P = 0 \quad (2)$$

$$\frac{\delta_C - \delta_E}{d} = \frac{\delta_A - \delta_E}{2d}$$

$$2\delta_C = \delta_A + \delta_E$$

$$\frac{2F_{CD}L}{AE} = \frac{F_{AB}L}{AE} + \frac{F_{EF}L}{AE}$$

$$2F_{CD} - F_{AB} - F_{EF} = 0 \quad (3)$$

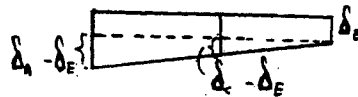
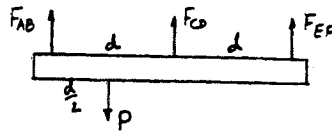

Solving Eqs. (1), (2) and (3) yields

$$F_{AB} = \frac{7P}{12} \quad F_{CD} = \frac{P}{3} \quad F_{EF} = \frac{P}{12}$$

$$\sigma_{AB} = \frac{7P}{12A} \quad \text{Ans}$$

$$\sigma_{CD} = \frac{P}{3A} \quad \text{Ans}$$

$$\sigma_{EF} = \frac{P}{12A} \quad \text{Ans}$$

From *Mechanics of Materials*, Sixth Edition by R. C. Hibbeler, ISBN 0-13-191345-X.

© 2005 R. C. Hibbeler. Published by Pearson Prentice Hall,

Pearson Education, Inc., Upper Saddle River, NJ. All rights reserved.

This material is protected under all copyright laws as they currently exist. No portion of this material may be reproduced, in any form or by any means, without permission in writing from the publisher.

4-51. The rigid bar is supported by the two short wooden posts and a spring. If each of the posts has an unloaded length of 500 mm and a cross-sectional area of 800 mm², and the spring has a stiffness of $k = 1.8 \text{ MN/m}$ and an unstretched length of 520 mm, determine the force in each post after the load is applied to the bar. $E_w = 11 \text{ GPa}$.

Due to symmetrical system and loading

$$F_A = F_B = F$$

$$+\uparrow \Sigma F_y = 0; \quad F_{sp} + 2F - 120(10^3) = 0 \quad (1)$$

Spring equation :

$$F_{sp} = k(\delta_A + 0.02)$$

$$= 1.8(10^6) \left(\frac{F(0.5)}{800(10^{-6})(11)(10^9)} + 0.02 \right)$$

$$= 0.10227 F + 36000 \quad (2)$$

Solving Eqs. (1) and (2) yields

$$F_{sp} = 40.1 \text{ kN}$$

$$F = 40.0 \text{ kN} \quad \text{Ans}$$

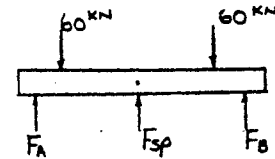
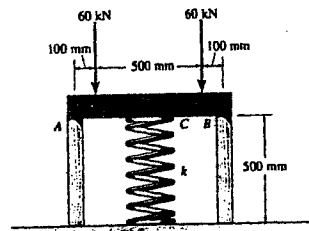

From *Mechanics of Materials*, Sixth Edition by R. C. Hibbeler, ISBN 0-13-191345-X.

© 2005 R. C. Hibbeler. Published by Pearson Prentice Hall,

Pearson Education, Inc., Upper Saddle River, NJ. All rights reserved.

This material is protected under all copyright laws as they currently exist. No portion of this material may be reproduced, in any form or by any means, without permission in writing from the publisher.

***4-52.** The rigid bar is supported by the two short white spruce wooden posts and a spring. If each of the posts has an unloaded length of 500 mm and a cross-sectional area of 800 mm^2 , and the spring has a stiffness of $k = 1.8 \text{ MN/m}$ and an unstretched length of 520 mm, determine the vertical displacement of A and B after the load is applied to the bar.

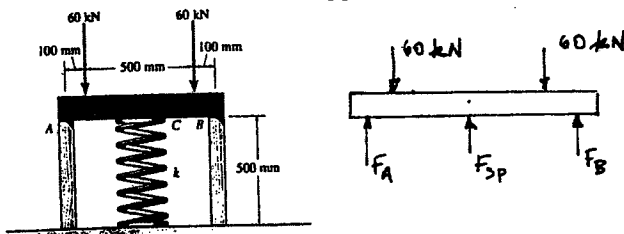

Due to symmetrical system and loading

$$F_A = F_B = F$$

$$+\uparrow \Sigma F_y = 0; \quad F_{sp} + 2F - 120(10^3) = 0 \quad (1)$$

Spring equation :

$$\begin{aligned} F_{sp} &= k(\delta_A + 0.02) \\ &= 1.8(10^6) \left(\frac{F(0.5)}{800(10^{-6})(11)(10^9)} + 0.02 \right) \\ &= 0.10227 F + 36000 \quad (2) \end{aligned}$$

Solving Eqs. (1) and (2) yields

$$F_{sp} = 40.1 \text{ kN}$$

$$F = 40.0 \text{ kN}$$

$$\delta_A = \delta_B = \frac{FL}{AE} = \frac{40.0(10^3)(0.5)}{800(10^{-6})(11)(10^9)} = 0.00227 \text{ m} = 2.27 \text{ mm} \quad \text{Ans}$$

From *Mechanics of Materials*, Sixth Edition by R. C. Hibbeler, ISBN 0-13-191345-X.

© 2005 R. C. Hibbeler. Published by Pearson Prentice Hall,

Pearson Education, Inc., Upper Saddle River, NJ. All rights reserved.

This material is protected under all copyright laws as they currently exist. No portion of this material may be reproduced, in any form or by any means, without permission in writing from the publisher.

4-53 The 10-mm-diameter steel bolt is surrounded by a bronze sleeve. The outer diameter of this sleeve is 20 mm, and its inner diameter is 10 mm. If the bolt is subjected to a compressive force of $P = 20$ kN, determine the average normal stress in the steel and the bronze. $E_{st} = 200$ GPa, $E_{br} = 100$ GPa.

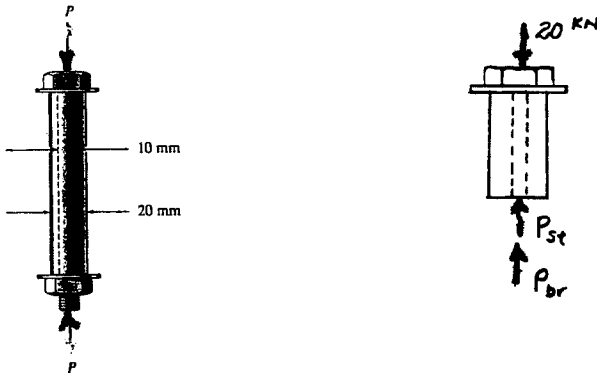

$$+\uparrow \Sigma F_y = 0; \quad P_{st} + P_{br} - 20 = 0 \quad (1)$$

$$\delta_{st} = \delta_{br}$$

$$\frac{P_{st}L}{\frac{\pi}{4}(0.01^2)(200)(10^9)} = \frac{P_{br}L}{\frac{\pi}{4}(0.02^2 - 0.01^2)(100)(10^9)}$$

$$P_{st} = 0.6667 P_{br} \quad (2)$$

Solving Eqs (1) and (2) yields

$$P_{st} = 8 \text{ kN} \quad P_{br} = 12 \text{ kN}$$

$$\sigma_{st} = \frac{P_{st}}{A_{st}} = \frac{8(10^3)}{\frac{\pi}{4}(0.01^2)} = 102 \text{ MPa} \quad \text{Ans}$$

$$\sigma_{br} = \frac{P_{br}}{A_{br}} = \frac{12(10^3)}{\frac{\pi}{4}(0.02^2 - 0.01^2)} = 50.9 \text{ MPa} \quad \text{Ans}$$

From *Mechanics of Materials*, Sixth Edition by R. C. Hibbeler, ISBN 0-13-191345-X.

© 2005 R. C. Hibbeler. Published by Pearson Prentice Hall,

Pearson Education, Inc., Upper Saddle River, NJ. All rights reserved.

This material is protected under all copyright laws as they currently exist. No portion of this material may be reproduced, in any form or by any means, without permission in writing from the publisher.

4-54 The 10-mm-diameter steel bolt is surrounded by a bronze sleeve. The outer diameter of this sleeve is 20 mm, and its inner diameter is 10 mm. If the yield stress for the steel is $(\sigma_Y)_{st} = 640$ MPa, and for the bronze $(\sigma_Y)_{br} = 520$ MPa, determine the magnitude of the largest elastic load P that can be applied to the assembly. $E_{st} = 200$ GPa, $E_{br} = 100$ GPa.

$$+\uparrow \Sigma F_y = 0; \quad P_{st} + P_{br} - P = 0 \quad (1)$$

Assume failure of bolt :

$$P_{st} = (\sigma_Y)_{st}(A) = 640(10^6)\left(\frac{\pi}{4}\right)(0.01^2) \\ = 50265.5 \text{ N}$$

$$\delta_{st} = \delta_{br}$$

$$\frac{P_{st}L}{\frac{\pi}{4}(0.01^2)(200)(10^9)} = \frac{P_{br}L}{\frac{\pi}{4}(0.02^2 - 0.01^2)(100)(10^9)}$$

$$P_{st} = 0.6667 P_{br}$$

$$50\,265.5 = 0.6667 P_{br}$$

$$P_{br} = 75398.2 \text{ N}$$

From Eq. (1)

$$P = 50265.5 + 75398.2 \\ = 125663.7 \text{ N} = 126 \text{ kN} \quad (\text{controls}) \quad \mathbf{Ans}$$

Assume failure of sleeve :

$$P_{br} = (\sigma_Y)_{br}(A) = 520(10^6)\left(\frac{\pi}{4}\right)(0.02^2 - 0.01^2) = 122\,522.11 \text{ N}$$

$$P_{st} = 0.6667 P_{br} \\ = 0.6667(122\,522.11) \\ = 81\,681.4 \text{ N}$$

From Eq. (1),

$$P = 122\,522.11 + 81\,681.4 \\ = 204\,203.52 \text{ N} \\ = 204 \text{ kN}$$

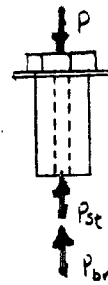
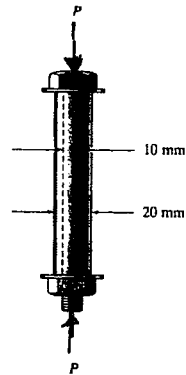

From *Mechanics of Materials*, Sixth Edition by R. C. Hibbeler, ISBN 0-13-191345-X.

© 2005 R. C. Hibbeler. Published by Pearson Prentice Hall,

Pearson Education, Inc., Upper Saddle River, NJ. All rights reserved.

This material is protected under all copyright laws as they currently exist. No portion of this material may be reproduced, in any form or by any means, without permission in writing from the publisher.

4-55 The rigid member is held in the position shown by three A-36 steel tie rods. Each rod has an unstretched length of 0.75 m and a cross-sectional area of 125 mm². Determine the forces in the rods if a turnbuckle on rod *EF* undergoes one full turn. The lead of the screw is 1.5 mm. Neglect the size of the turnbuckle and assume that it is rigid. *Note:* The lead would cause the rod, when *unloaded*, to shorten 1.5 mm when the turnbuckle is rotated one revolution.

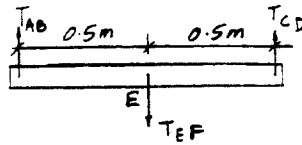
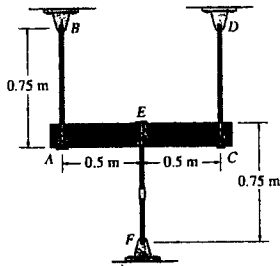

$$(+\Sigma M_E = 0; \quad -T_{AB}(0.5) + T_{CD}(0.5) = 0$$

$$T_{AB} = T_{CD} = T \quad (1)$$

$$+\downarrow \Sigma F_y = 0; \quad T_{EF} - 2T = 0$$

$$T_{EF} = 2T \quad (2)$$

Rod *EF* shortens 1.5mm causing *AB* (and *DC*) to elongate. Thus;

$$0.0015 = \delta_{A/B} + \delta_{E/F}$$

$$0.0015 = \frac{T(0.75)}{(125)(10^{-6})(200)(10^9)} + \frac{2T(0.75)}{(125)(10^{-6})(200)(10^9)}$$

$$2.25T = 37500$$

$$T = 16666.67 \text{ N}$$

$$T_{AB} = T_{CD} = 16.7 \text{ kN} \quad \text{Ans}$$

$$T_{EF} = 33.3 \text{ kN} \quad \text{Ans}$$

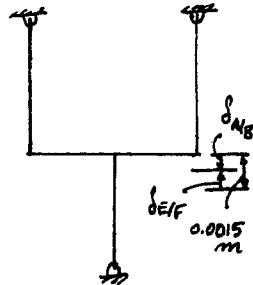

From *Mechanics of Materials*, Sixth Edition by R. C. Hibbeler, ISBN 0-13-191345-X.

© 2005 R. C. Hibbeler. Published by Pearson Prentice Hall,

Pearson Education, Inc., Upper Saddle River, NJ. All rights reserved.

This material is protected under all copyright laws as they currently exist. No portion of this material may be reproduced, in any form or by any means, without permission in writing from the publisher.

*4-56 The press consists of two rigid heads that are held together by the two A-36 steel $\frac{1}{2}$ -in.-diameter rods. A 6061-T6-solid-aluminum cylinder is placed in the press and the screw is adjusted so that it just presses up against the cylinder. If it is then tightened one-half turn, determine the average normal stress in the rods and in the cylinder. The single-threaded screw on the bolt has a lead of 0.01 in. *Note:* The lead represents the distance the screw advances along its axis for one complete turn of the screw.

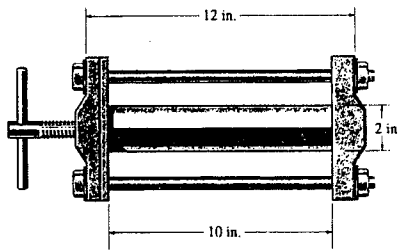

$$\rightarrow \Sigma F_x = 0; \quad 2F_{st} - F_{al} = 0$$

$$\delta_{st} = 0.005 - \delta_{al}$$

$$\frac{F_{st}(12)}{\left(\frac{\pi}{4}\right)(0.5)^2(29)(10^3)} = 0.005 - \frac{F_{al}(10)}{\pi(1)^2(10)(10^3)}$$

Solving,

$$F_{st} = 1.822 \text{ kip}$$

$$F_{al} = 3.644 \text{ kip}$$

$$\sigma_{rod} = \frac{F_{st}}{A_{st}} = \frac{1.822}{\left(\frac{\pi}{4}\right)(0.5)^2} = 9.28 \text{ ksi} \quad \text{Ans}$$

$$\sigma_{cyl} = \frac{F_{al}}{A_{al}} = \frac{3.644}{\pi(1)^2} = 1.16 \text{ ksi} \quad \text{Ans}$$

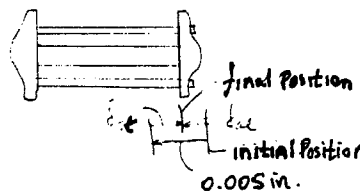
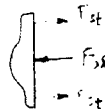

From *Mechanics of Materials*, Sixth Edition by R. C. Hibbeler, ISBN 0-13-191345-X.

© 2005 R. C. Hibbeler. Published by Pearson Prentice Hall,

Pearson Education, Inc., Upper Saddle River, NJ. All rights reserved.

This material is protected under all copyright laws as they currently exist. No portion of this material may be reproduced, in any form or by any means, without permission in writing from the publisher.

4-57 The press consists of two rigid heads that are held together by the two A-36 steel $\frac{1}{2}$ -in.-diameter rods. A 6061-T6-solid-aluminum cylinder is placed in the press and the screw is adjusted so that it just presses up against the cylinder. Determine the angle through which the screw can be turned before the rods or the specimen begin to yield. The single-threaded screw on the bolt has a lead of 0.01 in. *Note:* The lead represents the distance the screw advances along its axis for one complete turn of the screw.

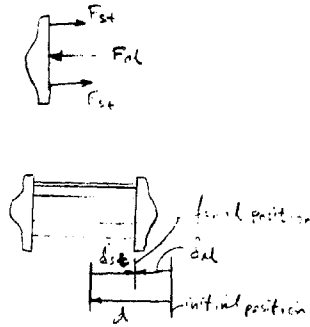
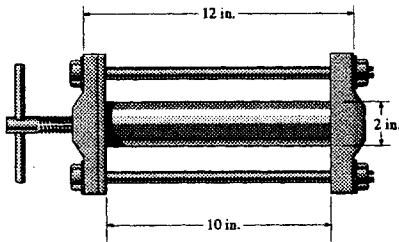

$$\rightarrow \Sigma F_x = 0; \quad 2F_{st} - F_{al} = 0$$

$$\delta_{st} = d - \delta_{al}$$

$$\frac{F_{st}(12)}{\left(\frac{\pi}{4}\right)(0.5)^2(29)(10^3)} = d - \frac{F_{al}(10)}{\pi(1)^2(10)(10^3)} \quad (1)$$

Assume steel yields first,

$$\sigma_Y = 36 = \frac{F_{st}}{\left(\frac{\pi}{4}\right)(0.5)^2}; \quad F_{st} = 7.068 \text{ kip}$$

Then $F_{al} = 14.137$ kip;

$$\sigma_{al} = \frac{14.137}{\pi(1)^2} = 4.50 \text{ ksi}$$

4.50 ksi < 37 ksi steel yields first as assumed. From Eq. (1),

$$d = 0.01940 \text{ in.}$$

Thus,

$$\frac{\theta}{360^\circ} = \frac{0.01940}{0.01}$$

$$\theta = 698^\circ \quad \text{Ans}$$

From *Mechanics of Materials*, Sixth Edition by R. C. Hibbeler, ISBN 0-13-191345-X.

© 2005 R. C. Hibbeler. Published by Pearson Prentice Hall,

Pearson Education, Inc., Upper Saddle River, NJ. All rights reserved.

This material is protected under all copyright laws as they currently exist. No portion of this material may be reproduced, in any form or by any means, without permission in writing from the publisher.

4-58. The assembly consists of two posts made from material 1 having a modulus of elasticity of E_1 and each a cross-sectional area A_1 , and a material 2 having a modulus of elasticity E_2 and cross-sectional area A_2 . If a central load P is applied to the rigid cap, determine the force in each material.

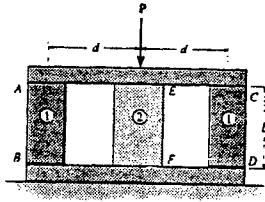

Equilibrium :

$$+\uparrow \Sigma F_y = 0; \quad 2F_1 + F_2 - P = 0 \quad [1]$$

Compatibility :

$$\delta = \delta_1 = \delta_2$$

$$\frac{F_1 L}{A_1 E_1} = \frac{F_2 L}{A_2 E_2} \quad F_1 = \left(\frac{A_1 E_1}{A_2 E_2} \right) F_2 \quad [2]$$

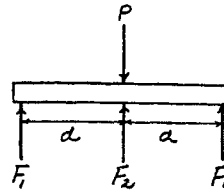

Solving Eq.[1] and [2] yields :

$$F_1 = \left(\frac{A_1 E_1}{2A_1 E_1 + A_2 E_2} \right) P \quad \text{Ans}$$

$$F_2 = \left(\frac{A_2 E_2}{2A_1 E_1 + A_2 E_2} \right) P \quad \text{Ans}$$

From *Mechanics of Materials*, Sixth Edition by R. C. Hibbeler, ISBN 0-13-191345-X.

© 2005 R. C. Hibbeler. Published by Pearson Prentice Hall,

Pearson Education, Inc., Upper Saddle River, NJ. All rights reserved.

This material is protected under all copyright laws as they currently exist. No portion of this material may be reproduced, in any form or by any means, without permission in writing from the publisher.

4-59. The assembly consists of two posts AB and CD made from material 1 having a modulus of elasticity of E_1 and each a cross-sectional area A_1 , and a central post EF made from material 2 having a modulus of elasticity E_2 and a cross sectional area A_2 . If posts AB and CD are to be replaced by those having a material 2, determine the required cross-sectional area of these new posts so that both assemblies deform the same amount when loaded.

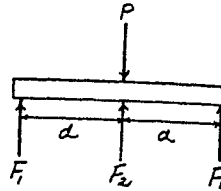
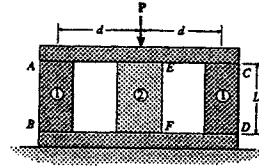

$$+\uparrow \Sigma F_y = 0; \quad 2F_1 + F_2 - P = 0 \quad [1]$$

Compatibility :

$$\delta_{in} = \delta_1 = \delta_2$$

$$\frac{F_1 L}{A_1 E_1} = \frac{F_2 L}{A_2 E_2} \quad F_1 = \left(\frac{A_1 E_1}{A_2 E_2} \right) F_2 \quad [2]$$

Solving Eq. [1] and [2] yields :

$$F_1 = \left(\frac{A_1 E_1}{2A_1 E_1 + A_2 E_2} \right) P \quad F_2 = \left(\frac{A_2 E_2}{2A_1 E_1 + A_2 E_2} \right) P$$

$$\delta_{in} = \frac{F_2 L}{A_2 E_2} = \frac{\left(\frac{A_2 E_2}{2A_1 E_1 + A_2 E_2} \right) PL}{A_2 E_2} = \frac{PL}{2A_1 E_1 + A_2 E_2}$$

Compatibility : When material 1 has been replaced by material 2 for two side posts, then

$$\delta_{final} = \delta_1 = \delta_2$$

$$\frac{F_1 L}{A_1' E_2} = \frac{F_2 L}{A_2 E_2} \quad F_1 = \left(\frac{A_1'}{A_2} \right) F_2 \quad [3]$$

Solving for F_2 from Eq. [1] and [3]

$$F_2 = \left(\frac{A_2}{2A_1' + A_2} \right) P$$

$$\delta_{final} = \frac{F_2 L}{A_2 E_2} = \frac{\left(\frac{A_2}{2A_1' + A_2} \right) PL}{A_2 E_2} = \frac{PL}{E_2 (2A_1' + A_2)}$$

Requires,

$$\delta_{in} = \delta_{final}$$

$$\frac{PL}{2A_1 E_1 + A_2 E_2} = \frac{PL}{E_2 (2A_1' + A_2)}$$

$$A_1' = \left(\frac{E_1}{E_2} \right) A_1$$

Ans

From *Mechanics of Materials*, Sixth Edition by R. C. Hibbeler, ISBN 0-13-191345-X.

© 2005 R. C. Hibbeler. Published by Pearson Prentice Hall,

Pearson Education, Inc., Upper Saddle River, NJ. All rights reserved.

This material is protected under all copyright laws as they currently exist. No portion of this material may be reproduced, in any form or by any means, without permission in writing from the publisher.

***4-60.** The assembly consists of two posts AB and CD made from material 1 having a modulus of elasticity of E_1 and each a cross-sectional area A_1 , and a central post EF made from material 2 having a modulus of elasticity E_2 and a cross-sectional area A_2 . If post EF is to be replaced by one having a material 1, determine the required cross-sectional area of this new post so that both assemblies deform the same amount when loaded.

$$+\uparrow \Sigma F_y = 0; \quad 2F_1 + F_2 - P = 0 \quad [1]$$

Compatibility :

$$\delta_{in} = \delta_1 = \delta_2$$

$$\frac{F_1 L}{A_1 E_1} = \frac{F_2 L}{A_2 E_2} \quad F_1 = \left(\frac{A_1 E_1}{A_2 E_2} \right) F_2 \quad [2]$$

Solving Eq. [1] and [2] yields :

$$F_1 = \left(\frac{A_1 E_1}{2A_1 E_1 + A_2 E_2} \right) P \quad F_2 = \left(\frac{A_2 E_2}{2A_1 E_1 + A_2 E_2} \right) P$$

$$\delta_{in} = \frac{F_2 L}{A_2 E_2} = \frac{\left(\frac{A_2 E_2}{2A_1 E_1 + A_2 E_2} \right) P}{A_2 E_2} = \frac{PL}{2A_1 E_1 + A_2 E_2}$$

Compatibility : When material 2 has been replaced by material 1 for central posts, then

$$\delta_{final} = \delta_1 = \delta_2$$

$$\frac{F_1 L}{A_1 E_1} = \frac{F_2 L}{A_2' E_1} \quad F_2 = \left(\frac{A_2'}{A_1} \right) F_1 \quad [3]$$

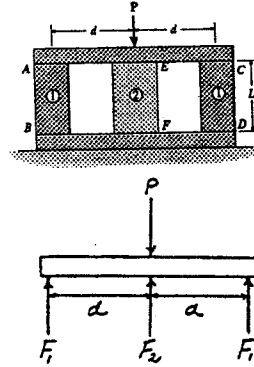

Solving for F_1 from Eq. [1] and [3]

$$F_1 = \left(\frac{A_1}{2A_1 + A_2'} \right) P$$

$$\delta_{final} = \frac{F_1 L}{A_1 E_1} = \frac{\left(\frac{A_1}{2A_1 + A_2'} \right) PL}{A_1 E_1} = \frac{PL}{E_1 (2A_1 + A_2')}$$

Requires,

$$\delta_{in} = \delta_{final}$$

$$\frac{PL}{2A_1 E_1 + A_2 E_2} = \frac{PL}{E_1 (2A_1 + A_2')}$$

$$A_2' = \left(\frac{E_2}{E_1} \right) A_2$$

Ans

From *Mechanics of Materials*, Sixth Edition by R. C. Hibbeler, ISBN 0-13-191345-X.

© 2005 R. C. Hibbeler. Published by Pearson Prentice Hall,

Pearson Education, Inc., Upper Saddle River, NJ. All rights reserved.

This material is protected under all copyright laws as they currently exist. No portion of this material may be reproduced, in any form or by any means, without permission in writing from the publisher.

4-61. The assembly consists of a 6061-T6-aluminum member and a C83400-red-brass member that rest on the rigid plates. Determine the distance d where the vertical load P should be placed on the plates so that the plates remain horizontal when the materials deform. Each member has a width of 8 in. and they are not bonded together.

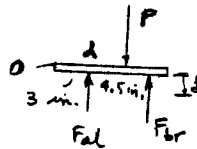
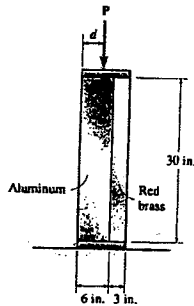

$$+\uparrow \Sigma F_y = 0; \quad -P + F_{al} + F_{br} = 0$$

$$+\Sigma M_O = 0; \quad 3 F_{al} + 7.5 F_{br} - Pd = 0$$

$$\delta = \delta_{br} = \delta_{al}$$

$$\frac{F_{br}L}{A_{br}E_{br}} = \frac{F_{al}L}{A_{al}E_{al}}$$

$$F_{br} = F_{al} \left(\frac{A_{br}E_{br}}{A_{al}E_{al}} \right) = F_{al} \left(\frac{(3)(8)(14.6)(10^3)}{6(8)(10)(10^3)} \right) = 0.730 F_{al}$$

Thus,

$$P = 1.730 F_{al}$$

$$3 F_{al} + 7.5(0.730 F_{al}) = (1.730 F_{al})d$$

$$d = 4.90 \text{ in. Ans}$$

From *Mechanics of Materials*, Sixth Edition by R. C. Hibbeler, ISBN 0-13-191345-X.

© 2005 R. C. Hibbeler. Published by Pearson Prentice Hall,

Pearson Education, Inc., Upper Saddle River, NJ. All rights reserved.

This material is protected under all copyright laws as they currently exist. No portion of this material may be reproduced, in any form or by any means, without permission in writing from the publisher.

4-62 The rigid beam is supported by a symmetrical arrangement of bars of equal area A and length L . Bars AB and CD have a modulus of elasticity E_1 and bars EF and GH have a modulus of elasticity E_2 . Determine the average normal stress in each bar if a couple moment M_0 is applied to the beam.

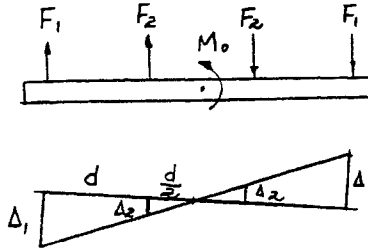
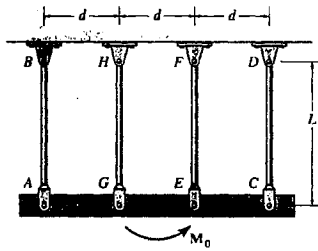

$$F_{AB} = F_{CD} = F_1; \quad F_{GH} = F_{EF} = F_2$$

$$+\Sigma M_O = 0; \quad -F_1(3d) - F_2(d) + M_0 = 0 \quad (1)$$

$$\frac{\delta_1}{1.5d} = \frac{\delta_2}{0.5d}; \quad 0.5\delta_1 = 1.5\delta_2$$

$$\frac{0.5F_1(L)}{AE_1} = \frac{1.5F_2(L)}{AE_2}$$

$$F_1 = 3\left(\frac{E_1}{E_2}\right)F_2 \quad (2)$$

Solving Eqs. (1) and (2).

$$F_2 = \frac{M_0 E_2}{d[9E_1 + E_2]}; \quad F_1 = \frac{3E_1 M_0}{d[9E_1 + E_2]}$$

$$\sigma_{AB} = \sigma_{CD} = \frac{3E_1 M_0}{Ad[9E_1 + E_2]} \quad \text{Ans}$$

$$\sigma_{GH} = \sigma_{EF} = \frac{M_0 E_2}{Ad[9E_1 + E_2]} \quad \text{Ans}$$

From *Mechanics of Materials*, Sixth Edition by R. C. Hibbeler, ISBN 0-13-191345-X.

© 2005 R. C. Hibbeler. Published by Pearson Prentice Hall,

Pearson Education, Inc., Upper Saddle River, NJ. All rights reserved.

This material is protected under all copyright laws as they currently exist. No portion of this material may be reproduced, in any form or by any means, without permission in writing from the publisher.

4-63. The tapered member is fixed connected at its ends A and B and is subjected to a load $P = 7$ kip at $x = 30$ in. Determine the reactions at the supports. The material is 2 in. thick and is made from 2014-T6 aluminum.

$$\frac{y}{120-x} = \frac{1.5}{60}$$

$$y = 3 - 0.025x$$

$$\rightarrow \Sigma F_x = 0; \quad F_A + F_B - 7 = 0 \quad (1)$$

$$\delta_{A/B} = 0$$

$$-\int_0^{30} \frac{F_A dx}{2(3-0.025x)(2)(E)} + \int_{30}^{60} \frac{F_B dx}{2(3-0.025x)(2)(E)} = 0$$

$$-F_A \int_0^{30} \frac{dx}{(3-0.025x)} + F_B \int_{30}^{60} \frac{dx}{(3-0.025x)} = 0$$

$$40 F_A \ln(3-0.025x) \Big|_0^{30} - 40 F_B \ln(3-0.025x) \Big|_{30}^{60} = 0$$

$$-F_A(0.2876) + 0.40547 F_B = 0$$

$$F_A = 1.40942 F_B$$

Thus, from Eq. (1),

$$F_A = 4.09 \text{ kip} \quad \text{Ans}$$

$$F_B = 2.91 \text{ kip} \quad \text{Ans}$$

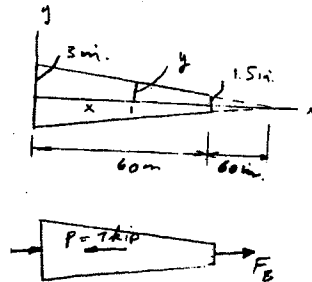
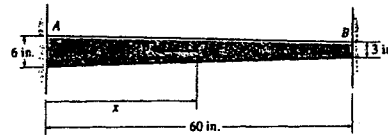

From *Mechanics of Materials*, Sixth Edition by R. C. Hibbeler, ISBN 0-13-191345-X.

© 2005 R. C. Hibbeler. Published by Pearson Prentice Hall,

Pearson Education, Inc., Upper Saddle River, NJ. All rights reserved.

This material is protected under all copyright laws as they currently exist. No portion of this material may be reproduced, in any form or by any means, without permission in writing from the publisher.

*4-64 The tapered member is fixed connected at its ends A and B and is subjected to a load P . Determine the location x of the load and its greatest magnitude if the allowable normal stress for the material is $\sigma_{\text{allow}} = 4$ ksi. The member is 2 in. thick.

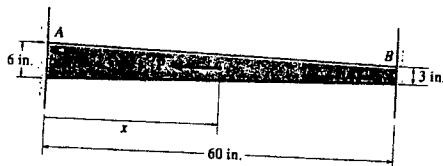

$$\frac{y}{120-x} = \frac{1.5}{60}$$

$$y = 3 - 0.025x$$

$$\rightarrow \Sigma F_x = 0; \quad F_A + F_B - P = 0$$

$$\delta_{A/B} = 0$$

$$-\int_0^x \frac{F_A dx}{2(3-0.025x)(2)(E)} + \int_x^{60} \frac{F_B dx}{2(3-0.025x)(2)(E)} = 0$$

$$-F_A \int_0^x \frac{dx}{(3-0.025x)} + F_B \int_x^{60} \frac{dx}{(3-0.025x)} = 0$$

$$F_A(40) \ln(3-0.025x) \Big|_0^x - F_B(40) \ln(3-0.025x) \Big|_x^{60} = 0$$

$$F_A \ln\left(1 - \frac{0.025x}{3}\right) = -F_B \ln\left(2 - \frac{0.025x}{1.5}\right)$$

For greatest magnitude of P require,

$$4 = \frac{F_A}{2(3-0.025x)(2)}; \quad F_A = 48 - 0.4x$$

$$4 = \frac{F_B}{2(3)}; \quad F_B = 24 \text{ kip}$$

Thus,

$$(48 - 0.4x) \ln\left(1 - \frac{0.025x}{3}\right) = -24 \ln\left(2 - \frac{0.025x}{1.5}\right)$$

Solving by trial and error,

$$x = 28.9 \text{ in. Ans}$$

Therefore,

$$F_A = 36.4 \text{ kip}$$

$$P = 60.4 \text{ kip Ans}$$

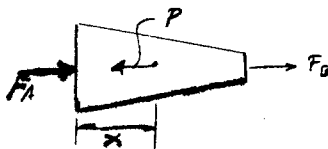
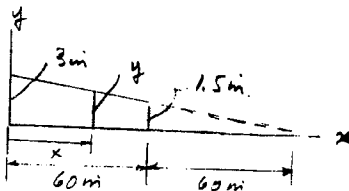

From *Mechanics of Materials*, Sixth Edition by R. C. Hibbeler, ISBN 0-13-191345-X.

© 2005 R. C. Hibbeler. Published by Pearson Prentice Hall,

Pearson Education, Inc., Upper Saddle River, NJ. All rights reserved.

This material is protected under all copyright laws as they currently exist. No portion of this material may be reproduced, in any form or by any means, without permission in writing from the publisher.

4-65. The spring has an unstretched length of 250 mm and stiffness $k = 400 \text{ kN/m}$. If it is compressed and placed over the 200-mm-long portion AC of the aluminum bar AB and released, determine the force that the bar exerts on the wall at A . Before loading there is a gap of 0.1 mm between the bar and the wall at B . The bar is fixed to the wall at A . Neglect the thickness of the rigid plate at C . $E_{al} = 70 \text{ GPa}$.

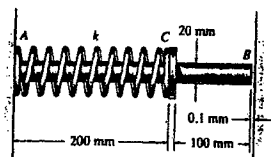

$$\rightarrow + \Sigma F_x = 0; \quad F_{sp} - F_A - F_B = 0 \quad (1)$$

$$\rightarrow + 0.1 = \Delta_B - \delta_B$$

$$0.1 = \frac{F_{sp}(200)}{\frac{\pi}{4}(0.02^2)(70)(10^9)} - \frac{F_B(300)}{\frac{\pi}{4}(0.02^2)(70)(10^9)}$$

$$2F_{sp} - 3F_B = 21991.15 \quad (2)$$

$$F_{sp} = k \Delta x = 400(10^3)(0.25 - 0.2001) = 19960 \text{ N}$$

From Eq. (2),

$$F_B = 5976.28 \text{ N}$$

From Eq. (1),

$$F_A = 13983.7 \text{ N} = 14.0 \text{ kN}$$

Ans

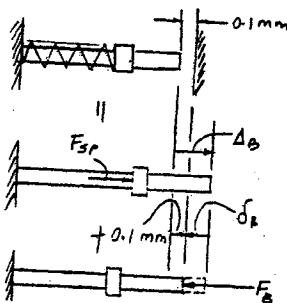

From *Mechanics of Materials*, Sixth Edition by R. C. Hibbeler, ISBN 0-13-191345-X.

© 2005 R. C. Hibbeler. Published by Pearson Prentice Hall,

Pearson Education, Inc., Upper Saddle River, NJ. All rights reserved.

This material is protected under all copyright laws as they currently exist. No portion of this material may be reproduced, in any form or by any means, without permission in writing from the publisher.

4-66. The post is made from 6061-T6 aluminum and has a diameter of 50 mm. It is fixed supported at A and B and at its center C there is a coiled spring attached to the rigid collar. If the spring is originally uncompressed, determine the reactions at A and B when the force $P = 40$ kN is applied to the collar.

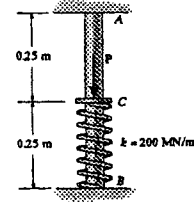

Equations of Equilibrium :

$$+\uparrow \Sigma F_y = 0; \quad F_A + F_B + F_{sp} - 40(10^3) = 0 \quad [1]$$

Compatibility :

$$0 = \delta_p - \delta_B$$

$$0 = \frac{40(10^3)(0.25)}{\frac{\pi}{4}(0.05^2)68.9(10^9)} - \left[\frac{(F_B + F_{sp})(0.25)}{\frac{\pi}{4}(0.05^2)68.9(10^9)} + \frac{F_B + F_{sp}}{\frac{\frac{\pi}{4}(0.05^2)68.9(10^9)}{0.25} + 200(10^6)} \right]$$

$$F_B + F_{sp} = 23119.45 \quad [2]$$

Also,

$$\delta_{sp} = \delta_{BC}$$

$$\frac{F_{sp}}{200(10^6)} = \frac{F_B + F_{sp}}{\frac{\frac{\pi}{4}(0.05^2)68.9(10^9)}{0.25} + 200(10^6)}$$

$$F_B = 2.7057 F_{sp} \quad [3]$$

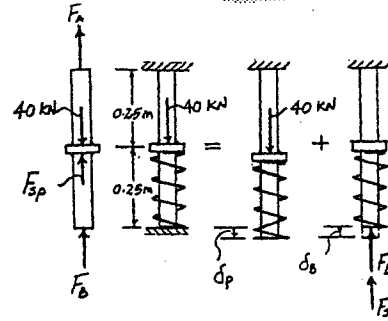

Solving Eq. [2] and [3] yields

$$F_{sp} = 6238.9 \text{ N}$$

$$F_B = 16880.6 \text{ N} = 16.9 \text{ kN} \quad \text{Ans}$$

Substitute the results into Eq. [1]

$$F_A = 16880.6 \text{ N} = 16.9 \text{ kN} \quad \text{Ans}$$

From *Mechanics of Materials*, Sixth Edition by R. C. Hibbeler, ISBN 0-13-191345-X.

© 2005 R. C. Hibbeler. Published by Pearson Prentice Hall,

Pearson Education, Inc., Upper Saddle River, NJ. All rights reserved.

This material is protected under all copyright laws as they currently exist. No portion of this material may be reproduced, in any form or by any means, without permission in writing from the publisher.

4-67. The post is made from 6061-T6 aluminum and has a diameter of 50 mm. It is fixed supported at A and B and at its center C there is a coiled spring attached to the rigid collar. If the spring is originally uncompressed, determine the compression in the spring when the load of $P = 50$ kN is applied to the collar.

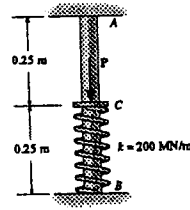

Compatibility :

$$0 = \delta_p - \delta_B$$

$$0 = \frac{50(10^3)(0.25)}{\frac{\pi}{4}(0.05^2)68.9(10^9)} - \left[\frac{(F_B + F_{sp})(0.25)}{\frac{\pi}{4}(0.05^2)68.9(10^9)} + \frac{F_B + F_{sp}}{\frac{\frac{\pi}{4}(0.05^2)68.9(10^9)}{0.25} + 200(10^6)} \right]$$

$$F_B + F_{sp} = 28899.31 \quad [1]$$

Also,

$$\delta_{sp} = \delta_{BC}$$

$$\frac{F_{sp}}{200(10^6)} = \frac{F_B + F_{sp}}{\frac{\frac{\pi}{4}(0.05^2)68.9(10^9)}{0.25} + 200(10^6)}$$

$$F_B = 2.7057F_{sp} \quad [2]$$

Solving Eqs. [1] and [2] yield

$$F_{sp} = 7798.6 \text{ N} \quad F_B = 21100.7 \text{ N}$$

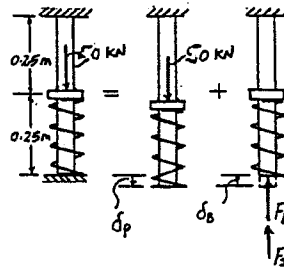

Thus,

$$\delta_{sp} = \frac{F_{sp}}{k} = \frac{7798.6}{200(10^6)}$$

$$= 0.0390(10^{-3}) \text{ m} = 0.0390 \text{ mm} \quad \text{Ans}$$

From *Mechanics of Materials*, Sixth Edition by R. C. Hibbeler, ISBN 0-13-191345-X.

© 2005 R. C. Hibbeler. Published by Pearson Prentice Hall,

Pearson Education, Inc., Upper Saddle River, NJ. All rights reserved.

This material is protected under all copyright laws as they currently exist. No portion of this material may be reproduced, in any form or by any means, without permission in writing from the publisher.

*4-68 The rigid bar supports the uniform distributed load of 6 kip/ft. Determine the force in each cable if each cable has a cross-sectional area of 0.05 in², and $E = 31(10^3)$ ksi.

$$\left(\sum M_A = 0; \quad T_{CB} \left(\frac{2}{\sqrt{5}} \right) (3) - 54(4.5) + T_{CD} \left(\frac{2}{\sqrt{5}} \right) 9 = 0 \quad (1) \right.$$

$$\theta = \tan^{-1} \frac{6}{3} = 45^\circ$$

$$L_{BC}^2 = (3)^2 + (8.4853)^2 - 2(3)(8.4853) \cos \theta$$

Also,

$$L_{DC}^2 = (9)^2 + (8.4853)^2 - 2(9)(8.4853) \cos \theta \quad (2)$$

Thus, eliminating $\cos \theta$,

$$-L_{BC}^2(0.019642) + 1.5910 = -L_{DC}^2(0.0065473) + 1.001735$$

$$L_{BC}^2(0.019642) = 0.0065473 L_{DC}^2 + 0.589256$$

$$L_{BC}^2 = 0.333 L_{DC}^2 + 30$$

But,

$$L_{BC} = \sqrt{45 + \delta_{BC}}, \quad L_{DC} = \sqrt{45 + \delta_{DC}}$$

Neglect squares or δ 's since small strain occurs.

$$L_{BC}^2 = (\sqrt{45 + \delta_{BC}})^2 = 45 + 2\sqrt{45} \delta_{BC}$$

$$L_{DC}^2 = (\sqrt{45 + \delta_{DC}})^2 = 45 + 2\sqrt{45} \delta_{DC}$$

$$45 + 2\sqrt{45} \delta_{BC} = 0.333(45 + 2\sqrt{45} \delta_{DC}) + 30$$

$$2\sqrt{45} \delta_{BC} = 0.333(2\sqrt{45}) \delta_{DC}$$

$$\delta_{DC} = 3\delta_{BC}$$

Thus,

$$\frac{T_{CD} \sqrt{45}}{AE} = 3 \frac{T_{CB} \sqrt{45}}{AE}$$

$$T_{CD} = 3 T_{CB}$$

From Eq. (1),

$$T_{CD} = 27.1682 \text{ kip} = 27.2 \text{ kip} \quad \text{Ans}$$

$$T_{CB} = 9.06 \text{ kip} \quad \text{Ans}$$

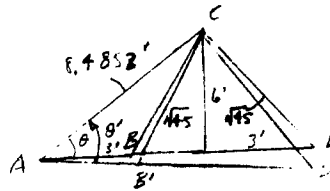
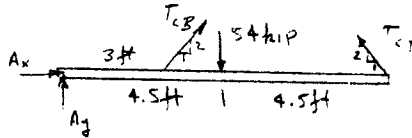
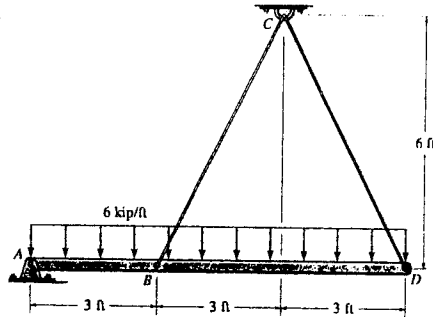

From *Mechanics of Materials*, Sixth Edition by R. C. Hibbeler, ISBN 0-13-191345-X.

© 2005 R. C. Hibbeler. Published by Pearson Prentice Hall,

Pearson Education, Inc., Upper Saddle River, NJ. All rights reserved.

This material is protected under all copyright laws as they currently exist. No portion of this material may be reproduced, in any form or by any means, without permission in writing from the publisher.

4-69 The rigid bar is originally horizontal and is supported by two cables each having a cross-sectional area of 0.05 in^2 , and $E = 31(10^3) \text{ ksi}$. Determine the slight rotation of the bar when the uniform load is applied.

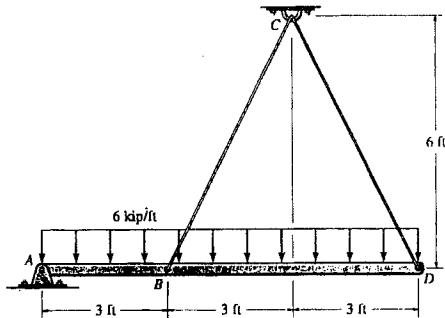

See solution of Prob. 4 - 68.

$$T_{CD} = 27.1682 \text{ kip}$$

$$\delta_{DC} = \frac{T_{CD} \sqrt{45}}{0.05(31)(10^3)} = \frac{27.1682\sqrt{45}}{0.05(31)(10^3)} = 0.1175806 \text{ ft}$$

Using Eq. (2) of Prob. 4 - 68,

$$(\sqrt{45} + 0.1175806)^2 = (9)^2 + (8.4852)^2 - 2(9)(8.4852) \cos \theta'$$

$$\theta' = 45.838^\circ$$

Thus,

$$\Delta \theta = 45.838^\circ - 45^\circ = 0.838^\circ \quad \text{Ans}$$

From *Mechanics of Materials*, Sixth Edition by R. C. Hibbeler, ISBN 0-13-191345-X.

© 2005 R. C. Hibbeler. Published by Pearson Prentice Hall,

Pearson Education, Inc., Upper Saddle River, NJ. All rights reserved.

This material is protected under all copyright laws as they currently exist. No portion of this material may be reproduced, in any form or by any means, without permission in writing from the publisher.

4-70. Three bars each made of different materials are connected together and placed between two walls when the temperature is $T_1 = 12^\circ\text{C}$. Determine the force exerted on the (rigid) supports when the temperature becomes $T_2 = 18^\circ\text{C}$. The material properties and cross-sectional area of each bar are given in the figure.

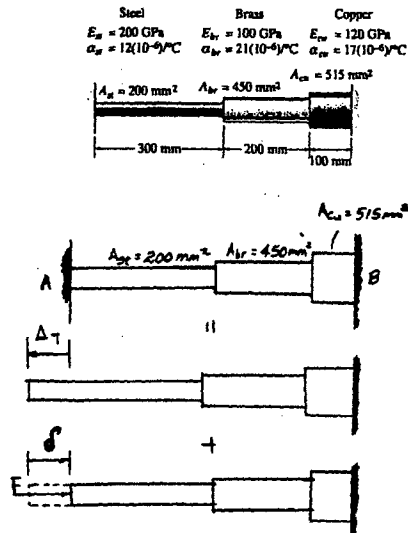

$$(\leftarrow) \quad 0 = \Delta_T - \delta$$

$$0 = 12(10^{-6})(6)(0.3) + 21(10^{-6})(6)(0.2) + 17(10^{-6})(6)(0.1)$$

$$-\frac{F(0.3)}{200(10^{-6})(200)(10^9)} - \frac{F(0.2)}{450(10^{-6})(100)(10^9)} - \frac{F(0.1)}{515(10^{-6})(120)(10^9)}$$

$$F = 4202 \text{ N} = 4.20 \text{ kN} \quad \text{Ans}$$

From *Mechanics of Materials*, Sixth Edition by R. C. Hibbeler, ISBN 0-13-191345-X.

© 2005 R. C. Hibbeler. Published by Pearson Prentice Hall,

Pearson Education, Inc., Upper Saddle River, NJ. All rights reserved.

This material is protected under all copyright laws as they currently exist. No portion of this material may be reproduced, in any form or by any means, without permission in writing from the publisher.

4-71 A steel surveyor's tape is to be used to measure the length of a line. The tape has a rectangular cross section of 0.05 in. by 0.2 in. and a length of 100 ft when $T_1 = 60^\circ\text{F}$ and the tension or pull on the tape is 20 lb. Determine the true length of the line if the tape shows the reading to be 463.25 ft when used with a pull of 35 lb at $T_2 = 90^\circ\text{F}$. The ground on which it is placed is flat. $\alpha_{st} = 9.60(10^{-6})/^\circ\text{F}$, $E_{st} = 29(10^3)$ ksi.

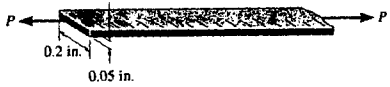

$$\delta_T = \alpha \Delta T L = 9.6(10^{-6})(90 - 60)(463.25) = 0.133416 \text{ ft}$$

$$\delta = \frac{PL}{AE} = \frac{(35 - 20)(463.25)}{(0.2)(0.05)(29)(10^6)} = 0.023961 \text{ ft}$$

$$L = 463.25 + 0.133416 + 0.023961 = 463.41 \text{ ft} \quad \mathbf{Ans}$$

From *Mechanics of Materials*, Sixth Edition by R. C. Hibbeler, ISBN 0-13-191345-X.

© 2005 R. C. Hibbeler. Published by Pearson Prentice Hall,

Pearson Education, Inc., Upper Saddle River, NJ. All rights reserved.

This material is protected under all copyright laws as they currently exist. No portion of this material may be reproduced, in any form or by any means, without permission in writing from the publisher.

*4-72 The assembly has the diameters and material make-up indicated. If it fits securely between its fixed supports when the temperature is $T_1 = 70^\circ\text{F}$, determine the average normal stress in each material when the temperature reaches $T_2 = 110^\circ\text{F}$.

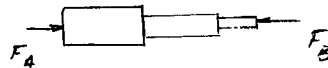
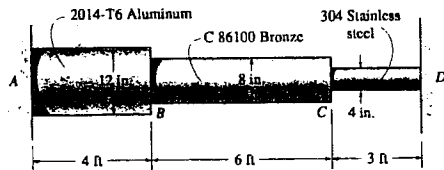

$$\Sigma F_x = 0; \quad F_A = F_B = F$$

$$\delta_{A/D} = 0; \quad -\frac{F(4)(12)}{\pi(6)^2(10.6)(10^6)} + 12.8(10^{-6})(110-70)(4)(12)$$

$$-\frac{F(6)(12)}{\pi(4)^2(15)(10^6)} + 9.60(10^{-6})(110-70)(6)(12)$$

$$-\frac{F(3)(12)}{\pi(2)^2(28)(10^6)} + 9.60(10^{-6})(110-70)(3)(12) = 0$$

$$F = 277.69 \text{ kip}$$

$$\sigma_{al} = \frac{277.69}{\pi(6)^2} = 2.46 \text{ ksi} \quad \text{Ans}$$

$$\sigma_{br} = \frac{277.69}{\pi(4)^2} = 5.52 \text{ ksi} \quad \text{Ans}$$

$$\sigma_{st} = \frac{277.69}{\pi(2)^2} = 22.1 \text{ ksi} \quad \text{Ans}$$

From *Mechanics of Materials*, Sixth Edition by R. C. Hibbeler, ISBN 0-13-191345-X.

© 2005 R. C. Hibbeler. Published by Pearson Prentice Hall,

Pearson Education, Inc., Upper Saddle River, NJ. All rights reserved.

This material is protected under all copyright laws as they currently exist. No portion of this material may be reproduced, in any form or by any means, without permission in writing from the publisher.

4-73 A high-strength concrete driveway slab has a length of 20 ft when its temperature is 20°F. If there is a gap of 0.125 in. on one side before it touches its fixed abutment, determine the temperature required to close the gap. What is the compressive stress in the concrete if the temperature becomes 110°F?

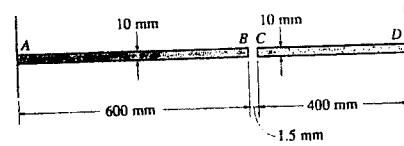

Require,

$$\delta_T = \alpha \Delta T L$$

$$0.125 = 6(10^{-6})(T - 20^\circ)(20)(12)$$

$$T = 107^\circ F \quad \text{Ans}$$

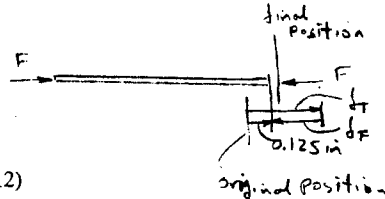

$$0.125 = \delta_T - \delta_F$$

$$0.125 = 6(10^{-6})(110^\circ - 20^\circ)(20)(12) - \frac{F(20)(12)}{A(4.20(10^6))}$$

$$\sigma = \frac{F}{A} = 80.5 \text{ psi} \quad \text{Ans}$$

From *Mechanics of Materials*, Sixth Edition by R. C. Hibbeler, ISBN 0-13-191345-X.

© 2005 R. C. Hibbeler. Published by Pearson Prentice Hall,

Pearson Education, Inc., Upper Saddle River, NJ. All rights reserved.

This material is protected under all copyright laws as they currently exist. No portion of this material may be reproduced, in any form or by any means, without permission in writing from the publisher.

4-74. A thermo gate consists of two 6061-T6-aluminum plates that have a width of 15 mm and are fixed supported at their ends. If the gap between them is 1.5 mm when the temperature is $T_1 = 25^\circ\text{C}$, determine the temperature required to just close the gap. Also, what is the axial force in each plate if the temperature becomes $T_2 = 100^\circ\text{C}$? Assume bending or buckling will not occur.

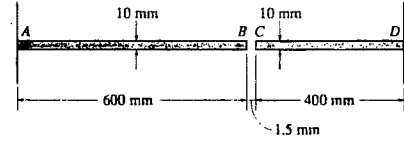

$$\delta_T = \alpha \Delta T L$$

Require,

$$\delta_T = 0.0015 \text{ m} = \delta_{B/A} + \delta_{C/D}$$

$$0.0015 = 24(10^{-6})(T_2 - 25)(1)$$

$$T_2 = 87.5^\circ \text{C} \quad \text{Ans}$$

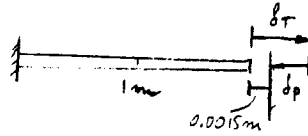

The problem is equivalent to that shown in diagram.

$$(\rightarrow) \delta_T - \delta_p = 0.0015$$

$$\alpha \Delta T L - \frac{FL}{AE} = 0.0015$$

$$24(10^{-6})(100 - 25)(1) - \frac{F(1)}{(0.015)(0.010)(68.9)(10^9)} = 0.0015$$

From *Mechanics of Materials*, Sixth Edition by R. C. Hibbeler, ISBN 0-13-191345-X.

© 2005 R. C. Hibbeler. Published by Pearson Prentice Hall,

Pearson Education, Inc., Upper Saddle River, NJ. All rights reserved.

This material is protected under all copyright laws as they currently exist. No portion of this material may be reproduced, in any form or by any means, without permission in writing from the publisher.

4-75. A thermo gate consists of a 6061-T6-aluminum plate AB and an Am-1004-T61-magnesium plate CD , each having a width of 15 mm and fixed supported at their ends. If the gap between them is 1.5 mm when the temperature is $T_1 = 25^\circ\text{C}$, determine the temperature required to just close the gap. Also, what is the axial force in each plate if the temperature becomes $T_2 = 100^\circ\text{C}$? Assume bending or buckling will not occur.

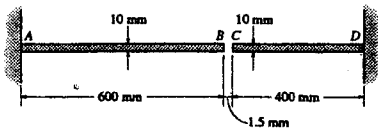

$$\delta_T = \alpha \Delta T L$$

Require,

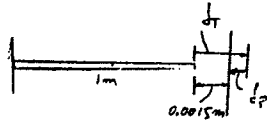

$$\delta_T = 0.0015 \text{ m} = \delta_{B/A} + \delta_{C/D}$$

$$0.0015 = 24(10^{-6})(T_2 - 25)(0.6) + 26(10^{-6})(T_2 - 25)(0.4)$$

$$T_2 = 85.5^\circ\text{C} \quad \text{Ans}$$

The problem is equivalent to that shown in the diagram. Require,

$$(\rightarrow) \delta_T - \delta_P = 0.0015$$

$$\Sigma(\alpha \Delta T L) - \Sigma\left(\frac{FL}{AE}\right) = 0.0015$$

$$\frac{24(10^{-6})(100 - 25)(0.6) + 26(10^{-6})(100 - 25)(0.4)}{(0.01)(0.015)(68.9)(10^9)} - \frac{F(0.4)}{(0.01)(0.015)(44.7)(10^9)} = 0.0015$$

$$F = 3.06 \text{ kN} \quad \text{Ans}$$

From *Mechanics of Materials*, Sixth Edition by R. C. Hibbeler, ISBN 0-13-191345-X.

© 2005 R. C. Hibbeler. Published by Pearson Prentice Hall,

Pearson Education, Inc., Upper Saddle River, NJ. All rights reserved.

This material is protected under all copyright laws as they currently exist. No portion of this material may be reproduced, in any form or by any means, without permission in writing from the publisher.

*4-76. The C83400-red-brass rod AB and 2014-T6-aluminum rod BC are joined at the collar B and fixed connected at their ends. If there is no load in the members when $T_1 = 50^\circ\text{F}$, determine the average normal stress in each member when $T_2 = 120^\circ\text{F}$. Also, how far will the collar be displaced? The cross-sectional area of each member is 1.75 in^2 .

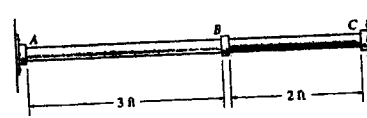

$$\Sigma F_x = 0; \quad F_{br} = F_{al} = F$$

$$\delta_{AC} = 0$$

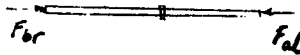

$$-\frac{F_{br}L_{AB}}{A_{AB}E_{br}} + \alpha_B \Delta T L_{AB} - \frac{F_{al}L_{BC}}{A_{BC}E_{al}} + \alpha_{al} \Delta T L_{BC} = 0$$

$$-\frac{F(3)(12)}{(1.75)(14.6)(10^6)} + 9.80(10^{-6})(120 - 50)(3)(12)$$

$$-\frac{F(2)(12)}{1.75(10.6)(10^6)} + 12.8(10^{-6})(120 - 50)(2)(12) = 0$$

$$F = 17\,093.4 \text{ lb}$$

$$\sigma_{br} = \sigma_{al} = \frac{17\,093.4}{1.75} = 9.77 \text{ ksi} \quad \text{Ans}$$

$$9.77 \text{ ksi} < (\sigma_Y)_{al} \quad \text{and} \quad (\sigma_Y)_{br} \quad \text{OK}$$

$$\delta_B = \frac{17\,093.4(3)(12)}{1.75(14.6)(10^6)} + 9.80(10^{-6})(120 - 50)(3)(12)$$

$$\delta_B = 0.611(10^{-3}) \text{ in.} \rightarrow \quad \text{Ans}$$

From *Mechanics of Materials*, Sixth Edition by R. C. Hibbeler, ISBN 0-13-191345-X.

© 2005 R. C. Hibbeler. Published by Pearson Prentice Hall,

Pearson Education, Inc., Upper Saddle River, NJ. All rights reserved.

This material is protected under all copyright laws as they currently exist. No portion of this material may be reproduced, in any form or by any means, without permission in writing from the publisher.

4-77 The 50-mm-diameter cylinder is made from Am 1004-T61 magnesium and is placed in the clamp when the temperature is $T_1 = 20^\circ\text{C}$. If the 304-stainless-steel carriage bolts of the clamp each have a diameter of 10 mm, and they hold the cylinder snug with negligible force against the rigid jaws, determine the force in the cylinder when the temperature rises to $T_2 = 130^\circ\text{C}$.

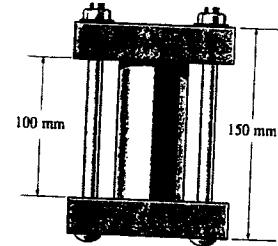
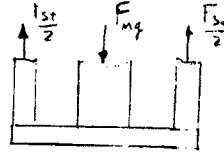

$$+\uparrow \Sigma F_y = 0; \quad F_{st} = F_{mg} = F$$

$$\delta_{mg} = \delta_{st}$$

$$\alpha_{mg} L_{mg} \Delta T - \frac{F_{mg} L_{mg}}{E_{mg} A_{mg}} = \alpha_{st} L_{st} \Delta T + \frac{F_{st} L_{st}}{E_{st} A_{st}}$$

$$26(10^{-6})(0.1)(110) - \frac{F(0.1)}{44.7(10^9)\frac{\pi}{4}(0.05)^2} = 17(10^{-6})(0.150)(110) + \frac{F(0.150)}{193(10^9)(2)\frac{\pi}{4}(0.01)^2}$$

$$F = 904 \text{ N} \quad \text{Ans}$$

From *Mechanics of Materials*, Sixth Edition by R. C. Hibbeler, ISBN 0-13-191345-X.

© 2005 R. C. Hibbeler. Published by Pearson Prentice Hall,

Pearson Education, Inc., Upper Saddle River, NJ. All rights reserved.

This material is protected under all copyright laws as they currently exist. No portion of this material may be reproduced, in any form or by any means, without permission in writing from the publisher.

4-78. The 50-mm-diameter cylinder is made from Am 1004-T61 magnesium and is placed in the clamp when the temperature is $T_1 = 15^\circ\text{C}$. If the two 304-stainless-steel carriage bolts of the clamp each have a diameter of 10 mm, and they hold the cylinder snug with negligible force against the rigid jaws, determine the temperature at which the average normal stress in either the magnesium or steel becomes 12 MPa.

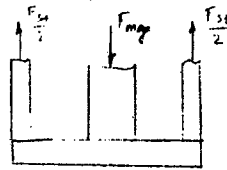
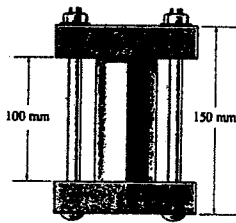

$$+\uparrow \Sigma F_y = 0; \quad F_{st} = F_{mg} = F$$

$$\delta_{mg} = \delta_{st}$$

$$\alpha_{mg} L_{mg} \Delta T - \frac{F_{mg} L_{mg}}{E_{mg} A_{mg}} = \alpha_{st} L_{st} \Delta T + \frac{F_{st} L_{st}}{E_{st} A_{st}}$$

$$26(10^{-6})(0.1)(\Delta T) - \frac{F(0.1)}{44.7(10^9)\frac{\pi}{4}(0.05)^2} = 17(10^{-6})(0.150)(\Delta T) + \frac{F(0.150)}{193(10^9)(2)\frac{\pi}{4}(0.01)^2}$$

The steel has the smallest cross-sectional area.

$$F = \sigma A = 12(10^6)(2)\left(\frac{\pi}{4}\right)(0.01)^2 = 1885.0 \text{ N}$$

Thus,

$$\Delta T = 229^\circ$$

$$T_2 = 229^\circ + 15^\circ = 244^\circ \quad \text{Ans}$$

From *Mechanics of Materials*, Sixth Edition by R. C. Hibbeler, ISBN 0-13-191345-X.

© 2005 R. C. Hibbeler. Published by Pearson Prentice Hall,

Pearson Education, Inc., Upper Saddle River, NJ. All rights reserved.

This material is protected under all copyright laws as they currently exist. No portion of this material may be reproduced, in any form or by any means, without permission in writing from the publisher.

4-79 The assembly consists of a 2014-T6-aluminum cylinder having an outer diameter of 200 mm and inner diameter of 150 mm, together with a concentric solid inner cylinder of Am 1004-T61 magnesium, having a diameter of 125 mm. If the clamping force in the bolts *AB* and *CD* is 4 kN when the temperature is $T_1 = 16^\circ\text{C}$, determine the force in the bolts when the temperature becomes $T_2 = 48^\circ\text{C}$. Assume the bolts and the restraining bars are rigid.

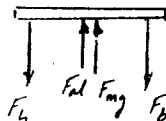
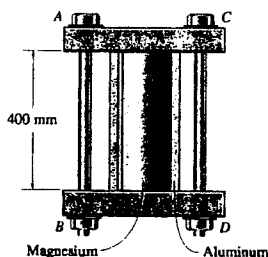

For aluminum :

$$-\delta_F + \delta_T = 0$$

$$\frac{F_{al}(0.4)}{\frac{\pi}{4}((0.2)^2 - (0.15)^2)73.1(10^9)} + 23(10^{-6})(48 - 16)(0.4) = 0$$

$$F_{al} = 739.47 \text{ kN}$$

For magnesium :

$$-\delta_F + \delta_T = 0$$

$$-\frac{F_{mg}(0.4)}{\frac{\pi}{4}(0.125)^2(44.7)(10^9)} + 26(10^{-6})(48 - 16)(0.4) = 0$$

$$F_{mg} = 456.39 \text{ kN}$$

$$+\uparrow \Sigma F_z = 0: \quad 739.47 + 456.39 - 2F_b = 0$$

$$F_b = 598 \text{ kN} \quad \text{Ans}$$

Note :

$$\sigma_{al} = \frac{F_{al}}{A_{al}} = \frac{739.47(10)^3}{\frac{\pi}{4}[(0.2)^2 - (0.15)^2]} = 53.8 \text{ MPa} < 414 \text{ MPa} = (\sigma_Y)_{al}$$

$$\sigma_{mg} = \frac{F_{mg}}{A_{mg}} = \frac{456.39(10)^3}{\frac{\pi}{4}(0.125)^2} = 37.2 \text{ MPa} < 152 \text{ MPa} = (\sigma_Y)_{mg}$$

From *Mechanics of Materials*, Sixth Edition by R. C. Hibbeler, ISBN 0-13-191345-X.

© 2005 R. C. Hibbeler. Published by Pearson Prentice Hall,

Pearson Education, Inc., Upper Saddle River, NJ. All rights reserved.

This material is protected under all copyright laws as they currently exist. No portion of this material may be reproduced, in any form or by any means, without permission in writing from the publisher.

***4-80** The center rod CD of the assembly is heated from $T_1 = 30^\circ\text{C}$ to $T_2 = 180^\circ\text{C}$ using electrical resistance heating. At the lower temperature T_1 the gap between C and the rigid bar is 0.7 mm . Determine the force in rods AB and EF caused by the increase in temperature. Rods AB and EF are made of steel, and each has a cross-sectional area of 125 mm^2 . CD is made of aluminum and has a cross-sectional area of 375 mm^2 . $E_{st} = 200\text{ GPa}$, $E_{al} = 70\text{ GPa}$, and $\alpha_{al} = 23(10^{-6})/^\circ\text{C}$.

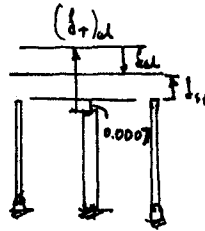
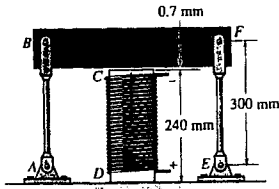

$$\delta_{st} = (\delta_T)_{al} - \delta_{al} - 0.0007$$

$$\frac{F_{st}(0.3)}{(125)(10^{-6})(200)(10^9)} = 23(10^{-6})(150)(0.24) - \frac{F(0.24)}{(375)(10^{-6})(70)(10^9)} - 0.0007$$

$$12F_{st} = 128\,000 - 9.1428F \quad (1)$$

$$+\uparrow \Sigma F_y = 0; \quad F - 2F_{st} = 0 \quad (2)$$

Solving Eqs. (1) and (2) yields,

$$F_{AB} = F_{EF} = F_{st} = 4.23\text{ kN} \quad \mathbf{Ans}$$

$$F_{CD} = F = 8.45\text{ kN}$$

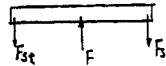

From *Mechanics of Materials*, Sixth Edition by R. C. Hibbeler, ISBN 0-13-191345-X.

© 2005 R. C. Hibbeler. Published by Pearson Prentice Hall,

Pearson Education, Inc., Upper Saddle River, NJ. All rights reserved.

This material is protected under all copyright laws as they currently exist. No portion of this material may be reproduced, in any form or by any means, without permission in writing from the publisher.

4-81 The center rod CD of the assembly is heated from $T_1 = 30^\circ\text{C}$ to $T_2 = 180^\circ\text{C}$ using electrical resistance heating. Also, the two end rods AB and EF are heated from $T_1 = 30^\circ\text{C}$ to $T_2 = 50^\circ\text{C}$. At the lower temperature T_1 the gap between C and the rigid bar is 0.7 mm . Determine the force in rods AB and EF caused by the increase in temperature. Rods AB and EF are made of steel, and each has a cross-sectional area of 125 mm^2 . CD is made of aluminum and has a cross-sectional area of 375 mm^2 . $E_{st} = 200\text{ GPa}$, $E_{al} = 70\text{ GPa}$, $\alpha_{st} = 12(10^{-6})/^\circ\text{C}$, and $\alpha_{al} = 23(10^{-6})/^\circ\text{C}$.

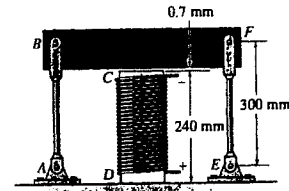

$$\delta_{st} + (\delta_T)_{st} = (\delta_T)_{al} - \delta_{al} - 0.0007$$

$$\frac{F_{st}(0.3)}{(125)(10^{-6})(200)(10^9)} + 12(10^{-6})(50 - 30)(0.3)$$

$$= 23(10^{-6})(180 - 30)(0.24) - \frac{F_{al}(0.24)}{375(10^{-6})(70)(10^9)} - 0.0007$$

$$12.0F_{st} + 9.14286F_{al} = 56000 \quad (1)$$

$$+\uparrow \Sigma F_y = 0; \quad F_{al} - 2F_{st} = 0 \quad (2)$$

Solving Eqs. (1) and (2) yields :

$$F_{AB} = F_{EF} = F_{st} = 1.85\text{ kN} \quad \text{Ans}$$

$$F_{CD} = F_{al} = 3.70\text{ kN}$$

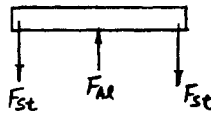
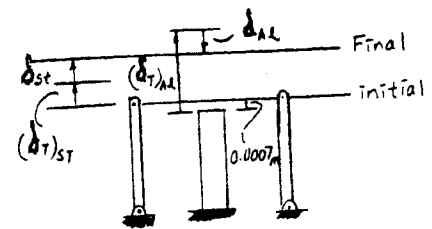

From *Mechanics of Materials*, Sixth Edition by R. C. Hibbeler, ISBN 0-13-191345-X.

© 2005 R. C. Hibbeler. Published by Pearson Prentice Hall,

Pearson Education, Inc., Upper Saddle River, NJ. All rights reserved.

This material is protected under all copyright laws as they currently exist. No portion of this material may be reproduced, in any form or by any means, without permission in writing from the publisher.

4-82 The three bars are made of A-36 steel and form a pin-connected truss. If the truss is constructed when $T_1 = 50^\circ\text{F}$, determine the force in each bar when $T_2 = 110^\circ\text{F}$. Each bar has a cross-sectional area of 2 in^2 .

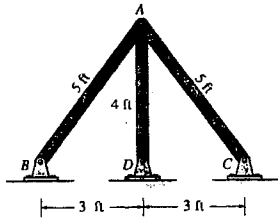

$$(\delta_T')_{AB} - (\delta_F')_{AB} = (\delta_T)_{AD} + (\delta_F)_{AD} \quad (1)$$

However, $\delta_{AB} = \delta'_{AB} \cos \theta$;

$$\delta'_{AB} = \frac{\delta_{AB}}{\cos \theta} = \frac{5}{4} \delta_{AB}$$

Substitute into Eq. (1)

$$\frac{5}{4}(\delta_T)_{AB} - \frac{5}{4}(\delta_F)_{AB} = (\delta_T)_{AD} + (\delta_F)_{AD}$$

$$\frac{5}{4} \left[6.60(10^{-6})(110^\circ - 50^\circ)(5)(12) - \frac{F_{AB}(5)(12)}{2(29)(10^3)} \right]$$

$$= 6.60(10^{-6})(110^\circ - 50^\circ)(4)(12) + \frac{F_{AD}(4)(12)}{2(29)(10^3)}$$

$$620.136 = 75F_{AB} + 48F_{AD} \quad (2)$$

$$+\sum F_x = 0: \quad \frac{3}{5}F_{AC} - \frac{3}{5}F_{AB} = 0; \quad F_{AC} = F_{AB}$$

$$+\uparrow \sum F_y = 0: \quad F_{AD} - 2\left(\frac{4}{5}F_{AB}\right) = 0 \quad (3)$$

Solving Eqs. (2) and (3) yields :

$$F_{AD} = 6.54 \text{ kip} \quad \text{Ans}$$

$$F_{AC} = F_{AB} = 4.09 \text{ kip} \quad \text{Ans}$$

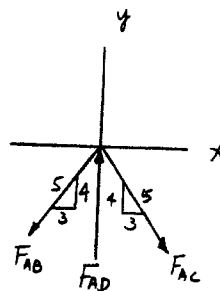
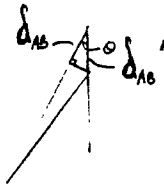
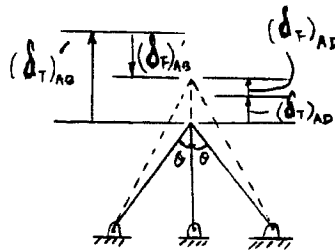

From *Mechanics of Materials*, Sixth Edition by R. C. Hibbeler, ISBN 0-13-191345-X.

© 2005 R. C. Hibbeler. Published by Pearson Prentice Hall,

Pearson Education, Inc., Upper Saddle River, NJ. All rights reserved.

This material is protected under all copyright laws as they currently exist. No portion of this material may be reproduced, in any form or by any means, without permission in writing from the publisher.

4-83 The three bars are made of A-36 steel and form a pin-connected truss. If the truss is constructed when $T_1 = 50^\circ\text{F}$, determine the vertical displacement of joint A when $T_2 = 150^\circ\text{F}$. Each bar has a cross-sectional area of 2 in^2 .

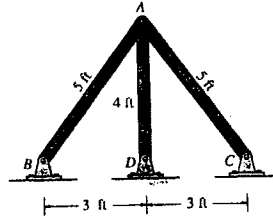

$$(\delta_T)_{AB} - (\delta_F)_{AB} = (\delta_T)_{AD} + (\delta_F)_{AD} \quad (1)$$

However, $\delta_{AB} = \delta'_{AB} \cos \theta$;

$$\delta'_{AB} = \frac{\delta_{AB}}{\cos \theta} = \frac{5}{4} \delta_{AB}$$

Substitute into Eq. (1)

$$\frac{5}{4}(\delta_T)_{AB} - \frac{5}{4}(\delta_F)_{AB} = (\delta_T)_{AD} + (\delta_F)_{AD}$$

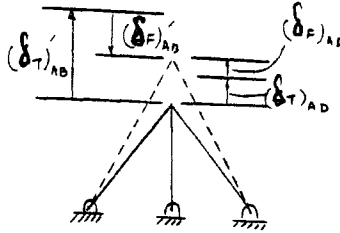

$$\begin{aligned} \frac{5}{4} [6.60(10^{-6})(150^\circ - 50^\circ)(5)(12) - \frac{F_{AB}(5)(12)}{2(29)(10^3)}] \\ = 6.60(10^{-6})(150^\circ - 50^\circ)(4)(12) + \frac{F_{AD}(4)(12)}{2(29)(10^3)} \end{aligned}$$

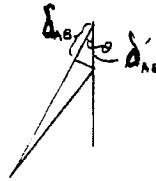

$$\begin{aligned} 239.25 - 6.25F_{AB} &= 153.12 + 4F_{AD} \\ 4F_{AD} + 6.25F_{AB} &= 86.13 \quad (2) \end{aligned}$$

$$+\Sigma F_x = 0: \quad \frac{3}{5}F_{AC} - \frac{3}{5}F_{AB} = 0; \quad F_{AC} = F_{AB}$$

$$\begin{aligned} +\uparrow \Sigma F_y = 0: \quad F_{AD} - 2\left(\frac{4}{5}F_{AB}\right) &= 0; \\ F_{AD} &= 1.6F_{AB} \quad (3) \end{aligned}$$

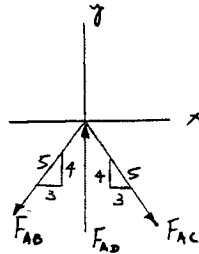

Solving Eqs. (2) and (3) yields :

$$F_{AB} = 6.8086 \text{ kip}; \quad F_{AD} = 10.8939 \text{ kip}$$

$$\begin{aligned} (\delta_A)_v &= (\delta_T)_{AD} + (\delta_F)_{AD} \\ &= 6.60(10^{-6})(150^\circ - 50^\circ)(4)(12) + \frac{10.8939(4)(12)}{2(29)(10^3)} \\ &= 0.0407 \text{ in. } \uparrow \quad \text{Ans} \end{aligned}$$

From *Mechanics of Materials*, Sixth Edition by R. C. Hibbeler, ISBN 0-13-191345-X.

© 2005 R. C. Hibbeler. Published by Pearson Prentice Hall,

Pearson Education, Inc., Upper Saddle River, NJ. All rights reserved.

This material is protected under all copyright laws as they currently exist. No portion of this material may be reproduced, in any form or by any means, without permission in writing from the publisher.

*4-84 The rod is made of A-36 steel and has a diameter of 0.25 in. If the springs are compressed 0.5 in. when the temperature of the rod is $T = 40^\circ\text{F}$, determine the force in the rod when its temperature is $T = 160^\circ\text{F}$.

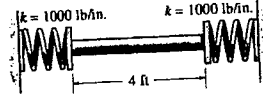

$$x = \Delta_T - \delta_F$$

$$x = 6.60(10^{-6})(160 - 40)(2)(12) - \frac{1.0(x + 0.5)(2)(12)}{\frac{\pi}{4}(0.25^2)(29)(10^3)}$$

$$x = 0.0104 \text{ in.}$$

$$F = 1.0(0.0104 + 0.5) = 0.510 \text{ kip} = 510 \text{ lb} \quad \text{Ans}$$

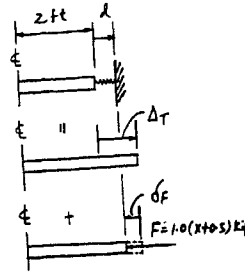

From *Mechanics of Materials*, Sixth Edition by R. C. Hibbeler, ISBN 0-13-191345-X.

© 2005 R. C. Hibbeler. Published by Pearson Prentice Hall,

Pearson Education, Inc., Upper Saddle River, NJ. All rights reserved.

This material is protected under all copyright laws as they currently exist. No portion of this material may be reproduced, in any form or by any means, without permission in writing from the publisher.

4-85 The bar has a cross-sectional area A , length L , modulus of elasticity E , and coefficient of thermal expansion α . The temperature of the bar changes uniformly from an original temperature of T_A to T_B so that at any point x along the bar $T = T_A + x(T_B - T_A)/L$. Determine the force the bar exerts on the rigid walls. Initially no axial force is in the bar.



$$0 = \Delta_T - \delta_F \quad (1)$$

However,

$$d\Delta_T = \alpha \Delta_T dx = \alpha \left(T_A + \frac{T_B - T_A}{L} x - T_A \right) dx$$

$$\Delta_T = \alpha \int_0^L \frac{T_B - T_A}{L} x dx = \alpha \left[\frac{T_B - T_A}{2L} x^2 \right]_0^L$$

$$= \alpha \left[\frac{T_B - T_A}{2} L \right] = \frac{\alpha L}{2} (T_B - T_A)$$

From Eq.(1).

$$0 = \frac{\alpha L}{2} (T_B - T_A) - \frac{FL}{AE}$$

$$F = \frac{\alpha AE}{2} (T_B - T_A) \quad \text{Ans}$$

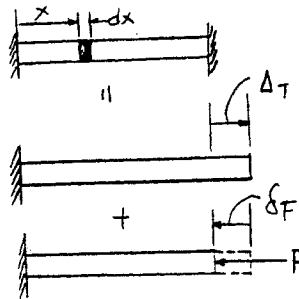

From *Mechanics of Materials*, Sixth Edition by R. C. Hibbeler, ISBN 0-13-191345-X.

© 2005 R. C. Hibbeler. Published by Pearson Prentice Hall,

Pearson Education, Inc., Upper Saddle River, NJ. All rights reserved.

This material is protected under all copyright laws as they currently exist. No portion of this material may be reproduced, in any form or by any means, without permission in writing from the publisher.

4-96 The metal strap has a thickness t and width w and is subjected to a temperature gradient T_1 to T_2 ($T_1 < T_2$). This causes the modulus of elasticity for the material to vary linearly from E_1 at the top to a smaller amount E_2 at the bottom. As a result, for any vertical position y , $E = [(E_2 - E_1)/w]y + E_1$. Determine the position d where the axial force P must be applied so that the bar stretches uniformly over its cross section.

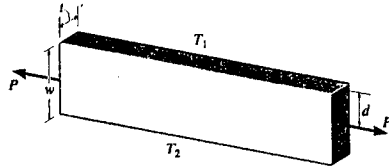

$$\epsilon = \text{constant} = \epsilon_0$$

$$\epsilon_0 = \frac{\sigma}{E} = \frac{\sigma}{\left(\frac{E_2 - E_1}{w}\right)y + E_1}$$

$$\sigma = \epsilon_0 \left(\frac{E_2 - E_1}{w} y + E_1 \right)$$

$$\sum F_x = 0: \quad P - \int_A \sigma dA = 0$$

$$P = \int_0^w \sigma t dy = \int_0^w \epsilon_0 \left(\frac{E_2 - E_1}{w} y + E_1 \right) t dy$$

$$P = \epsilon_0 t \left(\frac{(E_2 - E_1)w}{2} + E_1 w \right) = \epsilon_0 t \left(\frac{E_2 + E_1}{2} \right) w$$

$$\sum M_0 = 0: \quad P(d) - \int_A y \sigma dA = 0$$

$$\epsilon_0 t \left(\frac{E_2 + E_1}{2} \right) w d = \int_0^w \epsilon_0 \left(\frac{E_2 - E_1}{w} y^2 + E_1 y \right) t dy$$

$$\epsilon_0 t \left(\frac{E_2 + E_1}{2} \right) w d = \epsilon_0 t \left(\frac{E_2 - E_1}{3} w^2 + \frac{E_1}{2} w^2 \right)$$

$$\left(\frac{E_2 + E_1}{2} \right) d = \frac{1}{6} (2E_2 + E_1) w$$

$$d = \left(\frac{2E_2 + E_1}{3(E_2 + E_1)} \right) w \quad \text{Ans}$$

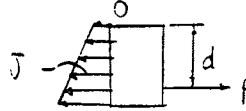
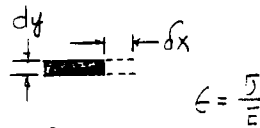
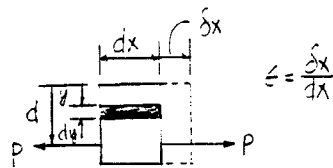
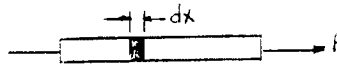

From *Mechanics of Materials*, Sixth Edition by R. C. Hibbeler, ISBN 0-13-191345-X.

© 2005 R. C. Hibbeler. Published by Pearson Prentice Hall,

Pearson Education, Inc., Upper Saddle River, NJ. All rights reserved.

This material is protected under all copyright laws as they currently exist. No portion of this material may be reproduced, in any form or by any means, without permission in writing from the publisher.

4-87 Determine the maximum normal stress developed in the bar when it is subjected to a tension of $P = 8 \text{ kN}$.

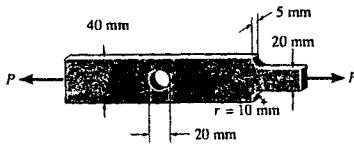

For the fillet :

$$\frac{w}{h} = \frac{40}{20} = 2 \quad \frac{r}{h} = \frac{10}{20} = 0.5$$

From Fig. 10-23. $K = 1.4$

$$\begin{aligned} \sigma_{\max} &= K\sigma_{\text{avg}} \\ &= 1.4 \left(\frac{8 (10^3)}{0.02 (0.005)} \right) \\ &= 112 \text{ MPa} \end{aligned}$$

For the hole :

$$\frac{r}{w} = \frac{10}{40} = 0.25$$

From Fig. 4-24. $K = 2.375$

$$\begin{aligned} \sigma_{\max} &= K\sigma_{\text{avg}} \\ &= 2.375 \left(\frac{8 (10^3)}{(0.04 - 0.02)(0.005)} \right) \\ &= 190 \text{ MPa} \quad \mathbf{Ans} \end{aligned}$$

From *Mechanics of Materials*, Sixth Edition by R. C. Hibbeler, ISBN 0-13-191345-X.

© 2005 R. C. Hibbeler. Published by Pearson Prentice Hall,

Pearson Education, Inc., Upper Saddle River, NJ. All rights reserved.

This material is protected under all copyright laws as they currently exist. No portion of this material may be reproduced, in any form or by any means, without permission in writing from the publisher.

***4-88.** If the allowable normal stress for the bar is $\sigma_{\text{allow}} = 120 \text{ MPa}$, determine the maximum axial force P that can be applied to the bar.

Assume failure of the fillet.

$$\frac{w}{h} = \frac{40}{20} = 2; \quad \frac{r}{h} = \frac{10}{20} = 0.5$$

From Fig. 4-23, $K = 1.4$

$$\sigma_{\text{allow}} = \sigma_{\text{max}} = K\sigma_{\text{avg}}$$

$$120 (10^6) = 1.4 \left(\frac{P}{0.02 (0.005)} \right)$$

$$P = 8.57 \text{ kN}$$

Assume failure of the hole.

$$\frac{r}{w} = \frac{10}{40} = 0.25$$

From Fig. 4-24, $K = 2.375$

$$\sigma_{\text{allow}} = \sigma_{\text{max}} = K\sigma_{\text{avg}}$$

$$120 (10^6) = 2.375 \left(\frac{P}{(0.04 - 0.02) (0.005)} \right)$$

$$P = 5.05 \text{ kN} \quad (\text{controls}) \quad \mathbf{Ans}$$

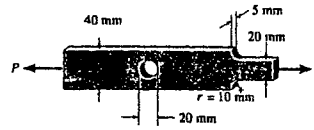

From *Mechanics of Materials*, Sixth Edition by R. C. Hibbeler, ISBN 0-13-191345-X.

© 2005 R. C. Hibbeler. Published by Pearson Prentice Hall,

Pearson Education, Inc., Upper Saddle River, NJ. All rights reserved.

This material is protected under all copyright laws as they currently exist. No portion of this material may be reproduced, in any form or by any means, without permission in writing from the publisher.

4-89. The member is to be made from a steel plate that is 0.25 in. thick. If a 1-in. hole is drilled through its center, determine the approximate width w of the plate so that it can support an axial force of 3350 lb. The allowable stress is $\sigma_{\text{allow}} = 22$ ksi.

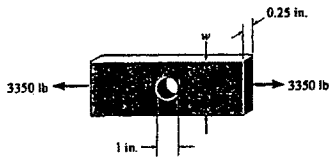

$$\sigma_{\text{allow}} = \sigma_{\text{max}} = K\sigma_{\text{avg}}$$

$$22 = K \left[\frac{3.35}{(w - 1)(0.25)} \right]$$

$$w = \frac{3.35K + 5.5}{5.5}$$

By trial and error, from Fig. 4-24,

choose $\frac{r}{w} = 0.2$: $K = 2.45$

$$w = \frac{3.35(2.45) + 5.5}{5.5} = 2.49 \text{ in.} \quad \mathbf{Ans}$$

$$\text{Since } \frac{r}{w} = \frac{0.5}{2.49} = 0.2 \quad \mathbf{OK}$$

From *Mechanics of Materials*, Sixth Edition by R. C. Hibbeler, ISBN 0-13-191345-X.

© 2005 R. C. Hibbeler. Published by Pearson Prentice Hall,

Pearson Education, Inc., Upper Saddle River, NJ. All rights reserved.

This material is protected under all copyright laws as they currently exist. No portion of this material may be reproduced, in any form or by any means, without permission in writing from the publisher.

4-90 Determine the maximum axial force P that can be applied to the bar. The bar is made from steel and has an allowable stress of $\sigma_{\text{allow}} = 21$ ksi.

Assume failure of the fillet.

$$\frac{r}{h} = \frac{0.25}{1.25} = 0.2 \quad \frac{w}{h} = \frac{1.875}{1.25} = 1.5$$

From Fig. 4-23. $K = 1.75$

$$\begin{aligned} \sigma_{\text{allow}} &= \sigma_{\text{max}} = K\sigma_{\text{avg}} \\ 21 &= 1.75 \left(\frac{P}{1.25(0.125)} \right) \\ P &= 1.875 \text{ kip} \end{aligned}$$

Assume failure of the hole.

$$\frac{r}{w} = \frac{0.375}{1.875} = 0.20$$

From Fig. 4-24. $K = 2.45$

$$\begin{aligned} \sigma_{\text{allow}} &= \sigma_{\text{max}} = K\sigma_{\text{avg}} \\ 21 &= 2.45 \left(\frac{P}{(1.875 - 0.75)(0.125)} \right) \end{aligned}$$

$$P = 1.21 \text{ kip} \quad (\text{controls}) \quad \mathbf{Ans}$$

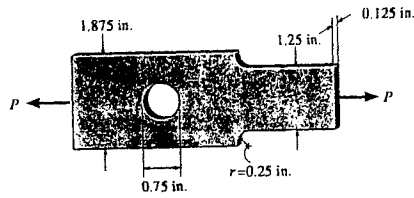

From *Mechanics of Materials*, Sixth Edition by R. C. Hibbeler, ISBN 0-13-191345-X.
 © 2005 R. C. Hibbeler. Published by Pearson Prentice Hall,
 Pearson Education, Inc., Upper Saddle River, NJ. All rights reserved.
 This material is protected under all copyright laws as they currently exist. No portion of this material may be reproduced, in any form or by any means, without permission in writing from the publisher.

4-91 Determine the maximum normal stress developed in the bar when it is subjected to a tension of $P = 2$ kip.

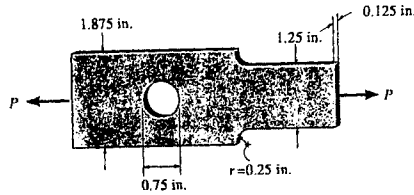

At fillet :

$$\frac{r}{h} = \frac{0.25}{1.25} = 0.2 \quad \frac{w}{h} = \frac{1.875}{1.25} = 1.5$$

From Fig. 4-23, $K = 1.73$

$$\sigma_{\max} = K \left(\frac{P}{A} \right) = 1.73 \left[\frac{2}{1.25(0.125)} \right] = 22.1 \text{ ksi}$$

At hole :

$$\frac{r}{w} = \frac{0.375}{1.875} = 0.20$$

From Fig. 4-24, $K = 2.45$

$$\sigma_{\max} = 2.45 \left[\frac{2}{(1.875 - 0.75)(0.125)} \right] = 34.8 \text{ ksi} \quad (\text{Controls}) \quad \text{Ans}$$

From *Mechanics of Materials*, Sixth Edition by R. C. Hibbeler, ISBN 0-13-191345-X.

© 2005 R. C. Hibbeler. Published by Pearson Prentice Hall,

Pearson Education, Inc., Upper Saddle River, NJ. All rights reserved.

This material is protected under all copyright laws as they currently exist. No portion of this material may be reproduced, in any form or by any means, without permission in writing from the publisher.

***4-92.** The A-36 steel plate has a thickness of 12 mm. If there are shoulder fillets at *B* and *C*, and $\sigma_{\text{allow}} = 150 \text{ MPa}$, determine the maximum axial load *P* that it can support. Compute its elongation neglecting the effect of the fillets.

Maximum Normal Stress at fillet :

$$\frac{r}{h} = \frac{30}{60} = 0.5 \quad \text{and} \quad \frac{w}{h} = \frac{120}{60} = 2$$

From the text, $K = 1.4$

$$\sigma_{\text{max}} = \sigma_{\text{allow}} = K\sigma_{\text{avg}}$$

$$150(10^6) = 1.4 \left[\frac{P}{0.06(0.012)} \right]$$

$$P = 77142.86 \text{ N} = 77.1 \text{ kN} \quad \text{Ans}$$

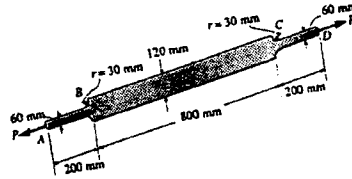

Displacement :

$$\begin{aligned} \delta &= \sum \frac{PL}{AE} \\ &= \frac{77142.86(400)}{(0.06)(0.012)(200)(10^9)} + \frac{77142.86(800)}{(0.12)(0.012)(200)(10^9)} \\ &= 0.429 \text{ mm} \quad \text{Ans} \end{aligned}$$

From *Mechanics of Materials*, Sixth Edition by R. C. Hibbeler, ISBN 0-13-191345-X.

© 2005 R. C. Hibbeler. Published by Pearson Prentice Hall,

Pearson Education, Inc., Upper Saddle River, NJ. All rights reserved.

This material is protected under all copyright laws as they currently exist. No portion of this material may be reproduced, in any form or by any means, without permission in writing from the publisher.

4-93 The resulting stress distribution along section AB for the bar is shown. From this distribution, determine the approximate resultant axial force P applied to the bar. Also, what is the stress-concentration factor for this geometry?

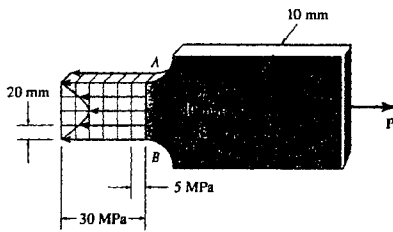

Number of squares ≈ 19

$$P = 19(5)(10^6)(0.02)(0.01) = 19 \text{ kN} \quad \mathbf{Ans}$$

$$\sigma_{avg} = \frac{P}{A} = \frac{19(10^3)}{0.08(0.01)} = 23.75 \text{ MPa}$$

$$K = \frac{\sigma_{max}}{\sigma_{avg}} = \frac{30 \text{ MPa}}{23.75 \text{ MPa}} = 1.26 \quad \mathbf{Ans}$$

From *Mechanics of Materials*, Sixth Edition by R. C. Hibbeler, ISBN 0-13-191345-X.

© 2005 R. C. Hibbeler. Published by Pearson Prentice Hall,

Pearson Education, Inc., Upper Saddle River, NJ. All rights reserved.

This material is protected under all copyright laws as they currently exist. No portion of this material may be reproduced, in any form or by any means, without permission in writing from the publisher.

4-94. The resulting stress distribution along section AB for the bar is shown. From this distribution, determine the approximate resultant axial force P applied to the bar. Also, what is the stress-concentration factor for this geometry?

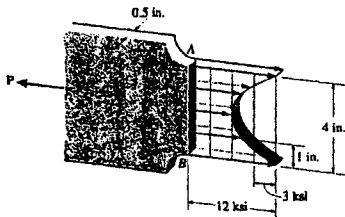

$$P = \int \sigma dA = \text{Volume under curve}$$

Number of squares = 10

$$P = 10(3)(1)(0.5) = 15 \text{ kip} \quad \text{Ans}$$

$$\sigma_{avg} = \frac{P}{A} = \frac{15 \text{ kip}}{(4 \text{ in.})(0.5 \text{ in.})} = 7.5 \text{ ksi}$$

$$K = \frac{\sigma_{max}}{\sigma_{avg}} = \frac{12 \text{ ksi}}{7.5 \text{ ksi}} = 1.60 \quad \text{Ans}$$

From *Mechanics of Materials*, Sixth Edition by R. C. Hibbeler, ISBN 0-13-191345-X.

© 2005 R. C. Hibbeler. Published by Pearson Prentice Hall,

Pearson Education, Inc., Upper Saddle River, NJ. All rights reserved.

This material is protected under all copyright laws as they currently exist. No portion of this material may be reproduced, in any form or by any means, without permission in writing from the publisher.

4-95 The resulting stress distribution along section AB for the bar is shown. From this distribution, determine the approximate resultant axial force P applied to the bar. Also, what is the stress-concentration factor for this geometry?

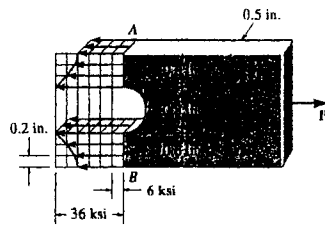

Number of squares ≈ 28

$$P = 28(6)(0.2)(0.5) = 16.8 \text{ kip} \quad \text{Ans}$$

$$\sigma_{\text{avg}} = \frac{P}{A} = \frac{16.8}{2(0.1)(0.5)} = 28 \text{ ksi}$$

$$K = \frac{\sigma_{\text{max}}}{\sigma_{\text{avg}}} = \frac{36}{28} = 1.29 \quad \text{Ans}$$

From *Mechanics of Materials*, Sixth Edition by R. C. Hibbeler, ISBN 0-13-191345-X.

© 2005 R. C. Hibbeler. Published by Pearson Prentice Hall,

Pearson Education, Inc., Upper Saddle River, NJ. All rights reserved.

This material is protected under all copyright laws as they currently exist. No portion of this material may be reproduced, in any form or by any means, without permission in writing from the publisher.

*4-96 The 10-mm-diameter shank of the steel bolt has a bronze sleeve bonded to it. The outer diameter of this sleeve is 20 mm. If the yield stress for the steel is $(\sigma_Y)_{st} = 640$ MPa, and for the bronze $(\sigma_Y)_{br} = 520$ MPa, determine the largest possible value of P that can be applied to the bolt. Assume the materials to be elastic perfectly plastic. $E_{st} = 200$ GPa, $E_{br} = 100$ GPa.

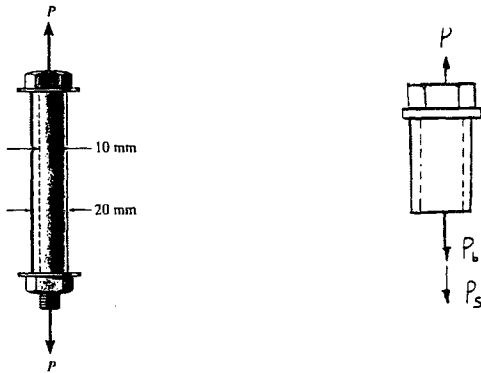

$$+\uparrow \Sigma F_y = 0: \quad P - P_b - P_s = 0 \quad (1)$$

The largest possible P that can be applied is when P causes both bolt and sleeve to yield. Hence,

$$P_b = (\sigma_{st})_Y A_b = 640(10^6) \left(\frac{\pi}{4}\right) (0.01^2) = 50.265 \text{ kN}$$

$$P_s = (\sigma_{br})_Y A_s = 520(10^6) \left(\frac{\pi}{4}\right) (0.02^2 - 0.01^2) = 122.52 \text{ kN}$$

From Eq. (1),

$$P = 50.265 + 122.52 = 173 \text{ kN} \quad \text{Ans}$$

From *Mechanics of Materials*, Sixth Edition by R. C. Hibbeler, ISBN 0-13-191345-X.

© 2005 R. C. Hibbeler. Published by Pearson Prentice Hall,

Pearson Education, Inc., Upper Saddle River, NJ. All rights reserved.

This material is protected under all copyright laws as they currently exist. No portion of this material may be reproduced, in any form or by any means, without permission in writing from the publisher.

4-97 The 10-mm-diameter shank of the steel bolt has a bronze sleeve bonded to it. The outer diameter of this sleeve is 20 mm. If the yield stress for the steel is $(\sigma_Y)_{st} = 640$ MPa, and for the bronze $(\sigma_Y)_{br} = 520$ MPa, determine the magnitude of the largest elastic load P that can be applied to the assembly. $E_{st} = 200$ GPa, $E_{br} = 100$ GPa.

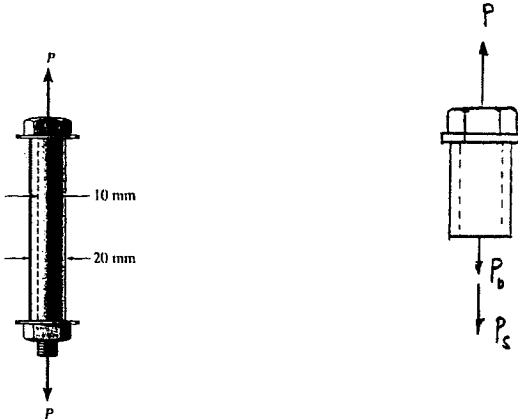

$$+\uparrow \Sigma F_y = 0: \quad P - P_b - P_s = 0 \quad (1)$$

$$\Delta_b = \Delta_s; \quad \frac{P_b(L)}{\frac{\pi}{4}(0.01^2)(200)(10^9)} = \frac{P_s(L)}{\frac{\pi}{4}(0.02^2 - 0.01^2)(100)(10^9)}$$

$$P_b = 0.6667 P \quad (2)$$

Assume yielding of the bolt :

$$P_b = (\sigma_Y)_{st} A_b = 640 (10^6) \left(\frac{\pi}{4}\right) (0.01^2) = 50.265 \text{ kN}$$

Using $P_b = 50.265$ kN and solving Eqs. (1) and (2) :

$$P_s = 75.40 \text{ kN}; \quad P = 125.66 \text{ kN}$$

Assume yielding of the sleeve :

$$P_s = (\sigma_Y)_{br} A_s = 520 (10^6) \left(\frac{\pi}{4}\right) (0.02^2 - 0.01^2) = 122.52 \text{ kN}$$

Use $P_s = 122.52$ kN, and solving Eqs. (1) and (2) :

$$P_b = 81.68 \text{ kN}; \quad P = 204.20 \text{ kN}$$

$$P = 126 \text{ kN (controls)} \quad \text{Ans}$$

From *Mechanics of Materials*, Sixth Edition by R. C. Hibbeler, ISBN 0-13-191345-X.

© 2005 R. C. Hibbeler. Published by Pearson Prentice Hall,

Pearson Education, Inc., Upper Saddle River, NJ. All rights reserved.

This material is protected under all copyright laws as they currently exist. No portion of this material may be reproduced, in any form or by any means, without permission in writing from the publisher.

4-98. The weight is suspended from steel and aluminum wires, each having the same initial length of 3 m and cross-sectional area of 4 mm². If the materials can be assumed to be elastic perfectly plastic, with $(\sigma_Y)_{st} = 120$ MPa and $(\sigma_Y)_{al} = 70$ MPa, determine the force in each wire if the weight is (a) 600 N and (b) 720 N. $E_{al} = 70$ GPa, $E_{st} = 200$ GPa.

$$+\uparrow \Sigma F_y = 0; \quad F_{al} + F_{st} - W = 0 \quad (1)$$

Assume both wires behave elastically.

$$\delta_{al} = \delta_{st}; \quad \frac{F_{al}L}{A(70)} = \frac{F_{st}L}{A(200)}$$

$$F_{al} = 0.35 F_{st} \quad (2)$$

a) When $W = 600$ N, solving Eqs. (1) and (2) yields :

$$F_{st} = 444.44 \text{ N} = 444 \text{ N} \quad \text{Ans}$$

$$F_{al} = 155.55 \text{ N} = 156 \text{ N} \quad \text{Ans}$$

$$\sigma_{al} = \frac{F_{al}}{A_{al}} = \frac{155.55}{4(10^{-6})} = 38.88 \text{ MPa} < (\sigma_Y)_{al} = 70 \text{ MPa} \quad \text{OK}$$

$$\sigma_{st} = \frac{F_{st}}{A_{st}} = \frac{444.44}{4(10^{-6})} = 111.11 \text{ MPa} < (\sigma_Y)_{st} = 120 \text{ MPa} \quad \text{OK}$$

The elastic analysis is valid for both wires

b) When $W = 720$ N, solving Eqs. (1) and (2) yields :

$$F_{st} = 533.33 \text{ N}; \quad F_{al} = 186.67 \text{ N}$$

$$\sigma_{al} = \frac{F_{al}}{A_{al}} = \frac{186.67}{4(10^{-6})} = 46.67 \text{ MPa} < (\sigma_Y)_{al} = 70 \text{ MPa} \quad \text{OK}$$

$$\sigma_{st} = \frac{F_{st}}{A_{st}} = \frac{533.33}{4(10^{-6})} = 133.33 \text{ MPa} > (\sigma_Y)_{st} = 120 \text{ MPa}$$

Therefore, the steel wire yields. Hence,

$$F_{st} = (\sigma_Y)_{st} A_{st} = 120(10^6)(4)(10^{-6}) = 480 \text{ N} \quad \text{Ans}$$

$$\text{From Eq. (1), } F_{al} = 240 \text{ N} \quad \text{Ans}$$

$$\sigma_{al} = \frac{240}{4(10^{-6})} = 60 \text{ MPa} < (\sigma_Y)_{al} \quad \text{OK}$$

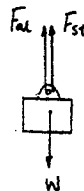
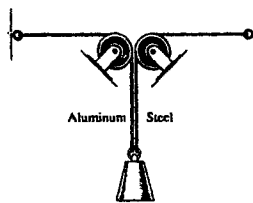

From *Mechanics of Materials*, Sixth Edition by R. C. Hibbeler, ISBN 0-13-191345-X.
 © 2005 R. C. Hibbeler. Published by Pearson Prentice Hall,
 Pearson Education, Inc., Upper Saddle River, NJ. All rights reserved.
 This material is protected under all copyright laws as they currently exist. No portion of this material may be reproduced, in any form or by any means, without permission in writing from the publisher.

4-99 The bar has a cross-sectional area of 1 in². If a force of $P = 45$ kip is applied at B and then removed, determine the residual stress in sections AB and BC . $\sigma_Y = 30$ ksi.

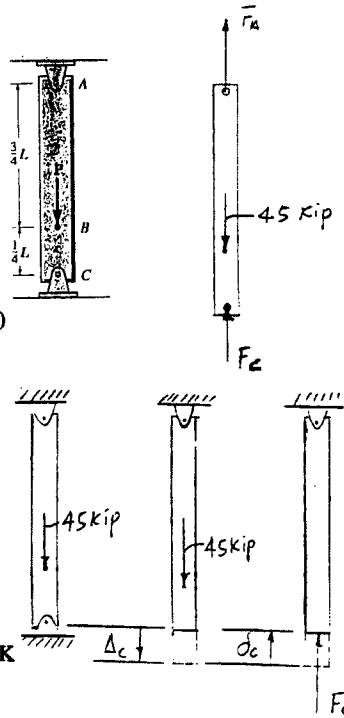

$$+\uparrow \Sigma F_y = 0: \quad F_A + F_C - 45 = 0 \quad (1)$$

Assume both segment AB and BC behave elastically.

$$+\downarrow 0 = \Delta_c - \delta_c: \quad \frac{45(\frac{3}{4}L)}{AE} = \frac{F_C L}{AE}$$

$$F_C = 33.75 \text{ kip}$$

$$\text{From Eq. (1), } F_A = 11.25 \text{ kip}$$

$$\sigma_{AB} = \frac{F_A}{A} = \frac{11.25}{1} = 11.25 \text{ ksi} < \sigma_Y = 30 \text{ ksi} \quad \text{OK}$$

$$\sigma_{BC} = \frac{F_C}{A} = \frac{33.75}{1} = 33.75 \text{ ksi} > \sigma_Y = 30 \text{ ksi}$$

Therefore segment BC yields and the elastic analysis is invalid.

Plastic analysis : Assume segment BC yields and AB behaves elastically.

$$F_C = \sigma_Y(A) = 30(1) = 30.0 \text{ kip}$$

$$\text{From Eq. (1), } F_A = 15.0 \text{ kip and } \sigma_{AB} = \frac{15}{1} = 15.0 \text{ ksi} < \sigma_Y = 30 \text{ ksi} \quad \text{OK}$$

A reversed force of 45 kip applied results in a reversed $F_C = 33.75$ kip

and $F_A = 11.25$ kip which produces $\sigma_{BC} = 33.75$ ksi (T) and

$\sigma_{AB} = 11.25$ ksi (C). Hence,

$$(\sigma_{AB})_r = 15 - 11.25 = 3.75 \text{ ksi (T)} \quad \text{Ans}$$

$$(\sigma_{BC})_r = -30 + 33.75 = 3.75 \text{ ksi (T)} \quad \text{Ans}$$

From *Mechanics of Materials*, Sixth Edition by R. C. Hibbeler, ISBN 0-13-191345-X.

© 2005 R. C. Hibbeler. Published by Pearson Prentice Hall,

Pearson Education, Inc., Upper Saddle River, NJ. All rights reserved.

This material is protected under all copyright laws as they currently exist. No portion of this material may be reproduced, in any form or by any means, without permission in writing from the publisher.

*4-100 Two steel wires, each having a cross-sectional area of 2 mm^2 , are tied to a ring at C , and then stretched and tied between the two pins A and B . The initial tension in the wires is 50 N . If a horizontal force P is applied to the ring, determine the force in each wire if $P = 20 \text{ N}$. What is the smallest force P that must be applied to the ring to reduce the force in wire CB to zero? Take $\sigma_Y = 300 \text{ MPa}$. $E_{st} = 200 \text{ GPa}$.

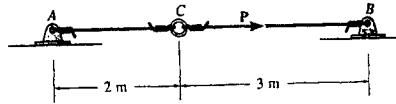

Equilibrium :

$$\rightarrow \Sigma F_x = 0; \quad 20 + (50 - P_2) - (50 + P_1) = 0$$

$$P_1 + P_2 = 20 \quad (1)$$

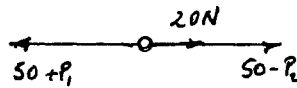

Compatibility condition :

$$\delta_C = \frac{P_1(2)}{AE} = \frac{P_2(3)}{AE}$$

$$P_1 = 1.5 P_2 \quad (2)$$

Solving Eqs. (1) and (2) yields:

$$P_1 = 12 \text{ N}, \quad P_2 = 8 \text{ N}$$

$$F_{AC} = 50 + 12 = 62 \text{ N} \quad \text{Ans}$$

$$F_{BC} = 50 - 8 = 42 \text{ N} \quad \text{Ans}$$

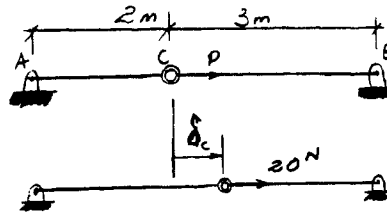

For $F_{CB} = 0$; $50 - P_2 = 0$

$$P_2 = 50 \text{ N}$$

$$P_1 = 1.5(50) = 75 \text{ N}$$

$$P = 75 + 50 = 125 \text{ N} \quad \text{Ans}$$

$$F_{AC} = 50 + 75 = 125 \text{ N}$$

$$\sigma_{Ac} = \frac{125}{2(10^{-6})} = 62.5 \text{ MPa}$$

$$62.5 \text{ MPa} < \sigma_Y \quad \text{OK}$$

From *Mechanics of Materials*, Sixth Edition by R. C. Hibbeler, ISBN 0-13-191345-X.

© 2005 R. C. Hibbeler. Published by Pearson Prentice Hall,

Pearson Education, Inc., Upper Saddle River, NJ. All rights reserved.

This material is protected under all copyright laws as they currently exist. No portion of this material may be reproduced, in any form or by any means, without permission in writing from the publisher.

4-101 The distributed loading is applied to the rigid beam, which is supported by the three bars. Each bar has a cross-sectional area of 1.25 in^2 and is made from a material having a stress-strain diagram that can be approximated by the two line segments shown. If a load of $w = 25 \text{ kip/ft}$ is applied to the beam, determine the stress in each bar and the vertical displacement of the beam.

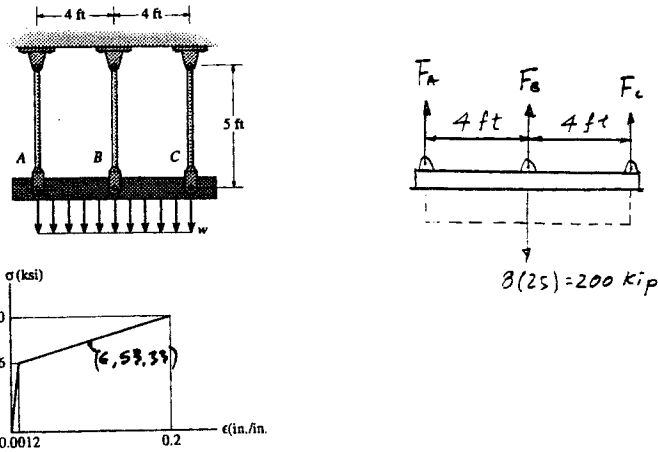

$$(+\Sigma M_B = 0): \quad F_C(4) - F_A(4) = 0;$$

$$F_A = F_C = F$$

$$+\uparrow \Sigma F_y = 0: \quad 2F + F_B - 200 = 0 \quad (1)$$

Since the loading and geometry are symmetrical, the bar will remain horizontal. Therefore, the displacement of the bars is the same and hence, the force in each bar is the same. From Eq. (1).

$$F = F_B = 66.67 \text{ kip}$$

Thus,

$$\sigma_A = \sigma_B = \sigma_C = \frac{66.67}{1.25} = 53.33 \text{ ksi} \quad \text{Ans}$$

From the stress-strain diagram :

$$\frac{53.33 - 36}{\epsilon - 0.0012} = \frac{60 - 36}{0.2 - 0.0012}; \quad \epsilon = 0.14477 \text{ in./in.}$$

$$\delta = \epsilon L = 0.14477(5)(12) = 8.69 \text{ in.} \quad \text{Ans}$$

From *Mechanics of Materials*, Sixth Edition by R. C. Hibbeler, ISBN 0-13-191345-X.

© 2005 R. C. Hibbeler. Published by Pearson Prentice Hall,

Pearson Education, Inc., Upper Saddle River, NJ. All rights reserved.

This material is protected under all copyright laws as they currently exist. No portion of this material may be reproduced, in any form or by any means, without permission in writing from the publisher.

4-102 The distributed loading is applied to the rigid beam, which is supported by the three bars. Each bar has a cross-sectional area of 0.75 in^2 and is made from a material having a stress-strain diagram that can be approximated by the two line segments shown. Determine the intensity of the distributed loading w needed to cause the beam to be displaced downward 1.5 in.

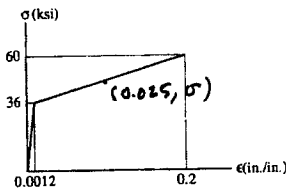
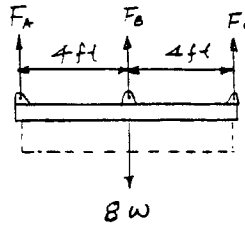
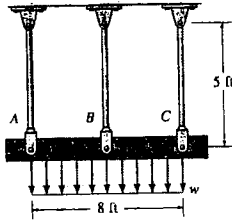

$$\begin{aligned} \uparrow + \Sigma M_B = 0; \quad F_C(4) - F_A(4) = 0; \quad F_A = F_C = F \\ + \uparrow \Sigma F_y = 0; \quad 2F + F_B - 8w = 0 \end{aligned} \quad (1)$$

Since the system and the loading are symmetrical, the bar will remain horizontal. Hence the displacement of the bars is the same and the force supported by each bar is the same.

From Eq. (1),
 $F_B = F = 2.6667 w$ (2)

From the stress-strain diagram :

$$\epsilon = \frac{1.5}{5(12)} = 0.025 \text{ in./in.}$$

$$\frac{\sigma - 36}{0.025 - 0.0012} = \frac{60 - 36}{0.2 - 0.0012}; \quad \sigma = 38.87 \text{ ksi}$$

Hence $F = \sigma A = 38.87(0.75) = 29.15 \text{ kip}$

From Eq.(2), $w = 10.9 \text{ kip/ft}$ **Ans**

From *Mechanics of Materials*, Sixth Edition by R. C. Hibbeler, ISBN 0-13-191345-X.
 © 2005 R. C. Hibbeler. Published by Pearson Prentice Hall,
 Pearson Education, Inc., Upper Saddle River, NJ. All rights reserved.
 This material is protected under all copyright laws as they currently exist. No portion of this material may be reproduced, in any form or by any means, without permission in writing from the publisher.

4-103. The rigid beam is supported by the three posts *A*, *B*, and *C* of equal length. Posts *A* and *C* have a diameter of 75 mm and are made of aluminum, for which $E_{al} = 70$ GPa and $(\sigma_Y)_{al} = 20$ MPa. Post *B* has a diameter of 20 mm and is made of brass, for which $E_{br} = 100$ GPa and $(\sigma_Y)_{br} = 590$ MPa. Determine the smallest magnitude of *P* so that (a) only rods *A* and *C* yield and (b) all the posts yield.

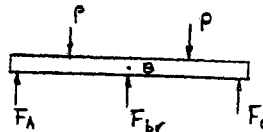
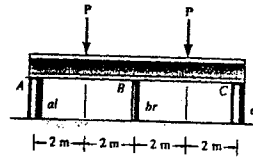

$$\Sigma M_B = 0; \quad F_A = F_C = F_{al}$$

$$+\uparrow \Sigma F_y = 0; \quad F_{br} + 2F_{al} - 2P = 0 \quad (1)$$

(a) Post *A* and *C* will yield,

$$\begin{aligned} F_{al} &= (\sigma_Y)_{al} A \\ &= 20(10^6) \left(\frac{\pi}{4}\right) (0.075)^2 \\ &= 88.36 \text{ kN} \end{aligned}$$

$$(\epsilon_{al})_Y = \frac{(\sigma_Y)_{al}}{E_{al}} = \frac{20(10^6)}{70(10^9)} = 0.0002857$$

Compatibility condition :

$$\begin{aligned} \delta_{br} &= \delta_{al} \\ &= 0.0002857(L) \end{aligned}$$

$$\frac{F_{br}(L)}{\frac{\pi}{4}(0.02)^2(100)(10^9)} = 0.0002857 L$$

$$F_{br} = 8.976 \text{ kN}$$

$$\sigma_{br} = \frac{8.976(10^3)}{\frac{\pi}{4}(0.02)^2} = 28.6 \text{ MPa} < \sigma_Y \quad \text{OK}$$

From Eq. (1),

$$\begin{aligned} 8.976 + 2(88.36) - 2P &= 0 \\ P &= 92.8 \text{ kN} \quad \text{Ans} \end{aligned}$$

(b) All the posts yield :

$$\begin{aligned} F_{br} &= (\sigma_Y)_{br} A \\ &= (590)(10^6) \left(\frac{\pi}{4}\right) (0.02)^2 \\ &= 185.35 \text{ kN} \end{aligned}$$

$$F_{al} = 88.36 \text{ kN}$$

$$\begin{aligned} \text{From Eq. (1):} \quad 185.35 + 2(88.36) - 2P &= 0 \\ P &= 181 \text{ kN} \quad \text{Ans} \end{aligned}$$

From *Mechanics of Materials*, Sixth Edition by R. C. Hibbeler, ISBN 0-13-191345-X.

© 2005 R. C. Hibbeler. Published by Pearson Prentice Hall,

Pearson Education, Inc., Upper Saddle River, NJ. All rights reserved.

This material is protected under all copyright laws as they currently exist. No portion of this material may be reproduced, in any form or by any means, without permission in writing from the publisher.

***4-104** The rigid beam is supported by the three posts *A*, *B*, and *C*. Posts *A* and *C* have a diameter of 60 mm and are made of aluminum, for which $E_{al} = 70$ GPa and $(\sigma_Y)_{al} = 20$ MPa. Post *B* is made of brass, for which $E_{br} = 100$ GPa and $(\sigma_Y)_{br} = 590$ MPa. If $P = 130$ kN, determine the largest diameter of post *B* so that all the posts yield at the same time.

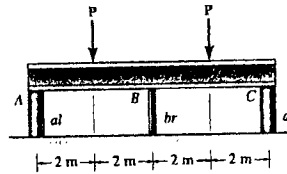

$$+\uparrow \Sigma F_y = 0; \quad 2(F_Y)_{al} + F_{br} - 260 = 0 \quad (1)$$

$$\begin{aligned} (F_{al})_Y &= (\sigma_Y)_{al} A \\ &= 20(10^6) \left(\frac{\pi}{4}\right) (0.06)^2 = 56.55 \text{ kN} \end{aligned}$$

From Eq. (1),

$$\begin{aligned} 2(56.55) + F_{br} - 260 &= 0 \\ F_{br} &= 146.9 \text{ kN} \end{aligned}$$

$$(\sigma_Y)_{br} = 590(10^6) = \frac{146.9(10^3)}{\frac{\pi}{4}(d_B)^2}$$

$$d_B = 0.01779 \text{ m} = 17.8 \text{ mm} \quad \text{Ans}$$

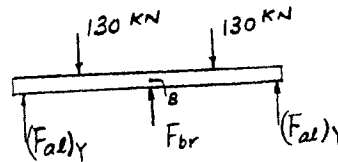

From *Mechanics of Materials*, Sixth Edition by R. C. Hibbeler, ISBN 0-13-191345-X.

© 2005 R. C. Hibbeler. Published by Pearson Prentice Hall,

Pearson Education, Inc., Upper Saddle River, NJ. All rights reserved.

This material is protected under all copyright laws as they currently exist. No portion of this material may be reproduced, in any form or by any means, without permission in writing from the publisher.

4-105 The three bars are pinned together and subjected to the load P . If each bar has a cross-sectional area A , length L , and is made from an elastic perfectly plastic material, for which the yield stress is σ_Y , determine the largest load (ultimate load) that can be supported by the bars, i.e., the load P that causes all the bars to yield. Also, what is the horizontal displacement of point A when the load reaches its ultimate value? The modulus of elasticity is E .

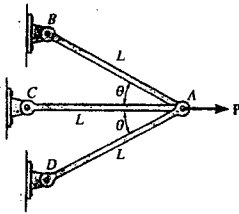

When all bars yield, the force in each bar is,
 $F_Y = \sigma_Y A$

$$\rightarrow \sum F_x = 0; \quad P - 2\sigma_Y A \cos \theta - \sigma_Y A = 0$$

$$P = \sigma_Y A(2 \cos \theta + 1) \quad \text{Ans}$$

Bar AC will yield first followed by bars AB and AD.

$$\delta_{AB} = \delta_{AD} = \frac{F_Y(L)}{AE} = \frac{\sigma_Y AL}{AE} = \frac{\sigma_Y L}{E}$$

$$\delta_A = \frac{\delta_{AB}}{\cos \theta} = \frac{\sigma_Y L}{E \cos \theta} \quad \text{Ans}$$

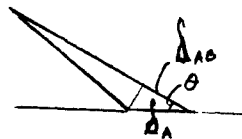
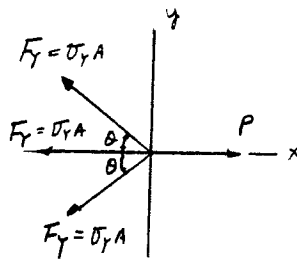

From *Mechanics of Materials*, Sixth Edition by R. C. Hibbeler, ISBN 0-13-191345-X.

© 2005 R. C. Hibbeler. Published by Pearson Prentice Hall,

Pearson Education, Inc., Upper Saddle River, NJ. All rights reserved.

This material is protected under all copyright laws as they currently exist. No portion of this material may be reproduced, in any form or by any means, without permission in writing from the publisher.

4-106. A material has a stress-strain diagram that can be described by the curve $\sigma = c\epsilon^{1/2}$. Determine the deflection δ of the end of a rod made from this material if it has a length L , cross-sectional area A , and a specific weight γ .

$$\sigma = c\epsilon^{1/2}; \quad \sigma^2 = c^2\epsilon$$

$$\sigma^2(x) = c^2\epsilon(x) \quad (1)$$

$$\text{However } \sigma(x) = \frac{P(x)}{A}; \quad \epsilon(x) = \frac{d\delta}{dx}$$

From Eq. (1),

$$\frac{P^2(x)}{A^2} = c^2 \frac{d\delta}{dx}; \quad \frac{d\delta}{dx} = \frac{P^2(x)}{A^2 c^2}$$

$$\delta = \frac{1}{A^2 c^2} \int P^2(x) dx = \frac{1}{A^2 c^2} \int_0^L (\gamma Ax)^2 dx$$

$$= \frac{\gamma^2}{c^2} \int_0^L x^2 dx = \frac{\gamma^2}{c^2} \left. \frac{x^3}{3} \right|_0^L$$

$$\delta = \frac{\gamma^2 L^3}{3c^2} \quad \text{Ans}$$

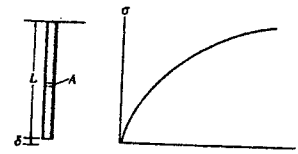
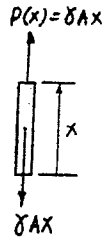

From *Mechanics of Materials*, Sixth Edition by R. C. Hibbeler, ISBN 0-13-191345-X.

© 2005 R. C. Hibbeler. Published by Pearson Prentice Hall,

Pearson Education, Inc., Upper Saddle River, NJ. All rights reserved.

This material is protected under all copyright laws as they currently exist. No portion of this material may be reproduced, in any form or by any means, without permission in writing from the publisher.

4-107 Solve Prob. 4-106 if the stress-strain diagram is defined by $\sigma = c\epsilon^{3/2}$.

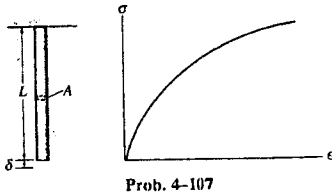

$$\sigma = c\epsilon^{3/2}; \quad \epsilon = \frac{\sigma^{2/3}}{c^{2/3}} \quad (1)$$

$$\text{However } \sigma(x) = \frac{P(x)}{A}; \quad \epsilon(x) = \frac{d\delta}{dx}$$

From Eq. (1),

$$\frac{d\delta}{dx} = \frac{1}{c^{2/3}} \frac{P^{2/3}}{A^{2/3}}$$

$$\delta = \frac{1}{c^{2/3} A^{2/3}} \int P^{2/3} dx = \frac{1}{(cA)^{2/3}} \int_0^L (\gamma Ax)^{2/3} dx$$

$$= \frac{1}{(cA)^{2/3}} (\gamma A)^{2/3} \int_0^L x^{2/3} dx = \left(\frac{\gamma}{c}\right)^{2/3} \left(\frac{3}{5}\right) x^{5/3} \Big|_0^L$$

$$\delta = \frac{3}{5} \left(\frac{\gamma}{c}\right)^{2/3} L^{5/3} \quad \text{Ans}$$

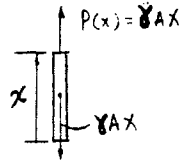

From *Mechanics of Materials*, Sixth Edition by R. C. Hibbeler, ISBN 0-13-191345-X.
 © 2005 R. C. Hibbeler. Published by Pearson Prentice Hall,
 Pearson Education, Inc., Upper Saddle River, NJ. All rights reserved.
 This material is protected under all copyright laws as they currently exist. No portion of this material may be reproduced, in any form or by any means, without permission in writing from the publisher.

*4-108 The bar having a diameter of 2 in. is fixed connected at its ends and supports the axial load P . If the material is elastic perfectly plastic as shown by the stress-strain diagram, determine the smallest load P needed to cause both segments AC and CB to yield. If this load is released, determine the permanent displacement of point C .

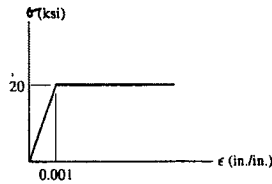
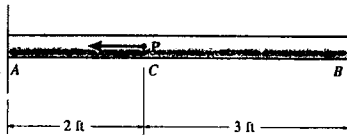

When P is increased, region AC will become plastic first, then CB will become plastic. Thus,

$$F_A = F_B = \sigma A = 20(\pi)(1)^2 = 62.832 \text{ kip}$$

$$\rightarrow \Sigma F_x = 0; \quad F_A + F_B - P = 0 \quad (1)$$

$$P = 2(62.832) = 125.66 \text{ kip}$$

$$P = 126 \text{ kip} \quad \text{Ans}$$

The deflection of point C is,

$$\delta_C = \epsilon L = (0.001)(3)(12) = 0.036 \text{ in.} \leftarrow$$

Consider the reverse of P on the bar.

$$\frac{F_A'(2)}{AE} = \frac{F_B'(3)}{AE}$$

$$F_A' = 1.5 F_B'$$

So that from Eq. (1)

$$F_B' = 0.4P$$

$$F_A' = 0.6P$$

$$\delta_C' = \frac{F_B' L}{AE} = \frac{0.4(P)(3)(12)}{AE} = \frac{0.4(125.66)(3)(12)}{\pi(1)^2(20/0.001)} = 0.02880 \text{ in.} \rightarrow$$

$$\Delta \delta = 0.036 - 0.0288 = 0.00720 \text{ in.} \leftarrow \quad \text{Ans}$$

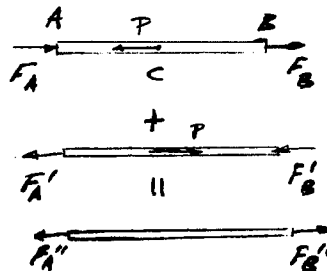

From *Mechanics of Materials*, Sixth Edition by R. C. Hibbeler, ISBN 0-13-191345-X.

© 2005 R. C. Hibbeler. Published by Pearson Prentice Hall,

Pearson Education, Inc., Upper Saddle River, NJ. All rights reserved.

This material is protected under all copyright laws as they currently exist. No portion of this material may be reproduced, in any form or by any means, without permission in writing from the publisher.

4-109 Determine the elongation of the bar in Prob. 4-108 when both the load P and the supports are removed.

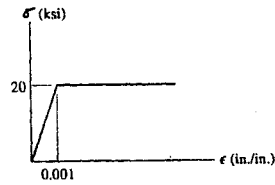
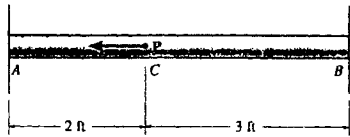

When P is increased, region AC will become plastic first, then CB will become plastic. Thus,

$$F_A = F_B = \sigma A = 20(\pi)(1)^2 = 62.832 \text{ kip}$$

$$\begin{aligned} \rightarrow \Sigma F_x = 0; \quad F_A + F_B - P &= 0 \quad (1) \\ P = 2(62.832) &= 125.66 \text{ kip} \\ P &= 126 \text{ kip} \quad \text{Ans} \end{aligned}$$

The deflection of point C is,

$$\delta_C = \epsilon L = (0.001)(3)(12) = 0.036 \text{ in.} \leftarrow$$

Consider the reverse of P on the bar.

$$\frac{F_A'(2)}{AE} = \frac{F_B'(3)}{AE}$$

$$F_A' = 1.5 F_B'$$

So that from Eq. (1)

$$F_B' = 0.4P$$

$$F_A' = 0.6P$$

The resultant reactions are

$$F_A'' = F_B'' = -62.832 + 0.4(125.66) = 62.832 - 0.4(125.66) = 12.568 \text{ kip}$$

When the supports are removed the elongation will be,

$$\delta = \frac{PL}{AE} = \frac{12.568(5)(12)}{\pi(1)^2(20/0.001)} = 0.0120 \text{ in.} \quad \text{Ans}$$

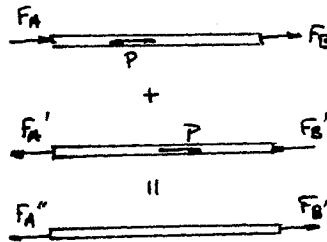

From *Mechanics of Materials*, Sixth Edition by R. C. Hibbeler, ISBN 0-13-191345-X.

© 2005 R. C. Hibbeler. Published by Pearson Prentice Hall,

Pearson Education, Inc., Upper Saddle River, NJ. All rights reserved.

This material is protected under all copyright laws as they currently exist. No portion of this material may be reproduced, in any form or by any means, without permission in writing from the publisher.

4-110. A 0.25-in.-diameter steel rivet having a temperature of 1500°F is secured between two plates such that at this temperature it is 2 in. long and exerts a clamping force of 250 lb between the plates. Determine the approximate clamping force between the plates when the rivet cools to 70°F. For the calculation, assume that the heads of the rivet and the plates are rigid. Take $\alpha_{st} = 8(10^{-6})/^\circ F$, $E_{st} = 29(10^3)$ ksi. Is the result a conservative estimate of the actual answer? Why or why not?

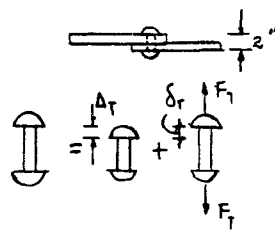

By superposition;

$$(+ \downarrow) \quad 0 = \Delta_T - \delta_T$$

$$0 = 8(10^{-6})(1500 - 70)(2) - \frac{F_T(2)}{\frac{\pi}{4}(0.25^2)(29)(10^3)}$$

$$F_T = 16.285 \text{ kip}$$

$$F = 0.25 + 16.285 = 16.5 \text{ kip} \quad \text{Ans}$$

Yes, because as the rivet cools, the plates and rivet head will also deform. Consequently, the force F_T on the rivet will not be as great.

From *Mechanics of Materials*, Sixth Edition by R. C. Hibbeler, ISBN 0-13-191345-X.

© 2005 R. C. Hibbeler. Published by Pearson Prentice Hall,

Pearson Education, Inc., Upper Saddle River, NJ. All rights reserved.

This material is protected under all copyright laws as they currently exist. No portion of this material may be reproduced, in any form or by any means, without permission in writing from the publisher.

4-111 Determine the maximum axial force P that can be applied to the steel plate. The allowable stress is $\sigma_{\text{allow}} = 21$ ksi.

Assume failure at fillet

$$\frac{r}{h} = \frac{0.25}{2.5} = 0.1; \quad \frac{w}{h} = \frac{5}{2.5} = 2$$

From Fig. 4-23, $K = 2.4$

$$\sigma_{\text{allow}} = \sigma_{\text{max}} = K\sigma_{\text{avg}}$$

$$21 = 2.4 \left[\frac{P}{2.5(0.25)} \right]; \quad P = 5.47 \text{ kip}$$

Assume failure at hole

$$\frac{r}{w} = \frac{0.5}{5} = 0.1; \quad \text{From Fig. 4-24, } K = 2.65$$

$$\sigma_{\text{allow}} = \sigma_{\text{max}} = K\sigma_{\text{avg}}$$

$$21 = 2.65 \left[\frac{P}{(5 - 1)(0.25)} \right]$$

$$P = 7.92 \text{ kip}$$

$$P = 5.47 \text{ kip (controls)} \quad \mathbf{Ans}$$

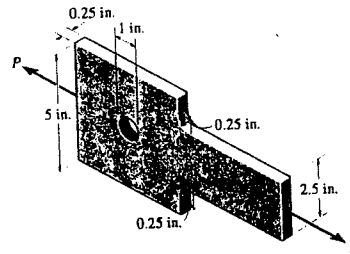

From *Mechanics of Materials*, Sixth Edition by R. C. Hibbeler, ISBN 0-13-191345-X.

© 2005 R. C. Hibbeler. Published by Pearson Prentice Hall,

Pearson Education, Inc., Upper Saddle River, NJ. All rights reserved.

This material is protected under all copyright laws as they currently exist. No portion of this material may be reproduced, in any form or by any means, without permission in writing from the publisher.

*4-112 Two A-36 steel pipes, each having a cross-sectional area of 0.32 in^2 , are screwed together using a union at B as shown. Originally the assembly is adjusted so that no load is on the pipe. If the union is then tightened so that its screw, having a lead of 0.15 in. , undergoes two full turns, determine the average normal stress developed in the pipe. Assume that the union at B and couplings at A and C are rigid. Neglect the size of the union. *Note:* The lead would cause the pipe, when *unloaded*, to shorten 0.15 in. when the union is rotated one revolution.

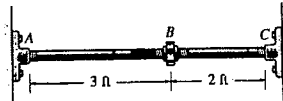

The loads acting on both segments AB and BC are the same since no external load acts on the system.

$$0.3 = \delta_{B/A} + \delta_{B/C}$$

$$0.3 = \frac{P(3)(12)}{0.32(29)(10^3)} + \frac{P(2)(12)}{0.32(29)(10^3)}$$

$$P = 46.4 \text{ kip}$$

$$\sigma_{AB} = \sigma_{BC} = \frac{P}{A} = \frac{46.4}{0.32} = 145 \text{ ksi} \quad \text{Ans}$$

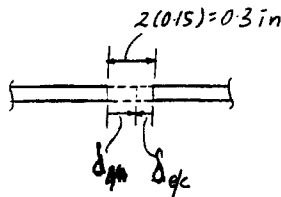

From *Mechanics of Materials*, Sixth Edition by R. C. Hibbeler, ISBN 0-13-191345-X.

© 2005 R. C. Hibbeler. Published by Pearson Prentice Hall,

Pearson Education, Inc., Upper Saddle River, NJ. All rights reserved.

This material is protected under all copyright laws as they currently exist. No portion of this material may be reproduced, in any form or by any means, without permission in writing from the publisher.

4-113 The force P is applied to the bar, which is composed of an elastic perfectly plastic material. Construct a graph to show how the force in each section AB and BC (ordinate) varies as P (abscissa) is increased. The bar has cross-sectional areas of 1 in^2 in region AB and 4 in^2 in region BC , and $\sigma_Y = 30 \text{ ksi}$.

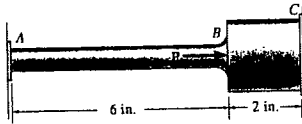

$$\rightarrow \sum F_x = 0: \quad P - F_{AB} - F_{BC} = 0 \quad (1)$$

$$\text{Elastic behavior: } \rightarrow 0 = \Delta_C - \delta_C;$$

$$0 = \frac{P(6)}{(1)E} - \left[\frac{F_{BC}(2)}{(4)E} + \frac{F_{BC}(6)}{(1)E} \right]$$

$$F_{BC} = 0.9231 P \quad (2)$$

Substituting Eq. (2) into (1):

$$F_{AB} = 0.07692 P \quad (3)$$

By comparison, segment BC will yield first. Hence,

$$(F_{BC})_Y = \sigma_Y A = 30(4) = 120 \text{ kip}$$

From Eq. (1) and (3) using $F_{BC} = (F_{BC})_Y = 120 \text{ kip}$

$$P = 130 \text{ kip}; \quad F_{AB} = 10 \text{ kip}$$

When segment AB yields,

$$(F_{AB})_Y = \sigma_Y A = 30(1) = 30 \text{ kip}; \quad (F_{BC})_Y = 120 \text{ kip}$$

From Eq. (1),

$$P = 150 \text{ kip}$$

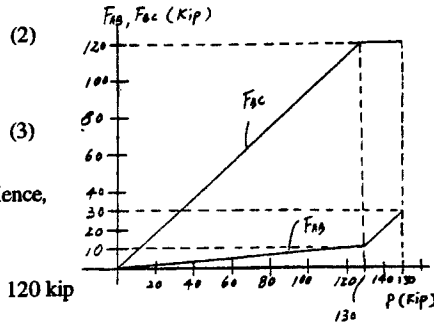
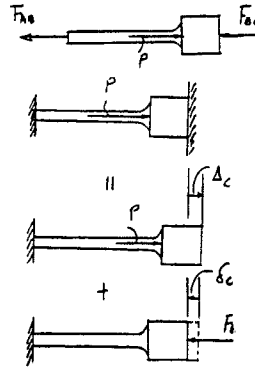

From *Mechanics of Materials*, Sixth Edition by R. C. Hibbeler, ISBN 0-13-191345-X.

© 2005 R. C. Hibbeler. Published by Pearson Prentice Hall,

Pearson Education, Inc., Upper Saddle River, NJ. All rights reserved.

This material is protected under all copyright laws as they currently exist. No portion of this material may be reproduced, in any form or by any means, without permission in writing from the publisher.

4-114 The 2014-T6 aluminum rod has a diameter of 0.5 in. and is lightly attached to the rigid supports at A and B when $T_1 = 70^\circ\text{F}$. If the temperature becomes $T_2 = -10^\circ\text{F}$, and an axial force of $P = 16$ lb is applied to the rigid collar as shown, determine the reactions at A and B .

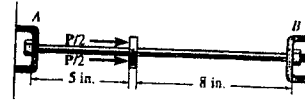

$$\rightarrow 0 = \Delta_B - \Delta_T + \delta_B$$

$$0 = \frac{0.016(5)}{\frac{\pi}{4}(0.5^2)(10.6)(10^3)} - 12.8(10^{-6})[70^\circ - (-10^\circ)](13) + \frac{F_B(13)}{\frac{\pi}{4}(0.5^2)(10.6)(10^3)}$$

$$F_B = 2.1251 \text{ kip} = 2.13 \text{ kip} \quad \text{Ans}$$

$$\rightarrow \Sigma F_x = 0; \quad 2(0.008) + 2.1251 - F_A = 0$$

$$F_A = 2.14 \text{ kip} \quad \text{Ans}$$

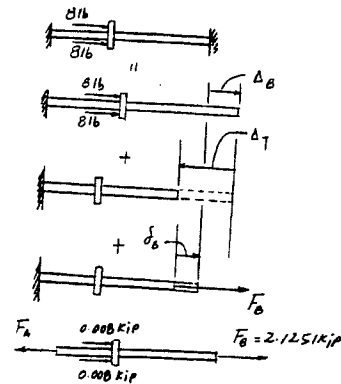

From *Mechanics of Materials*, Sixth Edition by R. C. Hibbeler, ISBN 0-13-191345-X.

© 2005 R. C. Hibbeler. Published by Pearson Prentice Hall,

Pearson Education, Inc., Upper Saddle River, NJ. All rights reserved.

This material is protected under all copyright laws as they currently exist. No portion of this material may be reproduced, in any form or by any means, without permission in writing from the publisher.

4-115 The 2014-T6 aluminum rod has a diameter of 0.5 in. and is lightly attached to the rigid supports at *A* and *B* when $T_1 = 70^\circ\text{F}$. Determine the force *P* that must be applied to the collar so that, when $T = 0^\circ\text{F}$, the reaction at *B* is zero.

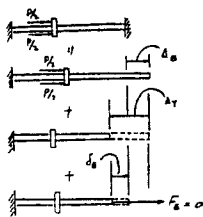
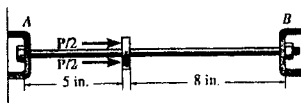

$$\rightarrow 0 = \Delta_B - \Delta_T + \delta_B$$

$$0 = \frac{P(5)}{\frac{\pi}{4}(0.5^2)(10.6)(10^3)} - 12.8(10^{-6})[(70)(13)] + 0$$

$$P = 4.85 \text{ kip} \quad \text{Ans}$$

From *Mechanics of Materials*, Sixth Edition by R. C. Hibbeler, ISBN 0-13-191345-X.

© 2005 R. C. Hibbeler. Published by Pearson Prentice Hall,

Pearson Education, Inc., Upper Saddle River, NJ. All rights reserved.

This material is protected under all copyright laws as they currently exist. No portion of this material may be reproduced, in any form or by any means, without permission in writing from the publisher.

***4-116** The steel bolt has a diameter of 7 mm and fits through an aluminum sleeve as shown. The sleeve has an inner diameter of 8 mm and an outer diameter of 10 mm. The nut at *A* is adjusted so that it just presses up against the sleeve. If it is then tightened one-half turn, determine the force in the bolt and the sleeve. The single-threaded screw on the bolt has a lead of 1.5 mm. $E_{st} = 200$ GPa, $E_{al} = 70$ GPa. *Note:* The lead represents the distance the nut advances along the bolt for one complete turn of the nut.

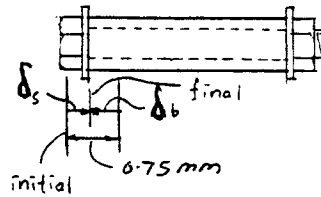
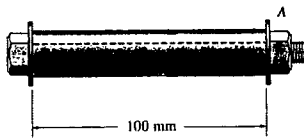

$$0.75 = \delta_s + \delta_b$$

$$0.75 = \frac{F(100)}{\frac{\pi}{4}(0.01^2 - 0.008^2)(70)(10^9)} + \frac{F(100)}{\frac{\pi}{4}(0.007^2)(200)(10^9)}$$

$$F = 11808 \text{ N} = 11.8 \text{ kN} \quad \mathbf{Ans}$$

From *Mechanics of Materials*, Sixth Edition by R. C. Hibbeler, ISBN 0-13-191345-X.

© 2005 R. C. Hibbeler. Published by Pearson Prentice Hall,

Pearson Education, Inc., Upper Saddle River, NJ. All rights reserved.

This material is protected under all copyright laws as they currently exist. No portion of this material may be reproduced, in any form or by any means, without permission in writing from the publisher.

4-117 The steel bolt has a diameter of 7 mm and fits through an aluminum sleeve as shown. The sleeve has an inner diameter of 8 mm and an outer diameter of 10 mm. The nut at A is adjusted so that it just presses up against the sleeve. Determine the amount of turn the nut at A is to be tightened so that the force in the bolt and sleeve will be 12 kN. The single-threaded screw on the bolt has a lead of 1.5 mm. $E_{st} = 200$ GPa, $E_{al} = 70$ GPa. Note: The lead represents the distance the nut advances along the bolt for one complete turn of the nut.

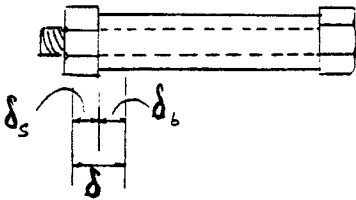
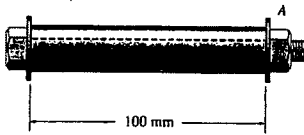

Since no external load was applied, the force acting on the sleeve must be equal to that acting on bolt i.e. 12 kN.

$$\delta = \delta_s + \delta_b$$

$$= \frac{12(10^3)(100)}{\frac{\pi}{4}(0.01^2 - 0.008^2)(70)(10^9)} + \frac{12(10^3)(100)}{\frac{\pi}{4}(0.007^2)(200)(10^9)}$$

$$= 0.7622 \text{ mm}$$

$$\text{The number of turns} = \frac{0.7622}{1.5} = 0.508 \text{ of a turn} \quad \text{Ans}$$

From *Mechanics of Materials*, Sixth Edition by R. C. Hibbeler, ISBN 0-13-191345-X.

© 2005 R. C. Hibbeler. Published by Pearson Prentice Hall,

Pearson Education, Inc., Upper Saddle River, NJ. All rights reserved.

This material is protected under all copyright laws as they currently exist. No portion of this material may be reproduced, in any form or by any means, without permission in writing from the publisher.

4-118 The assembly consists of two A-36 steel suspender rods AC and BD attached to the 100-lb uniform rigid beam AB . Determine the position x for the 300-lb loading so that the beam remains in a horizontal position both before and after the load is applied. Each rod has a diameter of 0.5 in.

$$+\Sigma M_A = 0; \quad F_{BD}(30) - 300x - 100(15) = 0$$

$$F_{BD} = 10x + 50 \quad (1)$$

$$+\Sigma M_B = 0; \quad -F_{AC}(30) + 300(30-x) + 100(15) = 0$$

$$F_{AC} = 350 - 10x \quad (2)$$

$$\delta_A = \delta_B$$

From Eq. (1) and (2),

$$\frac{(350 - 10x)(15)}{AE} = \frac{(10x + 50)(25)}{AE}$$

$$5250 - 150x = 250x + 1250$$

$$x = 10 \text{ in.} \quad \text{Ans}$$

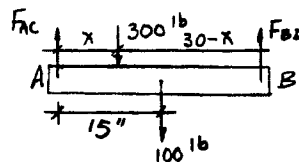
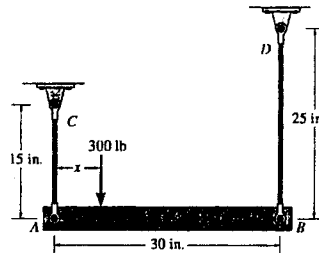

From *Mechanics of Materials*, Sixth Edition by R. C. Hibbeler, ISBN 0-13-191345-X.
 © 2005 R. C. Hibbeler. Published by Pearson Prentice Hall,
 Pearson Education, Inc., Upper Saddle River, NJ. All rights reserved.
 This material is protected under all copyright laws as they currently exist. No portion of this material may be reproduced, in any form or by any means, without permission in writing from the publisher.

4-119 The joint is made from three A-36 steel plates that are bonded together at their seams. Determine the displacement of end *A* with respect to end *B* when the joint is subjected to the axial loads shown. Each plate has a thickness of 5 mm.

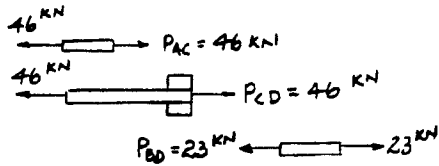
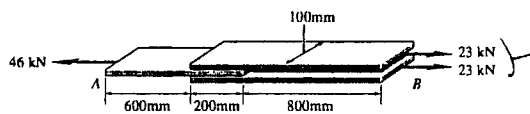

$$\delta_{A/B} = \sum \frac{PL}{AE} = \frac{46(10^3)(600)}{(0.005)(0.1)(200)(10^9)} + \frac{46(10^3)(200)}{3(0.005)(0.1)(200)(10^9)} + \frac{23(10^3)(800)}{(0.005)(0.1)(200)(10^9)}$$

$$= 0.491 \text{ mm} \quad \text{Ans}$$

From *Mechanics of Materials*, Sixth Edition by R. C. Hibbeler, ISBN 0-13-191345-X.

© 2005 R. C. Hibbeler. Published by Pearson Prentice Hall,

Pearson Education, Inc., Upper Saddle River, NJ. All rights reserved.

This material is protected under all copyright laws as they currently exist. No portion of this material may be reproduced, in any form or by any means, without permission in writing from the publisher.

5-1 The tube is subjected to a torque of 600 N·m. Determine the amount of this torque that is resisted by the shaded section. Solve the problem two ways: (a) by using the torsion formula; (b) by finding the resultant of the shear-stress distribution.

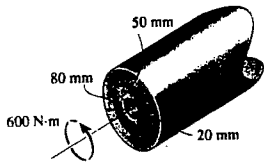

a)

$$\tau_{\max} = \frac{Tc}{J} = \frac{600(0.08)}{\frac{\pi}{2}(0.08^4 - 0.02^4)} = 748964 \text{ Pa}$$

$$\tau_{\max} = \frac{T'c}{J}$$

$$748964 = \frac{T'(0.08)}{\frac{\pi}{2}(0.08^4 - 0.02^4)}$$

$$T' = 510 \text{ N} \cdot \text{m} \quad \text{Ans}$$

b)

$$\tau = \tau_{\max} \left(\frac{\rho}{c} \right) \quad dA = 2\pi \rho d\rho$$

$$dT' = \rho \tau dA = \rho \tau_{\max} \left(\frac{\rho}{c} \right) 2\pi \rho d\rho$$

$$T' = \frac{2\pi \tau_{\max}}{c} \int \rho^3 d\rho = \frac{2\pi (748964)}{0.08} \frac{\rho^4}{4} \Big|_{0.02}^{0.08}$$

$$= 510 \text{ N} \cdot \text{m} \quad \text{Ans}$$

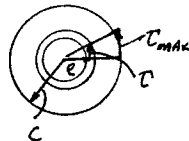

From *Mechanics of Materials*, Sixth Edition by R. C. Hibbeler, ISBN 0-13-191345-X.

© 2005 R. C. Hibbeler. Published by Pearson Prentice Hall,

Pearson Education, Inc., Upper Saddle River, NJ. All rights reserved.

This material is protected under all copyright laws as they currently exist. No portion of this material may be reproduced, in any form or by any means, without permission in writing from the publisher.

5-2 The solid shaft of radius r is subjected to a torque T . Determine the radius r' of the inner core of the shaft that resists one-half of the applied torque ($T/2$). Solve the problem two ways: (a) by using the torsion formula, (b) by finding the resultant of the shear-stress distribution.

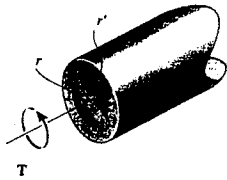

$$a) \tau_{\max} = \frac{Tc}{J} = \frac{Tr}{\frac{\pi}{2}r^4} = \frac{2T}{\pi r^3}$$

$$\tau = \frac{(\frac{T}{2})r'}{\frac{\pi}{2}(r')^4} = \frac{T}{\pi(r')^3}$$

$$\text{Since } \tau = \frac{r'}{r} \tau_{\max}; \quad \frac{T}{\pi(r')^3} = \frac{r'}{r} \left(\frac{2T}{\pi r^3} \right)$$

$$r' = \frac{r}{2^{\frac{1}{3}}} = 0.841 r \quad \text{Ans}$$

$$b) \int_0^{\frac{T}{2}} dT = 2\pi \int_0^{r'} \tau \rho^2 d\rho$$

$$\int_0^{\frac{T}{2}} dT = 2\pi \int_0^{r'} \frac{\rho}{r} \tau_{\max} \rho^2 d\rho$$

$$\int_0^{\frac{T}{2}} dT = 2\pi \int_0^{r'} \frac{\rho}{r} \left(\frac{2T}{\pi r^3} \right) \rho^2 d\rho$$

$$\frac{T}{2} = \frac{4T}{r^4} \int_0^{r'} \rho^3 d\rho$$

$$r' = \frac{r}{2^{\frac{1}{3}}} = 0.841 r \quad \text{Ans}$$

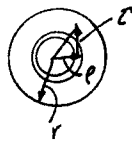

From *Mechanics of Materials*, Sixth Edition by R. C. Hibbeler, ISBN 0-13-191345-X.

© 2005 R. C. Hibbeler. Published by Pearson Prentice Hall,

Pearson Education, Inc., Upper Saddle River, NJ. All rights reserved.

This material is protected under all copyright laws as they currently exist. No portion of this material may be reproduced, in any form or by any means, without permission in writing from the publisher.

5-3. The solid shaft of radius r is subjected to a torque T . Determine the radius r' of the inner core of the shaft that resists one-quarter of the applied torque ($T/4$). Solve the problem two ways: (a) by using the torsion formula, (b) by finding the resultant of the shear-stress distribution.

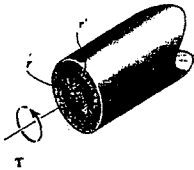

$$a) \tau_{\max} = \frac{Tc}{J} = \frac{T(r)}{\frac{\pi}{2}(r^4)} = \frac{2T}{\pi r^3}$$

$$\text{Since } \tau = \frac{r'}{r} \tau_{\max} = \frac{2T r'}{\pi r^4}$$

$$\tau = \frac{T c'}{J}; \quad \frac{2 T r'}{\pi r^4} = \frac{(\frac{T}{4}) r'}{\frac{\pi}{2}(r')^4}$$

$$r' = \frac{r}{4^{\frac{1}{4}}} = 0.707 r \quad \text{Ans}$$

$$b) \tau = \frac{\rho}{c} \tau_{\max} = \frac{\rho}{r} \left(\frac{2T}{\pi r^3} \right) = \frac{2T}{\pi r^4} \rho; \quad dA = 2\pi \rho d\rho$$

$$dT = \rho \tau dA = \rho \left[\frac{2T}{\pi r^4} \rho \right] (2\pi \rho d\rho) = \frac{4T}{r^4} \rho^3 d\rho$$

$$\int_0^{\frac{T}{4}} dT = \frac{4T}{r^4} \int_0^{r'} \rho^3 d\rho$$

$$\frac{T}{4} = \frac{4T}{r^4} \left. \frac{\rho^4}{4} \right|_0^{r'}; \quad \frac{1}{4} = \frac{(r')^4}{r^4}$$

$$r' = 0.707 r \quad \text{Ans}$$

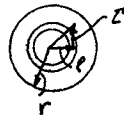

From *Mechanics of Materials*, Sixth Edition by R. C. Hibbeler, ISBN 0-13-191345-X.

© 2005 R. C. Hibbeler. Published by Pearson Prentice Hall,

Pearson Education, Inc., Upper Saddle River, NJ. All rights reserved.

This material is protected under all copyright laws as they currently exist. No portion of this material may be reproduced, in any form or by any means, without permission in writing from the publisher.

*5-4 The copper pipe has an outer diameter of 40 mm and an inner diameter of 37 mm. If it is tightly secured to the wall at A and three torques are applied to it as shown, determine the absolute maximum shear stress developed in the pipe.

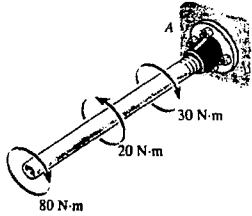

$$\tau_{\max} = \frac{T_{\max} c}{J} = \frac{90(0.02)}{\frac{\pi}{2}(0.02^4 - 0.0185^4)}$$

$$= 26.7 \text{ MPa} \quad \text{Ans}$$

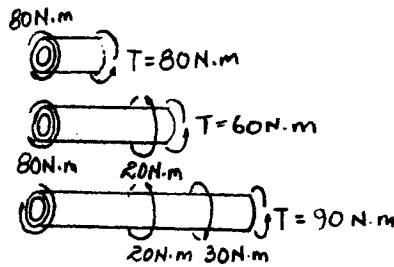

From *Mechanics of Materials*, Sixth Edition by R. C. Hibbeler, ISBN 0-13-191345-X.
 © 2005 R. C. Hibbeler. Published by Pearson Prentice Hall,
 Pearson Education, Inc., Upper Saddle River, NJ. All rights reserved.
 This material is protected under all copyright laws as they currently exist. No portion of this material may be reproduced, in any form or by any means, without permission in writing from the publisher.

5-5 The copper pipe has an outer diameter of 2.50 in. and an inner diameter of 2.30 in. If it is tightly secured to the wall at *C* and three torques are applied to it as shown, determine the shear stress developed at points *A* and *B*. These points lie on the pipe's outer surface. Sketch the shear stress on volume elements located at *A* and *B*.

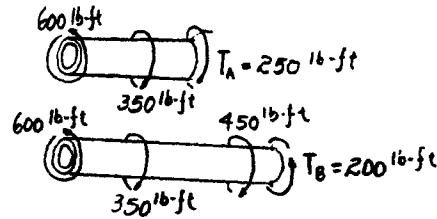
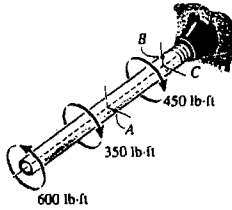

$$\tau_A = \frac{Tc}{J} = \frac{250(12)(1.25)}{\frac{\pi}{2}(1.25^4 - 1.15^4)} = 3.45 \text{ ksi} \quad \text{Ans}$$

$$\tau_B = \frac{Tc}{J} = \frac{200(12)(1.25)}{\frac{\pi}{2}(1.25^4 - 1.15^4)} = 2.76 \text{ ksi} \quad \text{Ans}$$



From *Mechanics of Materials*, Sixth Edition by R. C. Hibbeler, ISBN 0-13-191345-X.

© 2005 R. C. Hibbeler. Published by Pearson Prentice Hall,

Pearson Education, Inc., Upper Saddle River, NJ. All rights reserved.

This material is protected under all copyright laws as they currently exist. No portion of this material may be reproduced, in any form or by any means, without permission in writing from the publisher.

5-6 The solid 1.25-in.-diameter shaft is used to transmit the torques applied to the gears. If it is supported by smooth bearings at *A* and *B*, which do not resist torque, determine the shear stress developed in the shaft at points *C* and *D*. Indicate the shear stress on volume elements located at these points.

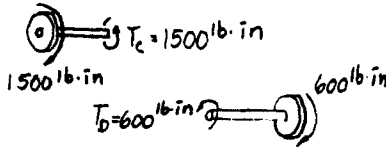
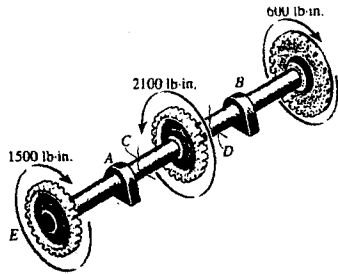

$$\tau_C = \frac{T_C}{J} = \frac{1500(0.625)}{\frac{\pi}{2}(0.625^4)} = 3.91 \text{ ksi} \quad \text{Ans}$$

$$\tau_D = \frac{T_D}{J} = \frac{600(0.625)}{\frac{\pi}{2}(0.625^4)} = 1.56 \text{ ksi} \quad \text{Ans}$$



$$\tau_C = 3.91 \text{ ksi}$$



$$\tau_D = 1.56 \text{ ksi}$$

From *Mechanics of Materials*, Sixth Edition by R. C. Hibbeler, ISBN 0-13-191345-X.

© 2005 R. C. Hibbeler. Published by Pearson Prentice Hall,

Pearson Education, Inc., Upper Saddle River, NJ. All rights reserved.

This material is protected under all copyright laws as they currently exist. No portion of this material may be reproduced, in any form or by any means, without permission in writing from the publisher.

5-7. The shaft has an outer diameter of 1.25 in. and an inner diameter of 1 in. If it is subjected to the applied torques as shown, determine the absolute maximum shear stress developed in the shaft. The smooth bearings at *A* and *B* do not resist torque.

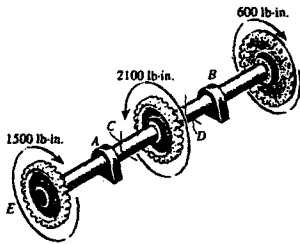

$$T_{\max} = 1500 \text{ lb} \cdot \text{in.}$$

$$\tau_{\max} = \frac{Tc}{J} = \frac{1500(0.625)}{\frac{\pi}{2}[(0.625)^4 - (0.5)^4]} = 6.62 \text{ ksi} \quad \text{Ans}$$

From *Mechanics of Materials*, Sixth Edition by R. C. Hibbeler, ISBN 0-13-191345-X.

© 2005 R. C. Hibbeler. Published by Pearson Prentice Hall,

Pearson Education, Inc., Upper Saddle River, NJ. All rights reserved.

This material is protected under all copyright laws as they currently exist. No portion of this material may be reproduced, in any form or by any means, without permission in writing from the publisher.

***5-8.** The shaft has an outer diameter of 1.25 in. and an inner diameter of 1 in. If it is subjected to the applied torques as shown, plot the shear-stress distribution acting along a radial line lying within region *EA* of the shaft. The smooth bearings at *A* and *B* do not resist torque.

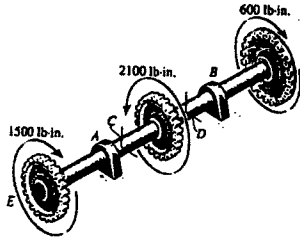

$$T = 1500 \text{ lb} \cdot \text{in.}$$

$$\tau_{\max} = \frac{Tc}{J} = \frac{1500(0.625)}{\frac{\pi}{2}[(0.625)^4 - (0.5)^4]} = 6.62 \text{ ksi}$$

$$\tau_2 = \frac{T\rho}{J} = \frac{1500(0.5)}{\frac{\pi}{2}[(0.625)^4 - (0.5)^4]} = 5.30 \text{ ksi}$$

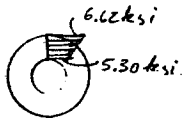

From *Mechanics of Materials*, Sixth Edition by R. C. Hibbeler, ISBN 0-13-191345-X.

© 2005 R. C. Hibbeler. Published by Pearson Prentice Hall,

Pearson Education, Inc., Upper Saddle River, NJ. All rights reserved.

This material is protected under all copyright laws as they currently exist. No portion of this material may be reproduced, in any form or by any means, without permission in writing from the publisher.

5-9 The assembly consists of two sections of galvanized steel pipe connected together using a reducing coupling at *B*. The smaller pipe has an outer diameter of 0.75 in. and an inner diameter of 0.68 in., whereas the larger pipe has an outer diameter of 1 in. and an inner diameter of 0.86 in. If the pipe is tightly secured to the wall at *C*, determine the maximum shear stress developed in each section of the pipe when the couple shown is applied to the handles of the wrench.

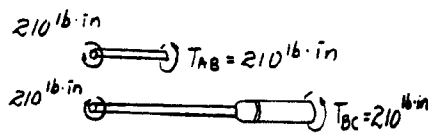
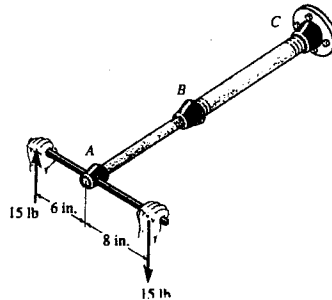

$$\tau_{AB} = \frac{T_c}{J} = \frac{210(0.375)}{\frac{\pi}{2}(0.375^4 - 0.34^4)} = 7.82 \text{ ksi} \quad \text{Ans}$$

$$\tau_{BC} = \frac{T_c}{J} = \frac{210(0.5)}{\frac{\pi}{2}(0.5^4 - 0.43^4)} = 2.36 \text{ ksi} \quad \text{Ans}$$

From *Mechanics of Materials*, Sixth Edition by R. C. Hibbeler, ISBN 0-13-191345-X.

© 2005 R. C. Hibbeler. Published by Pearson Prentice Hall,

Pearson Education, Inc., Upper Saddle River, NJ. All rights reserved.

This material is protected under all copyright laws as they currently exist. No portion of this material may be reproduced, in any form or by any means, without permission in writing from the publisher.

5-10 The link acts as part of the elevator control for a small airplane. If the attached aluminum tube has an inner diameter of 25 mm and a wall thickness of 5 mm, determine the maximum shear stress in the tube when the cable force of 600 N is applied to the cables. Also, sketch the shear-stress distribution over the cross section.

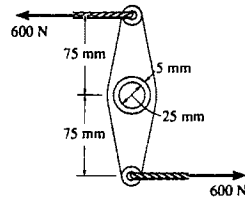

$$T = 600(0.15) = 90 \text{ N} \cdot \text{m}$$

$$\tau_{\max} = \frac{Tc}{J} = \frac{90(0.0175)}{\frac{\pi}{2}[(0.0175)^4 - (0.0125)^4]} = 14.5 \text{ MPa} \quad \text{Ans}$$

$$\tau_i = \frac{T\rho}{J} = \frac{90(0.0125)}{\frac{\pi}{2}[(0.0175)^4 - (0.0125)^4]} = 10.3 \text{ MPa}$$

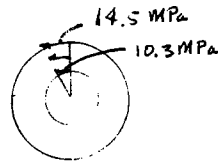

From *Mechanics of Materials*, Sixth Edition by R. C. Hibbeler, ISBN 0-13-191345-X.

© 2005 R. C. Hibbeler. Published by Pearson Prentice Hall,

Pearson Education, Inc., Upper Saddle River, NJ. All rights reserved.

This material is protected under all copyright laws as they currently exist. No portion of this material may be reproduced, in any form or by any means, without permission in writing from the publisher.

5-11 The shaft consists of three concentric tubes, each made from the same material and having the inner and outer radii shown. If a torque of $T = 800 \text{ N} \cdot \text{m}$ is applied to the rigid disk fixed to its end, determine the maximum shear stress in the shaft.

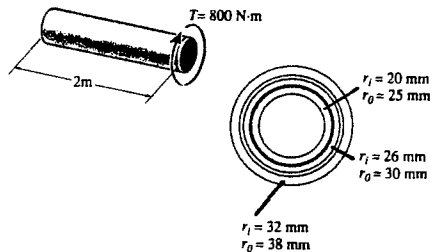

$$J = \frac{\pi}{2}((0.038)^4 - (0.032)^4) + \frac{\pi}{2}((0.030)^4 - (0.026)^4) + \frac{\pi}{2}((0.025)^4 - (0.020)^4)$$

$$J = 2.545(10^{-6})\text{m}^4$$

$$\tau_{\max} = \frac{Tc}{J} = \frac{800(0.038)}{2.545(10^{-6})} = 11.9 \text{ MPa} \quad \text{Ans}$$

From *Mechanics of Materials*, Sixth Edition by R. C. Hibbeler, ISBN 0-13-191345-X.

© 2005 R. C. Hibbeler. Published by Pearson Prentice Hall,

Pearson Education, Inc., Upper Saddle River, NJ. All rights reserved.

This material is protected under all copyright laws as they currently exist. No portion of this material may be reproduced, in any form or by any means, without permission in writing from the publisher.

*5-12 The solid shaft is fixed to the support at C and subjected to the torsional loadings shown. Determine the shear stress at points A and B and sketch the shear stress on volume elements located at these points.

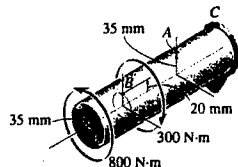

$$\tau_B = \frac{T_B \rho}{J} = \frac{800(0.02)}{\frac{\pi}{2}(0.035^4)} = 6.79 \text{ MPa}$$

Ans

$$\tau_A = \frac{T_A c}{J} = \frac{500(0.035)}{\frac{\pi}{2}(0.035^4)} = 7.42 \text{ MPa}$$

Ans

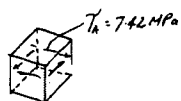
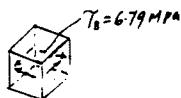
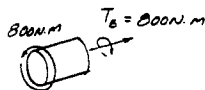

From *Mechanics of Materials*, Sixth Edition by R. C. Hibbeler, ISBN 0-13-191345-X.

© 2005 R. C. Hibbeler. Published by Pearson Prentice Hall,

Pearson Education, Inc., Upper Saddle River, NJ. All rights reserved.

This material is protected under all copyright laws as they currently exist. No portion of this material may be reproduced, in any form or by any means, without permission in writing from the publisher.

5-13. A steel tube having an outer diameter of 2.5 in. is used to transmit 350 hp when turning at 27 rev/min. Determine the inner diameter d of the tube to the nearest $\frac{1}{8}$ in. if the allowable shear stress is $\tau_{\text{allow}} = 10$ ksi.

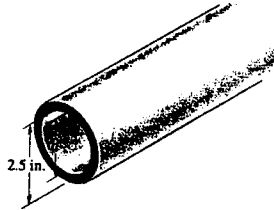

$$\omega = \frac{27(2\pi)}{60} = 2.8274 \text{ rad/s}$$

$$P = T\omega$$

$$350(550) = T(2.8274)$$

$$T = 68\,082.9 \text{ lb}\cdot\text{ft}$$

$$\tau_{\text{max}} = \tau_{\text{allow}} = \frac{Tc}{J}$$

$$10(10^3) = \frac{68\,082.9(12)(1.25)}{\frac{\pi}{2}(1.25^4 - c_i^4)}$$

$$c_i = 1.2416 \text{ in.}$$

$$d = 2.48 \text{ in.}$$

$$\text{Use } d = 2\frac{3}{8} \text{ in.}$$

Ans

From *Mechanics of Materials*, Sixth Edition by R. C. Hibbeler, ISBN 0-13-191345-X.

© 2005 R. C. Hibbeler. Published by Pearson Prentice Hall,

Pearson Education, Inc., Upper Saddle River, NJ. All rights reserved.

This material is protected under all copyright laws as they currently exist. No portion of this material may be reproduced, in any form or by any means, without permission in writing from the publisher.

5-14 The solid shaft has a diameter of 0.75 in. If it is subjected to the torques shown, determine the maximum shear stress developed in regions *BC* and *DE* of the shaft. The bearings at *A* and *F* allow free rotation of the shaft.

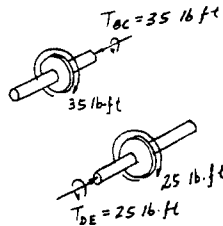
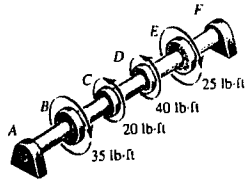

$$(\tau_{BC})_{\max} = \frac{T_{BC} c}{J} = \frac{35(12)(0.375)}{\frac{\pi}{2}(0.375)^4} = 5070 \text{ psi} = 5.07 \text{ ksi} \quad \text{Ans}$$

$$(\tau_{DE})_{\max} = \frac{T_{DE} c}{J} = \frac{25(12)(0.375)}{\frac{\pi}{2}(0.375)^4} = 3621 \text{ psi} = 3.62 \text{ ksi} \quad \text{Ans}$$

From *Mechanics of Materials*, Sixth Edition by R. C. Hibbeler, ISBN 0-13-191345-X.

© 2005 R. C. Hibbeler. Published by Pearson Prentice Hall,

Pearson Education, Inc., Upper Saddle River, NJ. All rights reserved.

This material is protected under all copyright laws as they currently exist. No portion of this material may be reproduced, in any form or by any means, without permission in writing from the publisher.

5-15 The solid shaft has a diameter of 0.75 in. If it is subjected to the torques shown, determine the maximum shear stress developed in regions CD and EF of the shaft. The bearings at A and F allow free rotation of the shaft.

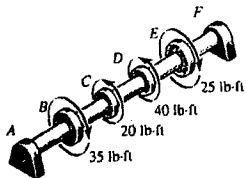

$$(\tau_{EF})_{\max} = \frac{T_{EF} c}{J} = 0$$

$$(\tau_{CD})_{\max} = \frac{T_{CD} c}{J} = \frac{15(12)(0.375)}{\frac{\pi}{2}(0.375)^4} = 2173 \text{ psi} = 2.17 \text{ ksi}$$

Ans

Ans

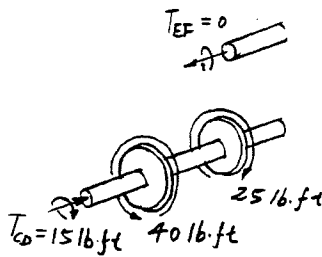

From *Mechanics of Materials*, Sixth Edition by R. C. Hibbeler, ISBN 0-13-191345-X.
 © 2005 R. C. Hibbeler. Published by Pearson Prentice Hall,
 Pearson Education, Inc., Upper Saddle River, NJ. All rights reserved.
 This material is protected under all copyright laws as they currently exist. No portion of this material may be reproduced, in any form or by any means, without permission in writing from the publisher.

*5-16 The steel shaft has a diameter of 1 in. and is screwed into the wall using a wrench. Determine the largest couple forces F that can be applied to the shaft without causing the steel to yield. $\tau_y = 8$ ksi.

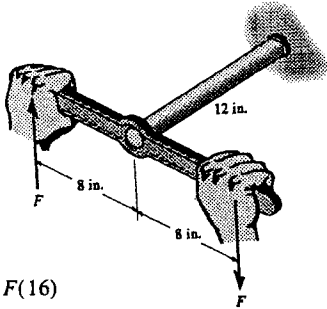

$$T = F(16)$$

$$\tau_{\max} = \frac{Tc}{J}; \quad 8(10^3) = \frac{F(16)(0.5)}{\frac{\pi}{2}(0.5)^4}$$

$$F = 98.2 \text{ lb} \quad \text{Ans}$$

From *Mechanics of Materials*, Sixth Edition by R. C. Hibbeler, ISBN 0-13-191345-X.

© 2005 R. C. Hibbeler. Published by Pearson Prentice Hall,

Pearson Education, Inc., Upper Saddle River, NJ. All rights reserved.

This material is protected under all copyright laws as they currently exist. No portion of this material may be reproduced, in any form or by any means, without permission in writing from the publisher.

5-17 The steel shaft has a diameter of 1 in. and is screwed into the wall using a wrench. Determine the maximum shear stress in the shaft if the couple forces have a magnitude of $F = 30$ lb.

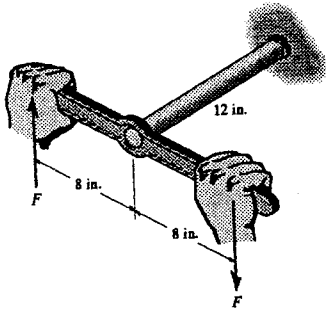

$$T = 30(16) = 480 \text{ lb} \cdot \text{in.}$$

$$\tau_{\max} = \frac{Tc}{J} = \frac{480(0.5)}{\frac{\pi}{2}(0.5)^4} = 2.44 \text{ ksi} \quad \mathbf{Ans}$$

From *Mechanics of Materials*, Sixth Edition by R. C. Hibbeler, ISBN 0-13-191345-X.

© 2005 R. C. Hibbeler. Published by Pearson Prentice Hall,

Pearson Education, Inc., Upper Saddle River, NJ. All rights reserved.

This material is protected under all copyright laws as they currently exist. No portion of this material may be reproduced, in any form or by any means, without permission in writing from the publisher.

5-18. The steel shaft is subjected to the torsional loading shown. Determine the shear stress developed at points *A* and *B* and sketch the shear stress on volume elements located at these points. The shaft where *A* and *B* are located has an outer radius of 60 mm.

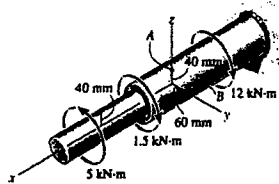

$$\tau_A = \frac{T\rho}{J} = \frac{3.5(10^3)(0.04)}{\frac{\pi}{2}(0.06)^4} = 6.88 \text{ MPa} \quad \text{Ans}$$

$$\tau_B = \frac{Tc}{J} = \frac{3.5(10^3)(0.06)}{\frac{\pi}{2}(0.06)^4} = 10.3 \text{ MPa} \quad \text{Ans}$$

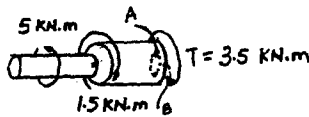

From *Mechanics of Materials*, Sixth Edition by R. C. Hibbeler, ISBN 0-13-191345-X.

© 2005 R. C. Hibbeler. Published by Pearson Prentice Hall,

Pearson Education, Inc., Upper Saddle River, NJ. All rights reserved.

This material is protected under all copyright laws as they currently exist. No portion of this material may be reproduced, in any form or by any means, without permission in writing from the publisher.

5-19. The steel shaft is subjected to the torsional loading shown. Determine the absolute maximum shear stress in the shaft and sketch the shear-stress distribution along a radial line where it is maximum.

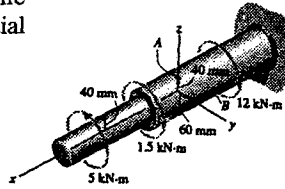

Maximum torque is $8.5 \text{ kN} \cdot \text{m}$; however, two sections of the shaft should be considered since J is different.

$$\tau_{\max} = \frac{Tc}{J} = \frac{5(10^3)(0.04)}{\frac{\pi}{2}(0.04)^4} = 49.7 \text{ MPa}$$

$$\tau_{\max} = \frac{Tc}{J} = \frac{8.5(10^3)(0.06)}{\frac{\pi}{2}(0.06)^4} = 25.1 \text{ MPa}$$

$$\tau_{\max \text{ abs}} = 49.7 \text{ MPa} \quad \text{Ans}$$

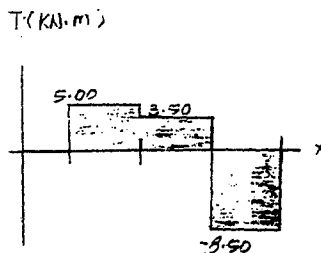

From *Mechanics of Materials*, Sixth Edition by R. C. Hibbeler, ISBN 0-13-191345-X.

© 2005 R. C. Hibbeler. Published by Pearson Prentice Hall,

Pearson Education, Inc., Upper Saddle River, NJ. All rights reserved.

This material is protected under all copyright laws as they currently exist. No portion of this material may be reproduced, in any form or by any means, without permission in writing from the publisher.

***5-20** The 20-mm-diameter steel shafts are connected using a brass coupling. If the yield point for the steel is $(\tau_y)_s = 100 \text{ MPa}$ and for the brass $(\tau_y)_{br} = 250 \text{ MPa}$, determine the required outer diameter d of the coupling so that the steel and brass begin to yield at the same time when the assembly is subjected to a torque T . Assume that the coupling has an inner diameter of 20 mm.

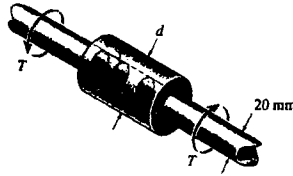

For the steel shaft :

$$\tau_{\max} = \frac{Tc}{J}; \quad 100(10^6) = \frac{T(0.01)}{\frac{\pi}{2}(0.01)^4}; \quad T = 157.08 \text{ N} \cdot \text{m}$$

For the brass coupling :

$$\tau_{\max} = \frac{Tc}{J}; \quad 250(10^6) = \frac{157.08(\frac{d}{2})}{\frac{\pi}{2}[(\frac{d}{2})^4 - (0.01)^4]}$$

$$24.5437(10^6)(d^4) - 78.54d - 3.9270 = 0$$

Solving,

$$d = 0.0219 \text{ m} = 21.9 \text{ mm} \quad \text{Ans}$$

From *Mechanics of Materials*, Sixth Edition by R. C. Hibbeler, ISBN 0-13-191345-X.

© 2005 R. C. Hibbeler. Published by Pearson Prentice Hall,

Pearson Education, Inc., Upper Saddle River, NJ. All rights reserved.

This material is protected under all copyright laws as they currently exist. No portion of this material may be reproduced, in any form or by any means, without permission in writing from the publisher.

5-21 The 20-mm-diameter steel shafts are connected using a brass coupling. If the yield point for the steel is $(\tau_Y)_{st} = 100 \text{ MPa}$, determine the applied torque T necessary to cause the steel to yield. If $d = 40 \text{ mm}$, determine the maximum shear stress in the brass. The coupling has an inner diameter of 20 mm.

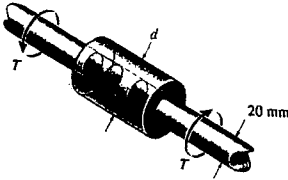

For the steel shaft :

$$(\tau_Y)_{st} = \frac{Tc}{J}; \quad 100(10^6) = \frac{T(0.01)}{\frac{\pi}{2}(0.01)^4}$$

$$T = 157.08 \text{ N} \cdot \text{m} = 157 \text{ N} \cdot \text{m}$$

Ans

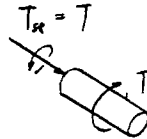

For the brass shaft :

$$(\tau_{max})_{br} = \frac{Tc}{J} = \frac{157.08(0.02)}{\frac{\pi}{2}[0.02^4 - 0.01^4]} = 13.3 \text{ MPa} \quad \text{Ans}$$

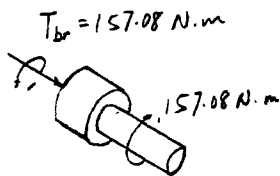

From *Mechanics of Materials*, Sixth Edition by R. C. Hibbeler, ISBN 0-13-191345-X.

© 2005 R. C. Hibbeler. Published by Pearson Prentice Hall,

Pearson Education, Inc., Upper Saddle River, NJ. All rights reserved.

This material is protected under all copyright laws as they currently exist. No portion of this material may be reproduced, in any form or by any means, without permission in writing from the publisher.

5-22. The coupling is used to connect the two shafts together. Assuming that the shear stress in the bolts is *uniform*, determine the number of bolts necessary to make the maximum shear stress in the shaft equal to the shear stress in the bolts. Each bolt has a diameter d .

n is the number of bolts and F is the shear force in each bolt

$$T - nFR = 0; \quad F = \frac{T}{nR}$$

$$\tau_{avg} = \frac{F}{A} = \frac{\frac{T}{nR}}{(\frac{\pi}{4})d^2} = \frac{4T}{nR\pi d^2}$$

Maximum shear stress for the shaft :

$$\tau_{max} = \frac{Tc}{J} = \frac{Tr}{\frac{\pi}{2}r^4} = \frac{2T}{\pi r^3}$$

$$\tau_{avg} = \tau_{max}; \quad \frac{4T}{nR\pi d^2} = \frac{2T}{\pi r^3}$$

$$n = \frac{2r^3}{Rd^2} \quad \text{Ans}$$

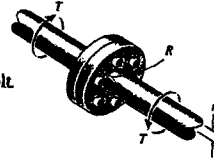

From *Mechanics of Materials*, Sixth Edition by R. C. Hibbeler, ISBN 0-13-191345-X.
 © 2005 R. C. Hibbeler. Published by Pearson Prentice Hall,
 Pearson Education, Inc., Upper Saddle River, NJ. All rights reserved.
 This material is protected under all copyright laws as they currently exist. No portion of this material may be reproduced, in any form or by any means, without permission in writing from the publisher.

5-23. The steel shafts are connected together using a fillet weld as shown. Determine the average shear stress in the weld along section $a-a$ if the torque applied to the shafts is $T = 60 \text{ N}\cdot\text{m}$. *Note:* The critical section where the weld fails is along section $a-a$.

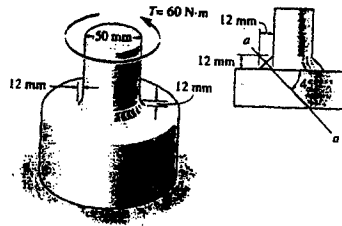

$$\tau_{avg} = \frac{V}{A} = \frac{(60 / (0.025 + 0.006))}{2\pi(0.025 + 0.006)(0.012\sin 45^\circ)}$$

$$\tau_{avg} = 1.17 \text{ MPa} \quad \text{Ans}$$

From *Mechanics of Materials*, Sixth Edition by R. C. Hibbeler, ISBN 0-13-191345-X.

© 2005 R. C. Hibbeler. Published by Pearson Prentice Hall,

Pearson Education, Inc., Upper Saddle River, NJ. All rights reserved.

This material is protected under all copyright laws as they currently exist. No portion of this material may be reproduced, in any form or by any means, without permission in writing from the publisher.

*5-24 The rod has a diameter of 0.5 in. and a weight of 5 lb/ft. Determine the maximum torsional stress in the rod at a section located at A due to the rod's weight.

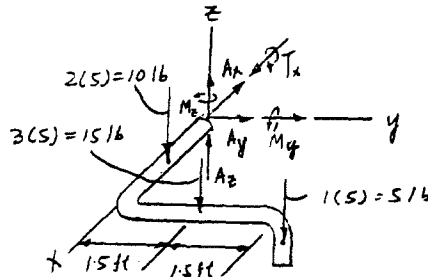
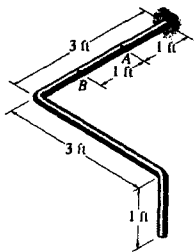

$$\Sigma M_x = 0; \quad T_x - 15(1.5) - 5(3) = 0;$$

$$T_x = 37.5 \text{ lb} \cdot \text{ft}$$

$$(\tau_A)_{\max} = \frac{Tc}{J} = \frac{37.5(12)(0.25)}{\frac{\pi}{2}(0.25)^4} = 18.3 \text{ ksi} \quad \text{Ans}$$

From *Mechanics of Materials*, Sixth Edition by R. C. Hibbeler, ISBN 0-13-191345-X.

© 2005 R. C. Hibbeler. Published by Pearson Prentice Hall,

Pearson Education, Inc., Upper Saddle River, NJ. All rights reserved.

This material is protected under all copyright laws as they currently exist. No portion of this material may be reproduced, in any form or by any means, without permission in writing from the publisher.

5-25 Solve Prob. 5-24 for the maximum torsional stress at B.

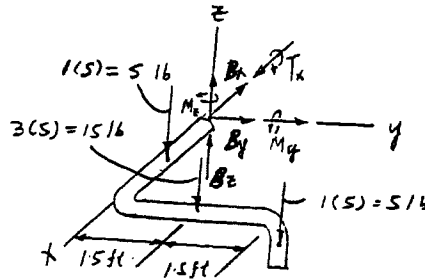
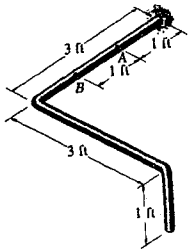

$$\Sigma M_x = 0; \quad -15(1.5) - 5(3) + T_x = 0;$$

$$T_x = 37.5 \text{ lb} \cdot \text{ft} = 450 \text{ lb} \cdot \text{in.}$$

$$(\tau_B)_{\max} = \frac{Tc}{J} = \frac{450(0.25)}{\frac{\pi}{2}(0.25)^4} = 18.3 \text{ ksi} \quad \text{Ans}$$

From *Mechanics of Materials*, Sixth Edition by R. C. Hibbeler, ISBN 0-13-191345-X.

© 2005 R. C. Hibbeler. Published by Pearson Prentice Hall,

Pearson Education, Inc., Upper Saddle River, NJ. All rights reserved.

This material is protected under all copyright laws as they currently exist. No portion of this material may be reproduced, in any form or by any means, without permission in writing from the publisher.

Because of the number and variety of potential correct solutions to this problem, no solution is being given.

From *Mechanics of Materials*, Sixth Edition by R. C. Hibbeler, ISBN 0-13-191345-X.

© 2005 R. C. Hibbeler. Published by Pearson Prentice Hall,

Pearson Education, Inc, Upper Saddle River, NJ. All rights reserved.

This material is protected under all copyright laws as they currently exist. No portion of this material may be reproduced, in any form or by any means, without permission in writing from the publisher.

5-27. The shaft is subjected to a distributed torque along its length of $t = (10x^2) \text{ N}\cdot\text{m/m}$, where x is in meters. If the maximum stress in the shaft is to remain constant at 80 MPa, determine the required variation of the radius c of the shaft for $0 \leq x \leq 3 \text{ m}$.

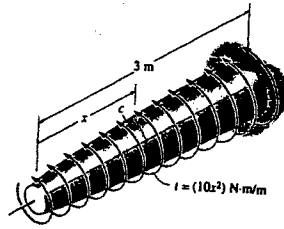

$$T = \int t dx = \int_0^x 10x^2 dx = \frac{10}{3}x^3$$

$$\tau = \frac{Tc}{J}; \quad 80(10^6) = \frac{(\frac{10}{3})x^3 c}{\frac{\pi}{2}c^4}$$

$$c^3 = 26.526(10^{-9})x^3$$

$$c = (2.98x) \text{ mm} \quad \text{Ans}$$

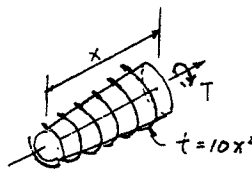

From *Mechanics of Materials*, Sixth Edition by R. C. Hibbeler, ISBN 0-13-191345-X.

© 2005 R. C. Hibbeler. Published by Pearson Prentice Hall,

Pearson Education, Inc., Upper Saddle River, NJ. All rights reserved.

This material is protected under all copyright laws as they currently exist. No portion of this material may be reproduced, in any form or by any means, without permission in writing from the publisher.

*5-28 A cylindrical spring consists of a rubber annulus bonded to a rigid ring and shaft. If the ring is held fixed and a torque T is applied to the shaft, determine the maximum shear stress in the rubber.

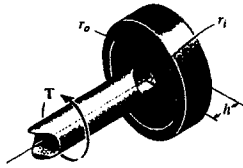

$$\tau = \frac{F}{A} = \frac{\frac{T}{r}}{2\pi r h} = \frac{T}{2\pi r^2 h}$$

Shear stress is maximum when r is the smallest, i.e. $r = r_i$. Hence,

$$\tau_{\max} = \frac{T}{2\pi r_i^2 h} \quad \text{Ans}$$

From *Mechanics of Materials*, Sixth Edition by R. C. Hibbeler, ISBN 0-13-191345-X.

© 2005 R. C. Hibbeler. Published by Pearson Prentice Hall,

Pearson Education, Inc., Upper Saddle River, NJ. All rights reserved.

This material is protected under all copyright laws as they currently exist. No portion of this material may be reproduced, in any form or by any means, without permission in writing from the publisher.

■5-29. The shaft has a diameter of 80 mm and due to friction at its surface within the hole, it is subjected to a variable torque described by the function $t = (25xe^{x^2}) \text{ N} \cdot \text{m}/\text{m}$, where x is in meters. Determine the minimum torque T_0 needed to overcome friction and cause it to twist. Also, determine the absolute maximum stress in the shaft.

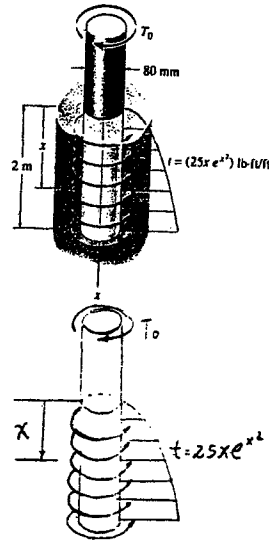

$$t = 25(x e^{x^2}) ; \quad T_0 = \int_0^2 25(x e^{x^2}) dx$$

Integrating using Simpson's rule, we get

$$T_0 = 669.98 = 670 \text{ N} \cdot \text{m} \quad \text{Ans}$$

$$\tau_{\text{abs}} = \frac{T_0 c}{J} = \frac{(669.98)(0.04)}{\frac{\pi}{2}(0.04)^4} = 6.66 \text{ MPa} \quad \text{Ans}$$

From *Mechanics of Materials*, Sixth Edition by R. C. Hibbeler, ISBN 0-13-191345-X.

© 2005 R. C. Hibbeler. Published by Pearson Prentice Hall,

Pearson Education, Inc., Upper Saddle River, NJ. All rights reserved.

This material is protected under all copyright laws as they currently exist. No portion of this material may be reproduced, in any form or by any means, without permission in writing from the publisher.

5-30. The solid shaft has a linear taper from r_A at one end to r_B at the other. Derive an equation that gives the maximum shear stress in the shaft at a location x along the shaft's axis.

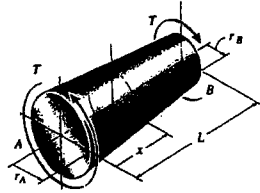

$$r = r_B + \frac{r_A - r_B}{L}(L - x) = \frac{r_B L + (r_A - r_B)(L - x)}{L}$$

$$= \frac{r_A(L - x) + r_B x}{L}$$

$$\tau_{\max} = \frac{Tc}{J} = \frac{Tr}{\frac{\pi}{2}r^4} = \frac{2T}{\pi r^3}$$

$$= \frac{2T}{\pi \left[\frac{r_A(L-x) + r_B x}{L} \right]^3} = \frac{2TL^3}{\pi [r_A(L-x) + r_B x]^3}$$

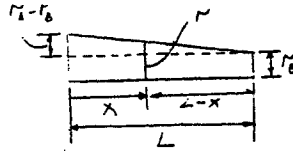

Ans

From *Mechanics of Materials*, Sixth Edition by R. C. Hibbeler, ISBN 0-13-191345-X.

© 2005 R. C. Hibbeler. Published by Pearson Prentice Hall,

Pearson Education, Inc., Upper Saddle River, NJ. All rights reserved.

This material is protected under all copyright laws as they currently exist. No portion of this material may be reproduced, in any form or by any means, without permission in writing from the publisher.

5-31 When drilling a well at constant angular velocity, the bottom end of the drill pipe encounters a torsional resistance T_A . Also, soil along the sides of the pipe creates a distributed frictional torque along its length, varying uniformly from zero at the surface B to t_A at A . Determine the minimum torque T_B that must be supplied by the drive unit to overcome the resisting torques, and compute the maximum shear stress in the pipe. The pipe has an outer radius r_o and an inner radius r_i .

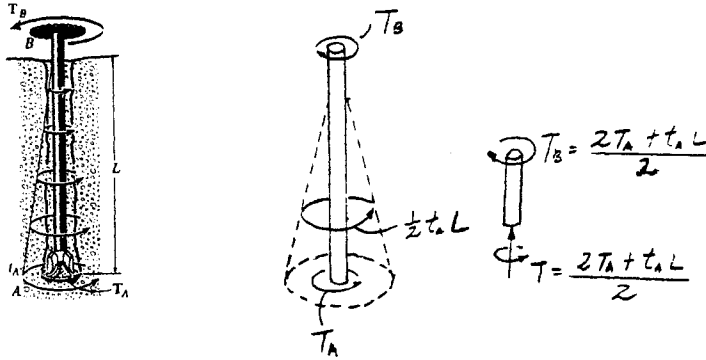

$$T_A + \frac{1}{2}t_A L - T_B = 0$$

$$T_B = \frac{2T_A + t_A L}{2} \quad \text{Ans}$$

Maximum shear stress : The maximum torque is within the region above the distributed torque.

$$\tau_{\max} = \frac{T c}{J}$$

$$\tau_{\max} = \frac{\left[\frac{(2T_A + t_A L)}{2}\right](r_o)}{\frac{\pi}{2}(r_o^4 - r_i^4)} = \frac{(2T_A + t_A L)r_o}{\pi(r_o^4 - r_i^4)} \quad \text{Ans}$$

From *Mechanics of Materials*, Sixth Edition by R. C. Hibbeler, ISBN 0-13-191345-X.

© 2005 R. C. Hibbeler. Published by Pearson Prentice Hall,

Pearson Education, Inc., Upper Saddle River, NJ. All rights reserved.

This material is protected under all copyright laws as they currently exist. No portion of this material may be reproduced, in any form or by any means, without permission in writing from the publisher.

*5-32 The drive shaft AB of an automobile is made of a steel having an allowable shear stress of $\tau_{\text{allow}} = 8$ ksi. If the outer diameter of the shaft is 2.5 in. and the engine delivers 200 hp to the shaft when it is turning at 1140 rev/min, determine the minimum required thickness of the shaft's wall.

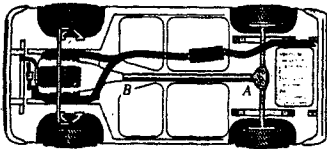

$$\omega = \frac{1140(2\pi)}{60} = 119.38 \text{ rad/s}$$

$$P = T\omega$$

$$200(550) = T(119.38)$$

$$T = 921.42 \text{ lb} \cdot \text{ft}$$

$$\tau_{\text{allow}} = \frac{Tc}{J}$$

$$8(10^3) = \frac{921.42(12)(1.25)}{\frac{\pi}{2}(1.25^4 - r_i^4)}, \quad r_i = 1.0762 \text{ in.}$$

$$t = r_o - r_i = 1.25 - 1.0762$$

$$t = 0.174 \text{ in.} \quad \mathbf{Ans}$$

From *Mechanics of Materials*, Sixth Edition by R. C. Hibbeler, ISBN 0-13-191345-X.

© 2005 R. C. Hibbeler. Published by Pearson Prentice Hall,

Pearson Education, Inc., Upper Saddle River, NJ. All rights reserved.

This material is protected under all copyright laws as they currently exist. No portion of this material may be reproduced, in any form or by any means, without permission in writing from the publisher.

5-33 The drive shaft AB of an automobile is to be designed as a thin-walled tube. The engine delivers 150 hp when the shaft is turning at 1500 rev/min. Determine the minimum thickness of the shaft's wall if the shaft's outer diameter is 2.5 in. The material has an allowable shear stress of $\tau_{\text{allow}} = 7$ ksi.

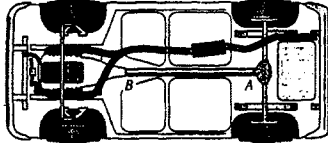

$$\omega = \frac{1500(2\pi)}{60} = 157.08 \text{ rad/s}$$

$$P = T\omega$$

$$150(550) = T(157.08)$$

$$T = 525.21 \text{ lb} \cdot \text{ft}$$

$$\tau_{\text{allow}} = \frac{Tc}{J}$$

$$7(10^3) = \frac{525.21(12)(1.25)}{\frac{\pi}{2}(1.25^4 - r_i^4)}, \quad r_i = 1.1460 \text{ in.}$$

$$t = r_o - r_i = 1.25 - 1.1460$$

$$t = 0.104 \text{ in.} \quad \text{Ans}$$

From *Mechanics of Materials*, Sixth Edition by R. C. Hibbeler, ISBN 0-13-191345-X.

© 2005 R. C. Hibbeler. Published by Pearson Prentice Hall,

Pearson Education, Inc., Upper Saddle River, NJ. All rights reserved.

This material is protected under all copyright laws as they currently exist. No portion of this material may be reproduced, in any form or by any means, without permission in writing from the publisher.

5-34 The drive shaft of a tractor is to be designed as a thin-walled tube. The engine delivers 200 hp when the shaft is turning at 1200 rev/min. Determine the minimum thickness of the wall of the shaft if the shaft's outer diameter is 3 in. The material has an allowable shear stress of $\tau_{\text{allow}} = 7$ ksi.

$$\omega = 1200 \frac{\text{rev}}{\text{min}} \left[\frac{2\pi \text{ rad}}{\text{rev}} \right] \frac{1 \text{ min}}{60 \text{ s}} = 40\pi \text{ rad/s}$$

$$P = 200 \text{ hp} \left[\frac{550 \text{ ft} \cdot \text{lb/s}}{1 \text{ hp}} \right] = 110,000 \text{ ft} \cdot \text{lb/s}$$

$$T = \frac{P}{\omega} = \frac{110,000}{40\pi} = 875.35 \text{ lb} \cdot \text{ft}$$

$$\tau_{\text{max}} = \tau_{\text{allow}} = \frac{Tc}{J}$$

$$7(10^3) = \frac{875.35(12)(1.5)}{\frac{\pi}{2}(1.5^4 - r_i^4)} ; \quad r_i = 1.380 \text{ in.}$$

$$t = r_o - r_i = 1.5 - 1.380 = 0.120 \text{ in.} \quad \mathbf{Ans}$$

From *Mechanics of Materials*, Sixth Edition by R. C. Hibbeler, ISBN 0-13-191345-X.

© 2005 R. C. Hibbeler. Published by Pearson Prentice Hall,

Pearson Education, Inc., Upper Saddle River, NJ. All rights reserved.

This material is protected under all copyright laws as they currently exist. No portion of this material may be reproduced, in any form or by any means, without permission in writing from the publisher.

5-35 A motor delivers 500 hp to the steel shaft AB , which is tubular and has an outer diameter of 2 in. If it is rotating at 200 rad/s, determine its largest inner diameter to the nearest $\frac{1}{8}$ in. if the allowable shear stress for the material is $\tau_{\text{allow}} = 25$ ksi.

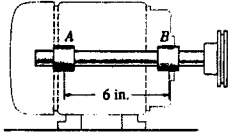

$$P = 500 \text{ hp} \left[\frac{550 \text{ ft} \cdot \text{lb/s}}{1 \text{ hp}} \right] = 275000 \text{ ft} \cdot \text{lb/s}$$

$$T = \frac{P}{\omega} = \frac{275000}{200} = 1375 \text{ lb} \cdot \text{ft}$$

$$\tau_{\text{max}} = \tau_{\text{allow}} = \frac{Tc}{J}$$

$$25(10^3) = \frac{1375(12)(1)}{\frac{\pi}{2} [1^4 - (\frac{d_i}{2})^4]}$$

$$\text{Use } d = 1\frac{5}{8} \text{ in.} \quad \mathbf{Ans}$$

From *Mechanics of Materials*, Sixth Edition by R. C. Hibbeler, ISBN 0-13-191345-X.

© 2005 R. C. Hibbeler. Published by Pearson Prentice Hall,

Pearson Education, Inc., Upper Saddle River, NJ. All rights reserved.

This material is protected under all copyright laws as they currently exist. No portion of this material may be reproduced, in any form or by any means, without permission in writing from the publisher.

***5-36** The drive shaft of a tractor is made of a steel tube having an allowable shear stress of $\tau_{allow} = 6$ ksi. If the outer diameter is 3 in. and the engine delivers 175 hp to the shaft when it is turning at 1250 rev/min, determine the minimum required thickness of the shaft's wall.

$$\omega = 1250 \frac{\text{rev}}{\text{min}} \left[\frac{2\pi \text{ rad}}{\text{rev}} \right] \frac{1 \text{ min}}{60 \text{ s}} = 130.90 \text{ rad/s}$$

$$P = 175 \text{ hp} \left[\frac{550 \text{ ft} \cdot \text{lb/s}}{1 \text{ hp}} \right] = 96,250 \text{ ft} \cdot \text{lb/s}$$

$$T = \frac{P}{\omega} = \frac{96,250}{130.90} = 735.30 \text{ lb} \cdot \text{ft}$$

$$\tau_{max} = \tau_{allow} = \frac{Tc}{J}$$

$$6(10^3) = \frac{735.30(12)(1.5)}{\frac{\pi}{2}(1.5^4 - r_i^4)} ; \quad r_i = 1.383 \text{ in.}$$

$$t = r_o - r_i = 1.5 - 1.383 = 0.117 \text{ in.} \quad \text{Ans}$$

From *Mechanics of Materials*, Sixth Edition by R. C. Hibbeler, ISBN 0-13-191345-X.

© 2005 R. C. Hibbeler. Published by Pearson Prentice Hall,

Pearson Education, Inc., Upper Saddle River, NJ. All rights reserved.

This material is protected under all copyright laws as they currently exist. No portion of this material may be reproduced, in any form or by any means, without permission in writing from the publisher.

5-37 A motor delivers 500 hp to the steel shaft AB , which is tubular and has an outer diameter of 2 in. and an inner diameter of 1.84 in. Determine the *smallest* angular velocity at which it can rotate if the allowable shear stress for the material is $\tau_{\text{allow}} = 25$ ksi.

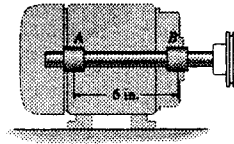

$$P = 500 \text{ hp} \left[\frac{550 \text{ ft} \cdot \text{lb/s}}{1 \text{ hp}} \right] = 275000 \text{ ft} \cdot \text{lb/s}$$

$$T = \frac{P}{\omega} = \frac{275000}{\omega}$$

$$\tau_{\text{max}} = \tau_{\text{allow}} = \frac{Tc}{J}$$

$$25(10^3) = \frac{\left(\frac{275000}{\omega}\right)(12)(1)}{\frac{\pi}{2}(1^4 - 0.92^4)}$$

From *Mechanics of Materials*, Sixth Edition by R. C. Hibbeler, ISBN 0-13-191345-X.

© 2005 R. C. Hibbeler. Published by Pearson Prentice Hall,

Pearson Education, Inc., Upper Saddle River, NJ. All rights reserved.

This material is protected under all copyright laws as they currently exist. No portion of this material may be reproduced, in any form or by any means, without permission in writing from the publisher.

5-38 The 0.75-in.-diameter shaft for the electric motor develops 0.5 hp and runs at 1740 rev/min. Determine the torque produced and compute the maximum shear stress in the shaft. The shaft is supported by ball bearings at *A* and *B*.

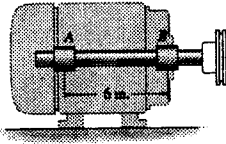

$$\omega = 1740 \frac{\text{rev}}{\text{min}} \left(\frac{2\pi \text{ rad}}{1 \text{ rev}} \right) \frac{1 \text{ min}}{60 \text{ s}} = 58 \pi \text{ rad/s}$$

$$P = 0.5 \text{ hp} \left(\frac{550 \text{ ft} \cdot \text{lb/s}}{1 \text{ hp}} \right) = 275 \text{ ft} \cdot \text{lb/s}$$

$$T = \frac{P}{\omega} = \frac{275}{58 \pi} = 1.5092 \text{ lb} \cdot \text{ft} = 1.51 \text{ lb} \cdot \text{ft} \quad \text{Ans}$$

$$\tau_{\max} = \frac{Tc}{J} = \frac{1.5092(12)(0.375)}{\frac{\pi}{2}(0.375^4)} = 219 \text{ psi} \quad \text{Ans}$$

From *Mechanics of Materials*, Sixth Edition by R. C. Hibbeler, ISBN 0-13-191345-X.

© 2005 R. C. Hibbeler. Published by Pearson Prentice Hall,

Pearson Education, Inc., Upper Saddle River, NJ. All rights reserved.

This material is protected under all copyright laws as they currently exist. No portion of this material may be reproduced, in any form or by any means, without permission in writing from the publisher.

5-39 The solid steel shaft AC has a diameter of 25 mm and is supported by smooth bearings at D and E . It is coupled to a motor at C , which delivers 3 kW of power to the shaft while it is turning at 50 rev/s. If gears A and B remove 1 kW and 2 kW, respectively, determine the maximum shear stress developed in the shaft within regions AB and BC . The shaft is free to turn in its support bearings D and E .

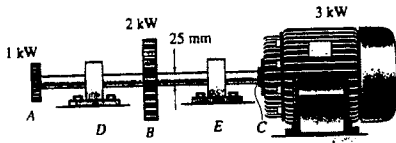

$$T_C = \frac{P}{\omega} = \frac{3(10^3)}{50(2\pi)} = 9.549 \text{ N} \cdot \text{m}$$

$$T_A = \frac{1}{3} T_C = 3.183 \text{ N} \cdot \text{m}$$

$$(\tau_{AB})_{\max} = \frac{T_C}{J} = \frac{3.183 (0.0125)}{\frac{\pi}{2}(0.0125^4)} = 1.04 \text{ MPa} \quad \text{Ans}$$

$$(\tau_{BC})_{\max} = \frac{T_C}{J} = \frac{9.549 (0.0125)}{\frac{\pi}{2}(0.0125^4)} = 3.11 \text{ MPa} \quad \text{Ans}$$

From *Mechanics of Materials*, Sixth Edition by R. C. Hibbeler, ISBN 0-13-191345-X.

© 2005 R. C. Hibbeler. Published by Pearson Prentice Hall,

Pearson Education, Inc., Upper Saddle River, NJ. All rights reserved.

This material is protected under all copyright laws as they currently exist. No portion of this material may be reproduced, in any form or by any means, without permission in writing from the publisher.

*5-40 The solid steel shaft DF has a diameter of 25 mm and is supported by smooth bearings at D and E . It is coupled to a motor at F , which delivers 12 kW of power to the shaft while it is turning at 50 rev/s. If gears A , B , and C , remove 3 kW, 4 kW, and 5 kW respectively, determine the maximum shear stress developed in the shaft within regions CF and BC . The shaft is free to turn in its support bearings D and E .

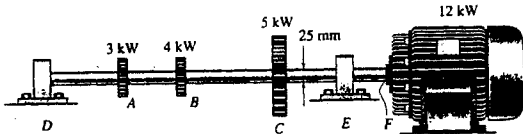

$$\omega = 50 \frac{\text{rev}}{\text{s}} \left[\frac{2\pi \text{ rad}}{\text{rev}} \right] = 100\pi \text{ rad/s}$$

$$T_F = \frac{P}{\omega} = \frac{12(10^3)}{100\pi} = 38.20 \text{ N}\cdot\text{m}$$

$$T_A = \frac{P}{\omega} = \frac{3(10^3)}{100\pi} = 9.549 \text{ N}\cdot\text{m}$$

$$T_B = \frac{P}{\omega} = \frac{4(10^3)}{100\pi} = 12.73 \text{ N}\cdot\text{m}$$

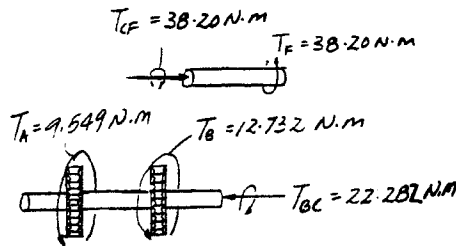

$$(\tau_{\max})_{CF} = \frac{T_{CF} c}{J} = \frac{38.20(0.0125)}{\frac{\pi}{2}(0.0125^4)} = 12.5 \text{ MPa} \quad \text{Ans}$$

$$(\tau_{\max})_{BC} = \frac{T_{BC} c}{J} = \frac{22.282(0.0125)}{\frac{\pi}{2}(0.0125^4)} = 7.26 \text{ MPa} \quad \text{Ans}$$

From *Mechanics of Materials*, Sixth Edition by R. C. Hibbeler, ISBN 0-13-191345-X.

© 2005 R. C. Hibbeler. Published by Pearson Prentice Hall,

Pearson Education, Inc., Upper Saddle River, NJ. All rights reserved.

This material is protected under all copyright laws as they currently exist. No portion of this material may be reproduced, in any form or by any means, without permission in writing from the publisher.

5-41. Determine the absolute maximum shear stress developed in the shaft in Prob. 5-40.

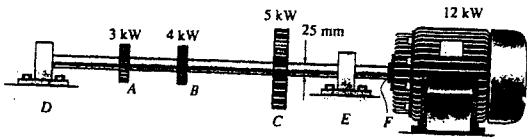

$$\omega = 50 \frac{\text{rev}}{\text{s}} \left[\frac{2\pi \text{ rad}}{\text{rev}} \right] = 100\pi \text{ rad/s}$$

$$T_F = \frac{P}{\omega} = \frac{12(10^3)}{100\pi} = 38.20 \text{ N}\cdot\text{m}$$

$$T_A = \frac{P}{\omega} = \frac{3(10^3)}{100\pi} = 9.549 \text{ N}\cdot\text{m}$$

$$T_B = \frac{P}{\omega} = \frac{4(10^3)}{100\pi} = 12.73 \text{ N}\cdot\text{m}$$

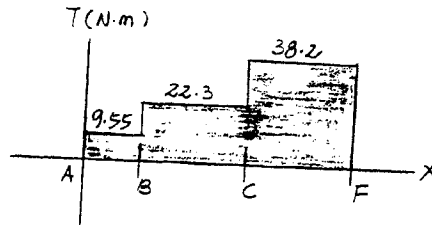

From the torque diagram,

$$T_{\max} = 38.2 \text{ N}\cdot\text{m}$$

$$\tau_{\max} = \frac{Tc}{J} = \frac{38.2(0.0125)}{\frac{\pi}{2}(0.0125^4)} = 12.5 \text{ MPa}$$

Ans

From *Mechanics of Materials*, Sixth Edition by R. C. Hibbeler, ISBN 0-13-191345-X.

© 2005 R. C. Hibbeler. Published by Pearson Prentice Hall,

Pearson Education, Inc., Upper Saddle River, NJ. All rights reserved.

This material is protected under all copyright laws as they currently exist. No portion of this material may be reproduced, in any form or by any means, without permission in writing from the publisher.

5-42 The motor delivers 500 hp to the steel shaft AB , which is tubular and has an outer diameter of 2 in. and an inner diameter of 1.84 in. Determine the *smallest* angular velocity at which it can rotate if the allowable shear stress for the material is $\tau_{\text{allow}} = 25$ ksi.

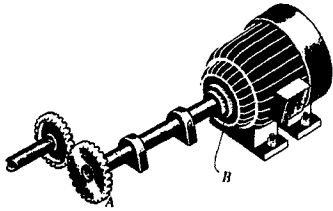

$$\tau_{\text{allow}} = \frac{Tc}{J}$$

$$25(10^3) = \frac{T(1)}{\frac{\pi}{2}(1^4 - 0.92^4)}$$

$$T = 11137.22 \text{ lb} \cdot \text{in.}$$

$$P = T\omega$$

$$500(550) = \frac{11137.22}{12}(\omega)$$

$$\omega = 296 \text{ rad/s} \quad \mathbf{Ans}$$

From *Mechanics of Materials*, Sixth Edition by R. C. Hibbeler, ISBN 0-13-191345-X.

© 2005 R. C. Hibbeler. Published by Pearson Prentice Hall,

Pearson Education, Inc., Upper Saddle River, NJ. All rights reserved.

This material is protected under all copyright laws as they currently exist. No portion of this material may be reproduced, in any form or by any means, without permission in writing from the publisher.

5-43 The motor delivers 50 hp while turning at a constant rate of 1350 rpm at A. Using the belt and pulley system this loading is delivered to the steel blower shaft BC. Determine to the nearest $\frac{1}{8}$ in. the smallest diameter of this shaft if the allowable shear stress for the steel is $\tau_{\text{allow}} = 12$ ksi.

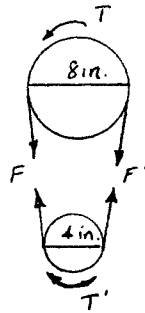
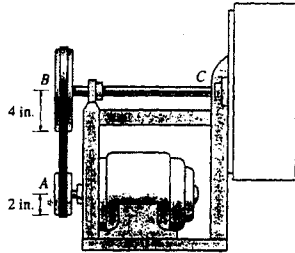

$$P = T\omega$$

$$50(550) = T'(1350 \text{ rev/min})\left(\frac{2\pi \text{ rad}}{1 \text{ rev}}\right)\left(\frac{1 \text{ min}}{60 \text{ s}}\right)$$

$$T' = 194.52 \text{ lb} \cdot \text{ft}$$

$$4(F' - F) = T'$$

$$4(F' - F) = (194.52)(12)$$

$$(F' - F) = 583.57 \text{ lb}$$

$$T = 8(F' - F)$$

$$= 8(583.57) = 4668.5 \text{ lb} \cdot \text{in}$$

$$\tau_{\text{allow}} = \frac{Tc}{J}; \quad 12(10^3) = \frac{4668.5c}{\frac{\pi}{2}(c)^4}$$

$$c = 0.628 \text{ in.}$$

Use $1\frac{3}{8}$ in. - diameter shaft. **Ans**

From *Mechanics of Materials*, Sixth Edition by R. C. Hibbeler, ISBN 0-13-191345-X.

© 2005 R. C. Hibbeler. Published by Pearson Prentice Hall,

Pearson Education, Inc., Upper Saddle River, NJ. All rights reserved.

This material is protected under all copyright laws as they currently exist. No portion of this material may be reproduced, in any form or by any means, without permission in writing from the publisher.

***5-44.** The propellers of a ship are connected to a .
 A-36 steel shaft that is 60 m long and has an outer diameter of 340 mm and inner diameter of 260 mm. If the power output is 4.5 MW when the shaft rotates at 20 rad/s, determine the maximum torsional stress in the shaft and its angle of twist.

$$T = \frac{P}{\omega} = \frac{4.5(10^6)}{20} = 225(10^3) \text{ N} \cdot \text{m}$$

$$\tau_{\max} = \frac{Tc}{J} = \frac{225(10^3)(0.170)}{\frac{\pi}{2}[(0.170)^4 - (0.130)^4]} = 44.3 \text{ MPa}$$

Ans

$$\phi = \frac{TL}{JG} = \frac{225(10^3)(60)}{\frac{\pi}{2}[(0.170)^4 - (0.130)^4]75(10^9)} = 0.2085 \text{ rad} = 11.9^\circ \quad \text{Ans.}$$

From *Mechanics of Materials*, Sixth Edition by R. C. Hibbeler, ISBN 0-13-191345-X.

© 2005 R. C. Hibbeler. Published by Pearson Prentice Hall,

Pearson Education, Inc., Upper Saddle River, NJ. All rights reserved.

This material is protected under all copyright laws as they currently exist. No portion of this material may be reproduced, in any form or by any means, without permission in writing from the publisher.

5-45. A shaft is subjected to a torque T . Compare the effectiveness of using the tube shown in the figure with that of a solid section of radius c . To do this, compute the percent increase in torsional stress and angle of twist per unit length for the tube versus the solid section.

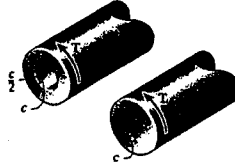

Shear stress :

For the tube,

$$(\tau_t)_{\max} = \frac{Tc}{J_t}$$

For the solid shaft,

$$(\tau_s)_{\max} = \frac{Tc}{J_s}$$

$$\begin{aligned} \text{\% increase in shear stress} &= \frac{(\tau_t)_{\max} - (\tau_s)_{\max}}{(\tau_s)_{\max}} (100) = \frac{\frac{Tc}{J_t} - \frac{Tc}{J_s}}{\frac{Tc}{J_s}} (100) \\ &= \frac{J_s - J_t}{J_t} (100) = \frac{\frac{\pi}{2} c^4 - [\frac{\pi}{2} [c^4 - (\frac{c}{2})^4]]}{\frac{\pi}{2} [c^4 - (\frac{c}{2})^4]} (100) \\ &= 6.67 \% \quad \text{Ans} \end{aligned}$$

Angle of twist :

For the tube,

$$\phi_t = \frac{TL}{J_t(G)}$$

For the shaft,

$$\phi_s = \frac{TL}{J_s(G)}$$

$$\begin{aligned} \text{\% increase in } \phi &= \frac{\phi_t - \phi_s}{\phi_s} (100) = \frac{\frac{TL}{J_t(G)} - \frac{TL}{J_s(G)}}{\frac{TL}{J_s(G)}} (100) \\ &= \frac{J_s - J_t}{J_t} (100) = \frac{\frac{\pi}{2} c^4 - [\frac{\pi}{2} [c^4 - (\frac{c}{2})^4]]}{\frac{\pi}{2} [c^4 - (\frac{c}{2})^4]} (100) \\ &= 6.67 \% \quad \text{Ans} \end{aligned}$$

From *Mechanics of Materials*, Sixth Edition by R. C. Hibbeler, ISBN 0-13-191345-X.

© 2005 R. C. Hibbeler. Published by Pearson Prentice Hall,

Pearson Education, Inc., Upper Saddle River, NJ. All rights reserved.

This material is protected under all copyright laws as they currently exist. No portion of this material may be reproduced, in any form or by any means, without permission in writing from the publisher.

5-46 The solid shaft of radius c is subjected to a torque T at its ends. Show that the maximum shear strain developed in the shaft is $\gamma_{\max} = Tc/JG$. What is the shear strain on an element located at point A , $c/2$ from the center of the shaft? Sketch the strain distortion of this element.

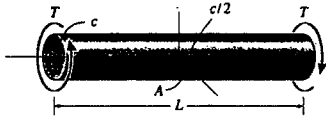

From the geometry :

$$\gamma L = \rho \phi ; \quad \gamma = \frac{\rho \phi}{L}$$

Since $\phi = \frac{TL}{JG}$, then

$$\gamma = \frac{T\rho}{JG} \quad (1)$$

However the maximum shear strain occurs when $\rho = c$

$$\gamma_{\max} = \frac{Tc}{JG} \quad \text{QED}$$

Shear strain when $\rho = \frac{c}{2}$ is from Eq. (1),

$$\gamma = \frac{T(c/2)}{JG} = \frac{Tc}{2JG} \quad \text{Ans}$$

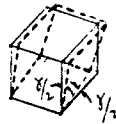
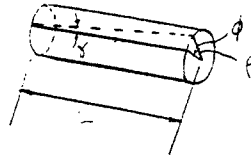

From *Mechanics of Materials*, Sixth Edition by R. C. Hibbeler, ISBN 0-13-191345-X.
 © 2005 R. C. Hibbeler. Published by Pearson Prentice Hall,
 Pearson Education, Inc., Upper Saddle River, NJ. All rights reserved.
 This material is protected under all copyright laws as they currently exist. No portion of this material may be reproduced, in any form or by any means, without permission in writing from the publisher.

5-47 The A-36 steel axle is made from tubes AB and CD and a solid section BC . It is supported on smooth bearings that allow it to rotate freely. If the gears, fixed to its ends, are subjected to $85\text{-N}\cdot\text{m}$ torques, determine the angle of twist of gear A relative to gear D . The tubes have an outer diameter of 30 mm and an inner diameter of 20 mm . The solid section has a diameter of 40 mm .

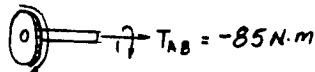
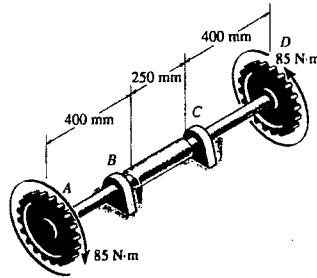

$85\text{ N}\cdot\text{m}$

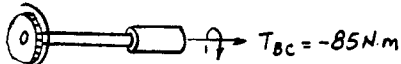

$85\text{ N}\cdot\text{m}$

$$\begin{aligned}\phi_{AD} &= \sum \frac{TL}{JG} \\ &= \frac{2(85)(0.4)}{\frac{\pi}{2}(0.015^4 - 0.01^4)(75)(10^9)} + \frac{(85)(0.25)}{\frac{\pi}{2}(0.02^4)(75)(10^9)} \\ &= 0.01534 \text{ rad} = 0.879^\circ \quad \text{Ans}\end{aligned}$$

From *Mechanics of Materials*, Sixth Edition by R. C. Hibbeler, ISBN 0-13-191345-X.

© 2005 R. C. Hibbeler. Published by Pearson Prentice Hall,

Pearson Education, Inc., Upper Saddle River, NJ. All rights reserved.

This material is protected under all copyright laws as they currently exist. No portion of this material may be reproduced, in any form or by any means, without permission in writing from the publisher.

***5-48** The A-36 steel axle is made from tubes AB and CD and a solid section BC . It is supported on smooth bearings that allow it to rotate freely. If the gears, fixed to its ends, are subjected to $85\text{-N}\cdot\text{m}$ torques, determine the angle of twist of the end B of the solid section relative to end C . The tubes have an outer diameter of 30 mm and an inner diameter of 20 mm . The solid section has a diameter of 40 mm .

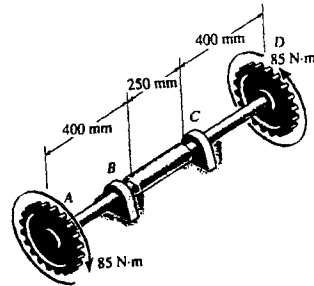

$$\phi_{B/C} = \frac{TL}{JG} = \frac{85(0.250)}{\frac{\pi}{2}(0.020)^4(75)(10^9)} = 0.00113 \text{ rad} = 0.0646^\circ \quad \text{Ans}$$

From *Mechanics of Materials*, Sixth Edition by R. C. Hibbeler, ISBN 0-13-191345-X.

© 2005 R. C. Hibbeler. Published by Pearson Prentice Hall,

Pearson Education, Inc., Upper Saddle River, NJ. All rights reserved.

This material is protected under all copyright laws as they currently exist. No portion of this material may be reproduced, in any form or by any means, without permission in writing from the publisher.

5-49. The splined ends and gears attached to the A-36 steel shaft are subjected to the torques shown. Determine the angle of twist of end B with respect to end A. The shaft has a diameter of 40 mm.

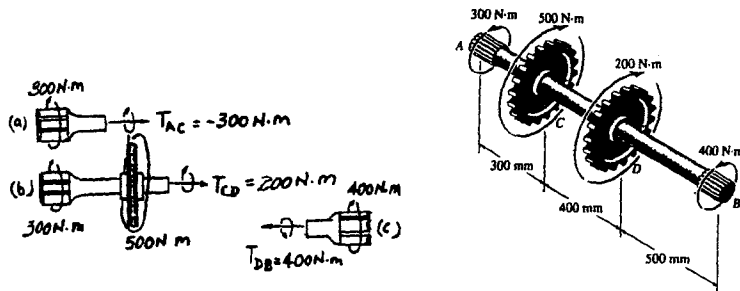

$$\begin{aligned} \phi_{B/A} &= \sum \frac{TL}{JG} = \frac{-300(0.3)}{JG} + \frac{200(0.4)}{JG} + \frac{400(0.5)}{JG} \\ &= \frac{190}{JG} = \frac{190}{\frac{\pi}{2}(0.02^4)(75)(10^9)} \\ &= 0.01008 \text{ rad} = 0.578^\circ \quad \text{Ans} \end{aligned}$$

From *Mechanics of Materials*, Sixth Edition by R. C. Hibbeler, ISBN 0-13-191345-X.

© 2005 R. C. Hibbeler. Published by Pearson Prentice Hall,

Pearson Education, Inc., Upper Saddle River, NJ. All rights reserved.

This material is protected under all copyright laws as they currently exist. No portion of this material may be reproduced, in any form or by any means, without permission in writing from the publisher.

5-50 The splined ends and gears attached to the A-36 steel shaft are subjected to the torques shown. Determine the angle of twist of gear C with respect to gear D. The shaft has a diameter of 40 mm.

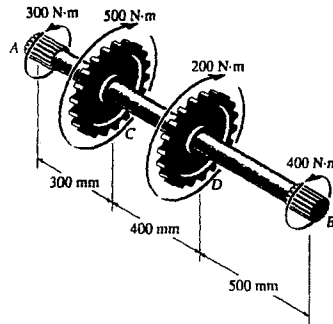
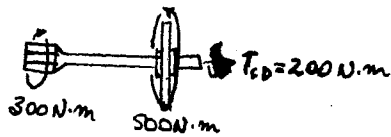

$$\phi_{C/D} = \frac{200(0.4)}{\frac{\pi}{2}(0.02^4)(75)(10^9)}$$

$$= 0.004244 \text{ rad} = 0.243^\circ \quad \text{Ans}$$

From *Mechanics of Materials*, Sixth Edition by R. C. Hibbeler, ISBN 0-13-191345-X.

© 2005 R. C. Hibbeler. Published by Pearson Prentice Hall,

Pearson Education, Inc., Upper Saddle River, NJ. All rights reserved.

This material is protected under all copyright laws as they currently exist. No portion of this material may be reproduced, in any form or by any means, without permission in writing from the publisher.

5-51. The rotating flywheel-and-shaft, when brought to a sudden stop at D , begins to oscillate clockwise-counter-clockwise such that a point A on the outer edge of the flywheel is displaced through a 6-mm arc. Determine the maximum shear stress developed in the tubular A-36 steel shaft due to this oscillation. The shaft has an inner diameter of 24 mm an outer diameter of 32 mm. The bearings at B and C allow the shaft to rotate freely, whereas the support at D holds the shaft fixed.

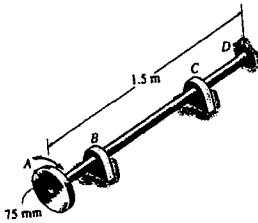

$$s = r \theta$$

$$6 = 75 \phi \quad \phi = 0.08 \text{ rad}$$

$$\phi = \frac{TL}{JG}$$

$$0.08 = \frac{T(1.5)}{J(75)(10^9)}$$

$$T = 4(10^9) J$$

$$\begin{aligned} \tau_{\max} &= \frac{Tc}{J} \\ &= \frac{4(10^9)(J)(0.016)}{J} \\ &= 64.0 \text{ MPa} \quad \text{Ans} \end{aligned}$$



From *Mechanics of Materials*, Sixth Edition by R. C. Hibbeler, ISBN 0-13-191345-X.

© 2005 R. C. Hibbeler. Published by Pearson Prentice Hall,

Pearson Education, Inc., Upper Saddle River, NJ. All rights reserved.

This material is protected under all copyright laws as they currently exist. No portion of this material may be reproduced, in any form or by any means, without permission in writing from the publisher.

***5-52** The 8-mm-diameter A-36 bolt is screwed tightly into a block at *A*. Determine the couple forces *F* that should be applied to the wrench so that the maximum shear stress in the bolt becomes 18 MPa. Also, compute the corresponding displacement of each force *F* needed to cause this stress. Assume that the wrench is rigid.

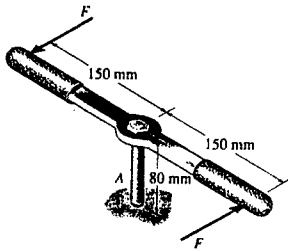

$$T - F(0.3) = 0 \quad (1)$$

$$\tau_{\max} = \frac{Tc}{J}; \quad 18(10^6) = \frac{T(0.004)}{\frac{\pi}{2}(0.004^4)}$$

$$T = 1.8096 \text{ N} \cdot \text{m}$$

From Eq. (1),

$$F = 6.03 \text{ N} \quad \text{Ans}$$

$$\phi = \frac{TL}{JG} = \frac{1.8096(0.08)}{\frac{\pi}{2}[(0.0040)^4]75(10^9)} = 0.00480 \text{ rad}$$

$$s = r\phi = 0.15(0.00480) = 0.00072 \text{ m} = 0.720 \text{ mm} \quad \text{Ans.}$$

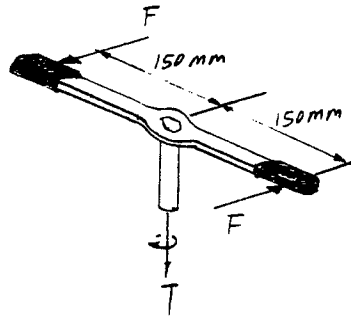

From *Mechanics of Materials*, Sixth Edition by R. C. Hibbeler, ISBN 0-13-191345-X.
 © 2005 R. C. Hibbeler. Published by Pearson Prentice Hall,
 Pearson Education, Inc., Upper Saddle River, NJ. All rights reserved.
 This material is protected under all copyright laws as they currently exist. No portion of this material may be reproduced, in any form or by any means, without permission in writing from the publisher.

5-53 The turbine develops 150 kW of power, which is transmitted to the gears such that C receives 70% and D receives 30%. If the rotation of the 100-mm-diameter A-36 steel shaft is $\omega = 800$ rev/min., determine the absolute maximum shear stress in the shaft and the angle of twist of end E of the shaft relative to B . The journal bearing at E allows the shaft to turn freely about its axis.

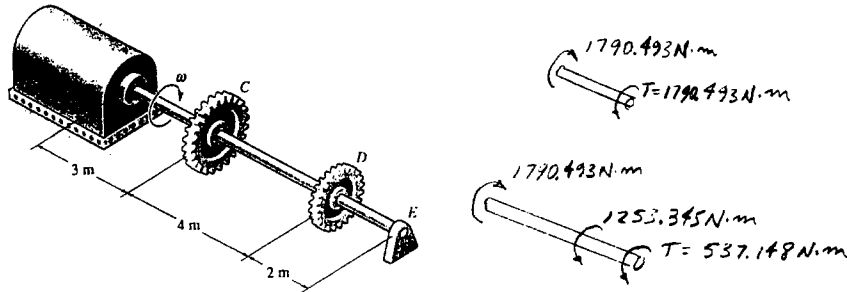

$$P = T\omega; \quad 150(10^3)W = T(800 \frac{\text{rev}}{\text{min}})(\frac{1 \text{ min}}{60 \text{ sec}})(\frac{2\pi \text{ rad}}{1 \text{ rev}})$$

$$T = 1790.493 \text{ N} \cdot \text{m}$$

$$T_C = 1790.493(0.7) = 1253.345 \text{ N} \cdot \text{m}$$

$$T_D = 1790.493(0.3) = 537.148 \text{ N} \cdot \text{m}$$

Maximum torque is in region BC .

$$\tau_{\max} = \frac{T_C}{J} = \frac{1790.493(0.05)}{\frac{\pi}{2}(0.05)^4} = 9.12 \text{ MPa} \quad \text{Ans}$$

$$\begin{aligned} \phi_{E/B} &= \sum \left(\frac{TL}{JG} \right) = \frac{1}{JG} [1790.493(3) + 537.148(4) + 0] \\ &= \frac{7520.171}{\frac{\pi}{2}(0.05)^4(75)(10^9)} = 0.0102 \text{ rad} = 0.585^\circ \quad \text{Ans} \end{aligned}$$

From *Mechanics of Materials*, Sixth Edition by R. C. Hibbeler, ISBN 0-13-191345-X.

© 2005 R. C. Hibbeler. Published by Pearson Prentice Hall,

Pearson Education, Inc., Upper Saddle River, NJ. All rights reserved.

This material is protected under all copyright laws as they currently exist. No portion of this material may be reproduced, in any form or by any means, without permission in writing from the publisher.

5-54 The turbine develops 150 kW of power, which is transmitted to the gears such that both *C* and *D* receive an equal amount. If the rotation of the 100-mm-diameter A-36 steel shaft is $\omega = 500$ rev/min., determine the absolute maximum shear stress in the shaft and the rotation of end *B* of the shaft relative to *E*. The journal bearing at *C* allows the shaft to turn freely about its axis.

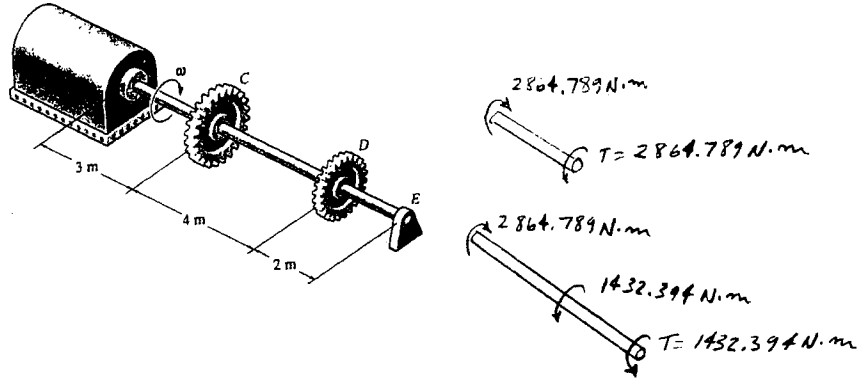

$$P = T\omega; \quad 150(10^3)W = T(500 \frac{\text{rev}}{\text{min}})(\frac{1 \text{ min}}{60 \text{ sec}})(\frac{2\pi \text{ rad}}{1 \text{ rev}})$$

$$T = 2864.789 \text{ N} \cdot \text{m}$$

$$T_C = T_D = \frac{T}{2} = 1432.394 \text{ N} \cdot \text{m}$$

Maximum torque is in region *BC*.

$$\tau_{\text{max}} = \frac{T_C}{J} = \frac{2864.789(0.05)}{\frac{\pi}{2}(0.05)^4} = 14.6 \text{ MPa} \quad \text{Ans}$$

$$\begin{aligned} \phi_{E/B} &= \Sigma\left(\frac{TL}{JG}\right) = \frac{1}{JG}[2864.789(3) + 1432.394(4) + 0] \\ &= \frac{14323.945}{\frac{\pi}{2}(0.05)^4(75)(10^9)} = 0.0195 \text{ rad} = 1.11^\circ \quad \text{Ans} \end{aligned}$$

From *Mechanics of Materials*, Sixth Edition by R. C. Hibbeler, ISBN 0-13-191345-X.

© 2005 R. C. Hibbeler. Published by Pearson Prentice Hall,

Pearson Education, Inc., Upper Saddle River, NJ. All rights reserved.

This material is protected under all copyright laws as they currently exist. No portion of this material may be reproduced, in any form or by any means, without permission in writing from the publisher.

5-55. The A-36 hollow steel shaft is 2 m long and has an outer diameter of 40 mm. When it is rotating at 80 rad/s, it transmits 32 kW of power from the engine *E* to the generator *G*. Determine the smallest thickness of the shaft if the allowable shear stress is $\tau_{\text{allow}} = 140 \text{ MPa}$ and the shaft is restricted not to twist more than 0.05 rad.



$$P = T\omega$$

$$32(10^3) = T(80)$$

$$T = 400 \text{ N} \cdot \text{m}$$

Shear stress failure

$$\tau = \frac{Tc}{J}$$

$$\tau_{\text{allow}} = 140(10^6) = \frac{400(0.02)}{\frac{\pi}{2}(0.02^4 - r_i^4)}$$

$$r_i = 0.01875 \text{ m}$$

Angle of twist limitation :

$$\phi = \frac{TL}{JG}$$

$$0.05 = \frac{400(2)}{\frac{\pi}{2}(0.02^4 - r_i^4)(75)(10^9)}$$

$$r_i = 0.01247 \text{ m (controls)}$$

$$t = r_o - r_i = 0.02 - 0.01247$$

$$= 0.00753 \text{ m}$$

From *Mechanics of Materials*, Sixth Edition by R. C. Hibbeler, ISBN 0-13-191345-X.

© 2005 R. C. Hibbeler. Published by Pearson Prentice Hall,

Pearson Education, Inc., Upper Saddle River, NJ. All rights reserved.

This material is protected under all copyright laws as they currently exist. No portion of this material may be reproduced, in any form or by any means, without permission in writing from the publisher.

***5-56.** The A-36 solid steel shaft is 3 m long and has a diameter of 50 mm. It is required to transmit 35 kW of power from the engine *E* to the generator *G*. Determine the smallest angular velocity the shaft can have if it is restricted not to twist more than 1°.



$$\phi = \frac{TL}{JG}$$

$$\frac{1^\circ(\pi)}{180^\circ} = \frac{T(3)}{\frac{\pi}{2}(0.025^4)(75)(10^9)}$$

$$T = 267.73 \text{ N} \cdot \text{m}$$

$$P = T\omega$$

$$35(10^3) = 267.73(\omega)$$

$$\omega = 131 \text{ rad/s} \quad \text{Ans}$$

From *Mechanics of Materials*, Sixth Edition by R. C. Hibbeler, ISBN 0-13-191345-X.

© 2005 R. C. Hibbeler. Published by Pearson Prentice Hall,

Pearson Education, Inc., Upper Saddle River, NJ. All rights reserved.

This material is protected under all copyright laws as they currently exist. No portion of this material may be reproduced, in any form or by any means, without permission in writing from the publisher.

5-57 The motor produces a torque of $T = 20 \text{ N} \cdot \text{m}$ on gear A. If gear C is suddenly locked so it does not turn, yet B can freely turn, determine the angle of twist of F with respect to E and F with respect to D of the L2-steel shaft, which has an inner diameter of 30 mm and an outer diameter of 50 mm. Also, calculate the absolute maximum shear stress in the shaft. The shaft is supported on journal bearings at G and H.

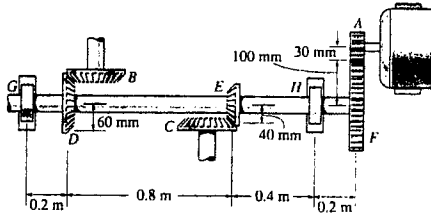

$$F(0.03) = 20$$

$$F = 666.67 \text{ N}$$

$$T' = (666.67)(0.1) = 66.67 \text{ N} \cdot \text{m}$$

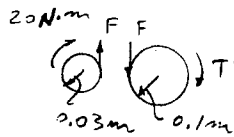

Since shaft is held fixed at C, the torque is only in region EF of the shaft.

$$\phi_{F/E} = \frac{TL}{JG} = \frac{66.67(0.6)}{\frac{\pi}{2}[(0.025)^4 - (0.015)^4]75(10^9)} = 0.999(10)^{-3} \text{ rad} \quad \text{Ans.}$$

Since the torque in region ED is zero,

$$\phi_{F/D} = 0.999(10)^{-3} \text{ rad} \quad \text{Ans}$$

$$\tau_{\max} = \frac{Tc}{J} = \frac{66.67(0.025)}{\frac{\pi}{2}[(0.025)^4 - (0.015)^4]} = 3.12 \text{ MPa} \quad \text{Ans}$$

From *Mechanics of Materials*, Sixth Edition by R. C. Hibbeler, ISBN 0-13-191345-X.

© 2005 R. C. Hibbeler. Published by Pearson Prentice Hall,

Pearson Education, Inc., Upper Saddle River, NJ. All rights reserved.

This material is protected under all copyright laws as they currently exist. No portion of this material may be reproduced, in any form or by any means, without permission in writing from the publisher.

5-58 The engine of the helicopter is delivering 600 hp to the rotor shaft AB when the blade is rotating at 1200 rev/min. Determine to the nearest $\frac{1}{8}$ in. the diameter of the shaft AB if the allowable shear stress is $\tau_{\text{allow}} = 8$ ksi and the vibrations limit the angle of twist of the shaft to 0.05 rad. The shaft is 2 ft long and made from 1.2 steel.

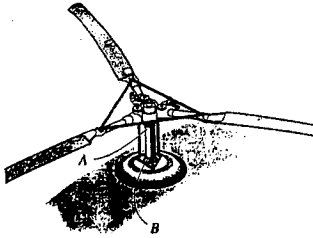

$$\omega = \frac{1200(2)(\pi)}{60} = 125.66 \text{ rad/s}$$

$$P = T\omega$$

$$600(550) = T(125.66)$$

$$T = 2626.06 \text{ lb} \cdot \text{ft}$$

Shear - stress failure

$$\tau_{\text{allow}} = \frac{Tc}{J}$$

$$8(10^3) = \frac{2626.06(12)c}{\frac{\pi}{2}c^4}$$

$$c = 1.3586 \text{ in.}$$

Angle of twist limitation

$$\phi = \frac{TL}{JG}$$

$$0.05 = \frac{2626.06(12)(2)(12)}{\frac{\pi}{2}c^4(11.0)(10^6)}$$

$$c = 0.967 \text{ in.}$$

Shear - stress failure controls the design.

$$d = 2c = 2(1.3586) = 2.72 \text{ in.}$$

Use $d = 2.75$ in. **Ans**

From *Mechanics of Materials*, Sixth Edition by R. C. Hibbeler, ISBN 0-13-191345-X.

© 2005 R. C. Hibbeler. Published by Pearson Prentice Hall,

Pearson Education, Inc., Upper Saddle River, NJ. All rights reserved.

This material is protected under all copyright laws as they currently exist. No portion of this material may be reproduced, in any form or by any means, without permission in writing from the publisher.

5-59 The engine of the helicopter is delivering 600 hp to the rotor shaft AB when the blade is rotating at 1200 rev/min. Determine to the nearest $\frac{1}{8}$ in. the diameter of the shaft AB if the allowable shear stress is $\tau_{\text{allow}} = 10.5$ ksi and the vibrations limit the angle of twist of the shaft to 0.05 rad. The shaft is 2 ft long and made from 1.2 steel.

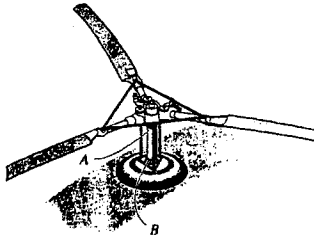

$$\omega = \frac{1200(2)(\pi)}{60} = 125.66 \text{ rad/s}$$

$$P = T\omega$$

$$600(550) = T(125.66)$$

$$T = 2626.06 \text{ lb} \cdot \text{ft}$$

Shear - stress failure

$$\tau_{\text{allow}} = 10.5(10)^3 = \frac{2626.06(12)c}{\frac{\pi}{2}c^4}$$

$$c = 1.2408 \text{ in.}$$

Angle of twist limitation

$$\phi = \frac{TL}{JG}$$

$$0.05 = \frac{2626.06(12)(2)(12)}{\frac{\pi}{2}c^4(11.0)(10^6)}$$

$$c = 0.967 \text{ in.}$$

Shear stress failure controls the design

$$d = 2c = 2(1.2408) = 2.48 \text{ in.}$$

Use $d = 2.50$ in. **Ans**

From *Mechanics of Materials*, Sixth Edition by R. C. Hibbeler, ISBN 0-13-191345-X.

© 2005 R. C. Hibbeler. Published by Pearson Prentice Hall,

Pearson Education, Inc., Upper Saddle River, NJ. All rights reserved.

This material is protected under all copyright laws as they currently exist. No portion of this material may be reproduced, in any form or by any means, without permission in writing from the publisher.

Because of the number and variety of potential correct solutions to this problem, no solution is being given.

From *Mechanics of Materials*, Sixth Edition by R. C. Hibbeler, ISBN 0-13-191345-X.

© 2005 R. C. Hibbeler. Published by Pearson Prentice Hall,

Pearson Education, Inc, Upper Saddle River, NJ. All rights reserved.

This material is protected under all copyright laws as they currently exist. No portion of this material may be reproduced, in any form or by any means, without permission in writing from the publisher.

5-61. The A-36 steel assembly consists of a tube having an outer radius of 1 in. and a wall thickness of 0.125 in. Using a rigid plate at B , it is connected to the solid 1-in-diameter shaft AB . Determine the rotation of the tube's end C if a torque of 200 lb·in. is applied to the tube at this end. The end A of the shaft is fixed-supported.

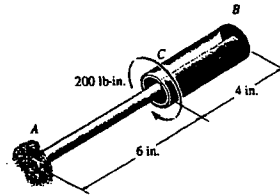

$$\phi_B = \frac{T_{AB}L}{JG} = \frac{200(10)}{\frac{\pi}{2}(0.5)^4(11.0)(10^6)} = 0.001852 \text{ rad}$$

$$\phi_{C/B} = \frac{T_{CB}L}{JG} = \frac{-200(4)}{\frac{\pi}{2}(1^4 - 0.875^4)(11.0)(10^6)} = -0.0001119 \text{ rad}$$

$$\begin{aligned} \phi_C &= \phi_B + \phi_{C/B} \\ &= 0.001852 + 0.0001119 \\ &= 0.001964 \text{ rad} = 0.113^\circ \end{aligned} \quad \text{Ans}$$

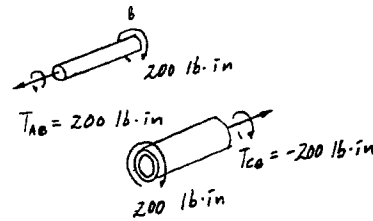

From *Mechanics of Materials*, Sixth Edition by R. C. Hibbeler, ISBN 0-13-191345-X.

© 2005 R. C. Hibbeler. Published by Pearson Prentice Hall,

Pearson Education, Inc., Upper Saddle River, NJ. All rights reserved.

This material is protected under all copyright laws as they currently exist. No portion of this material may be reproduced, in any form or by any means, without permission in writing from the publisher.

5-62. The 6-in.-diameter L-2 steel shaft on the turbine is supported on journal bearings at *A* and *B*. If *C* is held fixed and the turbine blades create a torque on the shaft that increases linearly from zero at *C* to 2000 lb·ft at *D*, determine the angle of twist of the shaft of end *D* relative to end *C*. Also, compute the absolute maximum shear stress in the shaft. Neglect the size of the blades.

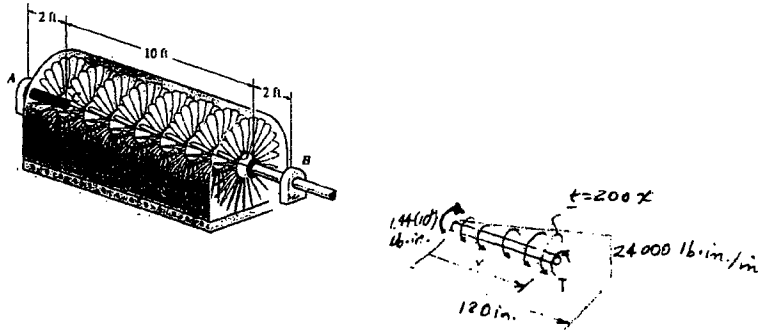

$$T_{max} = \frac{1}{2}(120)(200(120)) = 1.44(10^6)$$

$$T = 1.44(10^6) - \frac{1}{2}(x)(200x) = 1.44(10^6) - 100x^2$$

$$\begin{aligned} \phi_{D/C} &= \int \frac{T dx}{JG} = \frac{1}{JG} \int_0^{120} 1.44(10^6) dx - 100x^2 dx \\ &= \frac{1.44(10^6)(120)}{\pi \frac{(3)^4}{2} (11.0(10^6))} - \frac{100(120)^3}{3(\pi \frac{(3)^4}{2} (11.0(10^6)))} = 0.0823 \text{ rad} \quad \text{Ans} \end{aligned}$$

Maximum torque occurs at $x = 0$

$$\tau_{abs} = \frac{T_C}{J} = \frac{1.44(10^6)(3)}{\pi \frac{(3)^4}{2}} = 34.0 \text{ ksi} \quad \text{Ans}$$

From *Mechanics of Materials*, Sixth Edition by R. C. Hibbeler, ISBN 0-13-191345-X.

© 2005 R. C. Hibbeler. Published by Pearson Prentice Hall,

Pearson Education, Inc., Upper Saddle River, NJ. All rights reserved.

This material is protected under all copyright laws as they currently exist. No portion of this material may be reproduced, in any form or by any means, without permission in writing from the publisher.

5-63 When drilling a well, the deep end of the drill pipe is assumed to encounter a torsional resistance T_A . Furthermore, soil friction along the sides of the pipe creates a linear distribution of torque per unit length, varying from zero at the surface B to t_0 at A . Determine the necessary torque T_B that must be supplied by the drive unit to turn the pipe. Also, what is the relative angle of twist of one end of the pipe with respect to the other end at the instant the pipe is about to turn? The pipe has an outer radius r_o and an inner radius r_i . The shear modulus is G .

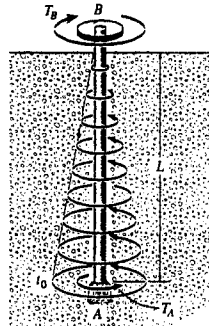

$$\frac{1}{2} t_0 L + T_A - T_B = 0$$

$$T_B = \frac{t_0 L + 2T_A}{2} \quad \text{Ans}$$

$$T(x) + \frac{t_0 x^2}{2L} - \frac{t_0 L + 2T_A}{2} = 0$$

$$T(x) = \frac{t_0 L + 2T_A}{2} - \frac{t_0 x^2}{2L}$$

$$\phi = \int \frac{T(x) dx}{JG}$$

$$= \frac{1}{JG} \int_0^L \left(\frac{t_0 L + 2T_A}{2} - \frac{t_0 x^2}{2L} \right) dx$$

$$= \frac{1}{JG} \left[\frac{t_0 L + 2T_A}{2} x - \frac{t_0 x^3}{6L} \right]_0^L$$

$$= \frac{t_0 L^2 + 3T_A L}{3JG}$$

However, $J = \frac{\pi}{2}(r_o^4 - r_i^4)$

$$\phi = \frac{2L(t_0 L + 3T_A)}{3\pi(r_o^4 - r_i^4)G} \quad \text{Ans}$$

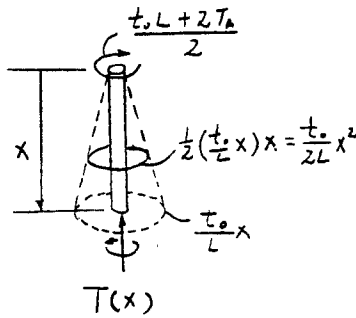
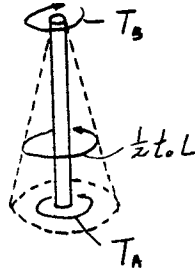

From *Mechanics of Materials*, Sixth Edition by R. C. Hibbeler, ISBN 0-13-191345-X.
 © 2005 R. C. Hibbeler. Published by Pearson Prentice Hall,
 Pearson Education, Inc., Upper Saddle River, NJ. All rights reserved.
 This material is protected under all copyright laws as they currently exist. No portion of this material may be reproduced, in any form or by any means, without permission in writing from the publisher.

*5-64 The A-36 steel posts are “drilled” at constant angular speed into the soil using the rotary installer. If the post has an inner diameter of 200 mm and an outer diameter of 225 mm, determine the relative angle of twist of end A of the post with respect to end B when the post reaches the depth indicated. Due to soil friction, assume the torque along the post varies linearly as shown, and a concentrated torque of 80 kN · m acts at the bit.

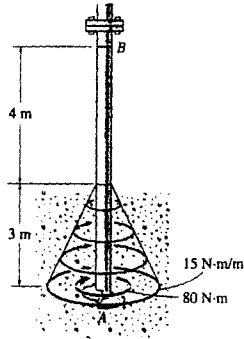

$$\Sigma M_z = 0; \quad T_B - 80 - \frac{1}{2}(15)(3) = 0$$

$$T_B = 102.5 \text{ kN} \cdot \text{m}$$

$$\Sigma M_z = 0; \quad 102.5 - \frac{1}{2}(5z)(z) - T = 0$$

$$T = (102.5 - 2.5z^2) \text{ kN} \cdot \text{m}$$

$$\phi_{AB} = \frac{TL}{JG} + \int \frac{T dz}{JG}$$

$$= \frac{102.5(10^3)(4)}{\frac{\pi}{2}((0.1125)^4 - (0.1)^4)(75)(10^9)} + \int_0^3 \frac{(102.5 - 2.5z^2)(10^3) dz}{\frac{\pi}{2}((0.1125)^4 - (0.1)^4)(75)(10^9)}$$

$$= 0.0980 \text{ rad} \quad \text{Ans}$$

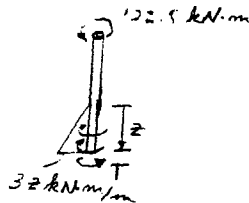
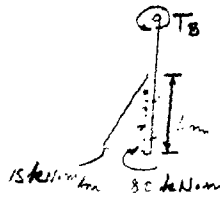

From *Mechanics of Materials*, Sixth Edition by R. C. Hibbeler, ISBN 0-13-191345-X.

© 2005 R. C. Hibbeler. Published by Pearson Prentice Hall,

Pearson Education, Inc., Upper Saddle River, NJ. All rights reserved.

This material is protected under all copyright laws as they currently exist. No portion of this material may be reproduced, in any form or by any means, without permission in writing from the publisher.

5-65. The device shown is used to mix soils in order to provide in-situ stabilization. If the mixer is connected to an A-36 steel tubular shaft that has an inner diameter of 3 in. and an outer diameter of 4.5 in, determine the angle of twist of the shaft of *A* relative to *B* and the absolute maximum shear stress in the shaft if each mixing blade is subjected to the torques shown.

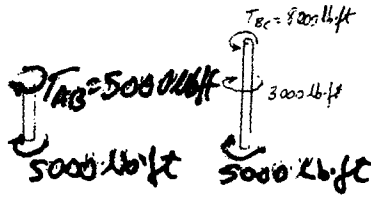
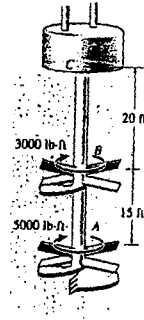

$$\phi_{A/B} = \frac{TL}{JG} = \frac{5000(12)(15)(12)}{\frac{\pi}{2}[(2.25)^4 - (1.5)^4]11(10^6)} = 0.03039 \text{ rad} = 1.74^\circ \text{ Ans.}$$

$$\tau_{\max} = \frac{Tc}{J} = \frac{8000(12)(2.25)}{\frac{\pi}{2}[(2.25)^4 - (1.5)^4]} = 6.69 \text{ ksi} \quad \text{Ans.}$$

From *Mechanics of Materials*, Sixth Edition by R. C. Hibbeler, ISBN 0-13-191345-X.

© 2005 R. C. Hibbeler. Published by Pearson Prentice Hall,

Pearson Education, Inc., Upper Saddle River, NJ. All rights reserved.

This material is protected under all copyright laws as they currently exist. No portion of this material may be reproduced, in any form or by any means, without permission in writing from the publisher.

5-66 The device shown is used to mix soils in order to provide in-situ stabilization. If the mixer is connected to an A-36 steel tubular shaft that has an inner diameter of 3 in. and an outer diameter of 4.5 in., determine the angle of twist of the shaft of A relative to C if each mixing blade is subjected to the torques shown.

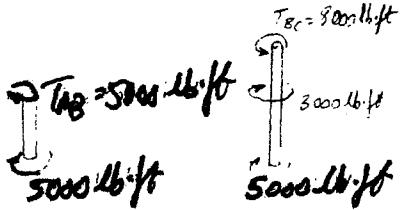
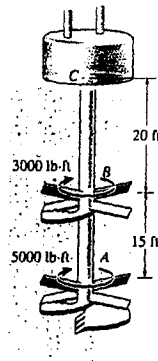

$$\phi_{AC} = \Sigma \left(\frac{TL}{JG} \right) = \frac{5000(12)(15)(12)}{\frac{\pi}{2}((2.25)^4 - (1.5)^4)(11)(10^6)} + \frac{8000(12)(20)(12)}{\frac{\pi}{2}((2.25)^4 - (1.5)^4)(11)(10^6)}$$

$$= 0.0952 \text{ rad} = 5.45^\circ \quad \text{Ans}$$

From *Mechanics of Materials*, Sixth Edition by R. C. Hibbeler, ISBN 0-13-191345-X.

© 2005 R. C. Hibbeler. Published by Pearson Prentice Hall,

Pearson Education, Inc., Upper Saddle River, NJ. All rights reserved.

This material is protected under all copyright laws as they currently exist. No portion of this material may be reproduced, in any form or by any means, without permission in writing from the publisher.

5-67 The shaft has a radius c and is subjected to a torque per unit length of t_0 , which is distributed uniformly over the shaft's entire length L . If it is fixed at its far end A , determine the angle of twist ϕ of end B . The shear modulus is G .

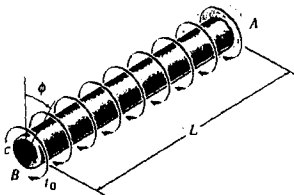

$$\begin{aligned}\phi &= \int \frac{T(x) dx}{JG} = \frac{-t_0}{JG} \int_0^L x dx \\ &= \frac{-t_0}{JG} \left[\frac{x^2}{2} \right]_0^L = \frac{-t_0}{JG} \frac{L^2}{2} \\ &= \frac{-t_0 L^2}{2JG}\end{aligned}$$

However, $J = \frac{\pi c^4}{2}$

$$\phi = \frac{-t_0 L^2}{\pi c^4 G} = \frac{t_0 L^2}{\pi c^4 G} \quad \text{Ans}$$

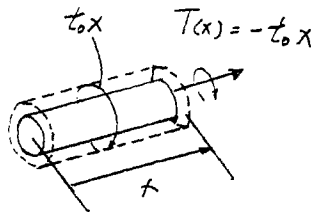

From *Mechanics of Materials*, Sixth Edition by R. C. Hibbeler, ISBN 0-13-191345-X.

© 2005 R. C. Hibbeler. Published by Pearson Prentice Hall,

Pearson Education, Inc., Upper Saddle River, NJ. All rights reserved.

This material is protected under all copyright laws as they currently exist. No portion of this material may be reproduced, in any form or by any means, without permission in writing from the publisher.

*5-68 The A-36 bolt is tightened within a hole so that the reactive torque on the shank AB can be expressed by the equation $t = (kx^2) \text{ N} \cdot \text{m/m}$, where x is in meters. If a torque of $T = 50 \text{ N} \cdot \text{m}$ is applied to the bolt head, determine the constant k and the amount of twist in the 50-mm length of the shank. Assume the shank has a constant radius of 4 mm.

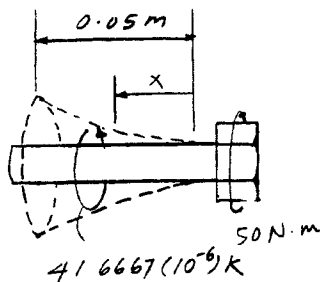
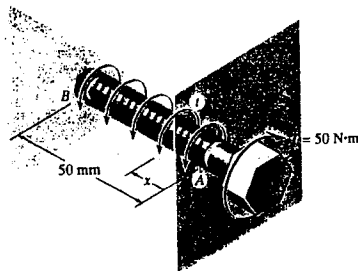

$$dT = t dx$$

$$T = \int_0^{0.05 \text{ m}} kx^2 dx = k \frac{x^3}{3} \Big|_0^{0.05} = 41.6667(10^{-6}) k$$

$$50 - 41.6667(10^{-6}) k = 0$$

$$k = 1.20(10^6) \text{ N/m}^2 \quad \text{Ans}$$

$$\text{In the general position, } T = \int_0^x 1.20(10^6)x^2 dx = 0.4(10^6)x^3$$

$$\phi = \int \frac{T(x) dx}{JG} = \frac{1}{JG} \int_0^{0.05 \text{ m}} [50 - 0.4(10^6)x^3] dx$$

$$= \frac{1}{JG} \left[50x - \frac{0.4(10^6)x^4}{4} \right] \Big|_0^{0.05 \text{ m}}$$

$$= \frac{1.875}{JG} = \frac{1.875}{\frac{\pi}{2}(0.004^4)(75)(10^9)}$$

$$= 0.06217 \text{ rad} = 3.56^\circ \quad \text{Ans}$$

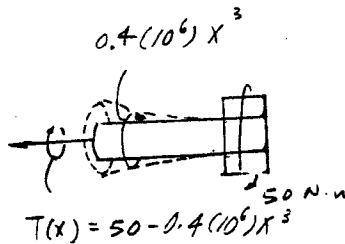

From *Mechanics of Materials*, Sixth Edition by R. C. Hibbeler, ISBN 0-13-191345-X.

© 2005 R. C. Hibbeler. Published by Pearson Prentice Hall,

Pearson Education, Inc., Upper Saddle River, NJ. All rights reserved.

This material is protected under all copyright laws as they currently exist. No portion of this material may be reproduced, in any form or by any means, without permission in writing from the publisher.

5-69 Solve Prob. 5-68 if the distributed torque is $t = (kx^{2/3})$ N · m/m.

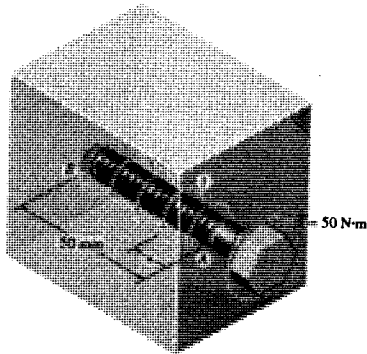

$$dT = t dx$$

$$T = \int_0^{0.05} kx^{2/3} dx = k \frac{3}{5} x^{5/3} \Big|_0^{0.05} = (4.0716)(10^{-3}) k$$

$$50 - 4.0716(10^{-3}) k = 0$$

$$k = 12.28(10^3) \quad \text{Ans}$$

In the general position,

$$T = \int_0^x 12.28(10^3)x^{2/3} dx = 7.368(10^3)x^{5/3}$$

Angle of twist :

$$\phi = \int \frac{T(x) dx}{JG} = \frac{1}{JG} \int_0^{0.05 \text{ m}} [50 - 7.368(10^3)x^{5/3}] dx$$

$$= \frac{1}{JG} [50x - 7.368(10^3) \left(\frac{3}{8}\right)x^{8/3}] \Big|_0^{0.05 \text{ m}}$$

$$= \frac{1.5625}{\frac{\pi}{2}(0.004^4)(75)(10^9)} = 0.0518 \text{ rad} = 2.97^\circ \quad \text{Ans}$$

From *Mechanics of Materials*, Sixth Edition by R. C. Hibbeler, ISBN 0-13-191345-X.

© 2005 R. C. Hibbeler. Published by Pearson Prentice Hall,

Pearson Education, Inc., Upper Saddle River, NJ. All rights reserved.

This material is protected under all copyright laws as they currently exist. No portion of this material may be reproduced, in any form or by any means, without permission in writing from the publisher.

5-70. The shaft of radius c is subjected to a distributed torque t , measured as torque/length of shaft. Determine the angle of twist at end A. The shear modulus is G .

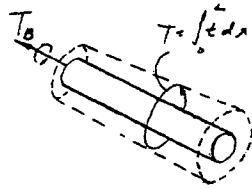
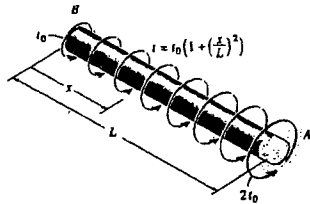

$$T_B - \int t dx = 0$$

$$T_B = \int t dx = t_0 \int \left(1 + \frac{x^2}{L^2}\right) dx$$

$$= t_0 \left[x + \frac{x^3}{3L^2} \right]_0^L = t_0 \left(L + \frac{L}{3} \right) = \frac{4}{3} t_0 L$$

$$T_B = \frac{4}{3} t_0 L$$

$$\phi = \int \frac{T(x) dx}{JG}$$

$$= \frac{1}{JG} \int_0^L \left[\frac{4}{3} t_0 L - t_0 \left(x + \frac{x^3}{3L^2} \right) \right] dx$$

$$= \frac{t_0}{JG} \left[\frac{4}{3} Lx - \left(\frac{x^2}{2} + \frac{x^4}{12L^2} \right) \right]_0^L = \frac{7 t_0 L^2}{12 JG}$$

$$T(x) = \frac{4}{3} t_0 L - t_0 \left(x + \frac{x^3}{3L^2} \right)$$

However $J = \frac{\pi}{2} c^4$,

$$\phi = \frac{7 t_0 L^2}{6 \pi c^4 G} \quad \text{Ans}$$

From *Mechanics of Materials*, Sixth Edition by R. C. Hibbeler, ISBN 0-13-191345-X.

© 2005 R. C. Hibbeler. Published by Pearson Prentice Hall,

Pearson Education, Inc., Upper Saddle River, NJ. All rights reserved.

This material is protected under all copyright laws as they currently exist. No portion of this material may be reproduced, in any form or by any means, without permission in writing from the publisher.

5-71 The contour of the surface of the shaft is defined by the equation $y = e^{ax}$, where a is a constant. If the shaft is subjected to a torque T at its ends, determine the angle of twist of end A with respect to end B . The shear modulus is G .

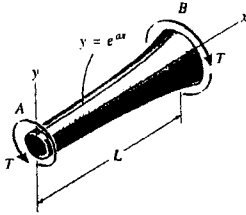

$$\begin{aligned} \phi &= \int \frac{T dx}{J(x)G} \quad \text{where, } J(x) = \frac{\pi}{2}(e^{ax})^4 \\ &= \frac{2T}{\pi G} \int_0^L \frac{dx}{e^{4ax}} = \frac{2T}{\pi G} \left[-\frac{1}{4a e^{4ax}} \right]_0^L \\ &= \frac{2T}{\pi G} \left[-\frac{1}{4a e^{4aL}} + \frac{1}{4a} \right] = \frac{T}{2a\pi G} \left[\frac{e^{4aL} - 1}{e^{4aL}} \right] \\ &= \frac{T}{2a\pi G} [1 - e^{-4aL}] \quad \text{Ans} \end{aligned}$$

From *Mechanics of Materials*, Sixth Edition by R. C. Hibbeler, ISBN 0-13-191345-X.

© 2005 R. C. Hibbeler. Published by Pearson Prentice Hall,

Pearson Education, Inc., Upper Saddle River, NJ. All rights reserved.

This material is protected under all copyright laws as they currently exist. No portion of this material may be reproduced, in any form or by any means, without permission in writing from the publisher.

***5-72** A cylindrical spring consists of a rubber annulus bonded to a rigid ring and shaft. If the ring is held fixed and a torque T is applied to the rigid shaft, determine the angle of twist of the shaft. The shear modulus of the rubber is G .
Hint: As shown in the figure, the deformation of the element at radius r can be determined from $r d\theta = dr \gamma$. Use this expression along with $\tau = T/(2\pi r^2 h)$, from Prob. 5-28, to obtain the result.

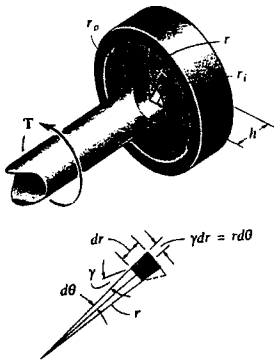

$$r d\theta = \gamma dr$$

$$d\theta = \frac{\gamma dr}{r} \quad (1)$$

From Prob. 5-28,

$$\tau = \frac{T}{2\pi r^2 h} \quad \text{and} \quad \gamma = \frac{\tau}{G}$$

$$\gamma = \frac{T}{2\pi r^2 h G}$$

From (1),

$$d\theta = \frac{T}{2\pi h G} \frac{dr}{r^3}$$

$$\theta = \frac{T}{2\pi h G} \int_{r_i}^{r_o} \frac{dr}{r^3} = \frac{T}{2\pi h G} \left[-\frac{1}{2r^2} \right]_{r_i}^{r_o}$$

$$= \frac{T}{2\pi h G} \left[-\frac{1}{2r_o^2} + \frac{1}{2r_i^2} \right]$$

$$= \frac{T}{4\pi h G} \left[\frac{1}{r_i^2} - \frac{1}{r_o^2} \right] \quad \text{Ans}$$

From *Mechanics of Materials*, Sixth Edition by R. C. Hibbeler, ISBN 0-13-191345-X.

© 2005 R. C. Hibbeler. Published by Pearson Prentice Hall,

Pearson Education, Inc., Upper Saddle River, NJ. All rights reserved.

This material is protected under all copyright laws as they currently exist. No portion of this material may be reproduced, in any form or by any means, without permission in writing from the publisher.

5-73. The steel shaft has a diameter of 40 mm and is fixed at its ends *A* and *B*. If it is subjected to the couple, determine the maximum shear stress in regions *AC* and *CB* of the shaft. $G_{st} = 10.8(10^3)$ ksi.

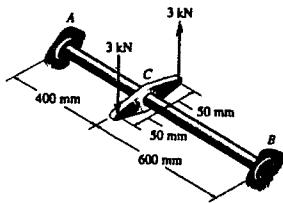

Equilibrium :

$$T_A + T_B - 3000(0.1) = 0 \quad (1)$$

Compatibility condition :

$$\phi_{C/A} = \phi_{C/B}$$

$$\frac{T_A(400)}{JG} = \frac{T_B(600)}{JG}$$

$$T_A = 1.5 T_B \quad (2)$$

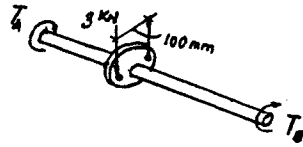

Solving Eqs (1) and (2) yields :

$$T_B = 120 \text{ N} \cdot \text{m}$$

$$T_A = 180 \text{ N} \cdot \text{m}$$

$$(\tau_{AC})_{\max} = \frac{T_C}{J} = \frac{180(0.02)}{\frac{\pi}{2}(0.02^4)} = 14.3 \text{ MPa} \quad \text{Ans}$$

$$(\tau_{CB})_{\max} = \frac{T_C}{J} = \frac{120(0.02)}{\frac{\pi}{2}(0.02^4)} = 9.55 \text{ MPa} \quad \text{Ans}$$

From *Mechanics of Materials*, Sixth Edition by R. C. Hibbeler, ISBN 0-13-191345-X.

© 2005 R. C. Hibbeler. Published by Pearson Prentice Hall,

Pearson Education, Inc., Upper Saddle River, NJ. All rights reserved.

This material is protected under all copyright laws as they currently exist. No portion of this material may be reproduced, in any form or by any means, without permission in writing from the publisher.

5-74 A rod is made from two segments: AB is steel and BC is brass. It is fixed at its ends and subjected to a torque of $T = 680 \text{ N} \cdot \text{m}$. If the steel portion has a diameter of 30 mm, determine the required diameter of the brass portion so the reactions at the walls will be the same. $G_{st} = 75 \text{ GPa}$, $G_{br} = 39 \text{ GPa}$.

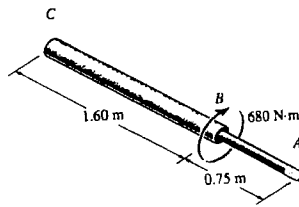

Compatibility condition :

$$\phi_{B/C} = \phi_{B/A}$$

$$\frac{T(1.60)}{\frac{\pi}{2}(c^4)(39)(10^9)} = \frac{T(0.75)}{\frac{\pi}{2}(0.015^4)(75)(10^9)}$$

$$c = 0.02134 \text{ m}$$

$$d = 2c = 0.04269 \text{ m} = 42.7 \text{ mm} \quad \text{Ans}$$

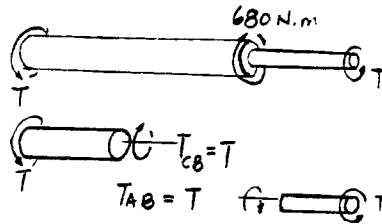

From *Mechanics of Materials*, Sixth Edition by R. C. Hibbeler, ISBN 0-13-191345-X.

© 2005 R. C. Hibbeler. Published by Pearson Prentice Hall,

Pearson Education, Inc., Upper Saddle River, NJ. All rights reserved.

This material is protected under all copyright laws as they currently exist. No portion of this material may be reproduced, in any form or by any means, without permission in writing from the publisher.

5-75 Determine the absolute maximum shear stress in the shaft of Prob. 5-74.

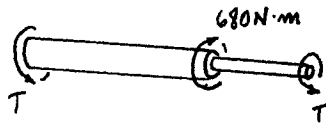
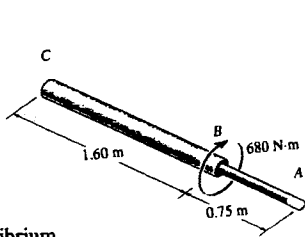

Equilibrium,

$$2T = 680$$

$$T = 340 \text{ N} \cdot \text{m}$$

$\tau_{\text{abs max}}$ occurs in the steel. See solution to Prob. 5-74.

$$\tau_{\text{abs max}} = \frac{Tc}{J} = \frac{340(0.015)}{\frac{\pi}{2}(0.015)^4}$$

$$= 64.1 \text{ MPa} \quad \text{Ans}$$

From *Mechanics of Materials*, Sixth Edition by R. C. Hibbeler, ISBN 0-13-191345-X.

© 2005 R. C. Hibbeler. Published by Pearson Prentice Hall,

Pearson Education, Inc., Upper Saddle River, NJ. All rights reserved.

This material is protected under all copyright laws as they currently exist. No portion of this material may be reproduced, in any form or by any means, without permission in writing from the publisher.

*5-76. The steel shaft is made from two segments: AC has a diameter of 0.5 in, and CB has a diameter of 1 in. If it is fixed at its ends A and B and subjected to a torque of 500 lb · ft, determine the maximum shear stress in the shaft.
 $G_{st} = 10.8(10^3)$ ksi.

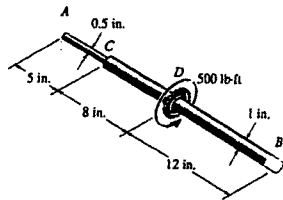

Equilibrium :

$$T_A + T_B - 500 = 0 \quad (1)$$

Compatibility condition :

$$\frac{\phi_{D/A} = \phi_{D/B}}{\frac{T_A(5)}{\frac{\pi}{2}(0.25^4)G} + \frac{T_A(8)}{\frac{\pi}{2}(0.5^4)G} = \frac{T_B(12)}{\frac{\pi}{2}(0.5^4)G}} = 1408 T_A = 192 T_B \quad (2)$$



Solving Eqs. (1) and (2) yields

$$T_A = 60 \text{ lb} \cdot \text{ft} \quad T_B = 440 \text{ lb} \cdot \text{ft}$$

$$\tau_{AC} = \frac{T_C}{J} = \frac{60(12)(0.25)}{\frac{\pi}{2}(0.25^4)} = 29.3 \text{ ksi} \quad (\text{max}) \quad \text{Ans}$$

$$\tau_{DB} = \frac{T_C}{J} = \frac{440(12)(0.5)}{\frac{\pi}{2}(0.5^4)} = 26.9 \text{ ksi}$$

From *Mechanics of Materials*, Sixth Edition by R. C. Hibbeler, ISBN 0-13-191345-X.

© 2005 R. C. Hibbeler. Published by Pearson Prentice Hall,

Pearson Education, Inc., Upper Saddle River, NJ. All rights reserved.

This material is protected under all copyright laws as they currently exist. No portion of this material may be reproduced, in any form or by any means, without permission in writing from the publisher.

5-77 The motor *A* develops a torque at gear *B* of 450 lb·ft, which is applied along the axis of the 2-in.-diameter steel shaft *CD*. This torque is to be transmitted to the pinion gears at *E* and *F*. If these gears are temporarily fixed, determine the maximum shear stress in segments *CB* and *BD* of the shaft. Also, what is the angle of twist of each of these segments? The bearings at *C* and *D* only exert force reactions on the shaft and do not resist torque. $G_s = 12(10^3)$ ksi.

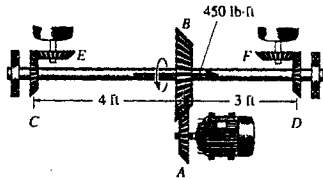

Equilibrium :

$$T_C + T_D - 450 = 0 \quad (1)$$

Compatibility condition :

$$\begin{aligned} \phi_{B/C} &= \phi_{B/D} \\ \frac{T_C(4)}{JG} &= \frac{T_D(3)}{JG} \\ T_C &= 0.75 T_D \end{aligned} \quad (2)$$

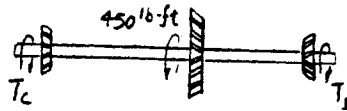

Solving Eqs. (1) and (2), yields

$$\begin{aligned} T_D &= 257.14 \text{ lb} \cdot \text{ft} \\ T_C &= 192.86 \text{ lb} \cdot \text{ft} \end{aligned}$$

$$(\tau_{BC})_{\max} = \frac{192.86(12)(1)}{\frac{\pi}{2}(1^4)} = 1.47 \text{ ksi} \quad \text{Ans}$$

$$(\tau_{BD})_{\max} = \frac{257.14(12)(1)}{\frac{\pi}{2}(1^4)} = 1.96 \text{ ksi} \quad \text{Ans}$$

$$\phi = \frac{192.86(12)(4)(12)}{\frac{\pi}{2}(1^4)(12)(10^6)} = 0.00589 \text{ rad} = 0.338^\circ \quad \text{Ans}$$

From *Mechanics of Materials*, Sixth Edition by R. C. Hibbeler, ISBN 0-13-191345-X.

© 2005 R. C. Hibbeler. Published by Pearson Prentice Hall,

Pearson Education, Inc., Upper Saddle River, NJ. All rights reserved.

This material is protected under all copyright laws as they currently exist. No portion of this material may be reproduced, in any form or by any means, without permission in writing from the publisher.

5-78. The composite shaft consists of a mid-section that includes the 1-in.-diameter solid shaft and a tube that is welded to the rigid flanges at *A* and *B*. Neglect the thickness of the flanges and determine the angle of twist of end *C* of the shaft relative to end *D*. The shaft is subjected to a torque of 800 lb · ft. The material is A-36 steel.

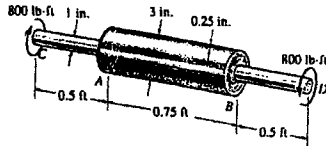

Equilibrium :

$$800(12) - T_T - T_S = 0$$

Compatibility condition :

$$\phi_T = \phi_S; \quad \frac{T_T(0.75)(12)}{\frac{\pi}{2}((1.5)^4 - (1.25)^4)G} = \frac{T_S(0.75)(12)}{\frac{\pi}{2}(0.5)^4 G}$$

$$T_T = 9376.42 \text{ lb} \cdot \text{in.}$$

$$T_S = 223.58 \text{ lb} \cdot \text{in.}$$

$$\phi_{C/D} = \sum \frac{TL}{JG} = \frac{800(12)(1)(12)}{\frac{\pi}{2}(0.5)^4(11.0)(10^6)} + \frac{223.58(0.75)(12)}{\frac{\pi}{2}(0.5)^4(11.0)(10^6)} = 0.1085 \text{ rad} = 6.22^\circ \quad \text{Ans}$$



From *Mechanics of Materials*, Sixth Edition by R. C. Hibbeler, ISBN 0-13-191345-X.

© 2005 R. C. Hibbeler. Published by Pearson Prentice Hall,

Pearson Education, Inc., Upper Saddle River, NJ. All rights reserved.

This material is protected under all copyright laws as they currently exist. No portion of this material may be reproduced, in any form or by any means, without permission in writing from the publisher.

5-79. The shaft is made from a solid steel section AB and a tubular portion made of steel and having a brass core. If it is fixed to a rigid support at A , and a torque of $T = 50 \text{ lb} \cdot \text{ft}$ is applied to it at C , determine the angle of twist that occurs at C and compute the maximum shear and maximum shear strain in the brass and steel. Take $G_{st} = 11.5(10^3) \text{ ksi}$, $G_{br} = 5.6(10^3) \text{ ksi}$.

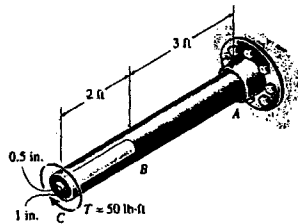

Equilibrium :

$$T_{br} + T_{st} - 50 = 0 \quad (1)$$

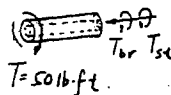

Both the steel tube and brass core undergo the same angle of twist $\phi_{C/B}$

$$\phi_{C/B} = \frac{TL}{JG} = \frac{T_{br}(2)(12)}{\frac{\pi}{2}(0.5^4)(5.6)(10^6)} = \frac{T_{st}(2)(12)}{\frac{\pi}{2}(1^4 - 0.5^4)(11.5)(10^6)}$$

$$T_{br} = 0.032464 T_{st} \quad (2)$$

Solving Eqs. (1) and (2) yields :

$$T_{st} = 48.428 \text{ lb} \cdot \text{ft}; \quad T_{br} = 1.572 \text{ lb} \cdot \text{ft}$$

$$\phi_C = \sum \frac{TL}{JG} = \frac{1.572(12)(2)(12)}{\frac{\pi}{2}(0.5^4)(5.6)(10^6)} + \frac{50(12)(3)(12)}{\frac{\pi}{2}(1^4)(11.5)(10^6)} = 0.002019 \text{ rad} = 0.116^\circ$$

Ans

$$(\tau_{st})_{\max AB} = \frac{T_{st}c}{J} = \frac{50(12)(1)}{\frac{\pi}{2}(1^4)} = 382 \text{ psi}$$

$$(\tau_{st})_{\max BC} = \frac{T_{st}c}{J} = \frac{48.428(12)(1)}{\frac{\pi}{2}(1^4 - 0.5^4)} = 394.63 \text{ psi} = 395 \text{ psi (Max)} \quad \text{Ans}$$

$$(\gamma_{st})_{\max} = \frac{(\tau_{st})_{\max}}{G} = \frac{394.63}{11.5(10^6)} = 34.3(10^{-6}) \text{ rad} \quad \text{Ans}$$

$$(\tau_{br})_{\max} = \frac{T_{br}c}{J} = \frac{1.572(12)(0.5)}{\frac{\pi}{2}(0.5^4)} = 96.07 \text{ psi} = 96.1 \text{ psi (Max)} \quad \text{Ans}$$

$$(\gamma_{br})_{\max} = \frac{(\tau_{br})_{\max}}{G} = \frac{96.07}{5.6(10^6)} = 17.2(10^{-6}) \text{ rad} \quad \text{Ans}$$

From *Mechanics of Materials*, Sixth Edition by R. C. Hibbeler, ISBN 0-13-191345-X.

© 2005 R. C. Hibbeler. Published by Pearson Prentice Hall,

Pearson Education, Inc., Upper Saddle River, NJ. All rights reserved.

This material is protected under all copyright laws as they currently exist. No portion of this material may be reproduced, in any form or by any means, without permission in writing from the publisher.

*5-80 The two 3-ft-long shafts are made of 2014-T6 aluminum. Each has a diameter of 1.5 in. and they are connected using the gears fixed to their ends. Their other ends are attached to fixed supports at *A* and *B*. They are also supported by bearings at *C* and *D*, which allow free rotation of the shafts along their axes. If a torque of 600 lb·ft is applied to the top gear as shown, determine the maximum shear stress in each shaft.

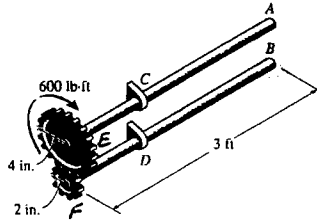

$$T_A + F\left(\frac{4}{12}\right) - 600 = 0 \quad (1)$$

$$T_B - F\left(\frac{2}{12}\right) = 0 \quad (2)$$

From Eqs. (1) and (2)

$$T_A + 2T_B - 600 = 0 \quad (3)$$

$$4(\phi_E) = 2(\phi_F); \quad \phi_E = 0.5\phi_F$$

$$\frac{T_A L}{JG} = 0.5\left(\frac{T_B L}{JG}\right); \quad T_A = 0.5T_B \quad (4)$$

Solving Eqs. (3) and (4) yields :

$$T_B = 240 \text{ lb}\cdot\text{ft}; \quad T_A = 120 \text{ lb}\cdot\text{ft}$$

$$(\tau_{BD})_{\max} = \frac{T_B c}{J} = \frac{240(12)(0.75)}{\frac{\pi}{2}(0.75^4)} = 4.35 \text{ ksi} \quad \text{Ans}$$

$$(\tau_{AC})_{\max} = \frac{T_A c}{J} = \frac{120(12)(0.75)}{\frac{\pi}{2}(0.75^4)} = 2.17 \text{ ksi} \quad \text{Ans}$$

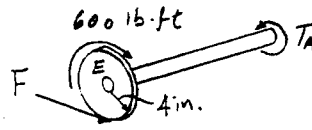

From *Mechanics of Materials*, Sixth Edition by R. C. Hibbeler, ISBN 0-13-191345-X.

© 2005 R. C. Hibbeler. Published by Pearson Prentice Hall,

Pearson Education, Inc., Upper Saddle River, NJ. All rights reserved.

This material is protected under all copyright laws as they currently exist. No portion of this material may be reproduced, in any form or by any means, without permission in writing from the publisher.

5-81 The two shafts AB and EF are fixed at their ends and fixed connected to gears that are in mesh with a common gear at C , which is fixed connected to shaft CD . If a torque of $T = 80 \text{ N}\cdot\text{m}$ is applied at end D , determine the angle of twist of end D . Each shaft has a diameter of 20 mm and is made from A-36 steel.

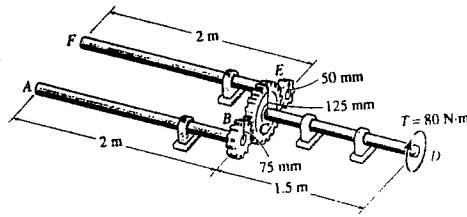

If gear C rotates ϕ_C then,

$$50 \phi_E = 125 \phi_C$$

$$\phi_E = 2.5 \phi_C$$

$$75 \phi_B = 125 \phi_C$$

$$\phi_B = 1.667 \phi_C$$

$$\phi_E = \frac{T_F(2)}{JG} \quad (1)$$

$$\phi_B = \frac{T_A(2)}{JG} \quad (2)$$

$$\Sigma M_{CD} = 0; \quad F_2(125) + F_1(125) - 80 = 0$$

$$\Sigma M_{BA} = 0; \quad -T_A + F_2(75) = 0$$

$$\Sigma M_{EF} = 0; \quad F_1(50) - T_F = 0$$

or

$$1.667 T_A + 2.5 T_F = 80$$

From Eqs. (1) and (2)

$$\phi_C = \frac{T_F(2)}{2.5 JG} \quad (3)$$

$$\phi_C = \frac{T_A(2)}{1.667 JG} \quad (4)$$

Thus,

$$\phi_C \left[\frac{1.667(1.667 JG)}{2} + \frac{2.5(2.5 JG)}{2} \right] = 80$$

$$\phi_C JG = 17.723$$

$$\phi_C = \frac{17.723}{(\pi \frac{(0.01)^4}{32})(75)(10^9)} = 0.01504 \text{ rad}$$

$$\phi_D = \phi_C + \frac{80(1.5)}{(\pi \frac{(0.01)^4}{32})(75)(10^9)} = 0.1169 \text{ rad} = 6.70^\circ \quad \text{Ans}$$

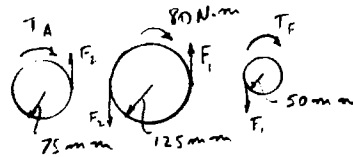
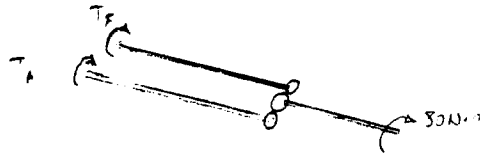

From *Mechanics of Materials*, Sixth Edition by R. C. Hibbeler, ISBN 0-13-191345-X.

© 2005 R. C. Hibbeler. Published by Pearson Prentice Hall,

Pearson Education, Inc., Upper Saddle River, NJ. All rights reserved.

This material is protected under all copyright laws as they currently exist. No portion of this material may be reproduced, in any form or by any means, without permission in writing from the publisher.

5-82 The two shafts AB and EF are fixed at their ends and fixed connected to gears that are in mesh with a common gear at C , which is fixed connected to shaft CD . If a torque of $T = 80 \text{ N}\cdot\text{m}$ is applied to end D , determine the torque at A and F . Each shaft has a diameter of 20 mm and is made from A-36 steel.

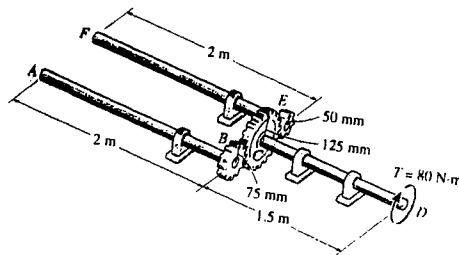

If gear C rotates ϕ_C then,

$$50 \phi_E = 125 \phi_C \\ \phi_E = 2.5 \phi_C$$

$$75 \phi_B = 125 \phi_C \\ \phi_B = 1.667 \phi_C$$

$$\phi_E = \frac{T_F(2)}{JG} \quad (1)$$

$$\phi_B = \frac{T_A(2)}{JG} \quad (2)$$

$$\Sigma M_{CD} = 0; \quad F_2(125) + F_1(125) - 80 = 0$$

$$\Sigma M_{BA} = 0; \quad -T_A + F_2(75) = 0$$

$$\Sigma M_{EF} = 0; \quad F_1(50) - T_F = 0$$

or

$$1.667 T_A + 2.5 T_F = 80$$

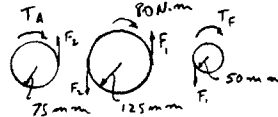
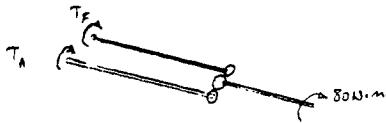

From Eqs. (1) and (2)

$$\phi_C = \frac{T_F(2)}{2.5 JG} \quad (3)$$

$$\phi_C = \frac{T_A(2)}{1.667 JG} \quad (4)$$

Thus,

$$\phi_C \left[\frac{1.667(1.667 JG)}{2} + \frac{2.5(2.5 JG)}{2} \right] = 80$$

$$\phi_C JG = 17.723$$

$$\phi_C = \frac{17.723}{(\pi \frac{(0.01)^4}{2})(75)(10^9)} = 0.01504 \text{ rad}$$

$$T_F = \frac{2.5 JG \phi_C}{2} = \frac{2.5(\pi \frac{(0.01)^4}{2})(75)(10^9)(0.01504)}{2}$$

$$T_F = 22.1 \text{ N}\cdot\text{m} \quad \text{Ans}$$

$$T_A = \frac{1.667 JG \phi_C}{2} = \frac{1.667(\pi \frac{(0.01)^4}{2})(75)(10^9)(0.01504)}{2}$$

$$T_A = 14.8 \text{ N}\cdot\text{m} \quad \text{Ans}$$

From *Mechanics of Materials*, Sixth Edition by R. C. Hibbeler, ISBN 0-13-191345-X.

© 2005 R. C. Hibbeler. Published by Pearson Prentice Hall,

Pearson Education, Inc., Upper Saddle River, NJ. All rights reserved.

This material is protected under all copyright laws as they currently exist. No portion of this material may be reproduced, in any form or by any means, without permission in writing from the publisher.

5-83 The A-36 steel shaft is made from two segments: AC has a diameter of 0.5 in. and CB has a diameter of 1 in. If the shaft is fixed at its ends A and B and subjected to a uniform distributed torque of $60 \text{ lb} \cdot \text{in./in.}$ along segment CB , determine the absolute maximum shear stress in the shaft.

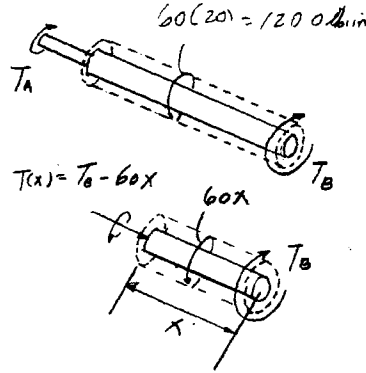
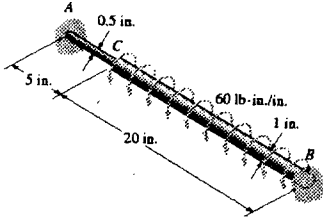

Equilibrium :

$$T_A + T_B - 60(20) = 0 \quad (1)$$

Compatibility condition :

$$\phi_{C/B} = \phi_{C/A}$$

$$\begin{aligned} \phi_{C/B} &= \int \frac{T(x) dx}{JG} = \int_0^{20} \frac{(T_B - 60x) dx}{\frac{\pi}{2}(0.5^4)(11.0)(10^6)} \\ &= 18.52(10^{-6})T_B - 0.011112 \\ 18.52(10^{-6})T_B - 0.011112 &= \frac{T_A(5)}{\frac{\pi}{2}(0.25^4)(11.0)(10^6)} \end{aligned}$$

$$18.52(10^{-6})T_B - 74.08(10^{-6})T_A = 0.011112$$

$$18.52T_B - 74.08T_A = 11112 \quad (2)$$

Solving Eqs. (1) and (2) yields :

$$T_A = 120.0 \text{ lb} \cdot \text{in.}; \quad T_B = 1080 \text{ lb} \cdot \text{in.}$$

$$(\tau_{\max})_{BC} = \frac{T_B c}{J} = \frac{1080(0.5)}{\frac{\pi}{2}(0.5^4)} = 5.50 \text{ ksi}$$

$$(\tau_{\max})_{AC} = \frac{T_A c}{J} = \frac{120.0(0.25)}{\frac{\pi}{2}(0.25^4)} = 4.89 \text{ ksi}$$

$$\tau_{\max} = 5.50 \text{ ksi} \quad \text{Ans}$$

From *Mechanics of Materials*, Sixth Edition by R. C. Hibbeler, ISBN 0-13-191345-X.

© 2005 R. C. Hibbeler. Published by Pearson Prentice Hall,

Pearson Education, Inc., Upper Saddle River, NJ. All rights reserved.

This material is protected under all copyright laws as they currently exist. No portion of this material may be reproduced, in any form or by any means, without permission in writing from the publisher.

*5-84. The tapered shaft is confined by the fixed supports at A and B . If a torque T is applied at its mid-point, determine the reactions at the supports.

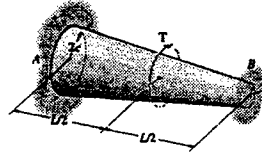

Equilibrium :

$$T_A + T_B - T = 0 \quad [1]$$

Section Properties :

$$r(x) = c + \frac{c}{L}x = \frac{c}{L}(L+x)$$

$$J(x) = \frac{\pi}{2} \left[\frac{c}{L}(L+x) \right]^4 = \frac{\pi c^4}{2L^4} (L+x)^4$$

Angle of Twist :

$$\begin{aligned} \phi_T &= \int \frac{T dx}{J(x)G} = \int_0^L \frac{T dx}{\frac{\pi c^4}{2L^4} (L+x)^4 G} \\ &= \frac{2TL^4}{\pi c^4 G} \int_0^L \frac{dx}{(L+x)^4} \\ &= \frac{2TL^4}{3\pi c^4 G} \left[\frac{1}{(L+x)^3} \right]_0^L \\ &= \frac{37TL}{324\pi c^4 G} \end{aligned}$$

$$\begin{aligned} \phi_B &= \int \frac{T dx}{J(x)G} = \int_0^L \frac{T_B dx}{\frac{\pi c^4}{2L^4} (L+x)^4 G} \\ &= \frac{2T_B L^4}{\pi c^4 G} \int_0^L \frac{dx}{(L+x)^4} \\ &= \frac{2T_B L^4}{3\pi c^4 G} \left[\frac{1}{(L+x)^3} \right]_0^L \\ &= \frac{7T_B L}{12\pi c^4 G} \end{aligned}$$

Compatibility :

$$\begin{aligned} 0 &= \phi_T - \phi_B \\ 0 &= \frac{37TL}{324\pi c^4 G} - \frac{7T_B L}{12\pi c^4 G} \\ T_B &= \frac{37}{189} T \quad \text{Ans} \end{aligned}$$

Substituting the result into Eq. [1] yields :

$$T_A = \frac{152}{189} T \quad \text{Ans}$$

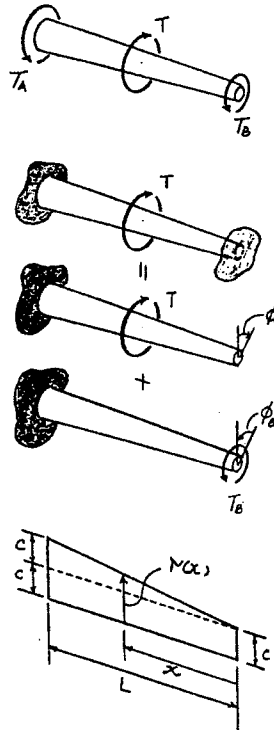

From *Mechanics of Materials*, Sixth Edition by R. C. Hibbeler, ISBN 0-13-191345-X.

© 2005 R. C. Hibbeler. Published by Pearson Prentice Hall,

Pearson Education, Inc., Upper Saddle River, NJ. All rights reserved.

This material is protected under all copyright laws as they currently exist. No portion of this material may be reproduced, in any form or by any means, without permission in writing from the publisher.

5-85 A portion of the A-36 steel shaft is subjected to a linearly distributed torsional loading. If the shaft has the dimensions shown, determine the reactions at the fixed supports A and C . Segment AB has a diameter of 1.5 in. and segment BC has a diameter of 0.75 in.

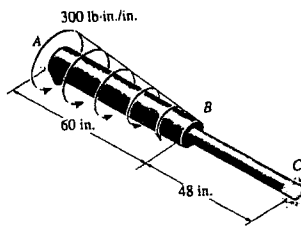

Equilibrium :

$$T_A + T_C - 9000 = 0 \quad (1)$$

$$T_R = tx + \frac{1}{2}(300 - t)x = 150x + \frac{tx}{2}$$

But $\frac{t}{60 - x} = \frac{300}{60}$; $t = 5(60 - x)$

$$T_R = 150x + \frac{1}{2}[5(60 - x)]x$$

$$= (300x - 2.5x^2) \text{ lb} \cdot \text{in.}$$

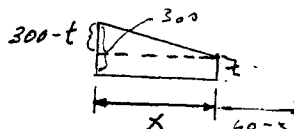

Compatibility condition :

$$\phi_{B/A} = \phi_{B/C}$$

$$\phi_{B/A} = \int \frac{T(x) dx}{JG} = \frac{1}{JG} \int_0^{60} [T_A - (300x - 2.5x^2)] dx$$

$$= \frac{1}{JG} [T_A x - 150x^2 + 0.8333x^3] \Big|_0^{60}$$

$$= \frac{60T_A - 360000}{JG}$$

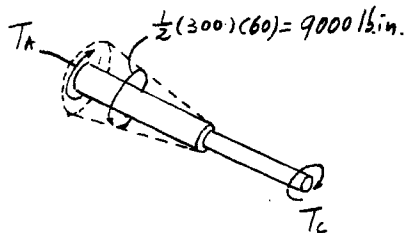

$$\frac{60T_A - 360000}{\frac{\pi}{2}(0.75^4)G} = \frac{T_C(48)}{\frac{\pi}{2}(0.375^4)G}$$

$$60T_A - 768T_C = 360000 \quad (2)$$

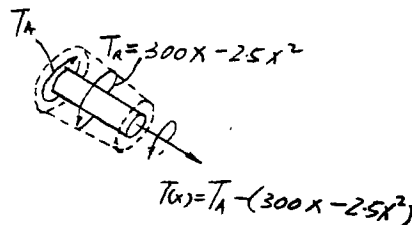

Solving Eqs. (1) and (2) yields :

$$T_C \approx 217.4 \text{ lb} \cdot \text{in.} = 18.1 \text{ lb} \cdot \text{ft} \quad \text{Ans}$$

$$T_A = 8782.6 \text{ lb} \cdot \text{in.} = 732 \text{ lb} \cdot \text{ft} \quad \text{Ans}$$

From *Mechanics of Materials*, Sixth Edition by R. C. Hibbeler, ISBN 0-13-191345-X.

© 2005 R. C. Hibbeler. Published by Pearson Prentice Hall,

Pearson Education, Inc., Upper Saddle River, NJ. All rights reserved.

This material is protected under all copyright laws as they currently exist. No portion of this material may be reproduced, in any form or by any means, without permission in writing from the publisher.

5-86 Determine the rotation of joint B and the absolute maximum shear stress in the shaft in Prob. 5-85.

Equilibrium :

$$T_A + T_C - 9000 = 0 \quad (1)$$

$$T_R = tx + \frac{1}{2}(300 - t)x = 150x + \frac{tx}{2}$$

But $\frac{t}{60 - x} = \frac{300}{60}; \quad t = 5(60 - x)$

$$T_R = 150x + \frac{1}{2}[5(60 - x)]x$$

$$= (300x - 2.5x^2) \text{ lb} \cdot \text{in.}$$

Compatibility condition :

$$\phi_{B/A} = \phi_{B/C}$$

$$\phi_{B/A} = \int \frac{T(x) dx}{JG} = \frac{1}{JG} \int_0^{60} [T_A - (300x - 2.5x^2)] dx$$

$$= \frac{1}{JG} [T_A x - 150x^2 + 0.8333x^3]_0^{60}$$

$$= \frac{60T_A - 360\,000}{JG}$$

$$\frac{60T_A - 360\,000}{\frac{\pi}{2}(0.75^4)G} = \frac{T_C(48)}{\frac{\pi}{2}(0.375^4)G}$$

$$60T_A - 768T_C = 360\,000 \quad (2)$$

Solving Eqs. (1) and (2) yields :

$$T_C = 217.4 \text{ lb} \cdot \text{in.} = 18.1 \text{ lb} \cdot \text{ft}$$

$$T_A = 8782.6 \text{ lb} \cdot \text{in.} = 732 \text{ lb} \cdot \text{ft}$$

For segment BC :

$$\phi_B = \phi_{B/C} = \frac{T_C L}{JG} = \frac{217.4(48)}{\frac{\pi}{2}(0.375)^4(11.0)(10^6)} = 0.030540 \text{ rad}$$

$$\phi_B = 1.75^\circ$$

$$\tau_{\max} = \frac{T_C}{J} = \frac{217.4(0.375)}{\frac{\pi}{2}(0.375)^4} = 2.62 \text{ ksi}$$

For segment AB,

$$\tau_{\max} = \frac{T_C}{J} = \frac{8782.6(0.75)}{\frac{\pi}{2}(0.75)^4} = 13.3 \text{ ksi}$$

$$\tau_{\max} = 13.3 \text{ ksi} \quad \text{Ans}$$

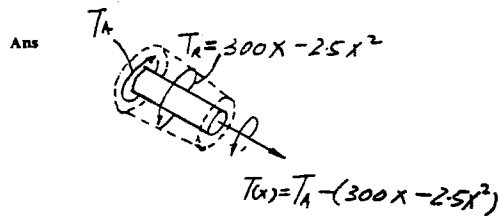
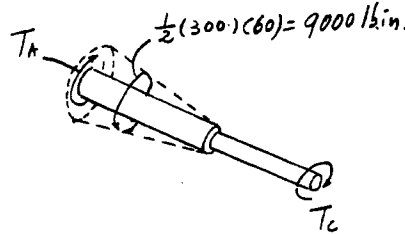
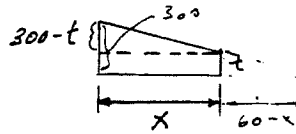
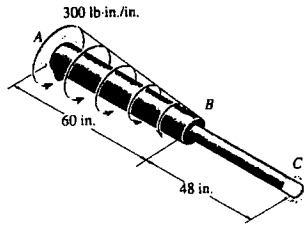

From *Mechanics of Materials*, Sixth Edition by R. C. Hibbeler, ISBN 0-13-191345-X.

© 2005 R. C. Hibbeler. Published by Pearson Prentice Hall,

Pearson Education, Inc., Upper Saddle River, NJ. All rights reserved.

This material is protected under all copyright laws as they currently exist. No portion of this material may be reproduced, in any form or by any means, without permission in writing from the publisher.

5-87. The shaft of radius c is subjected to a distributed torque t , measured as torque/length of shaft. Determine the reactions at the fixed supports A and B .

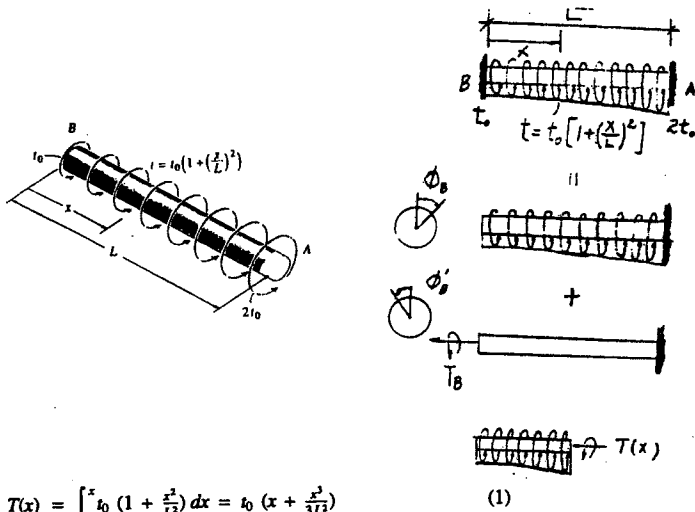

$$T(x) = \int_0^x t_0 \left(1 + \frac{x^2}{L^2}\right) dx = t_0 \left(x + \frac{x^3}{3L^2}\right)$$

By superposition :

$$0 = \phi_B - \phi_A$$

$$0 = \int_0^L \frac{t_0 \left(x + \frac{x^3}{3L^2}\right) dx}{JG} - \frac{T_B(L)}{JG} = \frac{7t_0 L^2}{12} - T_B(L)$$

$$T_B = \frac{7t_0 L}{12} \quad \text{Ans}$$

From Eq. (1),

$$T_R = t_0 \left(L + \frac{L^3}{3L^2}\right) = \frac{4t_0 L}{3}$$

$$T_A + \frac{7t_0 L}{12} - \frac{4t_0 L}{3} = 0$$

$$T_A = \frac{3t_0 L}{4} \quad \text{Ans}$$

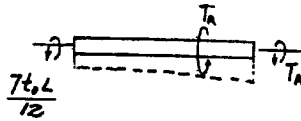

From *Mechanics of Materials*, Sixth Edition by R. C. Hibbeler, ISBN 0-13-191345-X.

© 2005 R. C. Hibbeler. Published by Pearson Prentice Hall,

Pearson Education, Inc., Upper Saddle River, NJ. All rights reserved.

This material is protected under all copyright laws as they currently exist. No portion of this material may be reproduced, in any form or by any means, without permission in writing from the publisher.

***5-88.** The aluminum rod has a square cross section of 10 mm by 10 mm. If it is 8 m long, determine the torque T that is required to rotate one end relative to the other end by 90° . $G_{al} = 28 \text{ GPa}$, $(\tau_Y)_{al} = 240 \text{ MPa}$.

$$\phi = \frac{7.10 T L}{a^4 G}$$

$$\frac{\pi}{2} = \frac{7.10 T (8)}{(0.01)^4 (28)(10^9)}$$

$$T = 7.74 \text{ N} \cdot \text{m} \quad \text{Ans}$$

$$\tau_{\max} = \frac{4.81 T}{a^3}$$

$$= \frac{4.81(7.74)}{0.01^3}$$

$$= 37.2 \text{ MPa} < \tau_Y \quad \text{OK}$$

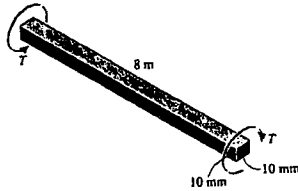

From *Mechanics of Materials*, Sixth Edition by R. C. Hibbeler, ISBN 0-13-191345-X.

© 2005 R. C. Hibbeler. Published by Pearson Prentice Hall,

Pearson Education, Inc., Upper Saddle River, NJ. All rights reserved.

This material is protected under all copyright laws as they currently exist. No portion of this material may be reproduced, in any form or by any means, without permission in writing from the publisher.

5-89 Determine the amount the maximum shear stress in the shaft having an elliptical cross section is increased compared to the shaft having a circular cross section if both shafts withstand the same torque.

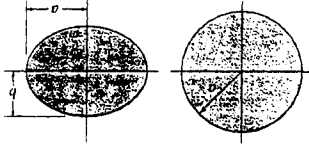

For the circular shaft :

$$(\tau_{\max})_c = \frac{Tc}{J} = \frac{2T}{\pi a^3}$$

For the elliptical shaft :

$$(\tau_{\max})_e = \frac{2T}{\pi a b^2}$$

$$\text{Fraction of increase} = \frac{(\tau_{\max})_e}{(\tau_{\max})_c} = \frac{\frac{2T}{\pi a b^2}}{\frac{2T}{\pi a^3}} = \left(\frac{a}{b}\right)^2 \quad \text{Ans}$$

From *Mechanics of Materials*, Sixth Edition by R. C. Hibbeler, ISBN 0-13-191345-X.

© 2005 R. C. Hibbeler. Published by Pearson Prentice Hall,

Pearson Education, Inc., Upper Saddle River, NJ. All rights reserved.

This material is protected under all copyright laws as they currently exist. No portion of this material may be reproduced, in any form or by any means, without permission in writing from the publisher.

5-90 If $a = 25$ mm and $b = 15$ mm, determine the maximum shear stress in the circular and elliptical shafts when the applied torque is $T = 80$ N · m. By what percentage is the shaft of circular cross section more efficient at withstanding the torque than the shaft of elliptical cross section?

For the circular shaft :

$$(\tau_{\max})_c = \frac{Tc}{J} = \frac{80(0.025)}{\frac{\pi}{2}(0.025^4)} = 3.26 \text{ MPa}$$

Ans

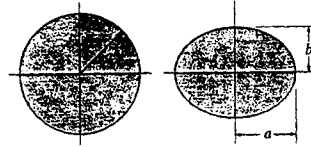

For the elliptical shaft :

$$(\tau_{\max})_e = \frac{2T}{\pi a b^2} = \frac{2(80)}{\pi(0.025)(0.015^2)} = 9.05 \text{ MPa}$$

Ans

$$\% \text{ more efficient} = \frac{(\tau_{\max})_e - (\tau_{\max})_c}{(\tau_{\max})_c} (100\%)$$

$$= \frac{9.05 - 3.26}{3.26} (100\%) = 178 \%$$

Ans

From *Mechanics of Materials*, Sixth Edition by R. C. Hibbeler, ISBN 0-13-191345-X.

© 2005 R. C. Hibbeler. Published by Pearson Prentice Hall,

Pearson Education, Inc., Upper Saddle River, NJ. All rights reserved.

This material is protected under all copyright laws as they currently exist. No portion of this material may be reproduced, in any form or by any means, without permission in writing from the publisher.

5-91 The steel shaft is 12 in. long and is screwed into the wall using a wrench. Determine the largest couple forces F that can be applied to the shaft without causing the steel to yield. $\tau_y = 8$ ksi.

$$F(16) - T = 0 \quad (1)$$

$$\tau_{max} = \tau_y = \frac{4.81T}{a^3}$$

$$8(10^3) = \frac{4.81T}{(1)^3}$$

$$T = 1663.2 \text{ lb} \cdot \text{in.}$$

From Eq. (1),

$$F = 104 \text{ lb} \quad \text{Ans}$$

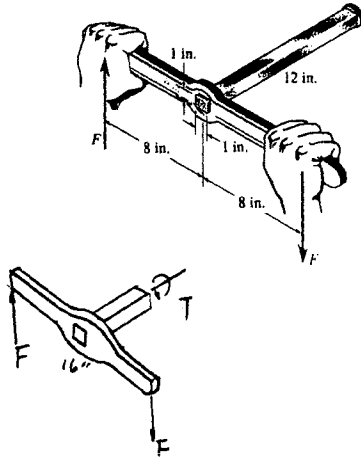

From *Mechanics of Materials*, Sixth Edition by R. C. Hibbeler, ISBN 0-13-191345-X.
 © 2005 R. C. Hibbeler. Published by Pearson Prentice Hall,
 Pearson Education, Inc., Upper Saddle River, NJ. All rights reserved.
 This material is protected under all copyright laws as they currently exist. No portion of this material may be reproduced, in any form or by any means, without permission in writing from the publisher.

*5-92 The steel shaft is 12 in. long and is screwed into the wall using a wrench. Determine the maximum shear stress in the shaft and the amount of displacement that each couple force undergoes if the couple forces have a magnitude of $F = 30$ lb. $G_s = 10.8(10^3)$ ksi.

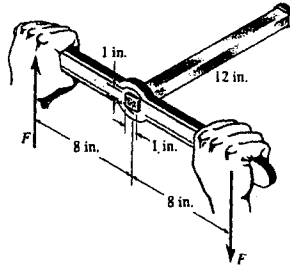

$$T - 30(16) = 0$$

$$T = 480 \text{ lb} \cdot \text{in.}$$

$$\tau_{\max} = \frac{4.81T}{a^3} = \frac{4.81(480)}{(1)^3}$$

$$= 2.31 \text{ ksi} \quad \text{Ans}$$

$$\phi = \frac{7.107L}{a^4G} = \frac{7.10(480)(12)}{(1)^4(10.8)(10^6)} = 0.00379 \text{ rad}$$

$$\delta_F = 8(0.00379) = 0.0303 \text{ in.} \quad \text{Ans}$$

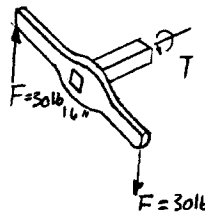

From *Mechanics of Materials*, Sixth Edition by R. C. Hibbeler, ISBN 0-13-191345-X.
 © 2005 R. C. Hibbeler. Published by Pearson Prentice Hall,
 Pearson Education, Inc., Upper Saddle River, NJ. All rights reserved.
 This material is protected under all copyright laws as they currently exist. No portion of this material may be reproduced, in any form or by any means, without permission in writing from the publisher.

5-93 The shaft is made of plastic and has an elliptical cross-section. If it is subjected to the torsional loading shown, determine the shear stress at point A and show the shear stress on a volume element located at this point. Also, determine the angle of twist ϕ at the end B. $G_p = 15 \text{ GPa}$.

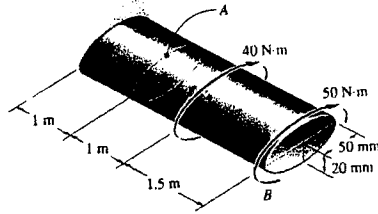

$$\tau_A = \frac{2(T_{AC})}{\pi a b^2}$$

$$= \frac{2(90)}{\pi(0.05)(0.02)^2} = 2.86 \text{ MPa} \quad \text{Ans}$$

$$\phi = \sum \frac{(a^2 + b^2)TL}{\pi a^3 b^3 G}$$

$$= \frac{(0.05^2 + 0.02^2)(50)(1.5)}{\pi(0.05^3)(0.02^3)(15)(10^9)} + \frac{(0.05^2 + 0.02^2)(90)(2)}{\pi(0.05^3)(0.02^3)(15)(10^9)}$$

$$= 0.0157 \text{ rad} = 0.899^\circ \quad \text{Ans}$$

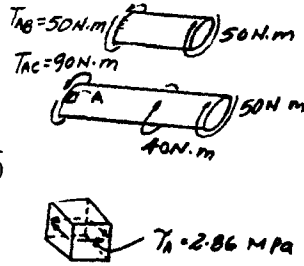

From *Mechanics of Materials*, Sixth Edition by R. C. Hibbeler, ISBN 0-13-191345-X.
 © 2005 R. C. Hibbeler. Published by Pearson Prentice Hall,
 Pearson Education, Inc., Upper Saddle River, NJ. All rights reserved.
 This material is protected under all copyright laws as they currently exist. No portion of this material may be reproduced, in any form or by any means, without permission in writing from the publisher.

5-94. The square shaft is used at the end of a drive cable in order to register the rotation of the cable on a gauge. If it has the dimensions shown and is subjected to a torque of $8 \text{ N} \cdot \text{m}$, determine the shear stress in the shaft at point A . Sketch the shear stress on a volume element located at this point.

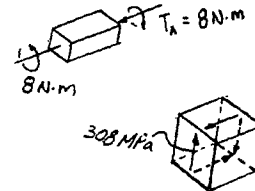
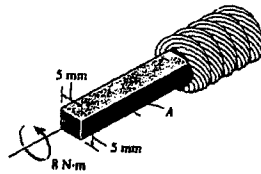

Maximum shear stress :

$$(\tau_{\max})_A = \frac{4.81T}{a^3} = \frac{4.81(8)}{(0.005)^3} = 308 \text{ MPa} \quad \text{Ans}$$

From *Mechanics of Materials*, Sixth Edition by R. C. Hibbeler, ISBN 0-13-191345-X.

© 2005 R. C. Hibbeler. Published by Pearson Prentice Hall,

Pearson Education, Inc., Upper Saddle River, NJ. All rights reserved.

This material is protected under all copyright laws as they currently exist. No portion of this material may be reproduced, in any form or by any means, without permission in writing from the publisher.

5-95. The aluminum strut is fixed between the two walls at *A* and *B*. If it has a 2 in. by 2 in. square cross section, and it is subjected to the torque of 80 lb·ft at *C*, determine the reactions at the fixed supports. Also, what is the angle of twist at *C*? $G_{al} = 3.8(10^3)$ ksi.

By superposition :

$$0 = \phi_A - \phi_B$$

$$0 = \frac{7.10(80)(2)}{a^4 G} - \frac{7.10(T_B)(5)}{a^4 G}$$

$$T_B = 32 \text{ lb} \cdot \text{ft} \quad \text{Ans}$$

$$T_A + 32 - 80 = 0$$

$$T_A = 48 \text{ lb} \cdot \text{ft} \quad \text{Ans}$$

$$\phi_C = \frac{7.10(32)(12)(3)(12)}{(2^4)(3.8)(10^6)} = 0.00161 \text{ rad} = 0.0925^\circ \quad \text{Ans}$$

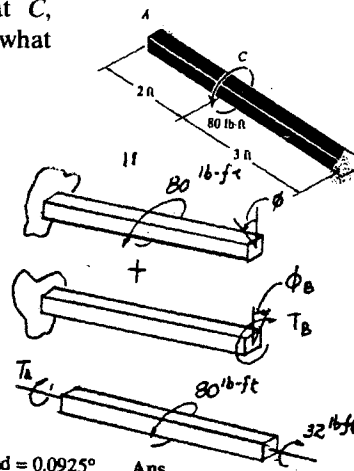

From *Mechanics of Materials*, Sixth Edition by R. C. Hibbeler, ISBN 0-13-191345-X.

© 2005 R. C. Hibbeler. Published by Pearson Prentice Hall,

Pearson Education, Inc., Upper Saddle River, NJ. All rights reserved.

This material is protected under all copyright laws as they currently exist. No portion of this material may be reproduced, in any form or by any means, without permission in writing from the publisher.

*5-96 It is intended to manufacture a circular bar to resist torque; however, the bar is made elliptical in the process of manufacturing, with one dimension smaller than the other by a factor k as shown. Determine the factor by which the maximum shear stress is increased.

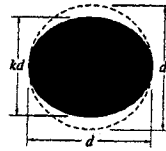

For the circular shaft :

$$(\tau_{\max})_c = \frac{Tc}{J} = \frac{T(\frac{d}{2})}{\frac{\pi(\frac{d}{2})^4}{2}} = \frac{16T}{\pi d^3}$$

For the elliptical shaft :

$$(\tau_{\max})_e = \frac{2T}{\pi a b^2} = \frac{2T}{\pi(\frac{d}{2})(\frac{kd}{2})^2} = \frac{16T}{\pi k^2 d^3}$$

$$\begin{aligned} \text{Factor of increase in shear stress} &= \frac{(\tau_{\max})_e}{(\tau_{\max})_c} = \frac{\frac{16T}{\pi k^2 d^3}}{\frac{16T}{\pi d^3}} \\ &= \frac{1}{k^2} \quad \text{Ans} \end{aligned}$$

From *Mechanics of Materials*, Sixth Edition by R. C. Hibbeler, ISBN 0-13-191345-X.

© 2005 R. C. Hibbeler. Published by Pearson Prentice Hall,

Pearson Education, Inc., Upper Saddle River, NJ. All rights reserved.

This material is protected under all copyright laws as they currently exist. No portion of this material may be reproduced, in any form or by any means, without permission in writing from the publisher.

5-97 A torque T is applied to two tubes having the cross-sections shown. Compare the shear flow developed in each tube.

Circular tube :

$$q_{c,t} = \frac{T}{2A_m} = \frac{T}{2\pi (a/2)^2} = \frac{2T}{\pi a^2}$$

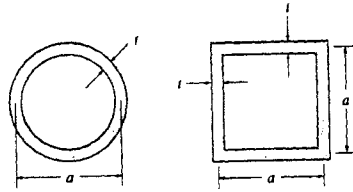

Square tube :

$$q_{s,t} = \frac{T}{2A_m} = \frac{T}{2a^2}$$

$$\frac{q_{s,t}}{q_{c,t}} = \frac{T/(2a^2)}{2T/(\pi a^2)} = \frac{\pi}{4}$$

Thus;

$$q_{s,t} = \frac{\pi}{4} q_{c,t} \quad \text{Ans}$$

From *Mechanics of Materials*, Sixth Edition by R. C. Hibbeler, ISBN 0-13-191345-X.

© 2005 R. C. Hibbeler. Published by Pearson Prentice Hall,

Pearson Education, Inc., Upper Saddle River, NJ. All rights reserved.

This material is protected under all copyright laws as they currently exist. No portion of this material may be reproduced, in any form or by any means, without permission in writing from the publisher.

5-98 The plastic tube is subjected to a torque of $150 \text{ N} \cdot \text{m}$. Determine the mean dimension a of its sides if the allowable shear stress if $\tau_{\text{allow}} = 60 \text{ MPa}$. Each side has a thickness of $t = 3 \text{ mm}$. Neglect stress concentrations at the corners.

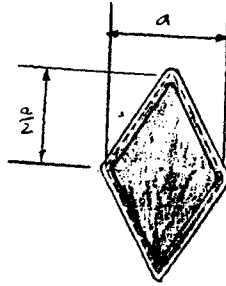
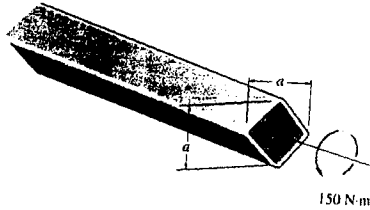

$$A_m = 4 \left[\frac{1}{2} \left(\frac{a}{2} \right) \left(\frac{a}{2} \right) \right] = \frac{a^2}{2}$$

$$\tau_{\text{avg}} = \frac{T}{2 t A_m}; \quad 60(10^6) = \frac{150}{2(0.003) \frac{1}{2} a^2}$$

$$a = 0.0289 \text{ m} = 28.9 \text{ mm}$$

Ans

From *Mechanics of Materials*, Sixth Edition by R. C. Hibbeler, ISBN 0-13-191345-X.

© 2005 R. C. Hibbeler. Published by Pearson Prentice Hall,

Pearson Education, Inc., Upper Saddle River, NJ. All rights reserved.

This material is protected under all copyright laws as they currently exist. No portion of this material may be reproduced, in any form or by any means, without permission in writing from the publisher.

5-99. The plastic tube is subjected to a torque of $150 \text{ N} \cdot \text{m}$. Determine the average shear stress in the tube if the mean dimension $a = 200 \text{ mm}$. Each side has a thickness of $t = 3 \text{ mm}$. Neglect stress concentrations at the corners.

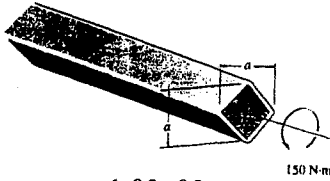

$$A_m = 4 \left[\frac{1}{2} \left(\frac{0.2}{2} \right) \left(\frac{0.2}{2} \right) \right] = 0.02 \text{ m}^2$$

$$\tau_{avg} = \frac{T}{2tA_m} = \frac{150}{2(0.003)(0.02)}$$

$$= 1.25 \text{ MPa} \quad \text{Ans}$$

From *Mechanics of Materials*, Sixth Edition by R. C. Hibbeler, ISBN 0-13-191345-X.

© 2005 R. C. Hibbeler. Published by Pearson Prentice Hall,

Pearson Education, Inc., Upper Saddle River, NJ. All rights reserved.

This material is protected under all copyright laws as they currently exist. No portion of this material may be reproduced, in any form or by any means, without permission in writing from the publisher.

***5-100** Determine the constant thickness of the rectangular tube if the average shear stress is not to exceed 12 ksi when a torque of $T = 20 \text{ kip} \cdot \text{in.}$ is applied to the tube. Neglect stress concentrations at the corners. The mean dimensions of the tube are shown.

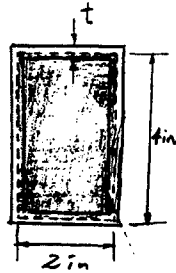
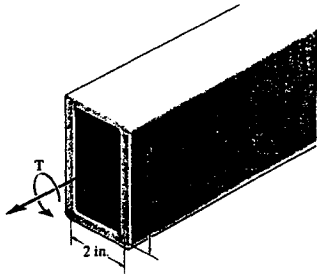

$$A_m = 2(4) = 8 \text{ in}^2$$

$$\tau_{avg} = \frac{T}{2 t A_m}$$

$$12 = \frac{20}{2 t (8)}$$

$$t = 0.104 \text{ in.} \quad \text{Ans}$$

From *Mechanics of Materials*, Sixth Edition by R. C. Hibbeler, ISBN 0-13-191345-X.

© 2005 R. C. Hibbeler. Published by Pearson Prentice Hall,

Pearson Education, Inc., Upper Saddle River, NJ. All rights reserved.

This material is protected under all copyright laws as they currently exist. No portion of this material may be reproduced, in any form or by any means, without permission in writing from the publisher.

5-101 Determine the torque T that can be applied to the rectangular tube if the average shear stress is not to exceed 12 ksi. Neglect stress concentrations at the corners. The mean dimensions of the tube are shown and the tube has a thickness of 0.125 in.

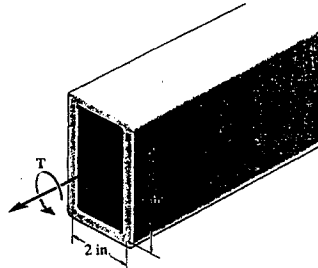

$$A_m = 2(4) = 8 \text{ in}^2$$

$$\tau_{\text{avg}} = \frac{T}{2tA_m}; \quad 12 = \frac{T}{2(0.125)(8)}$$

$$T = 24 \text{ kip} \cdot \text{in.} = 2 \text{ kip} \cdot \text{ft} \quad \text{Ans}$$

From *Mechanics of Materials*, Sixth Edition by R. C. Hibbeler, ISBN 0-13-191345-X.

© 2005 R. C. Hibbeler. Published by Pearson Prentice Hall,

Pearson Education, Inc., Upper Saddle River, NJ. All rights reserved.

This material is protected under all copyright laws as they currently exist. No portion of this material may be reproduced, in any form or by any means, without permission in writing from the publisher.

5-102 A torque of 2 kip · in. is applied to the tube. If the wall thickness is 0.1 in., determine the average shear stress in the tube.

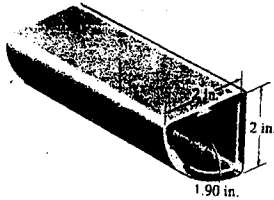

$$A_m = \frac{\pi (1.95^2)}{4} = 2.9865 \text{ in}^2$$

$$\tau_{avg} = \frac{T}{2tA_m} = \frac{2(10^3)}{2(0.1)(2.9865)} = 3.35 \text{ ksi} \quad \mathbf{Ans}$$

From *Mechanics of Materials*, Sixth Edition by R. C. Hibbeler, ISBN 0-13-191345-X.

© 2005 R. C. Hibbeler. Published by Pearson Prentice Hall,

Pearson Education, Inc., Upper Saddle River, NJ. All rights reserved.

This material is protected under all copyright laws as they currently exist. No portion of this material may be reproduced, in any form or by any means, without permission in writing from the publisher.

5-103. The tube is made of plastic, is 5 mm thick, and has the mean dimensions shown. Determine the average shear stress at points *A* and *B* if it is subjected to the torque of $T = 5 \text{ N} \cdot \text{m}$. Show the shear stress on volume elements located at these points.

$$A_m = (0.11)(0.08) + \frac{1}{2}(0.08)(0.03) = 0.01 \text{ m}^2$$

$$\tau_A = \tau_B = \tau_{avg} = \frac{T}{2tA_m} = \frac{5}{2(0.005)(0.01)} = 50 \text{ kPa}$$

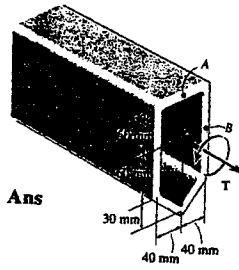

From *Mechanics of Materials*, Sixth Edition by R. C. Hibbeler, ISBN 0-13-191345-X.

© 2005 R. C. Hibbeler. Published by Pearson Prentice Hall,

Pearson Education, Inc., Upper Saddle River, NJ. All rights reserved.

This material is protected under all copyright laws as they currently exist. No portion of this material may be reproduced, in any form or by any means, without permission in writing from the publisher.

***5-104** The steel tube has an elliptical cross section of mean dimensions shown and a constant thickness of $t = 0.2$ in. If the allowable shear stress is $\tau_{\text{allow}} = 8$ ksi, and the tube is to resist a torque of $T = 250$ lb · ft, determine the necessary dimension b . The mean area for the ellipse is $A_m = \pi b(0.5b)$.

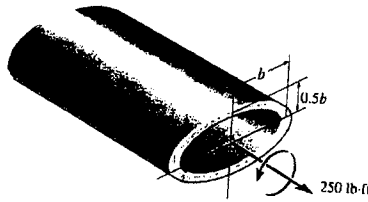

$$\tau_{\text{avg}} = \tau_{\text{allow}} = \frac{T}{2 t A_m}$$

$$8(10^3) = \frac{250(12)}{2(0.2)(\pi)(b)(0.5b)}$$

$$b = 0.773 \text{ in.} \quad \text{Ans}$$

From *Mechanics of Materials*, Sixth Edition by R. C. Hibbeler, ISBN 0-13-191345-X.

© 2005 R. C. Hibbeler. Published by Pearson Prentice Hall,

Pearson Education, Inc., Upper Saddle River, NJ. All rights reserved.

This material is protected under all copyright laws as they currently exist. No portion of this material may be reproduced, in any form or by any means, without permission in writing from the publisher.

5-105. The tube is made of plastic, is 5 mm thick, and has the mean dimensions shown. Determine the average shear stress at points *A* and *B* if the tube is subjected to the torque of $T = 500 \text{ N} \cdot \text{m}$. Show the shear stress on volume elements located at these points. Neglect stress concentrations at the corners.

$$A_m = 2\left[\frac{1}{2}(0.04)(0.03)\right] + 0.1(0.04) = 0.0052 \text{ m}^2$$

$$\begin{aligned} (\tau_{avg})_A = (\tau_{avg})_B &= \frac{T}{2tA_m} \\ &= \frac{500}{2(0.005)(0.0052)} \\ &= 9.62 \text{ MPa} \end{aligned}$$

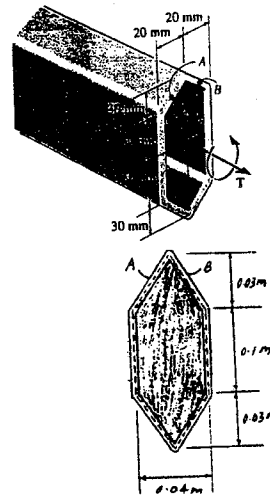
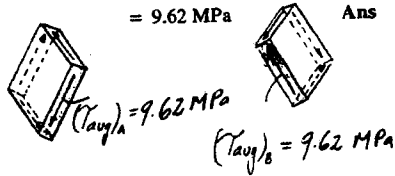

From *Mechanics of Materials*, Sixth Edition by R. C. Hibbeler, ISBN 0-13-191345-X.
 © 2005 R. C. Hibbeler. Published by Pearson Prentice Hall,
 Pearson Education, Inc., Upper Saddle River, NJ. All rights reserved.
 This material is protected under all copyright laws as they currently exist. No portion of this material may be reproduced, in any form or by any means, without permission in writing from the publisher.

5-106. A portion of an airplane fuselage can be approximated by the cross section shown. If the thickness of its 2014-T6-aluminum skin is 10 mm, determine the maximum wing torque T that can be applied if $\tau_{\text{allow}} = 4 \text{ MPa}$. Also, in a 4-m long section, determine the angle of twist.

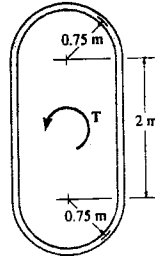

$$\tau_{\text{avg}} = \frac{T}{2t A_m}$$

$$4(10^6) = \frac{T}{2(0.01)[(\pi)(0.75)^2 + 2(1.5)]}$$

$$T = 381.37(10^3) = 381 \text{ kN} \cdot \text{m} \quad \text{Ans}$$

$$\phi = \frac{TL}{4A_m^2 G} \int \frac{ds}{t}$$

$$\phi = \frac{381.37(10^3)(4)}{4[(\pi(0.75)^2 + 2(1.5))^2 27(10^9)]} \left[\frac{4 + 2\pi(0.75)}{0.010} \right]$$

$$\phi = 0.542(10^{-3}) \text{ rad} \quad \text{Ans}$$

From *Mechanics of Materials*, Sixth Edition by R. C. Hibbeler, ISBN 0-13-191345-X.

© 2005 R. C. Hibbeler. Published by Pearson Prentice Hall,

Pearson Education, Inc., Upper Saddle River, NJ. All rights reserved.

This material is protected under all copyright laws as they currently exist. No portion of this material may be reproduced, in any form or by any means, without permission in writing from the publisher.

5-107. The symmetric tube is made from a high-strength steel, having the mean dimensions shown and a thickness of 5 mm. If it is subjected to a torque of $T = 40 \text{ N} \cdot \text{m}$, determine the average shear stress developed at points A and B . Indicate the shear stress on volume elements located at these points.

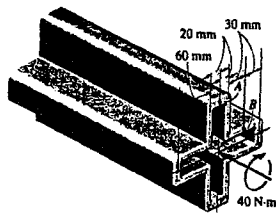

$$A_m = 4(0.04)(0.06) + (0.04)^2 = 0.0112 \text{ m}^2$$

$$\tau_{avg} = \frac{T}{2tA_m}$$

$$(\tau_{avg})_A = (\tau_{avg})_B = \frac{40}{2(0.005)(0.0112)} = 357 \text{ kPa} \quad \text{Ans}$$

$$\tau_A = \tau_B = 357 \text{ kPa}$$

From *Mechanics of Materials*, Sixth Edition by R. C. Hibbeler, ISBN 0-13-191345-X.

© 2005 R. C. Hibbeler. Published by Pearson Prentice Hall,

Pearson Education, Inc., Upper Saddle River, NJ. All rights reserved.

This material is protected under all copyright laws as they currently exist. No portion of this material may be reproduced, in any form or by any means, without permission in writing from the publisher.

***5-108.** The plastic hexagonal tube is subjected to a torque of $150 \text{ N} \cdot \text{m}$. Determine the mean dimension a of its sides if the allowable shear stress is $\tau_{\text{allow}} = 60 \text{ MPa}$. Each side has a thickness of $t = 3 \text{ mm}$.

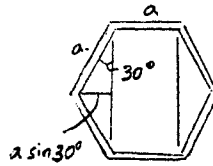
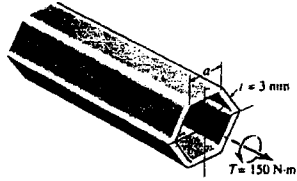

$$A_m = 4 \left[\frac{1}{2} (a \cos 30^\circ) (a \sin 30^\circ) \right] + (a)(2a) \cos 30^\circ = 2.5981 a^2$$

$$\tau_{\text{avg}} = \tau_{\text{allow}} = \frac{T}{2 t A_m}$$

$$60(10^6) = \frac{150}{(2)(0.003)(2.5981 a^2)}$$

$$a = 0.01266 \text{ m} = 12.7 \text{ mm} \quad \text{Ans}$$

From *Mechanics of Materials*, Sixth Edition by R. C. Hibbeler, ISBN 0-13-191345-X.

© 2005 R. C. Hibbeler. Published by Pearson Prentice Hall,

Pearson Education, Inc., Upper Saddle River, NJ. All rights reserved.

This material is protected under all copyright laws as they currently exist. No portion of this material may be reproduced, in any form or by any means, without permission in writing from the publisher.

5-109. Due to fabrication, the inner circle of the tube is eccentric with respect to the outer circle. By what percentage is the torsional strength reduced when the eccentricity e is one-fourth of the difference in the radii?

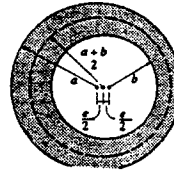

Average Shear Stress :
For the aligned tube

$$\tau_{avg} = \frac{T}{2tA_m} = \frac{T}{2(a-b)(\pi)\left(\frac{a+b}{2}\right)^2}$$

$$T = \tau_{avg}(2)(a-b)(\pi)\left(\frac{a+b}{2}\right)^2$$

For the eccentric tube

$$\tau'_{avg} = \frac{T'}{2tA_m}$$

$$t = a - \frac{e}{2} - \left(\frac{e}{2} + b\right) = a - e - b$$

$$= a - \frac{1}{4}(a-b) - b = \frac{3}{4}(a-b)$$

$$T' = \tau'_{avg}(2)\left[\frac{3}{4}(a-b)\right](\pi)\left(\frac{a+b}{2}\right)^2$$

$$\text{Factor} = \frac{T'}{T} = \frac{\tau'_{avg}(2)\left[\frac{3}{4}(a-b)\right](\pi)\left(\frac{a+b}{2}\right)^2}{\tau_{avg}(2)(a-b)(\pi)\left(\frac{a+b}{2}\right)^2} = \frac{3}{4}$$

$$\text{Percent reduction in strength} = \left(1 - \frac{3}{4}\right) \times 100\% = 25\% \quad \text{Ans}$$

From *Mechanics of Materials*, Sixth Edition by R. C. Hibbeler, ISBN 0-13-191345-X.

© 2005 R. C. Hibbeler. Published by Pearson Prentice Hall,

Pearson Education, Inc., Upper Saddle River, NJ. All rights reserved.

This material is protected under all copyright laws as they currently exist. No portion of this material may be reproduced, in any form or by any means, without permission in writing from the publisher.

5-110 For a given maximum shear stress, determine the factor by which the torque carrying capacity is increased if the half-circular section is reversed from the dashed-line position to the section shown. The tube is 0.1 in. thick.

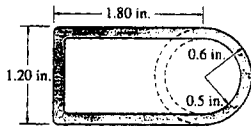

$$A_m = (1.10)(1.75) - \frac{\pi(0.55^2)}{2} = 1.4498 \text{ in}^2$$

$$A_m' = (1.10)(1.75) + \frac{\pi(0.55^2)}{2} = 2.4002 \text{ in}^2$$

$$\tau_{\max} = \frac{T}{2t A_m}$$

$$T = 2t A_m \tau_{\max}$$

$$\text{Factor} = \frac{2t A_m' \tau_{\max}}{2t A_m \tau_{\max}}$$

$$= \frac{A_m'}{A_m} = \frac{2.4002}{1.4498} = 1.66 \quad \text{Ans}$$

From *Mechanics of Materials*, Sixth Edition by R. C. Hibbeler, ISBN 0-13-191345-X.

© 2005 R. C. Hibbeler. Published by Pearson Prentice Hall,

Pearson Education, Inc., Upper Saddle River, NJ. All rights reserved.

This material is protected under all copyright laws as they currently exist. No portion of this material may be reproduced, in any form or by any means, without permission in writing from the publisher.

5-111. The steel shaft is made from two segments AB and BC , which are connected using a fillet weld having a radius of 2.8 mm. Determine the maximum shear stress developed in the shaft.

$$(\tau_{\max})_{CD} = \frac{T_{CD}c}{J} = \frac{100(0.025)}{\frac{\pi}{2}(0.025^4)} = 4.07 \text{ MPa}$$

For the fillet :

$$\frac{D}{d} = \frac{50}{20} = 2.5; \quad \frac{r}{d} = \frac{2.8}{20} = 0.14$$

From Fig. 5-36, $K = 1.325$

$$(\tau_{\max})_f = K \frac{T_{ABC}}{J} = 1.325 \left[\frac{60(0.01)}{\frac{\pi}{2}(0.01^4)} \right] = 50.6 \text{ MPa (max)}$$

Ans

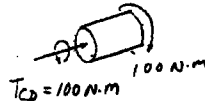
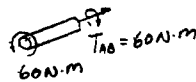
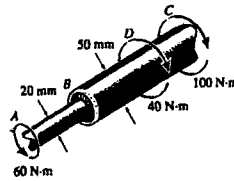

***5-112** The shaft is used to transmit 0.8 hp while turning at 450 rpm. Determine the maximum shear stress in the shaft. The segments are connected together using a fillet weld having a radius of 0.075 in.

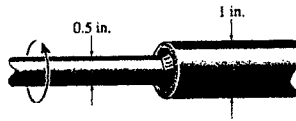

$$\frac{D}{d} = \frac{1}{0.5} = 2 \qquad \frac{r}{d} = \frac{0.075}{0.5} = 0.15$$

From Fig. 5 - 36, $K = 1.30$.

$$\omega = \frac{450(2\pi)}{60} = 47.124 \text{ rad/s}$$

$$P = T\omega$$

$$0.8(550) = T(47.124)$$

$$T = 9.337 \text{ lb} \cdot \text{ft}$$

$$\tau_{\max} = K \frac{Tc}{J} = \frac{1.30(9.337)(12)(0.25)}{\frac{\pi}{2}(0.25^4)} = 5.93 \text{ ksi} \quad \text{Ans}$$

From *Mechanics of Materials*, Sixth Edition by R. C. Hibbeler, ISBN 0-13-191345-X.

© 2005 R. C. Hibbeler. Published by Pearson Prentice Hall,

Pearson Education, Inc., Upper Saddle River, NJ. All rights reserved.

This material is protected under all copyright laws as they currently exist. No portion of this material may be reproduced, in any form or by any means, without permission in writing from the publisher.

5-113. The assembly is subjected to a torque of 710 lb · in. If the allowable shear stress for the material is $\tau_{\text{allow}} = 12 \text{ ksi}$, determine the radius of the smallest size fillet that can be used to transmit the torque.

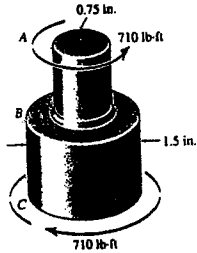

$$\tau_{\text{max}} = \tau_{\text{allow}} = K \frac{Tc}{J}$$

$$12(10^3) = \frac{K(710)(0.375)}{\frac{\pi}{2}(0.375^4)}$$

$$K = 1.40$$

$$\frac{D}{d} = \frac{1.5}{0.75} = 2$$

From Fig. 5-36,

$$\frac{r}{d} = 0.1; \quad r = 0.1(0.75) = 0.075 \text{ in.} \quad \text{Ans}$$

Check :

$$\frac{D-d}{2} = \frac{1.5-0.75}{2} = 0.375 > 0.075 \text{ in.} \quad \text{OK}$$

From *Mechanics of Materials*, Sixth Edition by R. C. Hibbeler, ISBN 0-13-191345-X.

© 2005 R. C. Hibbeler. Published by Pearson Prentice Hall,

Pearson Education, Inc., Upper Saddle River, NJ. All rights reserved.

This material is protected under all copyright laws as they currently exist. No portion of this material may be reproduced, in any form or by any means, without permission in writing from the publisher.

5-114 The built-up shaft is to be designed to rotate at 720 rpm while transmitting 30 kW of power. Is this possible? The allowable shear stress is $\tau_{\text{allow}} = 12 \text{ MPa}$.

$$\omega = 720 \frac{\text{rev}}{\text{min}} \left(\frac{2\pi \text{ rad}}{1 \text{ rev}} \right) \frac{1 \text{ min}}{60 \text{ s}} = 24 \pi \text{ rad/s}$$

$$T = \frac{P}{\omega} = \frac{30(10^3)}{24 \pi} = 397.89 \text{ N} \cdot \text{m}$$

$$\tau_{\text{max}} = K \frac{Tc}{J}; \quad 12(10^6) = K \left[\frac{397.89(0.03)}{\frac{\pi}{2}(0.03^4)} \right]; \quad K = 1.28$$

$$\frac{D}{d} = \frac{75}{60} = 1.25$$

From Fig. 5-36, $\frac{r}{d} = 0.133$

$$\frac{r}{60} = 0.133; \quad r = 7.98 \text{ mm}$$

$$\text{Check:} \quad \frac{D-d}{2} = \frac{75-60}{2} = \frac{15}{2} = 7.5 \text{ mm} < 7.98 \text{ mm}$$

No, it is not possible. **Ans**

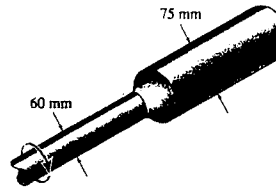

From *Mechanics of Materials*, Sixth Edition by R. C. Hibbeler, ISBN 0-13-191345-X.
 © 2005 R. C. Hibbeler. Published by Pearson Prentice Hall,
 Pearson Education, Inc., Upper Saddle River, NJ. All rights reserved.
 This material is protected under all copyright laws as they currently exist. No portion of this material may be reproduced, in any form or by any means, without permission in writing from the publisher.

5-115 The built-up shaft is designed to rotate at 540 rpm. If the radius of the fillet weld connecting the shafts is $r = 7.20$ mm, and the allowable shear stress for the material is $\tau_{\text{allow}} = 55$ MPa, determine the maximum power the shaft can transmit.

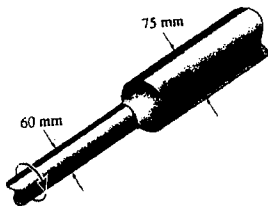

$$\frac{D}{d} = \frac{75}{60} = 1.25; \quad \frac{r}{d} = \frac{7.2}{60} = 0.12$$

From Fig. 5-36, $K = 1.30$

$$\tau_{\text{max}} = K \frac{Tc}{J}; \quad 55(10^6) = 1.30 \left[\frac{T(0.03)}{\frac{\pi}{2}(0.03^4)} \right]; \quad T = 1794.33 \text{ N} \cdot \text{m}$$

$$\omega = 540 \frac{\text{rev}}{\text{min}} \left(\frac{2\pi \text{ rad}}{1 \text{ rev}} \right) \frac{1 \text{ min}}{60 \text{ s}} = 18\pi \text{ rad/s}$$

$$P = T\omega = 1794.33(18\pi) = 101466 \text{ W} = 101 \text{ kW} \quad \text{Ans}$$

From *Mechanics of Materials*, Sixth Edition by R. C. Hibbeler, ISBN 0-13-191345-X.

© 2005 R. C. Hibbeler. Published by Pearson Prentice Hall,

Pearson Education, Inc., Upper Saddle River, NJ. All rights reserved.

This material is protected under all copyright laws as they currently exist. No portion of this material may be reproduced, in any form or by any means, without permission in writing from the publisher.

***5-116.** The steel used for the shaft has an allowable shear stress of $\tau_{\text{allow}} = 8 \text{ MPa}$. If the members are connected together with a fillet weld of radius $r = 2.25 \text{ mm}$, determine the maximum torque T that can be applied.

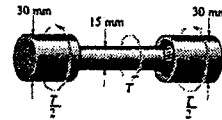

Allowable Shear Stress :

$$\frac{D}{d} = \frac{30}{15} = 2 \quad \text{and} \quad \frac{r}{d} = \frac{2.25}{15} = 0.15$$

From the text, $K = 1.30$

$$\tau_{\text{max}} = \tau_{\text{allow}} = K \frac{Tc}{J}$$

$$8(10^6) = 1.3 \left[\frac{\left(\frac{T}{2}\right) (0.0075)}{\frac{\pi}{2} (0.0075^4)} \right]$$

$$T = 8.16 \text{ N} \cdot \text{m} \quad \text{Ans}$$

From *Mechanics of Materials*, Sixth Edition by R. C. Hibbeler, ISBN 0-13-191345-X.

© 2005 R. C. Hibbeler. Published by Pearson Prentice Hall,

Pearson Education, Inc., Upper Saddle River, NJ. All rights reserved.

This material is protected under all copyright laws as they currently exist. No portion of this material may be reproduced, in any form or by any means, without permission in writing from the publisher.

5-117 A solid shaft is subjected to the torque T , which causes the material to yield. If the material is elastic plastic, show that the torque can be expressed in terms of the angle of twist ϕ of the shaft as $T = \frac{4}{3} T_Y (1 - \frac{\phi^3}{4\phi_Y^3})$, where T_Y and ϕ_Y are the torque and angle of twist when the material begins to yield.

$$\phi = \frac{\gamma L}{\rho} = \frac{\gamma_Y L}{\rho_Y}$$

$$\rho_Y = \frac{\gamma_Y L}{\phi} \quad (1)$$

When $\rho_Y = c$, $\phi = \phi_Y$

From Eq. (1),

$$c = \frac{\gamma_Y L}{\phi_Y} \quad (2)$$

Dividing Eq. (1) by Eq. (2) yields :

$$\frac{\rho_Y}{c} = \frac{\phi_Y}{\phi} \quad (3)$$

Use Eq. 5-26 from the text.

$$T = \frac{\pi \tau_Y}{6} (4c^3 - \rho_Y^3) = \frac{2\pi \tau_Y c^3}{3} (1 - \frac{\rho_Y^3}{4c^3})$$

Use Eq. 5-24, $T_Y = \frac{\pi}{2} \tau_Y c^3$ from the text and Eq. (3)

$$T = \frac{4}{3} T_Y (1 - \frac{\phi^3}{4\phi_Y^3}) \quad \mathbf{QED}$$

From *Mechanics of Materials*, Sixth Edition by R. C. Hibbeler, ISBN 0-13-191345-X.

© 2005 R. C. Hibbeler. Published by Pearson Prentice Hall,

Pearson Education, Inc., Upper Saddle River, NJ. All rights reserved.

This material is protected under all copyright laws as they currently exist. No portion of this material may be reproduced, in any form or by any means, without permission in writing from the publisher.

5-118 A solid shaft having a diameter of 2 in. is made of elastic-plastic material having a yield stress of $\tau_Y = 16$ ksi and shear modulus of $G = 12 (10^3)$ ksi. Determine the torque required to develop an elastic core in the shaft having a diameter of 1 in. Also, what is the plastic torque?

Use Eq. 5-26 from the text :

$$T = \frac{\pi \tau_Y}{6} (4c^3 - \rho_Y^3) = \frac{\pi (16)}{6} [4(1^3) - 0.5^3]$$

$$= 32.46 \text{ kip} \cdot \text{in.} = 2.71 \text{ kip} \cdot \text{ft} \quad \text{Ans}$$

Use Eq. 5-27 from the text :

$$T_p = \frac{2\pi}{3} \tau_Y c^3 = \frac{2\pi}{3} (16)(1^3)$$

$$= 33.51 \text{ kip} \cdot \text{in.} = 2.79 \text{ kip} \cdot \text{ft} \quad \text{Ans}$$

From *Mechanics of Materials*, Sixth Edition by R. C. Hibbeler, ISBN 0-13-191345-X.

© 2005 R. C. Hibbeler. Published by Pearson Prentice Hall,

Pearson Education, Inc., Upper Saddle River, NJ. All rights reserved.

This material is protected under all copyright laws as they currently exist. No portion of this material may be reproduced, in any form or by any means, without permission in writing from the publisher.

5-119 Determine the torque needed to twist a short 3-mm-diameter steel wire through several revolutions if it is made from steel assumed to be elastic plastic and having a yield stress of $\tau_Y = 80$ MPa. Assume that the material becomes fully plastic.

When the material becomes fully plastic then, from Eq. 5-2 in the text,

$$T_p = \frac{2\pi\tau_Y}{3}c^3 = \frac{2\pi(80)(10^6)}{3}(0.0015^3) = 0.565 \text{ N}\cdot\text{m} \quad \text{Ans}$$

From *Mechanics of Materials*, Sixth Edition by R. C. Hibbeler, ISBN 0-13-191345-X.

© 2005 R. C. Hibbeler. Published by Pearson Prentice Hall,

Pearson Education, Inc., Upper Saddle River, NJ. All rights reserved.

This material is protected under all copyright laws as they currently exist. No portion of this material may be reproduced, in any form or by any means, without permission in writing from the publisher.

*5-120 A solid shaft has a diameter of 40 mm and length of 1 m. It is made from an elastic-plastic material having a yield stress of $\tau_Y = 100$ MPa. Determine the maximum elastic torque T_Y and the corresponding angle of twist. What is the angle of twist if the torque is increased to $T = 1.2T_Y$? $G = 80$ GPa.

Maximum elastic torque T_Y ,

$$\tau_Y = \frac{T_Y c}{J}$$

$$T_Y = \frac{\tau_Y J}{c} = \frac{100(10^6) \left(\frac{\pi}{2}\right) (0.02^4)}{0.02} = 1256.64 \text{ N} \cdot \text{m} = 1.26 \text{ kN} \cdot \text{m} \quad \text{Ans}$$

Angle of twist :

$$\gamma_Y = \frac{\tau_Y}{G} = \frac{100(10^6)}{80(10^9)} = 0.00125 \text{ rad}$$

$$\phi = \frac{\gamma_Y L}{\rho_Y} = \frac{0.00125}{0.02} (1) = 0.0625 \text{ rad} = 3.58^\circ \quad \text{Ans}$$

Also,

$$\phi = \frac{T_Y L}{JG} = \frac{1256.64(1)}{\frac{\pi}{2}(0.02^4)(80)(10^9)} = 0.0625 \text{ rad} = 3.58^\circ$$

From Eq. 5-26 of the text,

$$T = \frac{\pi \tau_Y}{6} (4c^3 - \rho_Y^3); \quad 1.2(1256.64) = \frac{\pi (100)(10^6)}{6} [4(0.02^3) - \rho_Y^3]$$

$$\rho_Y = 0.01474 \text{ m}$$

$$\phi' = \frac{\gamma_Y L}{\rho_Y} = \frac{0.00125}{0.01474} (1) = 0.0848 \text{ rad} = 4.86^\circ \quad \text{Ans}$$

From *Mechanics of Materials*, Sixth Edition by R. C. Hibbeler, ISBN 0-13-191345-X.

© 2005 R. C. Hibbeler. Published by Pearson Prentice Hall,

Pearson Education, Inc., Upper Saddle River, NJ. All rights reserved.

This material is protected under all copyright laws as they currently exist. No portion of this material may be reproduced, in any form or by any means, without permission in writing from the publisher.

5-121 Determine the torque needed to twist a short 2-mm-diameter steel wire through several revolutions if it is made from steel assumed to be elastic-plastic and having a yield stress of $\tau_Y = 50$ MPa. Assume that the material becomes fully plastic.

Fully plastic torque is applied. From Eq. 5-27,

$$T_p = \frac{2\pi}{3} \tau_Y c^3 = \frac{2\pi}{3} (50)(10^6)(0.001^3) = 0.105 \text{ N} \cdot \text{m} \quad \text{Ans}$$

From *Mechanics of Materials*, Sixth Edition by R. C. Hibbeler, ISBN 0-13-191345-X.

© 2005 R. C. Hibbeler. Published by Pearson Prentice Hall,

Pearson Education, Inc., Upper Saddle River, NJ. All rights reserved.

This material is protected under all copyright laws as they currently exist. No portion of this material may be reproduced, in any form or by any means, without permission in writing from the publisher.

5-122 A bar having a circular cross section of 3 in. diameter is subjected to a torque of 100 in. · kip. If the material is elastic plastic, with $\tau_Y = 16$ ksi, determine the radius of the elastic core.

Using Eq. 5-26 of the text,

$$T = \frac{\pi \tau_Y}{6} (4c^3 - \rho_Y^3)$$

$$100(10^3) = \frac{\pi (16)(10^3)}{6} (4(1.5^3) - \rho_Y^3)$$

$$\rho_Y = 1.16 \text{ in.} \quad \text{Ans}$$

From *Mechanics of Materials*, Sixth Edition by R. C. Hibbeler, ISBN 0-13-191345-X.

© 2005 R. C. Hibbeler. Published by Pearson Prentice Hall,

Pearson Education, Inc., Upper Saddle River, NJ. All rights reserved.

This material is protected under all copyright laws as they currently exist. No portion of this material may be reproduced, in any form or by any means, without permission in writing from the publisher.

5-123 A shaft of radius $c = 0.75$ in. is made from an elastic-plastic material as shown. Determine the torque T that must be applied to its ends so that it has an elastic core of radius $\rho = 0.6$ in. If the shaft is 30 in. long, determine the angle of twist.

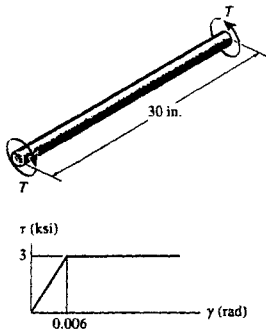

Use Eq. 5 - 26 of the text.

$$\begin{aligned}
 T &= \frac{\pi \tau_Y}{6} (4c^3 - \rho_Y^3) \\
 &= \frac{\pi (3)(10^3)}{6} (4(0.75^3) - 0.6^3) \\
 &= 2311 \text{ lb} \cdot \text{in.} = 193 \text{ lb} \cdot \text{ft} \quad \text{Ans}
 \end{aligned}$$

See Example 5 - 20 of the text.

$$\phi = \frac{\gamma L}{\rho} = \frac{\gamma_Y L}{\rho_Y} = \frac{0.006(30)}{0.6} = 0.300 \text{ rad} = 17.2^\circ \quad \text{Ans}$$

From *Mechanics of Materials*, Sixth Edition by R. C. Hibbeler, ISBN 0-13-191345-X.

© 2005 R. C. Hibbeler. Published by Pearson Prentice Hall,

Pearson Education, Inc., Upper Saddle River, NJ. All rights reserved.

This material is protected under all copyright laws as they currently exist. No portion of this material may be reproduced, in any form or by any means, without permission in writing from the publisher.

***5-124.** The 2-m-long tube is made from an elastic-plastic material as shown. Determine the applied torque T , which subjects the material of the tube's outer edge to a shearing strain of $\gamma_{max} = 0.008$ rad. What would be the permanent angle of twist of the tube when the torque is removed? Sketch the residual stress distribution of the tube.

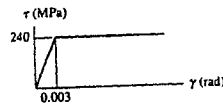
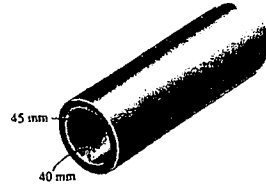

$$\phi = \frac{\gamma_{max} L}{c} = \frac{0.008 (2)}{0.045}$$

$$\phi = 0.3556 \text{ rad}$$

However,

$$\phi = \frac{\tau_r L}{\rho_r}$$

$$0.3556 = \frac{0.003}{\rho_r} (2)$$

$$\rho_r = 0.016875 \text{ m} < 0.04 \text{ m}$$

Therefore the tube is fully plastic.

Also,

$$\frac{0.008}{45} = \frac{r}{40}$$

$$r = 0.00711 > 0.003$$

Again, the tube is fully plastic.

$$T_p = 2\pi \int_{c_i}^{c_o} \tau_r \rho^2 d\rho$$

$$= \frac{2\pi \tau_y}{3} (c_o^3 - c_i^3)$$

$$= \frac{2\pi (240)(10^3)}{3} (0.045^3 - 0.04^3)$$

$$= 13634.5 \text{ N}\cdot\text{m} = 13.6 \text{ kN}\cdot\text{m} \quad \text{Ans}$$

The torque is removed and the opposite torque of $T_p = 13634.5 \text{ N}\cdot\text{m}$ is applied.

$$\phi = \frac{T_p L}{JG} \quad G = \frac{240(10^3)}{0.003} = 80 \text{ GPa}$$

$$= \frac{13634.5 (2)}{\frac{\pi}{2} (0.045^4 - 0.04^4) (80)(10^9)}$$

$$= 0.14085 \text{ rad}$$

$$\phi_r = \phi - \phi = 0.35555 - 0.14085$$

$$= 0.215 \text{ rad} = 12.3^\circ \quad \text{Ans}$$

$$\tau_{r_1} = \frac{T_p c}{J} = \frac{13634.5 (0.045)}{\frac{\pi}{2} (0.045^4 - 0.04^4)} = 253.5 \text{ MPa}$$

$$\tau_{r_2} = \frac{0.04}{0.045} (253.5) = 225.4 \text{ MPa}$$

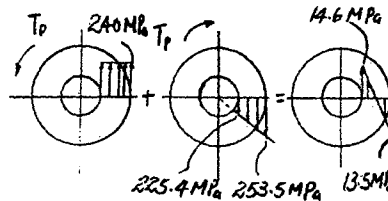
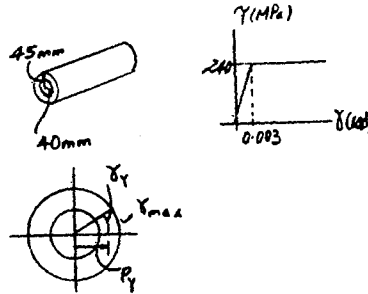

From *Mechanics of Materials*, Sixth Edition by R. C. Hibbeler, ISBN 0-13-191345-X.
 © 2005 R. C. Hibbeler. Published by Pearson Prentice Hall,
 Pearson Education, Inc., Upper Saddle River, NJ. All rights reserved.
 This material is protected under all copyright laws as they currently exist. No portion of this material may be reproduced, in any form or by any means, without permission in writing from the publisher.

5-125 The shaft consists of two sections that are rigidly connected. If the material is elastic plastic as shown, determine the largest torque T that can be applied to the shaft. Also, draw the shear-stress distribution over a radial line for each section. Neglect the effect of stress concentration.

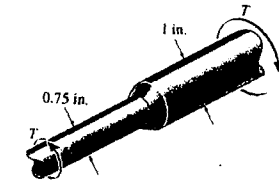

0.75 in. diameter segment will be fully plastic.

From Eq. 5-27 of the text :

$$T = T_p = \frac{2\pi \tau_y (c^3)}{3}$$

$$= \frac{2\pi (12)(10^3)(0.375^3)}{3}$$

$$= 1325.36 \text{ lb} \cdot \text{in.} = 110 \text{ lb} \cdot \text{ft} \quad \text{Ans}$$

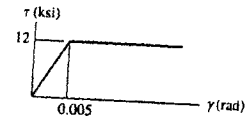
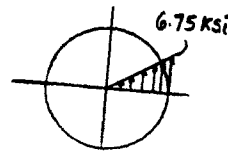
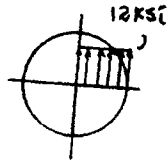

For 1-in. diameter segment :

$$\tau_{\max} = \frac{Tc}{J} = \frac{1325.36(0.5)}{\frac{\pi}{2}(0.5)^4}$$

$$= 6.75 \text{ ksi} < \tau_y$$

From *Mechanics of Materials*, Sixth Edition by R. C. Hibbeler, ISBN 0-13-191345-X.

© 2005 R. C. Hibbeler. Published by Pearson Prentice Hall,

Pearson Education, Inc., Upper Saddle River, NJ. All rights reserved.

This material is protected under all copyright laws as they currently exist. No portion of this material may be reproduced, in any form or by any means, without permission in writing from the publisher.

5-126. The shaft is made from a strain-hardening material having a τ - γ diagram as shown. Determine the torque T that must be applied to the shaft in order to create an elastic core in the shaft having a radius of $\rho_c = 0.5$ in.

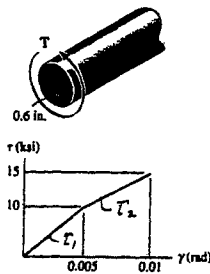

$$\frac{\tau_1}{\gamma} = \frac{10(10^3)}{0.005}$$

$$\tau_1 = 2(10^6) \gamma \quad (1)$$

$$\frac{\tau_2 - 10(10^3)}{\gamma - 0.005} = \frac{15(10^3) - 10(10^3)}{0.01 - 0.005}$$

$$\tau_2 = 1(10^6) \gamma + 5(10^3) \quad (2)$$

$$\gamma_{\max} = \frac{0.6}{0.5} (0.005) = 0.006$$

$$\gamma = \frac{\rho}{c} \gamma_{\max} = \frac{\rho}{0.6} (0.006) = 0.01 \rho$$

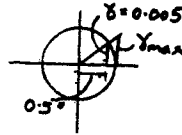

Substituting γ into Eqs. (1) and (2) yields :

$$\tau_1 = 20(10^3) \rho$$

$$\tau_2 = 10(10^3) \rho + 5(10^3)$$

$$T = 2\pi \int_0^c \tau \rho^2 d\rho$$

$$= 2\pi \int_0^{0.5} 20(10^3) \rho^3 d\rho + 2\pi \int_{0.5}^{0.6} [10(10^3) \rho + 5(10^3)] \rho^2 d\rho$$

$$= 3970 \text{ lb} \cdot \text{in.} = 331 \text{ lb} \cdot \text{ft} \quad \text{Ans}$$

From *Mechanics of Materials*, Sixth Edition by R. C. Hibbeler, ISBN 0-13-191345-X.

© 2005 R. C. Hibbeler. Published by Pearson Prentice Hall,

Pearson Education, Inc., Upper Saddle River, NJ. All rights reserved.

This material is protected under all copyright laws as they currently exist. No portion of this material may be reproduced, in any form or by any means, without permission in writing from the publisher.

5-127 The tubular shaft is made from a strain-hardening material having a τ - γ diagram as shown. Determine the torque T that must be applied to the shaft so that the maximum shear strain is 0.01 rad.

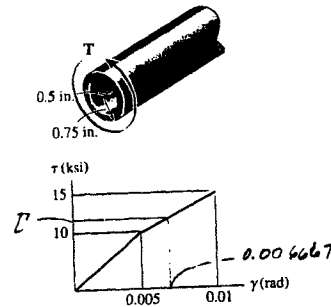

From the shear - strain diagram,

$$\frac{\gamma}{0.5} = \frac{0.01}{0.75}; \quad \gamma = 0.006667 \text{ rad}$$

From the shear stress - strain diagram,

$$\frac{\tau - 10}{0.006667 - 0.005} = \frac{15 - 10}{0.01 - 0.005}; \quad \tau = 11.667 \text{ ksi}$$

$$\frac{\tau - 11.667}{\rho - 0.5} = \frac{15 - 11.667}{0.75 - 0.50}; \quad \tau = 13.333 \rho + 5$$

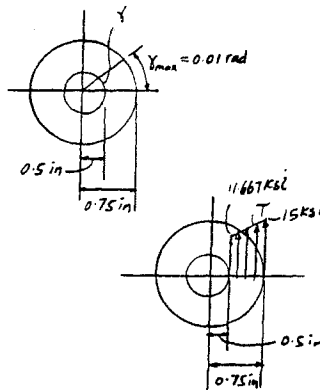

$$\begin{aligned} T &= 2\pi \int_{c_i}^{c_o} \tau \rho^2 d\rho \\ &= 2\pi \int_{0.5}^{0.75} (13.333\rho + 5) \rho^2 d\rho \\ &= 2\pi \int_{0.5}^{0.75} (13.333\rho^3 + 5\rho^2) d\rho \\ &= 2\pi \left[\frac{13.333\rho^4}{4} + \frac{5\rho^3}{3} \right]_{0.5}^{0.75} \\ &= 8.426 \text{ kip} \cdot \text{in.} = 702 \text{ lb} \cdot \text{ft} \end{aligned}$$

Ans

From *Mechanics of Materials*, Sixth Edition by R. C. Hibbeler, ISBN 0-13-191345-X.

© 2005 R. C. Hibbeler. Published by Pearson Prentice Hall,

Pearson Education, Inc., Upper Saddle River, NJ. All rights reserved.

This material is protected under all copyright laws as they currently exist. No portion of this material may be reproduced, in any form or by any means, without permission in writing from the publisher.

***5-128.** The shear stress–strain diagram for a solid 50-mm diameter shaft can be approximated as shown in the figure. Determine the torque required to cause a maximum shear stress in the shaft of 125 MPa. If the shaft is 3 m long, what is the corresponding angle of twist?

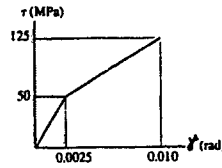

$$\gamma = \frac{\rho}{c} \gamma_{\max}$$

$$\gamma_{\max} = 0.01$$

When $\gamma = 0.0025$

$$\rho = \frac{c\gamma}{\gamma_{\max}}$$

$$= \frac{0.025(0.0025)}{0.010} = 0.00625$$

$$\frac{\tau - 0}{\rho - 0} = \frac{50(10^6)}{0.00625}$$

$$\tau = 8000(10^6)(\rho)$$

$$\frac{\tau - 50(10^6)}{\rho - 0.00625} = \frac{125(10^6) - 50(10^6)}{0.025 - 0.00625}$$

$$\tau = 4000(10^6)(\rho) + 25(10^6)$$

$$T = 2\pi \int_0^c \tau \rho^2 d\rho$$

$$= 2\pi \int_0^{0.00625} 8000(10^6) \rho^3 d\rho$$

$$+ 2\pi \int_{0.00625}^{0.025} [4000(10^6)\rho + 25(10^6)] \rho^2 d\rho$$

$$T = 3269 \text{ N} \cdot \text{m} = 3.27 \text{ kN} \cdot \text{m} \quad \text{Ans}$$

$$\phi = \frac{\gamma_{\max} L}{c} = \frac{0.01}{0.025}(3)$$

$$= 1.20 \text{ rad} = 68.8^\circ \quad \text{Ans}$$

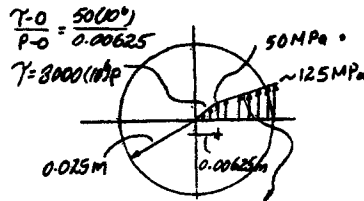

From *Mechanics of Materials*, Sixth Edition by R. C. Hibbeler, ISBN 0-13-191345-X.

© 2005 R. C. Hibbeler. Published by Pearson Prentice Hall,

Pearson Education, Inc., Upper Saddle River, NJ. All rights reserved.

This material is protected under all copyright laws as they currently exist. No portion of this material may be reproduced, in any form or by any means, without permission in writing from the publisher.

5-129. The 2-m-long tube is made from an elastic-plastic material as shown. Determine the applied torque T , which subjects the material at the tube's outer edge to a shear strain of $\gamma_{\max} = 0.006$ rad. What would be the permanent angle of twist of the tube when this torque is removed? Sketch the residual stress distribution in the tube.

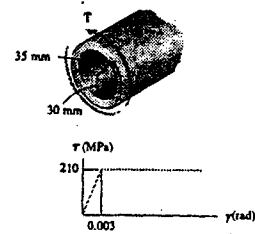

Plastic Torque : The tube is fully plastic if $\gamma_r \geq \gamma_Y = 0.003$ rad.

$$\frac{\gamma}{0.03} = \frac{0.006}{0.035}; \quad \gamma = 0.005143 \text{ rad}$$

Therefore the tube is fully plastic.

$$\begin{aligned} T_p &= 2\pi \int_{c_i}^{c_o} \tau_Y \rho^2 d\rho \\ &= \frac{2\pi \tau_Y}{3} (c_o^3 - c_i^3) \\ &= \frac{2\pi (210)(10^6)}{3} (0.035^3 - 0.03^3) \\ &= 6982.19 \text{ N}\cdot\text{m} = 6.98 \text{ kN}\cdot\text{m} \end{aligned}$$

Ans

Angle of Twist :

$$\phi_p = \frac{\gamma_{\max} L}{c_o} = \left(\frac{0.006}{0.035} \right) (2) = 0.34286 \text{ rad}$$

When a reverse torque of $T_p = 6982.19 \text{ N}\cdot\text{m}$ is applied,

$$G = \frac{\tau_Y}{\gamma_Y} = \frac{210(10^6)}{0.003} = 70 \text{ GPa}$$

$$\phi_p' = \frac{T_p L}{JG} = \frac{6982.19(2)}{\frac{\pi}{2}(0.035^4 - 0.03^4)(70)(10^9)} = 0.18389 \text{ rad}$$

Permanent angle of twist,

$$\begin{aligned} \phi_r &= \phi_p - \phi_p' \\ &= 0.34286 - 0.18389 = 0.1590 \text{ rad} = 9.11^\circ \end{aligned}$$

Ans

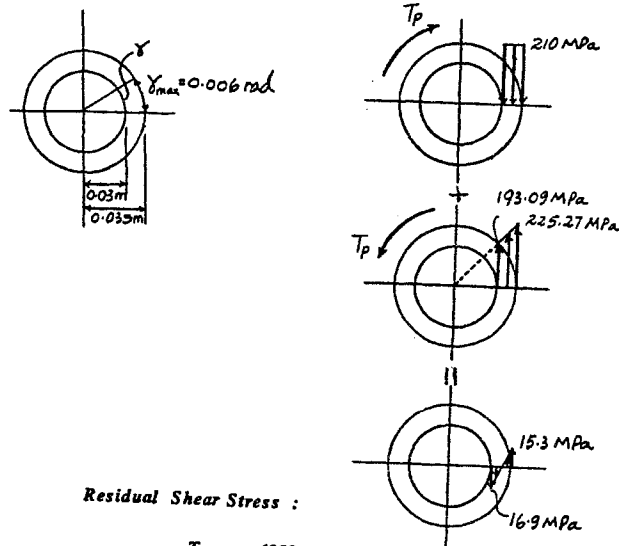

Residual Shear Stress :

$$\tau_p' = \frac{T_p c}{J} = \frac{6982.19(0.035)}{\frac{\pi}{2}(0.035^4 - 0.03^4)} = 225.27 \text{ MPa}$$

$$\tau_p'' = \frac{T_p \rho}{J} = \frac{6982.19(0.03)}{\frac{\pi}{2}(0.035^4 - 0.03^4)} = 193.09 \text{ MPa}$$

$$(\tau_r)_o = -\tau_Y + \tau_p'' = -210 + 225.27 = 15.3 \text{ MPa}$$

$$(\tau_r)_i = -\tau_Y + \tau_p' = -210 + 193.09 = -16.9 \text{ MPa}$$

From *Mechanics of Materials*, Sixth Edition by R. C. Hibbeler, ISBN 0-13-191345-X.

© 2005 R. C. Hibbeler. Published by Pearson Prentice Hall,

Pearson Education, Inc., Upper Saddle River, NJ. All rights reserved.

This material is protected under all copyright laws as they currently exist. No portion of this material may be reproduced, in any form or by any means, without permission in writing from the publisher.

5-130 The solid shaft is made from an elastic-plastic material as shown. Determine the torque T needed to form an elastic core in the shaft having a radius of $\rho_Y = 23$ mm. If the shaft is 2 m long, through what angle does one end of the shaft twist with respect to the other end? When the torque is removed, determine the residual stress distribution in the shaft and the permanent angle of twist.

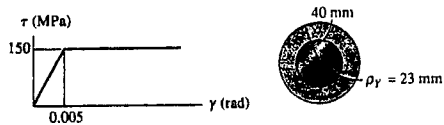

Use Eq. 5-26 of the text.

$$T = \frac{\pi \tau_Y}{6} (4c^3 - \rho_Y^3) = \frac{\pi (150)(10^6)}{6} (4(0.04^3) - 0.023^3) = 19\,151 \text{ N}\cdot\text{m} = 19.2 \text{ kN}\cdot\text{m} \quad \text{Ans}$$

$$\phi = \frac{\gamma L}{\rho} = \frac{\gamma_Y L}{\rho_Y} = \frac{0.005(2)(1000)}{23} = 0.4348 \text{ rad} = 24.9^\circ \quad \text{Ans}$$

An opposite torque $T = 19\,151 \text{ N}\cdot\text{m}$ is applied :

$$\tau_r = \frac{TC}{J} = \frac{19\,151(0.04)}{\frac{\pi}{2}(0.04^4)} = 190 \text{ MPa}$$

$$G = \frac{150(10^6)}{0.005} = 30 \text{ GPa}$$

$$\phi_p = \frac{TL}{JG} = \frac{19\,151(2)}{\frac{\pi}{2}(0.04^4)(30)(10^9)} = 0.3175 \text{ rad}$$

$$\phi_r = 0.4348 - 0.3175 = 0.117 \text{ rad} = 6.72^\circ \quad \text{Ans}$$

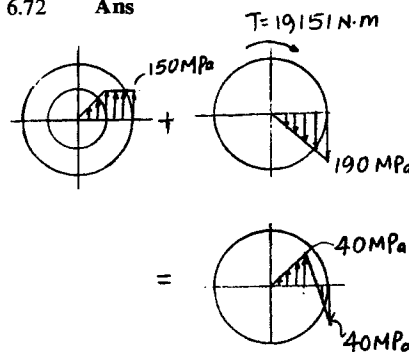

From *Mechanics of Materials*, Sixth Edition by R. C. Hibbeler, ISBN 0-13-191345-X.

© 2005 R. C. Hibbeler. Published by Pearson Prentice Hall,

Pearson Education, Inc., Upper Saddle River, NJ. All rights reserved.

This material is protected under all copyright laws as they currently exist. No portion of this material may be reproduced, in any form or by any means, without permission in writing from the publisher.

5-131 A 1.5-in.-diameter shaft is made from an elastic-plastic material as shown. Determine the radius of its elastic core if it is subjected to a torque of $T = 200 \text{ lb} \cdot \text{ft}$. If the shaft is 10 in. long, determine the angle of twist.

Use Eq. 5-26 from the text :

$$T = \frac{\pi \tau_Y}{6} (4c^3 - \rho_Y^3)$$

$$200(12) = \frac{\pi (3)(10^3)}{6} [4(0.75^3) - \rho_Y^3]$$

$$\rho_Y = 0.542 \text{ in.}$$

Ans

$$\phi = \frac{\gamma_Y L}{\rho_Y} = \frac{0.006}{0.542}(10) = 0.111 \text{ rad} = 6.34^\circ$$

Ans

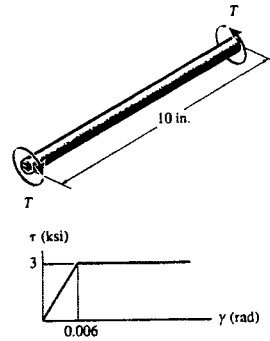

From *Mechanics of Materials*, Sixth Edition by R. C. Hibbeler, ISBN 0-13-191345-X.

© 2005 R. C. Hibbeler. Published by Pearson Prentice Hall,

Pearson Education, Inc., Upper Saddle River, NJ. All rights reserved.

This material is protected under all copyright laws as they currently exist. No portion of this material may be reproduced, in any form or by any means, without permission in writing from the publisher.

*5-132 The shaft is subjected to a maximum shear strain of 0.0048 rad. Determine the torque applied to the shaft if the material has strain-hardening as shown by the shear stress-strain diagram.

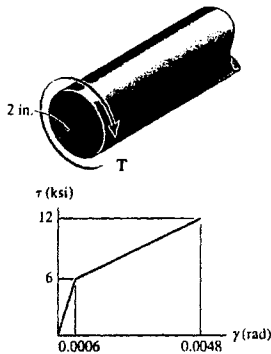

From the shear-strain diagram,

$$\frac{\rho\gamma}{0.0006} = \frac{2}{0.0048}; \quad \rho\gamma = 0.25 \text{ in.}$$

From the shear stress-strain diagram,

$$\tau_1 = \frac{6}{0.25}\rho = 24\rho$$

$$\frac{\tau_2 - 6}{\rho - 0.25} = \frac{12 - 6}{2 - 0.25}; \quad \tau_2 = 3.4286\rho + 5.1429$$

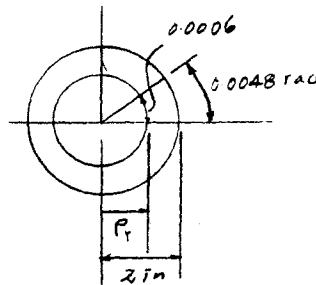

$$\begin{aligned} T &= 2\pi \int_0^c \tau \rho^2 d\rho \\ &= 2\pi \int_0^{0.25} 24\rho^3 d\rho + 2\pi \int_{0.25}^2 (3.4286\rho + 5.1429) \rho^2 d\rho \\ &= 2\pi [6\rho^4]_0^{0.25} + 2\pi \left[\frac{3.4286\rho^4}{4} + \frac{5.1429\rho^3}{3} \right]_{0.25}^2 \\ &= 172.30 \text{ kip}\cdot\text{in.} = 14.4 \text{ kip}\cdot\text{ft} \end{aligned}$$

Ans

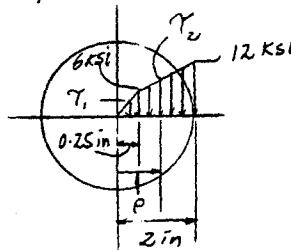

From *Mechanics of Materials*, Sixth Edition by R. C. Hibbeler, ISBN 0-13-191345-X.

© 2005 R. C. Hibbeler. Published by Pearson Prentice Hall,

Pearson Education, Inc., Upper Saddle River, NJ. All rights reserved.

This material is protected under all copyright laws as they currently exist. No portion of this material may be reproduced, in any form or by any means, without permission in writing from the publisher.

5-133 A torque is applied to the shaft of radius r . If the material has a shear stress-strain relation of $\tau = k\gamma^{1/6}$, where k is a constant, determine the maximum shear stress in the shaft.

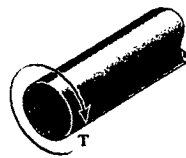

$$\gamma = \frac{\rho}{c} \gamma_{\max} = \frac{\rho}{r} \gamma_{\max}$$

$$\tau = k\gamma^{1/6} = k \left(\frac{\gamma_{\max}}{r} \right)^{1/6} \rho^{1/6}$$

$$T = 2\pi \int_0^r \tau \rho^2 d\rho$$

$$= 2\pi \int_0^r k \left(\frac{\gamma_{\max}}{r} \right)^{1/6} \rho^{13/6} d\rho = 2\pi k \left(\frac{\gamma_{\max}}{r} \right)^{1/6} \left(\frac{6}{19} \right) r^{19/6} = \frac{12\pi k \gamma_{\max}^{1/6} r^3}{19}$$

$$\gamma_{\max} = \left(\frac{19T}{12\pi k r^3} \right)^6$$

$$\tau_{\max} = k \gamma_{\max}^{1/6} = \frac{19T}{12\pi r^3} \quad \text{Ans}$$

From *Mechanics of Materials*, Sixth Edition by R. C. Hibbeler, ISBN 0-13-191345-X.

© 2005 R. C. Hibbeler. Published by Pearson Prentice Hall,

Pearson Education, Inc., Upper Saddle River, NJ. All rights reserved.

This material is protected under all copyright laws as they currently exist. No portion of this material may be reproduced, in any form or by any means, without permission in writing from the publisher.

5-134 Consider a thin-walled tube of mean radius r and thickness t . Show that the maximum shear stress in the tube due to an applied torque T approaches the average shear stress computed from Eq. 5-18 as $r/t \rightarrow \infty$.

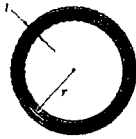

$$r_o = r + \frac{t}{2} = \frac{2r + t}{2}; \quad r_i = r - \frac{t}{2} = \frac{2r - t}{2}$$

$$J = \frac{\pi}{2} \left[\left(\frac{2r + t}{2} \right)^4 - \left(\frac{2r - t}{2} \right)^4 \right]$$

$$= \frac{\pi}{32} [(2r + t)^4 - (2r - t)^4] = \frac{\pi}{32} [64r^3t + 16rt^3]$$

$$\tau_{\max} = \frac{Tc}{J}; \quad c = r_o = \frac{2r + t}{2}$$

$$= \frac{T \left(\frac{2r + t}{2} \right)}{\frac{\pi}{32} [64r^3t + 16rt^3]} = \frac{T \left(\frac{2r + t}{2} \right)}{2\pi r t \left[r^2 + \frac{1}{4}t^2 \right]}$$

$$= \frac{T \left(\frac{2r}{2r^2} + \frac{t}{2r^2} \right)}{2\pi r t \left[\frac{r^2}{r^2} + \frac{1}{4} \frac{t^2}{r^2} \right]}$$

As $\frac{r}{t} \rightarrow \infty$, then $\frac{t}{r} \rightarrow 0$

$$\tau_{\max} = \frac{T \left(\frac{1}{r} + 0 \right)}{2\pi r t (1 + 0)} = \frac{T}{2\pi r^2 t}$$

$$= \frac{T}{2tA_m} \quad \text{QED}$$

From *Mechanics of Materials*, Sixth Edition by R. C. Hibbeler, ISBN 0-13-191345-X.

© 2005 R. C. Hibbeler. Published by Pearson Prentice Hall,

Pearson Education, Inc., Upper Saddle River, NJ. All rights reserved.

This material is protected under all copyright laws as they currently exist. No portion of this material may be reproduced, in any form or by any means, without permission in writing from the publisher.

5-135 The pipe has an outer diameter of 0.75 in. and an inner diameter of 0.68 in. If it is tightly secured to the flange, determine the maximum shear stress developed in the pipe when the couple shown is applied to the handles of the wrench.

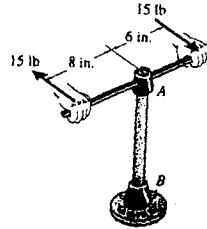

$$T - 15(6) - 15(8) = 0$$

$$T = 210 \text{ lb} \cdot \text{in.}$$

$$\tau_{\max} = \frac{Tc}{J} = \frac{210(0.375)}{\frac{\pi}{2}(0.375^4 - 0.34^4)}$$

$$= 7.82 \text{ ksi} \quad \text{Ans}$$

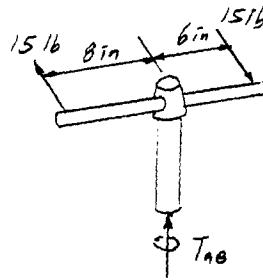

From *Mechanics of Materials*, Sixth Edition by R. C. Hibbeler, ISBN 0-13-191345-X.
 © 2005 R. C. Hibbeler. Published by Pearson Prentice Hall,
 Pearson Education, Inc., Upper Saddle River, NJ. All rights reserved.
 This material is protected under all copyright laws as they currently exist. No portion of this material may be reproduced, in any form or by any means, without permission in writing from the publisher.

*5-136 The pipe has an outer diameter of 0.75 in. and an inner diameter of 0.68 in. If it is tightly secured to the flange at *B*, determine the shear-stress distribution acting along a radial line lying on the midsection of the pipe when the couple shown is applied to the handles of the wrench.

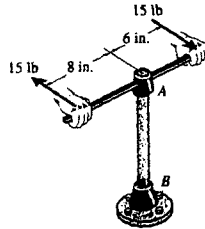

See Prob. 5 - 135.

$$\tau_{\max} = 7.82 \text{ ksi}$$

At $\rho = 0.34$ in.

$$\tau = \frac{T\rho}{J} = \frac{210(0.34)}{\frac{\pi}{2}((0.375)^4 - (0.34)^4)} = 7.09 \text{ ksi} \quad \text{Ans}$$

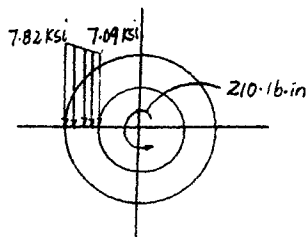

From *Mechanics of Materials*, Sixth Edition by R. C. Hibbeler, ISBN 0-13-191345-X.

© 2005 R. C. Hibbeler. Published by Pearson Prentice Hall,

Pearson Education, Inc., Upper Saddle River, NJ. All rights reserved.

This material is protected under all copyright laws as they currently exist. No portion of this material may be reproduced, in any form or by any means, without permission in writing from the publisher.

5-137 The drilling pipe on an oil rig is made from steel pipe having an outside diameter of 4.5 in. and a thickness of 0.25 in. If the pipe is turning at 650 rev/min while being powered by a 15-hp motor, determine the maximum shear stress in the pipe.

$$\omega = \frac{650(2\pi)}{60} = 68.068 \text{ rad/s}$$

$$P = T\omega$$

$$15(550) = T(68.068)$$

$$T = 121.20 \text{ lb}\cdot\text{ft}$$

$$\tau_{\max} = \frac{Tc}{J} = \frac{121.20(12)(2.25)}{\frac{\pi}{2}(2.25^4 - 2^4)} = 216 \text{ psi} \quad \text{Ans}$$

From *Mechanics of Materials*, Sixth Edition by R. C. Hibbeler, ISBN 0-13-191345-X.

© 2005 R. C. Hibbeler. Published by Pearson Prentice Hall,

Pearson Education, Inc., Upper Saddle River, NJ. All rights reserved.

This material is protected under all copyright laws as they currently exist. No portion of this material may be reproduced, in any form or by any means, without permission in writing from the publisher.

5-138 The tapered shaft is made from 2014-T6 aluminum alloy, and has a radius which can be described by the function $r = 0.02(1 + x^{3/2})$ m, where x is in meters. Determine the angle of twist of its end A if it is subjected to a torque of $450 \text{ N} \cdot \text{m}$.

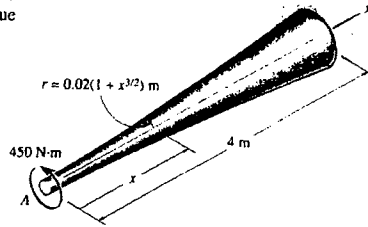

$$T = 450 \text{ N} \cdot \text{m}$$

$$\phi_A = \int \frac{T dx}{JG} = \int_0^4 \frac{450 dx}{\frac{\pi}{2}(0.02)^4(1 + x^{3/2})^4(27)(10^9)} = 0.0666315 \int_0^4 \frac{dx}{(1 + x^{3/2})^4}$$

Evaluating the integral using Simpson's rule, we have

$$\begin{aligned} \phi_A &= 0.0666315[0.4179] \text{ rad} \\ &= 0.0277 \text{ rad} = 1.59^\circ \quad \text{Ans} \end{aligned}$$

From *Mechanics of Materials*, Sixth Edition by R. C. Hibbeler, ISBN 0-13-191345-X.

© 2005 R. C. Hibbeler. Published by Pearson Prentice Hall,

Pearson Education, Inc., Upper Saddle River, NJ. All rights reserved.

This material is protected under all copyright laws as they currently exist. No portion of this material may be reproduced, in any form or by any means, without permission in writing from the publisher.

5-139. If the solid shaft AB to which the valve handle is attached is made of C83400 red brass and has a diameter of 10 mm, determine the maximum couple forces F that can be applied to the handle just before the material starts to fail. Take $\tau_{\text{allow}} = 40 \text{ MPa}$. What is the angle of twist of the handle? The shaft is fixed at A .

$$\tau_{\text{max}} = \tau_{\text{allow}} = \frac{Tc}{J}$$

$$40(10^6) = \frac{0.3F(0.005)}{\frac{\pi}{2}(0.005)^4}$$

$$F = 26.18 \text{ N} = 26.2 \text{ N}$$

$$T = 0.3F = 7.85 \text{ N}\cdot\text{m}$$

$$\phi = \frac{TL}{JG} = \frac{7.85(0.15)}{\frac{\pi}{2}(0.005)^4(37)(10^9)} = 0.03243 \text{ rad} = 1.86^\circ$$

Ans

Ans

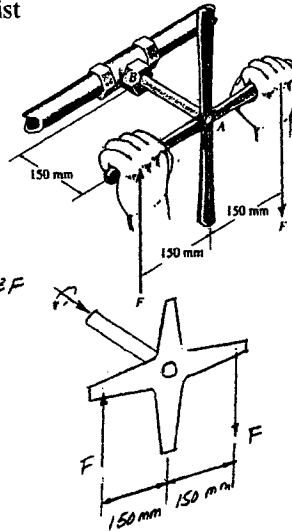

From *Mechanics of Materials*, Sixth Edition by R. C. Hibbeler, ISBN 0-13-191345-X.
 © 2005 R. C. Hibbeler. Published by Pearson Prentice Hall,
 Pearson Education, Inc., Upper Saddle River, NJ. All rights reserved.
 This material is protected under all copyright laws as they currently exist. No portion of this material may be reproduced, in any form or by any means, without permission in writing from the publisher.

***5-140.** If the solid shaft AB to which the valve handle is attached is made of C83400 red brass, determine the smallest diameter of the handle so that the angle of twist does not exceed 0.5° and the shear stress does not exceed 40 MPa when $F = 25 \text{ N}$.

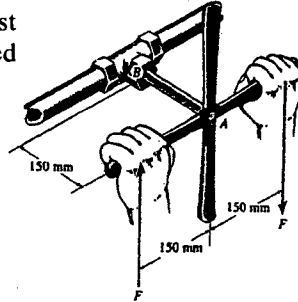

Failure by shear :
 $T = 25(0.3) = 7.5 \text{ N} \cdot \text{m}$

$$\tau_{\text{allow}} = \frac{Tc}{J} ; \quad 40(10^6) = \frac{7.5c}{\frac{\pi}{2}c^4}$$

$$c = 4.92 \text{ in.}$$

$$d = 9.85 \text{ mm}$$

Failure by twist :

$$\phi = \frac{TL}{JG} ; \quad 0.5\left(\frac{\pi}{180^\circ}\right) = \frac{7.5(0.15)}{\frac{\pi}{2}(c)^4(37)(10^9)}$$

$$c = 6.86 \text{ mm}$$

$$d = 13.7 \text{ mm (controls)}$$

Ans

From *Mechanics of Materials*, Sixth Edition by R. C. Hibbeler, ISBN 0-13-191345-X.

© 2005 R. C. Hibbeler. Published by Pearson Prentice Hall,

Pearson Education, Inc., Upper Saddle River, NJ. All rights reserved.

This material is protected under all copyright laws as they currently exist. No portion of this material may be reproduced, in any form or by any means, without permission in writing from the publisher.

5-141 The material of which each of three shafts is made has a yield stress of τ_y and a shear modulus of G . Determine which shaft geometry will resist the largest torque without yielding. What percentage of this torque can be carried by the other two shafts? Assume that each shaft is made of the same amount of material and that it has the same cross-sectional area A .



For circular shaft :

$$A = \pi c^2; \quad c = \left(\frac{A}{\pi}\right)^{\frac{1}{2}}$$

$$\tau_{\max} = \frac{Tc}{J}; \quad \tau_y = \frac{Tc}{\frac{\pi}{2}c^4}$$

$$T = \frac{\pi c^3}{2} \tau_y = \frac{\pi \left(\frac{A}{\pi}\right)^{\frac{3}{2}}}{2} \tau_y$$

$$T_{\text{cir}} = 0.282 A^{\frac{3}{2}} \tau_y \quad \text{Ans}$$

For the square shaft :

$$A = a^2; \quad a = A^{\frac{1}{2}}$$

$$\tau_{\max} = \frac{4.81T}{a^3}; \quad \tau_y = \frac{4.81T}{A^{\frac{3}{2}}}$$

$$T = 0.2079 A^{\frac{3}{2}} \tau_y$$

For the triangular shaft :

$$A = \frac{1}{2}(a)(a \sin 60^\circ); \quad a = 1.5197A^{\frac{1}{2}}$$

$$\tau_{\max} = \frac{20T}{a^3}; \quad \tau_y = \frac{20T}{(1.5197)^3 A^{\frac{3}{2}}}$$

$$T = 0.1755A^{\frac{3}{2}} \tau_y$$

The circular shaft will carry the largest torque. **Ans.**

For the square shaft

$$\% = \frac{0.2079}{0.2821} (100\%) = 73.7\% \quad \text{Ans}$$

For the triangular shaft ,

$$\% = \frac{0.1755}{0.2821} (100\%) = 62.2\% \quad \text{Ans}$$

From *Mechanics of Materials*, Sixth Edition by R. C. Hibbeler, ISBN 0-13-191345-X.

© 2005 R. C. Hibbeler. Published by Pearson Prentice Hall,

Pearson Education, Inc., Upper Saddle River, NJ. All rights reserved.

This material is protected under all copyright laws as they currently exist. No portion of this material may be reproduced, in any form or by any means, without permission in writing from the publisher.

5-142 The 60-mm-diameter shaft rotates at 300 rev/min. This motion is caused by the unequal belt tensions on the pulley of 800 N and 450 N. Determine the power transmitted and the maximum shear stress developed in the shaft.

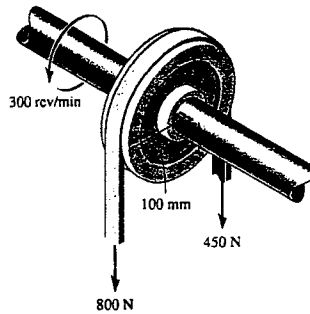

$$\omega = 300 \frac{\text{rev}}{\text{min}} \left[\frac{2\pi \text{ rad}}{1 \text{ rev}} \right] \frac{1 \text{ min}}{60 \text{ s}} = 10\pi \text{ rad/s}$$

$$T + 450(0.1) - 800(0.1) = 0$$

$$T = 35.0 \text{ N} \cdot \text{m}$$

$$P = T\omega = 35.0(10\pi) = 1100 \text{ W} = 1.10 \text{ kW} \quad \text{Ans}$$

$$\tau_{\max} = \frac{Tc}{J} = \frac{35.0(0.03)}{\frac{\pi}{2}(0.03^4)} = 825 \text{ kPa} \quad \text{Ans}$$

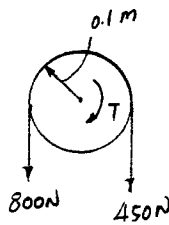

From *Mechanics of Materials*, Sixth Edition by R. C. Hibbeler, ISBN 0-13-191345-X.

© 2005 R. C. Hibbeler. Published by Pearson Prentice Hall,

Pearson Education, Inc., Upper Saddle River, NJ. All rights reserved.

This material is protected under all copyright laws as they currently exist. No portion of this material may be reproduced, in any form or by any means, without permission in writing from the publisher.

5-143 The aluminum tube has a thickness of 5 mm and the outer cross-sectional dimensions shown. Determine the maximum average shear stress in the tube. If the tube has a length of 5 m, determine the angle of twist. $G_{al} = 28 \text{ GPa}$.

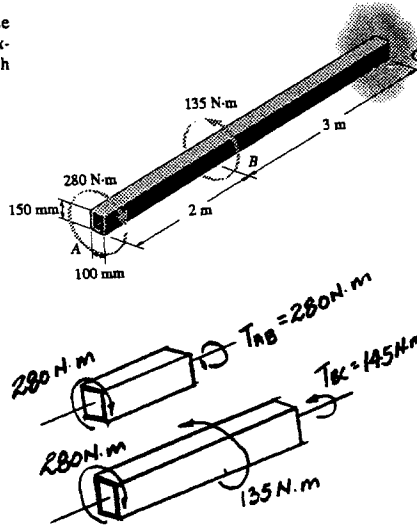

$$A_m = (0.145)(0.095) = 0.013775 \text{ m}^2$$

$$(\tau_{avg})_{max} = \frac{T_{AB}}{2A_mt} = \frac{280}{2(0.013775)(0.005)}$$

$$= 2.03 \text{ MPa} \quad \text{Ans}$$

$$\phi = \frac{TL}{4A_m^2 G} \int \frac{ds}{t}$$

$$\int \frac{ds}{t} = \frac{2(0.145) + 2(0.095)}{0.005} = 96$$

$$\phi = \frac{96}{4(0.013775)^2(28)(10^9)} [280(2) + 145(3)] = 0.00449 \text{ rad} = 0.258^\circ \quad \text{Ans}$$

From *Mechanics of Materials*, Sixth Edition by R. C. Hibbeler, ISBN 0-13-191345-X.

© 2005 R. C. Hibbeler. Published by Pearson Prentice Hall,

Pearson Education, Inc., Upper Saddle River, NJ. All rights reserved.

This material is protected under all copyright laws as they currently exist. No portion of this material may be reproduced, in any form or by any means, without permission in writing from the publisher.

6-1. Draw the shear and moment diagrams for the shaft. The bearings at *A* and *B* exert only vertical reactions on the shaft.

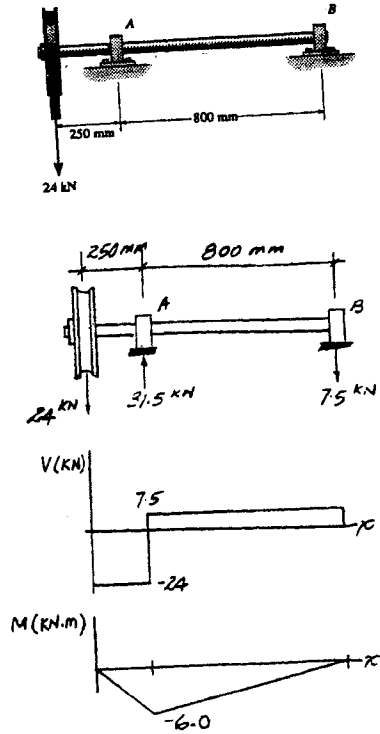

From *Mechanics of Materials*, Sixth Edition by R. C. Hibbeler, ISBN 0-13-191345-X.
 © 2005 R. C. Hibbeler. Published by Pearson Prentice Hall,
 Pearson Education, Inc., Upper Saddle River, NJ. All rights reserved.
 This material is protected under all copyright laws as they currently exist. No portion of this material may be reproduced, in any form or by any means, without permission in writing from the publisher.

6-2 The load binder is used to support a load. If the force applied to the handle is 50 lb, determine the tensions T_1 and T_2 in each end of the chain and then draw the shear and moment diagrams for the arm ABC .

$$\begin{aligned} \curvearrowleft + \Sigma M_C = 0; & \quad -50(15) + T_1(3) = 0 \\ & \quad T_1 = 250 \text{ lb} \end{aligned}$$

Ans

$$\begin{aligned} + \uparrow \Sigma F_y = 0; & \quad 50 - 250 + T_2 = 0 \\ & \quad T_2 = 200 \text{ lb} \end{aligned}$$

Ans

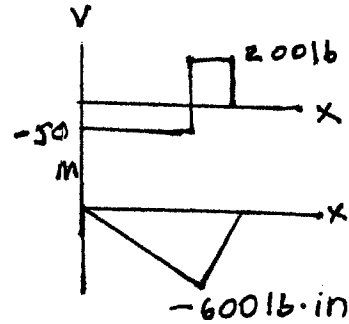
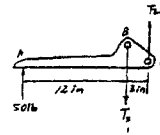
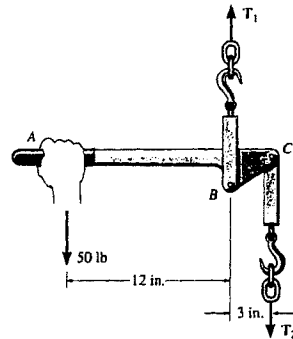

From *Mechanics of Materials*, Sixth Edition by R. C. Hibbeler, ISBN 0-13-191345-X.

© 2005 R. C. Hibbeler. Published by Pearson Prentice Hall,

Pearson Education, Inc., Upper Saddle River, NJ. All rights reserved.

This material is protected under all copyright laws as they currently exist. No portion of this material may be reproduced, in any form or by any means, without permission in writing from the publisher.

6-3 Draw the shear and moment diagrams for the shaft. The bearings at *A* and *D* exert only vertical reactions on the shaft. The loading is applied to the pulleys at *B* and *C* and *E*.

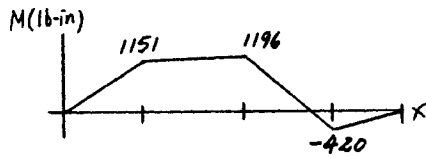
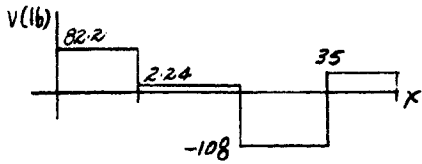
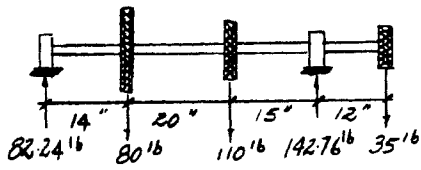
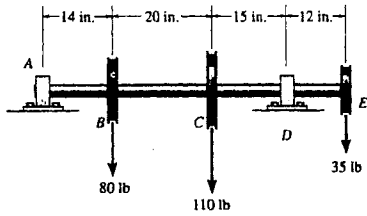

From *Mechanics of Materials*, Sixth Edition by R. C. Hibbeler, ISBN 0-13-191345-X.
 © 2005 R. C. Hibbeler. Published by Pearson Prentice Hall,
 Pearson Education, Inc., Upper Saddle River, NJ. All rights reserved.
 This material is protected under all copyright laws as they currently exist. No portion of this material may be reproduced, in any form or by any means, without permission in writing from the publisher.

*6-4 Draw the shear and moment diagrams for the beam.

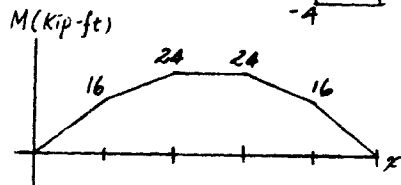
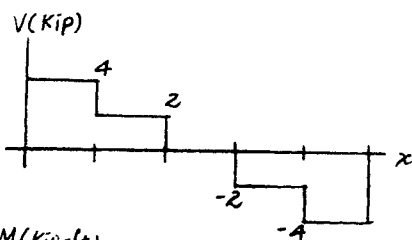
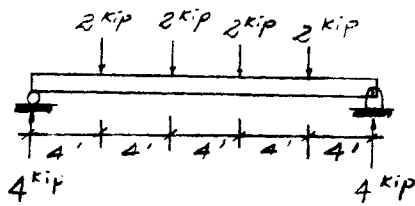
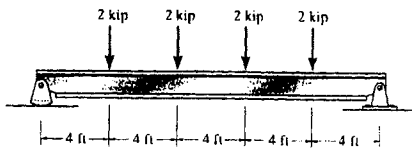

From *Mechanics of Materials*, Sixth Edition by R. C. Hibbeler, ISBN 0-13-191345-X.

© 2005 R. C. Hibbeler. Published by Pearson Prentice Hall,

Pearson Education, Inc., Upper Saddle River, NJ. All rights reserved.

This material is protected under all copyright laws as they currently exist. No portion of this material may be reproduced, in any form or by any means, without permission in writing from the publisher.

6-5 Draw the shear and moment diagrams for the rod. It is supported by a pin at A and a smooth plate at B . The plate slides within the groove and so it cannot support a vertical force, although it can support a moment.

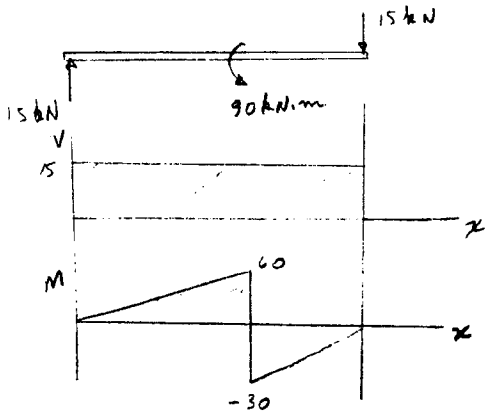
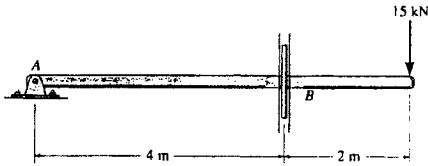

From *Mechanics of Materials*, Sixth Edition by R. C. Hibbeler, ISBN 0-13-191345-X.

© 2005 R. C. Hibbeler. Published by Pearson Prentice Hall,

Pearson Education, Inc., Upper Saddle River, NJ. All rights reserved.

This material is protected under all copyright laws as they currently exist. No portion of this material may be reproduced, in any form or by any means, without permission in writing from the publisher.

6-6. Draw the shear and moment diagrams for the shaft. The bearings at *A* and *B* exert only vertical reactions on the shaft. Also, express the shear and moment in the shaft as a function of *x* within the region $125 \text{ mm} < x < 725 \text{ mm}$.

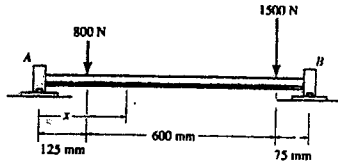

$$+\uparrow \Sigma F_y = 0; \quad 815.63 - 800 - V = 0$$

$$V = 15.6 \text{ N} \quad \text{Ans}$$

$$\curvearrowleft + \Sigma M = 0; \quad M + 800(x - 0.125) - 815.63x = 0$$

$$M = (15.6x + 100) \text{ N} \cdot \text{m} \quad \text{Ans}$$

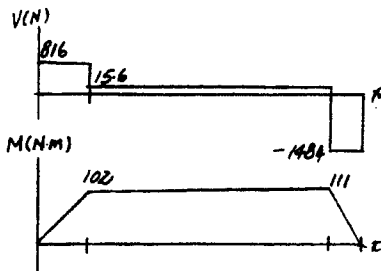
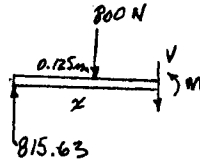
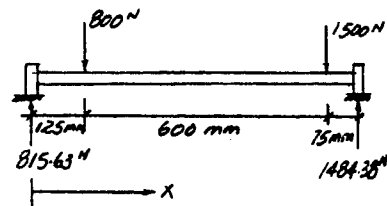

From *Mechanics of Materials*, Sixth Edition by R. C. Hibbeler, ISBN 0-13-191345-X.
 © 2005 R. C. Hibbeler. Published by Pearson Prentice Hall,
 Pearson Education, Inc., Upper Saddle River, NJ. All rights reserved.
 This material is protected under all copyright laws as they currently exist. No portion of this material may be reproduced, in any form or by any means, without permission in writing from the publisher.

6-7 Draw the shear and moment diagrams for the beam.

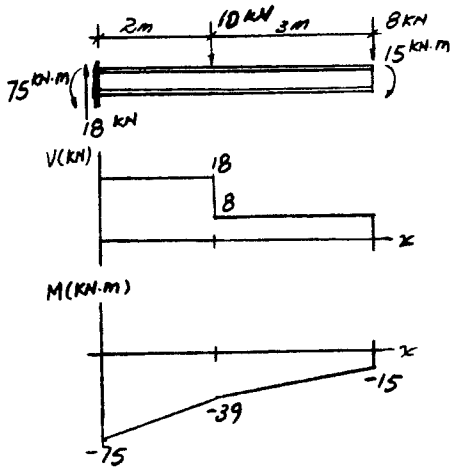
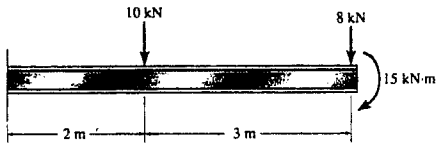

From *Mechanics of Materials*, Sixth Edition by R. C. Hibbeler, ISBN 0-13-191345-X.

© 2005 R. C. Hibbeler. Published by Pearson Prentice Hall,

Pearson Education, Inc., Upper Saddle River, NJ. All rights reserved.

This material is protected under all copyright laws as they currently exist. No portion of this material may be reproduced, in any form or by any means, without permission in writing from the publisher.

***6-8** Draw the shear and moment diagrams for the pipe. The end screw is subjected to a horizontal force of 5 kN. *Hint:* The reactions at the pin C must be replaced by equivalent loadings at point B on the axis of the pipe.

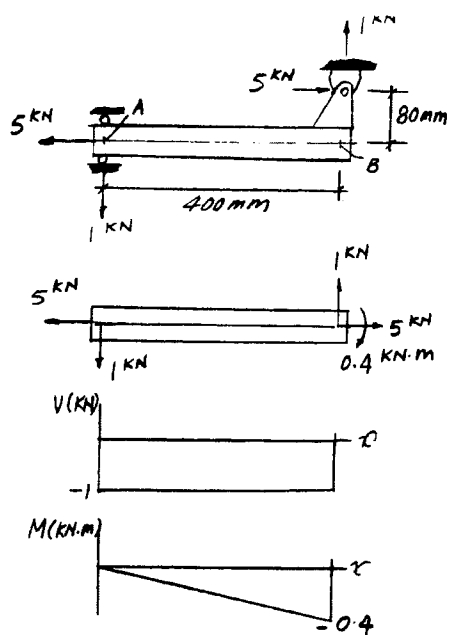
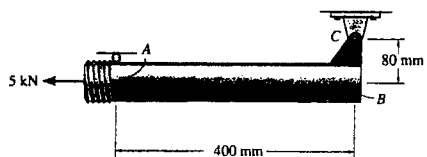

From *Mechanics of Materials*, Sixth Edition by R. C. Hibbeler, ISBN 0-13-191345-X.

© 2005 R. C. Hibbeler. Published by Pearson Prentice Hall,

Pearson Education, Inc., Upper Saddle River, NJ. All rights reserved.

This material is protected under all copyright laws as they currently exist. No portion of this material may be reproduced, in any form or by any means, without permission in writing from the publisher.

6-9 Draw the shear and moment diagrams for the beam.
 Hint: The 20-kip load must be replaced by equivalent loadings at point C on the axis of the beam.

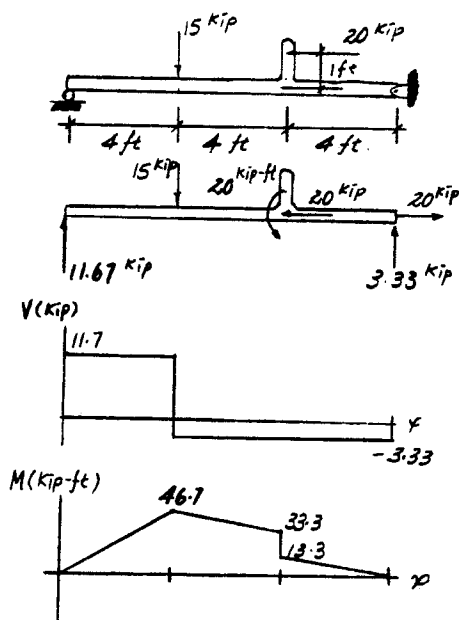
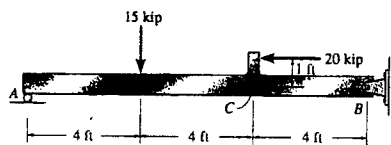

From *Mechanics of Materials*, Sixth Edition by R. C. Hibbeler, ISBN 0-13-191345-X.
 © 2005 R. C. Hibbeler. Published by Pearson Prentice Hall,
 Pearson Education, Inc., Upper Saddle River, NJ. All rights reserved.
 This material is protected under all copyright laws as they currently exist. No portion of this material may be reproduced, in any form or by any means, without permission in writing from the publisher.

6-10. The engine crane is used to support the engine, which has a weight of 1200 lb. Draw the shear and moment diagrams of the boom ABC when it is in the horizontal position shown.

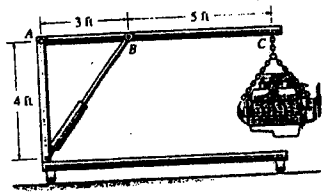

$$\left(+ \right) \Sigma M_A = 0; \quad \frac{4}{5}F_B(3) - 1200(8) = 0; \quad F_B = 4000 \text{ lb}$$

$$+ \uparrow \Sigma F_y = 0; \quad -A_y + \frac{4}{5}(4000) - 1200 = 0; \quad A_y = 2000 \text{ lb}$$

$$\left(+ \right) \Sigma F_x = 0; \quad A_x - \frac{3}{5}(4000) = 0; \quad A_x = 2400 \text{ lb}$$

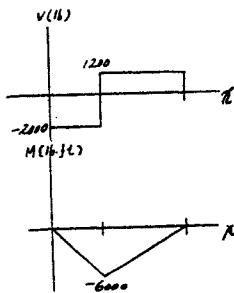
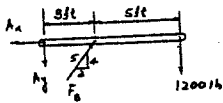

From *Mechanics of Materials*, Sixth Edition by R. C. Hibbeler, ISBN 0-13-191345-X.

© 2005 R. C. Hibbeler. Published by Pearson Prentice Hall,

Pearson Education, Inc., Upper Saddle River, NJ. All rights reserved.

This material is protected under all copyright laws as they currently exist. No portion of this material may be reproduced, in any form or by any means, without permission in writing from the publisher.

6-11 Determine the placement distance a of the roller support so that the largest absolute value of the moment is a minimum. Draw the shear and moment diagrams for this condition.

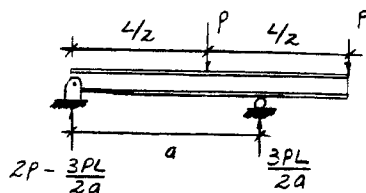
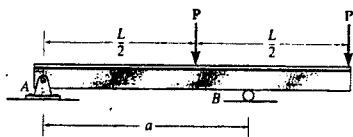

To get absolute minimum moment;

$$M_{\max(+)} = M_{\max(-)}$$

$$\frac{PL}{2} \left(2 - \frac{3L}{2a} \right) = P(L - a)$$

$$a = \frac{\sqrt{3}}{2} L = 0.866 L \quad \text{Ans}$$

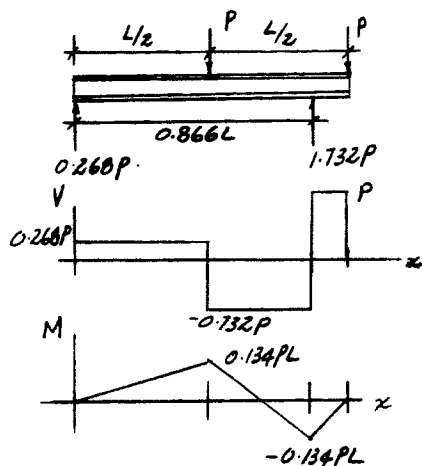
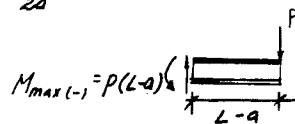
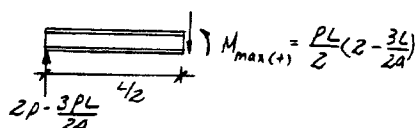

From *Mechanics of Materials*, Sixth Edition by R. C. Hibbeler, ISBN 0-13-191345-X.

© 2005 R. C. Hibbeler. Published by Pearson Prentice Hall,

Pearson Education, Inc., Upper Saddle River, NJ. All rights reserved.

This material is protected under all copyright laws as they currently exist. No portion of this material may be reproduced, in any form or by any means, without permission in writing from the publisher.

*6-12 Draw the shear and moment diagrams for the compound beam which is pin connected at *B*.

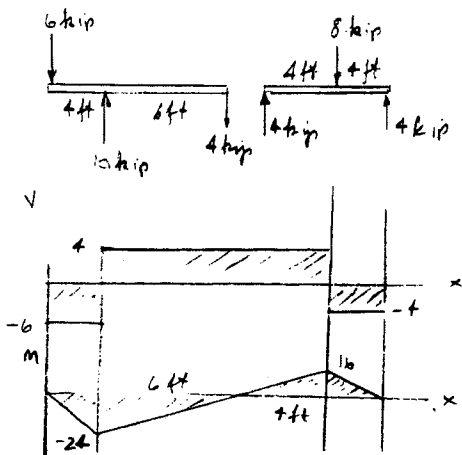
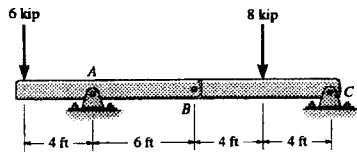

From *Mechanics of Materials*, Sixth Edition by R. C. Hibbeler, ISBN 0-13-191345-X.

© 2005 R. C. Hibbeler. Published by Pearson Prentice Hall,

Pearson Education, Inc., Upper Saddle River, NJ. All rights reserved.

This material is protected under all copyright laws as they currently exist. No portion of this material may be reproduced, in any form or by any means, without permission in writing from the publisher.

6-13 The bars are connected by pins at C and D . Draw the shear and moment diagrams for the assembly. Neglect the effect of axial load.

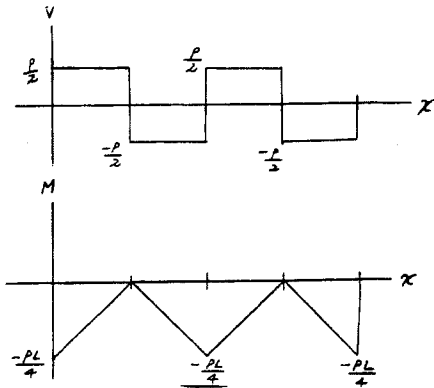
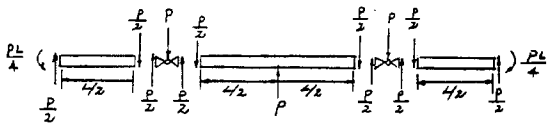
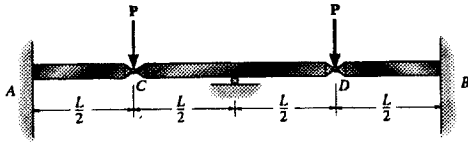

From *Mechanics of Materials*, Sixth Edition by R. C. Hibbeler, ISBN 0-13-191345-X.

© 2005 R. C. Hibbeler. Published by Pearson Prentice Hall,

Pearson Education, Inc., Upper Saddle River, NJ. All rights reserved.

This material is protected under all copyright laws as they currently exist. No portion of this material may be reproduced, in any form or by any means, without permission in writing from the publisher.

Because of the number and variety of potential correct solutions to this problem, no solution is being given.

From *Mechanics of Materials*, Sixth Edition by R. C. Hibbeler, ISBN 0-13-191345-X.

© 2005 R. C. Hibbeler. Published by Pearson Prentice Hall,

Pearson Education, Inc, Upper Saddle River, NJ. All rights reserved.

This material is protected under all copyright laws as they currently exist. No portion of this material may be reproduced, in any form or by any means, without permission in writing from the publisher.

6-15 Draw the shear and moment diagrams for the beam. Also, determine the shear and moment in the beam as functions of x , where $3 \text{ ft} < x \leq 15 \text{ ft}$.

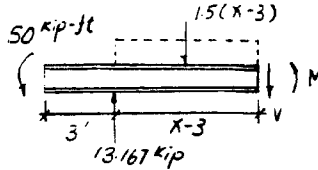
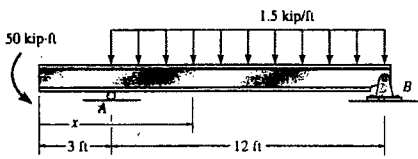

$$+\uparrow \Sigma F_y = 0; \quad -V - 1.5(x-3) + 13.167 = 0$$

$$V = 17.7 - 1.5x \quad \text{Ans}$$

$$\curvearrowleft \Sigma M = 0; \quad M + 1.5(x-3)\frac{(x-3)}{2} + 50 - 13.167(x-3) = 0$$

$$M = -0.75x^2 + 17.7x - 96.25 \quad \text{Ans}$$

$$V = 0 \text{ at } x = \frac{17.7}{1.5} = 11.778 \text{ ft}$$

$$M_{\max} = -0.75(11.778)^2 + 17.7(11.778) - 96.25 = 7.79 \text{ ft} \quad \text{Ans}$$

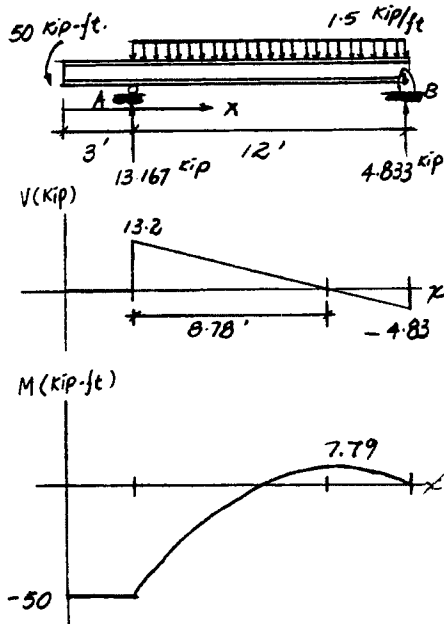

From *Mechanics of Materials*, Sixth Edition by R. C. Hibbeler, ISBN 0-13-191345-X.

© 2005 R. C. Hibbeler. Published by Pearson Prentice Hall,

Pearson Education, Inc., Upper Saddle River, NJ. All rights reserved.

This material is protected under all copyright laws as they currently exist. No portion of this material may be reproduced, in any form or by any means, without permission in writing from the publisher.

*6-16 Draw the shear and moment diagrams for the beam.

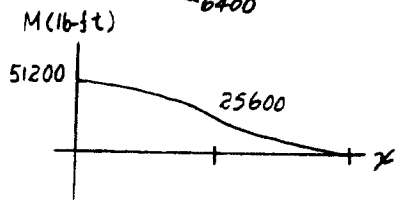
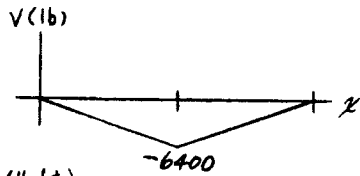
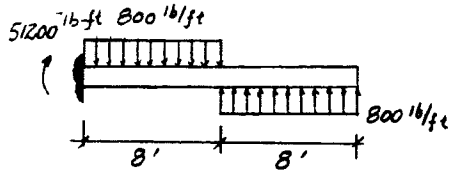
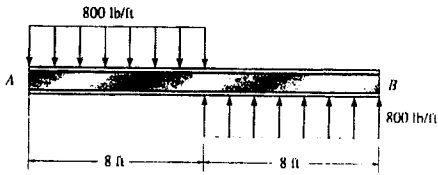

From *Mechanics of Materials*, Sixth Edition by R. C. Hibbeler, ISBN 0-13-191345-X.

© 2005 R. C. Hibbeler. Published by Pearson Prentice Hall,

Pearson Education, Inc., Upper Saddle River, NJ. All rights reserved.

This material is protected under all copyright laws as they currently exist. No portion of this material may be reproduced, in any form or by any means, without permission in writing from the publisher.

6-17 The 150-lb man sits in the center of the boat, which has a uniform width and a weight per linear foot of 3 lb/ft. Determine the maximum bending moment exerted on the boat. Assume that the water exerts a uniform distributed load upward on the bottom of the boat.

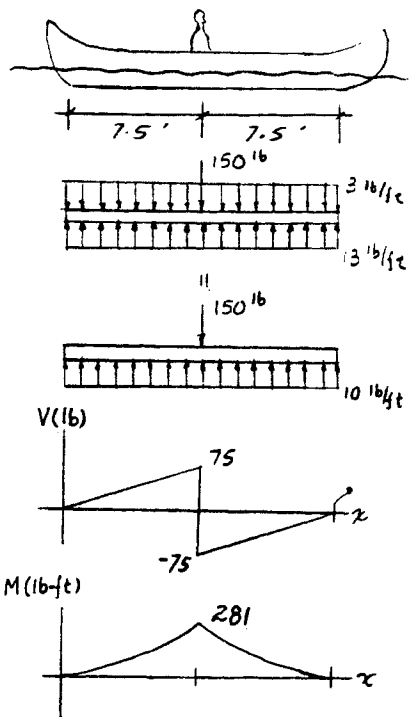
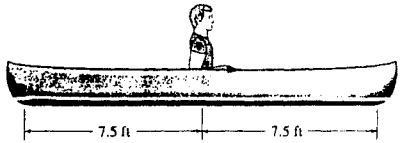

$M_{max} = 281 \text{ lb} \cdot \text{ft}$ Ans

From *Mechanics of Materials*, Sixth Edition by R. C. Hibbeler, ISBN 0-13-191345-X.
 © 2005 R. C. Hibbeler. Published by Pearson Prentice Hall,
 Pearson Education, Inc., Upper Saddle River, NJ. All rights reserved.
 This material is protected under all copyright laws as they currently exist. No portion of this material may be reproduced, in any form or by any means, without permission in writing from the publisher.

6-18 The footing supports the load transmitted by the two columns. Draw the shear and moment diagrams for the footing if the reaction of soil pressure on the footing is assumed to be uniform.

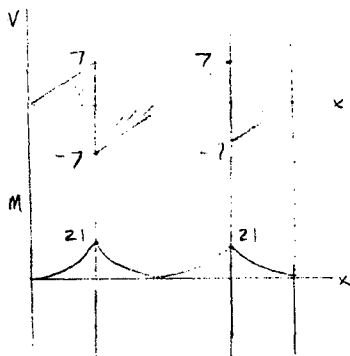
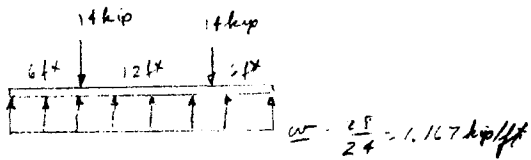
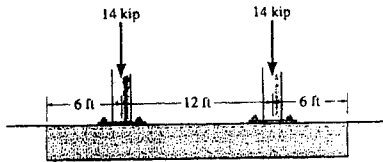

From *Mechanics of Materials*, Sixth Edition by R. C. Hibbeler, ISBN 0-13-191345-X.

© 2005 R. C. Hibbeler. Published by Pearson Prentice Hall,

Pearson Education, Inc., Upper Saddle River, NJ. All rights reserved.

This material is protected under all copyright laws as they currently exist. No portion of this material may be reproduced, in any form or by any means, without permission in writing from the publisher.

6-19 Draw the shear and moment diagrams for the beam.

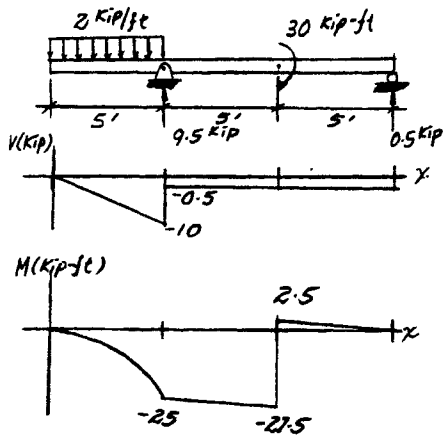
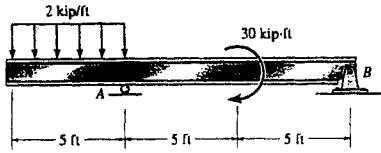

From *Mechanics of Materials*, Sixth Edition by R. C. Hibbeler, ISBN 0-13-191345-X.

© 2005 R. C. Hibbeler. Published by Pearson Prentice Hall,

Pearson Education, Inc., Upper Saddle River, NJ. All rights reserved.

This material is protected under all copyright laws as they currently exist. No portion of this material may be reproduced, in any form or by any means, without permission in writing from the publisher.

*6-20. The industrial robot is held in the stationary position shown. Draw the shear and moment diagrams of the arm ABC if it is pin connected at A and connected to a hydraulic cylinder (two-force member) BD . Assume the arm and grip have a uniform weight of 1.5 lb/in. and support the load of 40 lb at C .

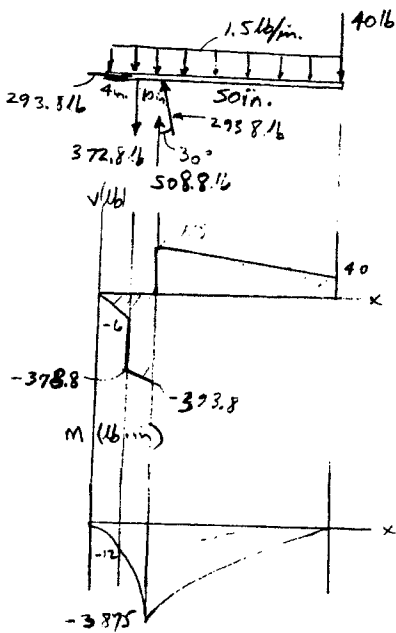
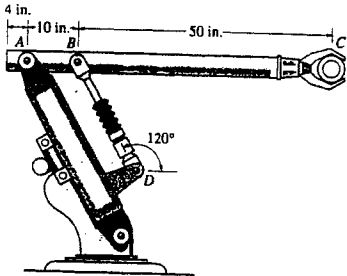

From *Mechanics of Materials*, Sixth Edition by R. C. Hibbeler, ISBN 0-13-191345-X.

© 2005 R. C. Hibbeler. Published by Pearson Prentice Hall,

Pearson Education, Inc., Upper Saddle River, NJ. All rights reserved.

This material is protected under all copyright laws as they currently exist. No portion of this material may be reproduced, in any form or by any means, without permission in writing from the publisher.

6-21 Draw the shear and moment diagrams for the beam and determine the shear and moment in the beam as functions of x , where $4 \text{ ft} < x < 10 \text{ ft}$.

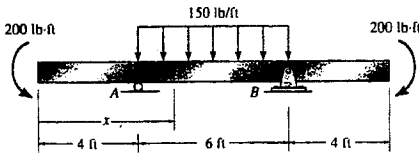

$$+\uparrow \Sigma F_y = 0; \quad -150(x-4) - V + 450 = 0$$

$$V = 1050 - 150x \quad \text{Ans}$$

$$\curvearrowright \Sigma M = 0; \quad -200 - 150(x-4)\frac{(x-4)}{2} - M + 450(x-4) = 0$$

$$M = -75x^2 + 1050x - 3200 \quad \text{Ans}$$

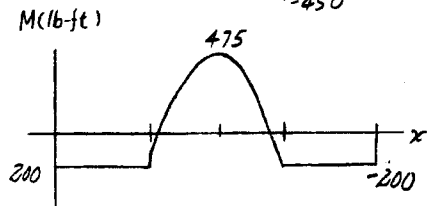
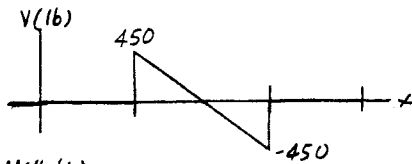
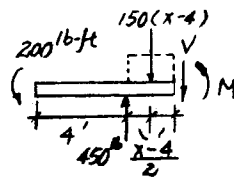
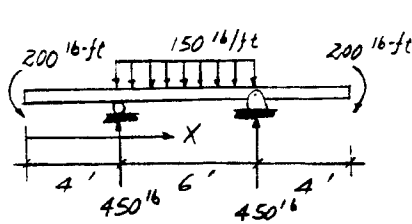

From *Mechanics of Materials*, Sixth Edition by R. C. Hibbeler, ISBN 0-13-191345-X.

© 2005 R. C. Hibbeler. Published by Pearson Prentice Hall,

Pearson Education, Inc., Upper Saddle River, NJ. All rights reserved.

This material is protected under all copyright laws as they currently exist. No portion of this material may be reproduced, in any form or by any means, without permission in writing from the publisher.

6-22 Draw the shear and moment diagrams for the compound beam. The three segments are connected by pins at *B* and *E*.

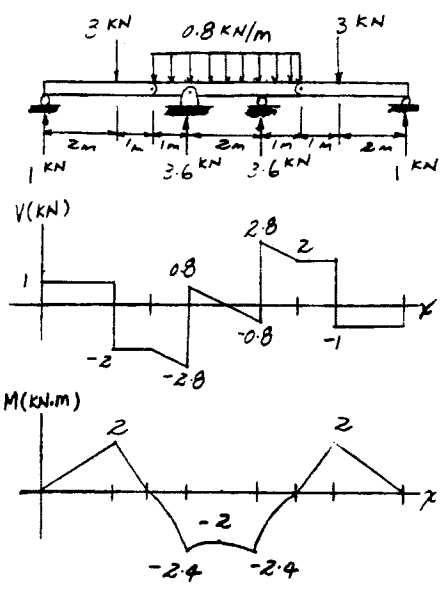
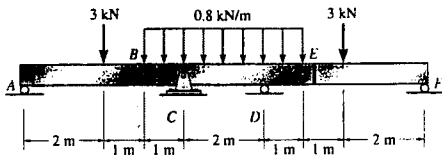

From *Mechanics of Materials*, Sixth Edition by R. C. Hibbeler, ISBN 0-13-191345-X.

© 2005 R. C. Hibbeler. Published by Pearson Prentice Hall,

Pearson Education, Inc., Upper Saddle River, NJ. All rights reserved.

This material is protected under all copyright laws as they currently exist. No portion of this material may be reproduced, in any form or by any means, without permission in writing from the publisher.

6-23 The T-beam is subjected to the loading shown. Draw the shear and moment diagrams for the beam.

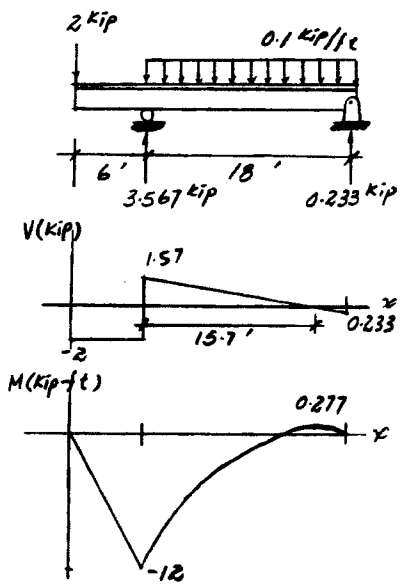
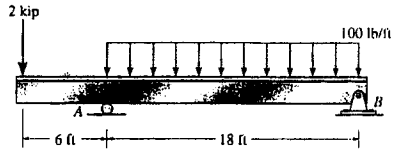

From *Mechanics of Materials*, Sixth Edition by R. C. Hibbeler, ISBN 0-13-191345-X.

© 2005 R. C. Hibbeler. Published by Pearson Prentice Hall,

Pearson Education, Inc., Upper Saddle River, NJ. All rights reserved.

This material is protected under all copyright laws as they currently exist. No portion of this material may be reproduced, in any form or by any means, without permission in writing from the publisher.

*6-24 The beam is bolted or pinned at A and rests on a bearing pad at B that exerts a uniform distributed loading on the beam over its 2-ft length. Draw the shear and moment diagrams for the beam if it supports a uniform loading of 2 kip/ft.

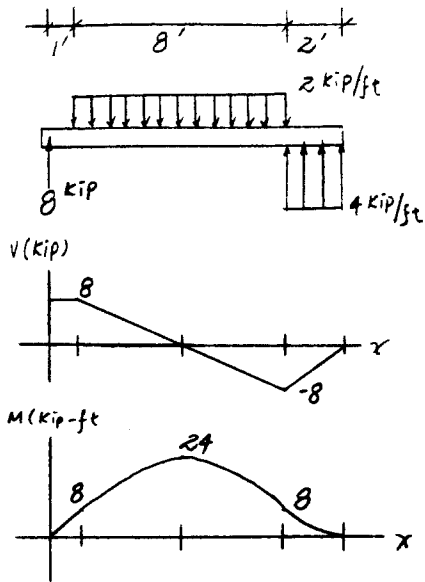
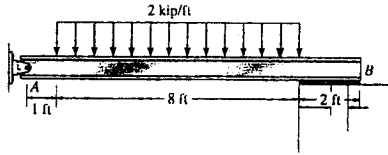

From *Mechanics of Materials*, Sixth Edition by R. C. Hibbeler, ISBN 0-13-191345-X.

© 2005 R. C. Hibbeler. Published by Pearson Prentice Hall,

Pearson Education, Inc., Upper Saddle River, NJ. All rights reserved.

This material is protected under all copyright laws as they currently exist. No portion of this material may be reproduced, in any form or by any means, without permission in writing from the publisher.

6-25 Draw the shear and moment diagrams for the beam. The two segments are joined together at B.

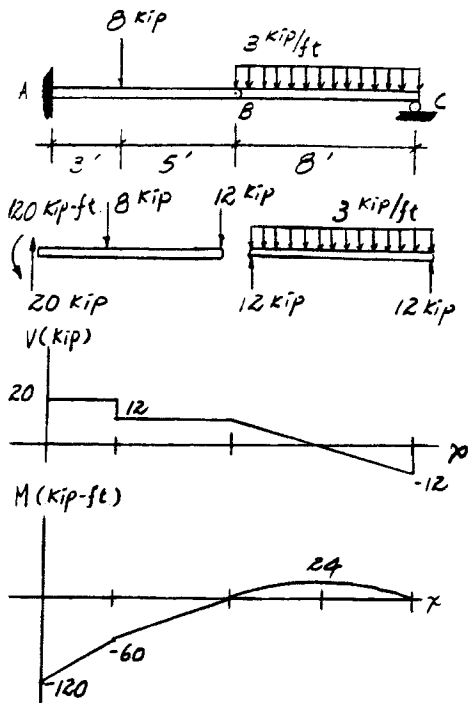
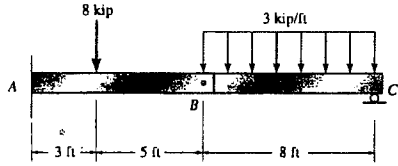

From *Mechanics of Materials*, Sixth Edition by R. C. Hibbeler, ISBN 0-13-191345-X.
 © 2005 R. C. Hibbeler. Published by Pearson Prentice Hall,
 Pearson Education, Inc., Upper Saddle River, NJ. All rights reserved.
 This material is protected under all copyright laws as they currently exist. No portion of this material may be reproduced, in any form or by any means, without permission in writing from the publisher.

Because of the number and variety of potential correct solutions to this problem, no solution is being given.

From *Mechanics of Materials*, Sixth Edition by R. C. Hibbeler, ISBN 0-13-191345-X.

© 2005 R. C. Hibbeler. Published by Pearson Prentice Hall,

Pearson Education, Inc, Upper Saddle River, NJ. All rights reserved.

This material is protected under all copyright laws as they currently exist. No portion of this material may be reproduced, in any form or by any means, without permission in writing from the publisher.

6-27 Determine the placement distance a of the roller support so that the largest absolute value of the moment is a minimum. Draw the shear and moment diagrams for this condition.

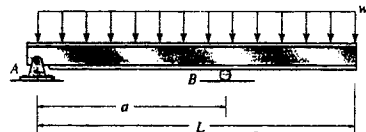

$$+\uparrow \Sigma F_y = 0; \quad wL - \frac{wL^2}{2a} - wx = 0$$

$$x = L - \frac{L^2}{2a}$$

$$(+\Sigma M = 0; \quad M_{\max (+)} + wx\left(\frac{x}{2}\right) - \left(wL - \frac{wL^2}{2a}\right)x = 0$$

Substitute $x = L - \frac{L^2}{2a}$;

$$M_{\max (+)} = \left(wL - \frac{wL^2}{2a}\right)\left(L - \frac{L^2}{2a}\right) - \frac{w}{2}\left(L - \frac{L^2}{2a}\right)^2$$

$$= \frac{w}{2}\left(L - \frac{L^2}{2a}\right)^2$$

$$\Sigma M = 0; \quad M_{\max (-)} - w(L-a)\frac{(L-a)}{2} = 0$$

$$M_{\max (-)} = \frac{w(L-a)^2}{2}$$

To get absolute minimum moment,

$$M_{\max (+)} = M_{\max (-)}$$

$$\frac{w}{2}\left(L - \frac{L^2}{2a}\right)^2 = \frac{w}{2}(L-a)^2$$

$$L - \frac{L^2}{2a} = L - a$$

$$a = \frac{L}{\sqrt{2}} \quad \text{Ans}$$

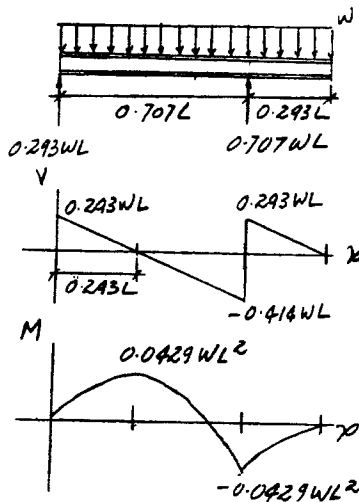
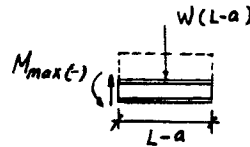
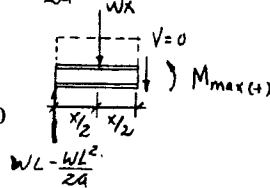
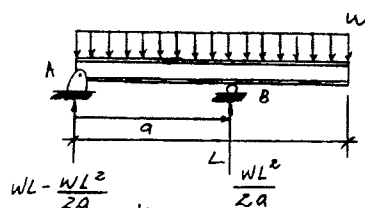

From *Mechanics of Materials*, Sixth Edition by R. C. Hibbeler, ISBN 0-13-191345-X.

© 2005 R. C. Hibbeler. Published by Pearson Prentice Hall,

Pearson Education, Inc., Upper Saddle River, NJ. All rights reserved.

This material is protected under all copyright laws as they currently exist. No portion of this material may be reproduced, in any form or by any means, without permission in writing from the publisher.

*6-28 Draw the shear and moment diagrams for the connecting rod. Only vertical reactions occur at its ends *A* and *B*.

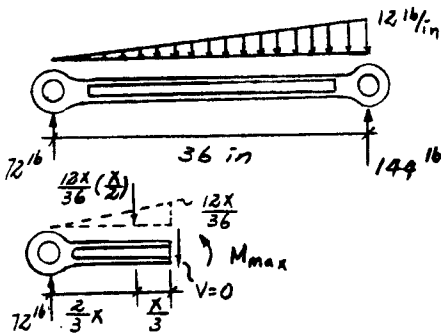
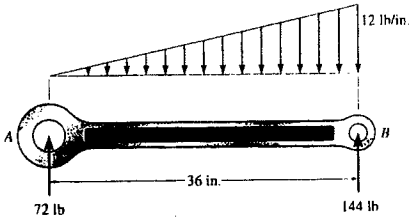

$$+\uparrow \Sigma F_y = 0; \quad 72 - \frac{12x}{36} \left(\frac{x}{2} \right) = 0$$

$$x = 20.784 \text{ in.}$$

$$\zeta + \Sigma M = 0; \quad M_{\max} + \frac{12x}{36} \left(\frac{x}{2} \right) \left(\frac{x}{3} \right) - 72x = 0$$

$$M_{\max} = -\frac{x^3}{18} + 72x$$

Substitute $x = 20.784 \text{ in.}$

$$M_{\max} = 997.66 \text{ lb} \cdot \text{in.}$$

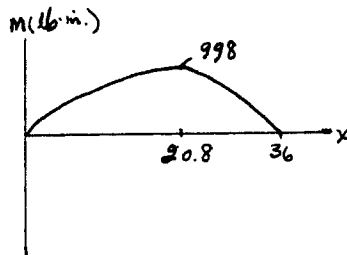
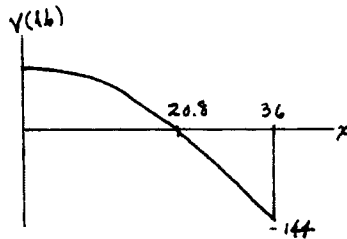

From *Mechanics of Materials*, Sixth Edition by R. C. Hibbeler, ISBN 0-13-191345-X.

© 2005 R. C. Hibbeler. Published by Pearson Prentice Hall,

Pearson Education, Inc., Upper Saddle River, NJ. All rights reserved.

This material is protected under all copyright laws as they currently exist. No portion of this material may be reproduced, in any form or by any means, without permission in writing from the publisher.

6-29. Draw the shear and moment diagrams for the beam.

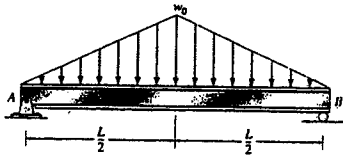

$$\left(+ \right) \Sigma M = 0; \quad M - \frac{w_0 L}{4} \left(\frac{L}{3} \right) = 0; \quad M = \frac{w_0 L^2}{12}$$

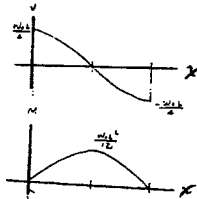
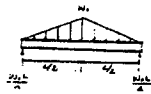

From *Mechanics of Materials*, Sixth Edition by R. C. Hibbeler, ISBN 0-13-191345-X.

© 2005 R. C. Hibbeler. Published by Pearson Prentice Hall,

Pearson Education, Inc., Upper Saddle River, NJ. All rights reserved.

This material is protected under all copyright laws as they currently exist. No portion of this material may be reproduced, in any form or by any means, without permission in writing from the publisher.

6-30 Draw the shear and moment diagrams for the beam.

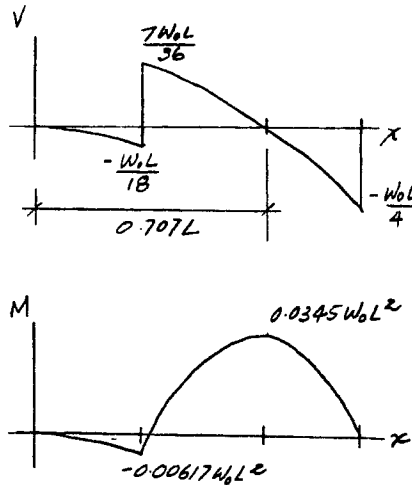
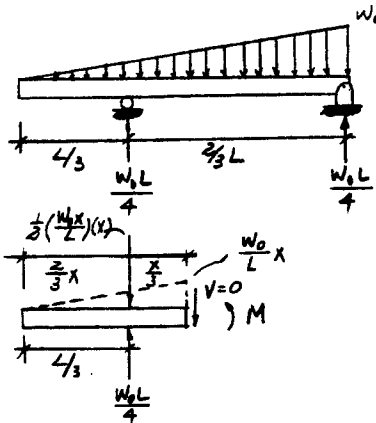
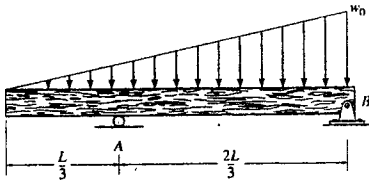

$$+\uparrow \Sigma F_y = 0; \quad \frac{w_0 L}{4} - \frac{1}{2} \left(\frac{w_0 x}{L} \right) (x) = 0$$

$$x = 0.7071 L$$

$$(+\Sigma M_{NA} = 0; \quad M + \frac{1}{2} \left(\frac{w_0 x}{L} \right) (x) \left(\frac{x}{3} \right) - \frac{w_0 L}{4} \left(x - \frac{L}{3} \right) = 0$$

Substitute $x = 0.7071L$.

$$M = 0.0345 w_0 L^2$$

From *Mechanics of Materials*, Sixth Edition by R. C. Hibbeler, ISBN 0-13-191345-X.

© 2005 R. C. Hibbeler. Published by Pearson Prentice Hall,

Pearson Education, Inc., Upper Saddle River, NJ. All rights reserved.

This material is protected under all copyright laws as they currently exist. No portion of this material may be reproduced, in any form or by any means, without permission in writing from the publisher.

6-31. Draw the shear and moment diagrams for the beam.

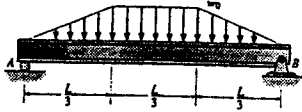

Support Reactions : As shown on FBD.

Shear and Moment Diagram : Shear and moment at $x = L/3$ can be determined using the method of sections.

$$+\uparrow \Sigma F_y = 0; \quad \frac{w_0 L}{3} - \frac{w_0 L}{6} - V = 0 \quad V = \frac{w_0 L}{6}$$

$$\curvearrowleft + \Sigma M_{NA} = 0; \quad M + \frac{w_0 L}{6} \left(\frac{L}{9} \right) - \frac{w_0 L}{3} \left(\frac{L}{3} \right) = 0$$

$$M = \frac{5w_0 L^2}{54}$$

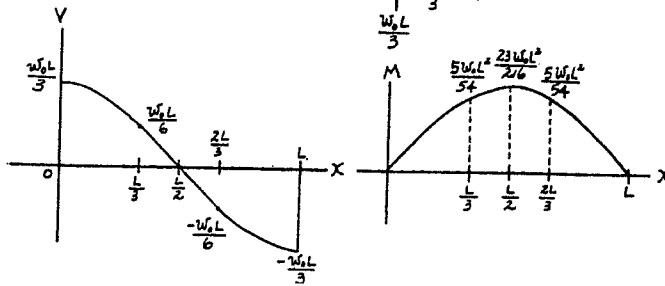
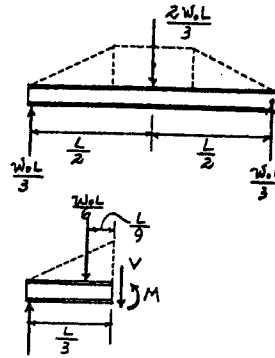

From *Mechanics of Materials*, Sixth Edition by R. C. Hibbeler, ISBN 0-13-191345-X.

© 2005 R. C. Hibbeler. Published by Pearson Prentice Hall,

Pearson Education, Inc., Upper Saddle River, NJ. All rights reserved.

This material is protected under all copyright laws as they currently exist. No portion of this material may be reproduced, in any form or by any means, without permission in writing from the publisher.

*6-32. The ski supports the 180-lb weight of the man. If the snow loading on its bottom surface is trapezoidal as shown, determine the intensity w , and then draw the shear and moment diagrams for the ski.

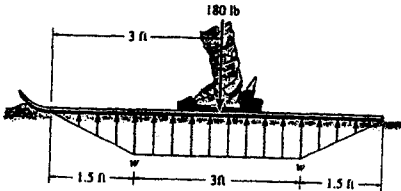

Ski :

$$+\uparrow \Sigma F_y = 0; \quad \frac{1}{2}w(1.5) + 3w + \frac{1}{2}w(1.5) - 180 = 0$$

$$w = 40.0 \text{ lb/ft} \quad \text{Ans}$$

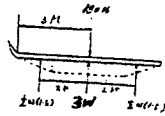

Segment :

$$+\uparrow \Sigma F_y = 0; \quad 30 - V = 0; \quad V = 30.0 \text{ lb}$$

$$(+ \Sigma M = 0; \quad M - 30(0.5) = 0; \quad M = 15.0 \text{ lb}\cdot\text{ft}$$

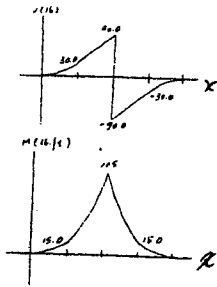

From *Mechanics of Materials*, Sixth Edition by R. C. Hibbeler, ISBN 0-13-191345-X.

© 2005 R. C. Hibbeler. Published by Pearson Prentice Hall,

Pearson Education, Inc., Upper Saddle River, NJ. All rights reserved.

This material is protected under all copyright laws as they currently exist. No portion of this material may be reproduced, in any form or by any means, without permission in writing from the publisher.

6-33 Draw the shear and moment diagrams for the beam.

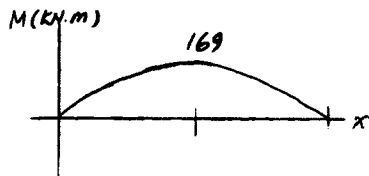
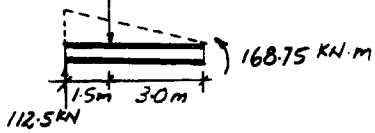
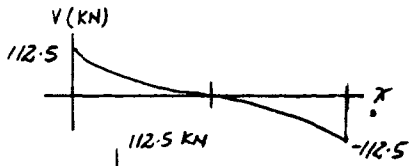
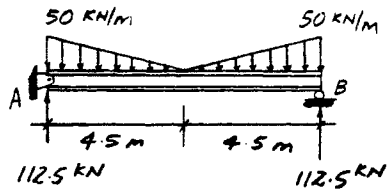
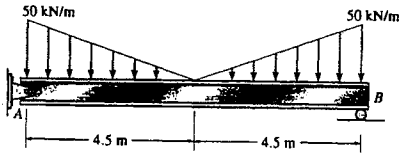

From *Mechanics of Materials*, Sixth Edition by R. C. Hibbeler, ISBN 0-13-191345-X.
 © 2005 R. C. Hibbeler. Published by Pearson Prentice Hall,
 Pearson Education, Inc., Upper Saddle River, NJ. All rights reserved.
 This material is protected under all copyright laws as they currently exist. No portion of this material may be reproduced, in any form or by any means, without permission in writing from the publisher.

6-34. Draw the shear and moment diagrams for the beam and determine the shear and moment in the beam as functions of x .

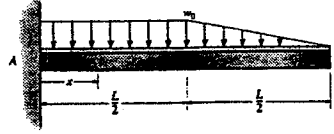

Support Reactions : As shown on FBD.
Shear and Moment Functions :

For $0 \leq x < L/2$

$$+\uparrow \Sigma F_y = 0; \quad \frac{3w_0L}{4} - w_0x - V = 0$$

$$V = \frac{w_0}{4}(3L - 4x) \quad \text{Ans}$$

$$\curvearrowleft + \Sigma M_{NA} = 0; \quad \frac{7w_0L^2}{24} - \frac{3w_0L}{4}x + w_0x\left(\frac{x}{2}\right) + M = 0$$

$$M = \frac{w_0}{24}(-12x^2 + 18Lx - 7L^2) \quad \text{Ans}$$

For $L/2 < x \leq L$

$$+\uparrow \Sigma F_y = 0; \quad V - \frac{1}{2}\left[\frac{2w_0}{L}(L-x)\right](L-x) = 0$$

$$V = \frac{w_0}{L}(L-x)^2 \quad \text{Ans}$$

$$\curvearrowleft + \Sigma M_{NA} = 0; \quad -M - \frac{1}{2}\left[\frac{2w_0}{L}(L-x)\right](L-x)\left(\frac{L-x}{3}\right) = 0$$

$$M = -\frac{w_0}{3L}(L-x)^3 \quad \text{Ans}$$

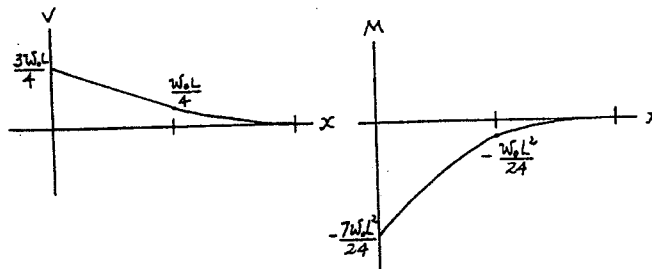
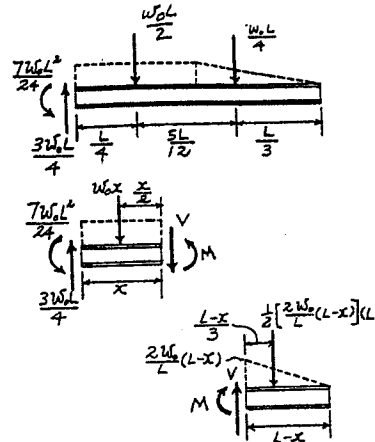

From *Mechanics of Materials*, Sixth Edition by R. C. Hibbeler, ISBN 0-13-191345-X.

© 2005 R. C. Hibbeler. Published by Pearson Prentice Hall,

Pearson Education, Inc., Upper Saddle River, NJ. All rights reserved.

This material is protected under all copyright laws as they currently exist. No portion of this material may be reproduced, in any form or by any means, without permission in writing from the publisher.

6-35. The smooth pin is supported by two leaves *A* and *B* and subjected to a compressive load of 0.4 kN/m caused by bar *C*. Determine the intensity of the distributed load w_0 of the leaves on the pin and draw the shear and moment diagrams for the pin.

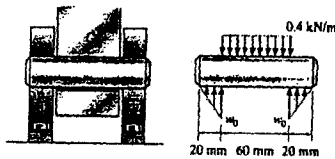

$$+\uparrow \Sigma F_y = 0; \quad 2(w_0)(20)\left(\frac{1}{2}\right) - 60(0.4) = 0$$

$$w_0 = 1.2 \text{ kN/m} \quad \text{Ans}$$

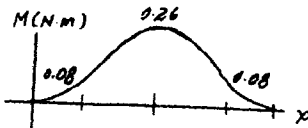
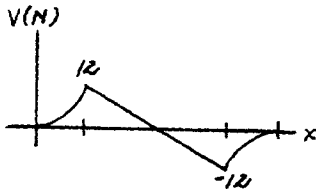
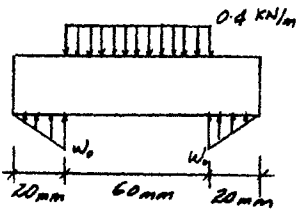

From *Mechanics of Materials*, Sixth Edition by R. C. Hibbeler, ISBN 0-13-191345-X.

© 2005 R. C. Hibbeler. Published by Pearson Prentice Hall,

Pearson Education, Inc., Upper Saddle River, NJ. All rights reserved.

This material is protected under all copyright laws as they currently exist. No portion of this material may be reproduced, in any form or by any means, without permission in writing from the publisher.

*6-36 Draw the shear and moment diagrams for the beam.

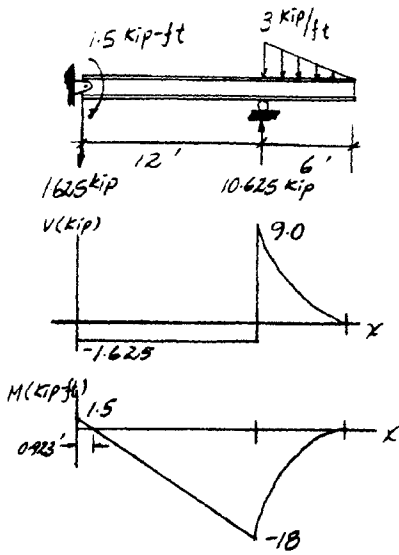
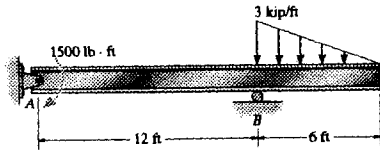

From *Mechanics of Materials*, Sixth Edition by R. C. Hibbeler, ISBN 0-13-191345-X.

© 2005 R. C. Hibbeler. Published by Pearson Prentice Hall,

Pearson Education, Inc., Upper Saddle River, NJ. All rights reserved.

This material is protected under all copyright laws as they currently exist. No portion of this material may be reproduced, in any form or by any means, without permission in writing from the publisher.

6-37 The compound beam consists of two segments that are pinned together at B . Draw the shear and moment diagrams if it supports the distributed loading shown.

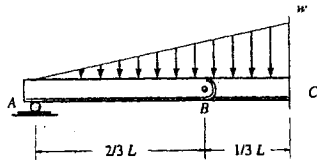

$$+\uparrow \Sigma F_y = 0; \quad \frac{2wL}{27} - \frac{1w}{2L}x^2 = 0$$

$$x = \sqrt{\frac{4}{27}} L = 0.385 L$$

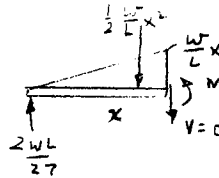

$$(+ \Sigma M = 0; \quad M + \frac{1w}{2L}(0.385L)^2 \left(\frac{1}{3}\right)(0.385L) - \frac{2wL}{27}(0.385L) = 0$$

$$M = 0.0190 wL^2$$

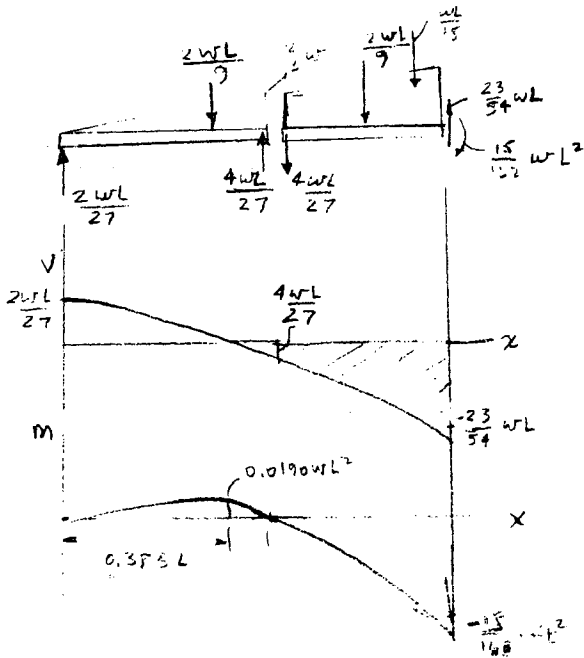

From *Mechanics of Materials*, Sixth Edition by R. C. Hibbeler, ISBN 0-13-191345-X.

© 2005 R. C. Hibbeler. Published by Pearson Prentice Hall,

Pearson Education, Inc., Upper Saddle River, NJ. All rights reserved.

This material is protected under all copyright laws as they currently exist. No portion of this material may be reproduced, in any form or by any means, without permission in writing from the publisher.

6-38 Draw the shear and moment diagrams for the beam.

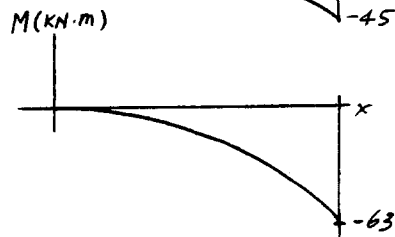
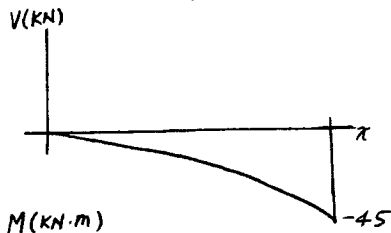
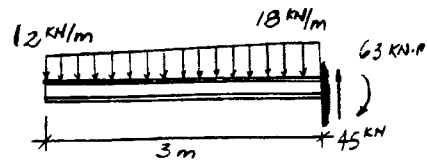
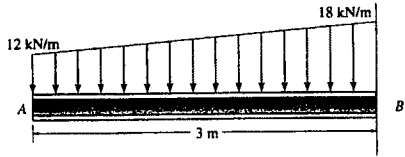

From *Mechanics of Materials*, Sixth Edition by R. C. Hibbeler, ISBN 0-13-191345-X.

© 2005 R. C. Hibbeler. Published by Pearson Prentice Hall,

Pearson Education, Inc., Upper Saddle River, NJ. All rights reserved.

This material is protected under all copyright laws as they currently exist. No portion of this material may be reproduced, in any form or by any means, without permission in writing from the publisher.

6-39 Draw the shear and moment diagrams for the beam and determine the shear and moment as functions of x .

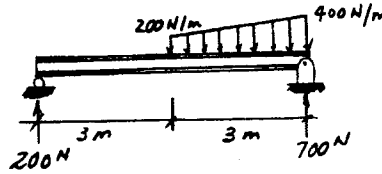
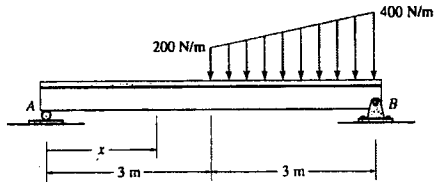

For $0 \leq x \leq 3 \text{ m}$:

$$+\uparrow \Sigma F_y = 0; \quad 200 - V = 0$$

$$V = 200$$

$$\curvearrowleft \Sigma M = 0; \quad M - 200x = 0$$

$$M = 200x$$

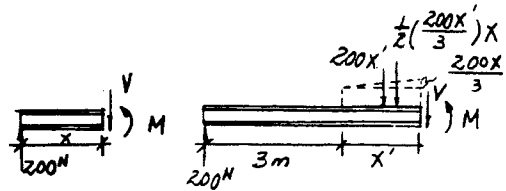

For $3 \text{ m} \leq x \leq 6 \text{ m}$:

$$+\uparrow \Sigma F_y = 0; \quad 200 - 200x' - \frac{200x'^2}{6} - V = 0$$

$$V = 200 - 200x' - \frac{100}{3}x'^2$$

$$x' = x - 3$$

$$V = 200 - 200(x-3) - \frac{100}{3}(x-3)^2$$

$$V = 500 - \frac{100}{3}x^2 \quad \text{Ans}$$

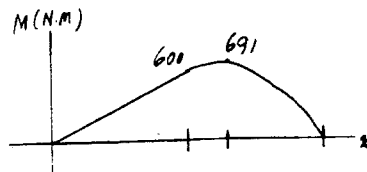
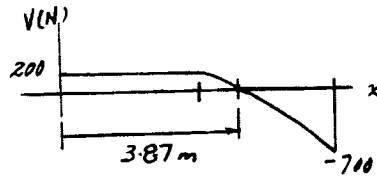

Set $V = 0$; $x = 3.873 \text{ m}$

$$\curvearrowleft \Sigma M = 0; \quad 200(x' + 3) - 200x'(\frac{x'}{2}) - \frac{100}{3}x'^2(\frac{x'}{3}) - M = 0$$

$$M = 200(x' + 3) - 100x'^2 - \frac{100}{9}x'^3$$

Substitute $x' = x - 3$,

$$M = -\frac{100}{9}x^3 + 500x - 600 \quad \text{Ans}$$

Substitute $x = 3.873 \text{ m}$,

$$M = 691 \text{ N} \cdot \text{m}$$

From *Mechanics of Materials*, Sixth Edition by R. C. Hibbeler, ISBN 0-13-191345-X.

© 2005 R. C. Hibbeler. Published by Pearson Prentice Hall,

Pearson Education, Inc., Upper Saddle River, NJ. All rights reserved.

This material is protected under all copyright laws as they currently exist. No portion of this material may be reproduced, in any form or by any means, without permission in writing from the publisher.

6-40. Draw the shear and moment diagrams for the beam.

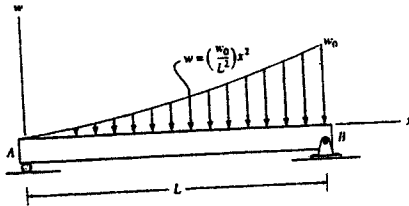

$$F_R = \int_A^B dA = \int_0^L w dx = \frac{w_0}{L^2} \int_0^L x^2 dx = \frac{w_0 L}{3}$$

$$\bar{x} = \frac{\int_A x dA}{\int_A dA} = \frac{\frac{w_0}{L^2} \int_0^L x^3 dx}{\frac{w_0 L}{3}} = \frac{3L}{4}$$

$$+\uparrow \Sigma F_y = 0; \quad \frac{w_0 L}{12} - \frac{w_0 x^3}{3L^2} = 0$$

$$x = \left(\frac{1}{4}\right)^{1/3} L = 0.630 L$$

$$(+\Sigma M = 0; \quad \frac{w_0 L}{12}(x) - \frac{w_0 x^3}{3L^2} \left(\frac{1}{4}x\right) - M = 0$$

$$M = \frac{w_0 Lx}{12} - \frac{w_0 x^4}{12L^2}$$

Substitute $x = 0.630L$

$$M = 0.0394 w_0 L^2$$

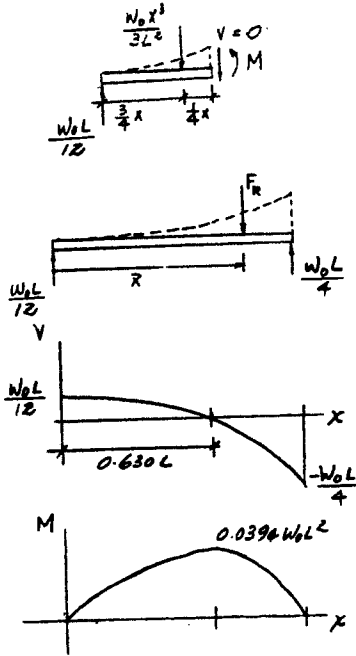

From *Mechanics of Materials*, Sixth Edition by R. C. Hibbeler, ISBN 0-13-191345-X.
 © 2005 R. C. Hibbeler. Published by Pearson Prentice Hall,
 Pearson Education, Inc., Upper Saddle River, NJ. All rights reserved.
 This material is protected under all copyright laws as they currently exist. No portion of this material may be reproduced, in any form or by any means, without permission in writing from the publisher.

6-41 Draw the shear and moment diagrams for the beam.

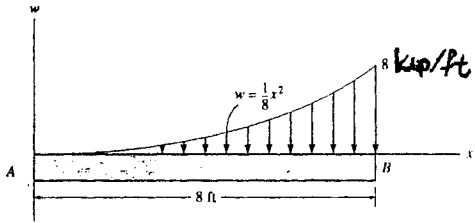

$$F_R = \frac{1}{8} \int_0^8 x^2 dx = 21.33 \text{ kip}$$

$$\bar{x} = \frac{\frac{1}{8} \int_0^8 x^3 dx}{21.33} = 6.0 \text{ ft}$$

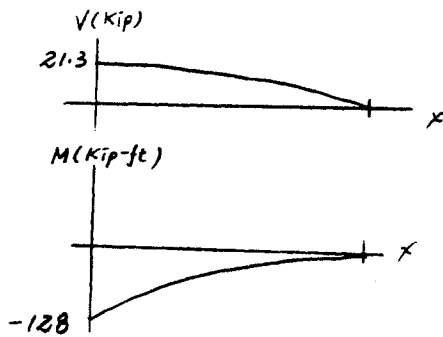
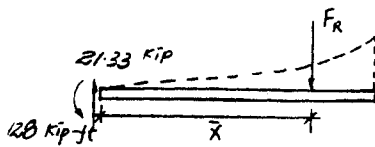

From *Mechanics of Materials*, Sixth Edition by R. C. Hibbeler, ISBN 0-13-191345-X.

© 2005 R. C. Hibbeler. Published by Pearson Prentice Hall,

Pearson Education, Inc., Upper Saddle River, NJ. All rights reserved.

This material is protected under all copyright laws as they currently exist. No portion of this material may be reproduced, in any form or by any means, without permission in writing from the publisher.

6-42 Draw the shear and moment diagrams for the beam.

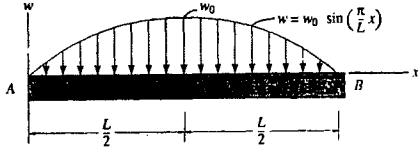

$$F_R = \int_A^B dA = w_0 \int_0^L \sin\left(\frac{\pi}{L}x\right) dx = \frac{2w_0L}{\pi}$$

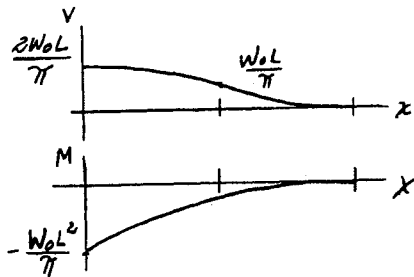
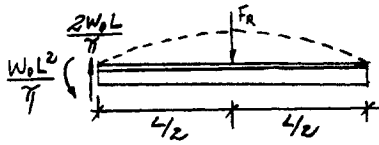

From *Mechanics of Materials*, Sixth Edition by R. C. Hibbeler, ISBN 0-13-191345-X.
 © 2005 R. C. Hibbeler. Published by Pearson Prentice Hall,
 Pearson Education, Inc., Upper Saddle River, NJ. All rights reserved.
 This material is protected under all copyright laws as they currently exist. No portion of this material may be
 reproduced, in any form or by any means, without permission in writing from the publisher.

6-43 A member having the dimensions shown is to be used to resist an internal bending moment of $M = 2 \text{ kip} \cdot \text{ft}$. Determine the maximum stress in the member if the moment is applied (a) about the z axis, (b) about the y axis. Sketch the stress distribution for each case.

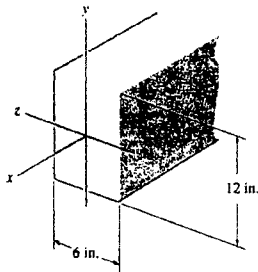

$$I_z = \frac{1}{12}(6)(12^3) = 864 \text{ in}^4$$

$$I_y = \frac{1}{12}(12)(6^3) = 216 \text{ in}^4$$

a) Maximum stress :

For z - z axis :

$$\sigma_{\max} = \frac{Mc}{I_z} = \frac{2(10^3)(12)(6)}{864} = 167 \text{ psi} \quad \text{Ans}$$

b) For y - y axis :

$$\sigma_{\max} = \frac{Mc}{I_y} = \frac{2(10^3)(12)(3)}{216} = 333 \text{ psi} \quad \text{Ans}$$

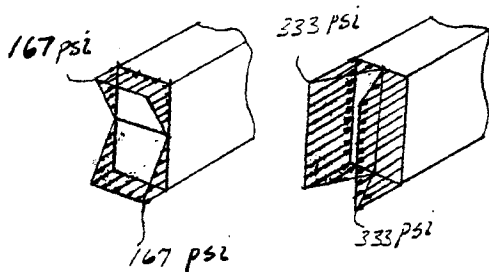

From *Mechanics of Materials*, Sixth Edition by R. C. Hibbeler, ISBN 0-13-191345-X.

© 2005 R. C. Hibbeler. Published by Pearson Prentice Hall,

Pearson Education, Inc., Upper Saddle River, NJ. All rights reserved.

This material is protected under all copyright laws as they currently exist. No portion of this material may be reproduced, in any form or by any means, without permission in writing from the publisher.

*6-44 The steel rod having a diameter of 1 in. is subjected to an internal moment of $M = 300 \text{ lb} \cdot \text{ft}$. Determine the stress created at points A and B . Also, sketch a three-dimensional view of the stress distribution acting over the cross section.

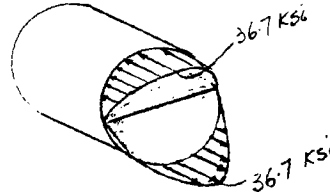
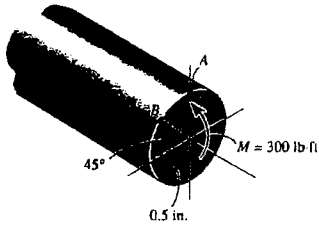

$$I = \frac{\pi}{4} r^4 = \frac{\pi}{4} (0.5^4) = 0.0490874 \text{ in}^4$$

$$\sigma_A = \frac{Mc}{I} = \frac{300(12)(0.5)}{0.0490874} = 36.7 \text{ ksi} \quad \text{Ans}$$

$$\sigma_B = \frac{My}{I} = \frac{300(12)(0.5 \sin 45^\circ)}{0.0490874} = 25.9 \text{ ksi} \quad \text{Ans}$$

From *Mechanics of Materials*, Sixth Edition by R. C. Hibbeler, ISBN 0-13-191345-X.

© 2005 R. C. Hibbeler. Published by Pearson Prentice Hall,

Pearson Education, Inc., Upper Saddle River, NJ. All rights reserved.

This material is protected under all copyright laws as they currently exist. No portion of this material may be reproduced, in any form or by any means, without permission in writing from the publisher.

6-45. A member has the triangular cross section shown. Determine the largest internal moment M that can be applied to the cross section without exceeding allowable tensile and compressive stresses of $(\sigma_{\text{allow}})_t = 22$ ksi and $(\sigma_{\text{allow}})_c = 15$ ksi, respectively.

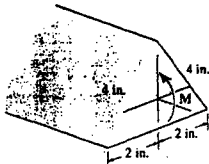

$$\bar{y} \text{ (From base)} = \frac{1}{3}\sqrt{4^2 - 2^2} = 1.1547 \text{ in.}$$

$$I = \frac{1}{36}(4)(\sqrt{4^2 - 2^2})^3 = 4.6188 \text{ in}^4$$

Assume failure due to tensile stress :

$$\sigma_{\text{max}} = \frac{My}{I}; \quad 22 = \frac{M(1.1547)}{4.6188}$$

$$M = 88.0 \text{ kip} \cdot \text{in.} = 7.33 \text{ kip} \cdot \text{ft}$$

Assume failure due to compressive stress:

$$\sigma_{\text{max}} = \frac{Mc}{I}; \quad 15 = \frac{M(3.4641 - 1.1547)}{4.6188}$$

$$M = 30.0 \text{ kip} \cdot \text{in.} = 2.50 \text{ kip} \cdot \text{ft} \quad (\text{controls}) \quad \mathbf{Ans}$$

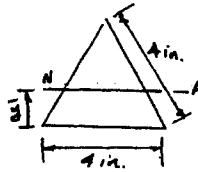

From *Mechanics of Materials*, Sixth Edition by R. C. Hibbeler, ISBN 0-13-191345-X.
 © 2005 R. C. Hibbeler. Published by Pearson Prentice Hall,
 Pearson Education, Inc., Upper Saddle River, NJ. All rights reserved.
 This material is protected under all copyright laws as they currently exist. No portion of this material may be reproduced, in any form or by any means, without permission in writing from the publisher.

6-46. A member has the triangular cross section shown. If a moment of $M = 800 \text{ lb} \cdot \text{ft}$ is applied to the cross section, determine the maximum tensile and compressive bending stresses in the member. Also, sketch a three-dimensional view of the stress distribution acting over the cross section.

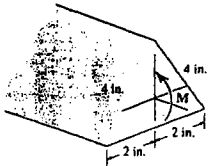

$$h = \sqrt{4^2 - 2^2} = 3.4641 \text{ in.}$$

$$I_x = \frac{1}{36}(4)(3.4641)^3 = 4.6188 \text{ in}^4$$

$$c = \frac{2}{3}(3.4641) = 2.3094 \text{ in.}$$

$$y = \frac{1}{3}(3.4641) = 1.1547 \text{ in.}$$

$$(\sigma_{\max})_t = \frac{My}{I} = \frac{800(12)(1.1547)}{4.6188} = 2.40 \text{ ksi} \quad \text{Ans}$$

$$(\sigma_{\max})_c = \frac{Mc}{I} = \frac{800(12)(2.3094)}{4.6188} = 4.80 \text{ ksi} \quad \text{Ans}$$

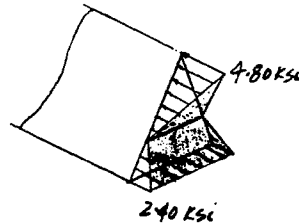
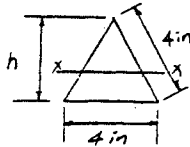

From *Mechanics of Materials*, Sixth Edition by R. C. Hibbeler, ISBN 0-13-191345-X.

© 2005 R. C. Hibbeler. Published by Pearson Prentice Hall,

Pearson Education, Inc., Upper Saddle River, NJ. All rights reserved.

This material is protected under all copyright laws as they currently exist. No portion of this material may be reproduced, in any form or by any means, without permission in writing from the publisher.

6-47 The beam is made from three boards nailed together as shown. If the moment acting on the cross section is $M = 600 \text{ N} \cdot \text{m}$, determine the maximum bending stress in the beam. Sketch a three-dimensional view of the stress distribution acting over the cross section.

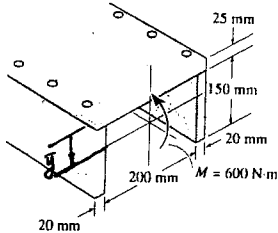

$$\bar{y} = \frac{(0.0125)(0.24)(0.025) + 2(0.1)(0.15)(0.02)}{0.24(0.025) + 2(0.15)(0.02)} = 0.05625 \text{ m}$$

$$I = \frac{1}{12}(0.24)(0.025^3) + (0.24)(0.025)(0.04375^2) + 2\left(\frac{1}{12}(0.02)(0.15^3) + 2(0.15)(0.02)(0.04375^2)\right) = 34.53125(10^{-6}) \text{ m}^4$$

$$\sigma_{\max} = \sigma_B = \frac{M c}{I} = \frac{600(0.175 - 0.05625)}{34.53125(10^{-6})} = 2.06 \text{ MPa} \quad \text{Ans}$$

$$\sigma_C = \frac{M y}{I} = \frac{600(0.05625)}{34.53125(10^{-6})} = 0.977 \text{ MPa}$$

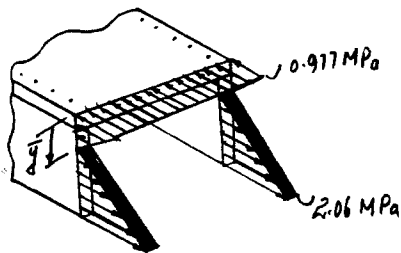

From *Mechanics of Materials*, Sixth Edition by R. C. Hibbeler, ISBN 0-13-191345-X.

© 2005 R. C. Hibbeler. Published by Pearson Prentice Hall,

Pearson Education, Inc., Upper Saddle River, NJ. All rights reserved.

This material is protected under all copyright laws as they currently exist. No portion of this material may be reproduced, in any form or by any means, without permission in writing from the publisher.

*6-48 The beam is made from three boards nailed together as shown. If the moment acting on the cross section is $M = 600 \text{ N} \cdot \text{m}$, determine the resultant force the bending stress produces on the top board.

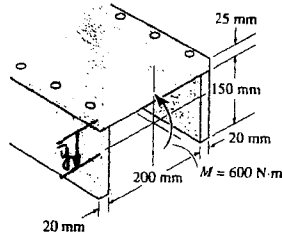

$$\bar{y} = \frac{(0.0125)(0.24)(0.025) + 2(0.15)(0.1)(0.02)}{0.24(0.025) + 2(0.15)(0.02)} = 0.05625 \text{ m}$$

$$I = \frac{1}{12}(0.24)(0.025^3) + (0.24)(0.025)(0.04375^2) + 2\left(\frac{1}{12}\right)(0.02)(0.15^3) + 2(0.15)(0.02)(0.04375^2)$$

$$= 34.53125(10^{-6}) \text{ m}^4$$

$$\sigma_t = \frac{My}{I} = \frac{600(0.05625)}{34.53125(10^{-6})} = 0.9774 \text{ MPa}$$

$$\sigma_b = \frac{My}{I} = \frac{600(0.05625 - 0.025)}{34.53125(10^{-6})} = 0.5430 \text{ MPa}$$

$$F = \frac{1}{2}(0.025)(0.9774 + 0.5430)(10^6)(0.240) = 4.56 \text{ kN} \quad \text{Ans}$$

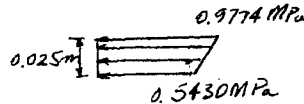

From *Mechanics of Materials*, Sixth Edition by R. C. Hibbeler, ISBN 0-13-191345-X.

© 2005 R. C. Hibbeler. Published by Pearson Prentice Hall,

Pearson Education, Inc., Upper Saddle River, NJ. All rights reserved.

This material is protected under all copyright laws as they currently exist. No portion of this material may be reproduced, in any form or by any means, without permission in writing from the publisher.

6-49 A beam has the cross section shown. If it is made of steel that has an allowable stress of $\sigma_{\text{allow}} = 24$ ksi, determine the largest internal moment the beam can resist if the moment is applied (a) about the z axis, (b) about the y axis.

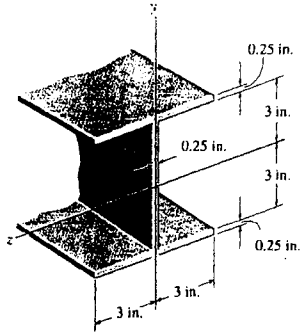

$$I_z = \frac{1}{12}(6)(6.5^3) - \frac{1}{12}(5.75)(6^3) = 33.8125 \text{ in}^4$$

$$I_y = 2\left[\frac{1}{12}(0.25)(6^3)\right] + \frac{1}{12}(6)(0.25^3) = 9.0078 \text{ in}^4$$

$$\begin{aligned} \text{a) } (M_{\text{allow}})_z &= \frac{\sigma_{\text{allow}} I_z}{c} = \frac{24(33.8125)}{3.25} \\ &= 249.7 \text{ kip} \cdot \text{in.} = 20.8 \text{ kip} \cdot \text{ft} \quad \text{Ans} \end{aligned}$$

$$\begin{aligned} \text{b) } (M_{\text{allow}})_y &= \frac{\sigma_{\text{allow}} I_y}{c} = \frac{24(9.0078)}{3} \\ &= 72.0625 \text{ kip} \cdot \text{in.} = 6.00 \text{ kip} \cdot \text{ft} \quad \text{Ans} \end{aligned}$$

From *Mechanics of Materials*, Sixth Edition by R. C. Hibbeler, ISBN 0-13-191345-X.

© 2005 R. C. Hibbeler. Published by Pearson Prentice Hall,

Pearson Education, Inc., Upper Saddle River, NJ. All rights reserved.

This material is protected under all copyright laws as they currently exist. No portion of this material may be reproduced, in any form or by any means, without permission in writing from the publisher.

6-50 The beam is subjected to a moment of $M = 40 \text{ kN} \cdot \text{m}$. Determine the bending stress acting at points A and B . Sketch the results on a volume element acting at each of these points.

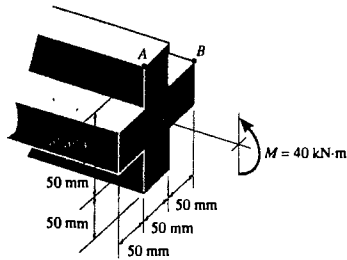

$$I = \frac{1}{12}(0.150)(0.05)^3 + 2\left[\frac{1}{12}(0.05)(0.05)^3 + (0.05)(0.05)(0.05)^2\right] = 15.1042(10^{-6}) \text{ m}^4$$

$$\sigma_A = \frac{Mc}{I} = \frac{40(10^3)(0.075)}{15.1042(10^{-6})} = 199 \text{ MPa} \quad \text{Ans}$$

$$\sigma_B = \frac{My}{I} = \frac{40(10^3)(0.025)}{15.1042(10^{-6})} = 66.2 \text{ MPa} \quad \text{Ans}$$

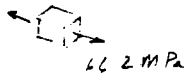
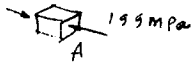

From *Mechanics of Materials*, Sixth Edition by R. C. Hibbeler, ISBN 0-13-191345-X.

© 2005 R. C. Hibbeler. Published by Pearson Prentice Hall,

Pearson Education, Inc., Upper Saddle River, NJ. All rights reserved.

This material is protected under all copyright laws as they currently exist. No portion of this material may be reproduced, in any form or by any means, without permission in writing from the publisher.

6-51. The aluminum machine part is subjected to a moment of $M = 75 \text{ N} \cdot \text{m}$. Determine the bending stress created at points B and C on the cross section. Sketch the results on a volume element located at each of these points.

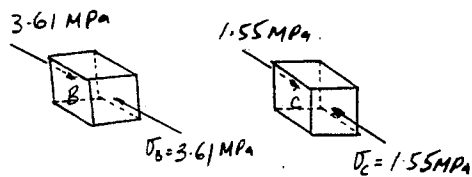
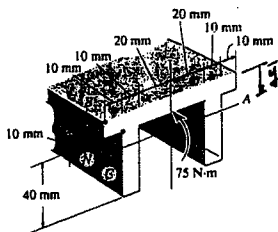

$$\bar{y} = \frac{0.005(0.08)(0.01) + 2[0.03(0.04)(0.01)]}{0.08(0.01) + 2(0.04)(0.01)} = 0.0175 \text{ m}$$

$$I = \frac{1}{12}(0.08)(0.01^3) + 0.08(0.01)(0.0125^2) + 2\left[\frac{1}{12}(0.01)(0.04^3) + 0.01(0.04)(0.0125^2)\right] = 0.3633(10^{-6}) \text{ m}^4$$

$$\sigma_B = \frac{Mc}{I} = \frac{75(0.0175)}{0.3633(10^{-6})} = 3.61 \text{ MPa} \quad \text{Ans}$$

$$\sigma_C = \frac{My}{I} = \frac{75(0.0175 - 0.01)}{0.3633(10^{-6})} = 1.55 \text{ MPa} \quad \text{Ans}$$

From *Mechanics of Materials*, Sixth Edition by R. C. Hibbeler, ISBN 0-13-191345-X.

© 2005 R. C. Hibbeler. Published by Pearson Prentice Hall,

Pearson Education, Inc., Upper Saddle River, NJ. All rights reserved.

This material is protected under all copyright laws as they currently exist. No portion of this material may be reproduced, in any form or by any means, without permission in writing from the publisher.

***6-52.** The aluminum machine part is subjected to a moment of $M = 75 \text{ N} \cdot \text{m}$. Determine the maximum tensile and compressive bending stresses in the part.

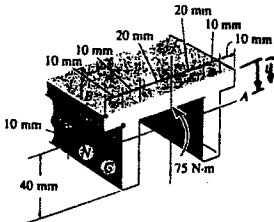

$$\bar{y} = \frac{0.005(0.08)(0.01) + 2[0.03(0.04)(0.01)]}{0.08(0.01) + 2(0.04)(0.01)} = 0.0175 \text{ m}$$

$$I = \frac{1}{12}(0.08)(0.01^3) + 0.08(0.01)(0.0125^2) + 2\left[\frac{1}{12}(0.01)(0.04^3) + 0.01(0.04)(0.0125^2)\right] = 0.3633(10^{-6}) \text{ m}^4$$

$$(\sigma_{\max})_t = \frac{Mc}{I} = \frac{75(0.050 - 0.0175)}{0.3633(10^{-6})} = 6.71 \text{ MPa} \quad \text{Ans}$$

$$(\sigma_{\max})_c = \frac{My}{I} = \frac{75(0.0175)}{0.3633(10^{-6})} = 3.61 \text{ MPa} \quad \text{Ans}$$

From *Mechanics of Materials*, Sixth Edition by R. C. Hibbeler, ISBN 0-13-191345-X.

© 2005 R. C. Hibbeler. Published by Pearson Prentice Hall,

Pearson Education, Inc., Upper Saddle River, NJ. All rights reserved.

This material is protected under all copyright laws as they currently exist. No portion of this material may be reproduced, in any form or by any means, without permission in writing from the publisher.

6-53. A beam is constructed from four pieces of wood, glued together as shown. If the moment acting on the cross section is $M = 450 \text{ N} \cdot \text{m}$, determine the resultant force the bending stress produces on the top board A and on the side board B .

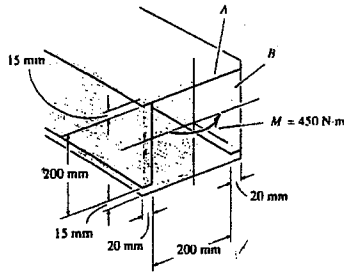

$$I_y = \frac{1}{12} (0.23) (0.24^3) - \frac{1}{12} (0.2) (0.2^3) = 1.31626 (10^{-4}) \text{ m}^4$$

$$\sigma_D = \frac{Mx}{I_y} = \frac{450 (0.12)}{1.31626 (10^{-4})} = 410.25 \text{ kPa}$$

$$\sigma_c = \frac{Mx}{I_y} = \frac{450 (0.1)}{1.31626 (10^{-4})} = 341.88 \text{ kPa}$$

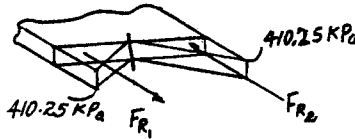

$$F_{R_x} = F_{R_1} - F_{R_2}$$

$$= \frac{1}{2} (410.25)(10^3)(0.12)(0.015) - \frac{1}{2} (410.25)(10^3)(0.12)(0.015)$$

$$= 0 \quad \text{Ans}$$

$$F_{R_y} = 341.88 (10^3)(0.2)(0.02) + \frac{1}{2} (410.25 - 341.88)(10^3)(0.2)(0.02)$$

$$= 1.50 \text{ kN} \quad \text{Ans}$$

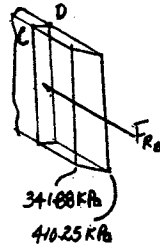

From *Mechanics of Materials*, Sixth Edition by R. C. Hibbeler, ISBN 0-13-191345-X.
 © 2005 R. C. Hibbeler. Published by Pearson Prentice Hall,
 Pearson Education, Inc., Upper Saddle River, NJ. All rights reserved.
 This material is protected under all copyright laws as they currently exist. No portion of this material may be reproduced, in any form or by any means, without permission in writing from the publisher.

6-54. The beam is subjected to a moment of 15 kip · ft. Determine the resultant force the bending stress produces on the top flange *A* and bottom flange *B*. Also compute the maximum bending stress developed in the beam.

$$\bar{y} = \frac{\sum yA}{\sum A} = \frac{0.5(1)(5) + 5(8)(1) + 9.5(3)(1)}{1(5) + 8(1) + 3(1)} = 4.4375 \text{ in.}$$

$$I = \frac{1}{12}(5)(1^3) + 5(1)(4.4375 - 0.5)^2 + \frac{1}{12}(1)(8^3) + 8(1)(5 - 4.4375)^2 + \frac{1}{12}(3)(1^3) + 3(1)(9.5 - 4.4375)^2 = 200.27 \text{ in}^4$$

Using flexure formula $\sigma = \frac{My}{I}$

$$\sigma_A = \frac{15(12)(4.4375 - 1)}{200.27} = 3.0896 \text{ ksi}$$

$$\sigma_B = \frac{15(12)(4.4375)}{200.27} = 3.9883 \text{ ksi}$$

$$\sigma_C = \frac{15(12)(9 - 4.4375)}{200.27} = 4.1007 \text{ ksi}$$

$$\sigma_{\text{Max}} = \frac{15(12)(10 - 4.4375)}{200.27} = 4.9995 \text{ ksi} = 5.00 \text{ ksi (Max)} \quad \text{Ans}$$

$$F_A = \frac{1}{2}(3.0896 + 3.9883)(1)(5) = 17.7 \text{ kip} \quad \text{Ans}$$

$$F_B = \frac{1}{2}(4.9995 + 4.1007)(1)(3) = 13.7 \text{ kip} \quad \text{Ans}$$

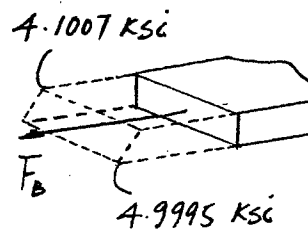
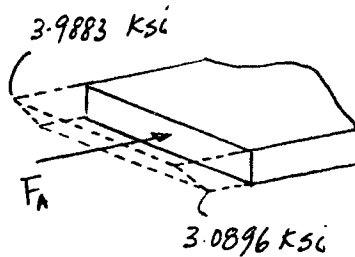
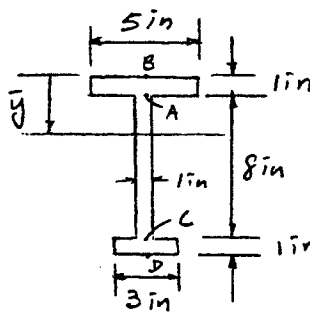

From *Mechanics of Materials*, Sixth Edition by R. C. Hibbeler, ISBN 0-13-191345-X.
 © 2005 R. C. Hibbeler. Published by Pearson Prentice Hall,
 Pearson Education, Inc., Upper Saddle River, NJ. All rights reserved.
 This material is protected under all copyright laws as they currently exist. No portion of this material may be reproduced, in any form or by any means, without permission in writing from the publisher.

6-55. The beam is subjected to a moment of 15 kip · ft. Determine the percentage of this moment that is resisted by the web *D* of the beam.

$$\bar{y} = \frac{\sum \bar{y} A}{\sum A} = \frac{0.5(1)(5) + 5(8)(1) + 9.5(3)(1)}{1(5) + 8(1) + 3(1)} = 4.4375 \text{ in.}$$

$$I = \frac{1}{12}(5)(1^3) + 5(1)(4.4375 - 0.5)^2 + \frac{1}{12}(1)(8^3) + 8(1)(5 - 4.4375)^2 + \frac{1}{12}(3)(1^3) + 3(1)(9.5 - 4.4375)^2 = 200.27 \text{ in}^4$$

Using flexure formula $\sigma = \frac{My}{I}$

$$\sigma_A = \frac{15(12)(4.4375 - 1)}{200.27} = 3.0896 \text{ ksi}$$

$$\sigma_B = \frac{15(12)(9 - 4.4375)}{200.27} = 4.1007 \text{ ksi}$$

$$F_C = \frac{1}{2}(3.0896)(3.4375)(1) = 5.3102 \text{ kip}$$

$$F_T = \frac{1}{2}(4.1007)(4.5625)(1) = 9.3547 \text{ kip}$$

$$M = 5.3102(2.2917) + 9.3547(3.0417) = 40.623 \text{ kip} \cdot \text{in.} = 3.3852 \text{ kip} \cdot \text{ft}$$

$$\% \text{ of moment carried by web} = \frac{3.3852}{15} \times 100 = 22.6 \% \quad \text{Ans}$$

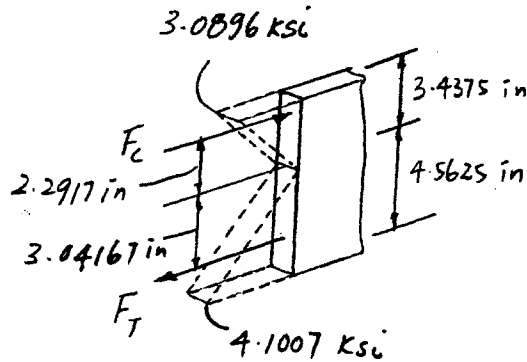
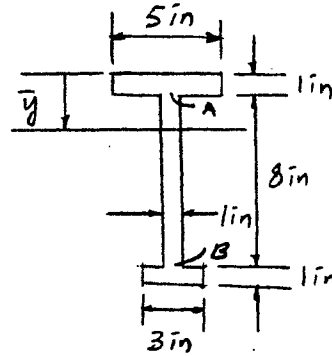

From *Mechanics of Materials*, Sixth Edition by R. C. Hibbeler, ISBN 0-13-191345-X.

© 2005 R. C. Hibbeler. Published by Pearson Prentice Hall,

Pearson Education, Inc., Upper Saddle River, NJ. All rights reserved.

This material is protected under all copyright laws as they currently exist. No portion of this material may be reproduced, in any form or by any means, without permission in writing from the publisher.

*6-56 The beam is constructed from four boards as shown. If it is subjected to a moment of $M_z = 16 \text{ kip} \cdot \text{ft}$, determine the stress at points A and B . Sketch a three-dimensional view of the stress distribution.

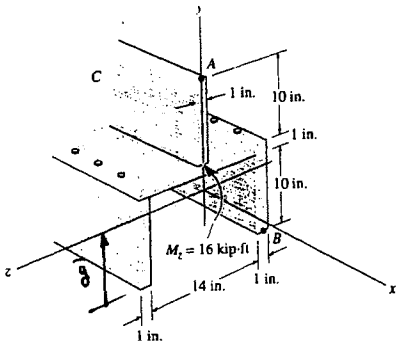

$$\bar{y} = \frac{2[5(10)(1)] + 10.5(16)(1) + 16(10)(1)}{2(10)(1) + 16(1) + 10(1)}$$

$$= 9.3043 \text{ in.}$$

$$I = 2\left[\frac{1}{12}(1)(10^3) + 1(10)(9.3043 - 5)^2\right] + \frac{1}{12}(16)(1^3) + 16(1)(10.5 - 9.3043)^2$$

$$+ \frac{1}{12}(1)(10^3) + 1(10)(16 - 9.3043) = 1093.07 \text{ in}^4$$

$$\sigma_A = \frac{Mc}{I} = \frac{16(12)(21 - 9.3043)}{1093.07} = 2.05 \text{ ksi} \quad \text{Ans}$$

$$\sigma_B = \frac{My}{I} = \frac{16(12)(9.3043)}{1093.07} = 1.63 \text{ ksi} \quad \text{Ans}$$

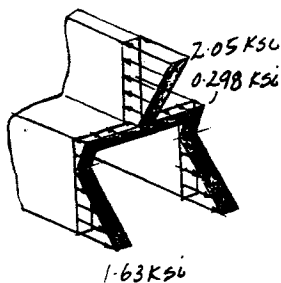

From *Mechanics of Materials*, Sixth Edition by R. C. Hibbeler, ISBN 0-13-191345-X.
 © 2005 R. C. Hibbeler. Published by Pearson Prentice Hall,
 Pearson Education, Inc., Upper Saddle River, NJ. All rights reserved.
 This material is protected under all copyright laws as they currently exist. No portion of this material may be reproduced, in any form or by any means, without permission in writing from the publisher.

6-57 The beam is constructed from four boards as shown. If it is subjected to a moment of $M_z = 16 \text{ kip} \cdot \text{ft}$, determine the resultant force the stress produces on the top board C.

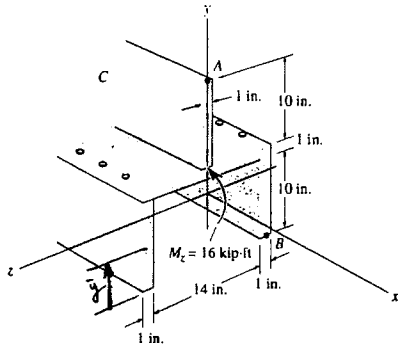

$$\bar{y} = \frac{2[5(10)(1)] + 10.5(16)(1) + 16(10)(1)}{2(10)(1) + 16(1) + 10(1)} = 9.3043 \text{ in.}$$

$$I = 2\left[\frac{1}{12}(1)(10^3) + (10)(9.3043 - 5)^2\right] + \frac{1}{12}(16)(1^3) + 16(1)(10.5 - 9.3043)^2 + \frac{1}{12}(1)(10^3) + 1(10)(16 - 9.3043)^2 = 1093.07 \text{ in}^4$$

$$\sigma_A = \frac{Mc}{I} = \frac{16(12)(21 - 9.3043)}{1093.07} = 2.0544 \text{ ksi}$$

$$\sigma_D = \frac{My}{I} = \frac{16(12)(11 - 9.3043)}{1093.07} = 0.2978 \text{ ksi}$$

$$(F_R)_C = \frac{1}{2}(2.0544 + 0.2978)(10)(1) = 11.8 \text{ kip} \quad \text{Ans}$$

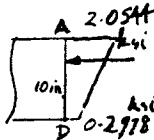

From *Mechanics of Materials*, Sixth Edition by R. C. Hibbeler, ISBN 0-13-191345-X.

© 2005 R. C. Hibbeler. Published by Pearson Prentice Hall,

Pearson Education, Inc., Upper Saddle River, NJ. All rights reserved.

This material is protected under all copyright laws as they currently exist. No portion of this material may be reproduced, in any form or by any means, without permission in writing from the publisher.

6-58. The control lever is used on a riding lawn mower. Determine the maximum bending stress in the lever at section $a - a$ if a force of 20 lb is applied to the handle. The lever is supported by a pin at A and a wire at B . Section $a - a$ is square, 0.25 in. by 0.25 in.

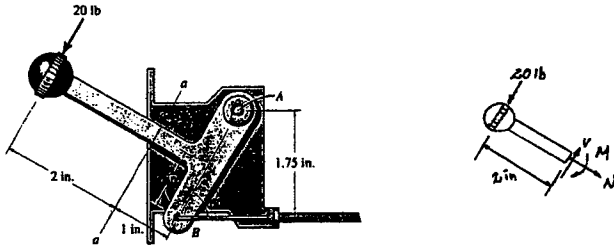

$$\left(+ \sum M = 0; \quad 20(2) - M = 0; \quad M = 40 \text{ lb} \cdot \text{in.} \right.$$

$$\sigma_{\max} = \frac{Mc}{I} = \frac{40(0.125)}{\frac{1}{12}(0.25)(0.25^3)} = 15.4 \text{ ksi} \quad \text{Ans}$$

From *Mechanics of Materials*, Sixth Edition by R. C. Hibbeler, ISBN 0-13-191345-X.

© 2005 R. C. Hibbeler. Published by Pearson Prentice Hall,

Pearson Education, Inc., Upper Saddle River, NJ. All rights reserved.

This material is protected under all copyright laws as they currently exist. No portion of this material may be reproduced, in any form or by any means, without permission in writing from the publisher.

6-59. The beam is subjected to a moment of $M = 30 \text{ lb} \cdot \text{ft}$. Determine the bending stress acting at points A and B . Also, sketch a three-dimensional view of the stress distribution acting over the entire cross-sectional area.

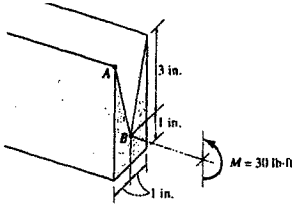

$$\bar{y} = \frac{2(4)(2) - 3(\frac{1}{2})(2)(3)}{4(2) - \frac{1}{2}(2)(3)} = 1.40 \text{ in.}$$

$$I = \frac{1}{12}(2)(4)^3 + (4)(2)(2 - 1.40)^2 - \left(\frac{1}{36}(2)(3)^3 + \frac{1}{2}(2)(3)(3 - 1.40)^2\right) = 4.367 \text{ in}^4$$

$$\sigma_A = \frac{My}{I} = \frac{(30)(12)(4 - 1.40)}{4.367} = 214 \text{ psi} \quad \text{Ans}$$

$$\sigma_B = \frac{My}{I} = \frac{30(12)(1.40 - 1)}{4.367} = 33.0 \text{ psi} \quad \text{Ans}$$

$$\sigma_C = \frac{My}{I} = \frac{30(12)(1.40)}{4.367} = 115 \text{ psi}$$



From *Mechanics of Materials*, Sixth Edition by R. C. Hibbeler, ISBN 0-13-191345-X.

© 2005 R. C. Hibbeler. Published by Pearson Prentice Hall,

Pearson Education, Inc., Upper Saddle River, NJ. All rights reserved.

This material is protected under all copyright laws as they currently exist. No portion of this material may be reproduced, in any form or by any means, without permission in writing from the publisher.

*6-60 The tapered casting supports the loading shown. Determine the bending stress at points *A* and *B*. The cross section at section *a-a* is given in the figure.

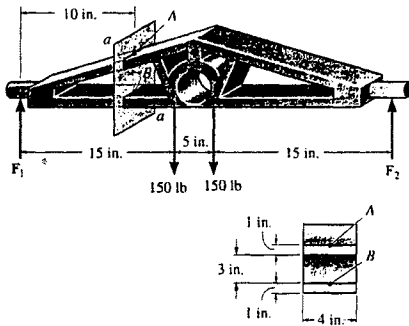

Casting :

$$\begin{aligned} \curvearrowleft + \Sigma M_C = 0; \quad F_1(35) - 150(20) - 150(15) &= 0 \\ F_1 &= 150 \text{ lb} \end{aligned}$$

Section :

$$\begin{aligned} \curvearrowleft + \Sigma M = 0; \quad M - 150(10) &= 0 \\ M &= 1500 \text{ lb} \cdot \text{in.} \end{aligned}$$

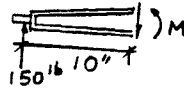

$$I_x = \frac{1}{12}(4)(5^3) - \frac{1}{12}(4)(3)^3 = 32.67 \text{ in}^4$$

$$\sigma_A = \frac{Mc}{I} = \frac{1500(2.5)}{32.67} = 115 \text{ psi (C)} \quad \text{Ans}$$

$$\sigma_B = \frac{My}{I} = \frac{1500(1.5)}{32.67} = 68.9 \text{ psi (T)} \quad \text{Ans}$$

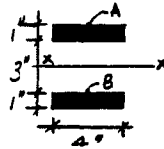

From *Mechanics of Materials*, Sixth Edition by R. C. Hibbeler, ISBN 0-13-191345-X.

© 2005 R. C. Hibbeler. Published by Pearson Prentice Hall,

Pearson Education, Inc., Upper Saddle River, NJ. All rights reserved.

This material is protected under all copyright laws as they currently exist. No portion of this material may be reproduced, in any form or by any means, without permission in writing from the publisher.

6-61 If the shaft in Prob. 6-1 has a diameter of 100 mm, determine the absolute maximum bending stress in the shaft.

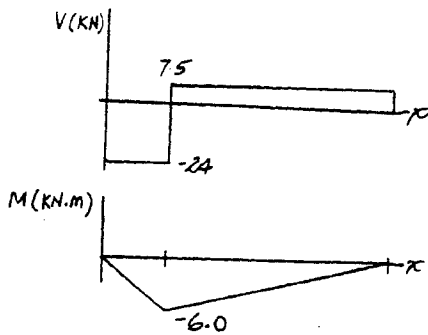
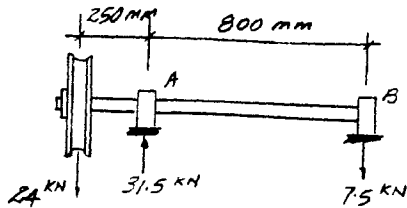
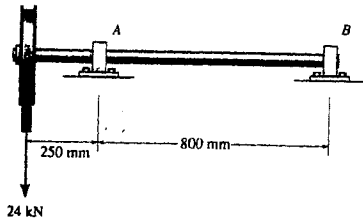

$$M_{\max} = 6000 \text{ N} \cdot \text{m}$$

$$\sigma_{\max} = \frac{Mc}{I} = \frac{(6000)(0.05)}{\frac{1}{4}\pi(0.05)^4} = 61.1 \text{ MPa} \quad \text{Ans}$$

From *Mechanics of Materials*, Sixth Edition by R. C. Hibbeler, ISBN 0-13-191345-X.

© 2005 R. C. Hibbeler. Published by Pearson Prentice Hall,

Pearson Education, Inc., Upper Saddle River, NJ. All rights reserved.

This material is protected under all copyright laws as they currently exist. No portion of this material may be reproduced, in any form or by any means, without permission in writing from the publisher.

6-62 If the shaft in Prob. 6-3 has a diameter of 1.5 in., determine the absolute maximum bending stress in the shaft.

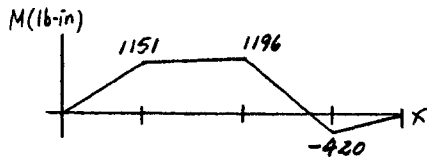
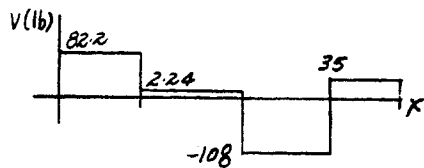
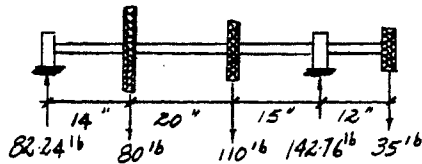
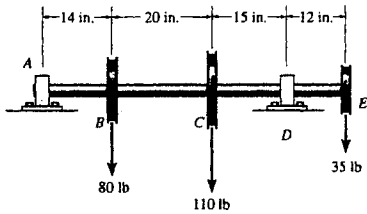

$$M_{\max} = 1196 \text{ lb} \cdot \text{in.}$$

$$\sigma_{\max} = \frac{Mc}{I} = \frac{1196(0.75)}{\frac{1}{4}\pi(0.75)^4} = 3.61 \text{ ksi} \quad \text{Ans}$$

From *Mechanics of Materials*, Sixth Edition by R. C. Hibbeler, ISBN 0-13-191345-X.

© 2005 R. C. Hibbeler. Published by Pearson Prentice Hall,

Pearson Education, Inc., Upper Saddle River, NJ. All rights reserved.

This material is protected under all copyright laws as they currently exist. No portion of this material may be reproduced, in any form or by any means, without permission in writing from the publisher.

6-63 If the shaft in Prob. 6-6 has a diameter of 50 mm, determine the absolute maximum bending stress in the shaft.

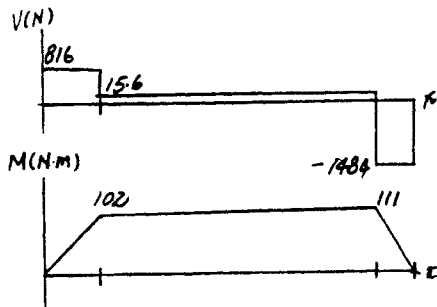
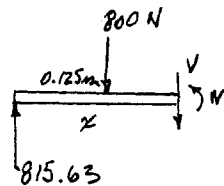
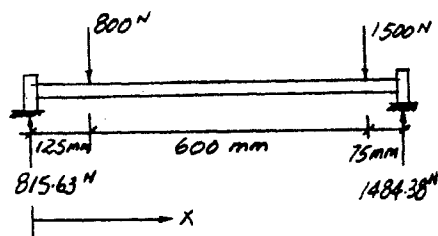
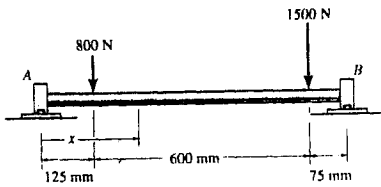

$$M_{\max} = 111 \text{ N} \cdot \text{m}$$

$$\sigma_{\max} = \frac{Mc}{I} = \frac{111(0.025)}{\frac{1}{4}\pi(0.025)^4} = 9.05 \text{ MPa} \quad \text{Ans}$$

From *Mechanics of Materials*, Sixth Edition by R. C. Hibbeler, ISBN 0-13-191345-X.

© 2005 R. C. Hibbeler. Published by Pearson Prentice Hall,

Pearson Education, Inc., Upper Saddle River, NJ. All rights reserved.

This material is protected under all copyright laws as they currently exist. No portion of this material may be reproduced, in any form or by any means, without permission in writing from the publisher.

*6-64 If the pipe in Prob. 6-8 has an outer diameter of 30 mm and thickness of 10 mm, determine the absolute maximum bending stress in the shaft.

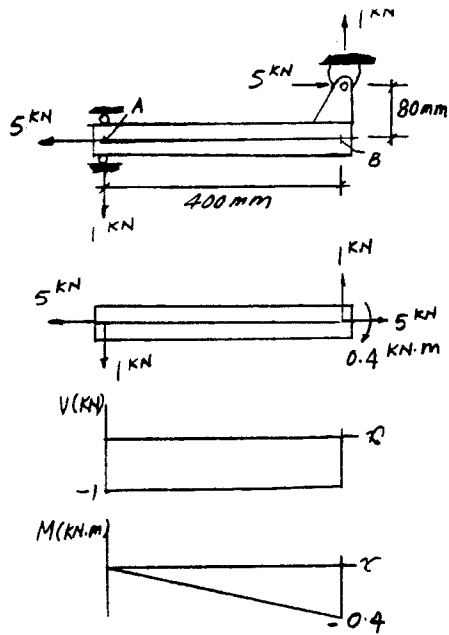
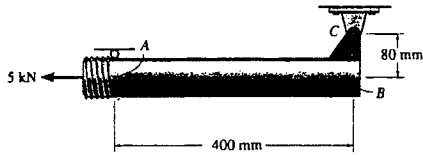

$$M_{\max} = 0.4 \text{ N} \cdot \text{m}$$

$$\sigma_{\max} = \frac{400(0.015)}{\frac{1}{4}\pi((0.015)^4 - (0.005)^4)} = 153 \text{ MPa} \quad \text{Ans}$$

From *Mechanics of Materials*, Sixth Edition by R. C. Hibbeler, ISBN 0-13-191345-X.

© 2005 R. C. Hibbeler. Published by Pearson Prentice Hall,

Pearson Education, Inc., Upper Saddle River, NJ. All rights reserved.

This material is protected under all copyright laws as they currently exist. No portion of this material may be reproduced, in any form or by any means, without permission in writing from the publisher.

6-65 If the beam ACB in Prob. 6-9 has a square cross section, 6 in. by 6 in., determine the absolute maximum bending stress in the beam.

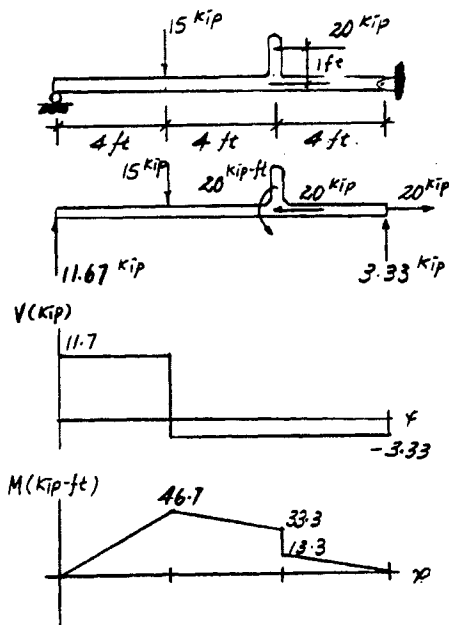
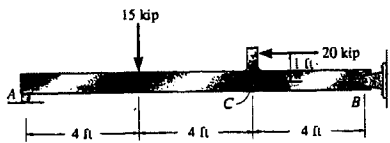

$$M_{\max} = 46.7 \text{ kip} \cdot \text{ft}$$

$$\sigma_{\max} = \frac{Mc}{I} = \frac{46.7(10^3)(12)(3)}{\frac{1}{12}(6)(6^3)} = 15.6 \text{ ksi} \quad \text{Ans}$$

From *Mechanics of Materials*, Sixth Edition by R. C. Hibbeler, ISBN 0-13-191345-X.

© 2005 R. C. Hibbeler. Published by Pearson Prentice Hall,

Pearson Education, Inc., Upper Saddle River, NJ. All rights reserved.

This material is protected under all copyright laws as they currently exist. No portion of this material may be reproduced, in any form or by any means, without permission in writing from the publisher.

6-66 If the crane boom ABC in Prob. 6-10 has a rectangular cross section with a base of 2.5 in., determine its required height h to the nearest 1/4 in. if the allowable bending stress is $\sigma_{\text{allow}} = 24 \text{ ksi}$.

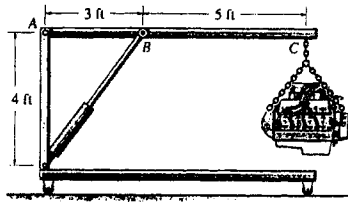

$$\curvearrowleft + \Sigma M_A = 0; \quad \frac{4}{5}F_B(3) - 1200(8) = 0; \quad F_B = 4000 \text{ lb}$$

$$+ \uparrow \Sigma F_y = 0; \quad -A_y + \frac{4}{5}(4000) - 1200 = 0; \quad A_y = 2000 \text{ lb}$$

$$\leftarrow \Sigma F_x = 0; \quad A_x - \frac{3}{5}(4000) = 0; \quad A_x = 2400 \text{ lb}$$

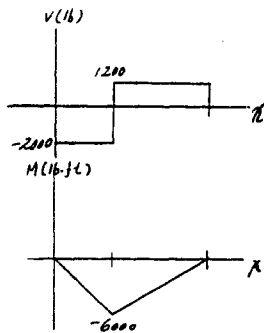
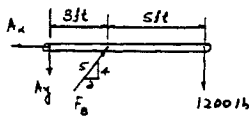

$$\sigma_{\text{max}} = \frac{Mc}{I} = \frac{6000(12)\left(\frac{h}{2}\right)}{\frac{1}{12}(2.5)(h^3)} = 24(10)^3$$

$$h = 2.68 \text{ in.}$$

Use $h = 2.75 \text{ in.}$ **Ans**

From *Mechanics of Materials*, Sixth Edition by R. C. Hibbeler, ISBN 0-13-191345-X.

© 2005 R. C. Hibbeler. Published by Pearson Prentice Hall,

Pearson Education, Inc., Upper Saddle River, NJ. All rights reserved.

This material is protected under all copyright laws as they currently exist. No portion of this material may be reproduced, in any form or by any means, without permission in writing from the publisher.

6-67 If the crane boom ABC in Prob. 6-10 has a rectangular cross section with a base of 2 in. and a height of 3 in., determine the absolute maximum bending stress in the boom.

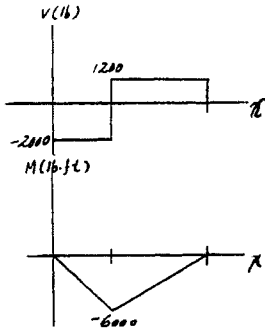
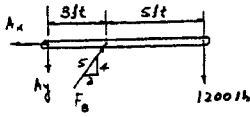
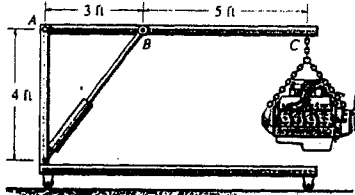

$$M_{\max} = 6000 \text{ lb} \cdot \text{ft}$$

$$\sigma_{\max} = \frac{Mc}{I} = \frac{6000(12)(1.5)}{\frac{1}{12}(2)(3^3)} = 24 \text{ ksi} \quad \text{Ans}$$

From *Mechanics of Materials*, Sixth Edition by R. C. Hibbeler, ISBN 0-13-191345-X.

© 2005 R. C. Hibbeler. Published by Pearson Prentice Hall,

Pearson Education, Inc., Upper Saddle River, NJ. All rights reserved.

This material is protected under all copyright laws as they currently exist. No portion of this material may be reproduced, in any form or by any means, without permission in writing from the publisher.

*6-68 Determine the absolute maximum bending stress in the beam in Prob. 6-24. The cross section is rectangular with a base of 3 in. and height of 4 in.

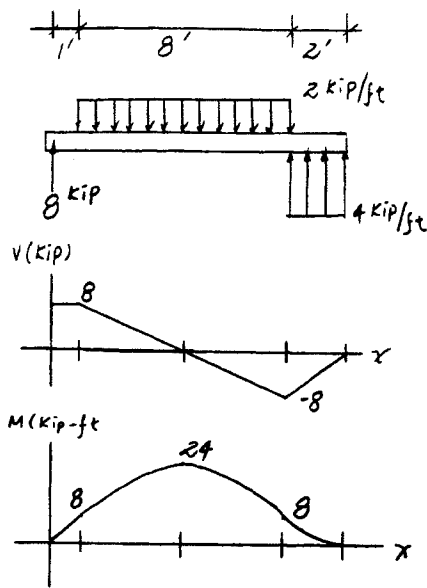
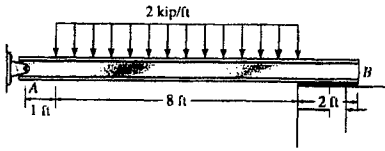

$$M_{\max} = 24 \text{ kip} \cdot \text{ft}$$

$$\sigma_{\max} = \frac{Mc}{I} = \frac{24(12)(10^3)(2)}{\frac{1}{12}(3)(4)^3} = 36 \text{ ksi} \quad \text{Ans}$$

From *Mechanics of Materials*, Sixth Edition by R. C. Hibbeler, ISBN 0-13-191345-X.

© 2005 R. C. Hibbeler. Published by Pearson Prentice Hall,

Pearson Education, Inc., Upper Saddle River, NJ. All rights reserved.

This material is protected under all copyright laws as they currently exist. No portion of this material may be reproduced, in any form or by any means, without permission in writing from the publisher.

6-69 Determine the absolute maximum bending stress in the beam in Prob. 6-25. Each segment has a rectangular cross section with a base of 4 in. and height of 8 in.

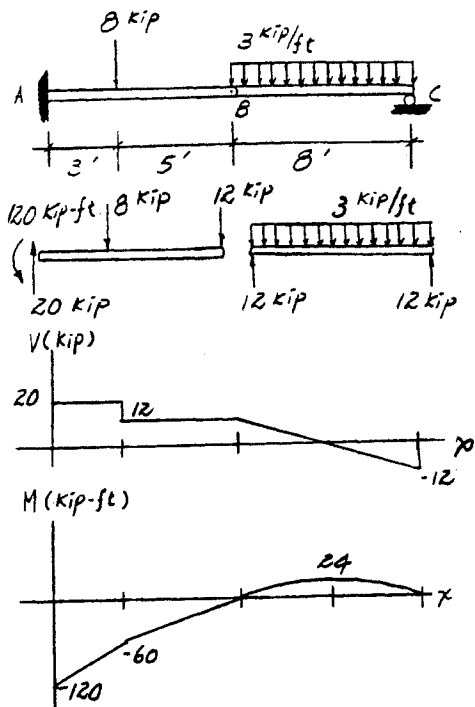
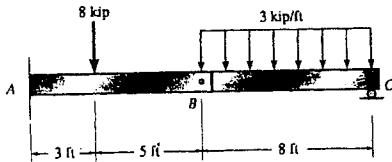

$$M_{\max} = 120 \text{ kip} \cdot \text{ft}$$

$$\sigma_{\max} = \frac{Mc}{I} = \frac{120(12)(10^3)(4)}{\frac{1}{12}(4)(8)^3} = 33.8 \text{ ksi} \quad \text{Ans}$$

From *Mechanics of Materials*, Sixth Edition by R. C. Hibbeler, ISBN 0-13-191345-X.

© 2005 R. C. Hibbeler. Published by Pearson Prentice Hall,

Pearson Education, Inc., Upper Saddle River, NJ. All rights reserved.

This material is protected under all copyright laws as they currently exist. No portion of this material may be reproduced, in any form or by any means, without permission in writing from the publisher.

6-70 Determine the absolute maximum bending stress in the 20-mm-diameter pin in Prob. 6-35.

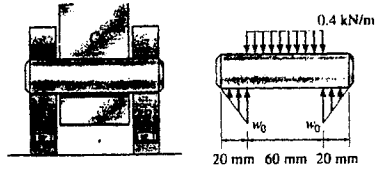

$$+\uparrow \Sigma F_y = 0; \quad 2(w_0)(20)\left(\frac{1}{2}\right) - 60(0.4) = 0$$

$$w_0 = 1.2 \text{ kN/m}$$

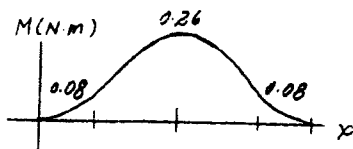
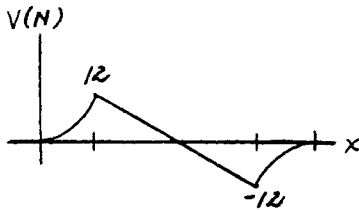
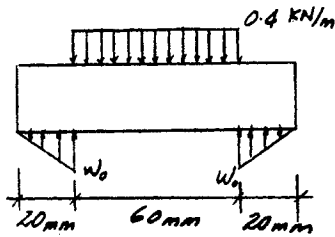

$$\sigma_{\max} = \frac{Mc}{I} = \frac{0.26(0.01)}{\frac{1}{4}\pi(0.01)^4} = 331 \text{ kPa} \quad \text{Ans}$$

From *Mechanics of Materials*, Sixth Edition by R. C. Hibbeler, ISBN 0-13-191345-X.

© 2005 R. C. Hibbeler. Published by Pearson Prentice Hall,

Pearson Education, Inc., Upper Saddle River, NJ. All rights reserved.

This material is protected under all copyright laws as they currently exist. No portion of this material may be reproduced, in any form or by any means, without permission in writing from the publisher.

6-71. The axle of the freight car is subjected to wheel loadings of 20 kip. If it is supported by two journal bearings at *C* and *D*, determine the maximum bending stress developed at the center of the axle, where the diameter is 5.5 in.

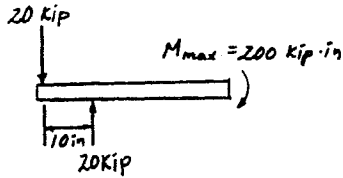
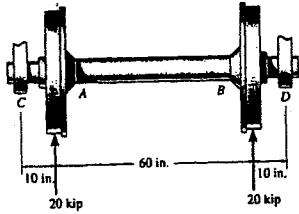

$$\sigma_{\max} = \frac{Mc}{I} = \frac{200(2.75)}{\frac{1}{4}\pi(2.75)^4} = 12.2 \text{ ksi} \quad \text{Ans}$$

From *Mechanics of Materials*, Sixth Edition by R. C. Hibbeler, ISBN 0-13-191345-X.

© 2005 R. C. Hibbeler. Published by Pearson Prentice Hall,

Pearson Education, Inc., Upper Saddle River, NJ. All rights reserved.

This material is protected under all copyright laws as they currently exist. No portion of this material may be reproduced, in any form or by any means, without permission in writing from the publisher.

*6-72 Determine the absolute maximum bending stress in the 30-mm-diameter shaft which is subjected to the concentrated forces. The sleeve bearings at *A* and *B* support only vertical forces.

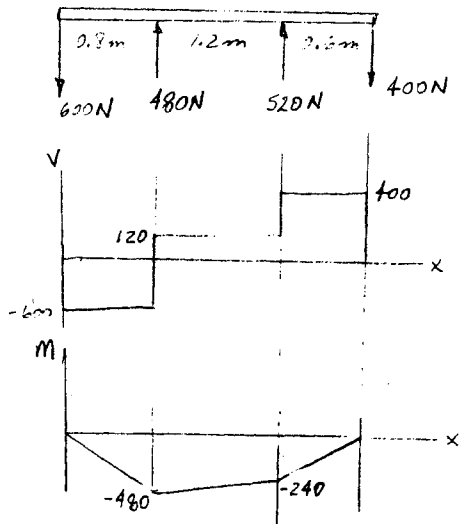
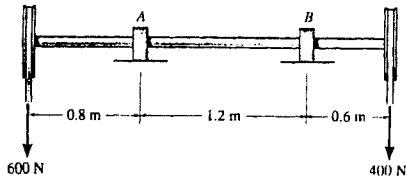

$$\sigma_{\max} = \frac{Mc}{I} = \frac{480(0.015)}{\frac{1}{4}\pi(0.015)^4} = 181 \text{ MPa} \quad \text{Ans}$$

From *Mechanics of Materials*, Sixth Edition by R. C. Hibbeler, ISBN 0-13-191345-X.

© 2005 R. C. Hibbeler. Published by Pearson Prentice Hall,

Pearson Education, Inc., Upper Saddle River, NJ. All rights reserved.

This material is protected under all copyright laws as they currently exist. No portion of this material may be reproduced, in any form or by any means, without permission in writing from the publisher.

6-73 Determine the smallest allowable diameter of the shaft which is subjected to the concentrated forces. The sleeve bearings at *A* and *B* support only vertical forces, and the allowable bending stress is $\sigma_{\text{allow}} = 160 \text{ MPa}$.

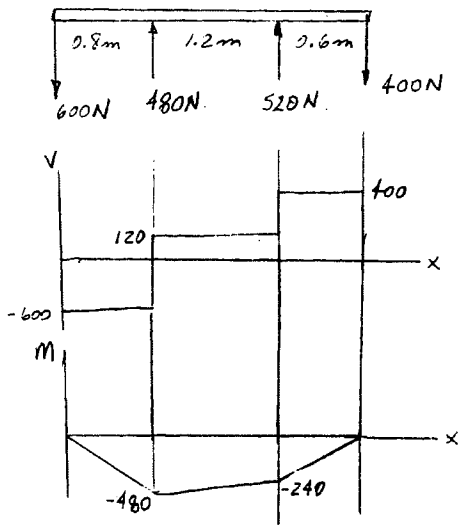
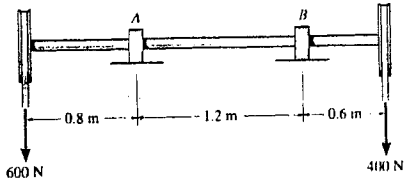

$$M_{\text{max}} = 480 \text{ N} \cdot \text{m}$$

$$\sigma_{\text{allow}} = \frac{Mc}{I}; \quad 160(10^6) = \frac{480c}{\frac{1}{4}\pi c^4}$$

$$c = 0.01563 \text{ m}$$

$$d = 31.3 \text{ mm} \quad \text{Ans}$$

From *Mechanics of Materials*, Sixth Edition by R. C. Hibbeler, ISBN 0-13-191345-X.

© 2005 R. C. Hibbeler. Published by Pearson Prentice Hall,

Pearson Education, Inc., Upper Saddle River, NJ. All rights reserved.

This material is protected under all copyright laws as they currently exist. No portion of this material may be reproduced, in any form or by any means, without permission in writing from the publisher.

6-74 Determine the absolute maximum bending stress in the 1.5-in.-diameter shaft which is subjected to the concentrated forces. The sleeve bearings at *A* and *B* support only vertical forces.

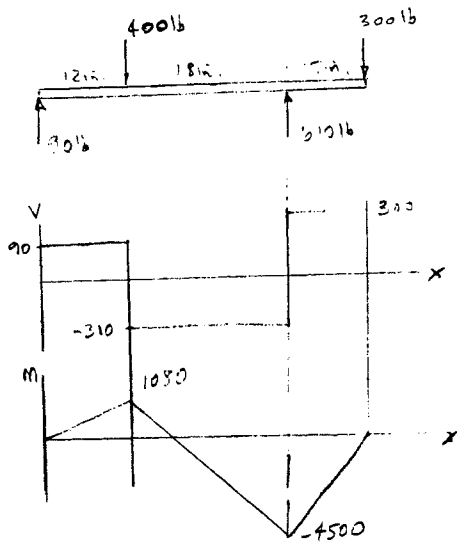
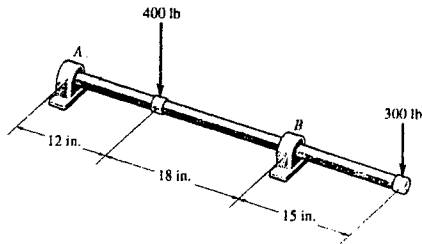

$$M_{\max} = 4500 \text{ lb} \cdot \text{in.}$$

$$\sigma = \frac{Mc}{I} = \frac{4500(0.75)}{\frac{1}{4}\pi(0.75)^4} = 13.6 \text{ ksi} \quad \text{Ans}$$

From *Mechanics of Materials*, Sixth Edition by R. C. Hibbeler, ISBN 0-13-191345-X.

© 2005 R. C. Hibbeler. Published by Pearson Prentice Hall,

Pearson Education, Inc., Upper Saddle River, NJ. All rights reserved.

This material is protected under all copyright laws as they currently exist. No portion of this material may be reproduced, in any form or by any means, without permission in writing from the publisher.

6-75 Determine the smallest allowable diameter of the shaft which is subjected to the concentrated forces. The sleeve bearings at *A* and *B* support only vertical forces, and the allowable bending stress is $\sigma_{\text{allow}} = 22 \text{ ksi}$.

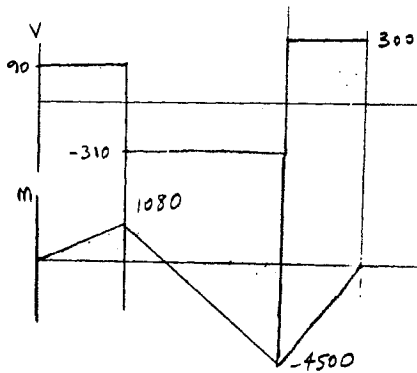
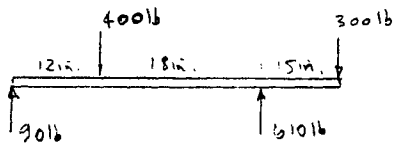
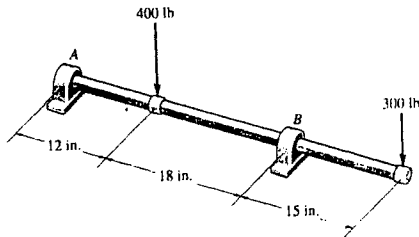

$$M_{\text{max}} = 4500 \text{ lb} \cdot \text{in.}$$

$$\sigma = \frac{Mc}{I}; \quad 22(10^3) = \frac{4500c}{\frac{1}{4}\pi c^4}$$

$$c = 0.639 \text{ in.}$$

$$d = 1.28 \text{ in.} \quad \text{Ans}$$

From *Mechanics of Materials*, Sixth Edition by R. C. Hibbeler, ISBN 0-13-191345-X.

© 2005 R. C. Hibbeler. Published by Pearson Prentice Hall,

Pearson Education, Inc., Upper Saddle River, NJ. All rights reserved.

This material is protected under all copyright laws as they currently exist. No portion of this material may be reproduced, in any form or by any means, without permission in writing from the publisher.

*6-76. The strut on the utility pole supports the cable having a weight of 600 lb. Determine the absolute maximum bending stress in the strut if A, B, and C are assumed to be pinned.

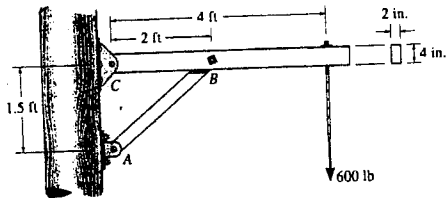

$$(+ \Sigma M_C = 0; \quad F_{AB} \left(\frac{3}{5}\right)(2) - 600(4) = 0$$

$$F_{AB} = 2000 \text{ lb}$$

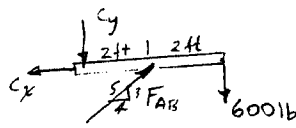

$$+ \uparrow \Sigma F_y = 0; \quad -C_y + 2000\left(\frac{3}{5}\right) - 600 = 0$$

$$C_y = 600 \text{ lb}$$

$$\rightarrow \Sigma F_x = 0; \quad 2000\left(\frac{4}{5}\right) - C_x = 0$$

$$C_x = 1600 \text{ lb}$$

$$\sigma_{\max} = \frac{Mc}{I} = \frac{1200(12)(2)}{\frac{1}{12}(2)(4)^3} = 2.70 \text{ ksi} \quad \text{Ans}$$

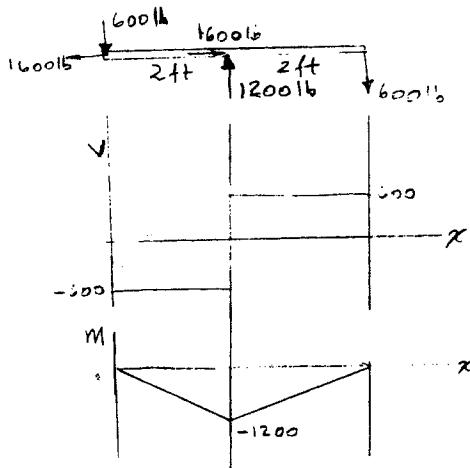

From *Mechanics of Materials*, Sixth Edition by R. C. Hibbeler, ISBN 0-13-191345-X.

© 2005 R. C. Hibbeler. Published by Pearson Prentice Hall,

Pearson Education, Inc., Upper Saddle River, NJ. All rights reserved.

This material is protected under all copyright laws as they currently exist. No portion of this material may be reproduced, in any form or by any means, without permission in writing from the publisher.

6-77 A portion of the femur can be modeled as a tube having an inner diameter of 0.375 in. and an outer diameter of 1.25 in. Determine the maximum elastic static force P that can be applied to its center without causing failure. Assume the bone to be roller supported at its ends. The σ - ϵ diagram for the bone mass is shown and is the same in tension as in compression.

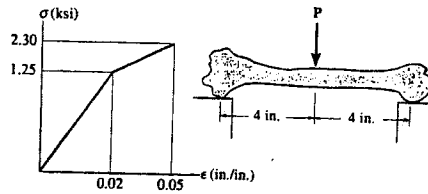

$$I = \frac{1}{4} \pi \left[\left(\frac{1.25}{2} \right)^4 - \left(\frac{0.375}{2} \right)^4 \right] = 0.11887 \text{ in}^4$$

$$M_{\max} = \frac{P}{2}(4) = 2P$$

Require $\sigma_{\max} = 1.25 \text{ ksi}$

$$\sigma_{\max} = \frac{Mc}{I}$$

$$1.25 = \frac{2P(1.25/2)}{0.11887}$$

$$P = 0.119 \text{ kip} = 119 \text{ lb} \quad \text{Ans}$$

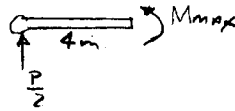

From *Mechanics of Materials*, Sixth Edition by R. C. Hibbeler, ISBN 0-13-191345-X.

© 2005 R. C. Hibbeler. Published by Pearson Prentice Hall,

Pearson Education, Inc., Upper Saddle River, NJ. All rights reserved.

This material is protected under all copyright laws as they currently exist. No portion of this material may be reproduced, in any form or by any means, without permission in writing from the publisher.

6-78 The chair is supported by an arm that is hinged so it rotates about the vertical axis at *A*. If the load on the chair is 180 lb and the arm is a hollow tube section having the dimensions shown, determine the maximum bending stress at section *a-a*.

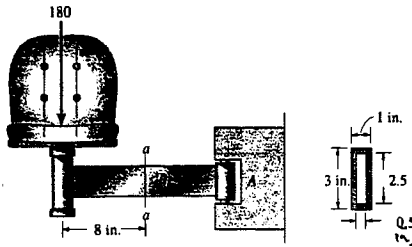

$$\begin{aligned} \sum M = 0; \quad M - 180(8) &= 0 \\ M &= 1440 \text{ lb} \cdot \text{in.} \end{aligned}$$

$$I_x = \frac{1}{12}(1)(3^3) - \frac{1}{12}(0.5)(2.5^3) = 1.59896 \text{ in}^4$$

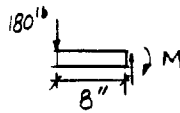

$$\sigma_{\max} = \frac{Mc}{I} = \frac{1440(1.5)}{1.59896} = 1.35 \text{ ksi} \quad \text{Ans}$$

From *Mechanics of Materials*, Sixth Edition by R. C. Hibbeler, ISBN 0-13-191345-X.

© 2005 R. C. Hibbeler. Published by Pearson Prentice Hall,

Pearson Education, Inc., Upper Saddle River, NJ. All rights reserved.

This material is protected under all copyright laws as they currently exist. No portion of this material may be reproduced, in any form or by any means, without permission in writing from the publisher.

6-79 The steel shaft has a circular cross section with a diameter of 2 in. It is supported on smooth journal bearings *A* and *B*, which exert only vertical reactions on the shaft. Determine the absolute maximum bending stress in the shaft if it is subjected to the pulley loadings shown.

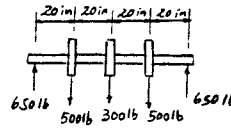
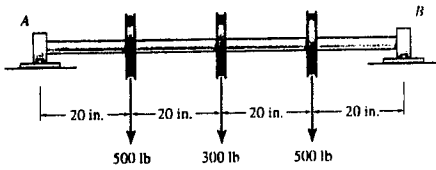

$$I = \frac{1}{4} \pi (1^4) = 0.7854 \text{ in}^4$$

$$\sigma_{\max} = \frac{Mc}{I} = \frac{16000 (1)}{0.7854} = 20.4 \text{ ksi}$$

Ans

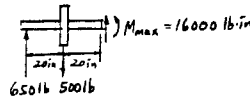

From *Mechanics of Materials*, Sixth Edition by R. C. Hibbeler, ISBN 0-13-191345-X.
 © 2005 R. C. Hibbeler. Published by Pearson Prentice Hall,
 Pearson Education, Inc., Upper Saddle River, NJ. All rights reserved.
 This material is protected under all copyright laws as they currently exist. No portion of this material may be reproduced, in any form or by any means, without permission in writing from the publisher.

*6-80. The end supports of a drillers' scaffold used in coal mining consist of a suspended 4-in.-outside-diameter pipe and telescoping 3-in.-outside-diameter pipe having a length of 1.5 ft. Each pipe has a thickness of 0.25 in. If the end reactions of the supported planks are given, determine the absolute maximum bending stress in each pipe. Neglect the size of the planks in the calculation.

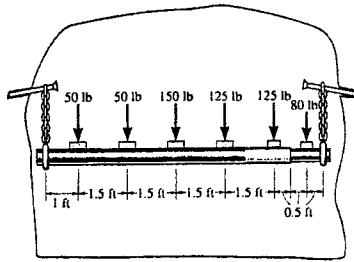

4 in. diameter pipe :

$$M_{\max} = 693.82 \text{ lb} \cdot \text{ft}$$

$$\sigma_{\max} = \frac{Mc}{I} = \frac{693.82(12)(2)}{\frac{1}{4}\pi(2)^4 - (1.75)^4} = 3.20 \text{ ksi} \quad \text{Ans}$$

3 in. diameter pipe :

$$M_{\max} = 310.29 \text{ lb} \cdot \text{ft}$$

$$\sigma_{\max} = \frac{Mc}{I} = \frac{310.29(12)(1.5)}{\frac{1}{4}\pi(1.5)^4 - (1.25)^4} = 2.71 \text{ ksi} \quad \text{Ans}$$

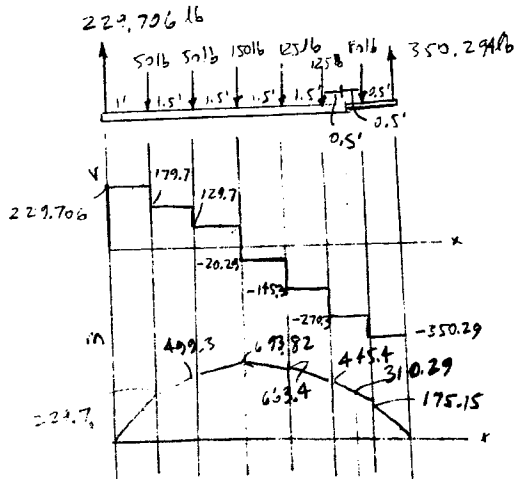

From *Mechanics of Materials*, Sixth Edition by R. C. Hibbeler, ISBN 0-13-191345-X.

© 2005 R. C. Hibbeler. Published by Pearson Prentice Hall,

Pearson Education, Inc., Upper Saddle River, NJ. All rights reserved.

This material is protected under all copyright laws as they currently exist. No portion of this material may be reproduced, in any form or by any means, without permission in writing from the publisher.

6-81. The beam is subjected to the load P at its center. Determine the placement a of the supports so that the absolute maximum bending stress in the beam is as large as possible. What is this stress?

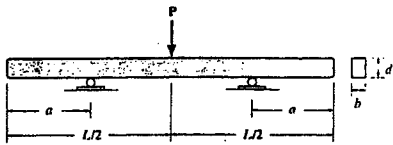

$$M_{\max} = \frac{P}{2} \left(\frac{L}{2} - a \right)$$

For the largest M_{\max} require,

$$a = 0 \quad \text{Ans}$$

$$\sigma_{\max} = \frac{Mc}{I} = \frac{(P/2)(\frac{L}{2})(\frac{d}{2})}{\frac{1}{12} b d^3} = \frac{3 PL}{2 b d^2} \quad \text{Ans}$$

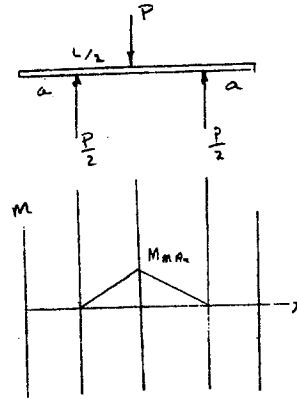
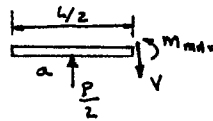

From *Mechanics of Materials*, Sixth Edition by R. C. Hibbeler, ISBN 0-13-191345-X.

© 2005 R. C. Hibbeler. Published by Pearson Prentice Hall,

Pearson Education, Inc., Upper Saddle River, NJ. All rights reserved.

This material is protected under all copyright laws as they currently exist. No portion of this material may be reproduced, in any form or by any means, without permission in writing from the publisher.

6-82. The simply supported truss is subjected to the central distributed load. Neglect the effect of the diagonal lacing and determine the absolute maximum bending stress in the truss. The top member is a pipe having an outer diameter of 1 in. and thickness of $\frac{3}{16}$ in., and the bottom member is a solid rod having a diameter of $\frac{1}{2}$ in.

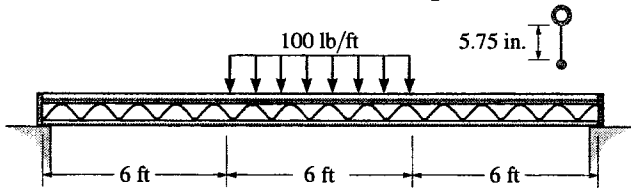

$$\bar{y} = \frac{\sum \bar{y}A}{\sum A} = \frac{0 + (6.50)(0.4786)}{0.4786 + 0.19635} = 4.6091 \text{ in.}$$

$$I = \left[\frac{1}{4}\pi(0.5)^4 - \frac{1}{4}\pi(0.3125)^4 \right] + 0.4786(6.50 - 4.6091)^2 + \frac{1}{4}\pi(0.25)^4 + 0.19635(4.6091)^2 = 5.9271 \text{ in}^4$$

$$M_{\max} = 300(9 - 1.5)(12) = 27\,000 \text{ lb} \cdot \text{in.}$$

$$\sigma_{\max} = \frac{Mc}{I} = \frac{27\,000(4.6091 + 0.25)}{5.9271}$$

$$= 22.1 \text{ ksi} \quad \text{Ans}$$

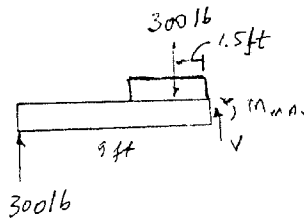

From *Mechanics of Materials*, Sixth Edition by R. C. Hibbeler, ISBN 0-13-191345-X.

© 2005 R. C. Hibbeler. Published by Pearson Prentice Hall,

Pearson Education, Inc., Upper Saddle River, NJ. All rights reserved.

This material is protected under all copyright laws as they currently exist. No portion of this material may be reproduced, in any form or by any means, without permission in writing from the publisher.

6-83 The pin is used to connect the three links together. Due to wear, the load is distributed over the top and bottom of the pin as shown on the free-body diagram. If the diameter of the pin is 0.40 in., determine the maximum bending stress on the cross-sectional area at the center section $a-a$. For the solution it is first necessary to determine the load intensities w_1 and w_2 .

$$\frac{1}{2} w_2 (1) = 400; \quad w_2 = 800 \text{ lb/in.}$$

$$w_1 (1.5) = 800; \quad w_1 = 533 \text{ lb/in.}$$

$$M = 400 (0.70833) = 283.33 \text{ lb} \cdot \text{in}$$

$$I = \frac{1}{4} \pi (0.2^4) = 0.0012566 \text{ in}^4$$

$$\sigma_{\max} = \frac{M c}{I} = \frac{283.33 (0.2)}{0.0012566}$$

$$= 45.1 \text{ ksi} \quad \text{Ans}$$

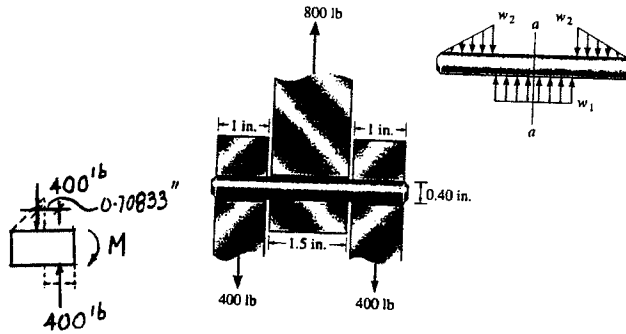

From *Mechanics of Materials*, Sixth Edition by R. C. Hibbeler, ISBN 0-13-191345-X.

© 2005 R. C. Hibbeler. Published by Pearson Prentice Hall,

Pearson Education, Inc., Upper Saddle River, NJ. All rights reserved.

This material is protected under all copyright laws as they currently exist. No portion of this material may be reproduced, in any form or by any means, without permission in writing from the publisher.

*6-84 A shaft is made of a polymer having an elliptical cross-section. If it resists an internal moment of $M = 50 \text{ N} \cdot \text{m}$, determine the maximum bending stress developed in the material (a) using the flexure formula, where $I_x = \frac{1}{4}\pi(0.08 \text{ m})(0.04 \text{ m})^3$, (b) using integration. Sketch a three-dimensional view of the stress distribution acting over the cross-sectional area.

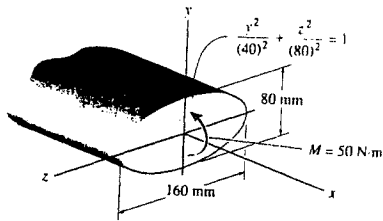

a)
$$I = \frac{1}{4}\pi ab^3 = \frac{1}{4}\pi(0.08)(0.04)^3 = 4.021238(10^{-6})\text{m}^4$$

$$\sigma_{\max} = \frac{Mc}{I} = \frac{50(0.04)}{4.021238(10^{-6})} = 497 \text{ kPa} \quad \text{Ans}$$

b)

$$M = \frac{\sigma_{\max}}{c} \int_A y^2 dA$$

$$= \frac{\sigma_{\max}}{c} \int y^2 2z dy$$

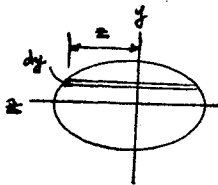

$$z = \sqrt{0.0064 - 4y^2} = 2\sqrt{(0.04)^2 - y^2}$$

$$2 \int_{-0.04}^{0.04} y^2 z dy = 4 \int_{-0.04}^{0.04} y^2 \sqrt{(0.04)^2 - y^2} dy$$

$$= 4 \left[\frac{(0.04)^4}{8} \sin^{-1} \left(\frac{y}{0.04} \right) - \frac{1}{8} y \sqrt{0.04^2 - y^2} (0.04^2 - 2y^2) \right] \Big|_{-0.04}^{0.04}$$

$$= \frac{(0.04)^4}{2} \sin^{-1} \left(\frac{y}{0.04} \right) \Big|_{-0.04}^{0.04}$$

$$= 4.021238(10^{-6})\text{m}^4$$

$$\sigma_{\max} = \frac{50(0.04)}{4.021238(10^{-6})} = 497 \text{ kPa} \quad \text{Ans}$$

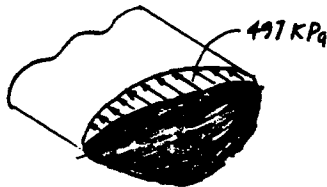

From *Mechanics of Materials*, Sixth Edition by R. C. Hibbeler, ISBN 0-13-191345-X.

© 2005 R. C. Hibbeler. Published by Pearson Prentice Hall,

Pearson Education, Inc., Upper Saddle River, NJ. All rights reserved.

This material is protected under all copyright laws as they currently exist. No portion of this material may be reproduced, in any form or by any means, without permission in writing from the publisher.

6-85 Solve Prob. 6-84 if the moment $M = 50 \text{ N} \cdot \text{m}$ is applied about the y axis instead of the x axis. Here $I_y = \frac{1}{4}\pi (0.04 \text{ m})(0.08 \text{ m})^3$.

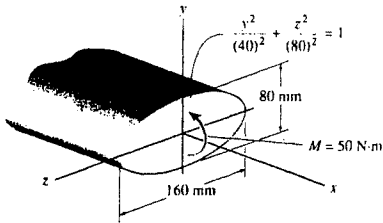

a)

$$I = \frac{1}{4}\pi ab^3 = \frac{1}{4}\pi(0.04)(0.08)^3 = 16.085(10^{-6}) \text{ m}^4$$

$$\sigma_{\max} = \frac{Mc}{I} = \frac{50(0.08)}{16.085(10^{-6})} = 249 \text{ kPa} \quad \text{Ans}$$

b)

$$M = \int_A z(\sigma dA) = \int_A z\left(\frac{\sigma_{\max}}{0.08}\right)(z)(2y)dz$$

$$50 = 2\left(\frac{\sigma_{\max}}{0.04}\right)\int_0^{0.08} z^2\left(1 - \frac{z^2}{(0.08)^2}\right)^{1/2}(0.04)dz$$

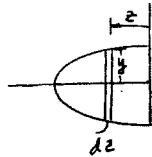

$$50 = 201.06(10^{-6})\sigma_{\max}$$

$$\sigma_{\max} = 249 \text{ kPa} \quad \text{Ans}$$

From *Mechanics of Materials*, Sixth Edition by R. C. Hibbeler, ISBN 0-13-191345-X.

© 2005 R. C. Hibbeler. Published by Pearson Prentice Hall,

Pearson Education, Inc., Upper Saddle River, NJ. All rights reserved.

This material is protected under all copyright laws as they currently exist. No portion of this material may be reproduced, in any form or by any means, without permission in writing from the publisher.

6-86 The simply supported beam is made from four 3/4-in.-diameter rods, which are bundled as shown. Determine the maximum bending stress in the beam due to the loading shown.

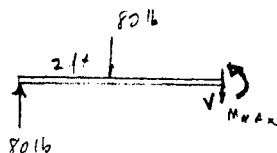
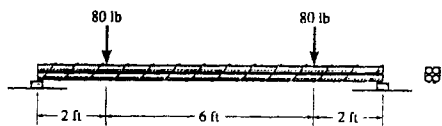

$$M_{max} = 80(2) = 160 \text{ lb} \cdot \text{ft}$$

$$I = 4\left[\frac{1}{4}\pi(3/8)^4 + \pi(3/8)^2(3/8)^2\right] = 0.31063 \text{ in}^4$$

$$\sigma_{max} = \frac{Mc}{I} = \frac{160(12)(3/4)}{0.31063} = 4.64 \text{ ksi} \quad \text{Ans.}$$

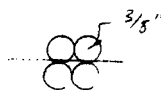

From *Mechanics of Materials*, Sixth Edition by R. C. Hibbeler, ISBN 0-13-191345-X.
 © 2005 R. C. Hibbeler. Published by Pearson Prentice Hall,
 Pearson Education, Inc., Upper Saddle River, NJ. All rights reserved.
 This material is protected under all copyright laws as they currently exist. No portion of this material may be reproduced, in any form or by any means, without permission in writing from the publisher.

6-87 Solve Prob. 6-86 if the bundle is rotated 45° and set on the supports.

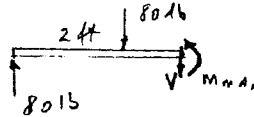
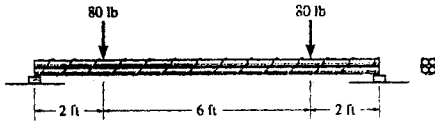

$$M_{max} = 80(2) = 160 \text{ lb} \cdot \text{ft}$$

$$I = 2\left[\frac{1}{4}\pi(3/8)^4\right] + 2\left[\frac{1}{4}\pi(3/8)^4 + \pi(3/8)^2\left(\frac{3}{4}\sin 45^\circ\right)^2\right] = 0.31063 \text{ in}^4$$

$$\sigma_{max} = \frac{Mc}{I} = \frac{160(12)\left(\frac{3}{4}\sin 45^\circ + \frac{3}{8}\right)}{0.31063} = 5.60 \text{ ksi} \quad \text{Ans}$$

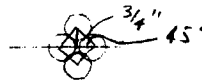

From *Mechanics of Materials*, Sixth Edition by R. C. Hibbeler, ISBN 0-13-191345-X.
 © 2005 R. C. Hibbeler. Published by Pearson Prentice Hall,
 Pearson Education, Inc., Upper Saddle River, NJ. All rights reserved.
 This material is protected under all copyright laws as they currently exist. No portion of this material may be reproduced, in any form or by any means, without permission in writing from the publisher.

*6-88 The steel beam has the cross-sectional area shown. Determine the largest intensity of distributed load w that it can support so that the bending stress does not exceed $\sigma_{\max} = 22$ ksi.

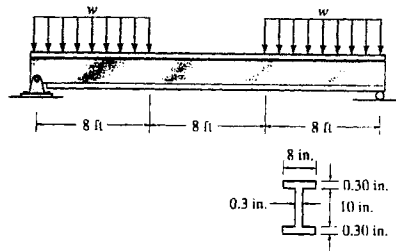

$$I = \frac{1}{12}(8)(10.6)^3 - \frac{1}{12}(7.7)(10^3) = 152.344 \text{ in}^4$$

$$\sigma_{\max} = \frac{Mc}{I}$$

$$22 = \frac{32w(12)(5.3)}{152.344}$$

$$w = 1.65 \text{ kip/ft} \quad \text{Ans}$$

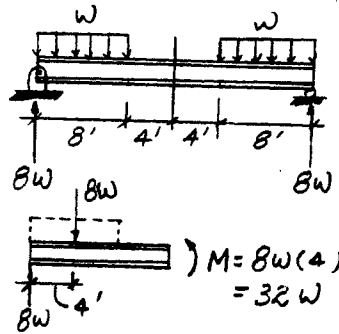

From *Mechanics of Materials*, Sixth Edition by R. C. Hibbeler, ISBN 0-13-191345-X.

© 2005 R. C. Hibbeler. Published by Pearson Prentice Hall,

Pearson Education, Inc., Upper Saddle River, NJ. All rights reserved.

This material is protected under all copyright laws as they currently exist. No portion of this material may be reproduced, in any form or by any means, without permission in writing from the publisher.

6-89 The steel beam has the cross-sectional area shown. If $w = 5$ kip/ft, determine the absolute maximum bending stress in the beam.

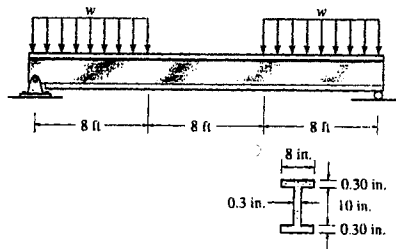

From Prob. 6-88;

$$M = 32w = 32(5)(12) = 1920 \text{ kip} \cdot \text{in.}$$

$$I = 152.344 \text{ in}^4$$

$$\sigma_{\max} = \frac{Mc}{I} = \frac{1920(5.3)}{152.344} = 66.8 \text{ ksi} \quad \text{Ans}$$

From *Mechanics of Materials*, Sixth Edition by R. C. Hibbeler, ISBN 0-13-191345-X.

© 2005 R. C. Hibbeler. Published by Pearson Prentice Hall,

Pearson Education, Inc., Upper Saddle River, NJ. All rights reserved.

This material is protected under all copyright laws as they currently exist. No portion of this material may be reproduced, in any form or by any means, without permission in writing from the publisher.

6-90 The beam has a rectangular cross section as shown. Determine the largest load P that can be supported on its overhanging ends so that the bending stress does not exceed $\sigma_{\max} = 10 \text{ MPa}$.

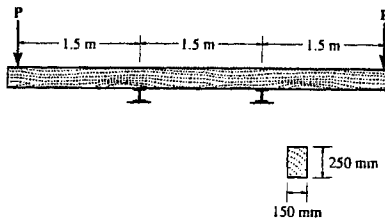

$$I = \frac{1}{12}(0.15)(0.25^3) = 1.953125(10^{-4})\text{m}^4$$

$$\sigma_{\max} = \frac{Mc}{I}$$

$$10(10^6) = \frac{1.5P(0.125)}{1.953125(10^{-4})}$$

$$P = 10.4 \text{ kN} \quad \text{Ans}$$

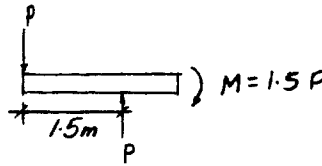

From *Mechanics of Materials*, Sixth Edition by R. C. Hibbeler, ISBN 0-13-191345-X.

© 2005 R. C. Hibbeler. Published by Pearson Prentice Hall,

Pearson Education, Inc., Upper Saddle River, NJ. All rights reserved.

This material is protected under all copyright laws as they currently exist. No portion of this material may be reproduced, in any form or by any means, without permission in writing from the publisher.

6-91 The beam has the rectangular cross section shown. If $P = 12 \text{ kN}$, determine the absolute maximum bending stress in the beam. Sketch the stress distribution acting over the cross section.

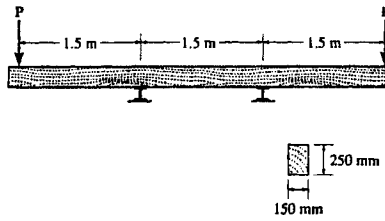

From Prob. 6-90 :

$$M = 1.5P = 1.5(12)(10^3) = 18000 \text{ N} \cdot \text{m}$$

$$I = 1.953125(10^{-4})\text{m}^4$$

$$\sigma_{\max} = \frac{Mc}{I} = \frac{18000(0.125)}{1.953125(10^{-4})} = 11.5 \text{ MPa} \quad \text{Ans}$$

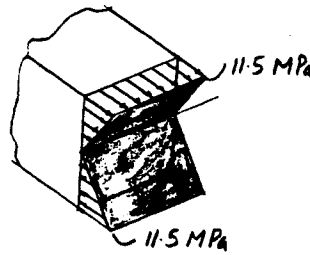

From *Mechanics of Materials*, Sixth Edition by R. C. Hibbeler, ISBN 0-13-191345-X.

© 2005 R. C. Hibbeler. Published by Pearson Prentice Hall,

Pearson Education, Inc., Upper Saddle River, NJ. All rights reserved.

This material is protected under all copyright laws as they currently exist. No portion of this material may be reproduced, in any form or by any means, without permission in writing from the publisher.

*6-92 A log that is 2 ft in diameter is to be cut into a rectangular section for use as a simply supported beam. If the allowable bending stress for the wood is $\sigma_{\text{allow}} = 8 \text{ ksi}$, determine the required width b and height h of the beam that will support the largest load possible. What is this load?

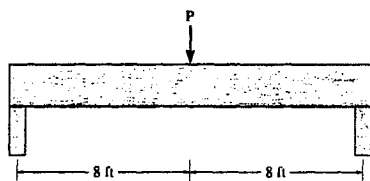
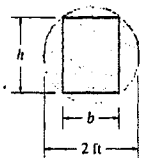

$$(24)^2 = b^2 + h^2$$

$$M_{\text{max}} = \frac{P}{2}(8)(12) = 48P$$

$$\sigma_{\text{allow}} = \frac{Mc}{I} = \frac{M_{\text{max}}(\frac{h}{2})}{\frac{1}{12}(b)(h)^3}$$

$$\sigma_{\text{allow}} = \frac{6 M_{\text{max}}}{bh^2}$$

$$bh^2 = \frac{6}{8000}(48P)$$

$$b(24)^2 - b^3 = 0.036P$$

$$(24)^2 - 3b^2 = 0.036 \frac{dP}{db} = 0$$

$$b = 13.856 \text{ in.}$$

Thus, from the above equations,

$$b = 13.9 \text{ in.} \quad \text{Ans}$$

$$h = 19.6 \text{ in.} \quad \text{Ans}$$

$$P = 148 \text{ kip} \quad \text{Ans}$$

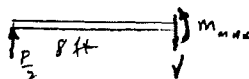
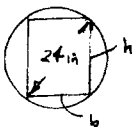

From *Mechanics of Materials*, Sixth Edition by R. C. Hibbeler, ISBN 0-13-191345-X.

© 2005 R. C. Hibbeler. Published by Pearson Prentice Hall,

Pearson Education, Inc., Upper Saddle River, NJ. All rights reserved.

This material is protected under all copyright laws as they currently exist. No portion of this material may be reproduced, in any form or by any means, without permission in writing from the publisher.

6-93 A log that is 2 ft in diameter is to be cut into a rectangular section for use as a simply supported beam. If the allowable bending stress for the wood is $\sigma_{\text{allow}} = 8 \text{ ksi}$, determine the largest load P that can be supported if the width of the beam is $b = 8 \text{ in.}$

$$24^2 = h^2 + 8^2$$

$$h = 22.63 \text{ in.}$$

$$M_{\text{max}} = \frac{P}{2}(96) = 48P$$

$$\sigma_{\text{allow}} = \frac{M_{\text{max}} c}{I}$$

$$8(10^3) = \frac{48P(\frac{22.63}{2})}{\frac{1}{12}(8)(22.63)^3}$$

$$P = 114 \text{ kip} \quad \text{Ans}$$

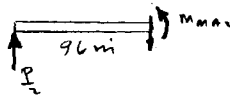
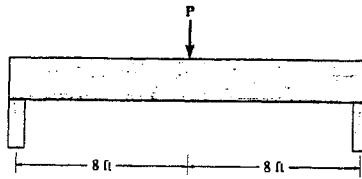
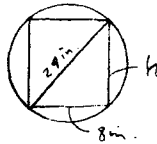
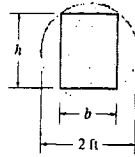

From *Mechanics of Materials*, Sixth Edition by R. C. Hibbeler, ISBN 0-13-191345-X.

© 2005 R. C. Hibbeler. Published by Pearson Prentice Hall,

Pearson Education, Inc., Upper Saddle River, NJ. All rights reserved.

This material is protected under all copyright laws as they currently exist. No portion of this material may be reproduced, in any form or by any means, without permission in writing from the publisher.

6-94. The wing spar ABD of a light plane is made from 2014-T6 aluminum and has a cross-sectional area of 1.27 in.^2 , a depth of 3 in. , and a moment of inertia about its neutral axis of 2.68 in.^4 . Determine the absolute maximum bending stress in the spar if the anticipated loading is to be as shown. Assume A , B , and C are pins. Connection is made along the central longitudinal axis of the spar.

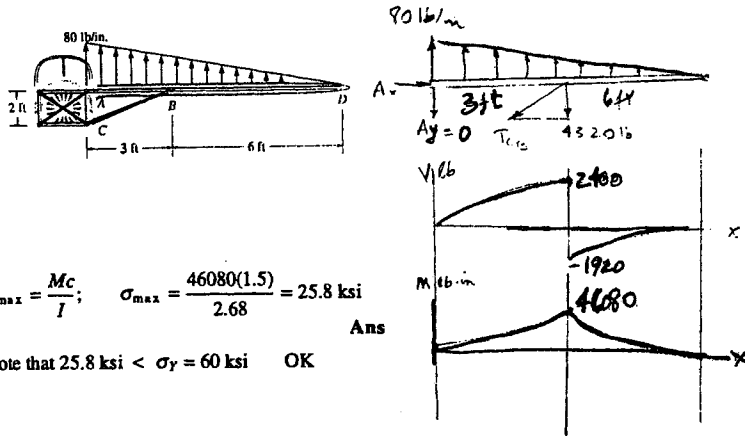

$$\sigma_{\max} = \frac{Mc}{I}; \quad \sigma_{\max} = \frac{46080(1.5)}{2.68} = 25.8 \text{ ksi}$$

Ans

Note that $25.8 \text{ ksi} < \sigma_y = 60 \text{ ksi}$ OK

From *Mechanics of Materials*, Sixth Edition by R. C. Hibbeler, ISBN 0-13-191345-X.

© 2005 R. C. Hibbeler. Published by Pearson Prentice Hall,

Pearson Education, Inc., Upper Saddle River, NJ. All rights reserved.

This material is protected under all copyright laws as they currently exist. No portion of this material may be reproduced, in any form or by any means, without permission in writing from the publisher.

6-95. The boat has a weight of 2300 lb and a center of gravity at G . If it rests on the trailer at the smooth contact A and can be considered pinned at B , determine the absolute maximum bending stress developed in the main strut of the trailer. Consider the strut to be a box-beam having the dimensions shown and pinned at C .

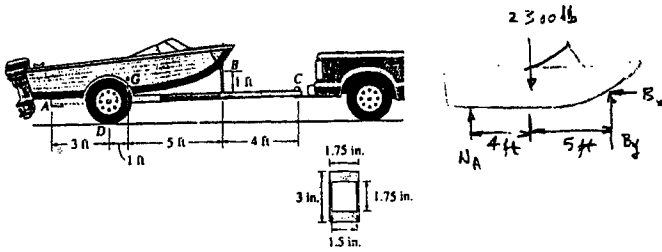

Boat :

$$\rightarrow \Sigma F_x = 0; \quad B_x = 0$$

$$\curvearrowleft \Sigma M_B = 0; \quad -N_A(9) + 2300(5) = 0$$

$$N_A = 1277.78 \text{ lb}$$

$$+\uparrow \Sigma F_y = 0; \quad 1277.78 - 2300 + B_y = 0$$

$$B_y = 1022.22 \text{ lb}$$

Assembly :

$$\curvearrowleft \Sigma M_C = 0; \quad -N_D(10) + 2300(9) = 0$$

$$N_D = 2070 \text{ lb}$$

$$+\uparrow \Sigma F_y = 0; \quad C_y + 2070 - 2300 = 0$$

$$C_y = 230 \text{ lb}$$

$$I = \frac{1}{12}(1.75)(3)^3 - \frac{1}{12}(1.5)(1.75)^3 = 3.2676 \text{ in}^4$$

$$\sigma_{\max} = \frac{Mc}{I} = \frac{3833.4(1.5)}{3.2676} = 21.1 \text{ ksi} \quad \text{Ans}$$

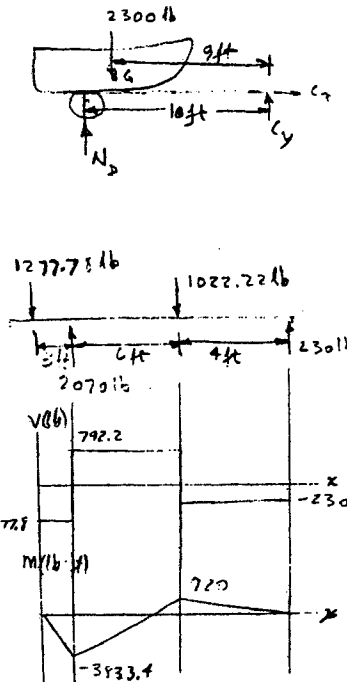

From *Mechanics of Materials*, Sixth Edition by R. C. Hibbeler, ISBN 0-13-191345-X.

© 2005 R. C. Hibbeler. Published by Pearson Prentice Hall,

Pearson Education, Inc., Upper Saddle River, NJ. All rights reserved.

This material is protected under all copyright laws as they currently exist. No portion of this material may be reproduced, in any form or by any means, without permission in writing from the publisher.

*6-96 A wooden beam has a square cross section as shown. Determine which orientation of the beam provides the greatest strength at resisting the moment M . What is the difference in the resulting maximum stress in both cases?

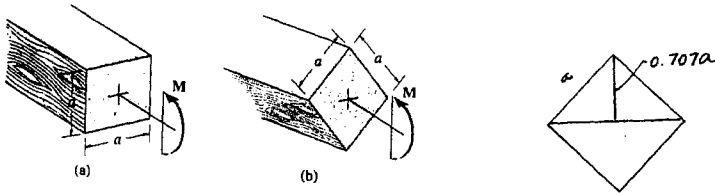

Case (a) :

$$\sigma_{\max} = \frac{Mc}{I} = \frac{M(a/2)}{\frac{1}{12}(a)^4} = \frac{6M}{a^3}$$

Case (b) :

$$I = 2 \left[\frac{1}{36} \left(\frac{2}{\sqrt{2}} a \right) \left(\frac{1}{\sqrt{2}} a \right)^3 + \frac{1}{2} \left(\frac{2}{\sqrt{2}} a \right) \left(\frac{1}{\sqrt{2}} a \right) \left[\left(\frac{1}{\sqrt{2}} a \right) \left(\frac{1}{3} \right) \right]^2 \right] = 0.08333 a^4$$

$$\sigma_{\max} = \frac{Mc}{I} = \frac{M \left(\frac{1}{\sqrt{2}} a \right)}{0.08333 a^4} = \frac{8.4853 M}{a^3}$$

Case (a) provides higher strength since the resulting maximum stress is less for a given M and a .

Case (a) **Ans**

$$\Delta \sigma_{\max} = \frac{8.4853 M}{a^3} - \frac{6M}{a^3} = 2.49 \left(\frac{M}{a^3} \right) \quad \mathbf{Ans}$$

From *Mechanics of Materials*, Sixth Edition by R. C. Hibbeler, ISBN 0-13-191345-X.

© 2005 R. C. Hibbeler. Published by Pearson Prentice Hall,

Pearson Education, Inc., Upper Saddle River, NJ. All rights reserved.

This material is protected under all copyright laws as they currently exist. No portion of this material may be reproduced, in any form or by any means, without permission in writing from the publisher.

6-97. The cantilevered beam has a thickness of 4 in. and a variable depth that can be described by the function $y = 2[(x + 2)/4]^{0.2}$, where x is in inches. Determine the maximum bending stress in the beam at its center.

At the same mid point :

$$y = 2\left(\frac{25 + 2}{4}\right)^{0.2} = 2.93 \text{ in.}$$

$$\left(\sum M = 0; \quad 500(25) - M = 0\right)$$

$$M = 500(25) = 12,500 \text{ lb} \cdot \text{in.}$$

$$\sigma_{\max} = \frac{Mc}{I} = \frac{12500\left(\frac{2.93}{2}\right)}{\frac{1}{12}(4)(2.93)^3} = 2.18 \text{ ksi} \quad \text{Ans}$$

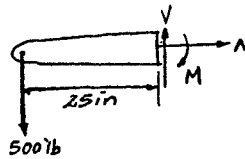
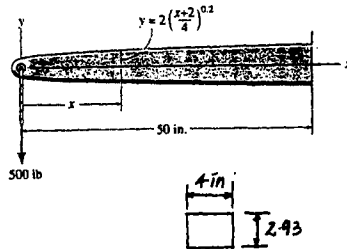

From *Mechanics of Materials*, Sixth Edition by R. C. Hibbeler, ISBN 0-13-191345-X.
 © 2005 R. C. Hibbeler. Published by Pearson Prentice Hall,
 Pearson Education, Inc., Upper Saddle River, NJ. All rights reserved.
 This material is protected under all copyright laws as they currently exist. No portion of this material may be reproduced, in any form or by any means, without permission in writing from the publisher.

6-98 A timber beam has a cross section which is originally square. If it is oriented as shown, determine the height h' so that it can resist the maximum moment possible. By what factor is this moment greater than that of the beam without its top or bottom flattened?

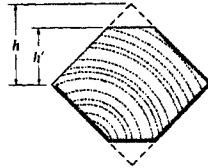

$$\frac{x}{h-h'} = \frac{2h}{h}; \quad x = 2(h-h')$$

$$y = h' + \frac{h-h'}{3} = \frac{2h'+h}{3}$$

$$I = 2\left\{\frac{1}{12}(2h)(h^3) - \left[\frac{1}{36}(2)(h-h')(h-h')^3 + \frac{1}{2}(2)(h-h')(h-h')\left(\frac{2h'+h}{3}\right)^2\right]\right\}$$

$$= \frac{1}{3}h^4 - \frac{1}{9}(h-h')^4 - \frac{2}{9}(h-h')^2(2h'+h)^2$$

$$= \frac{1}{3}h^4 - \frac{1}{9}(h-h')^2[3h^2 + 9h'^2 + 6hh']$$

$$= \frac{1}{3}h^4 - \frac{1}{9}(3h^4 + 9h'^4 - 12hh'^3)$$

$$= \frac{4}{3}hh'^3 - h'^4$$

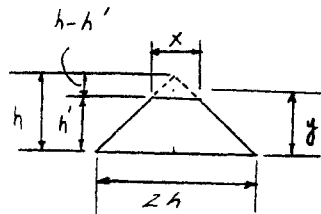

$$\sigma_{\max} = \frac{Mc}{I}$$

$$M = \frac{I}{c} \sigma_{\max} \quad (1)$$

$$= \frac{\frac{4}{3}hh'^3 - h'^4}{h'} \sigma_{\max} = \left(\frac{4}{3}hh'^2 - h'^3\right) \sigma_{\max}$$

$$\frac{dM}{dh'} = \left(\frac{8}{3}hh' - 3h'^2\right) \sigma_{\max}$$

In order to have maximum moment,

$$\frac{dM}{dh'} = 0 = \frac{8}{3}hh' - 3h'^2$$

$$h' = \frac{8}{9}h \quad \text{Ans}$$

For the square beam,

$$I = \bar{I} + Ad^2$$

$$I = 2\left[\frac{1}{36}(2h)(h)^3 + \frac{1}{12}(2h)(h)\left(\frac{h}{3}\right)^2\right] = \frac{h^4}{3}$$

From Eq. (1) σ_{\max}

$$M = \frac{h^4}{3} \sigma_{\max} = \frac{h^3}{3} \sigma_{\max} = 0.3333h^3 \sigma_{\max}$$

For the flattened beam :

$$I = \frac{4}{3}h\left(\frac{8}{9}h\right)^3 - \left(\frac{8}{9}h\right)^4 = 0.312147 h^4$$

From Eq. (1)

$$M' = \frac{0.312147 h^4}{\frac{8}{9}h} \sigma_{\max} = 0.35117 h^3 \sigma_{\max}$$

$$\text{Factor} = \frac{M'}{M} = \frac{0.35117 h^3 \sigma_{\max}}{0.3333h^3 \sigma_{\max}} = 1.05 \quad \text{Ans}$$

From *Mechanics of Materials*, Sixth Edition by R. C. Hibbeler, ISBN 0-13-191345-X.

© 2005 R. C. Hibbeler. Published by Pearson Prentice Hall,

Pearson Education, Inc., Upper Saddle River, NJ. All rights reserved.

This material is protected under all copyright laws as they currently exist. No portion of this material may be reproduced, in any form or by any means, without permission in writing from the publisher.

6-99 A beam is to be molded from polyethylene plastic and have the cross section shown. Determine its largest required height so that it supports the greatest moment M . What is this moment? The allowable tensile and compressive stress for the material is $(\sigma_{\text{allow}})_t = 10 \text{ ksi}$ and $(\sigma_{\text{allow}})_c = 30 \text{ ksi}$, respectively.

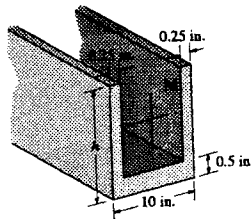

Require,

$$\sigma_c = \frac{Mh_2}{I}, \quad \sigma_t = \frac{Mh_1}{I}$$

Since $\sigma_c = 3 \sigma_t$

$$\frac{Mh_2}{I} = \frac{3Mh_1}{I}$$

$$h_2 = 3h_1$$

$$h_1 + h_2 = h$$

$$h_1 + 3h_1 = h$$

$$h_1 = 0.25h$$

$$h_2 = 0.75h$$

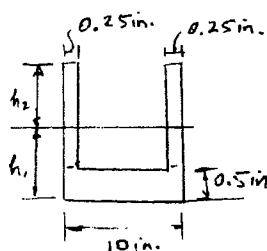

Also,

$$\Sigma \bar{y}A = 0; \quad 2[(0.75h)(0.25)(0.375h)] - 2[(0.25h - 0.5)(0.25)(0.25h - 0.5)/2] - (0.5)(10)(0.25h - 0.25) = 0$$

$$0.140625 h^2 - 0.015625 h^2 + 0.0625 h - 0.0625 - 1.25 h + 1.25 = 0$$

$$0.125 h^2 - 1.1875 h + 1.1875 = 0$$

Roots are

$$h = 8.364 \text{ in. and } 1.136 \text{ in.}$$

Choosing the largest root,

$$h = 8.364 \text{ in.} = 8.36 \text{ in.} \quad \text{Ans}$$

$$h_1 = 0.25(8.364) = 2.091 \text{ in.}$$

$$h_2 = 0.75(8.364) = 6.273 \text{ in.}$$

$$I = \left[\frac{1}{12}(10)(8.364)^3 + (10)(8.364) \left(\frac{8.364}{2} - 6.2731 \right)^2 \right] - \left[\frac{1}{12}(9.5)(8.364 - 0.5)^3 + 9.5(8.364 - 0.5) \left(\frac{8.364 - 0.5}{2} - 6.273 \right)^2 \right] = 58.863 \text{ in}^4$$

$$\sigma_{\text{max}} = \frac{Mc}{I}; \quad 10 = \frac{M(2.091)}{58.863}; \quad M = 281.5 \text{ kip} \cdot \text{in.} = 23.5 \text{ kip} \cdot \text{ft} \quad \text{Ans}$$

From *Mechanics of Materials*, Sixth Edition by R. C. Hibbeler, ISBN 0-13-191345-X.

© 2005 R. C. Hibbeler. Published by Pearson Prentice Hall,

Pearson Education, Inc., Upper Saddle River, NJ. All rights reserved.

This material is protected under all copyright laws as they currently exist. No portion of this material may be reproduced, in any form or by any means, without permission in writing from the publisher.

*6-100 A beam is made of a material that has a modulus of elasticity in compression different from that given for tension. Determine the location c of the neutral axis, and derive an expression for the maximum tensile stress in the beam having the dimensions shown if it is subjected to the bending moment M .

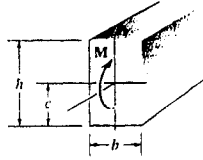

$$(\epsilon_{\max})_c = \frac{(\epsilon_{\max})_t (h - c)}{c}$$

$$(\sigma_{\max})_c = E_c (\epsilon_{\max})_c = \frac{E_c (\epsilon_{\max})_t (h - c)}{c}$$

Location of neutral axis :

$$+\sum F = 0; \quad -\frac{1}{2}(h - c)(\sigma_{\max})_c (b) + \frac{1}{2}(c)(\sigma_{\max})_t (b) = 0$$

$$(h - c)(\sigma_{\max})_c = c(\sigma_{\max})_t \quad [1]$$

$$(h - c)E_c (\epsilon_{\max})_t \frac{(h - c)}{c} = cE_t (\epsilon_{\max})_t; \quad E_c (h - c)^2 = E_t c^2$$

Taking positive root :

$$\frac{c}{h - c} = \sqrt{\frac{E_c}{E_t}}$$

$$c = \frac{h\sqrt{\frac{E_c}{E_t}}}{1 + \sqrt{\frac{E_c}{E_t}}} = \frac{h\sqrt{E_c}}{\sqrt{E_t} + \sqrt{E_c}} \quad [2] \quad \text{Ans}$$

$$\sum M_{NA} = 0;$$

$$M = \left\{ \frac{1}{2}(h - c)(\sigma_{\max})_c (b) \right\} \left(\frac{2}{3} \right) (h - c) + \left\{ \frac{1}{2}(c)(\sigma_{\max})_t (b) \right\} \left(\frac{2}{3} \right) (c)$$

$$M = \frac{1}{3}(h - c)^2 (b)(\sigma_{\max})_c + \frac{1}{3}c^2 b (\sigma_{\max})_t$$

$$\text{From Eq. [1], } (\sigma_{\max})_c = \frac{c}{h - c} (\sigma_{\max})_t$$

$$M = \frac{1}{3}(h - c)^2 (b) \left(\frac{c}{h - c} \right) (\sigma_{\max})_t + \frac{1}{3}c^2 b (\sigma_{\max})_t$$

$$M = \frac{1}{3}bc(\sigma_{\max})_t (h - c + c); \quad (\sigma_{\max})_t = \frac{3M}{bhc}$$

From Eq. [2]

$$(\sigma_{\max})_t = \frac{3M}{bh^2} \left(\frac{\sqrt{E_t} + \sqrt{E_c}}{\sqrt{E_c}} \right) \quad \text{Ans}$$

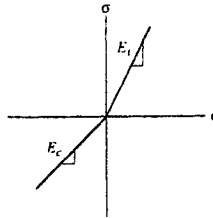

From *Mechanics of Materials*, Sixth Edition by R. C. Hibbeler, ISBN 0-13-191345-X.

© 2005 R. C. Hibbeler. Published by Pearson Prentice Hall,

Pearson Education, Inc., Upper Saddle River, NJ. All rights reserved.

This material is protected under all copyright laws as they currently exist. No portion of this material may be reproduced, in any form or by any means, without permission in writing from the publisher.

6-101 The beam has a rectangular cross section and is subjected to a bending moment M . If the material from which it is made has a different modulus of elasticity for tension and compression as shown, determine the location c of the neutral axis and the maximum compressive stress in the beam.

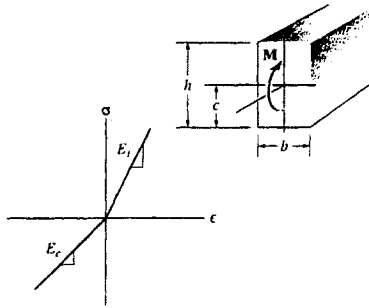

See the solution to Prob. 6 - 100

$$c = \frac{h\sqrt{E_c}}{\sqrt{E_t} + \sqrt{E_c}} \quad \text{Ans}$$

$$\text{Since } (\sigma_{\max})_c = \frac{c}{h - c} (\sigma_{\max})_t = \frac{h\sqrt{E_c}}{(\sqrt{E_t} + \sqrt{E_c})[h - (\frac{h\sqrt{E_c}}{\sqrt{E_t} + \sqrt{E_c}})]} (\sigma_{\max})_t$$

$$(\sigma_{\max})_c = \frac{\sqrt{E_c}}{\sqrt{E_t}} (\sigma_{\max})_t$$

$$(\sigma_{\max})_c = \frac{\sqrt{E_c}}{\sqrt{E_t}} \left(\frac{3M}{bh^2} \right) \left(\frac{\sqrt{E_t} + \sqrt{E_c}}{\sqrt{E_c}} \right)$$

$$(\sigma_{\max})_c = \frac{3M}{bh^2} \left(\frac{\sqrt{E_t} + \sqrt{E_c}}{\sqrt{E_t}} \right) \quad \text{Ans}$$

From *Mechanics of Materials*, Sixth Edition by R. C. Hibbeler, ISBN 0-13-191345-X.

© 2005 R. C. Hibbeler. Published by Pearson Prentice Hall,

Pearson Education, Inc., Upper Saddle River, NJ. All rights reserved.

This material is protected under all copyright laws as they currently exist. No portion of this material may be reproduced, in any form or by any means, without permission in writing from the publisher.

6-102. The member has a square cross section and is subjected to a resultant internal bending moment of $M = 850 \text{ N}\cdot\text{m}$ as shown. Determine the stress at each corner and sketch the stress distribution produced by M . Set $\theta = 45^\circ$.

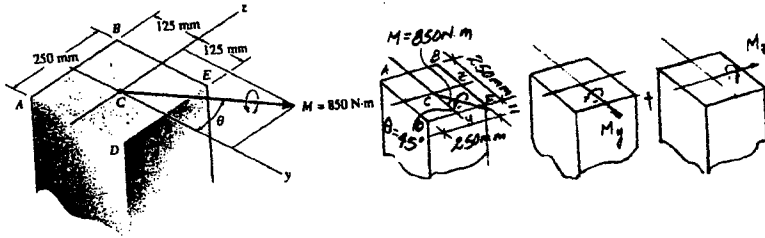

$$M_y = 850 \cos 45^\circ = 601.04 \text{ N}\cdot\text{m}$$

$$M_z = 850 \sin 45^\circ = 601.04 \text{ N}\cdot\text{m}$$

$$I_z = I_y = \frac{1}{12}(0.25)(0.25)^3 = 0.3255208(10^{-3}) \text{ m}^4$$

$$\sigma = -\frac{M_z y}{I_z} + \frac{M_y z}{I_y}$$

$$\sigma_A = -\frac{601.04(-0.125)}{0.3255208(10^{-3})} + \frac{601.04(-0.125)}{0.3255208(10^{-3})} = 0 \quad \text{Ans}$$

$$\sigma_B = -\frac{601.04(-0.125)}{0.3255208(10^{-3})} + \frac{601.04(0.125)}{0.3255208(10^{-3})} = 462 \text{ kPa} \quad \text{Ans}$$

$$\sigma_D = -\frac{601.04(0.125)}{0.3255208(10^{-3})} + \frac{601.04(-0.125)}{0.3255208(10^{-3})} = -462 \text{ kPa} \quad \text{Ans}$$

$$\sigma_E = -\frac{601.04(0.125)}{0.3255208(10^{-3})} + \frac{601.04(0.125)}{0.3255208(10^{-3})} = 0 \quad \text{Ans}$$

The negative sign indicates compressive stress.



From *Mechanics of Materials*, Sixth Edition by R. C. Hibbeler, ISBN 0-13-191345-X.

© 2005 R. C. Hibbeler. Published by Pearson Prentice Hall,

Pearson Education, Inc., Upper Saddle River, NJ. All rights reserved.

This material is protected under all copyright laws as they currently exist. No portion of this material may be reproduced, in any form or by any means, without permission in writing from the publisher.

6-103. The member has a square cross section and is subjected to a resultant internal bending moment of $M = 850 \text{ N}\cdot\text{m}$ as shown. Determine the stress at each corner and sketch the stress distribution produced by M . Set $\theta = 30^\circ$.

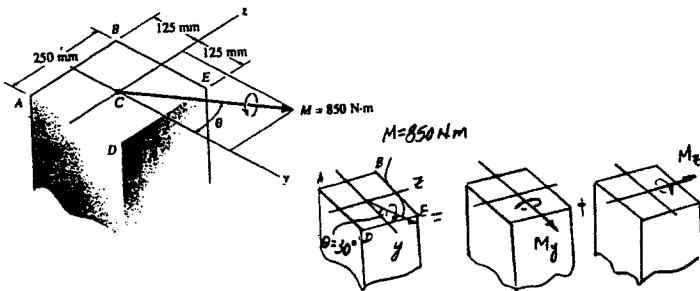

$$M_y = 850 \cos 30^\circ = 736.12 \text{ N}\cdot\text{m}$$

$$M_z = 850 \sin 30^\circ = 425 \text{ N}\cdot\text{m}$$

$$I_z = I_y = \frac{1}{12} (0.25)(0.25)^3 = 0.3255208(10^{-3}) \text{ m}^4$$

$$\sigma = -\frac{M_z y}{I_z} + \frac{M_y z}{I_y}$$

$$\sigma_A = -\frac{425(-0.125)}{0.3255208(10^{-3})} + \frac{736.12(-0.125)}{0.3255208(10^{-3})} = -119 \text{ kPa} \quad \text{Ans}$$

$$\sigma_B = -\frac{425(-0.125)}{0.3255208(10^{-3})} + \frac{736.12(0.125)}{0.3255208(10^{-3})} = 446 \text{ kPa} \quad \text{Ans}$$

$$\sigma_D = -\frac{425(0.125)}{0.3255208(10^{-3})} + \frac{736.12(-0.125)}{0.3255208(10^{-3})} = -446 \text{ kPa} \quad \text{Ans}$$

$$\sigma_E = -\frac{425(0.125)}{0.3255208(10^{-3})} + \frac{736.12(0.125)}{0.3255208(10^{-3})} = 119 \text{ kPa} \quad \text{Ans}$$

The negative signs indicate compressive stress.

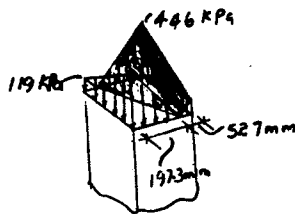

From *Mechanics of Materials*, Sixth Edition by R. C. Hibbeler, ISBN 0-13-191345-X.

© 2005 R. C. Hibbeler. Published by Pearson Prentice Hall,

Pearson Education, Inc., Upper Saddle River, NJ. All rights reserved.

This material is protected under all copyright laws as they currently exist. No portion of this material may be reproduced, in any form or by any means, without permission in writing from the publisher.

*6-104 The beam has a rectangular cross section. If it is subjected to a moment of $M = 3500 \text{ N} \cdot \text{m}$ directed as shown, determine the maximum bending stress in the beam and the orientation of the neutral axis.

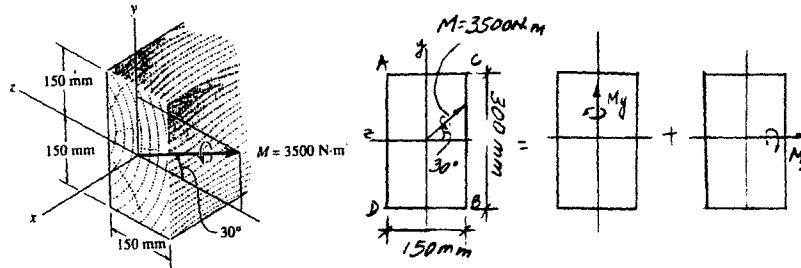

$$M_y = 3500 \sin 30^\circ = 1750 \text{ N} \cdot \text{m}$$

$$M_z = 3500 \cos 30^\circ = -3031.09 \text{ N} \cdot \text{m}$$

$$I_y = \frac{1}{12}(0.3)(0.15^3) = 84.375(10^{-6}) \text{ m}^4$$

$$I_z = \frac{1}{12}(0.15)(0.3^3) = 0.3375(10^{-3}) \text{ m}^4$$

$$\sigma = -\frac{M_z y}{I_z} + \frac{M_y z}{I_y}$$

$$\sigma_A = -\frac{-3031.09(0.15)}{0.3375(10^{-3})} + \frac{1750(0.075)}{84.375(10^{-6})} = 2.90 \text{ MPa (max) Ans}$$

$$\sigma_B = -\frac{-3031.09(-0.15)}{0.3375(10^{-3})} + \frac{1750(-0.075)}{84.375(10^{-6})} = -2.90 \text{ MPa (max) Ans}$$

$$\sigma_C = -\frac{-3031.09(0.15)}{0.3375(10^{-3})} + \frac{1750(-0.075)}{84.375(10^{-6})} = -0.2084 \text{ MPa}$$

$$\sigma_D = 0.2084 \text{ MPa}$$

$$\frac{z}{0.2084} = \frac{150 - z}{2.90}$$

$$z = 10.0 \text{ mm}$$

$$\tan \alpha = \frac{I_z}{I_y} \tan \theta = \frac{3.375(10^{-4})}{8.4375(10^{-5})} \tan(-30^\circ)$$

$$\alpha = -66.6^\circ \text{ Ans}$$

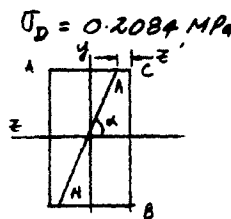

From *Mechanics of Materials*, Sixth Edition by R. C. Hibbeler, ISBN 0-13-191345-X.

© 2005 R. C. Hibbeler. Published by Pearson Prentice Hall,

Pearson Education, Inc., Upper Saddle River, NJ. All rights reserved.

This material is protected under all copyright laws as they currently exist. No portion of this material may be reproduced, in any form or by any means, without permission in writing from the publisher.

6-105 The T-beam is subjected to a moment of $M = 150$ kip · in. directed as shown. Determine the maximum bending stress in the beam and the orientation of the neutral axis. The location \bar{y} of the centroid, C , must be determined.

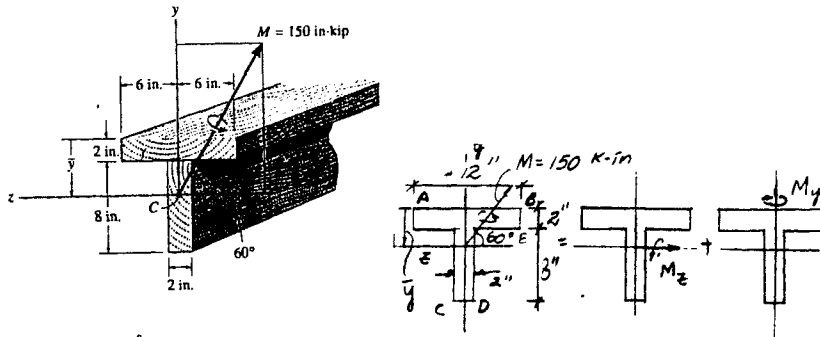

$$M_y = 150 \sin 60^\circ = 129.9 \text{ kip} \cdot \text{in.}$$

$$M_z = -150 \cos 60^\circ = -75 \text{ kip} \cdot \text{in.}$$

$$\bar{y} = \frac{(1)(12)(2) + (6)(8)(2)}{12(2) + 8(2)} = 3 \text{ in.}$$

$$I_y = \frac{1}{12}(2)(12^3) + \frac{1}{12}(8)(2^3) = 293.33 \text{ in}^4$$

$$I_z = \frac{1}{12}(12)(2^3) + 12(2)(2^2) + \frac{1}{12}(2)(8^3) + 2(8)(3^2) = 333.33 \text{ in}^4$$

$$\sigma = -\frac{M_z y}{I_z} + \frac{M_y z}{I_y}$$

$$\sigma_A = \frac{-(-75)(3)}{333.33} + \frac{129.9(6)}{293.33} = 3.33 \text{ ksi} \quad \text{Ans}$$

$$\sigma_D = \frac{-(-75)(-7)}{333.33} + \frac{129.9(-1)}{293.33} = -2.02 \text{ ksi}$$

$$\sigma_B = \frac{-(-75)(3)}{333.33} + \frac{129.9(-6)}{293.33} = -1.982 \text{ ksi}$$

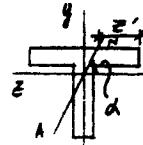

$$\frac{z'}{1.982} = \frac{12 - z'}{3.333}$$

$$z' = 4.47 \text{ in.}$$

$$\tan \alpha = \frac{I_z}{I_y} \tan \theta = \frac{333.33}{293.33} \tan (-60^\circ)$$

$$\alpha = -63.1^\circ \quad \text{Ans}$$

From *Mechanics of Materials*, Sixth Edition by R. C. Hibbeler, ISBN 0-13-191345-X.

© 2005 R. C. Hibbeler. Published by Pearson Prentice Hall,

Pearson Education, Inc., Upper Saddle River, NJ. All rights reserved.

This material is protected under all copyright laws as they currently exist. No portion of this material may be reproduced, in any form or by any means, without permission in writing from the publisher.

6-106. If the internal moment acting on the cross section of the strut has a magnitude of $M = 800 \text{ N} \cdot \text{m}$ and is directed as shown, determine the bending stress at points A and B . The location \bar{z} of the centroid C of the strut's cross-sectional area must be determined. Also, specify the orientation of the neutral axis.

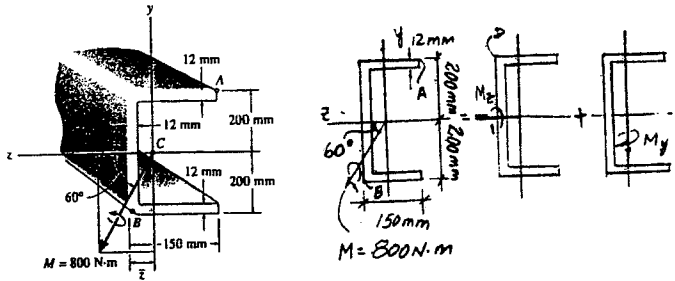

$$M_z = 800 \cos 60^\circ = 400 \text{ N} \cdot \text{m}$$

$$M_y = -800 \sin 60^\circ = -692.82 \text{ N} \cdot \text{m}$$

$$\bar{z} = \frac{400(12)(6) + 2(138)(12)(81)}{400(12) + 2(138)(12)} = 36.6 \text{ mm}$$

$$I_z = \frac{1}{12}(0.15)(0.4^3) - \frac{1}{12}(0.138)(0.376^3) = 0.18869(10^{-3}) \text{ m}^4$$

$$I_y = \frac{1}{12}(0.4)(0.012^3) + (0.4)(0.012)(0.03062^2)$$

$$+ 2\left[\frac{1}{12}(0.012)(0.138^3) + (0.138)(0.012)(0.04438^2)\right] = 16.3374(10^{-6}) \text{ m}^4$$

$$\sigma = -\frac{M_z y}{I_z} + \frac{M_y z}{I_y}$$

$$\sigma_A = \frac{-(400)(0.2)}{0.18869(10^{-3})} + \frac{(-692.82)(-0.11338)}{16.3374(10^{-6})} = 4.38 \text{ MPa} \quad \text{Ans}$$

$$\sigma_B = \frac{-(400)(-0.2)}{0.18869(10^{-3})} + \frac{(-692.82)(0.036621)}{16.3374(10^{-6})} = -1.13 \text{ MPa} \quad \text{Ans}$$

$$\tan \alpha = \frac{I_z}{I_y} \tan \theta$$

$$\tan \alpha = \frac{1.8869(10^{-4})}{1.63374(10^{-5})} \tan(-60)$$

$$\alpha = -87.1^\circ \quad \text{Ans}$$

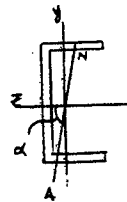

From *Mechanics of Materials*, Sixth Edition by R. C. Hibbeler, ISBN 0-13-191345-X.

© 2005 R. C. Hibbeler. Published by Pearson Prentice Hall,

Pearson Education, Inc., Upper Saddle River, NJ. All rights reserved.

This material is protected under all copyright laws as they currently exist. No portion of this material may be reproduced, in any form or by any means, without permission in writing from the publisher.

6-107. The resultant moment acting on the cross section of the aluminum strut has a magnitude of $M = 800 \text{ N} \cdot \text{m}$ and is directed as shown. Determine the maximum bending stress in the strut. The location \bar{y} of the centroid C of the strut's cross-sectional area must be determined. Also, specify the orientation of the neutral axis.

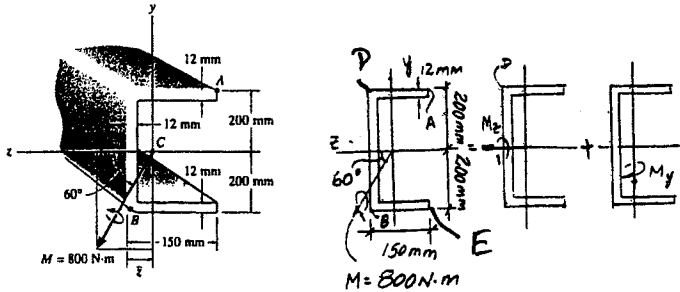

$$M_z = 800 \cos 60^\circ = 400 \text{ N} \cdot \text{m}$$

$$M_y = -800 \sin 60^\circ = -692.82 \text{ N} \cdot \text{m}$$

$$\bar{z} = \frac{400(12)(6) + 2(138)(12)(81)}{400(12) + 2(138)(12)} = 36.6 \text{ mm} \quad \text{Ans}$$

$$I_z = \frac{1}{12}(0.15)(0.4^3) - \frac{1}{12}(0.138)(0.376^3) = 0.18869(10^{-3}) \text{ m}^4$$

$$I_y = \frac{1}{12}(0.4)(0.012^3) + (0.4)(0.012)(0.03062^2)$$

$$+ 2\left[\frac{1}{12}(0.012)(0.138^3) + (0.138)(0.012)(0.04438^2)\right] = 16.3374(10^{-6}) \text{ m}^4$$

$$\sigma = -\frac{M_z y}{I_z} + \frac{M_y z}{I_y}$$

$$\sigma_A = \frac{-(400)(0.2)}{0.18869(10^{-3})} + \frac{(-692.82)(-0.11338)}{16.3374(10^{-6})} = 4.38 \text{ MPa}$$

$$\sigma_B = \frac{-(400)(-0.2)}{0.18869(10^{-3})} + \frac{(-692.82)(0.036621)}{16.3374(10^{-6})} = -1.13 \text{ MPa}$$

$$\sigma_D = \frac{-(400)(0.2)}{0.18869(10^{-3})} + \frac{(-692.82)(0.036621)}{16.3374(10^{-6})} = -1.977 \text{ MPa}$$

$$\sigma_E = -\frac{(400)(-0.2)}{0.18869(10^{-3})} + \frac{(-692.82)(-0.11338)}{16.3374(10^{-6})} = 5.23 \text{ MPa} \quad \text{Ans}$$

From *Mechanics of Materials*, Sixth Edition by R. C. Hibbeler, ISBN 0-13-191345-X.

© 2005 R. C. Hibbeler. Published by Pearson Prentice Hall,

Pearson Education, Inc., Upper Saddle River, NJ. All rights reserved.

This material is protected under all copyright laws as they currently exist. No portion of this material may be reproduced, in any form or by any means, without permission in writing from the publisher.

***6-108.** The cantilevered wide-flange steel beam is subjected to the concentrated force P at its end. Determine the largest magnitude of this force so that the bending stress developed at A does not exceed $\sigma_{\text{allow}} = 180 \text{ MPa}$.

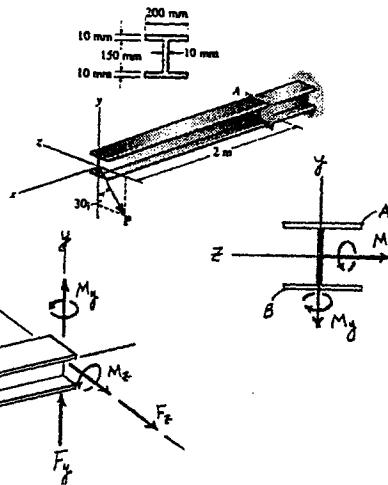

Internal Moment Components : Using method of section

$$\Sigma M_z = 0; \quad M_z + P \cos 30^\circ(2) = 0 \quad M_z = -1.732P$$

$$\Sigma M_y = 0; \quad M_y + P \sin 30^\circ(2) = 0; \quad M_y = -1.00P$$

Section Properties :

$$I_z = \frac{1}{12}(0.2)(0.17^3) - \frac{1}{12}(0.19)(0.15^3) = 28.44583(10^{-6}) \text{ m}^4$$

$$I_y = 2 \left[\frac{1}{12}(0.01)(0.2^3) \right] + \frac{1}{12}(0.15)(0.01^3) = 13.34583(10^{-6}) \text{ m}^4$$

Allowable Bending Stress : By inspection, maximum bending stress occurs at points A and B . Applying the flexure formula for biaxial bending at point A ,

$$\sigma_A = \sigma_{\text{allow}} = -\frac{M_z y}{I_z} + \frac{M_y z}{I_y}$$

$$180(10^6) = \frac{(-1.732P)(0.085)}{28.44583(10^{-6})} + \frac{-1.00P(-0.1)}{13.34583(10^{-6})}$$

$$P = 14208 \text{ N} = 14.2 \text{ kN} \quad \text{Ans}$$

From *Mechanics of Materials*, Sixth Edition by R. C. Hibbeler, ISBN 0-13-191345-X.

© 2005 R. C. Hibbeler. Published by Pearson Prentice Hall,

Pearson Education, Inc., Upper Saddle River, NJ. All rights reserved.

This material is protected under all copyright laws as they currently exist. No portion of this material may be reproduced, in any form or by any means, without permission in writing from the publisher.

6-109. The cantilevered wide-flange steel beam is subjected to the concentrated force of $P = 600 \text{ N}$ at its end. Determine the maximum bending stress developed in the beam at section A.

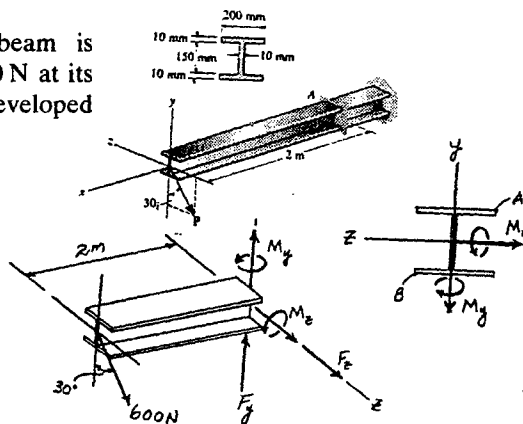

Internal Moment Components : Using method of sections

$$\Sigma M_z = 0; \quad M_z + 600 \cos 30^\circ(2) = 0 \quad M_z = -1039.23 \text{ N} \cdot \text{m}$$

$$\Sigma M_y = 0; \quad M_y + 600 \sin 30^\circ(2) = 0; \quad M_y = -600.0 \text{ N} \cdot \text{m}$$

Section Properties :

$$I_z = \frac{1}{12}(0.2)(0.17^3) - \frac{1}{12}(0.19)(0.15^3) = 28.44583(10^{-6}) \text{ m}^4$$

$$I_y = 2 \left[\frac{1}{12}(0.01)(0.2^3) \right] + \frac{1}{12}(0.15)(0.01^3) = 13.34583(10^{-6}) \text{ m}^4$$

Maximum Bending Stress : By inspection, maximum bending stress occurs at A and B. Applying the flexure formula for biaxial bending at points A and B

$$\sigma = -\frac{M_z y}{I_z} + \frac{M_y z}{I_y}$$

$$\sigma_A = \frac{-1039.32(0.085)}{28.44583(10^{-6})} + \frac{-600.0(-0.1)}{13.34583(10^{-6})} = 7.60 \text{ MPa (T) (Max)}$$

Ans

$$\sigma_B = \frac{-1039.32(-0.085)}{28.44583(10^{-6})} + \frac{-600.0(0.1)}{13.34583(10^{-6})} = -7.60 \text{ MPa} = 7.60 \text{ MPa (C) (Max)}$$

Ans

From *Mechanics of Materials*, Sixth Edition by R. C. Hibbeler, ISBN 0-13-191345-X.

© 2005 R. C. Hibbeler. Published by Pearson Prentice Hall,

Pearson Education, Inc., Upper Saddle River, NJ. All rights reserved.

This material is protected under all copyright laws as they currently exist. No portion of this material may be reproduced, in any form or by any means, without permission in writing from the publisher.

6-110 The board is used as a simply supported floor joist. If a bending moment of $M = 800 \text{ lb} \cdot \text{ft}$ is applied 3° from the z axis, determine the bending stress developed in the board at the corner A . Compare this stress with that developed by the same moment applied along the z axis ($\theta = 0^\circ$). What is the angle α for the neutral axis when $\theta = 3^\circ$?
Comment: Normally, floor boards would be nailed to the top of the beam so that $\theta \approx 0^\circ$ and the high stress due to misalignment would not occur.

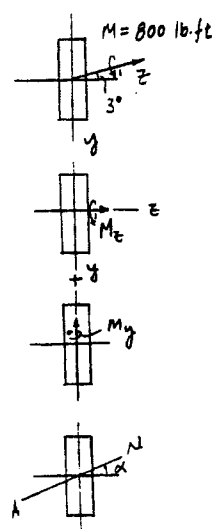
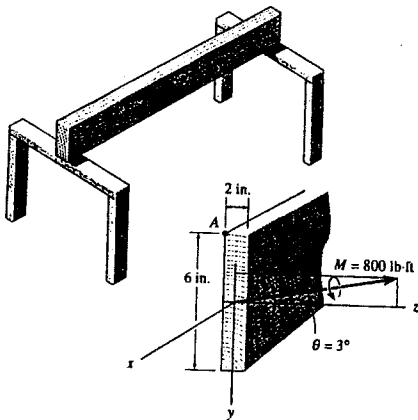

$$M_z = 800 \cos 3^\circ = 798.904 \text{ lb} \cdot \text{ft}$$

$$M_y = -800 \sin 3^\circ = -41.869 \text{ lb} \cdot \text{ft}$$

$$I_z = \frac{1}{12}(2)(6^3) = 36 \text{ in}^4; \quad I_y = \frac{1}{12}(6)(2^3) = 4 \text{ in}^4$$

$$\sigma = -\frac{M_z y}{I_z} + \frac{M_y z}{I_y}$$

$$\sigma_A = -\frac{798.904(12)(-3)}{36} + \frac{-41.869(12)(-1)}{4} = 924 \text{ psi}$$

Ans

$$\tan \alpha = \frac{I_z}{I_y} \tan \theta; \quad \tan \alpha = \frac{36}{4} \tan (-3^\circ)$$

$$\alpha = -25.3^\circ$$

Ans

When $\theta = 0^\circ$

$$\sigma_A = \frac{Mc}{I} = \frac{800(12)(3)}{36} = 800 \text{ psi}$$

Ans

From *Mechanics of Materials*, Sixth Edition by R. C. Hibbeler, ISBN 0-13-191345-X.
 © 2005 R. C. Hibbeler. Published by Pearson Prentice Hall,
 Pearson Education, Inc., Upper Saddle River, NJ. All rights reserved.
 This material is protected under all copyright laws as they currently exist. No portion of this material may be reproduced, in any form or by any means, without permission in writing from the publisher.

6-111 Consider the general case of a prismatic beam subjected to bending-moment components M_y and M_z , as shown, when the x, y, z axes pass through the centroid of the cross section. If the material is linear-elastic, the normal stress in the beam is a linear function of position such that $\sigma = a + by + cz$. Using the equilibrium conditions $0 = \int_A \sigma \, dA$, $M_y = \int_A z \sigma \, dA$, $M_z = \int_A -y \sigma \, dA$, determine the constants a, b , and c , and show that the normal stress can be determined from the equation $\sigma = [-(M_z I_y + M_y I_{yz})y + (M_y I_z + M_z I_{yz})z] / (I_y I_z - I_{yz}^2)$, where the moments and products of inertia are defined in Appendix A.

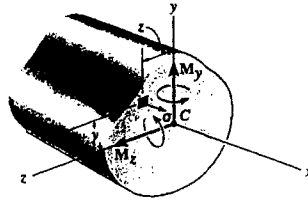

$$\sigma_x = a + by + cz$$

$$0 = \int_A \sigma_x \, dA = \int_A (a + by + cz) \, dA$$

$$= a \int_A \, dA + b \int_A y \, dA + c \int_A z \, dA$$

$$M_y = \int_A z \sigma_x \, dA = \int_A z(a + by + cz) \, dA$$

$$= a \int_A z \, dA + b \int_A yz \, dA + c \int_A z^2 \, dA$$

$$M_z = \int_A -y \sigma_x \, dA = \int_A -y(a + by + cz) \, dA$$

$$= -a \int_A y \, dA - b \int_A y^2 \, dA - c \int_A yz \, dA$$

The integrals are defined in Appendix A. Note that $\int_A y \, dA = \int_A z \, dA = 0$.

Thus, $0 = aA$

$$M_y = bI_{yz} + cI_y; \quad M_z = -bI_z - cI_{yz}$$

Solving for a, b, c :

$$a = 0 \text{ (Since } A \neq 0 \text{)}$$

$$b = -\left(\frac{I_y M_z + M_y I_{yz}}{I_y I_z - I_{yz}^2}\right); \quad c = \frac{I_z M_y + M_z I_{yz}}{I_y I_z - I_{yz}^2}$$

$$\text{Thus, } \sigma_x = -\left(\frac{M_z I_y + M_y I_{yz}}{I_y I_z - I_{yz}^2}\right)y + \left(\frac{M_y I_z + M_z I_{yz}}{I_y I_z - I_{yz}^2}\right)z \quad \text{QED}$$

From *Mechanics of Materials*, Sixth Edition by R. C. Hibbeler, ISBN 0-13-191345-X.

© 2005 R. C. Hibbeler. Published by Pearson Prentice Hall,

Pearson Education, Inc., Upper Saddle River, NJ. All rights reserved.

This material is protected under all copyright laws as they currently exist. No portion of this material may be reproduced, in any form or by any means, without permission in writing from the publisher.

*6-112. The cantilevered beam is made from the Z section having the cross-section shown. If it supports the two loadings, determine the bending stress at the wall in the beam at point A. Use the result of Prob. 6-111.

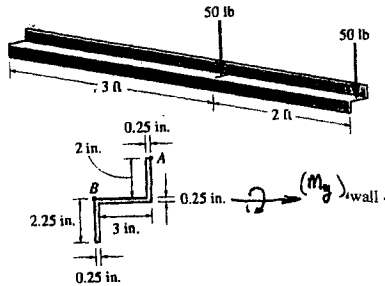

$$(M_y)_{\text{wall}} = 50(3) + 50(5) = 400 \text{ lb} \cdot \text{ft} = 4.80(10^3) \text{ lb} \cdot \text{in.}$$

$$I_y = \frac{1}{12}(3.25)(0.25)^3 + 2\left[\frac{1}{12}(0.25)(2)^3 + (0.25)(2)(1.125)^2\right] = 1.60319 \text{ in}^4$$

$$I_z = \frac{1}{12}(0.25)(3.25)^3 + 2\left[\frac{1}{12}(2)(0.25)^3 + (0.25)(2)(1.5)^2\right] = 2.970378 \text{ in}^4$$

$$I_{yz} = 2[1.5(1.125)(2)(0.25)] = 1.6875 \text{ in}^4$$

Using the equation developed in Prob. 6-111,

$$\sigma = -\left(\frac{M_z I_y + M_y I_{yz}}{I_y I_z - I_{yz}^2}\right)y + \left(\frac{M_y I_z + M_z I_{yz}}{I_y I_z - I_{yz}^2}\right)z$$

$$\sigma_A = \frac{\{-[0 + (4.80)(10^3)(1.6875)](1.625) + [(4.80)(10^3)(2.970378) + 0](2.125)\}}{[1.60319(2.970378) - (1.6875)^2]} = 8.95 \text{ ksi} \quad \text{Ans}$$

From *Mechanics of Materials*, Sixth Edition by R. C. Hibbeler, ISBN 0-13-191345-X.

© 2005 R. C. Hibbeler. Published by Pearson Prentice Hall,

Pearson Education, Inc., Upper Saddle River, NJ. All rights reserved.

This material is protected under all copyright laws as they currently exist. No portion of this material may be reproduced, in any form or by any means, without permission in writing from the publisher.

6-113. The cantilevered beam is made from the Z section having the cross-section shown. If it supports the two loadings, determine the bending stress at the wall in the beam at point B. Use the result of Prob. 6-111.

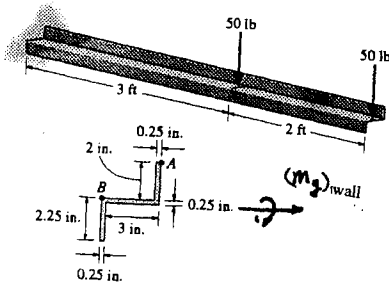

$$(M_y)_{\text{wall}} = 50(3) + 50(5) = 400 \text{ lb} \cdot \text{ft} = 4.80(10^3) \text{ lb} \cdot \text{in.}$$

$$I_y = \frac{1}{12}(3.25)(0.25)^3 + 2\left[\frac{1}{12}(0.25)(2)^3 + (0.25)(2)(1.125)^2\right] = 1.60319 \text{ in}^4$$

$$I_z = \frac{1}{12}(0.25)(3.25)^3 + 2\left[\frac{1}{12}(2)(0.25)^3 + (0.25)(2)(1.5)^2\right] = 2.970378 \text{ in}^4$$

$$I_{yz} = 2[1.5(1.125)(2)(0.25)] = 1.6875 \text{ in}^4$$

Using the equation developed in Prob. 6-111,

$$\sigma = -\left(\frac{M_z I_y + M_y I_{yz}}{I_y I_z - I_{yz}^2}\right)y + \left(\frac{M_y I_z + M_z I_{yz}}{I_y I_z - I_{yz}^2}\right)z$$

$$\sigma_B = \frac{-[0 + (4.80)(10^3)(1.6875)](-1.625) + [(4.80)(10^3)(2.970378) + 0](0.125)}{[(1.60319)(2.970378) - (1.6875)^2]}$$

$$= 7.81 \text{ ksi} \quad \text{Ans}$$

From *Mechanics of Materials*, Sixth Edition by R. C. Hibbeler, ISBN 0-13-191345-X.

© 2005 R. C. Hibbeler. Published by Pearson Prentice Hall,

Pearson Education, Inc., Upper Saddle River, NJ. All rights reserved.

This material is protected under all copyright laws as they currently exist. No portion of this material may be reproduced, in any form or by any means, without permission in writing from the publisher.

6-114. Using the techniques outlined in Appendix A, Example A.5 or A.6, the Z section has principal moments of inertia of $I_y = 0.060(10^{-3}) \text{ m}^4$ and $I_z = 0.471(10^{-3}) \text{ m}^4$, computed about the principal axes of inertia y and z , respectively. If the section is subjected to an internal moment of $M = 250 \text{ N} \cdot \text{m}$ directed horizontally as shown, determine the stress produced at point A . Solve the problem using Eq. 6-17.

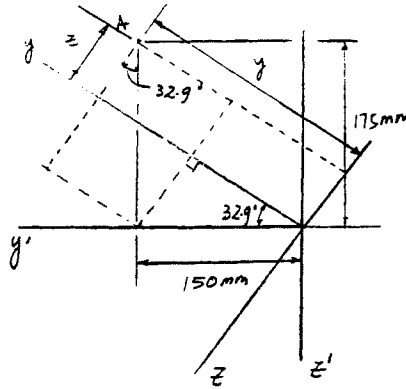
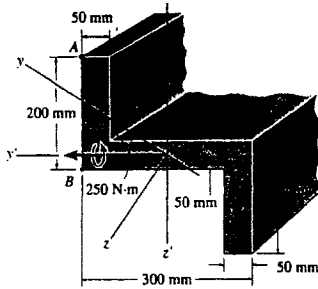

$$M_y = 250 \cos 32.9^\circ = 209.9 \text{ N} \cdot \text{m}$$

$$M_z = 250 \sin 32.9^\circ = 135.8 \text{ N} \cdot \text{m}$$

$$y = 0.15 \cos 32.9^\circ + 0.175 \sin 32.9^\circ = 0.2210 \text{ m}$$

$$z = -(0.175 \cos 32.9^\circ - 0.15 \sin 32.9^\circ) = -0.06546 \text{ m}$$

$$\begin{aligned} \sigma_A &= -\frac{M_z y}{I_z} + \frac{M_y z}{I_y} = \frac{-135.8(0.2210)}{0.471(10^{-3})} + \frac{209.9(-0.06546)}{60.0(10^{-6})} \\ &= -293 \text{ kPa} = 293 \text{ kPa (C)} \end{aligned} \quad \text{Ans}$$

From *Mechanics of Materials*, Sixth Edition by R. C. Hibbeler, ISBN 0-13-191345-X.

© 2005 R. C. Hibbeler. Published by Pearson Prentice Hall,

Pearson Education, Inc., Upper Saddle River, NJ. All rights reserved.

This material is protected under all copyright laws as they currently exist. No portion of this material may be reproduced, in any form or by any means, without permission in writing from the publisher.

* 6-115c. Solve Prob. 6-114 using the equation developed in Prob 6-111.

Internal Moment Components :

$$M_y = 250 \text{ N} \cdot \text{m} \quad M_z = 0$$

Section Properties :

$$I_y = \frac{1}{12}(0.3)(0.05^3) + 2 \left[\frac{1}{12}(0.05)(0.15^3) + 0.05(0.15)(0.1^2) \right]$$

$$= 0.18125(10^{-3}) \text{ m}^4$$

$$I_z = \frac{1}{12}(0.05)(0.3^3) + 2 \left[\frac{1}{12}(0.15)(0.05^3) + 0.15(0.05)(0.125^2) \right]$$

$$= 0.350(10^{-3}) \text{ m}^4$$

$$I_{yz} = 0.15(0.05)(0.125)(-0.1) + 0.15(0.05)(-0.125)(0.1)$$

$$= -0.1875(10^{-3}) \text{ m}^4$$

Bending Stress : Using formula developed in Prob. 6-110

$$\sigma = \frac{-(M_z I_y + M_y I_{yz})y + (M_y I_z + M_z I_{yz})z}{I_y I_z - I_{yz}^2}$$

$$\sigma_A = \frac{-[0 + 250(-0.1875)(10^{-3})](0.15) + [250(0.350)(10^{-3}) + 0](-0.175)}{0.18125(10^{-3})(0.350)(10^{-3}) - [0.1875(10^{-3})]^2}$$

$$= -293 \text{ kPa} = 293 \text{ kPa (C)}$$

Ans

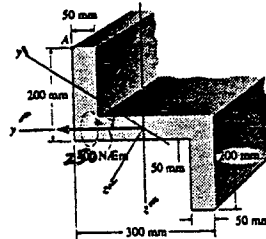

From *Mechanics of Materials*, Sixth Edition by R. C. Hibbeler, ISBN 0-13-191345-X.

© 2005 R. C. Hibbeler. Published by Pearson Prentice Hall,

Pearson Education, Inc., Upper Saddle River, NJ. All rights reserved.

This material is protected under all copyright laws as they currently exist. No portion of this material may be reproduced, in any form or by any means, without permission in writing from the publisher.

***6-116.** Using the techniques outlined in Appendix A, Example A.5 or A.6, the Z section has principal moments of inertia of $I_y = 0.060(10^{-3}) \text{ m}^4$ and $I_z = 0.471(10^{-3}) \text{ m}^4$, computed about the principal axes of inertia y and z , respectively. If the section is subjected to an internal moment of $M = 250 \text{ N} \cdot \text{m}$ directed horizontally as shown, determine the stress produced at point B . Solve the problem using Eq. 6-17.

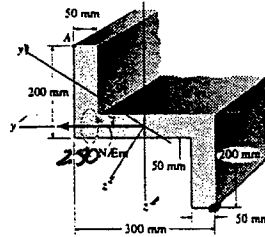

Internal Moment Components :

$$M_y = 250 \cos 32.9^\circ = 209.9 \text{ N} \cdot \text{m}$$

$$M_z = 250 \sin 32.9^\circ = 135.8 \text{ N} \cdot \text{m}$$

Section Property :

$$y' = 0.15 \cos 32.9^\circ + 0.175 \sin 32.9^\circ = 0.2210 \text{ m}$$

$$z' = 0.15 \sin 32.9^\circ - 0.175 \cos 32.9^\circ = -0.06546 \text{ m}$$

Bending Stress : Applying the flexure formula for biaxial bending

$$\sigma = -\frac{M_z \cdot y'}{I_z} + \frac{M_y \cdot z'}{I_y}$$

$$\sigma_B = -\frac{135.8(0.2210)}{0.471(10^{-3})} + \frac{209.9(-0.06546)}{0.060(10^{-3})}$$

$$= -293 \text{ kPa} = 293 \text{ kPa (C)}$$

Ans

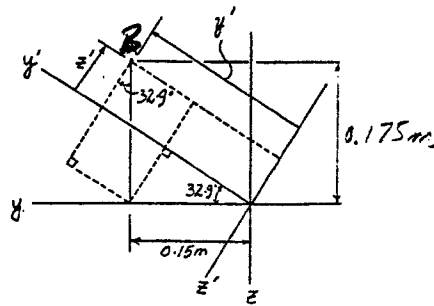

From *Mechanics of Materials*, Sixth Edition by R. C. Hibbeler, ISBN 0-13-191345-X.

© 2005 R. C. Hibbeler. Published by Pearson Prentice Hall,

Pearson Education, Inc., Upper Saddle River, NJ. All rights reserved.

This material is protected under all copyright laws as they currently exist. No portion of this material may be reproduced, in any form or by any means, without permission in writing from the publisher.

6-117. For the section, $I_y = 31.7(10^{-6}) \text{ m}^4$, $I_z = 114(10^{-6}) \text{ m}^4$, $I_{yz} = 15.1(10^{-6}) \text{ m}^4$. Using the techniques outlined in Appendix A, the member's cross-sectional area has principal moments of inertia of $I_y = 29.0(10^{-6}) \text{ m}^4$ and $I_z = 117(10^{-6}) \text{ m}^4$, computed about the principal axes of inertia y and z , respectively. If the section is subjected to a moment of $M = 2500 \text{ N} \cdot \text{m}$ directed as shown, determine the stress produced at point A, using Eq. 6-17.

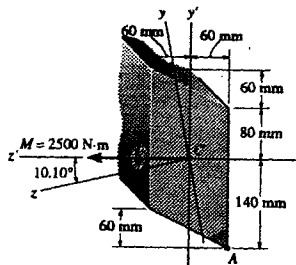

$$I_z = 117(10^{-6}) \text{ m}^4 \quad I_y = 29.0(10^{-6}) \text{ m}^4$$

$$M_y = 2500 \sin 10.1^\circ = 438.42 \text{ N} \cdot \text{m}$$

$$M_z = 2500 \cos 10.1^\circ = 2461.26 \text{ N} \cdot \text{m}$$

$$y = -0.06 \sin 10.1^\circ - 0.14 \cos 10.1^\circ = -0.14835 \text{ m}$$

$$z = 0.14 \sin 10.1^\circ - 0.06 \cos 10.1^\circ = -0.034519 \text{ m}$$

$$\sigma_A = \frac{-M_z y}{I_z} + \frac{M_y z}{I_y}$$

$$= \frac{-2461.26(-0.14835)}{117(10^{-6})} + \frac{438.42(-0.034519)}{29.0(10^{-6})} = 2.60 \text{ MPa (T)} \quad \text{Ans}$$

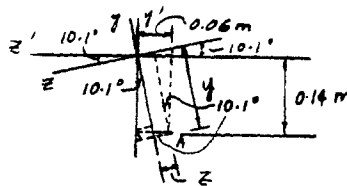

From *Mechanics of Materials*, Sixth Edition by R. C. Hibbeler, ISBN 0-13-191345-X.

© 2005 R. C. Hibbeler. Published by Pearson Prentice Hall,

Pearson Education, Inc., Upper Saddle River, NJ. All rights reserved.

This material is protected under all copyright laws as they currently exist. No portion of this material may be reproduced, in any form or by any means, without permission in writing from the publisher.

6-118. Solve Prob. 6-117 using the equation developed in Prob. 6-111.

$$\sigma_A = \frac{-(M_z I_y + M_y I_{yz})y' + (M_y I_z + M_z I_{yz})z'}{I_y I_z - I_{yz}^2}$$

$$= \frac{-[2500(31.7)(10^{-6}) + 0](-0.14) + [0 + 2500(15.1)(10^{-6})](-0.06)}{31.7(10^{-6})(114)(10^{-6}) - [(15.1)(10^{-6})]^2} = 2.60 \text{ MPa (T)}$$

Ans

From *Mechanics of Materials*, Sixth Edition by R. C. Hibbeler, ISBN 0-13-191345-X.

© 2005 R. C. Hibbeler. Published by Pearson Prentice Hall,

Pearson Education, Inc., Upper Saddle River, NJ. All rights reserved.

This material is protected under all copyright laws as they currently exist. No portion of this material may be reproduced, in any form or by any means, without permission in writing from the publisher.

6-119 The composite beam is made of steel (A) bonded to brass (B) and has the cross section shown. If it is subjected to a moment of $M = 6.5 \text{ kN} \cdot \text{m}$, determine the maximum bending stress in the brass and steel. Also, what is the stress in each material at the seam where they are bonded together? $E_{br} = 100 \text{ GPa}$, $E_{st} = 200 \text{ GPa}$.

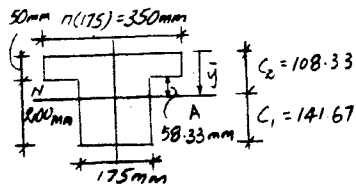
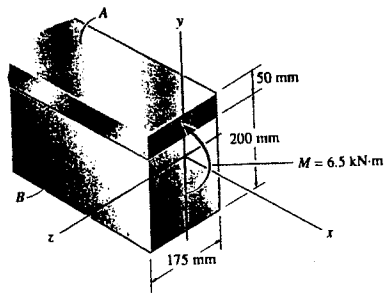

$$n = \frac{E_{st}}{E_{br}} = \frac{200(10^9)}{100(10^9)} = 2$$

$$\bar{y} = \frac{(350)(50)(25) + (175)(200)(150)}{350(50) + 175(200)} = 108.33 \text{ mm}$$

$$I = \frac{1}{12}(0.35)(0.05^3) + (0.35)(0.05)(0.08333^2) + \frac{1}{12}(0.175)(0.2^3) + (0.175)(0.2)(0.04167^2) = 0.3026042(10^{-3})\text{m}^4$$

Maximum stress in brass :

$$(\sigma_{br})_{\max} = \frac{Mc_1}{I} = \frac{6.5(10^3)(0.14167)}{0.3026042(10^{-3})} = 3.04 \text{ MPa} \quad \text{Ans}$$

Maximum stress in steel :

$$(\sigma_{st})_{\max} = \frac{nMc_2}{I} = \frac{(2)(6.5)(10^3)(0.10833)}{0.3026042(10^{-3})} = 4.65 \text{ MPa} \quad \text{Ans}$$

Stress at the junction :

$$\sigma_{br} = \frac{M\rho}{I} = \frac{6.5(10^3)(0.05833)}{0.3026042(10^{-3})} = 1.25 \text{ MPa} \quad \text{Ans}$$

$$\sigma_{st} = n\sigma_{br} = 2(1.25) = 2.51 \text{ MPa} \quad \text{Ans}$$

From *Mechanics of Materials*, Sixth Edition by R. C. Hibbeler, ISBN 0-13-191345-X.

© 2005 R. C. Hibbeler. Published by Pearson Prentice Hall,

Pearson Education, Inc., Upper Saddle River, NJ. All rights reserved.

This material is protected under all copyright laws as they currently exist. No portion of this material may be reproduced, in any form or by any means, without permission in writing from the publisher.

*6-120 The composite beam is made of steel (A) bonded to brass (B) and has the cross section shown. If the allowable bending stress for the steel is $(\sigma_{\text{allow}})_{st} = 180 \text{ MPa}$, and for the brass $(\sigma_{\text{allow}})_{br} = 60 \text{ MPa}$, determine the maximum moment M that can be applied to the beam. $E_{br} = 100 \text{ GPa}$, $E_{st} = 200 \text{ GPa}$.

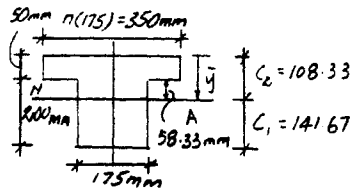
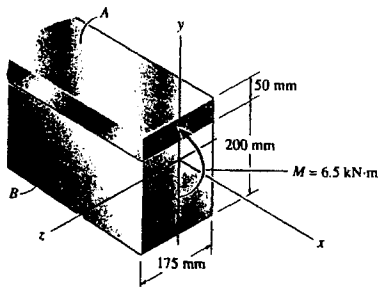

$$n = \frac{E_{st}}{E_{br}} = \frac{200(10^9)}{100(10^9)} = 2$$

$$\bar{y} = \frac{(350)(50)(25) + (175)(200)(150)}{350(50) + 175(200)} = 108.33 \text{ mm}$$

$$I = \frac{1}{12}(0.35)(0.05^3) + (0.35)(0.05)(0.08333^2) + \frac{1}{12}(0.175)(0.2^3) + (0.175)(0.2)(0.04167^2) = 0.3026042(10^{-3})\text{m}^4$$

$$(\sigma_{st})_{\text{allow}} = \frac{nMc_2}{I}; \quad 180(10^6) = \frac{(2)M(0.10833)}{0.3026042(10^{-3})}$$

$$M = 251 \text{ kN} \cdot \text{m}$$

$$(\sigma_{br})_{\text{allow}} = \frac{Mc_1}{I}; \quad 60(10^6) = \frac{M(0.14167)}{0.3026042(10^{-3})}$$

$$M = 128 \text{ kN} \cdot \text{m (controls)} \quad \text{Ans}$$

From *Mechanics of Materials*, Sixth Edition by R. C. Hibbeler, ISBN 0-13-191345-X.

© 2005 R. C. Hibbeler. Published by Pearson Prentice Hall,

Pearson Education, Inc., Upper Saddle River, NJ. All rights reserved.

This material is protected under all copyright laws as they currently exist. No portion of this material may be reproduced, in any form or by any means, without permission in writing from the publisher.

6-121 A wood beam is reinforced with steel straps at its top and bottom as shown. Determine the maximum bending stress developed in the wood and steel if the beam is subjected to a bending moment of $M = 5 \text{ kN} \cdot \text{m}$. Sketch the stress distribution acting over the cross section. Take $E_w = 11 \text{ GPa}$, $E_{st} = 200 \text{ GPa}$.

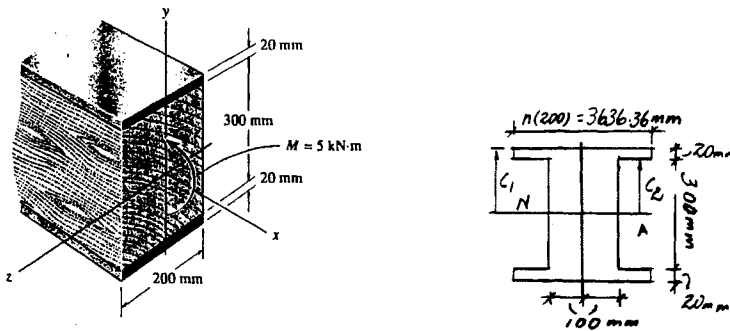

$$I = \frac{1}{12}(3.63636)(0.34)^3 - \frac{1}{12}(3.43636)(0.3)^3 = 4.17848(10^{-3})\text{m}^4$$

Maximum stress in steel :

$$(\sigma_{st})_{\max} = \frac{nMc_1}{I} = \frac{18.182(5)(10^3)(0.17)}{4.17848(10^{-3})} = 3.70 \text{ MPa} \quad \text{Ans}$$

Maximum stress in wood :

$$(\sigma_w)_{\max} = \frac{Mc_2}{I} = \frac{5(10^3)(0.15)}{4.17848(10^{-3})} = 0.179 \text{ MPa} \quad \text{Ans}$$

$$(\sigma_{st}) = n(\sigma_w)_{\max} = 18.182(0.179) = 3.26 \text{ MPa}$$

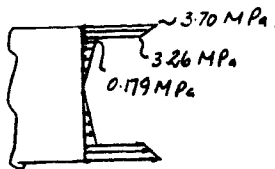

From *Mechanics of Materials*, Sixth Edition by R. C. Hibbeler, ISBN 0-13-191345-X.

© 2005 R. C. Hibbeler. Published by Pearson Prentice Hall,

Pearson Education, Inc., Upper Saddle River, NJ. All rights reserved.

This material is protected under all copyright laws as they currently exist. No portion of this material may be reproduced, in any form or by any means, without permission in writing from the publisher.

6-122 The sandwich beam is used as a strut in a surfboard. It consists of top and bottom face segments that are made from thin strips of aluminum and an inner core of plastic resin. Determine the maximum bending stress in the aluminum and plastic if the beam is subjected to a moment of $M = 6 \text{ lb} \cdot \text{in}$. $E_{al} = 10(10^3) \text{ ksi}$, $E_{pl} = 2(10^3) \text{ ksi}$.

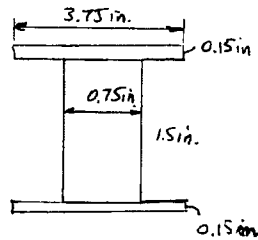
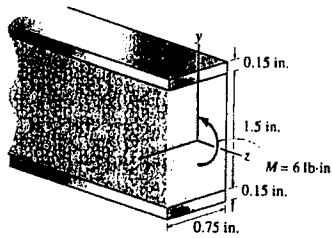

$$n = \frac{10(10^3)}{2(10^3)} = 5$$

$$I = \frac{1}{12}(3.75)(1.8)^3 - \frac{1}{12}(3)(1.5)^3 = 0.97875 \text{ in}^4$$

Maximum stress in the aluminum :

$$(\sigma_{al})_{\max} = n \frac{M c_1}{I} = \frac{5(6)(0.75 + 0.15)}{0.97875} = 27.6 \text{ psi} \quad \text{Ans}$$

Maximum stress in the plastic :

$$(\sigma_{pl})_{\max} = \frac{M c_2}{I} = \frac{6(0.75)}{0.97875} = 4.60 \text{ psi} \quad \text{Ans}$$

From *Mechanics of Materials*, Sixth Edition by R. C. Hibbeler, ISBN 0-13-191345-X.

© 2005 R. C. Hibbeler. Published by Pearson Prentice Hall,

Pearson Education, Inc., Upper Saddle River, NJ. All rights reserved.

This material is protected under all copyright laws as they currently exist. No portion of this material may be reproduced, in any form or by any means, without permission in writing from the publisher.

6-123 The steel channel is used to reinforce the wood beam. Determine the maximum bending stress in the steel and in the wood if the beam is subjected to a moment of $M = 850$ lb · ft. $E_{st} = 29(10^3)$ ksi, $E_w = 1600$ ksi.

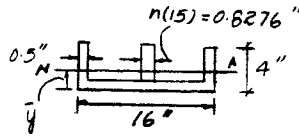
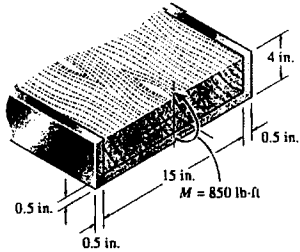

$$\bar{y} = \frac{(0.5)(16)(0.25) + 2(3.5)(0.5)(2.25) + (0.8276)(3.5)(2.25)}{0.5(16) + 2(3.5)(0.5) + (0.8276)(3.5)} = 1.1386 \text{ in.}$$

$$I = \frac{1}{12}(16)(0.5^3) + (16)(0.5)(0.8886^2) + 2\left(\frac{1}{12}\right)(0.5)(3.5^3) + 2(0.5)(3.5)(1.1114^2) + \frac{1}{12}(0.8276)(3.5^3) + (0.8276)(3.5)(1.1114^2) = 20.914 \text{ in}^4$$

Maximum stress in steel :

$$(\sigma_{st}) = \frac{Mc}{I} = \frac{850(12)(4 - 1.1386)}{20.914} = 1395 \text{ psi} = 1.40 \text{ ksi} \quad \text{Ans}$$

Maximum stress in wood :

$$(\sigma_w) = n(\sigma_{st})_{\max} = 0.05517(1395) = 77.0 \text{ psi} \quad \text{Ans}$$

From *Mechanics of Materials*, Sixth Edition by R. C. Hibbeler, ISBN 0-13-191345-X.

© 2005 R. C. Hibbeler. Published by Pearson Prentice Hall,

Pearson Education, Inc., Upper Saddle River, NJ. All rights reserved.

This material is protected under all copyright laws as they currently exist. No portion of this material may be reproduced, in any form or by any means, without permission in writing from the publisher.

*6-124 The member has a brass core bonded to a steel casing. If a couple moment of $8 \text{ kN} \cdot \text{m}$ is applied at its end, determine the maximum bending stress in the member. $E_{br} = 100 \text{ GPa}$, $E_{st} = 200 \text{ GPa}$.

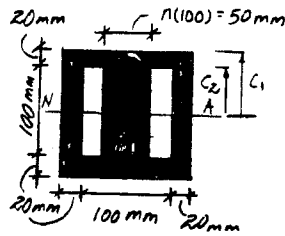
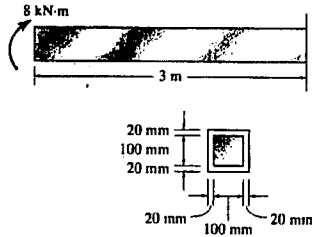

$$n = \frac{E_{br}}{E_{st}} = \frac{100}{200} = 0.5$$

$$I = \frac{1}{12}(0.14)(0.14)^3 - \frac{1}{12}(0.05)(0.1)^3 = 27.84667(10^{-6})\text{m}^4$$

Maximum stress in steel :

$$(\sigma_{st})_{\max} = \frac{Mc_1}{I} = \frac{8(10^3)(0.07)}{27.84667(10^{-6})} = 20.1 \text{ MPa} \quad (\text{max}) \quad \text{Ans}$$

Maximum stress in brass :

$$(\sigma_{br})_{\max} = \frac{nMc_2}{I} = \frac{0.5(8)(10^3)(0.05)}{27.84667(10^{-6})} = 7.18 \text{ MPa}$$

From *Mechanics of Materials*, Sixth Edition by R. C. Hibbeler, ISBN 0-13-191345-X.

© 2005 R. C. Hibbeler. Published by Pearson Prentice Hall,

Pearson Education, Inc., Upper Saddle River, NJ. All rights reserved.

This material is protected under all copyright laws as they currently exist. No portion of this material may be reproduced, in any form or by any means, without permission in writing from the publisher.

6-125 The beam is made from three types of plastic that are identified and have the moduli of elasticity shown in the figure. Determine the maximum bending stress in the PVC.

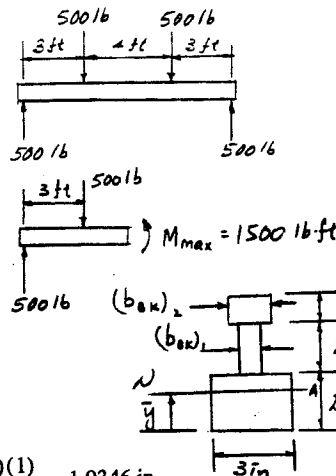
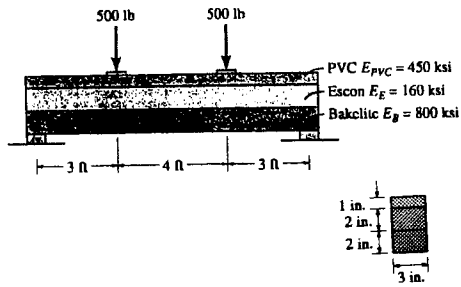

$$(b_{bk})_1 = n_1 b_{Es} = \frac{160}{800}(3) = 0.6 \text{ in.}$$

$$(b_{bk})_2 = n_2 b_{pvc} = \frac{450}{800}(3) = 1.6875 \text{ in.}$$

$$\bar{y} = \frac{\Sigma \bar{y}A}{\Sigma A} = \frac{(1)(3)(2) + 3(0.6)(2) + 4.5(1.6875)(1)}{3(2) + 0.6(2) + 1.6875(1)} = 1.9346 \text{ in.}$$

$$I = \frac{1}{12}(3)(2^3) + 3(2)(0.9346^2) + \frac{1}{12}(0.6)(2^3) + 0.6(2)(1.0654^2) + \frac{1}{12}(1.6875)(1^3) + 1.6875(1)(2.5654^2) = 20.2495 \text{ in}^4$$

$$(\sigma_{\max})_{pvc} = n_2 \frac{M c}{I} = \left(\frac{450}{800}\right) \frac{1500(12)(3.0654)}{20.2495} = 1.53 \text{ ksi} \quad \text{Ans}$$

From *Mechanics of Materials*, Sixth Edition by R. C. Hibbeler, ISBN 0-13-191345-X.
 © 2005 R. C. Hibbeler. Published by Pearson Prentice Hall,
 Pearson Education, Inc., Upper Saddle River, NJ. All rights reserved.
 This material is protected under all copyright laws as they currently exist. No portion of this material may be reproduced, in any form or by any means, without permission in writing from the publisher.

6-426 The reinforced concrete beam is used to support the loading shown. Determine the absolute maximum normal stress in each of the A-36 steel reinforcing rods and the absolute maximum compressive stress in the concrete. Assume the concrete has a high strength in compression and neglect its strength in supporting tension.

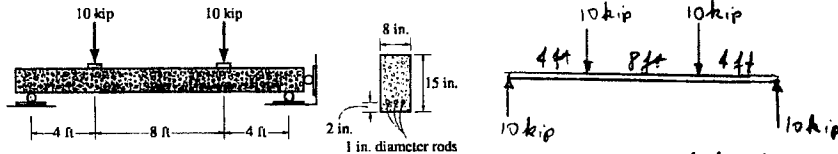

$$M_{max} = (10 \text{ kip})(4 \text{ ft}) = 40 \text{ kip} \cdot \text{ft}$$

$$A_{st} = 3(\pi)(0.5)^2 = 2.3562 \text{ in}^2$$

$$E_{st} = 29.0(10^3) \text{ ksi}$$

$$E_{con} = 4.20(10^3) \text{ ksi}$$

$$A' = nA_{st} = \frac{29.0(10^3)}{4.20(10^3)}(2.3562) = 16.2690 \text{ in}^2$$

$$\Sigma \bar{y}A = 0; \quad 8(h')\left(\frac{h'}{2}\right) - 16.2690(13 - h') = 0$$

$$h'^2 + 4.06724h' - 52.8741 = 0$$

Solving for the positive root :

$$h' = 5.517 \text{ in.}$$

$$I = \left[\frac{1}{12}(8)(5.517)^3 + 8(5.517)(5.517/2)^2 \right] + 16.2690(13 - 5.517)^2 = 1358.781 \text{ in}^4$$

$$(\sigma_{con})_{max} = \frac{My}{I} = \frac{40(12)(5.517)}{1358.781} = 1.95 \text{ ksi} \quad \text{Ans}$$

$$(\sigma_{st})_{max} = n\left(\frac{My}{I}\right) = \left(\frac{29.0(10^3)}{4.20(10^3)}\right)\left(\frac{40(12)(13 - 5.517)}{1358.781}\right) = 18.3 \text{ ksi} \quad \text{Ans}$$

From *Mechanics of Materials*, Sixth Edition by R. C. Hibbeler, ISBN 0-13-191345-X.

© 2005 R. C. Hibbeler. Published by Pearson Prentice Hall,

Pearson Education, Inc., Upper Saddle River, NJ. All rights reserved.

This material is protected under all copyright laws as they currently exist. No portion of this material may be reproduced, in any form or by any means, without permission in writing from the publisher.

6-127. The reinforced concrete beam is made using two steel reinforcing rods. If the allowable tensile stress, for the steel is $(\sigma_{st})_{allow} = 40$ ksi, and the allowable compressive stress for the concrete is $(\sigma_{conc})_{allow} = 3$ ksi, determine the maximum moment M that can be applied to the section. Assume the concrete cannot support a tensile stress. $E_{st} = 29(10^3)$ ksi, $E_{conc} = 3.8(10^3)$ ksi.

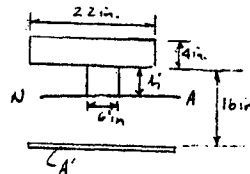
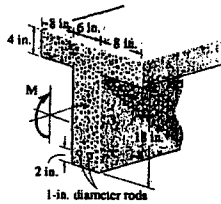

$$A_{st} = 2(\pi)(0.5)^2 = 1.5708 \text{ in}^2$$

$$A' = nA_{st} = \frac{29(10^3)}{3.8(10^3)}(1.5708) = 11.9877 \text{ in}^2$$

$$\Sigma \bar{y}A = 0; \quad 22(4)(h' + 2) + h'(6)(h'/2) - 11.9877(16 - h') = 0$$

$$3h^2 + 99.9877h' - 15.8032 = 0$$

Solving for the positive root :

$$h' = 0.15731 \text{ in.}$$

$$I = \left[\frac{1}{12}(22)(4)^3 + 22(4)(2.15731)^2 \right] + \left[\frac{1}{12}(6)(0.15731)^3 + 6(0.15731)(0.15731/2)^2 \right]$$

$$+ 11.9877(16 - 0.15731)^2 = 3535.69 \text{ in}^4$$

Assume concrete fails :

$$(\sigma_{conc})_{allow} = \frac{My}{I}; \quad 3 = \frac{M(4.15731)}{3535.69}$$

$$M = 2551 \text{ kip} \cdot \text{in.}$$

Assume steel fails :

$$(\sigma_{st})_{allow} = n\left(\frac{My}{I}\right); \quad 40 = \left(\frac{29(10^3)}{3.8(10^3)}\right)\left(\frac{M(16 - 0.15731)}{3535.69}\right)$$

$$M = 1169.7 \text{ kip} \cdot \text{in.} = 97.5 \text{ kip} \cdot \text{ft (controls)} \quad \text{Ans}$$

From *Mechanics of Materials*, Sixth Edition by R. C. Hibbeler, ISBN 0-13-191345-X.

© 2005 R. C. Hibbeler. Published by Pearson Prentice Hall,

Pearson Education, Inc., Upper Saddle River, NJ. All rights reserved.

This material is protected under all copyright laws as they currently exist. No portion of this material may be reproduced, in any form or by any means, without permission in writing from the publisher.

*6-128 Determine the maximum uniform distributed load w_0 that can be supported by the reinforced concrete beam if the allowable tensile stress for the steel is $(\sigma_s)_{allow} = 28$ ksi, and the allowable compressive stress for the concrete is $(\sigma_{conc})_{allow} = 3$ ksi. Assume the concrete cannot support a tensile stress. Take $E_{st} = 29(10^3)$ ksi, $E_{conc} = 3.6(10^3)$ ksi.

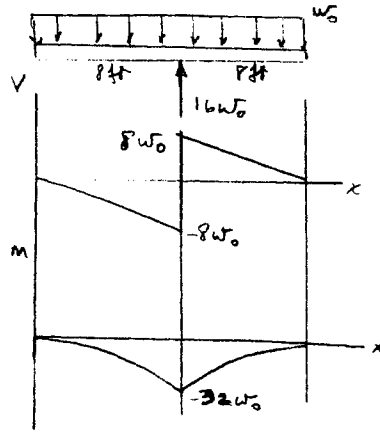
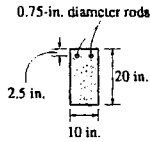
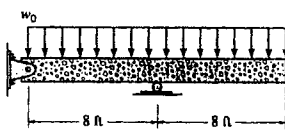

$$M_{max} = -32w_0$$

$$A_{st} = 2\pi (0.375)^2 = 0.883573 \text{ in}^2$$

$$A' = nA_{st} = \frac{29(10^3)}{3.6(10^3)} (0.883573) = 7.11767 \text{ in}^2$$

$$\Sigma \bar{y}A = 0; \quad -10(h')(h'/2) + 7.11767(17.5 - h') = 0$$

$$5h'^2 + 7.11767h' - 124.559 = 0$$

Solving for the positive root :

$$h' = 4.330 \text{ in.}$$

$$I = \left[\frac{1}{12} (10)(4.330)^3 + (10)(4.330)(4.330/2)^2 \right] + 7.11767(17.5 - 4.330)^2 = 1505.161 \text{ in}^4$$

Assume concrete fails :

$$(\sigma_{con})_{allow} = \frac{My}{I}; \quad 3 = \frac{M(4.330)}{1505.161}$$

$$M = 1043.9 \text{ kip} \cdot \text{in.}$$

Assume steel fails :

$$(\sigma_{st})_{allow} = n \left(\frac{My}{I} \right); \quad 28 = \left(\frac{29(10^3)}{3.6(10^3)} \right) \left(\frac{M(17.5 - 4.330)}{1505.161} \right)$$

$$M = 397.2 \text{ kip} \cdot \text{in.}$$

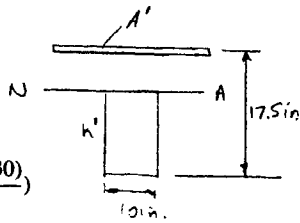

Thus, steel fails first :

$$\frac{397.2}{12} = 32w_0; \quad w_0 = 1.03 \text{ kip/ft} \quad \text{Ans}$$

From *Mechanics of Materials*, Sixth Edition by R. C. Hibbeler, ISBN 0-13-191345-X.

© 2005 R. C. Hibbeler. Published by Pearson Prentice Hall,

Pearson Education, Inc., Upper Saddle River, NJ. All rights reserved.

This material is protected under all copyright laws as they currently exist. No portion of this material may be reproduced, in any form or by any means, without permission in writing from the publisher.

6-129 A bimetallic strip is made from pieces of 2014-T6 aluminum and C83400 red brass, having the cross section shown. A temperature increase causes its neutral surface to be bent into a circular arc having a radius of 16 in. Determine the moment that must be acting on its cross section due to the thermal stress.

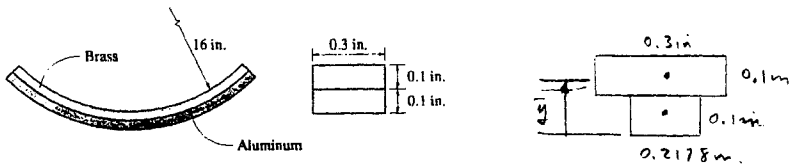

Transform the section to brass.

$$n = \frac{E_{al}}{E_{br}} = \frac{10.6}{14.6} = 0.7260$$

Thus,

$$\bar{y} = \frac{0.05(0.1)(0.2178) + (0.15)(0.1)(0.3)}{(0.1)(0.2178) + (0.1)(0.3)} = 0.10794 \text{ in.}$$

$$I = \frac{1}{12}(0.2178)(0.1)^3 + (0.2178)(0.1)(0.10794 - 0.05)^2 + \frac{1}{12}(0.3)(0.1)^3 + (0.1)(0.3)(0.15 - 0.10794)^2 = 169.34(10^{-6}) \text{ in}^4$$

$$\frac{1}{\rho} = \frac{M}{EI}$$

$$M = \frac{14.6(10^6)(169.34)(10^{-6})}{16.092} = 154 \text{ lb} \cdot \text{ft} \quad \text{Ans.}$$

From *Mechanics of Materials*, Sixth Edition by R. C. Hibbeler, ISBN 0-13-191345-X.

© 2005 R. C. Hibbeler. Published by Pearson Prentice Hall,

Pearson Education, Inc., Upper Saddle River, NJ. All rights reserved.

This material is protected under all copyright laws as they currently exist. No portion of this material may be reproduced, in any form or by any means, without permission in writing from the publisher.

6-130 The fork is used as part of a nosewheel assembly for an airplane. If the maximum wheel reaction at the end of the fork is 840 lb, determine the maximum bending stress in the curved portion of the fork at section $a-a$. There the cross-sectional area is circular, having a diameter of 2 in.

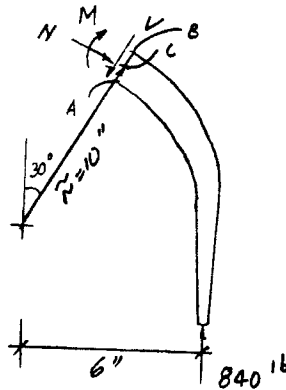
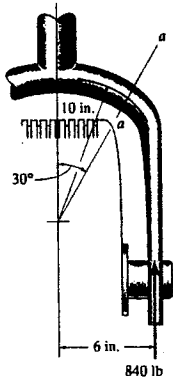

$$\begin{aligned} \sum M_C = 0; \quad M - 840(6 - 10 \sin 30^\circ) &= 0 \\ M &= 840 \text{ lb} \cdot \text{in.} \end{aligned}$$

$$\begin{aligned} \int_A \frac{dA}{r} &= 2\pi(\bar{r} - \sqrt{\bar{r}^2 - c^2}) \\ &= 2\pi(10 - \sqrt{10^2 - (1)^2}) \\ &= 0.314948615 \text{ in.} \end{aligned}$$

$$A = \pi c^2 = \pi (1)^2 = \pi \text{ in}^2$$

$$R = \frac{A}{\int_A \frac{dA}{r}} = \frac{\pi}{0.314948615} = 9.974937173 \text{ in.}$$

$$\bar{r} - R = 10 - 9.974937173 = 0.025062827 \text{ in.}$$

$$\sigma_A = \frac{M(R - r_A)}{Ar_A(\bar{r} - R)} = \frac{840(9.974937173 - 9)}{\pi(9)(0.025062827)} = 1.16 \text{ ksi (T) (max) \quad Ans}$$

$$\sigma_B = \frac{M(R - r_B)}{Ar_B(\bar{r} - R)} = \frac{840(9.974937173 - 11)}{\pi(11)(0.025062827)} = -0.994 \text{ ksi (C)}$$

From *Mechanics of Materials*, Sixth Edition by R. C. Hibbeler, ISBN 0-13-191345-X.

© 2005 R. C. Hibbeler. Published by Pearson Prentice Hall,

Pearson Education, Inc., Upper Saddle River, NJ. All rights reserved.

This material is protected under all copyright laws as they currently exist. No portion of this material may be reproduced, in any form or by any means, without permission in writing from the publisher.

6-131 The curved member is symmetric and is subjected to a moment of $M = 600 \text{ lb} \cdot \text{ft}$. Determine the bending stress in the member at points A and B. Show the stress acting on volume elements located at these points.

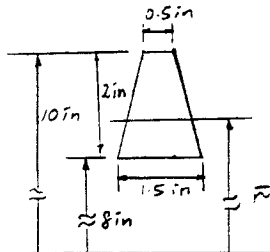
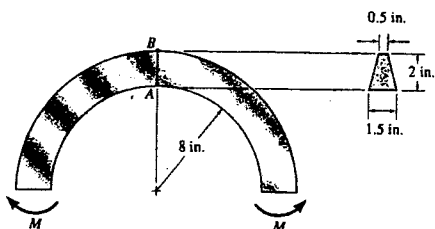

$$A = 0.5(2) + \frac{1}{2}(1)(2) = 2 \text{ in}^2$$

$$\bar{r} = \frac{\Sigma \bar{r}A}{\Sigma A} = \frac{9(0.5)(2) + 8.6667(\frac{1}{2})(1)(2)}{2} = 8.83333 \text{ in.}$$

$$\int_A \frac{dA}{r} = 0.5 \ln \frac{10}{8} + \left[\frac{1(10)}{(10-8)} \left[\ln \frac{10}{8} \right] - 1 \right] = 0.22729 \text{ in.}$$

$$R = \frac{A}{\int_A \frac{dA}{r}} = \frac{2}{0.22729} = 8.7993 \text{ in.}$$

$$\bar{r} - R = 8.83333 - 8.7993 = 0.03398 \text{ in.}$$

$$\sigma = \frac{M(R - r)}{Ar(\bar{r} - R)}$$

$$\sigma_A = \frac{600(12)(8.7993 - 8)}{2(8)(0.03398)} = 10.6 \text{ ksi (T)}$$

$$\sigma_B = \frac{600(12)(8.7993 - 10)}{2(10)(0.03398)} = -12.7 \text{ ksi} = 12.7 \text{ ksi (C)} \quad \text{Ans}$$

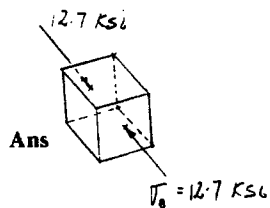
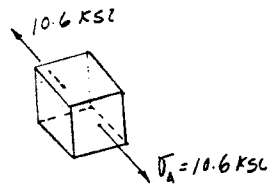

From *Mechanics of Materials*, Sixth Edition by R. C. Hibbeler, ISBN 0-13-191345-X.

© 2005 R. C. Hibbeler. Published by Pearson Prentice Hall,

Pearson Education, Inc., Upper Saddle River, NJ. All rights reserved.

This material is protected under all copyright laws as they currently exist. No portion of this material may be reproduced, in any form or by any means, without permission in writing from the publisher.

*6-132 The curved member is symmetric and is subjected to a moment of $M = 400 \text{ lb} \cdot \text{ft}$. Determine the maximum tensile and compressive stress in the member. Compare these values with those for a straight member having the same cross section and loaded with the same moment.

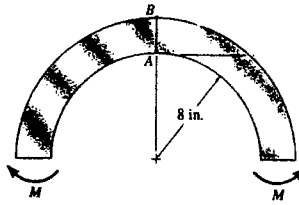

$$A = 0.5(2) + \frac{1}{2}(1)(2) = 2 \text{ in}^2$$

$$\bar{r} = \frac{\Sigma \bar{r}A}{\Sigma A} = \frac{9(0.5)(2) + 8.6667(\frac{1}{2})(1)(2)}{2} = 8.8333 \text{ in.}$$

$$\int_A \frac{dA}{r} = 0.5 \ln \frac{10}{8} + \left[\frac{1(10)}{(10-8)} \left[\ln \frac{10}{8} \right] - 1 \right] = 0.22729 \text{ in.}$$

$$R = \frac{A}{\int_A \frac{dA}{r}} = \frac{2}{0.22729} = 8.7993 \text{ in.}$$

$$\bar{r} - R = 8.8333 - 8.7993 = 0.03398 \text{ in.}$$

$$\sigma = \frac{M(R - r)}{Ar(\bar{r} - R)}$$

$$(\sigma_{\max})_t = \frac{400(12)(8.7993 - 8)}{2(8)(0.3398)} = 7.06 \text{ ksi} \quad \text{Ans}$$

$$(\sigma_{\max})_c = \frac{400(12)(8.7993 - 10)}{2(10)(0.3398)} = -8.48 \text{ ksi} = 8.48 \text{ ksi (C)} \quad \text{Ans}$$

For straight beam : $\bar{y} = \bar{r} - 8 = 0.83333 \text{ in.}$

$$I = \frac{1}{12}(0.5)(2^3) + 0.5(2)(0.1666^2) + \frac{1}{36}(1)(2^3) + \frac{1}{2}(1)(2)(0.1666^2) = 0.61111 \text{ in}^4$$

Bending stress :

$$(\sigma_{\max})_c = \frac{Mc}{I} = \frac{400(12)(1.1666)}{0.61111} = 9.16 \text{ ksi} \quad \text{Ans}$$

$$(\sigma_{\max})_t = \frac{My}{I} = \frac{400(12)(0.8333)}{0.61111} = 6.54 \text{ ksi} \quad \text{Ans}$$

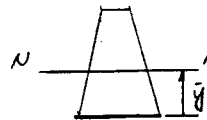
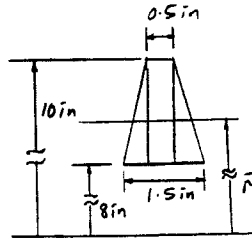

From *Mechanics of Materials*, Sixth Edition by R. C. Hibbeler, ISBN 0-13-191345-X.
 © 2005 R. C. Hibbeler. Published by Pearson Prentice Hall,
 Pearson Education, Inc., Upper Saddle River, NJ. All rights reserved.
 This material is protected under all copyright laws as they currently exist. No portion of this material may be reproduced, in any form or by any means, without permission in writing from the publisher.

6-133. The curved beam is subjected to a bending moment of $M = 40 \text{ lb}\cdot\text{ft}$. Determine the maximum bending stress in the beam. Also, sketch a two-dimensional view of the stress distribution acting on section $a-a$.

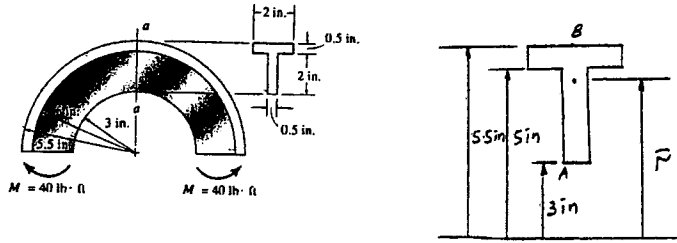

Section properties :

$$\bar{r} = \frac{4(2)(0.5) + 5.25(2)(0.5)}{2(0.5) + 2(0.5)} = 4.625 \text{ in.}$$

$$\Sigma \int \frac{dA}{r} = 0.5 \ln \frac{5}{3} + 2 \ln \frac{5.5}{5} = 0.446033 \text{ in.}$$

$$R = \frac{A}{\int \frac{dA}{r}} = \frac{2}{0.446033} = 4.4840 \text{ in.}$$

$$\bar{r} - R = 4.625 - 4.4840 = 0.1410 \text{ in.}$$

$$\sigma = \frac{M(R - r)}{Ar(\bar{r} - R)}$$

$$\sigma_A = \frac{40(12)(4.4840 - 3)}{2(3)(0.1410)} = 842 \text{ psi (T) (Max)}$$

Ans

$$\sigma_B = \frac{40(12)(4.4840 - 5.5)}{2(5.5)(0.1410)} = -314 \text{ psi} = 314 \text{ psi (C)}$$

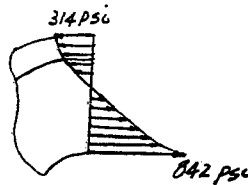

From *Mechanics of Materials*, Sixth Edition by R. C. Hibbeler, ISBN 0-13-191345-X.

© 2005 R. C. Hibbeler. Published by Pearson Prentice Hall,

Pearson Education, Inc., Upper Saddle River, NJ. All rights reserved.

This material is protected under all copyright laws as they currently exist. No portion of this material may be reproduced, in any form or by any means, without permission in writing from the publisher.

6-134. The curved beam is made from a material having an allowable bending stress of $\sigma_{\text{allow}} = 24$ ksi. Determine the maximum moment M that can be applied to the beam.

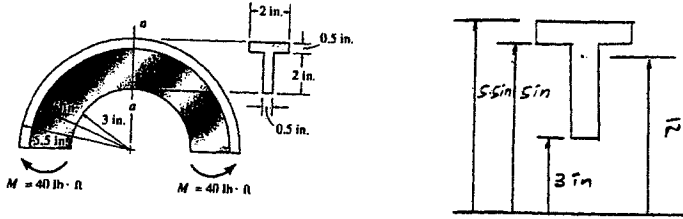

$$\bar{r} = \frac{4(2)(0.5) + 5.25(2)(0.5)}{2(0.5) + 2(0.5)} = 4.625 \text{ in.}$$

$$\Sigma \int_A \frac{dA}{r} = 0.5 \ln \frac{5}{3} + 2 \ln \frac{5.5}{5} = 0.4460 \text{ in.}$$

$$R = \frac{A}{\int_A \frac{dA}{r}} = \frac{2}{0.4460} = 4.4840 \text{ in.}$$

$$\bar{r} - R = 4.625 - 4.4840 = 0.1410 \text{ in.}$$

$$\sigma = \frac{M(R - r)}{Ar(\bar{r} - R)}$$

Assume tension failure :

$$24 = \frac{M(4.484 - 3)}{2(3)(0.1410)}$$

$$M = 13.68 \text{ kip} \cdot \text{in.} = 1.14 \text{ kip} \cdot \text{ft} \quad (\text{controls}) \quad \text{Ans}$$

Assume compression failure :

$$-24 = \frac{M(4.484 - 5.5)}{2(5.5)(0.1410)}; \quad M = 36.64 \text{ kip} \cdot \text{in.} = 3.05 \text{ kip} \cdot \text{ft}$$

From *Mechanics of Materials*, Sixth Edition by R. C. Hibbeler, ISBN 0-13-191345-X.

© 2005 R. C. Hibbeler. Published by Pearson Prentice Hall,

Pearson Education, Inc., Upper Saddle River, NJ. All rights reserved.

This material is protected under all copyright laws as they currently exist. No portion of this material may be reproduced, in any form or by any means, without permission in writing from the publisher.

6-135 The curved bar used on a machine has a rectangular cross section. If the bar is subjected to a couple as shown, determine the maximum tensile and compressive stress acting at section $a-a$. Sketch the stress distribution on the section in three dimensions.

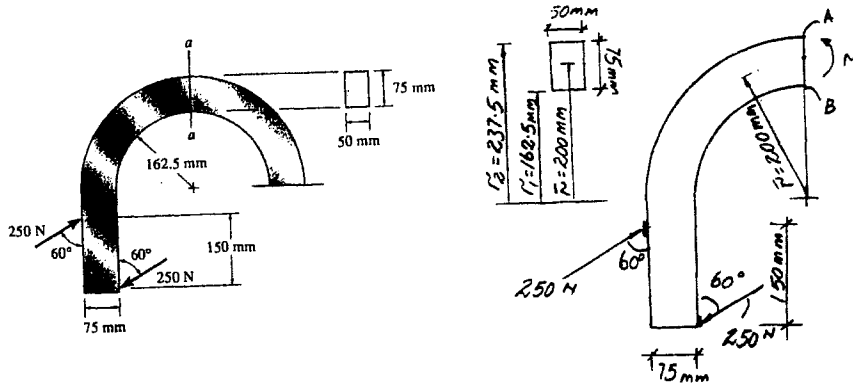

$$+\Sigma M_O = 0; \quad M - 250 \cos 60^\circ (0.075) - 250 \sin 60^\circ (0.15) = 0$$

$$M = 41.851 \text{ N} \cdot \text{m}$$

$$\int_A \frac{dA}{r} = b \ln \frac{r_2}{r_1} = 0.05 \ln \frac{0.2375}{0.1625} = 0.018974481 \text{ m}$$

$$A = (0.075)(0.05) = 3.75(10^{-3}) \text{ m}^2$$

$$R = \frac{A}{\int_A \frac{dA}{r}} = \frac{3.75(10^{-3})}{0.018974481} = 0.197633863 \text{ m}$$

$$\bar{r} - R = 0.2 - 0.197633863 = 0.002366137$$

$$\sigma_A = \frac{M(R - r_A)}{A r_A (\bar{r} - R)} = \frac{41.851(0.197633863 - 0.2375)}{3.75(10^{-3})(0.2375)(0.002366137)} = -791.72 \text{ kPa}$$

$$= 792 \text{ kPa (C)} \quad \text{Ans}$$

$$\sigma_B = \frac{M(R - r_B)}{A r_B (\bar{r} - R)} = \frac{41.851(0.197633863 - 0.1625)}{3.75(10^{-3})(0.1625)(0.002366137)} = 1.02 \text{ MPa (T)} \quad \text{Ans}$$

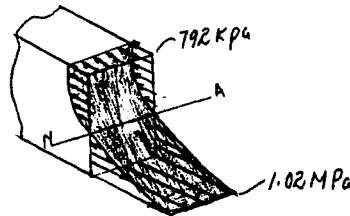

From *Mechanics of Materials*, Sixth Edition by R. C. Hibbeler, ISBN 0-13-191345-X.

© 2005 R. C. Hibbeler. Published by Pearson Prentice Hall,

Pearson Education, Inc., Upper Saddle River, NJ. All rights reserved.

This material is protected under all copyright laws as they currently exist. No portion of this material may be reproduced, in any form or by any means, without permission in writing from the publisher.

*6-136 The curved box member is symmetric and is subjected to a moment of $M = 500 \text{ lb} \cdot \text{ft}$. Determine the bending stress in the member at points A and B . Show the stress acting on volume elements located at these points.

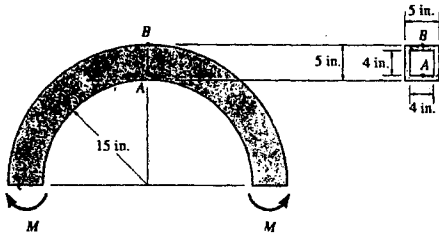

$$\int \frac{dA}{r} = \sum b \ln \frac{r_2}{r_1} = 5 \ln \frac{20}{15} - 4 \ln \frac{19.5}{15.5} = 0.520112595 \text{ in.}$$

$$A = (5)(5) - (4)(4) = 9 \text{ in}^2$$

$$R = \frac{A}{\int \frac{dA}{r}} = \frac{9}{0.520112595} = 17.30394549 \text{ in.}$$

$$\bar{r} - R = 17.5 - 17.30394549 = 0.196054513 \text{ in.}$$

$$\sigma_A = \frac{M(R - r_A)}{Ar_A(\bar{r} - R)} = \frac{500(12)(17.30394549 - 15.5)}{9(15.5)(0.196054513)} = 396 \text{ psi (T)} \quad \text{Ans.}$$

$$\sigma_B = \frac{M(R - r_B)}{Ar_B(\bar{r} - R)} = \frac{500(12)(17.30394549 - 20)}{9(20)(0.196054513)} = -458 \text{ psi (C)} \quad \text{Ans}$$

$$\sigma_B = 458 \text{ psi}$$

$$\sigma_A = 396 \text{ psi}$$

From *Mechanics of Materials*, Sixth Edition by R. C. Hibbeler, ISBN 0-13-191345-X.
 © 2005 R. C. Hibbeler. Published by Pearson Prentice Hall,
 Pearson Education, Inc., Upper Saddle River, NJ. All rights reserved.
 This material is protected under all copyright laws as they currently exist. No portion of this material may be reproduced, in any form or by any means, without permission in writing from the publisher.

6-137 The curved box member is symmetric and is subjected to a moment of $M = 350 \text{ lb} \cdot \text{ft}$. Determine the maximum tensile and compressive stress in the member. Compare these values with those for a straight member having the same cross section and loaded with the same moment.

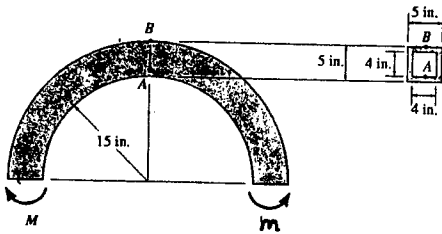

$$\int \frac{dA}{r} = \Sigma b \ln \frac{r_2}{r_1} = 5 \ln \frac{20}{15} - 4 \ln \frac{19.5}{15.5} = 0.520112595 \text{ in.}$$

$$A = (5)(5) - (4)(4) = 9 \text{ in}^2$$

$$R = \frac{A}{\int_A \frac{dA}{r}} = \frac{9}{0.520112595} = 17.30394549 \text{ in.}$$

$$\bar{r} - R = 17.5 - 17.30394549 = 0.196054513 \text{ in.}$$

Tensile stress :

$$(\sigma_t)_{\max} = \frac{M(R - r_A)}{Ar_A(\bar{r} - R)} = \frac{350(12)(17.30394549 - 15)}{(9)(15)(0.196054513)} = 366 \text{ psi} \quad \text{Ans}$$

Compressive stress :

$$(\sigma_c)_{\max} = \frac{M(R - r_B)}{Ar_B(\bar{r} - R)} = \frac{350(12)(17.30394549 - 20)}{9(20)(0.196054513)} = -321 \text{ psi} \quad \text{Ans}$$

Straight beam analysis :

$$I = \frac{1}{12}(5)(5^3) - \frac{1}{12}(4)(4^3) = 30.75 \text{ in}^4$$

$$(\sigma_t)_{\max} = (\sigma_c)_{\max} = \frac{Mc}{I} = \frac{350(12)(2.5)}{30.75} = 341 \text{ psi} \quad \text{Ans}$$

From *Mechanics of Materials*, Sixth Edition by R. C. Hibbeler, ISBN 0-13-191345-X.

© 2005 R. C. Hibbeler. Published by Pearson Prentice Hall,

Pearson Education, Inc., Upper Saddle River, NJ. All rights reserved.

This material is protected under all copyright laws as they currently exist. No portion of this material may be reproduced, in any form or by any means, without permission in writing from the publisher.

6-138. While in flight, the curved rib on the jet plane is ^s subjected to an anticipated moment of $M = 16 \text{ N} \cdot \text{m}$ at the section. Determine the maximum bending stress in the rib at this section, and sketch a two-dimensional view of the stress distribution.

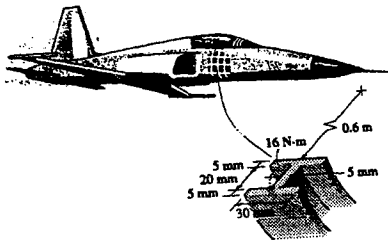

$$\int_A dA/r = (0.03) \ln \frac{0.605}{0.6} + (0.005) \ln \frac{0.625}{0.605} + (0.03) \ln \frac{0.630}{0.625} = 0.650625(10^{-3}) \text{ in.}$$

$$A = 2(0.005)(0.03) + (0.02)(0.005) = 0.4(10^{-3}) \text{ in}^2$$

$$R = \frac{A}{\int_A dA/r} = \frac{0.4(10^{-3})}{0.650625(10^{-3})} = 0.6147933$$

$$(\sigma_c)_{\max} = \frac{M(R - r_c)}{A r_A (\bar{r} - R)} = \frac{16(0.6147933 - 0.630)}{0.4(10^{-3})(0.630)(0.615 - 0.6147933)} = -4.67 \text{ MPa}$$

$$(\sigma_t)_{\max} = \frac{M(R - r_t)}{A r_A (\bar{r} - R)} = \frac{16(0.6147933 - 0.6)}{0.4(10^{-3})(0.6)(0.615 - 0.6147933)} = 4.77 \text{ MPa} \quad \text{Ans}$$

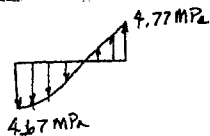

From *Mechanics of Materials*, Sixth Edition by R. C. Hibbeler, ISBN 0-13-191345-X.

© 2005 R. C. Hibbeler. Published by Pearson Prentice Hall,

Pearson Education, Inc., Upper Saddle River, NJ. All rights reserved.

This material is protected under all copyright laws as they currently exist. No portion of this material may be reproduced, in any form or by any means, without permission in writing from the publisher.

6-139 The elbow of the pipe has an outer radius of 0.75 in. and an inner radius of 0.63 in. If the assembly is subjected to the moments of $M = 25 \text{ lb} \cdot \text{in.}$, determine the maximum bending stress developed at section $a-a$.

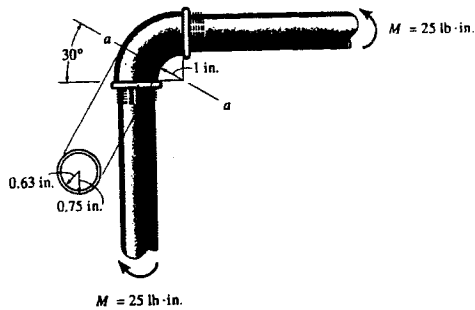

$$\int_A \frac{dA}{r} = \sum 2\pi (\bar{r} - \sqrt{\bar{r}^2 - c^2})$$

$$= 2\pi (1.75 - \sqrt{1.75^2 - 0.75^2}) - 2\pi (1.75 - \sqrt{1.75^2 - 0.63^2})$$

$$= 0.32375809 \text{ in.}$$

$$A = \pi (0.75^2) - \pi (0.63^2) = 0.1656 \pi$$

$$R = \frac{A}{\int_A \frac{dA}{r}} = \frac{0.1656 \pi}{0.32375809} = 1.606902679 \text{ in.}$$

$$\bar{r} - R = 1.75 - 1.606902679 = 0.14309732 \text{ in.}$$

$$(\sigma_{\max})_t = \frac{M(R - r_A)}{Ar_A(\bar{r} - R)} = \frac{25(1.606902679 - 1)}{0.1656 \pi (1)(0.14309732)} = 204 \text{ psi (T) \quad Ans}$$

$$(\sigma_{\max})_c = \frac{M(R - r_B)}{Ar_B(\bar{r} - R)} = \frac{25(1.606902679 - 2.5)}{0.1656 \pi (2.5)(0.14309732)} = 120 \text{ psi (C) \quad Ans}$$

From *Mechanics of Materials*, Sixth Edition by R. C. Hibbeler, ISBN 0-13-191345-X.

© 2005 R. C. Hibbeler. Published by Pearson Prentice Hall,

Pearson Education, Inc., Upper Saddle River, NJ. All rights reserved.

This material is protected under all copyright laws as they currently exist. No portion of this material may be reproduced, in any form or by any means, without permission in writing from the publisher.

*6-140 A 100-mm-diameter circular rod is bent into an S shape. If it is subjected to the applied moments $M = 125 \text{ N} \cdot \text{m}$ at its ends, determine the maximum tensile and compressive stress developed in the rod.

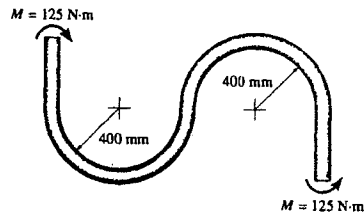

$$\int_A \frac{dA}{r} = 2 \pi (\bar{r} - \sqrt{\bar{r}^2 - c^2})$$

$$= 2 \pi (0.45 - \sqrt{0.45^2 - 0.05^2}) = 0.01750707495 \text{ m}$$

$$A = \pi c^2 = \pi (0.05^2) = 2.5(10^{-3}) \pi \text{ m}^2$$

$$R = \frac{A}{\int_A \frac{dA}{r}} = \frac{2.5(10^{-3})\pi}{0.017507495} = 0.448606818$$

$$\bar{r} - R = 0.45 - 0.448606818 = 1.39318138(10^{-3}) \text{ m}$$

Compressive stress at A and D :

$$\sigma_A = \frac{M(R - r_A)}{A r_A (\bar{r} - R)} = \frac{-125(0.448606818 - 0.4)}{2.5(10^{-3})\pi (0.4)(1.39318138)(10^{-3})} = -1.39 \text{ MPa (max) Ans}$$

$$\sigma_D = \frac{M(R - r_D)}{A r_D (\bar{r} - R)} = \frac{125(0.448606818 - 0.5)}{2.5(10^{-3})\pi (0.5)(1.39318138)(10^{-3})} = -1.17 \text{ MPa}$$

Tensile Stress at B and C :

$$\sigma_B = \frac{M(R - r_B)}{A r_B (\bar{r} - R)} = \frac{-125(0.448606818 - 0.5)}{2.5(10^{-3})\pi (0.5)(1.39318138)(10^{-3})} = 1.17 \text{ MPa}$$

$$\sigma_C = \frac{M(R - r_C)}{A r_C (\bar{r} - R)} = \frac{125(0.448606818 - 0.4)}{2.5(10^{-3})\pi (0.4)(1.39318138)(10^{-3})} = 1.39 \text{ MPa Ans}$$

From *Mechanics of Materials*, Sixth Edition by R. C. Hibbeler, ISBN 0-13-191345-X.

© 2005 R. C. Hibbeler. Published by Pearson Prentice Hall,

Pearson Education, Inc., Upper Saddle River, NJ. All rights reserved.

This material is protected under all copyright laws as they currently exist. No portion of this material may be reproduced, in any form or by any means, without permission in writing from the publisher.

6-141 The member has an elliptical cross section. If it is subjected to a moment of $M = 50 \text{ N} \cdot \text{m}$, determine the bending stress at points A and B . Is the stress at point A' , which is located on the member near the wall, the same as that at A ? Explain.

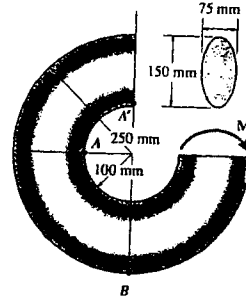

$$\int_A \frac{dA}{r} = \frac{2\pi b'}{a} (\bar{r} - \sqrt{\bar{r}^2 - a^2})$$

$$= \frac{2\pi(0.0375)}{0.075} (0.175 - \sqrt{0.175^2 - 0.075^2}) = 0.053049301 \text{ m}$$

$$A = \pi ab = \pi (0.075)(0.0375) = 2.8125(10^{-3})\pi$$

$$R = \frac{A}{\int_A \frac{dA}{r}} = \frac{2.8125(10^{-3})\pi}{0.053049301} = 0.166556941$$

$$\bar{r} - R = 0.175 - 0.166556941 = 0.0084430586$$

$$\sigma_A = \frac{M(R - r_A)}{Ar_A(\bar{r} - R)} = \frac{50(0.166556941 - 0.1)}{2.8125(10^{-3})\pi (0.1)(0.0084430586)} = 446 \text{ kPa (T)} \quad \text{Ans}$$

$$\sigma_B = \frac{M(R - r_B)}{Ar_B(\bar{r} - R)} = \frac{50(0.166556941 - 0.25)}{2.8125(10^{-3})\pi (0.25)(0.0084430586)} = 224 \text{ kPa (C)} \quad \text{Ans}$$

No, because of localized stress concentration at the wall. **Ans**

From *Mechanics of Materials*, Sixth Edition by R. C. Hibbeler, ISBN 0-13-191345-X.

© 2005 R. C. Hibbeler. Published by Pearson Prentice Hall,

Pearson Education, Inc., Upper Saddle River, NJ. All rights reserved.

This material is protected under all copyright laws as they currently exist. No portion of this material may be reproduced, in any form or by any means, without permission in writing from the publisher.

6-142 The member has an elliptical cross section. If the allowable bending stress is $\sigma_{allow} = 125 \text{ MPa}$, determine the maximum moment M that can be applied to the member.

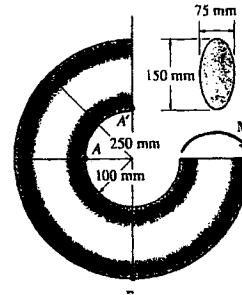

$$a = 0.075 \text{ m}; \quad b = 0.0375 \text{ m}$$

$$A = \pi(0.075)(0.0375) = 0.002825\pi \text{ m}^2$$

$$\int_A \frac{dA}{r} = \frac{2\pi b}{a} (\bar{r} - \sqrt{\bar{r}^2 - a^2}) = \frac{2\pi(0.0375)}{0.075} (0.175 - \sqrt{0.175^2 - 0.075^2}) = 0.053049301 \text{ m}$$

$$R = \frac{A}{\int_A \frac{dA}{r}} = \frac{0.0028125\pi}{0.053049301} = 0.166556941 \text{ m}$$

$$\bar{r} - R = 0.175 - 0.166556941 = 8.4430586(10^{-3}) \text{ m}$$

$$\sigma = \frac{M(R - r)}{Ar(\bar{r} - R)}$$

Assume tension failure.

$$125(10^6) = \frac{M(0.166556941 - 0.1)}{0.0028125\pi(0.1)(8.4430586)(10^{-3})}$$

$$M = 14.0 \text{ kN} \cdot \text{m} \quad (\text{controls}) \quad \mathbf{Ans}$$

Assume compression failure :

$$-125(10^6) = \frac{M(0.166556941 - 0.25)}{0.0028125\pi(0.25)(8.4430586)(10^{-3})}$$

$$M = 27.9 \text{ kN} \cdot \text{m}$$

From *Mechanics of Materials*, Sixth Edition by R. C. Hibbeler, ISBN 0-13-191345-X.

© 2005 R. C. Hibbeler. Published by Pearson Prentice Hall,

Pearson Education, Inc., Upper Saddle River, NJ. All rights reserved.

This material is protected under all copyright laws as they currently exist. No portion of this material may be reproduced, in any form or by any means, without permission in writing from the publisher.

6-143 The bar has a thickness of 0.25 in. and is made of a material having an allowable bending stress of $\sigma_{allow} = 18$ ksi. Determine the maximum moment M that can be applied.

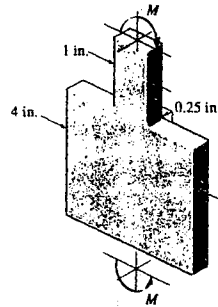

$$\frac{w}{h} = \frac{4}{1} = 4 \qquad \frac{r}{h} = \frac{0.25}{1} = 0.25$$

From Fig. 6-48, $K = 1.45$

$$\sigma_{max} = K \frac{Mc}{I}$$

$$18(10^3) = \frac{1.45(M)(0.5)}{\frac{1}{12}(0.25)(1^3)}$$

$$M = 517 \text{ lb} \cdot \text{in.} = 43.1 \text{ lb} \cdot \text{ft} \quad \text{Ans}$$

From *Mechanics of Materials*, Sixth Edition by R. C. Hibbeler, ISBN 0-13-191345-X.

© 2005 R. C. Hibbeler. Published by Pearson Prentice Hall,

Pearson Education, Inc., Upper Saddle River, NJ. All rights reserved.

This material is protected under all copyright laws as they currently exist. No portion of this material may be reproduced, in any form or by any means, without permission in writing from the publisher.

***6-144.** The bar has a thickness of 0.5 in. and is subjected to a moment of 60 lb · ft. Determine the maximum bending stress in the bar.

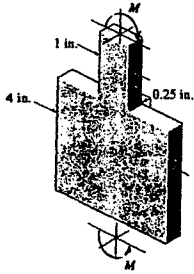

$$\frac{w}{h} = \frac{4}{1} = 4; \quad \frac{r}{h} = \frac{0.25}{1} = 0.25$$

From Fig. 6-48, $K = 1.45$

$$\sigma_{\max} = K \frac{Mc}{I} = 1.45 \left[\frac{60(12)(0.5)}{\frac{1}{12}(0.5)(1)^3} \right] = 12.5 \text{ ksi} \quad \text{Ans}$$

From *Mechanics of Materials*, Sixth Edition by R. C. Hibbeler, ISBN 0-13-191345-X.

© 2005 R. C. Hibbeler. Published by Pearson Prentice Hall,

Pearson Education, Inc., Upper Saddle River, NJ. All rights reserved.

This material is protected under all copyright laws as they currently exist. No portion of this material may be reproduced, in any form or by any means, without permission in writing from the publisher.

6-145 The bar is subjected to a moment of $M = 15 \text{ N} \cdot \text{m}$. Determine the maximum bending stress in the bar and sketch, approximately, how the stress varies over the critical section.

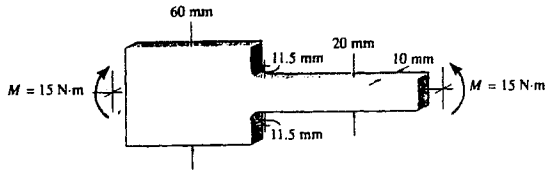

$$\frac{w}{h} = \frac{60}{20} = 3 \quad \frac{r}{h} = \frac{11.5}{20} = 0.575$$

From Fig. 6-48, $K = 1.2$

$$\sigma_{\max} = K \frac{Mc}{I} = 1.2 \left[\frac{(15)(0.01)}{\frac{1}{12}(0.01)(0.02^3)} \right] = 27.0 \text{ MPa} \quad \text{Ans}$$

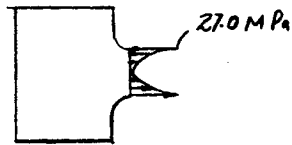

From *Mechanics of Materials*, Sixth Edition by R. C. Hibbeler, ISBN 0-13-191345-X.

© 2005 R. C. Hibbeler. Published by Pearson Prentice Hall,

Pearson Education, Inc., Upper Saddle River, NJ. All rights reserved.

This material is protected under all copyright laws as they currently exist. No portion of this material may be reproduced, in any form or by any means, without permission in writing from the publisher.

6-146 The allowable bending stress for the bar is $\sigma_{\text{allow}} = 175 \text{ MPa}$. Determine the maximum moment M that can be applied to the bar.

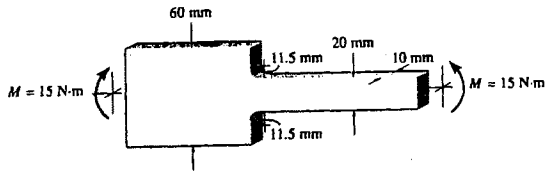

$$\frac{w}{h} = \frac{60}{20} = 3; \quad \frac{r}{h} = \frac{11.5}{20} = 0.575$$

From Fig. 6-48, $K = 1.2$

$$\sigma_{\text{allow}} = K \frac{Mc}{I}; \quad 175(10^6) = 1.2 \left[\frac{M(0.01)}{\frac{1}{12}(0.01)(0.02)^3} \right]$$

$$M = 97.2 \text{ N} \cdot \text{m} \quad \text{Ans}$$

From *Mechanics of Materials*, Sixth Edition by R. C. Hibbeler, ISBN 0-13-191345-X.

© 2005 R. C. Hibbeler. Published by Pearson Prentice Hall,

Pearson Education, Inc., Upper Saddle River, NJ. All rights reserved.

This material is protected under all copyright laws as they currently exist. No portion of this material may be reproduced, in any form or by any means, without permission in writing from the publisher.

6-147 The bar is subjected to four couple moments. If it is in equilibrium, determine the magnitudes of the largest moments M and M' that can be applied without exceeding an allowable bending stress of $\sigma_{\text{allow}} = 22 \text{ ksi}$.

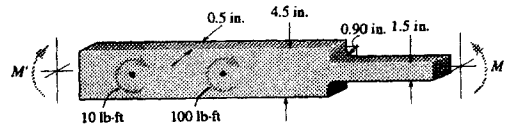

$$\frac{w}{h} = \frac{4.5}{1.5} = 3; \quad \frac{r}{h} = \frac{0.9}{1.5} = 0.6$$

From Fig. 6-48, $K = 1.2$

$$\sigma_{\text{allow}} = K \frac{Mc}{I}; \quad 22(10^3) = 1.2 \left[\frac{M(0.75)}{\frac{1}{12}(0.5)(1.5)^3} \right]$$

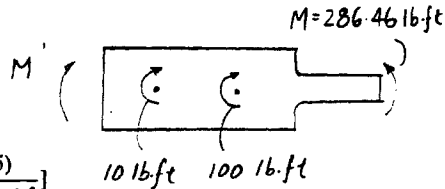

$$M = 3437.5 \text{ lb} \cdot \text{in.} = 286.46 \text{ lb} \cdot \text{ft} = 286 \text{ lb} \cdot \text{ft} \quad \text{Ans}$$

$$\sum M = 0; \quad 286.46 - 10 - 100 - M' = 0; \quad M' = 176 \text{ lb} \cdot \text{ft} \quad \text{Ans}$$

From *Mechanics of Materials*, Sixth Edition by R. C. Hibbeler, ISBN 0-13-191345-X.

© 2005 R. C. Hibbeler. Published by Pearson Prentice Hall,

Pearson Education, Inc., Upper Saddle River, NJ. All rights reserved.

This material is protected under all copyright laws as they currently exist. No portion of this material may be reproduced, in any form or by any means, without permission in writing from the publisher.

*6-148 The bar is subjected to four couple moments. If $M = 180 \text{ lb} \cdot \text{ft}$ and $M' = 70 \text{ lb} \cdot \text{ft}$, determine the maximum bending stress developed in the bar.

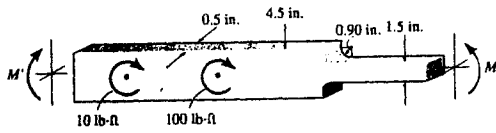

$$\frac{w}{h} = \frac{4.5}{1.5} = 3; \quad \frac{r}{h} = \frac{0.9}{1.5} = 0.6$$

From Fig. 6-48, $K = 1.2$

$$\sigma_{\max} = K \frac{Mc}{I} = 1.2 \left[\frac{180(12)(0.75)}{\frac{1}{12}(0.5)(1.5)^3} \right] = 13.8 \text{ ksi} \quad \text{Ans}$$

From *Mechanics of Materials*, Sixth Edition by R. C. Hibbeler, ISBN 0-13-191345-X.

© 2005 R. C. Hibbeler. Published by Pearson Prentice Hall,

Pearson Education, Inc., Upper Saddle River, NJ. All rights reserved.

This material is protected under all copyright laws as they currently exist. No portion of this material may be reproduced, in any form or by any means, without permission in writing from the publisher.

6-149 Determine the maximum bending stress developed in the bar if it is subjected to the couples shown. The bar has a thickness of 0.25 in.

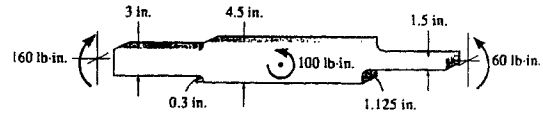

For the larger section :

$$\frac{w}{h} = \frac{4.5}{3} = 1.5; \quad \frac{r}{h} = \frac{0.3}{3} = 0.1$$

From Fig. 6-48, $K = 1.755$

$$\sigma_{\max} = K \frac{Mc}{I} = 1.755 \left[\frac{160(1.5)}{\frac{1}{12}(0.25)(3)^3} \right] = 749 \text{ psi (controls) } \quad \text{Ans}$$

For the smaller section :

$$\frac{w}{h} = \frac{4.5}{1.5} = 3; \quad \frac{r}{h} = \frac{1.125}{1.5} = 0.75$$

From Fig. 6-48, $K = 1.15$

$$\sigma_{\max} = K \frac{Mc}{I} = 1.15 \left[\frac{60(0.75)}{\frac{1}{12}(0.25)(1.5)^3} \right] = 736 \text{ psi}$$

From *Mechanics of Materials*, Sixth Edition by R. C. Hibbeler, ISBN 0-13-191345-X.

© 2005 R. C. Hibbeler. Published by Pearson Prentice Hall,

Pearson Education, Inc., Upper Saddle River, NJ. All rights reserved.

This material is protected under all copyright laws as they currently exist. No portion of this material may be reproduced, in any form or by any means, without permission in writing from the publisher.

6-150 Determine the length L of the center portion of the bar so that the maximum bending stress at A , B , and C is the same. The bar has a thickness of 10 mm.

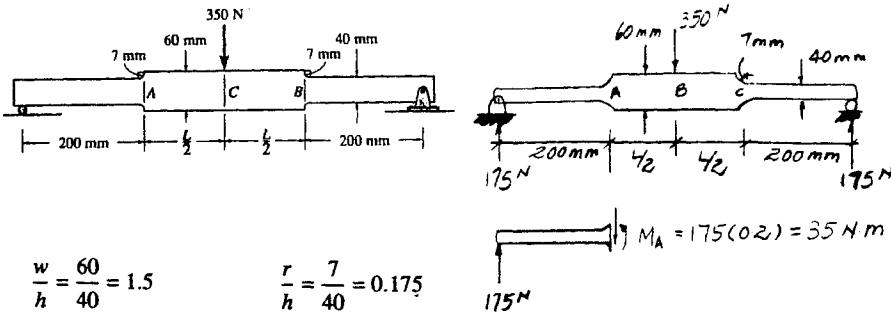

$$\frac{w}{h} = \frac{60}{40} = 1.5 \quad \frac{r}{h} = \frac{7}{40} = 0.175$$

From Fig. 6-48, $K = 1.5$

$$(\sigma_A)_{\max} = K \frac{M_A c}{I} = 1.5 \left[\frac{(35)(0.02)}{\frac{1}{12}(0.01)(0.04^3)} \right] = 19.6875 \text{ MPa}$$

$$(\sigma_B)_{\max} = (\sigma_A)_{\max} = \frac{M_B c}{I}$$

$$19.6875(10^6) = \frac{175(0.2 + \frac{L}{2})(0.03)}{\frac{1}{12}(0.01)(0.06^3)}$$

$$L = 0.95 \text{ m} = 950 \text{ mm} \quad \text{Ans}$$

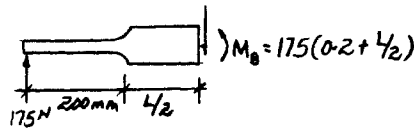

From *Mechanics of Materials*, Sixth Edition by R. C. Hibbeler, ISBN 0-13-191345-X.

© 2005 R. C. Hibbeler. Published by Pearson Prentice Hall,

Pearson Education, Inc., Upper Saddle River, NJ. All rights reserved.

This material is protected under all copyright laws as they currently exist. No portion of this material may be reproduced, in any form or by any means, without permission in writing from the publisher.

6-151. The bar is subjected to a moment of $M = 153 \text{ N}\cdot\text{m}$. Determine the smallest radius r of the fillets so that an allowable bending stress of $\sigma_{\text{allow}} = 120 \text{ MPa}$ is not exceeded.

$$\sigma_{\text{max}} = K \frac{Mc}{I}$$

$$120(10^6) = K \left[\frac{(153)(0.02)}{\frac{1}{12}(0.007)(0.04)^3} \right]$$

$$K = 1.46$$

$$\frac{w}{h} = \frac{60}{40} = 1.5$$

From Fig. 6-48,

$$\frac{r}{h} = 0.2$$

$$r = 0.2(40) = 8.0 \text{ mm} \quad \text{Ans}$$

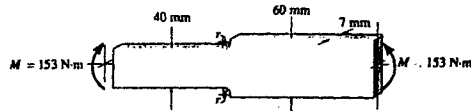

Probs. 6-151/6-152

From *Mechanics of Materials*, Sixth Edition by R. C. Hibbeler, ISBN 0-13-191345-X.

© 2005 R. C. Hibbeler. Published by Pearson Prentice Hall,

Pearson Education, Inc., Upper Saddle River, NJ. All rights reserved.

This material is protected under all copyright laws as they currently exist. No portion of this material may be reproduced, in any form or by any means, without permission in writing from the publisher.

*6-152 The bar is subjected to a moment of $M = 17.5 \text{ N} \cdot \text{m}$. If $r = 6 \text{ mm}$ determine the maximum bending stress in the material.

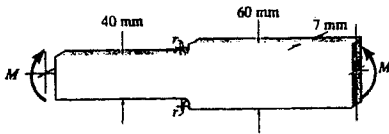

$$\frac{w}{h} = \frac{60}{40} = 1.5; \quad \frac{r}{h} = \frac{6}{40} = 0.15$$

From Fig. 6-48,

$$K = 1.555$$

$$\sigma_{\max} = K \frac{Mc}{I} = 1.555 \left[\frac{17.5(0.02)}{\frac{1}{12}(0.007)(0.04)^3} \right] = 14.6 \text{ MPa} \quad \text{Ans}$$

From *Mechanics of Materials*, Sixth Edition by R. C. Hibbeler, ISBN 0-13-191345-X.

© 2005 R. C. Hibbeler. Published by Pearson Prentice Hall,

Pearson Education, Inc., Upper Saddle River, NJ. All rights reserved.

This material is protected under all copyright laws as they currently exist. No portion of this material may be reproduced, in any form or by any means, without permission in writing from the publisher.

6-153 If the radius of each notch on the plate is $r = 0.5$ in. determine the largest moment that can be applied. The allowable bending stress for the material is $\sigma_{\text{allow}} = 18$ ksi.

$$b = \frac{14.5 - 12.5}{2} = 1.0 \text{ in.}$$

$$\frac{b}{r} = \frac{1}{0.5} = 2.0 \quad \frac{r}{h} = \frac{0.5}{12.5} = 0.04$$

From Fig. 6-50 :

$$K = 2.60$$

$$\sigma_{\text{max}} = K \frac{Mc}{I}$$

$$18(10^3) = 2.60 \left[\frac{(M)(6.25)}{\frac{1}{12}(1)(12.5)^3} \right]$$

$$M = 180\,288 \text{ lb} \cdot \text{in.} = 15.0 \text{ kip} \cdot \text{ft} \quad \text{Ans}$$

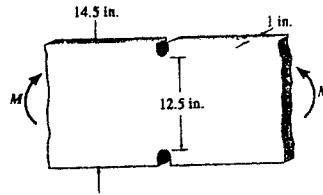

From *Mechanics of Materials*, Sixth Edition by R. C. Hibbeler, ISBN 0-13-191345-X.

© 2005 R. C. Hibbeler. Published by Pearson Prentice Hall,

Pearson Education, Inc., Upper Saddle River, NJ. All rights reserved.

This material is protected under all copyright laws as they currently exist. No portion of this material may be reproduced, in any form or by any means, without permission in writing from the publisher.

6-154 The symmetric notched plate is subjected to bending. If the radius of each notch is $r = 0.5$ in. and the applied moment is $M = 10$ kip · ft, determine the maximum bending stress in the plate.

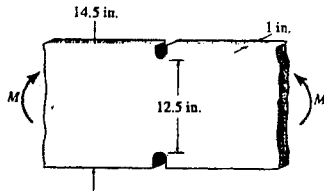

$$\frac{b}{r} = \frac{1}{0.5} = 2.0 \quad \frac{r}{h} = \frac{0.5}{12.5} = 0.04$$

From Fig. 6-50 :

$$K = 2.60$$

$$\sigma_{\max} = K \frac{Mc}{I} = 2.60 \left[\frac{(10)(12)(6.25)}{\frac{1}{12}(1)(12.5)^3} \right] = 12.0 \text{ ksi} \quad \text{Ans}$$

From *Mechanics of Materials*, Sixth Edition by R. C. Hibbeler, ISBN 0-13-191345-X.

© 2005 R. C. Hibbeler. Published by Pearson Prentice Hall,

Pearson Education, Inc., Upper Saddle River, NJ. All rights reserved.

This material is protected under all copyright laws as they currently exist. No portion of this material may be reproduced, in any form or by any means, without permission in writing from the publisher.

6-155 The simply supported notched bar is subjected to two forces P . Determine the largest magnitude of P that can be applied without causing the material to yield. The material is A-36 steel. Each notch has a radius of $r = 0.125$ in.

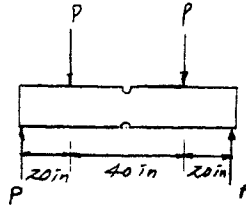
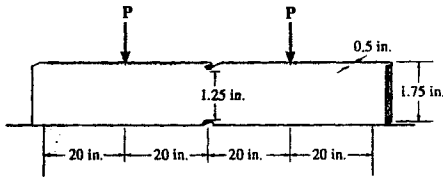

$$b = \frac{1.75 - 1.25}{2} = 0.25$$

$$\frac{b}{r} = \frac{0.25}{0.125} = 2; \quad \frac{r}{h} = \frac{0.125}{1.25} = 0.1$$

From Fig. 6-50, $K = 1.92$

$$\sigma_Y = K \frac{Mc}{I}; \quad 36 = 1.92 \left[\frac{20P(0.625)}{\frac{1}{12}(0.5)(1.25)^3} \right]$$

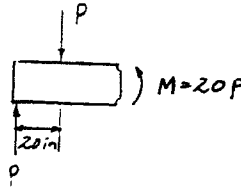

$$P = 122 \text{ lb} \quad \text{Ans}$$

From *Mechanics of Materials*, Sixth Edition by R. C. Hibbeler, ISBN 0-13-191345-X.

© 2005 R. C. Hibbeler. Published by Pearson Prentice Hall,

Pearson Education, Inc., Upper Saddle River, NJ. All rights reserved.

This material is protected under all copyright laws as they currently exist. No portion of this material may be reproduced, in any form or by any means, without permission in writing from the publisher.

*6-156 The simply supported notched bar is subjected to the two loads, each having a magnitude of $P = 100$ lb. Determine the maximum bending stress developed in the bar, and sketch the bending-stress distribution acting over the cross section at the center of the bar. Each notch has a radius of $r = 0.125$ in.

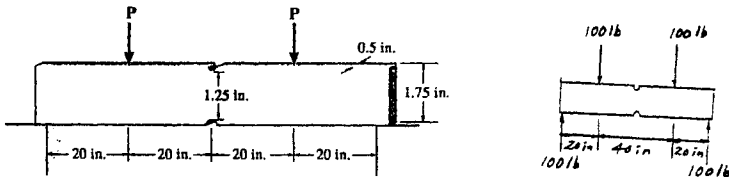

$$b = \frac{1.75 - 1.25}{2} = 0.25$$

$$\frac{b}{r} = \frac{0.25}{0.125} = 2; \quad \frac{r}{h} = \frac{0.125}{1.25} = 0.1$$

From Fig. 6-50, $K = 1.92$

$$\sigma_{\max} = K \frac{Mc}{I} = 1.92 \left[\frac{2000(0.625)}{\frac{1}{12}(0.5)(1.25)^3} \right] = 29.5 \text{ ksi} \quad \text{Ans}$$

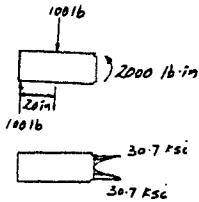

From *Mechanics of Materials*, Sixth Edition by R. C. Hibbeler, ISBN 0-13-191345-X.

© 2005 R. C. Hibbeler. Published by Pearson Prentice Hall,

Pearson Education, Inc., Upper Saddle River, NJ. All rights reserved.

This material is protected under all copyright laws as they currently exist. No portion of this material may be reproduced, in any form or by any means, without permission in writing from the publisher.

6-157 A bar having a width of 3 in. and height of 2 in. is made of an elastic plastic material for which $\sigma_y = 36$ ksi. Determine the moment applied about the horizontal axis that will cause half the bar to yield.

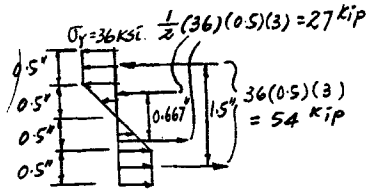

$$M = 54(1.5) + 27(0.667) = 99.0 \text{ kip} \cdot \text{in.} = 8.25 \text{ kip} \cdot \text{ft} \quad \text{Ans}$$

Also;

$$\sigma_y = \frac{M_y c}{I}$$

$$36(10^3) = \frac{M_y(1)}{\frac{1}{12}(3)(2^3)}$$

$$M_y = 72\,000 \text{ lb} \cdot \text{in.}$$

$$M = \frac{3}{2} M_y \left[1 - \frac{4}{3} \left(\frac{y_y^2}{h^2} \right) \right]$$

Half of the bar will yield, $y_y = h/4$

$$M = \frac{11}{8} M_y$$

$$= \frac{11}{8} (72\,000) = 99\,000 \text{ lb} \cdot \text{in.} = 8.25 \text{ kip} \cdot \text{ft} \quad \text{Ans}$$

Note : The above equation is valid only for rectangular sections.

From *Mechanics of Materials*, Sixth Edition by R. C. Hibbeler, ISBN 0-13-191345-X.

© 2005 R. C. Hibbeler. Published by Pearson Prentice Hall,

Pearson Education, Inc., Upper Saddle River, NJ. All rights reserved.

This material is protected under all copyright laws as they currently exist. No portion of this material may be reproduced, in any form or by any means, without permission in writing from the publisher.

6-158 Determine the plastic section modulus and the shape factor for the wide-flange beam.

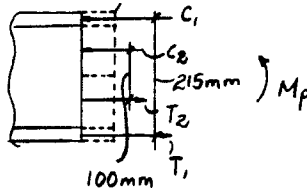
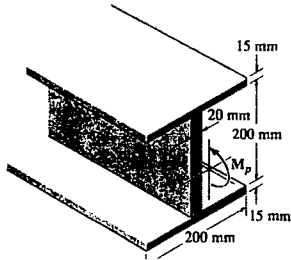

$$I_x = \frac{1}{12}(0.2)(0.23)^3 - \frac{1}{12}(0.18)(0.2)^3 = 82.78333(10^{-6})\text{m}^4$$

$$C_1 = T_1 = \sigma_Y(0.2)(0.015) = 0.003\sigma_Y$$

$$C_2 = T_2 = \sigma_Y(0.1)(0.02) = 0.002\sigma_Y$$

$$M_p = 0.003\sigma_Y(0.215) + 0.002\sigma_Y(0.1) = 0.000845\sigma_Y$$

$$\sigma_Y = \frac{M_p}{Z}$$

$$Z = \frac{0.000845\sigma_Y}{\sigma_Y} = 845(10^{-6})\text{m}^3 \quad \text{Ans}$$

$$\sigma_Y = \frac{M_Y c}{I}$$

$$M_Y = \frac{\sigma_Y(82.78333)10^{-6}}{0.115} = 0.000719855\sigma_Y$$

$$K = \frac{M_p}{M_Y} = \frac{0.000845\sigma_Y}{0.000719855\sigma_Y} = 1.17 \quad \text{Ans}$$

From *Mechanics of Materials*, Sixth Edition by R. C. Hibbeler, ISBN 0-13-191345-X.

© 2005 R. C. Hibbeler. Published by Pearson Prentice Hall,

Pearson Education, Inc., Upper Saddle River, NJ. All rights reserved.

This material is protected under all copyright laws as they currently exist. No portion of this material may be reproduced, in any form or by any means, without permission in writing from the publisher.

6-159 The beam is made of an elastic plastic material for which $\sigma_Y = 250$ MPa. Determine the residual stress in the beam at its top and bottom after the plastic moment M_p is applied and then released.

$$I_x = \frac{1}{12}(0.2)(0.23)^3 - \frac{1}{12}(0.18)(0.2)^3 = 82.78333(10^{-6})\text{m}^4$$

$$C_1 = T_1 = \sigma_Y(0.2)(0.015) = 0.003\sigma_Y$$

$$C_2 = T_2 = \sigma_Y(0.1)(0.02) = 0.002\sigma_Y$$

$$M_p = 0.003\sigma_Y(0.215) + 0.002\sigma_Y(0.1) = 0.000845\sigma_Y$$

$$= 0.000845(250)(10^6) = 211.25 \text{ kN}\cdot\text{m}$$

$$\sigma' = \frac{M_p c}{I} = \frac{211.25(10^3)(0.115)}{82.78333(10^{-6})} = 293.5 \text{ MPa}$$

$$\frac{y}{250} = \frac{0.115}{293.5}; \quad y = 0.09796 \text{ m} = 98.0 \text{ mm}$$

$$\sigma_{\text{top}} = \sigma_{\text{bottom}} = 293.5 - 250 = 43.5 \text{ MPa} \quad \text{Ans}$$

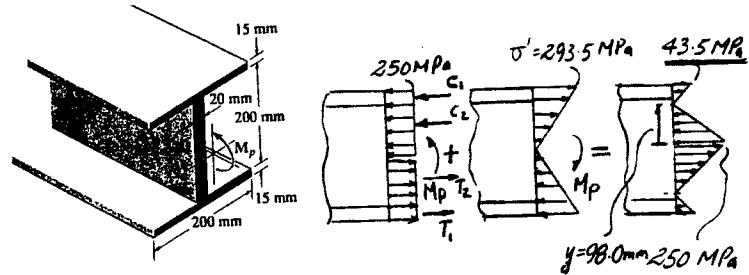

From *Mechanics of Materials*, Sixth Edition by R. C. Hibbeler, ISBN 0-13-191345-X.

© 2005 R. C. Hibbeler. Published by Pearson Prentice Hall,

Pearson Education, Inc., Upper Saddle River, NJ. All rights reserved.

This material is protected under all copyright laws as they currently exist. No portion of this material may be reproduced, in any form or by any means, without permission in writing from the publisher.

***6-160.** Determine the shape factor for the cross section of the H-beam.

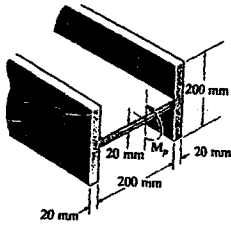

$$I_x = \frac{1}{12}(0.2)(0.02^3) + 2\left(\frac{1}{12}\right)(0.02)(0.2^3) = 26.8(10^{-6})\text{m}^4$$

$$C_1 = T_1 = \sigma_Y(2)(0.09)(0.02) = 0.0036\sigma_Y$$

$$C_2 = T_2 = \sigma_Y(0.01)(0.24) = 0.0024\sigma_Y$$

$$M_p = 0.0036\sigma_Y(0.11) + 0.0024\sigma_Y(0.01) = 0.00042\sigma_Y$$

$$\sigma_Y = \frac{M_Y c}{I}$$

$$M_Y = \frac{\sigma_Y(26.8)(10^{-6})}{0.1} = 0.000268\sigma_Y$$

$$K = \frac{M_p}{M_Y} = \frac{0.00042\sigma_Y}{0.000268\sigma_Y} = 1.57 \quad \text{Ans}$$

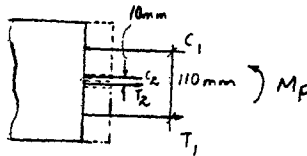

From *Mechanics of Materials*, Sixth Edition by R. C. Hibbeler, ISBN 0-13-191345-X.

© 2005 R. C. Hibbeler. Published by Pearson Prentice Hall,

Pearson Education, Inc., Upper Saddle River, NJ. All rights reserved.

This material is protected under all copyright laws as they currently exist. No portion of this material may be reproduced, in any form or by any means, without permission in writing from the publisher.

6-161. The H-beam is made of an elastic-plastic material for which $\sigma_Y = 250$ MPa. Determine the residual stress in the top and bottom of the beam after the plastic moment M_p is applied and then released.

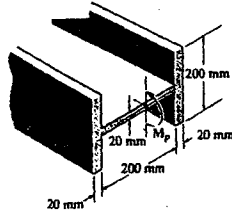

$$I_x = \frac{1}{12}(0.2)(0.02^3) + 2\left(\frac{1}{12}\right)(0.02)(0.2^3) = 26.8(10^{-6})\text{m}^4$$

$$C_1 = T_1 = \sigma_Y(2)(0.09)(0.02) = 0.0036\sigma_Y$$

$$C_2 = T_2 = \sigma_Y(0.01)(0.24) = 0.0024\sigma_Y$$

$$M_p = 0.0036\sigma_Y(0.11) + 0.0024\sigma_Y(0.01) = 0.00042\sigma_Y$$

$$M_p = 0.00042(250)(10^6) = 105 \text{ kN} \cdot \text{m}$$

$$\sigma = \frac{M_p c}{I} = \frac{105(10^3)(0.1)}{26.8(10^{-6})} = 392 \text{ MPa}$$

$$\frac{y}{250} = \frac{0.1}{392}; \quad y = 0.0638 = 63.8 \text{ mm}$$

$$\sigma_T = \sigma_B = 392 - 250 = 142 \text{ MPa} \quad \text{Ans}$$

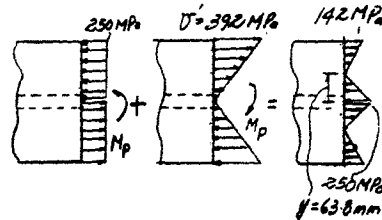
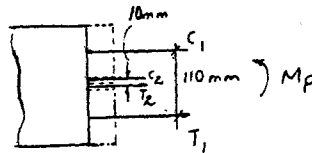

From *Mechanics of Materials*, Sixth Edition by R. C. Hibbeler, ISBN 0-13-191345-X.

© 2005 R. C. Hibbeler. Published by Pearson Prentice Hall,

Pearson Education, Inc., Upper Saddle River, NJ. All rights reserved.

This material is protected under all copyright laws as they currently exist. No portion of this material may be reproduced, in any form or by any means, without permission in writing from the publisher.

6-162 The rod has a circular cross section. If it is made of an elastic plastic material, determine the shape factor and the plastic section modulus Z .

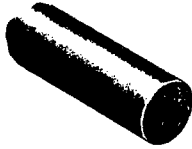

Plastic moment :

$$C = T = \sigma_y \left(\frac{\pi r^2}{2} \right) = \frac{\pi r^2}{2} \sigma_y$$

$$M_p = \frac{\pi r^2}{2} \sigma_y \left(\frac{8r}{3\pi} \right) = \frac{4r^3}{3} \sigma_y$$

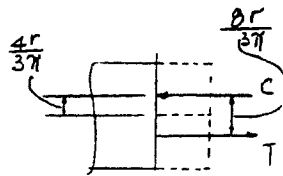

Elastic moment :

$$I = \frac{1}{4} \pi r^4$$

$$M_y = \frac{\sigma_y I}{c} = \frac{\sigma_y \left(\frac{1}{4} \pi r^4 \right)}{r} = \frac{\pi r^3}{4} \sigma_y$$

Shape factor :

$$K = \frac{M_p}{M_y} = \frac{\frac{4r^3}{3} \sigma_y}{\frac{\pi r^3}{4} \sigma_y} = \frac{16}{3\pi} = 1.70 \quad \text{Ans}$$

Plastic section modulus :

$$Z = \frac{M_p}{\sigma_y} = \frac{\frac{4r^3}{3} \sigma_y}{\sigma_y} = \frac{4r^3}{3} \quad \text{Ans}$$

From *Mechanics of Materials*, Sixth Edition by R. C. Hibbeler, ISBN 0-13-191345-X.

© 2005 R. C. Hibbeler. Published by Pearson Prentice Hall,

Pearson Education, Inc., Upper Saddle River, NJ. All rights reserved.

This material is protected under all copyright laws as they currently exist. No portion of this material may be reproduced, in any form or by any means, without permission in writing from the publisher.

6-163 The rod has a circular cross section. If it is made of an elastic plastic material, determine the maximum elastic moment and plastic moment that can be applied to the cross section. Take $r = 3$ in., $\sigma_Y = 36$ ksi.

Elastic moment :

$$I = \frac{1}{4} \pi r^4$$

$$\begin{aligned} M_Y &= \frac{\sigma_Y I}{c} = \frac{\sigma_Y (\frac{1}{4} \pi r^4)}{r} = \frac{\pi r^3}{4} \sigma_Y \\ &= \frac{\pi (3^3)}{4} (36) = 763.4 \text{ kip} \cdot \text{in.} \\ &= 63.6 \text{ kip} \cdot \text{ft} \end{aligned}$$

Ans

Plastic moment :

$$C = T = \sigma_Y \left(\frac{\pi r^2}{2} \right) = \frac{\pi r^2}{2} \sigma_Y$$

$$M_p = \frac{\pi r^2}{2} \sigma_Y \left(\frac{8r}{3\pi} \right) = \frac{4r^3}{3} \sigma_Y = \frac{4}{3} (3^3) (36)$$

$$= 1296 \text{ kip} \cdot \text{in.} = 108 \text{ kip} \cdot \text{ft} \quad \text{Ans}$$

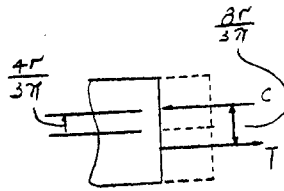

From *Mechanics of Materials*, Sixth Edition by R. C. Hibbeler, ISBN 0-13-191345-X.

© 2005 R. C. Hibbeler. Published by Pearson Prentice Hall,

Pearson Education, Inc., Upper Saddle River, NJ. All rights reserved.

This material is protected under all copyright laws as they currently exist. No portion of this material may be reproduced, in any form or by any means, without permission in writing from the publisher.

*6-164 The T-beam is made of an elastic-plastic material. Determine the maximum elastic moment and the plastic moment that can be applied to the cross section. $\sigma_Y = 36$ ksi.

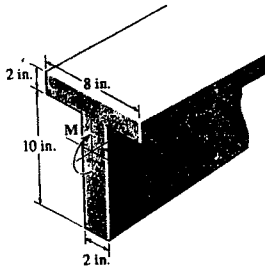

Elastic Analysis :

$$\bar{y} = \frac{8(2)(1) + 10(2)(7)}{8(2) + 10(2)} = 4.333 \text{ in.}$$

$$I = \frac{1}{12}(8)(2^3) + 8(2)(3.3333^2) + \frac{1}{12}(2)(10^3) + 10(2)(2.6667^2) = 492 \text{ in}^4$$

$$\sigma_Y = \frac{Myc}{I}$$

$$M_Y = \frac{492(36)}{7.667} = 2310 \text{ kip} \cdot \text{in.} = 193 \text{ kip} \cdot \text{ft} \quad \text{Ans}$$

Plastic analysis :

$$\int \sigma dA = 0; \quad C_1 + C_2 - T_1 = 0$$

$$36(8)(2) + 36(2)(10-d) - 36(2)(d) = 0$$

$$d = 9 \text{ in.} < 10 \text{ in.} \quad \text{OK}$$

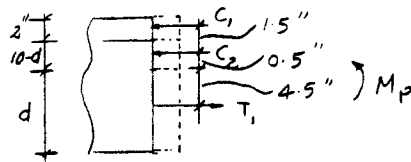

$$M_p = 36(8)(2)(2) + 36(2)(1)(0.5) + 36(2)(9)(4.5)$$

$$= 4104 \text{ kip} \cdot \text{in.} = 342 \text{ kip} \cdot \text{ft} \quad \text{Ans}$$

From *Mechanics of Materials*, Sixth Edition by R. C. Hibbeler, ISBN 0-13-191345-X.

© 2005 R. C. Hibbeler. Published by Pearson Prentice Hall,

Pearson Education, Inc., Upper Saddle River, NJ. All rights reserved.

This material is protected under all copyright laws as they currently exist. No portion of this material may be reproduced, in any form or by any means, without permission in writing from the publisher.

6-165 Determine the plastic section modulus and the shape factor for the beam.

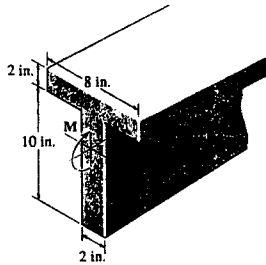

Elastic Analysis :

$$\bar{y} = \frac{8(2)(1) + 10(2)(7)}{8(2) + 10(2)} = 4.333 \text{ in.}$$

$$I = \frac{1}{12}(8)(2^3) + 8(2)(3.3333^2) + \frac{1}{12}(2)(10^3) + 10(2)(2.6667^2) = 492 \text{ in}^4$$

$$\sigma_Y = \frac{M_Y c}{I}$$

$$M_Y = \frac{492(36)}{7.667} = 2310 \text{ kip} \cdot \text{in.}$$

Plastic analysis :

$$\int \sigma dA = 0; \quad C_1 + C_2 - T_1 = 0$$

$$36(8)(2) + 36(2)(10-d) - 36(2)(d) = 0$$

$$d = 9 \text{ in.} < 10 \text{ in.} \quad \text{OK}$$

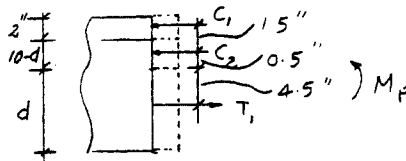

$$M_p = 36(8)(2)(2) + 36(2)(1)(0.5) + 36(2)(9)(4.5)$$

$$= 4104 \text{ kip} \cdot \text{in.}$$

$$\sigma_Y = \frac{M_p}{Z}$$

$$Z = \frac{M_p}{\sigma_Y} = \frac{4104}{36} = 114 \text{ in}^3 \quad \text{Ans}$$

$$K = \frac{M_p}{M_Y}$$

$$K = \frac{4104}{2310} = 1.78 \quad \text{Ans}$$

From *Mechanics of Materials*, Sixth Edition by R. C. Hibbeler, ISBN 0-13-191345-X.

© 2005 R. C. Hibbeler. Published by Pearson Prentice Hall,

Pearson Education, Inc., Upper Saddle River, NJ. All rights reserved.

This material is protected under all copyright laws as they currently exist. No portion of this material may be reproduced, in any form or by any means, without permission in writing from the publisher.

6-166 Determine the plastic section modulus and the shape factor for the cross section of the beam.

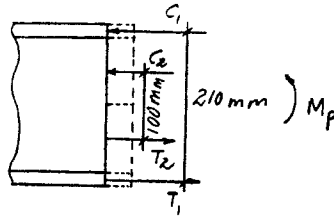
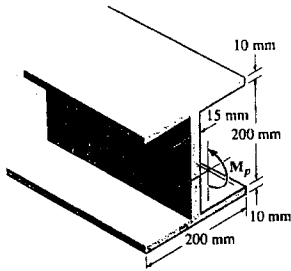

$$I = \frac{1}{12}(0.2)(0.22)^3 - \frac{1}{12}(0.185)(0.2)^3 = 54.133(10^{-6}) \text{ m}^4$$

$$C_1 = \sigma_Y(0.01)(0.2) = (0.002)\sigma_Y$$

$$C_2 = \sigma_Y(0.1)(0.015) = (0.0015)\sigma_Y$$

$$M_p = 0.002\sigma_Y(0.21) + 0.0015\sigma_Y(0.1) = 0.00057\sigma_Y$$

$$\sigma_Y = \frac{M_p}{Z}$$

$$Z = \frac{0.00057\sigma_Y}{\sigma_Y} = 570(10^{-6}) \text{ m}^3 \quad \text{Ans}$$

$$\sigma_Y = \frac{M_Y c}{I}$$

$$M_Y = \frac{\sigma_Y(54.133)(10^{-6})}{0.11} = 0.0005\sigma_Y$$

$$K = \frac{M_p}{M_Y} = \frac{0.0006\sigma_Y}{0.0005\sigma_Y} = 1.16 \quad \text{Ans}$$

From *Mechanics of Materials*, Sixth Edition by R. C. Hibbeler, ISBN 0-13-191345-X.

© 2005 R. C. Hibbeler. Published by Pearson Prentice Hall,

Pearson Education, Inc., Upper Saddle River, NJ. All rights reserved.

This material is protected under all copyright laws as they currently exist. No portion of this material may be reproduced, in any form or by any means, without permission in writing from the publisher.

6-167. Determine the plastic moment M_p that can be supported by a beam having the cross section shown. $\sigma_Y = 30$ ksi.

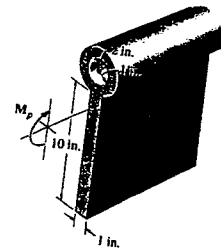

$$\int \sigma dA = 0$$

$$C_1 + C_2 - T_1 = 0$$

$$\pi(2^2 - 1^2)(30) + (10 - d)(1)(30) - d(1)(30) = 0$$

$$3\pi + 10 - 2d = 0$$

$$d = 9.7124 \text{ in.} < 10 \text{ in.} \quad \text{OK}$$

$$M_p = \pi(2^2 - 1^2)(30)(2.2876)$$

$$+ (0.2876)(1)(30)(0.1438)$$

$$+ (9.7124)(1)(30)(4.8562)$$

$$= 2063 \text{ kip} \cdot \text{in.}$$

$$= 172 \text{ kip} \cdot \text{ft} \quad \text{Ans}$$

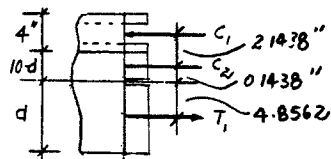

From *Mechanics of Materials*, Sixth Edition by R. C. Hibbeler, ISBN 0-13-191345-X.

© 2005 R. C. Hibbeler. Published by Pearson Prentice Hall,

Pearson Education, Inc., Upper Saddle River, NJ. All rights reserved.

This material is protected under all copyright laws as they currently exist. No portion of this material may be reproduced, in any form or by any means, without permission in writing from the publisher.

*6-168 The thick-walled tube is made from an elastic-plastic material. Determine the shape factor and the plastic section modulus Z .

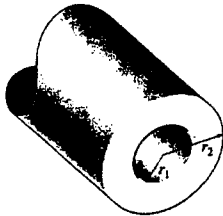

Plastic analysis :

Location of centroid C ,

$$\bar{y} = \frac{\sum \bar{y} A}{\sum A} = \frac{\frac{4r_2}{3\pi}(\frac{\pi}{2}r_2^2) - \frac{4r_1}{3\pi}(\frac{\pi}{2}r_1^2)}{\frac{\pi}{2}(r_2^2 - r_1^2)} = \frac{4(r_2^3 - r_1^3)}{3\pi(r_2^2 - r_1^2)}$$

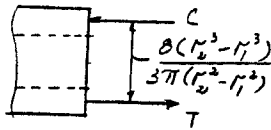

$$T = C = \frac{\pi}{2}(r_2^2 - r_1^2)\sigma_Y$$

$$M_p = \frac{\pi}{2}(r_2^2 - r_1^2)\sigma_Y \left[\frac{8(r_2^3 - r_1^3)}{3\pi(r_2^2 - r_1^2)} \right] = \frac{4}{3}(r_2^3 - r_1^3)\sigma_Y$$

Elastic analysis :

$$I = \frac{\pi}{4}(r_2^4 - r_1^4)$$

$$M_Y = \frac{\sigma_Y I}{c} = \frac{\frac{\pi}{4}(r_2^4 - r_1^4)}{r_2} \sigma_Y = \frac{\pi(r_2^4 - r_1^4)}{4r_2} \sigma_Y$$

Shape factor :

$$K = \frac{M_p}{M_Y} = \frac{\frac{4}{3}(r_2^3 - r_1^3)\sigma_Y}{\frac{\pi(r_2^4 - r_1^4)}{4r_2}\sigma_Y} = \frac{16r_2(r_2^3 - r_1^3)}{3\pi(r_2^4 - r_1^4)} \quad \text{Ans}$$

Plastic section modulus :

$$Z = \frac{M_p}{\sigma_Y} = \frac{\frac{4}{3}(r_2^3 - r_1^3)\sigma_Y}{\sigma_Y} = \frac{4}{3}(r_2^3 - r_1^3) \quad \text{Ans}$$

From *Mechanics of Materials*, Sixth Edition by R. C. Hibbeler, ISBN 0-13-191345-X.

© 2005 R. C. Hibbeler. Published by Pearson Prentice Hall,

Pearson Education, Inc., Upper Saddle River, NJ. All rights reserved.

This material is protected under all copyright laws as they currently exist. No portion of this material may be reproduced, in any form or by any means, without permission in writing from the publisher.

6-169 Determine the shape factor and the plastic section modulus for the member.

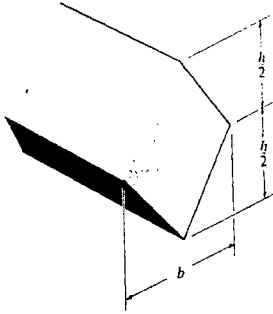

Plastic analysis :

$$T = C = \frac{1}{2}(b)\left(\frac{h}{2}\right)\sigma_Y = \frac{bh}{4}\sigma_Y$$

$$M_p = \frac{bh}{4}\sigma_Y\left(\frac{h}{3}\right) = \frac{bh^2}{12}\sigma_Y$$

Elastic analysis :

$$I = 2\left[\frac{1}{12}(b)\left(\frac{h}{2}\right)^3\right] = \frac{bh^3}{48}$$

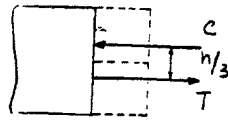

$$M_Y = \frac{\sigma_Y I}{c} = \frac{\sigma_Y \left(\frac{bh^3}{48}\right)}{\frac{h}{2}} = \frac{bh^2}{24}\sigma_Y$$

Shape factor :

$$K = \frac{M_p}{M_Y} = \frac{\frac{bh^2}{12}\sigma_Y}{\frac{bh^2}{24}\sigma_Y} = 2 \quad \text{Ans}$$

Plastic section modulus :

$$Z = \frac{M_p}{\sigma_Y} = \frac{\frac{bh^2}{12}\sigma_Y}{\sigma_Y} = \frac{bh^2}{12} \quad \text{Ans}$$

From *Mechanics of Materials*, Sixth Edition by R. C. Hibbeler, ISBN 0-13-191345-X.

© 2005 R. C. Hibbeler. Published by Pearson Prentice Hall,

Pearson Education, Inc., Upper Saddle River, NJ. All rights reserved.

This material is protected under all copyright laws as they currently exist. No portion of this material may be reproduced, in any form or by any means, without permission in writing from the publisher.

6-170 The member is made from an elastic-plastic material. Determine the maximum elastic moment and the plastic moment that can be applied to the cross section. Take $b = 4$ in., $h = 6$ in., $\sigma_Y = 36$ ksi.

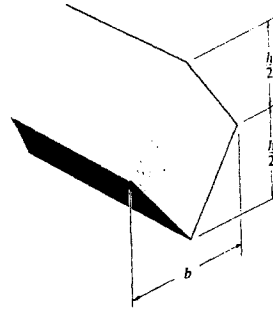

Elastic analysis :

$$I = 2\left[\frac{1}{12}(4)(3)^3\right] = 18 \text{ in}^4$$

$$M_Y = \frac{\sigma_Y I}{c} = \frac{36(18)}{3} = 216 \text{ kip} \cdot \text{in.} = 18 \text{ kip} \cdot \text{ft} \quad \text{Ans}$$

Plastic analysis :

$$T = C = \frac{1}{2}(4)(3)(36) = 216 \text{ kip}$$

$$M_p = 216\left(\frac{6}{3}\right) = 432 \text{ kip} \cdot \text{in.} = 36 \text{ kip} \cdot \text{ft} \quad \text{Ans}$$

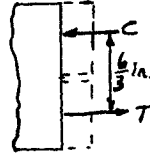

From *Mechanics of Materials*, Sixth Edition by R. C. Hibbeler, ISBN 0-13-191345-X.

© 2005 R. C. Hibbeler. Published by Pearson Prentice Hall,

Pearson Education, Inc., Upper Saddle River, NJ. All rights reserved.

This material is protected under all copyright laws as they currently exist. No portion of this material may be reproduced, in any form or by any means, without permission in writing from the publisher.

6-171 The wide-flange member is made from an elastic-plastic material. Determine the shape factor and the plastic section modulus Z .

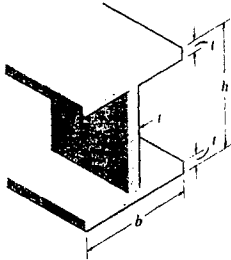

Plastic analysis :

$$T_1 = C_1 = \sigma_Y b t; \quad T_2 = C_2 = \sigma_Y \left(\frac{h-2t}{2}\right) t$$

$$M_p = \sigma_Y b t (h-t) + \sigma_Y \left(\frac{h-2t}{2}\right) t \left(\frac{h-2t}{2}\right) \\ = \sigma_Y \left[b t (h-t) + \frac{t}{4} (h-2t)^2 \right]$$

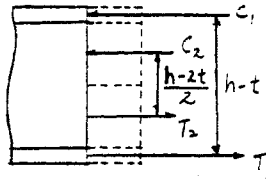

Elastic analysis :

$$I = \frac{1}{12} b h^3 - \frac{1}{12} (b-t)(h-2t)^3 \\ = \frac{1}{12} [b h^3 - (b-t)(h-2t)^3]$$

$$M_Y = \frac{\sigma_Y I}{c} = \frac{\sigma_Y \left(\frac{1}{12}\right) [b h^3 - (b-t)(h-2t)^3]}{\frac{h}{2}} \\ = \frac{b h^3 - (b-t)(h-2t)^3}{6 h} \sigma_Y$$

Shape factor :

$$K = \frac{M_p}{M_Y} = \frac{[b t (h-t) + \frac{t}{4} (h-2t)^2] \sigma_Y}{\frac{b h^3 - (b-t)(h-2t)^3}{6 h} \sigma_Y} \\ = \frac{3h}{2} \left[\frac{4b t (h-t) + t (h-2t)^2}{b h^3 - (b-t)(h-2t)^3} \right] \quad \text{Ans}$$

Plastic section modulus :

$$Z = \frac{M_p}{\sigma_Y} = \frac{\sigma_Y [b t (h-t) + \frac{t}{4} (h-2t)^2]}{\sigma_Y} \\ = b t (h-t) + \frac{t}{4} (h-2t)^2 \quad \text{Ans}$$

From *Mechanics of Materials*, Sixth Edition by R. C. Hibbeler, ISBN 0-13-191345-X.

© 2005 R. C. Hibbeler. Published by Pearson Prentice Hall,

Pearson Education, Inc., Upper Saddle River, NJ. All rights reserved.

This material is protected under all copyright laws as they currently exist. No portion of this material may be reproduced, in any form or by any means, without permission in writing from the publisher.

*6-172 The beam is made of an elastic-plastic material for which $\sigma_y = 200$ MPa. If the largest moment in the beam occurs within the center section $a-a$, determine the magnitude of each force P that causes this moment to be (a) the largest elastic moment and (b) the largest plastic moment.

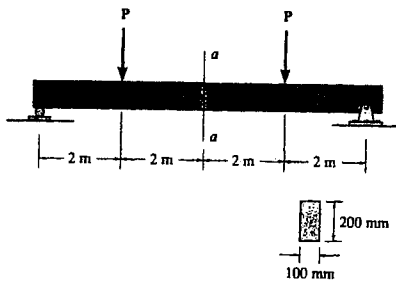

$$M = 2P \quad (1)$$

a) Elastic moment

$$I = \frac{1}{12}(0.1)(0.2^3) = 66.667(10^{-6}) \text{ m}^4$$

$$\sigma_y = \frac{M_y c}{I}$$

$$M_y = \frac{200(10^6)(66.667)(10^{-6})}{0.1}$$

$$= 133.33 \text{ kN} \cdot \text{m}$$

From Eq. (1)

$$133.33 = 2P$$

$$P = 66.7 \text{ kN} \quad \text{Ans}$$

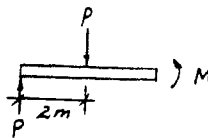
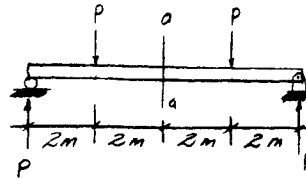

b) Plastic moment

$$M_p = \frac{b h^2}{4} \sigma_y$$

$$= \frac{0.1(0.2^2)}{4}(200)(10^6)$$

$$= 200 \text{ kN} \cdot \text{m}$$

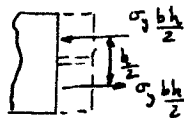

From Eq. (1)

$$200 = 2P$$

$$P = 100 \text{ kN} \quad \text{Ans}$$

From *Mechanics of Materials*, Sixth Edition by R. C. Hibbeler, ISBN 0-13-191345-X.

© 2005 R. C. Hibbeler. Published by Pearson Prentice Hall,

Pearson Education, Inc., Upper Saddle River, NJ. All rights reserved.

This material is protected under all copyright laws as they currently exist. No portion of this material may be reproduced, in any form or by any means, without permission in writing from the publisher.

6-173. The beam is made from an elastic-plastic material for which $\sigma_Y = 200$ MPa. Determine the magnitude of force P that causes this moment to be (a) the largest elastic moment and (b) the largest plastic moment.

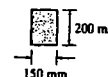
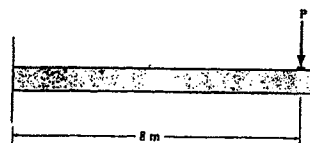

a) Elastic analysis :

$$M_Y = \frac{\sigma_Y I}{c} = \frac{200(10^6) \left(\frac{1}{12}\right)(0.15)(0.2^3)}{0.1} = 200 \text{ kN} \cdot \text{m}$$

$$M = 8P = 200; \quad P = 25.0 \text{ kN} \quad \text{Ans}$$

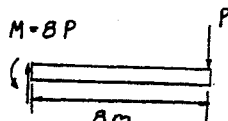

b) Plastic analysis :

$$T = C = 200(10^6)(0.15)(0.1) = 3000 \text{ kN}$$

$$M_p = 3000(0.1) = 300 \text{ kN} \cdot \text{m}$$

$$M = 8P = 300; \quad P = 37.5 \text{ kN} \quad \text{Ans}$$

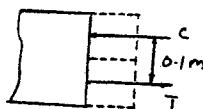

From *Mechanics of Materials*, Sixth Edition by R. C. Hibbeler, ISBN 0-13-191345-X.

© 2005 R. C. Hibbeler. Published by Pearson Prentice Hall,

Pearson Education, Inc., Upper Saddle River, NJ. All rights reserved.

This material is protected under all copyright laws as they currently exist. No portion of this material may be reproduced, in any form or by any means, without permission in writing from the publisher.

6-174. The box beam is made from an elastic-plastic material for which $\sigma_Y = 25$ ksi. Determine the intensity of the distributed load w_0 that will cause the moment to be (a) the largest elastic moment and (b) the largest plastic moment.

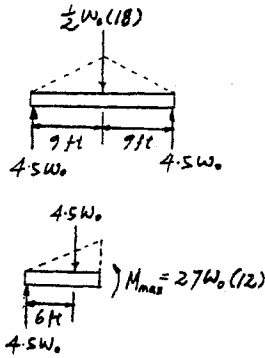
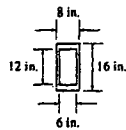
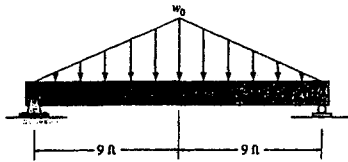

Elastic analysis :

$$I = \frac{1}{12}(8)(16^3) - \frac{1}{12}(6)(12^3) = 1866.67 \text{ in}^4$$

$$M_{\max} = \frac{\sigma_Y I}{c}; \quad 27w_0(12) = \frac{25(1866.67)}{8}$$

$$w_0 = 18.0 \text{ kip/ft} \quad \text{Ans}$$

Plastic analysis :

$$C_1 = T_1 = 25(8)(2) = 400 \text{ kip}$$

$$C_2 = T_2 = 25(6)(2) = 300 \text{ kip}$$

$$M_p = 400(14) + 300(6) = 7400 \text{ kip} \cdot \text{in.}$$

$$27w_0(12) = 7400$$

$$w_0 = 22.8 \text{ kip/ft} \quad \text{Ans}$$

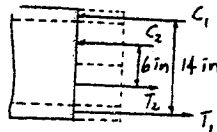

From *Mechanics of Materials*, Sixth Edition by R. C. Hibbeler, ISBN 0-13-191345-X.

© 2005 R. C. Hibbeler. Published by Pearson Prentice Hall,

Pearson Education, Inc., Upper Saddle River, NJ. All rights reserved.

This material is protected under all copyright laws as they currently exist. No portion of this material may be reproduced, in any form or by any means, without permission in writing from the publisher.

6-175 The beam is made of an elastic plastic material for which $\sigma_y = 30$ ksi. If the largest moment in the beam occurs at the center section $a-a$, determine the intensity of the distributed load w that causes this moment to be (a) the largest elastic moment and (b) the largest plastic moment.

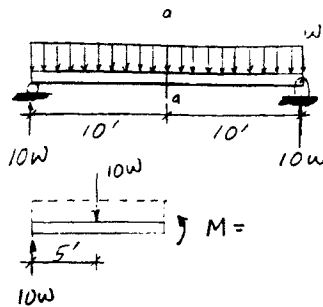
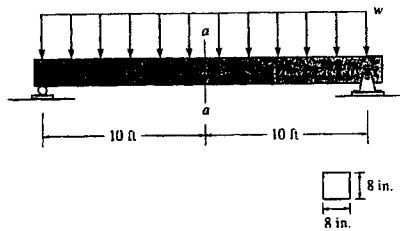

$$M = 50w \quad (1)$$

a) Elastic moment

$$I = \frac{1}{12}(8)(8^3) = 341.33 \text{ in}^4$$

$$\sigma_y = \frac{M_y c}{I}$$

$$M_y = \frac{30(341.33)}{4}$$

$$= 2560 \text{ kip} \cdot \text{in.} = 213.33 \text{ kip} \cdot \text{ft}$$

From Eq. (1),

$$213.33 = 50w$$

$$w = 4.27 \text{ kip/ft} \quad \text{Ans}$$

b) Plastic moment

$$C = T = 30(8)(4) = 960 \text{ kip}$$

$$M_p = 960(4) = 3840 \text{ kip} \cdot \text{in.} = 320 \text{ kip} \cdot \text{ft}$$



From Eq. (1)

$$320 = 50w$$

$$w = 6.40 \text{ kip/ft} \quad \text{Ans}$$

From *Mechanics of Materials*, Sixth Edition by R. C. Hibbeler, ISBN 0-13-191345-X.

© 2005 R. C. Hibbeler. Published by Pearson Prentice Hall,

Pearson Education, Inc., Upper Saddle River, NJ. All rights reserved.

This material is protected under all copyright laws as they currently exist. No portion of this material may be reproduced, in any form or by any means, without permission in writing from the publisher.

*6-176 The beam has a rectangular cross section and is made of an elastic-plastic material having a stress strain diagram as shown. Determine the magnitude of the moment **M** that must be applied to the beam in order to create a maximum strain in its outer fibers of $\epsilon_{max} = 0.008$.

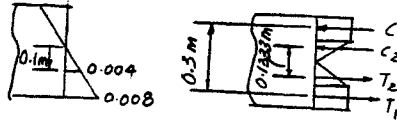
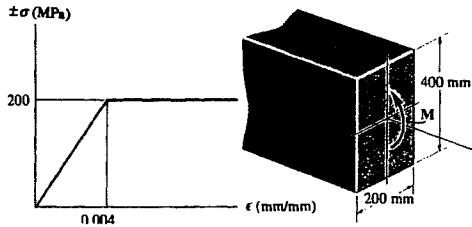

$$C_1 = T_1 = 200(10^6)(0.1)(0.2) = 4000 \text{ kN}$$

$$C_2 = T_2 = \frac{1}{2}(200)(10^6)(0.1)(0.2) = 2000 \text{ kN}$$

$$M = 4000(0.3) + 2000(0.1333) = 1467 \text{ kN} \cdot \text{m} = 14.7 \text{ MN} \cdot \text{m} \quad \text{Ans}$$

From *Mechanics of Materials*, Sixth Edition by R. C. Hibbeler, ISBN 0-13-191345-X.

© 2005 R. C. Hibbeler. Published by Pearson Prentice Hall,

Pearson Education, Inc., Upper Saddle River, NJ. All rights reserved.

This material is protected under all copyright laws as they currently exist. No portion of this material may be reproduced, in any form or by any means, without permission in writing from the publisher.

6-177 A beam is made from polypropylene plastic and has a stress-strain diagram that can be approximated by the curve shown. If the beam is subjected to a maximum tensile and compressive strain of $\epsilon = 0.02$ mm/mm, determine the maximum moment M .

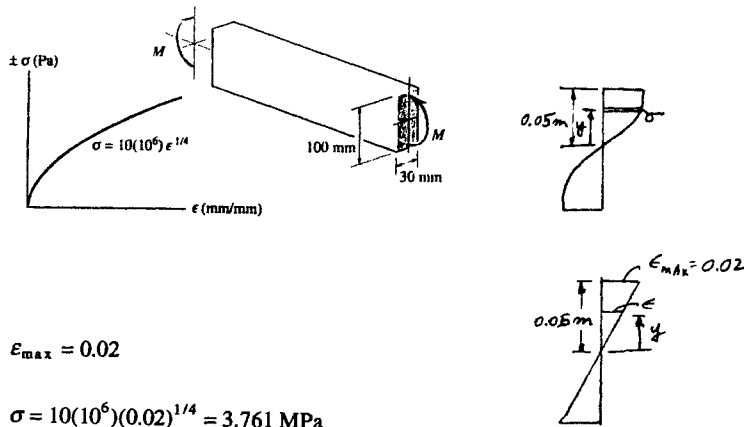

$$\epsilon_{max} = 0.02$$

$$\sigma = 10(10^6)(0.02)^{1/4} = 3.761 \text{ MPa}$$

$$\frac{0.02}{0.05} = \frac{\epsilon}{y}$$

$$\epsilon = 0.4 y$$

$$\sigma = 10(10^6)(0.4)^{1/4} y^{1/4}$$

$$\sigma = 7.9527(10^6) y^{1/4}$$

$$M = \int_A y \sigma dA = 2 \int_0^{0.05} y (7.9527)(10^6) y^{1/4} (0.03) dy$$

$$M = 0.47716(10^6) \int_0^{0.05} y^{5/4} dy = 0.47716(10^6) \left(\frac{4}{5}\right) (0.05)^{5/4}$$

$$M = 9.03 \text{ kN} \cdot \text{m} \quad \text{Ans}$$

From *Mechanics of Materials*, Sixth Edition by R. C. Hibbeler, ISBN 0-13-191345-X.

© 2005 R. C. Hibbeler. Published by Pearson Prentice Hall,

Pearson Education, Inc., Upper Saddle River, NJ. All rights reserved.

This material is protected under all copyright laws as they currently exist. No portion of this material may be reproduced, in any form or by any means, without permission in writing from the publisher.

6-178 The bar is made of an aluminum alloy having a stress-strain diagram that can be approximated by the straight line segments shown. Assuming that this diagram is the same for both tension and compression, determine the moment the bar will support if the maximum strain at the top and bottom fibers of the beam is $\epsilon_{max} = 0.03$.

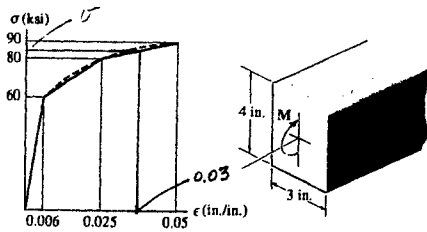

$$\frac{\sigma - 80}{0.03 - 0.025} = \frac{90 - 80}{0.05 - 0.025}; \quad \sigma = 82 \text{ ksi}$$

$$C_1 = T_1 = \frac{1}{2}(0.3333)(80 + 82)(3) = 81 \text{ kip}$$

$$C_2 = T_2 = \frac{1}{2}(1.2666)(60 + 80)(3) = 266 \text{ kip}$$

$$C_3 = T_3 = \frac{1}{2}(0.4)(60)(3) = 36 \text{ kip}$$

$$M = 81(3.6680) + 266(2.1270) + 36(0.5333) \\ = 882.09 \text{ kip} \cdot \text{in.} = 73.5 \text{ kip} \cdot \text{ft}$$

Ans

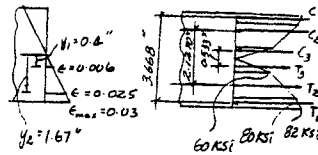

Note : The centroid of a trapezoidal area was used in calculation of moment areas.

From *Mechanics of Materials*, Sixth Edition by R. C. Hibbeler, ISBN 0-13-191345-X.

© 2005 R. C. Hibbeler. Published by Pearson Prentice Hall,

Pearson Education, Inc., Upper Saddle River, NJ. All rights reserved.

This material is protected under all copyright laws as they currently exist. No portion of this material may be reproduced, in any form or by any means, without permission in writing from the publisher.

6-179 The bar is made of an aluminum alloy having a stress-strain diagram that can be approximated by the straight line segments shown. Assuming that this diagram is the same for both tension and compression, determine the moment the bar will support if the maximum strain at the top and bottom fibers of the beam is $\epsilon_{\max} = 0.05$.

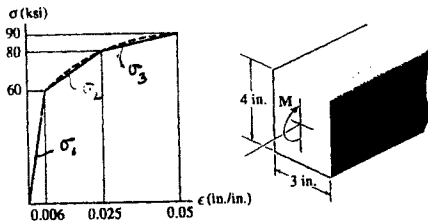

$$\sigma_1 = \frac{60}{0.006} \epsilon = 10(10^3) \epsilon$$

$$\frac{\sigma_2 - 60}{\epsilon - 0.006} = \frac{80 - 60}{0.025 - 0.006}$$

$$\sigma_2 = 1052.63 \epsilon + 53.684$$

$$\frac{\sigma_3 - 80}{\epsilon - 0.025} = \frac{90 - 80}{0.05 - 0.025}; \quad \sigma_3 = 400 \epsilon + 70$$

$$\epsilon = \frac{0.05}{2} (y) = 0.025y$$

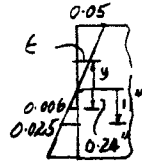

Substitute ϵ into σ expression :

$$\sigma_1 = 250y \quad 0 \leq y < 0.24 \text{ in.}$$

$$\sigma_2 = 26.315y + 53.684 \quad 0.24 < y < 1 \text{ in.}$$

$$\sigma_3 = 10y + 70 \quad 1 \text{ in.} < y \leq 2 \text{ in.}$$

$$dM = y \sigma dA = y \sigma (3 dy)$$

$$M = 2 \left[3 \int_0^{0.24} 250y^2 dy + 3 \int_{0.24}^1 (26.315y^2 + 53.684y) dy + 3 \int_1^2 (10y^2 + 70y) dy \right]$$

$$= 980.588 \text{ kip} \cdot \text{in.} = 81.7 \text{ kip} \cdot \text{ft} \quad \text{Ans}$$

Also, the solution can be obtained from stress blocks as in Prob . 6-178.

From *Mechanics of Materials*, Sixth Edition by R. C. Hibbeler, ISBN 0-13-191345-X.

© 2005 R. C. Hibbeler. Published by Pearson Prentice Hall,

Pearson Education, Inc., Upper Saddle River, NJ. All rights reserved.

This material is protected under all copyright laws as they currently exist. No portion of this material may be reproduced, in any form or by any means, without permission in writing from the publisher.

*6-180 A member is made of a polymer having the stress-strain diagram shown. If the curve can be represented by the equation $\sigma = 4.65(10^3) \epsilon^{1.35}$ ksi, determine the magnitude of the moment M that can be applied without causing the maximum strain in the member to exceed $\epsilon_{max} = 0.005$ in./in.

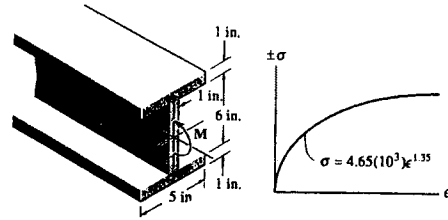

From the strain diagram :

$$\frac{\epsilon}{y} = \frac{0.005}{4}; \quad \epsilon = 0.00125 y$$

Substitute $\epsilon = 0.00125 y$ into σ expression

$$\sigma = 4.65(10^3)(0.00125 y)^{1.35} = 0.56012 y^{1.35}$$

$$dM = (\sigma dA)y = \sigma by dy = 0.56012b y^{2.35} dy$$

$$M = 2[0.56012(1) \int_0^3 y^{2.35} dy + 0.56012(5) \int_3^4 y^{2.35} dy]$$

$$= 120.79 \text{ kip} \cdot \text{in.} = 10.1 \text{ kip} \cdot \text{ft} \quad \text{Ans}$$

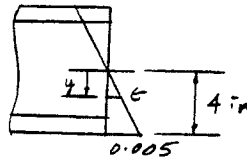

From *Mechanics of Materials*, Sixth Edition by R. C. Hibbeler, ISBN 0-13-191345-X.

© 2005 R. C. Hibbeler. Published by Pearson Prentice Hall,

Pearson Education, Inc., Upper Saddle River, NJ. All rights reserved.

This material is protected under all copyright laws as they currently exist. No portion of this material may be reproduced, in any form or by any means, without permission in writing from the publisher.

6-181 A material has a stress-strain diagram such that within the elastic range the tensile or compressive stress can be related to the tensile or compressive strain by the equation $\sigma^n = K\epsilon$, where K and n are constants. If the material is subjected to a bending moment M , derive an expression between the maximum stress in the material and the moment. The cross section has a moment of inertia of I about its neutral axis.

$$\sigma^n = k\epsilon$$

Due to symmetry, $T = C$

$$\epsilon = \frac{y}{C} \epsilon_{\max}$$

$$\frac{\sigma^n}{k} = \frac{2y}{h} \frac{\sigma_{\max}^n}{k}$$

$$\sigma^n = \frac{2y}{h} \sigma_{\max}^n$$

$$\sigma = \left(\frac{2y}{h}\right)^{\frac{1}{n}} \sigma_{\max}$$

$$M = \int_A y \sigma dA = 2 \int_0^{\frac{h}{2}} y \left(\frac{2y}{h}\right)^{\frac{1}{n}} \sigma_{\max} b dy$$

$$M = \frac{2(2)^{\frac{1}{n}} b}{h^{\frac{1}{n}}} \sigma_{\max} \int_0^{\frac{h}{2}} y^{\frac{(n+1)}{n}} dy$$

$$M = \frac{2(2)^{\frac{1}{n}} b}{h^{\frac{1}{n}}} \sigma_{\max} \left[\left(\frac{n}{2n+1}\right) y^{\frac{(2n+1)}{n}} \right]_0^{\frac{h}{2}}$$

$$M = \frac{n}{(2n+1)} \left(\frac{2(2)^{\frac{1}{n}} b}{h^{\frac{1}{n}}}\right) \sigma_{\max} \left[\frac{h}{2}\right]^{\frac{2n+1}{n}}$$

$$M = \frac{nbh^2}{2(2n+1)} \sigma_{\max} \quad \text{Ans}$$

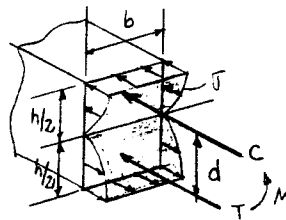
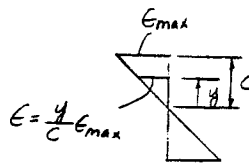
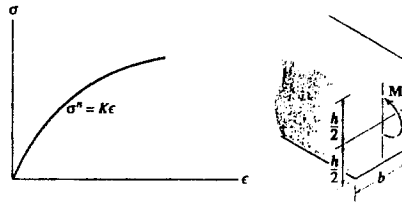

From *Mechanics of Materials*, Sixth Edition by R. C. Hibbeler, ISBN 0-13-191345-X.

© 2005 R. C. Hibbeler. Published by Pearson Prentice Hall,

Pearson Education, Inc., Upper Saddle River, NJ. All rights reserved.

This material is protected under all copyright laws as they currently exist. No portion of this material may be reproduced, in any form or by any means, without permission in writing from the publisher.

6-182 The composite beam consists of a wood core and two plates of steel. If the allowable bending stress for the wood is $(\sigma_{allow})_w = 20 \text{ MPa}$, and for the steel $(\sigma_{allow})_{st} = 130 \text{ MPa}$, determine the maximum moment that can be applied to the beam. $E_w = 11 \text{ GPa}$, $E_{st} = 200 \text{ GPa}$.

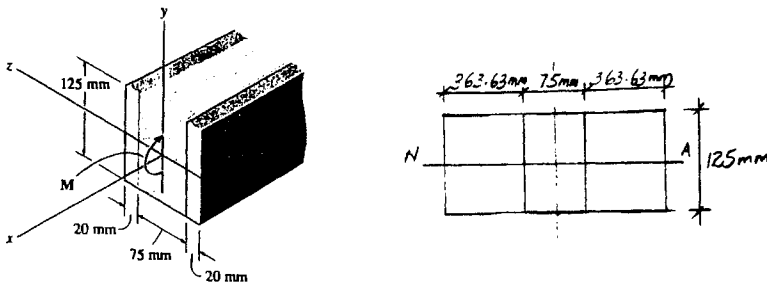

$$n = \frac{E_{st}}{E_w} = \frac{200(10^9)}{11(10^9)} = 18.182$$

$$I = \frac{1}{12}(0.80227)(0.125^3) = 0.130578(10^{-3})\text{m}^4$$

Failure of wood :

$$(\sigma_w)_{max} = \frac{Mc}{I}$$

$$20(10^6) = \frac{M(0.0625)}{0.130578(10^{-3})}; \quad M = 41.8 \text{ kN} \cdot \text{m}$$

Failure of steel :

$$(\sigma_{st})_{max} = \frac{nMc}{I}$$

$$130(10^6) = \frac{18.182(M)(0.0625)}{0.130578(10^{-3})}$$

$$M = 14.9 \text{ kN} \cdot \text{m} \quad (\text{controls}) \quad \text{Ans}$$

From *Mechanics of Materials*, Sixth Edition by R. C. Hibbeler, ISBN 0-13-191345-X.

© 2005 R. C. Hibbeler. Published by Pearson Prentice Hall,

Pearson Education, Inc., Upper Saddle River, NJ. All rights reserved.

This material is protected under all copyright laws as they currently exist. No portion of this material may be reproduced, in any form or by any means, without permission in writing from the publisher.

6-183. Solve Prob. 6-182 if the moment is applied about the y axis instead of the z axis as shown.

$$n = \frac{11(10^9)}{200(10^4)} = 0.055$$

$$I = \frac{1}{12}(0.125)(0.115^3) - \frac{1}{12}(0.118125)(0.075^3) = 11.689616(10^{-6})$$

Failure of wood :

$$(\sigma_w)_{\max} = \frac{nMc_2}{I}$$

$$20(10^6) = \frac{0.055(M)(0.0375)}{11.689616(10^{-6})}; \quad M = 113 \text{ kN} \cdot \text{m}$$

Failure of steel :

$$(\sigma_{st})_{\max} = \frac{Mc_1}{I}$$

$$130(10^6) = \frac{M(0.0575)}{11.689616(10^{-6})}$$

$$M = 26.4 \text{ kN} \cdot \text{m} \quad (\text{controls}) \quad \text{Ans}$$

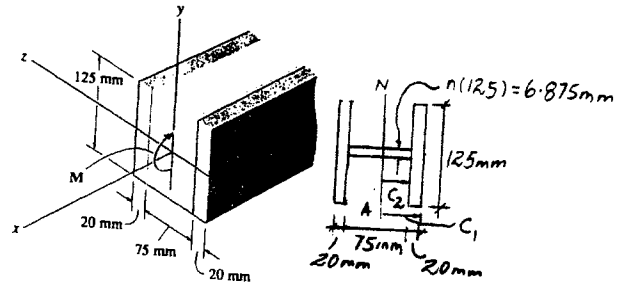

From *Mechanics of Materials*, Sixth Edition by R. C. Hibbeler, ISBN 0-13-191345-X.

© 2005 R. C. Hibbeler. Published by Pearson Prentice Hall,

Pearson Education, Inc., Upper Saddle River, NJ. All rights reserved.

This material is protected under all copyright laws as they currently exist. No portion of this material may be reproduced, in any form or by any means, without permission in writing from the publisher.

*6-184 Draw the shear and moment diagrams for the beam and determine the shear and moment in the beam as functions of x , where $0 \leq x < 6$ ft.

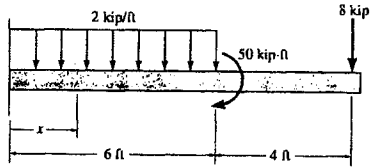

$$+\uparrow \Sigma F_y = 0; \quad 20 - 2x - V = 0$$

$$V = 20 - 2x \quad \text{Ans}$$

$$\curvearrowleft + \Sigma M_{NA} = 0; \quad 20x - 166 - 2x\left(\frac{x}{2}\right) - M = 0$$

$$M = -x^2 + 20x - 166 \quad \text{Ans}$$

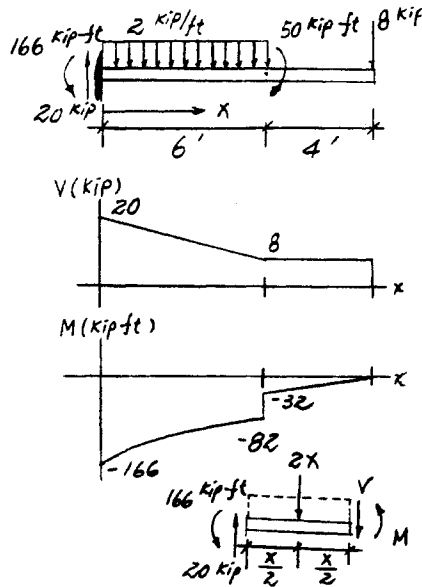

From *Mechanics of Materials*, Sixth Edition by R. C. Hibbeler, ISBN 0-13-191345-X.

© 2005 R. C. Hibbeler. Published by Pearson Prentice Hall,

Pearson Education, Inc., Upper Saddle River, NJ. All rights reserved.

This material is protected under all copyright laws as they currently exist. No portion of this material may be reproduced, in any form or by any means, without permission in writing from the publisher.

6-185 Determine the bending stress distribution in the beam at section $a-a$. Sketch the distribution in three dimensions acting over the cross section.

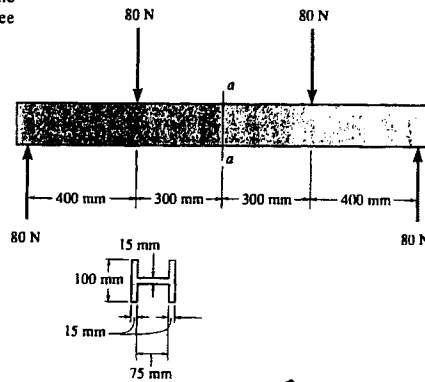
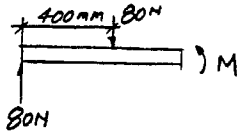

$$\begin{aligned} \sum M = 0; \quad M - 80(0.4) &= 0 \\ M &= 32 \text{ N} \cdot \text{m} \end{aligned}$$

$$I_z = \frac{1}{12}(0.075)(0.015^3) + 2\left(\frac{1}{12}\right)(0.015)(0.1^3) = 2.52109(10^{-6})\text{m}^4$$

$$\sigma_{\max} = \frac{Mc}{I} = \frac{32(0.05)}{2.52109(10^{-6})} = 635 \text{ kPa} \quad \text{Ans}$$

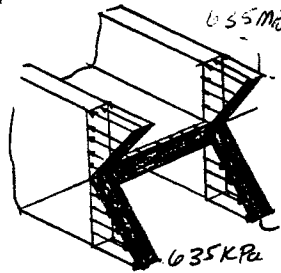

From *Mechanics of Materials*, Sixth Edition by R. C. Hibbeler, ISBN 0-13-191345-X.
 © 2005 R. C. Hibbeler. Published by Pearson Prentice Hall,
 Pearson Education, Inc., Upper Saddle River, NJ. All rights reserved.
 This material is protected under all copyright laws as they currently exist. No portion of this material may be reproduced, in any form or by any means, without permission in writing from the publisher.

6-186 Determine the plastic section modulus and the shape factor for the wide-flange beam.

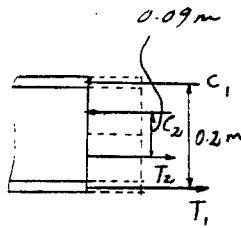
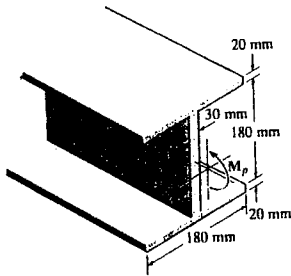

$$I = \frac{1}{12}(0.18)(0.22^3) - \frac{1}{12}(0.15)(0.18^3)$$

$$= 86.82(10^{-6}) \text{ m}^4$$

Plastic moment :

$$M_p = \sigma_Y(0.18)(0.02)(0.2) + \sigma_Y(0.09)(0.03)(0.09)$$

$$= 0.963(10^{-3})\sigma_Y$$

Plastic section modulus :

$$Z = \frac{M_p}{\sigma_Y} = \frac{0.963(10^{-3})\sigma_Y}{\sigma_Y}$$

$$= 0.963(10^{-3}) \text{ m}^3$$

Ans

Shape factor :

$$M_Y = \frac{\sigma_Y I}{c} = \frac{\sigma_Y(86.82)(10^{-6})}{0.11} = 0.789273(10^{-3})\sigma_Y$$

$$K = \frac{M_p}{M_Y} = \frac{0.963(10^{-3})\sigma_Y}{0.789273(10^{-3})\sigma_Y} = 1.22$$

Ans

From *Mechanics of Materials*, Sixth Edition by R. C. Hibbeler, ISBN 0-13-191345-X.

© 2005 R. C. Hibbeler. Published by Pearson Prentice Hall,

Pearson Education, Inc., Upper Saddle River, NJ. All rights reserved.

This material is protected under all copyright laws as they currently exist. No portion of this material may be reproduced, in any form or by any means, without permission in writing from the publisher.

6-187. The beam is made of an elastic plastic material for which $\sigma_Y = 250$ MPa. Determine the residual stress in the beam at its top and bottom after the plastic moment M_p is applied and then released.

$$I = \frac{1}{12}(0.18)(0.22^3) - \frac{1}{12}(0.15)(0.18^3)$$

$$= 86.82(10^{-6}) \text{ m}^4$$

Plastic moment :

$$M_p = 250(10^6)(0.18)(0.02)(0.2)$$

$$+ 250(10^6)(0.09)(0.03)(0.09)$$

$$= 240750 \text{ N} \cdot \text{m}$$

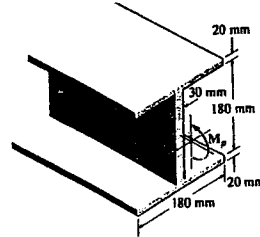
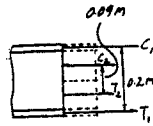

Applying a reverse $M_p = 240750 \text{ N} \cdot \text{m}$

$$\sigma_p = \frac{M_p c}{I} = \frac{240750(0.11)}{86.82(10^{-6})} = 305.03 \text{ MPa}$$

$$\sigma'_{\text{top}} = \sigma'_{\text{bottom}} = 305 - 250 = 55.0 \text{ MPa} \quad \text{Ans}$$

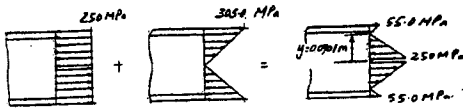

From *Mechanics of Materials*, Sixth Edition by R. C. Hibbeler, ISBN 0-13-191345-X.

© 2005 R. C. Hibbeler. Published by Pearson Prentice Hall,

Pearson Education, Inc., Upper Saddle River, NJ. All rights reserved.

This material is protected under all copyright laws as they currently exist. No portion of this material may be reproduced, in any form or by any means, without permission in writing from the publisher.

*6-188 For the curved beam in Fig. 6-44a, show that when the radius of curvature approaches infinity, the curved-beam formula, Eq. 6-24, reduces to the flexure formula, Eq. 6-13.

$$\sigma = \frac{M(R-r)}{Ar(\bar{r}-R)}, \quad R = \frac{A}{\int_A \frac{dA}{r}} = \frac{A}{A'}, \quad A' = \int_A \frac{dA}{r}$$

$$\sigma = \frac{M(A-rA')}{Ar(\bar{r}A'-A)} \quad (1)$$

But,

$$r = \bar{r} + y, \quad (2)$$

$$\begin{aligned} \bar{r}A' &= \bar{r} \int_A \frac{dA}{r} = \int_A \left(\frac{\bar{r}}{\bar{r}+y} - 1 + 1 \right) dA = \int_A \left(\frac{\bar{r}-\bar{r}-y}{\bar{r}+y} + 1 \right) dA \\ &= A - \int_A \frac{y}{\bar{r}+y} dA \quad (3) \end{aligned}$$

Denominator of Eq (1) becomes :

$$Ar(\bar{r}A'-A) = Ar\left(A - \int_A \frac{y}{\bar{r}+y} dA - A\right) = -Ar \int_A \frac{y}{\bar{r}+y} dA$$

Using Eq. (2) :

$$Ar(\bar{r}A'-A) = -Ar \int_A \left(\frac{\bar{r}y}{\bar{r}+y} + y - y \right) dA - Ay \int_A \frac{y}{\bar{r}+y} dA$$

$$Ar(\bar{r}A'-A) = A \int_A \frac{y^2}{\bar{r}+y} dA - A \int_A y dA - Ay \int_A \frac{y}{\bar{r}+y} dA$$

$$Ar(\bar{r}A'-A) = \frac{A}{\bar{r}} \int_A \left(\frac{y^2}{1+y/\bar{r}} \right) dA - A \int_A y dA - \frac{Ay}{\bar{r}} \int_A \left(\frac{y}{1+y/\bar{r}} \right) dA$$

But,

$$\int_A y dA = 0; \quad \text{as } \frac{y}{\bar{r}} \rightarrow 0$$

Then,

$$Ar(\bar{r}A'-A) \rightarrow \frac{A}{\bar{r}}$$

Equation (1) becomes :

$$\sigma = \frac{M\bar{r}}{AI}(A-rA')$$

Using Eq. (2) :

$$\sigma = \frac{M\bar{r}}{AI}(A-\bar{r}A'-yA')$$

Using Eq. (3)

$$\begin{aligned} \sigma &= \frac{M\bar{r}}{AI} \left[A - \left(A - \int_A \frac{y}{\bar{r}+y} dA \right) - y \int_A \frac{dA}{\bar{r}+y} \right] = \frac{M\bar{r}}{AI} \left[\int_A \frac{y}{\bar{r}+y} dA - y \int_A \frac{dA}{\bar{r}+y} \right] \\ &= \frac{M\bar{r}}{AI} \left[\int_A \frac{y/\bar{r}}{1+y/\bar{r}} dA - \frac{y}{\bar{r}} \int_A \frac{dA}{1+y/\bar{r}} \right] \end{aligned}$$

$$\text{As } \frac{y}{\bar{r}} \rightarrow 0$$

$$\int_A \frac{y/\bar{r}}{1+y/\bar{r}} dA = 0$$

$$\frac{y}{\bar{r}} \int_A \frac{dA}{1+y/\bar{r}} = \frac{y}{\bar{r}} \int_A dA = \frac{yA}{\bar{r}}$$

$$\sigma = \frac{M\bar{r}}{AI} \left(-\frac{yA}{\bar{r}} \right) = -\frac{My}{I} \quad \text{QED}$$

From *Mechanics of Materials*, Sixth Edition by R. C. Hibbeler, ISBN 0-13-191345-X.

© 2005 R. C. Hibbeler. Published by Pearson Prentice Hall,

Pearson Education, Inc., Upper Saddle River, NJ. All rights reserved.

This material is protected under all copyright laws as they currently exist. No portion of this material may be reproduced, in any form or by any means, without permission in writing from the publisher.

6-189 The curved beam is subjected to a bending moment of $M = 85 \text{ N} \cdot \text{m}$ as shown. Determine the stress at points A and B and show the stress on a volume element located at these points.

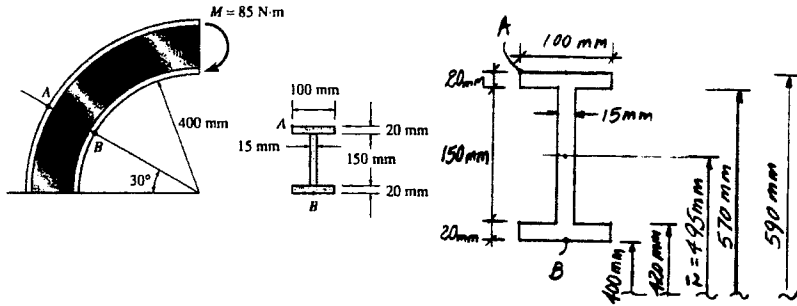

$$\int_A \frac{dA}{r} = b \ln \frac{r_2}{r_1} = 0.1 \ln \frac{0.42}{0.40} + 0.015 \ln \frac{0.57}{0.42} + 0.1 \ln \frac{0.59}{0.57} = 0.012908358 \text{ m}$$

$$A = 2(0.1)(0.02) + (0.15)(0.015) = 6.25(10^{-3}) \text{ m}^2$$

$$R = \frac{A}{\int_A \frac{dA}{r}} = \frac{6.25(10^{-3})}{0.012908358} = 0.484182418 \text{ m}$$

$$\bar{r} - R = 0.495 - 0.484182418 = 0.010817581 \text{ m}$$

$$\sigma_A = \frac{M(R - r_A)}{Ar_A(\bar{r} - R)} = \frac{85(0.484182418 - 0.59)}{6.25(10^{-3})(0.59)(0.010817581)} = -225.48 \text{ kPa}$$

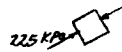

$$\sigma_A = 225 \text{ kPa (C) \quad Ans}$$

$$\sigma_B = \frac{M(R - r_B)}{Ar_B(\bar{r} - R)} = \frac{85(0.484182418 - 0.40)}{6.25(10^{-3})(0.40)(0.010817581)} = 265 \text{ kPa (T) \quad Ans}$$

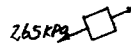

From *Mechanics of Materials*, Sixth Edition by R. C. Hibbeler, ISBN 0-13-191345-X.
 © 2005 R. C. Hibbeler. Published by Pearson Prentice Hall,
 Pearson Education, Inc., Upper Saddle River, NJ. All rights reserved.
 This material is protected under all copyright laws as they currently exist. No portion of this material may be reproduced, in any form or by any means, without permission in writing from the publisher.

6-190 Draw the shear and moment diagrams for the shaft if it is subjected to the vertical loadings of the belt, gear, and flywheel. The bearings at *A* and *B* exert only vertical reactions on the shaft.

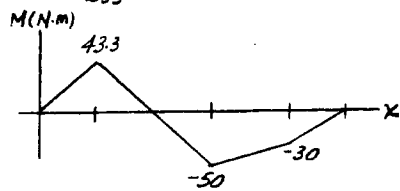
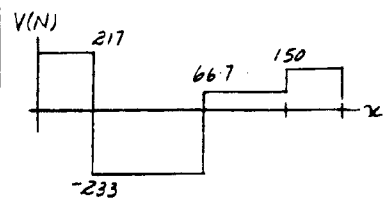
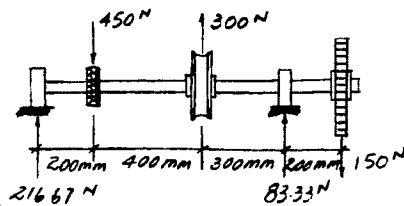
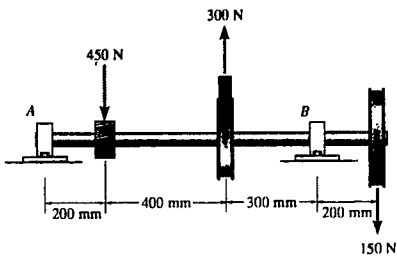

From *Mechanics of Materials*, Sixth Edition by R. C. Hibbeler, ISBN 0-13-191345-X.

© 2005 R. C. Hibbeler. Published by Pearson Prentice Hall,

Pearson Education, Inc., Upper Saddle River, NJ. All rights reserved.

This material is protected under all copyright laws as they currently exist. No portion of this material may be reproduced, in any form or by any means, without permission in writing from the publisher.

6-191. Determine the maximum bending stress in the handle of the cable cutter at section *a-a*. A force of 45 lb is applied to the handles. The cross-sectional area is shown in the figure.

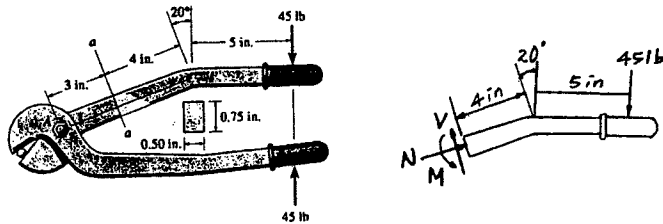

$$\begin{aligned} \sum M = 0; \quad M - 45(5 + 4 \cos 20^\circ) &= 0 \\ M &= 394.14 \text{ lb} \cdot \text{in.} \end{aligned}$$

$$\sigma_{\max} = \frac{Mc}{I} = \frac{394.14(0.375)}{\frac{1}{12}(0.5)(0.75^3)} = 8.41 \text{ ksi} \quad \text{Ans}$$

From *Mechanics of Materials*, Sixth Edition by R. C. Hibbeler, ISBN 0-13-191345-X.

© 2005 R. C. Hibbeler. Published by Pearson Prentice Hall,

Pearson Education, Inc., Upper Saddle River, NJ. All rights reserved.

This material is protected under all copyright laws as they currently exist. No portion of this material may be reproduced, in any form or by any means, without permission in writing from the publisher.

7-1 If the beam is subjected to a shear of $V = 15 \text{ kN}$, determine the web's shear stress at A and B . Indicate the shear-stress components on a volume element located at these points. Set $w = 125 \text{ mm}$. Show that the neutral axis is located at $\bar{y} = 0.1747 \text{ m}$ from the bottom and $I_{NA} = 0.2182(10^{-3}) \text{ m}^4$.

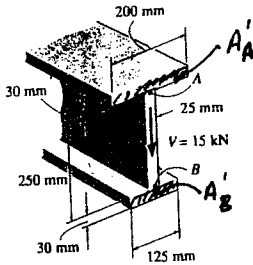

$$\bar{y} = \frac{(0.015)(0.125)(0.03) + (0.155)(0.025)(0.25) + (0.295)(0.2)(0.03)}{0.125(0.03) + (0.025)(0.25) + (0.2)(0.03)} = 0.1747 \text{ m}$$

$$I = \frac{1}{12}(0.125)(0.03^3) + 0.125(0.03)(0.1747 - 0.015)^2$$

$$+ \frac{1}{12}(0.025)(0.25^3) + 0.25(0.025)(0.1747 - 0.155)^2$$

$$+ \frac{1}{12}(0.2)(0.03^3) + 0.2(0.03)(0.295 - 0.1747)^2 = 0.218182(10^{-3}) \text{ m}^4$$

$$Q_A = \bar{y}A'_A = (0.310 - 0.015 - 0.1747)(0.2)(0.03) = 0.7219(10^{-3}) \text{ m}^3$$

$$Q_B = \bar{y}A'_B = (0.1747 - 0.015)(0.125)(0.03) = 0.59883(10^{-3}) \text{ m}^3$$

$$\tau_A = \frac{VQ_A}{I t} = \frac{15(10^3)(0.7219)(10^{-3})}{0.218182(10^{-3})(0.025)} = 1.99 \text{ MPa} \quad \text{Ans}$$

$$\tau_B = \frac{VQ_B}{I t} = \frac{15(10^3)(0.59883)(10^{-3})}{0.218182(10^{-3})(0.025)} = 1.65 \text{ MPa} \quad \text{Ans}$$

$$\tau_A = 1.99 \text{ MPa}$$



$$\tau_B = 1.65 \text{ MPa}$$

From *Mechanics of Materials*, Sixth Edition by R. C. Hibbeler, ISBN 0-13-191345-X.

© 2005 R. C. Hibbeler. Published by Pearson Prentice Hall,

Pearson Education, Inc., Upper Saddle River, NJ. All rights reserved.

This material is protected under all copyright laws as they currently exist. No portion of this material may be reproduced, in any form or by any means, without permission in writing from the publisher.

7-2 If the wide-flange beam is subjected to a shear of $V = 30 \text{ kN}$, determine the maximum shear stress in the beam. Set $w = 200 \text{ mm}$.

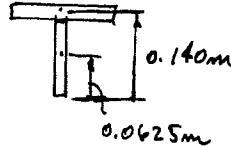
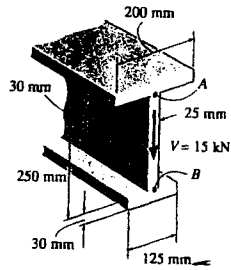

Section Properties :

$$I = \frac{1}{12}(0.2)(0.310)^3 - \frac{1}{12}(0.175)(0.250)^3 = 268.652(10)^{-6} \text{ m}^4$$

$$Q_{\max} = \Sigma \bar{y}A = 0.0625(0.125)(0.025) + 0.140(0.2)(0.030) = 1.0353(10)^{-3} \text{ m}^3$$

$$\tau_{\max} = \frac{VQ}{It} = \frac{30(10)^3(1.0353)(10)^{-3}}{268.652(10)^{-6}(0.025)} = 4.62 \text{ MPa} \quad \text{Ans}$$

From *Mechanics of Materials*, Sixth Edition by R. C. Hibbeler, ISBN 0-13-191345-X.

© 2005 R. C. Hibbeler. Published by Pearson Prentice Hall,

Pearson Education, Inc., Upper Saddle River, NJ. All rights reserved.

This material is protected under all copyright laws as they currently exist. No portion of this material may be reproduced, in any form or by any means, without permission in writing from the publisher.

7-3 If the wide-flange beam is subjected to a shear of $V = 30 \text{ kN}$, determine the shear force resisted by the web of the beam. Set $w = 200 \text{ mm}$.

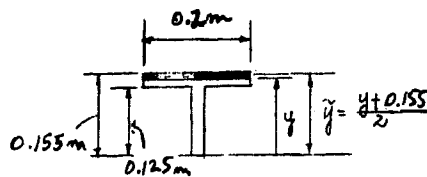
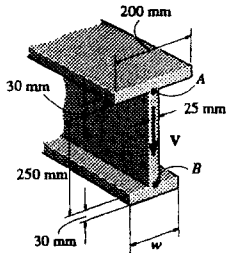

$$I = \frac{1}{12}(0.2)(0.310)^3 - \frac{1}{12}(0.175)(0.250)^3 = 268.652(10)^{-6} \text{ m}^4$$

$$Q = \left(\frac{0.155 + y}{2}\right)(0.155 - y)(0.2) = 0.1(0.024025 - y^2)$$

$$\tau_r = \frac{30(10)^3(0.1)(0.024025 - y^2)}{268.652(10)^{-6}(0.2)}$$

$$\begin{aligned} V_r &= \int \tau_r dA = 55.8343(10)^6 \int_{0.125}^{0.155} (0.024025 - y^2)(0.2) dy \\ &= 11.1669(10)^6 \left[0.024025y - \frac{1}{3}y^3 \right]_{0.125}^{0.155} \end{aligned}$$

$$V_r = 1.457 \text{ kN}$$

$$V_w = 30 - 2(1.457) = 27.1 \text{ kN} \quad \text{Ans}$$

From *Mechanics of Materials*, Sixth Edition by R. C. Hibbeler, ISBN 0-13-191345-X.

© 2005 R. C. Hibbeler. Published by Pearson Prentice Hall,

Pearson Education, Inc., Upper Saddle River, NJ. All rights reserved.

This material is protected under all copyright laws as they currently exist. No portion of this material may be reproduced, in any form or by any means, without permission in writing from the publisher.

*7-4. The beam is fabricated from three steel plates, and it is subjected to a shear force of $V = 150$ kN. Determine the shear stress at points A and C where the plates are joined. Show $\bar{y} = 0.080196$ m from the bottom and $I_{NA} = 4.8646(10^{-6})$ m⁴.

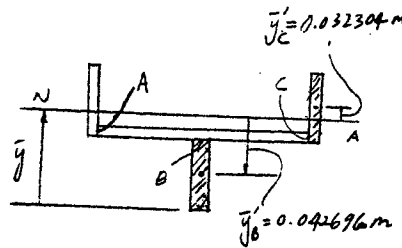
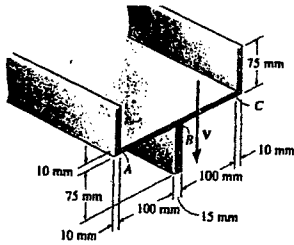

$$\bar{y} = \frac{\sum \bar{y}A}{\sum A} = \frac{0.0375(0.075)(0.015) + 0.08(0.215)(0.01) + 2[0.1125(0.075)(0.01)]}{0.075(0.015) + 0.215(0.01) + 2(0.075)(0.01)} = 0.080196 \text{ m}$$

$$I = \frac{1}{12}(0.015)(0.075^3) + (0.015)(0.075)(0.080196 - 0.0375)^2 + \frac{1}{12}(0.215)(0.01^3) + 0.215(0.01)(0.080196 - 0.08)^2 + 2\left[\frac{1}{12}(0.01)(0.075^3) + 0.01(0.075)(0.1125 - 0.080196)^2\right] = 4.8646(10^{-6}) \text{ m}^4$$

$$Q_A = Q_C = \bar{y}'_c A = 0.032304(0.075)(0.01) = 24.2277(10^{-6}) \text{ m}^3$$

$$\tau_A = \tau_C = \frac{VQ}{It} = \frac{150(10^3)(24.2277)(10^{-6})}{4.8646(10^{-6})(0.01)} = 74.7 \text{ MPa} \quad \text{Ans}$$

From *Mechanics of Materials*, Sixth Edition by R. C. Hibbeler, ISBN 0-13-191345-X.

© 2005 R. C. Hibbeler. Published by Pearson Prentice Hall,

Pearson Education, Inc., Upper Saddle River, NJ. All rights reserved.

This material is protected under all copyright laws as they currently exist. No portion of this material may be reproduced, in any form or by any means, without permission in writing from the publisher.

7-5. The beam is fabricated from three steel plates, and it is subjected to a shear force of $V = 150 \text{ kN}$. Determine the shear stress at point B where the plates are joined. Show $\bar{y} = 0.080196 \text{ m}$ from the bottom and $I_{NA} = 4.8646(10^{-6}) \text{ m}^4$.

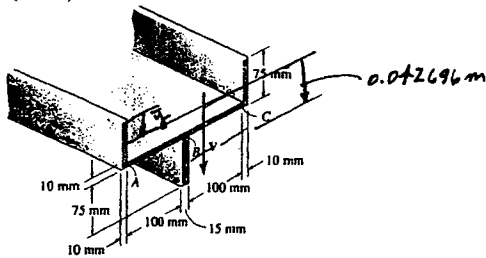

$$\bar{y} = \frac{\sum \bar{y} A}{\sum A} = \frac{0.0375(0.075)(0.015) + 0.08(0.215)(0.01) + 2[0.1125(0.075)(0.01)]}{0.075(0.015) + 0.215(0.01) + 2(0.075)(0.01)} = 0.080196 \text{ m}$$

$$I = \frac{1}{12}(0.015)(0.075^3) + (0.015)(0.075)(0.080196 - 0.0375)^2 + \frac{1}{12}(0.215)(0.01^3) + 0.215(0.01)(0.080196 - 0.08)^2 + 2\left[\frac{1}{12}(0.01)(0.075^3) + 0.01(0.075)(0.1125 - 0.080196)^2\right] = 4.8646(10^{-6}) \text{ m}^4$$

$$Q_B = \bar{y}_B A = 0.042696(0.075)(0.015) = 48.0333(10^{-6}) \text{ m}^3$$

$$\tau_B = \frac{VQ_B}{I t} = \frac{150(10^3)(48.0333)(10^{-6})}{4.8646(10^{-6})(0.015)} = 98.7 \text{ MPa} \quad \text{Ans}$$

From *Mechanics of Materials*, Sixth Edition by R. C. Hibbeler, ISBN 0-13-191345-X.

© 2005 R. C. Hibbeler. Published by Pearson Prentice Hall,

Pearson Education, Inc., Upper Saddle River, NJ. All rights reserved.

This material is protected under all copyright laws as they currently exist. No portion of this material may be reproduced, in any form or by any means, without permission in writing from the publisher.

7-6. If the T-beam is subjected to a vertical shear of $V = 10$ kip, determine the maximum shear stress in the beam. Also, compute the shear-stress jump at the flange-web junction AB . Sketch the variation of the shear-stress intensity over the entire cross section. Show that $I_{NA} = 532.04 \text{ in}^4$.

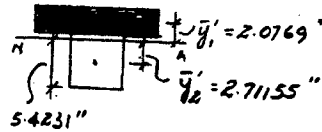
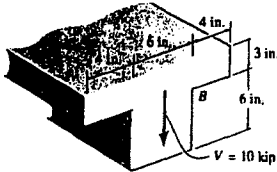

$$\bar{y} = \frac{(1.5)(3)(14) + 6(6)(6)}{3(14) + 6(6)} = 3.5769 \text{ in.}$$

$$I = \frac{1}{12}(14)(3)^3 + 3(14)(3.5769 - 1.5)^2 + \frac{1}{12}(6)(6)^3 + 6(6)(6 - 3.5769)^2 = 532.04 \text{ in}^4$$

$$Q_{\max} = \bar{y}_2 A' = 2.71155(5.4231)(6) = 88.23 \text{ in}^3$$

$$\tau_{\max} = \frac{VQ_{\max}}{I t} = \frac{10(10^3)(88.23)}{532.04(6)} = 276 \text{ psi} \quad \text{Ans}$$

$$Q_{AB} = \bar{y}_1 A' = 2.0769(3)(14) = 87.23 \text{ in}^3$$

$$(\tau_{AB})_f = \frac{VQ_{AB}}{I t_f} = \frac{10(10^3)(87.23)}{532.04(14)} = 117.1 \text{ psi}$$

$$(\tau_{AB})_w = \frac{VQ_{AB}}{I t_w} = \frac{10(10^3)(87.23)}{532.04(6)} = 273.3 \text{ psi}$$

$$\begin{aligned} \text{Shear stress jump} &= (\tau_{AB})_w - (\tau_{AB})_f \\ &= 273.3 - 117.1 \\ &= 156 \text{ psi} \quad \text{Ans} \end{aligned}$$

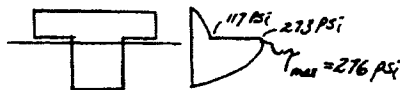

From *Mechanics of Materials*, Sixth Edition by R. C. Hibbeler, ISBN 0-13-191345-X.

© 2005 R. C. Hibbeler. Published by Pearson Prentice Hall,

Pearson Education, Inc., Upper Saddle River, NJ. All rights reserved.

This material is protected under all copyright laws as they currently exist. No portion of this material may be reproduced, in any form or by any means, without permission in writing from the publisher.

7-7. If the T-beam is subjected to a vertical shear of $V = 10$ kip, determine the vertical shear force resisted by the flange. Show that $I_{NA} = 532.04 \text{ in}^4$.

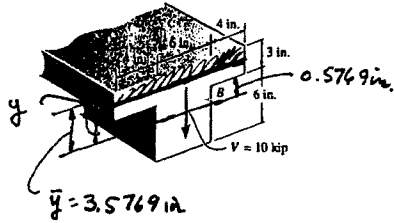

$$\bar{y} = \frac{(1.5)(3)(14) + 6(6)(6)}{3(14) + 6(6)} = 3.5769 \text{ in.}$$

$$I = \frac{1}{12}(14)(3^3) + 3(14)(3.5769 - 1.5)^2 + \frac{1}{12}(6)(6^3) + 6(6)(6 - 3.5769)^2 = 532.04 \text{ in}^4$$

$$Q = (3.5769 - y)(14)\left(\frac{3.5769 + y}{2}\right) = 7(3.5769^2 - y^2)$$

$$\tau = \frac{10(7)(3.5769^2 - y^2)}{(532.04)(14)} = 0.009398(3.5769^2 - y^2)$$

$$\begin{aligned} V_f &= \int \tau dA = \int_{0.5769}^{3.5769} 0.009398(3.5769^2 - y^2)(14 dy) \\ &= 0.13157(3.5769^2 y - \frac{1}{3}y^3) \Big|_{0.5769}^{3.5769} \\ &= 3.05 \text{ kip} \quad \text{Ans} \end{aligned}$$

From *Mechanics of Materials*, Sixth Edition by R. C. Hibbeler, ISBN 0-13-191345-X.

© 2005 R. C. Hibbeler. Published by Pearson Prentice Hall,

Pearson Education, Inc., Upper Saddle River, NJ. All rights reserved.

This material is protected under all copyright laws as they currently exist. No portion of this material may be reproduced, in any form or by any means, without permission in writing from the publisher.

*7-8 Determine the maximum shear stress in the strut if it is subjected to a shear force of $V = 15 \text{ kN}$. Show that $I_{NA} = 6.691(10^{-6}) \text{ m}^4$.

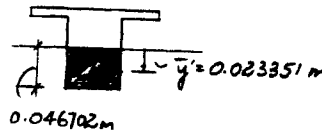
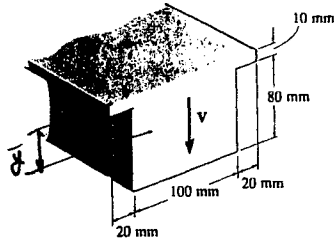

$$\bar{y} = \frac{(0.005)(0.01)(0.14) + (0.05)(0.1)(0.08)}{(0.01)(0.14) + (0.1)(0.08)} = 0.043298 \text{ m}$$

$$I = \frac{1}{12}(0.14)(0.01^3) + (0.14)(0.01)(0.043298 - 0.005)^2 + \frac{1}{12}(0.1)(0.08^3) + (0.1)(0.08)(0.05 - 0.43298)^2 = 6.6911(10^{-6}) \text{ m}^4$$

$$Q_{\max} = \bar{y}'A' = (0.023351)(0.046702)(0.1) = 0.1090544 (10^{-3}) \text{ m}^3$$

$$\tau_{\max} = \frac{VQ_{\max}}{It} = \frac{15(10^3)(0.1090544)(10^{-3})}{6.6911(10^{-6})(0.1)} = 2.44 \text{ MPa}$$

From *Mechanics of Materials*, Sixth Edition by R. C. Hibbeler, ISBN 0-13-191345-X.

© 2005 R. C. Hibbeler. Published by Pearson Prentice Hall,

Pearson Education, Inc., Upper Saddle River, NJ. All rights reserved.

This material is protected under all copyright laws as they currently exist. No portion of this material may be reproduced, in any form or by any means, without permission in writing from the publisher.

7-9 Determine the maximum shear force V that the strut can support if the allowable shear stress for the material is $\tau_{\text{allow}} = 50 \text{ MPa}$. Show that $I_{NA} = 6.691(10^{-6}) \text{ m}^4$.

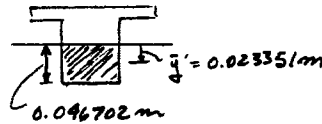
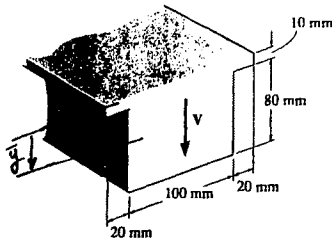

$$\bar{y} = \frac{(0.005)(0.01)(0.14) + (0.05)(0.1)(0.08)}{(0.01)(0.14) + (0.1)(0.08)} = 0.043298 \text{ m}$$

$$I = \frac{1}{12}(0.14)(0.01^3) + (0.14)(0.01)(0.043298 - 0.005)^2 + \frac{1}{12}(0.1)(0.08^3) + (0.1)(0.08)(0.043298 - 0.05)^2 = 6.6911(10^{-6}) \text{ m}^4$$

$$Q_{\text{max}} = \bar{y}'A' = (0.023351)(0.046702)(0.1) = 0.1090544 (10^{-3}) \text{ m}^3$$

$$\tau_{\text{max}} = \tau_{\text{allow}} = \frac{VQ_{\text{max}}}{It}$$

$$50(10^6) = \frac{V(0.1090544)(10^{-3})}{6.6911(10^{-6})(0.1)}$$

$$V = 307 \text{ kN} \quad \text{Ans}$$

From *Mechanics of Materials*, Sixth Edition by R. C. Hibbeler, ISBN 0-13-191345-X.

© 2005 R. C. Hibbeler. Published by Pearson Prentice Hall,

Pearson Education, Inc., Upper Saddle River, NJ. All rights reserved.

This material is protected under all copyright laws as they currently exist. No portion of this material may be reproduced, in any form or by any means, without permission in writing from the publisher.

7-10 Determine the intensity of the shear stress distributed over the cross section of the strut if it is subjected to a shear force of $V = 12 \text{ kN}$. Show that $I_{NA} = 6.691(10^{-6}) \text{ m}^4$.

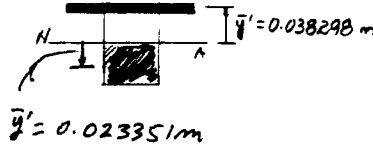
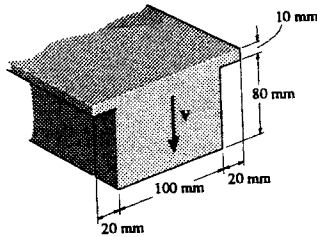

$$\bar{y} = \frac{(0.005)(0.01)(0.14) + (0.05)(0.1)(0.08)}{(0.01)(0.14) + (0.1)(0.08)} = 0.043298 \text{ m}$$

$$I = \frac{1}{12}(0.14)(0.01^3) + (0.14)(0.01)(0.043298 - 0.005)^2 + \frac{1}{12}(0.1)(0.08^3) + (0.1)(0.08)(0.05 - 0.043298)^2 = 6.6911(10^{-6}) \text{ m}^4$$

$$Q_{\max} = \bar{y}'A' = (0.023351)(0.046702)(0.1) = 0.1090544 (10^{-3}) \text{ m}^3$$

$$Q = \bar{y}'A' = (0.038298)(0.14)(0.01) = 53.6172 (10^{-6}) \text{ m}^3$$

$$\tau_f = \frac{VQ}{It} = \frac{12(10^3)(53.6172)(10^{-6})}{6.6911 (10^{-6})(0.14)} = 0.687 \text{ MPa}$$

$$\tau_w = \frac{12(10^3)(53.6172)(10^{-6})}{6.6911 (10^{-6})(0.1)} = 0.962 \text{ MPa}$$

$$\tau_{\max} = \frac{VQ_{\max}}{It} = \frac{12(10^3)(0.1090544) (10^{-3})}{6.6911 (10^{-6})(0.1)} = 1.96 \text{ MPa} \quad \text{Ans}$$

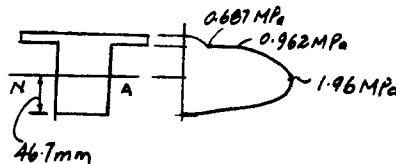

From *Mechanics of Materials*, Sixth Edition by R. C. Hibbeler, ISBN 0-13-191345-X.

© 2005 R. C. Hibbeler. Published by Pearson Prentice Hall,

Pearson Education, Inc., Upper Saddle River, NJ. All rights reserved.

This material is protected under all copyright laws as they currently exist. No portion of this material may be reproduced, in any form or by any means, without permission in writing from the publisher.

7-11. Sketch the intensity of the shear-stress distribution acting over the beam's cross-sectional area, and determine the resultant shear force acting on the segment AB . The shear acting at the section is $V = 35$ kip. Show that $I_{NA} = 872.49 \text{ in}^4$.

$$\bar{y} = \frac{(4)(8)(8) + (11)(6)(2)}{8(8) + 6(2)} = 5.1053 \text{ in.}$$

$$I = \frac{1}{12}(8)(8^3) + 8(8)(5.1053 - 4)^2 + \frac{1}{12}(2)(6^3) + 2(6)(11 - 5.1053)^2 = 872.49 \text{ in}^4$$

$$Q_E = \bar{y}'_1 A' = (2.55265)(5.1053)(8) = 104.26 \text{ in}^3$$

$$Q_D = \bar{y}'_2 A' = (5.8947)(6)(2) = 70.74 \text{ in}^3$$

$$\tau = \frac{VQ}{It}$$

$$\tau_E = \frac{35(10^3)(104.26)}{872.49(8)} = 523 \text{ psi}$$

$$(\tau_D)_t = 2 \text{ in.} = \frac{35(10^3)(70.74)}{872.49(2)} = 1419 \text{ psi}$$

$$(\tau_D)_b = 8 \text{ in.} = \frac{35(10^3)(70.74)}{872.49(8)} = 355 \text{ psi}$$

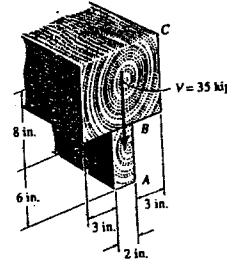
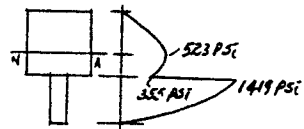
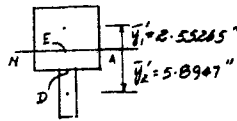

$$A' = 2(8.8947 - y)$$

$$\bar{y}' = y + \frac{(8.8947 - y)}{2} = \frac{(8.8947 + y)}{2}$$

$$Q = \bar{y}' A' = 79.1157 - y^2$$

$$\tau = \frac{VQ}{It} = \frac{35(79.1157 - y^2)}{872.49(2)} = 1.586866 - 0.0200575 y^2$$

$$V = \int \tau dA \quad dA = 2 dy$$

$$V = \int (1.586866 - 0.0200575 y^2) 2 dy$$

$$= \int_{2.8947}^{8.8947} (3.173732 - 0.040115 y^2) dy$$

$$= 9.96 \text{ kip} \quad \text{Ans}$$

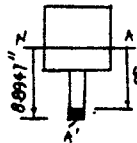

From *Mechanics of Materials*, Sixth Edition by R. C. Hibbeler, ISBN 0-13-191345-X.

© 2005 R. C. Hibbeler. Published by Pearson Prentice Hall,

Pearson Education, Inc., Upper Saddle River, NJ. All rights reserved.

This material is protected under all copyright laws as they currently exist. No portion of this material may be reproduced, in any form or by any means, without permission in writing from the publisher.

*7-12 The strut is subjected to a vertical shear of $V = 130$ kN. Plot the intensity of the shear-stress distribution acting over the cross-sectional area, and compute the resultant shear force developed in the vertical segment AB .

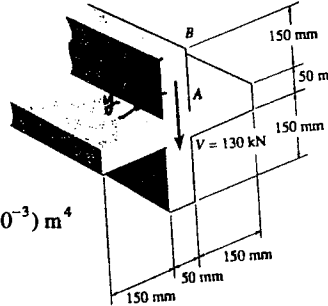

$$I = \frac{1}{12}(0.05)(0.35^3) + \frac{1}{12}(0.3)(0.05^3) = 0.18177083(10^{-3}) \text{ m}^4$$

$$Q_C = \bar{y}'A' = (0.1)(0.05)(0.15) = 0.75(10^{-3}) \text{ m}^3$$

$$Q_D = \Sigma \bar{y}'A' = (0.1)(0.05)(0.15) + (0.0125)(0.35)(0.025) = 0.859375(10^{-3}) \text{ m}^3$$

$$\tau = \frac{VQ}{It}$$

$$(\tau_C)_{t=0.05\text{m}} = \frac{130(10^3)(0.75)(10^{-3})}{0.18177083(10^{-3})(0.05)} = 10.7 \text{ MPa}$$

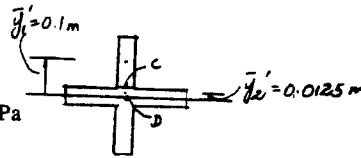

$$(\tau_C)_{t=0.35\text{m}} = \frac{130(10^3)(0.75)(10^{-3})}{0.18177083(10^{-3})(0.35)} = 1.53 \text{ MPa}$$

$$\tau_D = \frac{130(10^3)(0.859375)(10^{-3})}{0.18177083(10^{-3})(0.35)} = 1.76 \text{ MPa}$$

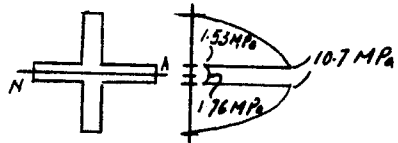

$$A' = (0.05)(0.175 - y)$$

$$\bar{y}' = y + \frac{(0.175 - y)}{2} = \frac{1}{2}(0.175 + y)$$

$$Q = \bar{y}'A' = 0.025(0.030625 - y^2)$$

$$\tau = \frac{VQ}{It}$$

$$= \frac{130(0.025)(0.030625 - y^2)}{0.18177083(10^{-3})(0.05)}$$

$$= 10951.3 - 357593.1 y^2$$

$$V = \int \tau dA \quad dA = 0.05 dy$$

$$= \int_{0.025}^{0.175} (10951.3 - 357593.1 y^2)(0.05 dy)$$

$$= \int_{0.025}^{0.175} (547.565 - 17879.66 y^2) dy$$

$$= 50.3 \text{ kN} \quad \text{Ans}$$

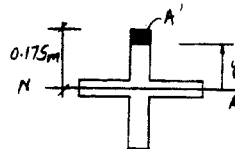

From *Mechanics of Materials*, Sixth Edition by R. C. Hibbeler, ISBN 0-13-191345-X.

© 2005 R. C. Hibbeler. Published by Pearson Prentice Hall,

Pearson Education, Inc., Upper Saddle River, NJ. All rights reserved.

This material is protected under all copyright laws as they currently exist. No portion of this material may be reproduced, in any form or by any means, without permission in writing from the publisher.

7-13 The steel rod has a radius of 1.25 in. If it is subjected to a shear of $V = 5$ kip, determine the maximum shear stress.

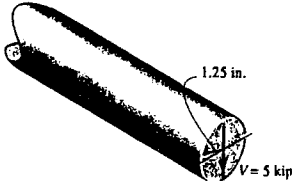

$$\bar{y}' = \frac{4r}{3\pi} = \frac{4(1.25)}{3\pi} = \frac{5}{3\pi}$$

$$I = \frac{1}{4}\pi r^4 = \frac{1}{4}\pi (1.25)^4 = 0.610351\pi$$

$$Q = \bar{y}'A' = \frac{5}{3\pi} \frac{\pi (1.25)^2}{2} = 1.3020833 \text{ in}^3$$

$$\tau_{\max} = \frac{VQ}{It} = \frac{5 (10^3)(1.3020833)}{0.610351 (\pi) (2.50)} = 1358 \text{ psi} = 1.36 \text{ ksi} \quad \text{Ans}$$



From *Mechanics of Materials*, Sixth Edition by R. C. Hibbeler, ISBN 0-13-191345-X.

© 2005 R. C. Hibbeler. Published by Pearson Prentice Hall,

Pearson Education, Inc., Upper Saddle River, NJ. All rights reserved.

This material is protected under all copyright laws as they currently exist. No portion of this material may be reproduced, in any form or by any means, without permission in writing from the publisher.

7-14. Determine the largest shear force V that the member can sustain if the allowable shear stress is $\tau_{\text{allow}} = 8 \text{ ksi}$.

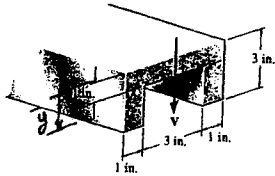

$$\bar{y} = \frac{(0.5)(1)(5) + 2[(2)(1)(2)]}{1(5) + 2(1)(2)} = 1.1667 \text{ in.}$$

$$I = \frac{1}{12}(5)(1^3) + 5(1)(1.1667 - 0.5)^2 + 2\left(\frac{1}{12}\right)(1)(2^3) + 2(1)(2)(2 - 1.1667)^2 = 6.75 \text{ in}^4$$

$$Q_{\text{max}} = \Sigma \bar{y}'A' = 2(0.91665)(1.8333)(1) = 3.3611 \text{ in}^3$$

$$\tau_{\text{max}} = \tau_{\text{allow}} = \frac{VQ_{\text{max}}}{It}$$

$$8(10^3) = \frac{V(3.3611)}{6.75(2)(1)}$$

$$V = 32132 \text{ lb} = 32.1 \text{ kip} \quad \text{Ans}$$

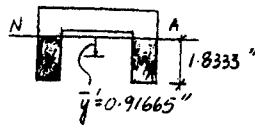

From *Mechanics of Materials*, Sixth Edition by R. C. Hibbeler, ISBN 0-13-191345-X.

© 2005 R. C. Hibbeler. Published by Pearson Prentice Hall,

Pearson Education, Inc., Upper Saddle River, NJ. All rights reserved.

This material is protected under all copyright laws as they currently exist. No portion of this material may be reproduced, in any form or by any means, without permission in writing from the publisher.

7-15. If the applied shear force $V = 18$ kip, determine the maximum shear stress in the member.

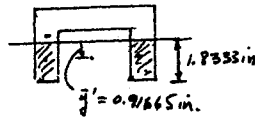
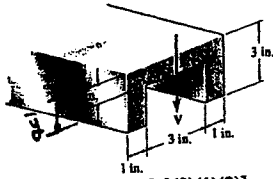

$$\bar{y} = \frac{(0.5)(1)(5) + 2[(2)(1)(2)]}{1(5) + 2(1)(2)} = 1.1667 \text{ in.}$$

$$I = \frac{1}{12}(5)(1^3) + 5(1)(1.1667 - 0.5)^2 + 2\left(\frac{1}{12}\right)(1)(2^3) + 2(1)(2)(2 - 1.1667)^2 = 6.75 \text{ in}^4$$

$$Q_{\max} = \Sigma \bar{y}' A' = 2(0.91665)(1.8333)(1) = 3.3611 \text{ in}^3$$

$$\tau_{\max} = \frac{VQ_{\max}}{It} = \frac{18(3.3611)}{6.75(2)(1)} = 4.48 \text{ ksi} \quad \text{Ans}$$

From *Mechanics of Materials*, Sixth Edition by R. C. Hibbeler, ISBN 0-13-191345-X.

© 2005 R. C. Hibbeler. Published by Pearson Prentice Hall,

Pearson Education, Inc., Upper Saddle River, NJ. All rights reserved.

This material is protected under all copyright laws as they currently exist. No portion of this material may be reproduced, in any form or by any means, without permission in writing from the publisher.

*7-16 The beam has a square cross section and is made of wood having an allowable shear stress of $\tau_{\text{allow}} = 1.4$ ksi. If it is subjected to a shear of $V = 1.5$ kip, determine the smallest dimension a of its sides.

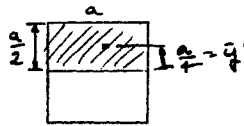
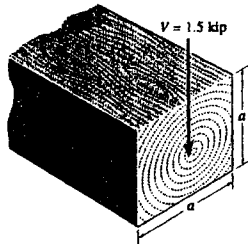

$$I = \frac{1}{12}a^4$$

$$Q_{\text{max}} = \bar{y}A' = \left(\frac{a}{4}\right)\left(\frac{a}{2}\right)a = \frac{a^3}{8}$$

$$\tau_{\text{max}} = \tau_{\text{allow}} = \frac{VQ_{\text{max}}}{It}$$

$$1.4 = \frac{1.5\left(\frac{a^3}{8}\right)}{\frac{1}{12}(a^4)(a)}$$

$$a = 1.27 \text{ in.} \quad \text{Ans}$$

From *Mechanics of Materials*, Sixth Edition by R. C. Hibbeler, ISBN 0-13-191345-X.

© 2005 R. C. Hibbeler. Published by Pearson Prentice Hall,

Pearson Education, Inc., Upper Saddle River, NJ. All rights reserved.

This material is protected under all copyright laws as they currently exist. No portion of this material may be reproduced, in any form or by any means, without permission in writing from the publisher.

7-17 The wood beam has an allowable shear stress of $\tau_{\text{allow}} = 7 \text{ MPa}$. Determine the maximum shear force V that can be applied to the cross section.

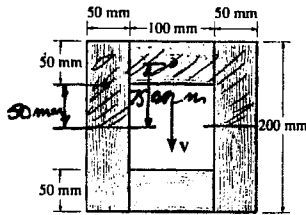

$$I = \frac{1}{12}(0.2)(0.2)^3 - \frac{1}{12}(0.1)(0.1)^3 = 125(10^{-6}) \text{ m}^4$$

$$\tau_{\text{allow}} = \frac{VQ_{\text{max}}}{It}$$

$$7(10^6) = \frac{V[(0.075)(0.1)(0.05) + 2(0.05)(0.1)(0.05)]}{125(10^{-6})(0.1)}$$

$$V = 100 \text{ kN} \quad \text{Ans}$$

From *Mechanics of Materials*, Sixth Edition by R. C. Hibbeler, ISBN 0-13-191345-X.

© 2005 R. C. Hibbeler. Published by Pearson Prentice Hall,

Pearson Education, Inc., Upper Saddle River, NJ. All rights reserved.

This material is protected under all copyright laws as they currently exist. No portion of this material may be reproduced, in any form or by any means, without permission in writing from the publisher.

7-18 The beam is made from a polymer and is subjected to a shear of $V = 7$ kip. Determine the maximum shear stress in the beam and plot the shear-stress distribution over the cross section. Report the values of the shear stress every 0.5 in. of beam depth.

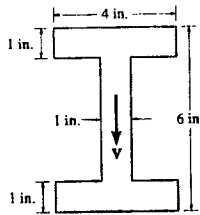

$$I = \frac{1}{12}(1)(4)^3 + 2\left[\frac{1}{12}(4)(1)^3 + 4(1)(2.5)^2\right] = 56 \text{ in}^4$$

$$\tau_1 = \frac{VQ}{It} = \frac{7(2.75)(4)(0.5)}{56(4)} = 0.172 \text{ ksi}$$

$$\tau_2 = \frac{VQ}{It} = \frac{7(2.5)(4)(1)}{56(4)} = 0.3125 \text{ ksi}$$

$$\tau_2 = \frac{VQ}{It} = \frac{7(2.5)(4)(1)}{56(1)} = 1.25 \text{ ksi}$$

$$\tau_3 = \frac{VQ}{It} = \frac{7[(2.5)(4)(1) + (1.75)(1)(0.5)]}{56(1)} = 1.36 \text{ ksi}$$

$$\tau_4 = \frac{VQ}{It} = \frac{7[(2.5)(4)(1) + (1.5)(1)(1)]}{56(1)} = 1.44 \text{ ksi}$$

$$\tau_4 = \frac{VQ}{It} = \frac{7[(2.5)(4)(1) + (1.25)(1)(1.5)]}{56(1)} = 1.48 \text{ ksi}$$

$$\tau_{\max} = \tau_5 = \frac{VQ}{It} = \frac{7[(2.5)(4)(1) + (1)(1)(2)]}{56(1)} = 1.50 \text{ ksi} \quad \text{Ans}$$

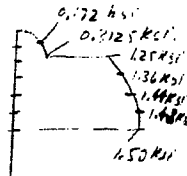

From *Mechanics of Materials*, Sixth Edition by R. C. Hibbeler, ISBN 0-13-191345-X.

© 2005 R. C. Hibbeler. Published by Pearson Prentice Hall,

Pearson Education, Inc., Upper Saddle River, NJ. All rights reserved.

This material is protected under all copyright laws as they currently exist. No portion of this material may be reproduced, in any form or by any means, without permission in writing from the publisher.

7-19. Plot the shear-stress distribution over the cross section of a rod that has a radius c . By what factor is the maximum shear stress greater than the average shear stress acting over the cross section?

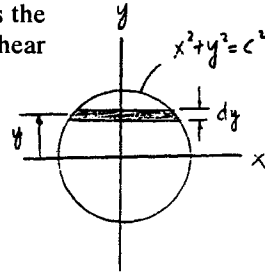

$$x = \sqrt{c^2 - y^2}; \quad I = \frac{\pi}{4} c^4$$

$$t = 2x = 2\sqrt{c^2 - y^2}$$

$$dA = 2x dy = 2\sqrt{c^2 - y^2} dy$$

$$dQ = y dA = 2y\sqrt{c^2 - y^2} dy$$

$$Q = \int_y^c 2y\sqrt{c^2 - y^2} dy = -\frac{2}{3}(c^2 - y^2)^{3/2} \Big|_y^c = \frac{2}{3}(c^2 - y^2)^{3/2}$$

$$\tau = \frac{VQ}{It} = \frac{V[\frac{2}{3}(c^2 - y^2)^{3/2}]}{(\frac{\pi}{4}c^4)(2\sqrt{c^2 - y^2})} = \frac{4V}{3\pi c^4}(c^2 - y^2)$$

The maximum shear stress occur when $y = 0$

$$\tau_{\max} = \frac{4V}{3\pi c^2}$$

$$\tau_{\text{avg}} = \frac{V}{A} = \frac{V}{\pi c^2}$$

$$\text{The factor} = \frac{\tau_{\max}}{\tau_{\text{avg}}} = \frac{\frac{4V}{3\pi c^2}}{\frac{V}{\pi c^2}} = \frac{4}{3} \quad \text{Ans}$$

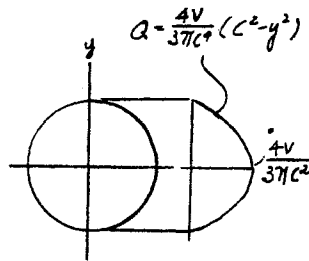

From *Mechanics of Materials*, Sixth Edition by R. C. Hibbeler, ISBN 0-13-191345-X.

© 2005 R. C. Hibbeler. Published by Pearson Prentice Hall,

Pearson Education, Inc., Upper Saddle River, NJ. All rights reserved.

This material is protected under all copyright laws as they currently exist. No portion of this material may be reproduced, in any form or by any means, without permission in writing from the publisher.

7-20 Develop an expression for the average vertical component of shear stress acting on the horizontal plane through the shaft, located a distance y from the neutral axis.

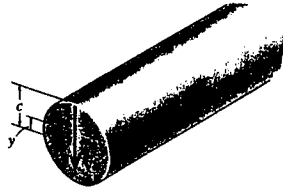

$$dA = 2x \, dy = 2\sqrt{c^2 - y^2} \, dy$$

$$Q = \int y \, dA = \int_y^c 2y \sqrt{c^2 - y^2} \, dy = \frac{2}{3}(c^2 - y^2)^{\frac{3}{2}}$$

$$I = \frac{\pi}{4}c^4; \quad t = 2(c^2 - y^2)^{\frac{1}{2}}$$

$$\tau = \frac{VQ}{It} = \frac{V[\frac{2}{3}(c^2 - y^2)^{\frac{3}{2}}]}{\frac{\pi}{4}c^4(2)(c^2 - y^2)^{\frac{1}{2}}}$$

$$= \frac{4V(c^2 - y^2)}{3\pi c^4}$$

Ans

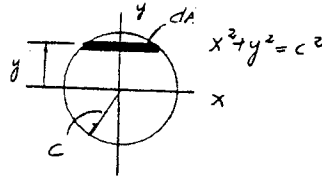

Also,

$$\bar{y} = \frac{\frac{2c \sin \theta}{3\theta} c^2 - \frac{2}{3} c \cos \theta (\frac{1}{2})(2c \sin \theta)(c \cos \theta)}{A'}$$

$$= \frac{2c^3 \sin \theta - 2c^3 \sin \theta \cos^2 \theta}{3A'}$$

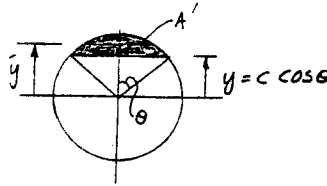

$$Q = \bar{y}A' = \frac{2}{3}c^3 \sin \theta (1 - \cos^2 \theta) = \frac{2}{3}c^3 \sin^3 \theta$$

$$I = \frac{1}{4}\pi c^4; \quad t = 2c \sin \theta$$

$$\tau = \frac{VQ}{It} = \frac{V(\frac{2}{3}c^3 \sin^3 \theta)}{\frac{1}{4}\pi c^4(2c \sin \theta)} = \frac{4V \sin^2 \theta}{3\pi c^2}$$

$$\sin \theta = \frac{\sqrt{c^2 - y^2}}{c}$$

$$\text{Therefore, } \tau = \frac{4V}{3\pi c^2} \frac{c^2 - y^2}{c^2} = \frac{4V(c^2 - y^2)}{3\pi c^4}$$

Ans

From *Mechanics of Materials*, Sixth Edition by R. C. Hibbeler, ISBN 0-13-191345-X.

© 2005 R. C. Hibbeler. Published by Pearson Prentice Hall,

Pearson Education, Inc., Upper Saddle River, NJ. All rights reserved.

This material is protected under all copyright laws as they currently exist. No portion of this material may be reproduced, in any form or by any means, without permission in writing from the publisher.

7-21 A member has a cross section in the form of an equilateral triangle. If it is subjected to a shear force V , determine the maximum average shear stress in the member. Can the shear formula be used to predict this value? Explain.

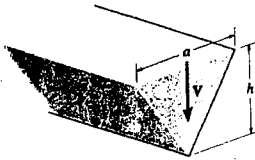

$$I = \frac{1}{36}(a)(h)^3$$

$$\frac{y}{x} = \frac{h}{a/2}; \quad y = \frac{2h}{a}x$$

$$Q = \int_A y dA = 2\left[\left(\frac{1}{2}\right)(x)(y)\left(\frac{2}{3}h - \frac{2}{3}y\right)\right]$$

$$Q = \left(\frac{4h^2}{3a}\right)(x^2)\left(1 - \frac{2x}{a}\right)$$

$$t = 2x$$

$$\tau = \frac{VQ}{It} = \frac{V(4h^2/3a)(x^2)(1 - \frac{2x}{a})}{((1/36)(a)(h^3))(2x)}$$

$$\tau = \frac{24V(x - \frac{2}{3}x^2)}{a^2h}$$

$$\frac{d\tau}{dx} = \frac{24V}{a^2h^2}\left(1 - \frac{4}{3}x\right) = 0$$

$$\text{At } x = \frac{a}{4}$$

$$y = \frac{2h}{a}\left(\frac{a}{4}\right) = \frac{h}{2}$$

$$\tau_{\max} = \frac{24V}{a^2h}\left(\frac{a}{4}\right)\left(1 - \frac{2}{3}\left(\frac{a}{4}\right)\right)$$

$$\tau_{\max} = \frac{3V}{ah} \quad \text{Ans}$$

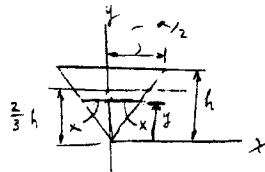

No, because the shear stress is not perpendicular to the boundary. See Sec. 7 - 3.

From *Mechanics of Materials*, Sixth Edition by R. C. Hibbeler, ISBN 0-13-191345-X.

© 2005 R. C. Hibbeler. Published by Pearson Prentice Hall,

Pearson Education, Inc., Upper Saddle River, NJ. All rights reserved.

This material is protected under all copyright laws as they currently exist. No portion of this material may be reproduced, in any form or by any means, without permission in writing from the publisher.

7-22 The beam is subjected to a uniform load w . Determine the placement a of the supports so that the shear stress in the beam is as small as possible. What is this stress?

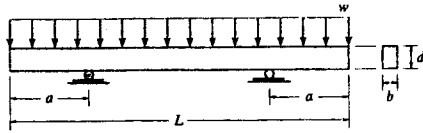

Require,

$$w\left(\frac{L}{2} - a\right) = wa$$

$$a = \frac{L}{4} \quad \text{Ans}$$

$$V = wa$$

$$\tau_{\max} = \frac{VQ}{It} = \frac{w(L/4)(d/4)(b)(d/2)}{\left[\frac{1}{12}(b)(d)^3\right](b)} = \frac{3wL}{8bd}$$

Ans

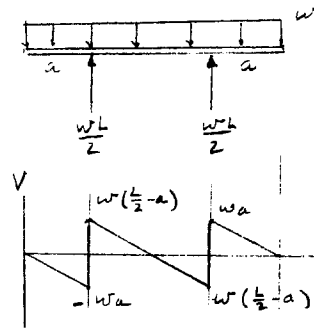

From *Mechanics of Materials*, Sixth Edition by R. C. Hibbeler, ISBN 0-13-191345-X.
 © 2005 R. C. Hibbeler. Published by Pearson Prentice Hall,
 Pearson Education, Inc., Upper Saddle River, NJ. All rights reserved.
 This material is protected under all copyright laws as they currently exist. No portion of this material may be reproduced, in any form or by any means, without permission in writing from the publisher.

7-23 The timber beam is to be notched at its ends as shown. If it is to support the loading shown, determine the smallest depth d of the beam at the notch if the allowable shear stress is $\tau_{\text{allow}} = 450$ psi. The beam has a width of 8 in.

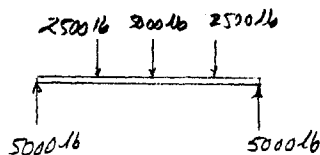
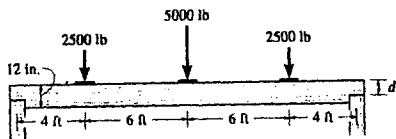

$$V = 5000 \text{ lb}$$

$$\tau = \frac{VQ}{It}$$

$$450 = \frac{5000(d/4)(d/2)(8)}{\frac{1}{12}(8)(d)^3(8)}$$

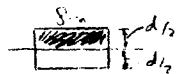

$$d = 2.08 \text{ in.} \quad \text{Ans}$$

From *Mechanics of Materials*, Sixth Edition by R. C. Hibbeler, ISBN 0-13-191345-X.

© 2005 R. C. Hibbeler. Published by Pearson Prentice Hall,

Pearson Education, Inc., Upper Saddle River, NJ. All rights reserved.

This material is protected under all copyright laws as they currently exist. No portion of this material may be reproduced, in any form or by any means, without permission in writing from the publisher.

*7-24 The beam is made from three boards glued together at the seams *A* and *B*. If it is subjected to the loading shown, determine the shear stress developed in the glued joints at section *a-a*. The supports at *C* and *D* exert only vertical reactions on the beam.

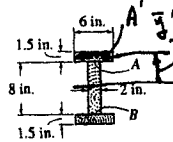
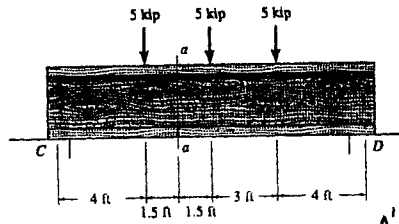
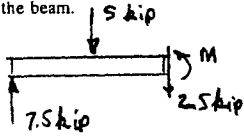

$$I = \frac{1}{12}(6)(11^3) - \frac{1}{12}(4)(8^3) = 494.83 \text{ in}^4$$

$$Q_A = Q_B = \bar{y}A' = \left(4 + \frac{1.5}{2}\right)(6)(1.5) = 42.75 \text{ in}^3$$

$$\tau = \frac{VQ}{I_t}$$

$$\tau_A = \tau_B = \frac{2.5(10^3)(42.75)}{494.83 (2)} = 108 \text{ psi} \quad \text{Ans}$$

From *Mechanics of Materials*, Sixth Edition by R. C. Hibbeler, ISBN 0-13-191345-X.

© 2005 R. C. Hibbeler. Published by Pearson Prentice Hall,

Pearson Education, Inc., Upper Saddle River, NJ. All rights reserved.

This material is protected under all copyright laws as they currently exist. No portion of this material may be reproduced, in any form or by any means, without permission in writing from the publisher.

7-25 The beam is made from three boards glued together at the seams *A* and *B*. If it is subjected to the loading shown, determine the maximum shear stress developed in the glued joints. The supports at *C* and *D* exert only vertical reactions on the beam.

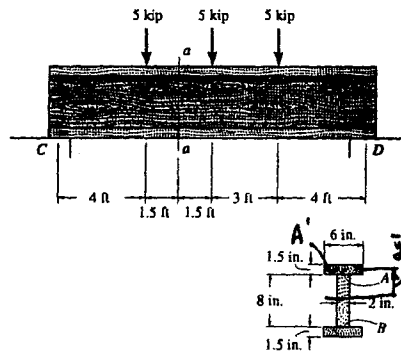

$$V_{max} = 7.5 \text{ kip} \quad (\text{at } C \text{ or } D)$$

$$I = \frac{1}{12}(6)(11)^3 - \frac{1}{12}(4)(8)^3 = 494.83 \text{ in}^4$$

$$Q_A = Q_B = \bar{y}'A' = \left(4 + \frac{1.5}{2}\right)(6)(1.5) = 42.75 \text{ in}^3$$

$$\tau_A = \tau_B = \frac{VQ}{I} = \frac{7.5(10^3)(42.75)}{494.83(2)} = 324 \text{ psi} \quad \text{Ans}$$

From *Mechanics of Materials*, Sixth Edition by R. C. Hibbeler, ISBN 0-13-191345-X.

© 2005 R. C. Hibbeler. Published by Pearson Prentice Hall,

Pearson Education, Inc., Upper Saddle River, NJ. All rights reserved.

This material is protected under all copyright laws as they currently exist. No portion of this material may be reproduced, in any form or by any means, without permission in writing from the publisher.

7-26. The beam is made from three boards glued together at the seams *A* and *B*. If it is subjected to the loading shown, determine the maximum vertical shear force resisted by the top flange of the beam. The supports at *C* and *D* exert only vertical reactions on the beam.

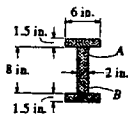
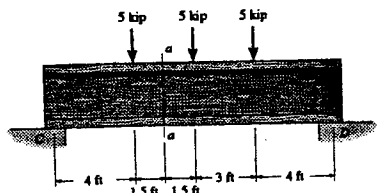

$$V_{\max} = 7.5 \text{ kip} \quad (\text{at } C \text{ or } D)$$

$$I = \frac{1}{12}(6)(11)^3 - \frac{1}{12}(4)(8)^3 = 494.83 \text{ in}^4$$

$$F_r = \int_{A'} \tau dA$$

$$\tau = \frac{VQ}{It} = \frac{7.5(10^3)(5.5-y)(6)[(5.5+y)/2]}{494.83(6)} = 7.57836(30.25-y^2)$$

$$F_r = \int_4^{5.5} 7.57836(30.25-y^2)(6dy)$$

$$= 45.4702(30.25y - \frac{1}{3}y^3) \Big|_4^{5.5} = 512 \text{ lb} \quad \text{Ans}$$

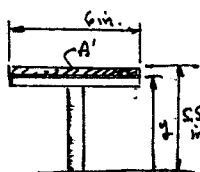

From *Mechanics of Materials*, Sixth Edition by R. C. Hibbeler, ISBN 0-13-191345-X.

© 2005 R. C. Hibbeler. Published by Pearson Prentice Hall,

Pearson Education, Inc., Upper Saddle River, NJ. All rights reserved.

This material is protected under all copyright laws as they currently exist. No portion of this material may be reproduced, in any form or by any means, without permission in writing from the publisher.

7-27 Determine the length of the cantilevered beam so that the maximum bending stress in the beam is equivalent to the maximum shear stress. Comment on the validity of your results.

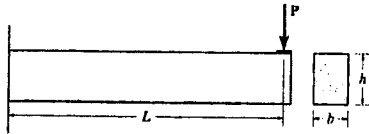

$$V_{\max} = P$$

$$M_{\max} = PL$$

$$\sigma_{\max} = \frac{Mc}{I} = \frac{PL(h/2)}{I} = \frac{PLh}{2I}$$

$$\tau_{\max} = \frac{VQ}{It} = \frac{P(h/2)(b)(h/4)}{Ib} = \frac{Ph^2}{8I}$$

Require,

$$\sigma_{\max} = \tau_{\max}$$

$$\frac{PLh}{2I} = \frac{Ph^2}{8I}$$

$$L = \frac{h}{4} \quad \text{Ans}$$

Shear stress is important only for very short beams. Note also, that this result is not all that accurate since Saint - Venant's Principle must be considered.

From *Mechanics of Materials*, Sixth Edition by R. C. Hibbeler, ISBN 0-13-191345-X.

© 2005 R. C. Hibbeler. Published by Pearson Prentice Hall,

Pearson Education, Inc., Upper Saddle River, NJ. All rights reserved.

This material is protected under all copyright laws as they currently exist. No portion of this material may be reproduced, in any form or by any means, without permission in writing from the publisher.

*7-28 Railroad ties must be designed to resist large shear loadings. If the tie is subjected to the 34-kip rail loadings and an assumed uniformly distributed ground reaction, determine the intensity w for equilibrium, and compute the maximum shear stress in the tie at section $a-a$, which is located just to the left of the rail.

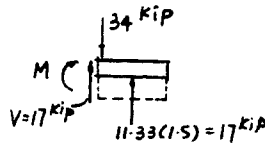
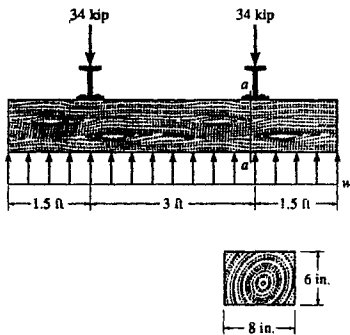

$$+\uparrow \Sigma F_y = 0; \quad 6w - 2(34) = 0$$

$$w = 11.3 \text{ kip/ft} \quad \text{Ans}$$

$$I = \frac{1}{12}(8)(6^3) = 144 \text{ in}^4$$

$$Q_{\max} = \bar{y}'A' = 1.5(3)(8) = 36 \text{ in}^3$$

$$\tau_{\max} = \frac{VQ_{\max}}{It} = \frac{17(10^3)(36)}{144(8)} = 531 \text{ psi} \quad \text{Ans}$$

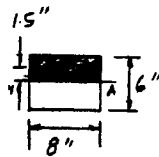

From *Mechanics of Materials*, Sixth Edition by R. C. Hibbeler, ISBN 0-13-191345-X.

© 2005 R. C. Hibbeler. Published by Pearson Prentice Hall,

Pearson Education, Inc., Upper Saddle River, NJ. All rights reserved.

This material is protected under all copyright laws as they currently exist. No portion of this material may be reproduced, in any form or by any means, without permission in writing from the publisher.

7-29 Determine the shear stress at point B on the web of the cantilevered strut at section a-a.

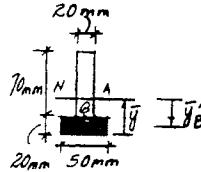
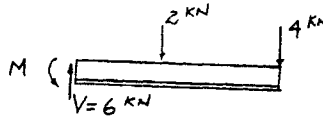
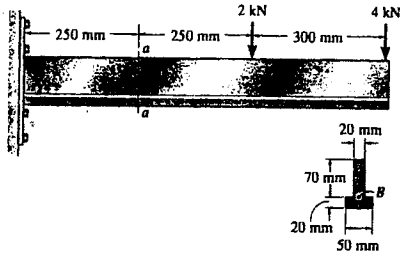

$$\bar{y} = \frac{(0.01)(0.05)(0.02) + (0.055)(0.07)(0.02)}{(0.05)(0.02) + (0.07)(0.02)} = 0.03625 \text{ m}$$

$$I = \frac{1}{12}(0.05)(0.02^3) + (0.05)(0.02)(0.03625 - 0.01)^2 + \frac{1}{12}(0.02)(0.07^3) + (0.02)(0.07)(0.055 - 0.03625)^2 = 1.78625(10^{-6}) \text{ m}^4$$

$$\bar{y}'_B = 0.03625 - 0.01 = 0.02625 \text{ m}$$

$$Q_B = (0.02)(0.05)(0.02625) = 26.25(10^{-6}) \text{ m}^3$$

$$\tau_B = \frac{VQ_B}{I t} = \frac{6(10^3)(26.25)(10^{-6})}{1.78622(10^{-6})(0.02)} = 4.41 \text{ MPa} \quad \text{Ans}$$

From *Mechanics of Materials*, Sixth Edition by R. C. Hibbeler, ISBN 0-13-191345-X.

© 2005 R. C. Hibbeler. Published by Pearson Prentice Hall,

Pearson Education, Inc., Upper Saddle River, NJ. All rights reserved.

This material is protected under all copyright laws as they currently exist. No portion of this material may be reproduced, in any form or by any means, without permission in writing from the publisher.

7-30 Determine the maximum shear stress acting at section $a-a$ of the cantilevered strut.

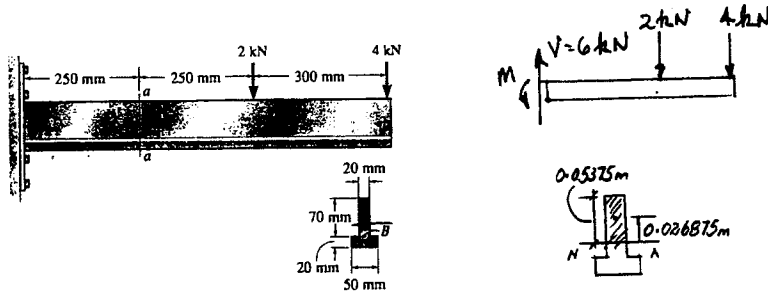

$$\bar{y} = \frac{(0.01)(0.05)(0.02) + (0.055)(0.07)(0.02)}{(0.05)(0.02) + (0.07)(0.02)} = 0.03625 \text{ m}$$

$$I = \frac{1}{12}(0.05)(0.02^3) + (0.05)(0.02)(0.03625 - 0.01)^2 + \frac{1}{12}(0.02)(0.07^3) + (0.02)(0.07)(0.055 - 0.03625)^2 = 1.78625(10^{-6}) \text{ m}^4$$

$$Q_{\max} = \bar{y}' A' = (0.026875)(0.05375)(0.02) = 28.8906(10^{-6}) \text{ m}^3$$

$$\tau_{\max} = \frac{VQ_{\max}}{It} = \frac{6(10^3)(28.8906)(10^{-6})}{1.78625(10^{-6})(0.02)} = 4.85 \text{ MPa} \quad \text{Ans}$$

From *Mechanics of Materials*, Sixth Edition by R. C. Hibbeler, ISBN 0-13-191345-X.

© 2005 R. C. Hibbeler. Published by Pearson Prentice Hall,

Pearson Education, Inc., Upper Saddle River, NJ. All rights reserved.

This material is protected under all copyright laws as they currently exist. No portion of this material may be reproduced, in any form or by any means, without permission in writing from the publisher.

7-31 The composite beam is constructed from wood and reinforced with a steel strap. Use the method of Sec. 6.6 and compute the maximum shear stress in the beam when it is subjected to a vertical shear of $V = 50$ kN. Take $E_{st} = 200$ GPa, $E_w = 15$ GPa.

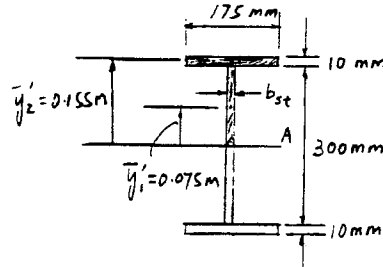
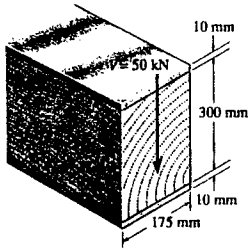

$$b_{st} = nb_w = \frac{15}{200}(0.175) = 0.013125 \text{ m}$$

$$I = \frac{1}{12}(0.175)(0.32^3) - \frac{1}{12}(0.175 - 0.013125)(0.3^3) = 0.113648(10^{-3}) \text{ m}^4$$

$$Q_{\max} = \Sigma \bar{y}'A' = 0.075(0.013125)(0.15) + 0.155(0.175)(0.01) = 0.4189(10^{-3}) \text{ m}^3$$

$$\begin{aligned} \tau_{\max} &= n \frac{VQ_{\max}}{I t} = \left(\frac{15}{200} \right) \frac{50(10^3)(0.4189)(10^{-3})}{0.113648(10^{-3})(0.013125)} \\ &= 1.05 \text{ MPa} \quad \text{Ans} \end{aligned}$$

From *Mechanics of Materials*, Sixth Edition by R. C. Hibbeler, ISBN 0-13-191345-X.

© 2005 R. C. Hibbeler. Published by Pearson Prentice Hall,

Pearson Education, Inc., Upper Saddle River, NJ. All rights reserved.

This material is protected under all copyright laws as they currently exist. No portion of this material may be reproduced, in any form or by any means, without permission in writing from the publisher.

Because of the number and variety of potential correct solutions to this problem, no solution is being given.

From *Mechanics of Materials*, Sixth Edition by R. C. Hibbeler, ISBN 0-13-191345-X.

© 2005 R. C. Hibbeler. Published by Pearson Prentice Hall,

Pearson Education, Inc, Upper Saddle River, NJ. All rights reserved.

This material is protected under all copyright laws as they currently exist. No portion of this material may be reproduced, in any form or by any means, without permission in writing from the publisher.

Because of the number and variety of potential correct solutions to this problem, no solution is being given.

From *Mechanics of Materials*, Sixth Edition by R. C. Hibbeler, ISBN 0-13-191345-X.

© 2005 R. C. Hibbeler. Published by Pearson Prentice Hall,

Pearson Education, Inc, Upper Saddle River, NJ. All rights reserved.

This material is protected under all copyright laws as they currently exist. No portion of this material may be reproduced, in any form or by any means, without permission in writing from the publisher.

7-34. The beam has a rectangular cross section and is subjected to a load P that is just large enough to develop a fully plastic moment $M_p = PL$ at the fixed support. If the material is elastic-plastic, then at a distance $x < L$ the moment $M = Px$ creates a region of plastic yielding with an associated elastic core having a height $2y'$. This situation has been described by Eq. 6-30 and the moment M is distributed over the cross section as shown in Fig. 6-54e. Prove that the maximum shear stress developed in the beam is given by $\tau_{\max} = \frac{3}{2}(P/A')$, where $A' = 2y'b$, the cross-sectional area of the elastic core.

Force Equilibrium : The shaded area indicates the plastic zone. Isolate an element in the plastic zone and write the equation of equilibrium.

$$\begin{aligned} \rightarrow \Sigma F_x = 0; \quad \tau_{\text{long}} A_2 + \sigma_Y A_1 - \sigma_Y A_1 &= 0 \\ \tau_{\text{long}} &= 0 \end{aligned}$$

This proves that the longitudinal shear stress, τ_{long} , is equal to zero. Hence the corresponding transverse stress, τ_{trans} , is also equal to zero in the plastic zone. Therefore, the shear force $V = P$ is carried by the material only in the elastic zone.

Section Properties :

$$\begin{aligned} I_{NA} &= \frac{1}{12}(b)(2y')^3 = \frac{2}{3}by'^3 \\ Q_{\max} &= \bar{y}'A' = \frac{y'}{2}(y')(b) = \frac{y'^2b}{2} \end{aligned}$$

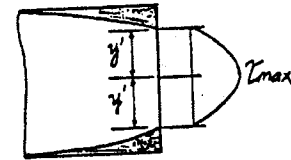
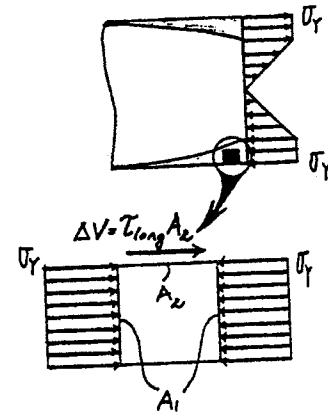

Maximum Shear Stress : Applying the shear formula

$$\tau_{\max} = \frac{VQ_{\max}}{It} = \frac{V\left(\frac{y'^2b}{2}\right)}{\left(\frac{2}{3}by'^3\right)(b)} = \frac{3P}{4by'}$$

However, $A' = 2by'$ hence

$$\tau_{\max} = \frac{3P}{2A'} \quad (Q.E.D.)$$

From *Mechanics of Materials*, Sixth Edition by R. C. Hibbeler, ISBN 0-13-191345-X.

© 2005 R. C. Hibbeler. Published by Pearson Prentice Hall,

Pearson Education, Inc., Upper Saddle River, NJ. All rights reserved.

This material is protected under all copyright laws as they currently exist. No portion of this material may be reproduced, in any form or by any means, without permission in writing from the publisher.

7-35. The beam in Fig. 6-54f is subjected to a fully plastic moment M_p . Prove that the longitudinal and transverse shear stresses in the beam are zero. *Hint:* Consider an element of the beam as shown in Fig. 7-4d.

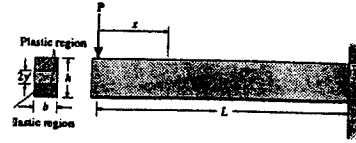

Force Equilibrium : If a fully plastic moment acts on the cross section, then an element of the material taken from the top or bottom of the cross section is subjected to the loading shown. For equilibrium

$$\begin{aligned} \sum F_x = 0; \quad \sigma_y A_1 + \tau_{long} A_2 - \sigma_y A_1 &= 0 \\ \tau_{long} &= 0 \end{aligned}$$

Thus no shear stress is developed on the longitudinal or transverse plane of the element. (Q. E. D.)

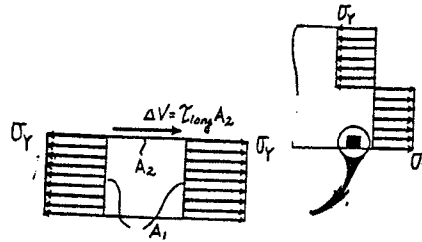

From *Mechanics of Materials*, Sixth Edition by R. C. Hibbeler, ISBN 0-13-191345-X.
 © 2005 R. C. Hibbeler. Published by Pearson Prentice Hall,
 Pearson Education, Inc., Upper Saddle River, NJ. All rights reserved.
 This material is protected under all copyright laws as they currently exist. No portion of this material may be reproduced, in any form or by any means, without permission in writing from the publisher.

*7-36 The beam is constructed from three boards. If it is subjected to a shear of $V = 5$ kip, determine the spacing s of the nails used to hold the top and bottom flanges to the web. Each nail can support a shear force of 500 lb.

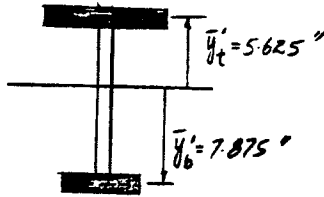
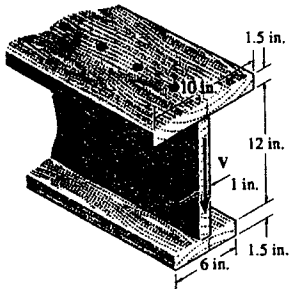

$$\bar{y} = \frac{0.75(10)(1.5) + 7.5(12)(1) + 14.25(6)(1.5)}{10(1.5) + 12(1) + 6(1.5)} = 6.375 \text{ in.}$$

$$I = \frac{1}{12}(10)(1.5^3) + 10(1.5)(6.375 - 0.75)^2 + \frac{1}{12}(1)(12^3) + (1)(12)(7.5 - 6.375)^2 + \frac{1}{12}(6)(1.5^3) + (1.5)(6)(14.25 - 6.375)^2 = 1196.4375 \text{ in}^4$$

$$Q_t = \bar{y}_t' A' = 5.625(10)(1.5) = 84.375 \text{ in}^3$$

$$Q_b = \bar{y}_b' A' = 7.875(6)(1.5) = 70.875 \text{ in}^3$$

$$q_t = \frac{V Q_t}{I} = \frac{5(10^3)(84.375)}{1196.4375} = 352.61 \text{ lb/in.}$$

$$q_b = \frac{V Q_b}{I} = \frac{5(10^3)(70.875)}{1196.4375} = 296.19 \text{ lb/in.}$$

$$F = q s; \quad s = \frac{F}{q}$$

$$s_t = \frac{500}{352.61} = 1.42 \text{ in.} \quad \text{Ans}$$

$$s_b = \frac{500}{296.19} = 1.69 \text{ in.} \quad \text{Ans}$$

From *Mechanics of Materials*, Sixth Edition by R. C. Hibbeler, ISBN 0-13-191345-X.

© 2005 R. C. Hibbeler. Published by Pearson Prentice Hall,

Pearson Education, Inc., Upper Saddle River, NJ. All rights reserved.

This material is protected under all copyright laws as they currently exist. No portion of this material may be reproduced, in any form or by any means, without permission in writing from the publisher.

7-37. The beam is constructed from three boards. Determine the maximum shear V that it can sustain if the allowable shear stress for the wood is $\tau_{\text{allow}} = 400$ psi. What is the required spacing s of the nails if each nail can resist a shear force of 400 lb?

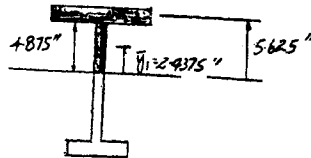
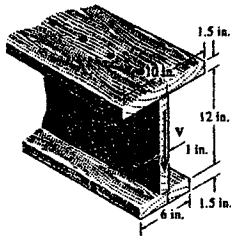

$$\bar{y} = \frac{0.75(10)(1.5) + 7.5(12)(1) + 14.25(6)(1.5)}{10(1.5) + 12(1) + 6(1.5)} = 6.375 \text{ in.}$$

$$I = \frac{1}{12}(10)(1.5^3) + 10(1.5)(6.375 - 0.75)^2 + \frac{1}{12}(1)(12^3) + (1)(12)(7.5 - 6.375)^2 + \frac{1}{12}(6)(1.5^3) + (1.5)(6)(14.25 - 6.375)^2 = 1196.4375 \text{ in}^4$$

$$Q_{\text{max}} = \Sigma \bar{y}'A' = 5.625(10)(1.5) + 2.4375(4.875)(1) = 96.258 \text{ in}^3$$

$$\tau_{\text{max}} = \tau_{\text{allow}} = \frac{VQ_{\text{max}}}{I t}$$

$$0.4 = \frac{V(96.258)}{1196.4375(1)}$$

$$V = 4.97 \text{ kip} \quad \text{Ans}$$

$$Q_t = \bar{y}_t' A' = 5.625(10)(1.5) = 84.375 \text{ in}^3$$

$$Q_b = \bar{y}_b' A' = 7.875(6)(1.5) = 70.875 \text{ in}^3$$

$$q_t = \frac{4.9718(10^3)(84.375)}{1196.4375} = 350.62 \text{ lb/in.}$$

$$q_b = \frac{4.9718(10^3)(70.875)}{1196.4375} = 294.52 \text{ lb/in.}$$

$$s = \frac{F}{q}$$

$$s_t = \frac{400}{350.62} = 1.14 \text{ in.} \quad \text{Ans}$$

$$s_b = \frac{400}{294.52} = 1.36 \text{ in.} \quad \text{Ans}$$

From *Mechanics of Materials*, Sixth Edition by R. C. Hibbeler, ISBN 0-13-191345-X.

© 2005 R. C. Hibbeler. Published by Pearson Prentice Hall,

Pearson Education, Inc., Upper Saddle River, NJ. All rights reserved.

This material is protected under all copyright laws as they currently exist. No portion of this material may be reproduced, in any form or by any means, without permission in writing from the publisher.

7-38. The box beam is made from four pieces of plastic that are glued together as shown. If the glue has an allowable strength of 400 lb/in^2 , determine the maximum shear the beam will support.

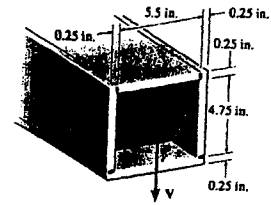

$$I = \frac{1}{12}(6)(5.25^3) - \frac{1}{12}(5.5)(4.75^3) = 23.231 \text{ in}^4$$

$$Q_B = \bar{y}'A' = 2.5(6)(0.25) = 3.75 \text{ in}^3$$

The beam will fail at the glue joint for board B since Q is a maximum for this board.

$$\tau_{\text{allow}} = \frac{VQ_B}{It}; \quad 400 = \frac{V(3.75)}{23.231(2)(0.25)}$$

$$V = 1239 \text{ lb} = 1.24 \text{ kip} \quad \text{Ans}$$

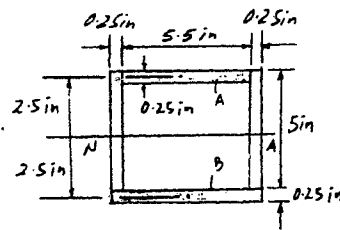

From *Mechanics of Materials*, Sixth Edition by R. C. Hibbeler, ISBN 0-13-191345-X.

© 2005 R. C. Hibbeler. Published by Pearson Prentice Hall,

Pearson Education, Inc., Upper Saddle River, NJ. All rights reserved.

This material is protected under all copyright laws as they currently exist. No portion of this material may be reproduced, in any form or by any means, without permission in writing from the publisher.

7-39 The box beam is made from four pieces of plastic that are glued together as shown. If the shear $V = 2$ kip, determine the shear stress resisted by the seam at each of the glued joints.

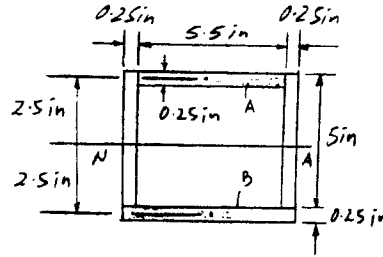
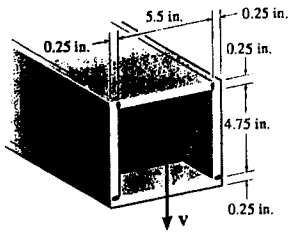

$$I = \frac{1}{12}(6)(5.25^3) - \frac{1}{12}(5.5)(4.75^3) = 23.231 \text{ in}^4$$

$$Q_B = \bar{y}'A' = 2.5(6)(0.25) = 3.75 \text{ in}^3$$

$$Q_A = 2.5(5.5)(0.25) = 3.4375$$

$$\tau_B = \frac{VQ_B}{It} = \frac{2(10^3)(3.75)}{23.231(2)(0.25)} = 646 \text{ psi} \quad \text{Ans}$$

$$\tau_A = \frac{VQ_A}{It} = \frac{2(10^3)(3.4375)}{23.231(2)(0.25)} = 592 \text{ psi} \quad \text{Ans}$$

From *Mechanics of Materials*, Sixth Edition by R. C. Hibbeler, ISBN 0-13-191345-X.

© 2005 R. C. Hibbeler. Published by Pearson Prentice Hall,

Pearson Education, Inc., Upper Saddle River, NJ. All rights reserved.

This material is protected under all copyright laws as they currently exist. No portion of this material may be reproduced, in any form or by any means, without permission in writing from the publisher.

*7-40 The beam is subjected to a shear of $V = 800$ N. Determine the average shear stress developed in the nails along the sides A and B if the nails are spaced $s = 100$ mm apart. Each nail has a diameter of 2 mm.

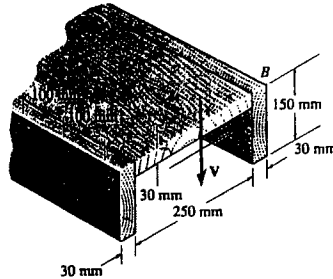

$$\bar{y} = \frac{0.015(0.03)(0.25) + 2(0.075)(0.15)(0.03)}{0.03(0.25) + 2(0.15)(0.03)} = 0.04773 \text{ m}$$

$$I = \frac{1}{12}(0.25)(0.03^3) + (0.25)(0.03)(0.04773 - 0.015)^2 + 2\left(\frac{1}{12}\right)(0.03)(0.15^3) + 2(0.03)(0.15)(0.075 - 0.04773)^2 = 32.164773(10^{-6}) \text{ m}^4$$

$$Q = \bar{y}'A' = 0.03273(0.25)(0.03) = 0.245475(10^{-3}) \text{ m}^3$$

$$q = \frac{VQ}{I} = \frac{800(0.245475)(10^{-3})}{32.164773(10^{-6})} = 6105.44 \text{ N/m}$$

$$F = qs = 6105.44(0.1) = 610.544 \text{ N}$$

Since each side of the beam resists this shear force then

$$\tau_{avg} = \frac{F}{2A} = \frac{610.544}{2\left(\frac{\pi}{4}\right)(0.002^2)} = 97.2 \text{ MPa} \quad \text{Ans}$$

From *Mechanics of Materials*, Sixth Edition by R. C. Hibbeler, ISBN 0-13-191345-X.

© 2005 R. C. Hibbeler. Published by Pearson Prentice Hall,

Pearson Education, Inc., Upper Saddle River, NJ. All rights reserved.

This material is protected under all copyright laws as they currently exist. No portion of this material may be reproduced, in any form or by any means, without permission in writing from the publisher.

7-41 The double T-beam is fabricated by welding the three plates together as shown. Determine the shear stress in the weld necessary to support the shear force of $V = 80 \text{ kN}$.

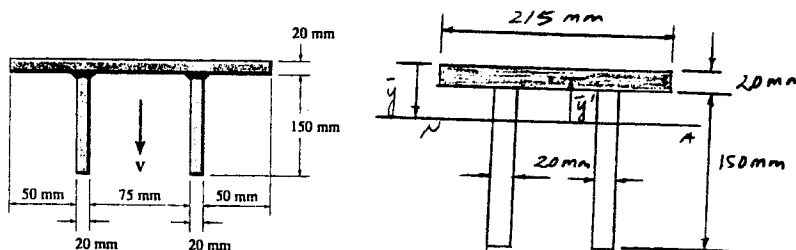

$$\bar{y} = \frac{\sum \bar{y}A}{\sum A} = \frac{0.01(0.215)(0.02) + 2[0.095(0.15)(0.02)]}{0.215(0.02) + 2(0.15)(0.02)} = 0.059515 \text{ m}$$

$$I = \frac{1}{12}(0.215)(0.02^3) + 0.215(0.02)(0.059515 - 0.01)^2 + 2\left[\frac{1}{12}(0.02)(0.15^3) + 0.02(0.15)(0.095 - 0.059515)^2\right] = 29.4909(10^{-6}) \text{ m}^4$$

$$\bar{y}' = 0.059515 - 0.01 = 0.049515 \text{ m}$$

$$Q = \bar{y}'A' = 0.049515(0.215)(0.02) = 0.2129(10^{-3}) \text{ m}^3$$

Shear stress :

$$\tau = \frac{VQ}{It} = \frac{80(10^3)(0.2129)(10^{-3})}{29.4909(10^{-6})(2)(0.02)} = 14.4 \text{ MPa} \quad \text{Ans}$$

From *Mechanics of Materials*, Sixth Edition by R. C. Hibbeler, ISBN 0-13-191345-X.

© 2005 R. C. Hibbeler. Published by Pearson Prentice Hall,

Pearson Education, Inc., Upper Saddle River, NJ. All rights reserved.

This material is protected under all copyright laws as they currently exist. No portion of this material may be reproduced, in any form or by any means, without permission in writing from the publisher.

7-42 The double T-beam is fabricated by welding the three plates together as shown. If the weld can resist a shear stress $\tau_{\text{allow}} = 90 \text{ MPa}$, determine the maximum shear V that can be applied to the beam.

$$\bar{y} = \frac{\sum \bar{y}A}{\sum A} = \frac{0.01(0.215)(0.02) + 2[0.095(0.15)(0.02)]}{0.215(0.02) + 2(0.15)(0.02)} = 0.059515 \text{ m}$$

$$I = \frac{1}{12}(0.215)(0.02^3) + 0.215(0.02)(0.059515 - 0.01)^2 + 2\left[\frac{1}{12}(0.02)(0.15^3) + 0.02(0.15)(0.095 - 0.059515)^2\right] = 29.4909(10^{-6}) \text{ m}^4$$

$$\bar{y}' = 0.059515 - 0.01 = 0.049515 \text{ m}$$

$$Q = \bar{y}'A' = 0.049515(0.215)(0.02) = 0.2129(10^{-3}) \text{ m}^3$$

$$\tau = \frac{VQ}{It}$$

$$90(10^6) = \frac{V(0.2129)(10^{-3})}{29.491(10^{-6})(2)(0.02)}$$

$$V = 499 \text{ kN} \quad \text{Ans}$$

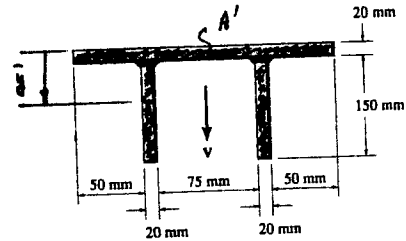

From *Mechanics of Materials*, Sixth Edition by R. C. Hibbeler, ISBN 0-13-191345-X.

© 2005 R. C. Hibbeler. Published by Pearson Prentice Hall,

Pearson Education, Inc., Upper Saddle River, NJ. All rights reserved.

This material is protected under all copyright laws as they currently exist. No portion of this material may be reproduced, in any form or by any means, without permission in writing from the publisher.

7-43. The double-web girder is constructed from two plywood sheets that are secured to wood members at its top and bottom. If each fastener can support 600 lb in single shear, determine the required spacing s of the fasteners needed to support the loading $P = 3000$ lb. Assume A is pinned and B is a roller.

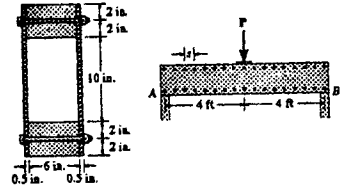

Support Reactions : As shown on FBD.

Internal Shear Force : As shown on shear diagram,
 $V_{max} = 1500$ lb.

Section Properties :

$$I_{NA} = \frac{1}{12}(7)(18^3) - \frac{1}{12}(6)(10^3) = 2902 \text{ in}^4$$

$$Q = \bar{y}'A' = 7(4)(6) = 168 \text{ in}^3$$

Shear Flow : Since there are two shear planes on the bolt, the allowable shear flow is $q = \frac{2(600)}{s} = \frac{1200}{s}$.

$$q = \frac{VQ}{I}$$

$$\frac{1200}{s} = \frac{1500(168)}{2902}$$

$$s = 13.8 \text{ in.}$$

Ans

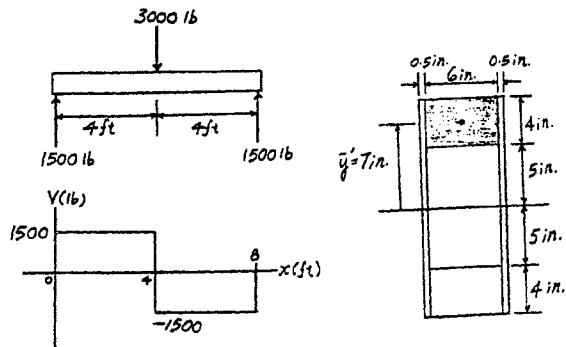

From *Mechanics of Materials*, Sixth Edition by R. C. Hibbeler, ISBN 0-13-191345-X.
 © 2005 R. C. Hibbeler. Published by Pearson Prentice Hall,
 Pearson Education, Inc., Upper Saddle River, NJ. All rights reserved.
 This material is protected under all copyright laws as they currently exist. No portion of this material may be reproduced, in any form or by any means, without permission in writing from the publisher.

***7-44.** The double-web girder is constructed from two plywood sheets that are secured to wood members at its top and bottom. The allowable bending stress for the wood is $\sigma_{\text{allow}} = 8 \text{ ksi}$ and the allowable shear stress is $\tau_{\text{allow}} = 3 \text{ ksi}$. If the fasteners are spaced $s = 6 \text{ in.}$ and each fastener can support 600 lb in single shear, determine the maximum load P that can be applied to the beam.

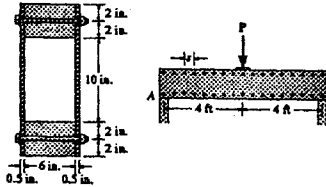

Support Reactions : As shown on FBD.

Internal Shear Force and Moment : As shown on shear and moment diagram, $V_{\text{max}} = 0.500P$ and $M_{\text{max}} = 2.00P$.

Section Properties :

$$I_{NA} = \frac{1}{12}(7)(18^3) - \frac{1}{12}(6)(10^3) = 2902 \text{ in}^4$$

$$Q = \bar{y}'_2 A' = 7(4)(6) = 168 \text{ in}^3$$

$$Q_{\text{max}} = \Sigma \bar{y}' A' = 7(4)(6) + 4.5(9)(1) = 208.5 \text{ in}^3$$

Shear Flow : Assume bolt failure. Since there are two shear planes on the bolt, the allowable shear flow is $q = \frac{2(600)}{6} = 200 \text{ lb/in.}$

$$q = \frac{VQ}{I}$$

$$200 = \frac{0.500P(168)}{2902}$$

$$P = 6910 \text{ lb} = 6.91 \text{ kip (Controls!)} \quad \text{Ans}$$

Shear Stress : Assume failure due to shear stress.

$$\tau_{\text{max}} = \tau_{\text{allow}} = \frac{VQ_{\text{max}}}{It}$$

$$3000 = \frac{0.500P(208.5)}{2902(1)}$$

$$P = 22270 \text{ lb} = 83.5 \text{ kip}$$

Bending Stress : Assume failure due to bending stress.

$$\sigma_{\text{max}} = \sigma_{\text{allow}} = \frac{Mc}{I}$$

$$8(10^3) = \frac{2.00P(12)(9)}{2902}$$

$$P = 107 \text{ ksi}$$

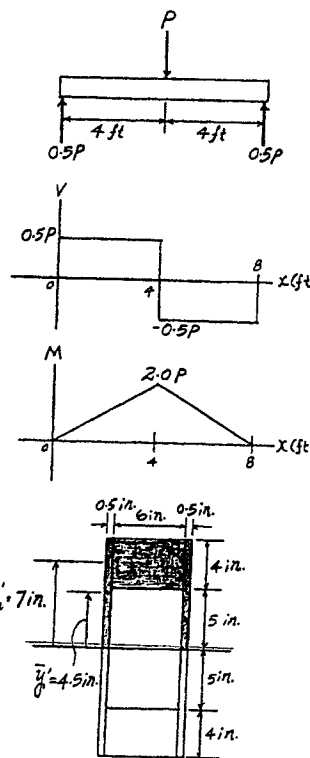

From *Mechanics of Materials*, Sixth Edition by R. C. Hibbeler, ISBN 0-13-191345-X.

© 2005 R. C. Hibbeler. Published by Pearson Prentice Hall,

Pearson Education, Inc., Upper Saddle River, NJ. All rights reserved.

This material is protected under all copyright laws as they currently exist. No portion of this material may be reproduced, in any form or by any means, without permission in writing from the publisher.

7-45. The beam is made from three polystyrene strips that are glued together as shown. If the glue has a shear strength of 80 kPa, determine the maximum load P that can be applied without causing the glue to lose its bond.

Maximum shear is at the supports.

$$V_{\max} = \frac{3P}{4}$$

$$I = \frac{1}{12}(0.02)(0.06)^3 + 2\left[\frac{1}{12}(0.03)(0.04)^3 + (0.03)(0.04)(0.05)^2\right] = 6.68(10^{-6})\text{m}^4$$

$$\tau = \frac{VQ}{It}; \quad 80(10^3) = \frac{(3P/4)(0.05)(0.04)(0.03)}{6.68(10^{-6})(0.02)}$$

$$P = 238 \text{ N} \quad \text{Ans}$$

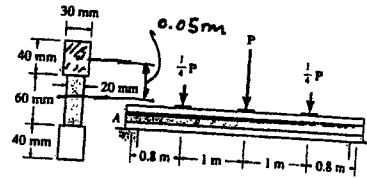

From *Mechanics of Materials*, Sixth Edition by R. C. Hibbeler, ISBN 0-13-191345-X.
 © 2005 R. C. Hibbeler. Published by Pearson Prentice Hall,
 Pearson Education, Inc., Upper Saddle River, NJ. All rights reserved.
 This material is protected under all copyright laws as they currently exist. No portion of this material may be reproduced, in any form or by any means, without permission in writing from the publisher.

7-46. A beam is constructed from three boards bolted together as shown. Determine the shear force developed in each bolt if the bolts are spaced $s = 250$ mm apart and the applied shear is $V = 35$ kN.

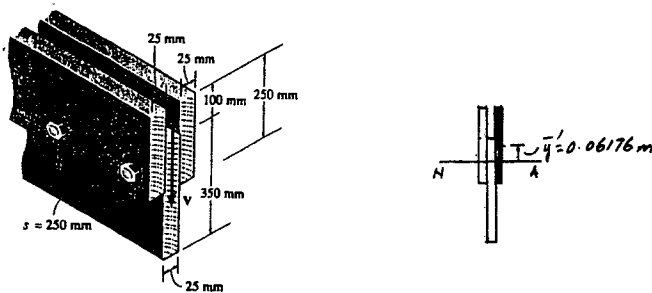

$$\bar{y} = \frac{2(0.125)(0.25)(0.025) + 0.275(0.35)(0.025)}{2(0.25)(0.025) + 0.35(0.025)} = 0.18676 \text{ m}$$

$$I = (2)\left(\frac{1}{12}\right)(0.025)(0.25^3) + 2(0.025)(0.25)(0.18676 - 0.125)^2 \\ + \frac{1}{12}(0.025)(0.35)^3 + (0.025)(0.35)(0.275 - 0.18676)^2 \\ = 0.270236 (10^{-3}) \text{ m}^4$$

$$Q = \bar{y}A' = 0.06176(0.025)(0.25) = 0.386(10^{-3}) \text{ m}^3$$

$$q = \frac{VQ}{I} = \frac{35(0.386)(10^{-3})}{0.270236(10^{-3})} = 49.993 \text{ kN/m}$$

$$F = q(s) = 49.993(0.25) = 12.5 \text{ kN} \quad \text{Ans}$$

From *Mechanics of Materials*, Sixth Edition by R. C. Hibbeler, ISBN 0-13-191345-X.

© 2005 R. C. Hibbeler. Published by Pearson Prentice Hall,

Pearson Education, Inc., Upper Saddle River, NJ. All rights reserved.

This material is protected under all copyright laws as they currently exist. No portion of this material may be reproduced, in any form or by any means, without permission in writing from the publisher.

7-47 The box beam is constructed from four boards that are fastened together using nails spaced along the beam every 2 in. If each nail can resist a shear of 50 lb, determine the greatest shear V that can be applied to the beam without causing failure of the nails.

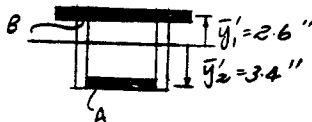
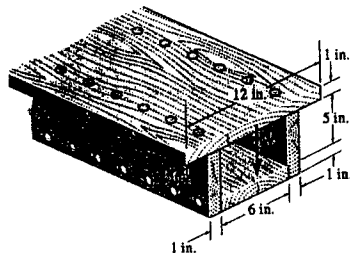

$$\bar{y} = \frac{\sum \bar{y} A}{\sum A} = \frac{0.5(12)(1) + 2(4)(6)(1) + (6.5)(6)(1)}{12(1) + 2(6)(1) + (6)(1)} = 3.1 \text{ in.}$$

$$I = \frac{1}{12}(12)(1)^3 + 12(1)(3.1 - 0.5)^2 + 2\left(\frac{1}{12}\right)(1)(6^3) + 2(1)(6)(4 - 3.1)^2 + \frac{1}{12}(6)(1)^3 + 6(1)(6.5 - 3.1)^2 = 197.7 \text{ in}^4$$

$$Q_B = \bar{y}_1' A' = 2.6(12)(1) = 31.2 \text{ in}^3$$

$$q_B = \frac{1}{2} \left(\frac{V Q_B}{I} \right) = \frac{V(31.2)}{2(197.7)} = 0.0789 V$$

$$q_B s = 0.0789V(2) = 50$$

$$V = 317 \text{ lb (controls) Ans}$$

$$Q_A = \bar{y}_2' A' = 3.4(6)(1) = 20.4 \text{ in}^3$$

$$q_A = \frac{1}{2} \left(\frac{V Q_A}{I} \right) = \frac{V(20.4)}{2(197.7)} = 0.0516 V$$

$$q_A s = 0.0516V(2) = 50$$

$$V = 485 \text{ lb}$$

From *Mechanics of Materials*, Sixth Edition by R. C. Hibbeler, ISBN 0-13-191345-X.

© 2005 R. C. Hibbeler. Published by Pearson Prentice Hall,

Pearson Education, Inc., Upper Saddle River, NJ. All rights reserved.

This material is protected under all copyright laws as they currently exist. No portion of this material may be reproduced, in any form or by any means, without permission in writing from the publisher.

Because of the number and variety of potential correct solutions to this problem, no solution is being given.

From *Mechanics of Materials*, Sixth Edition by R. C. Hibbeler, ISBN 0-13-191345-X.

© 2005 R. C. Hibbeler. Published by Pearson Prentice Hall,

Pearson Education, Inc, Upper Saddle River, NJ. All rights reserved.

This material is protected under all copyright laws as they currently exist. No portion of this material may be reproduced, in any form or by any means, without permission in writing from the publisher.

Because of the number and variety of potential correct solutions to this problem, no solution is being given.

From *Mechanics of Materials*, Sixth Edition by R. C. Hibbeler, ISBN 0-13-191345-X.

© 2005 R. C. Hibbeler. Published by Pearson Prentice Hall,

Pearson Education, Inc, Upper Saddle River, NJ. All rights reserved.

This material is protected under all copyright laws as they currently exist. No portion of this material may be reproduced, in any form or by any means, without permission in writing from the publisher.

7-50 The box beam is constructed from four boards that are fastened together using nails spaced along the beam every 2 in. If each nail can resist a shear force of 50 lb, determine the largest force P that can be applied to the beam without causing failure of the nails.

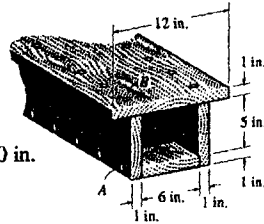
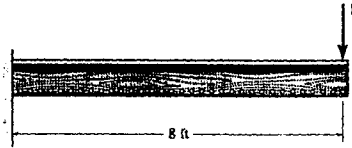
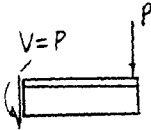

Shear force : $V = P$

$$\bar{y} = \frac{\sum \bar{y}A}{\sum A} = \frac{0.5(12)(1) + 2[4(6)(1)] + 6.5(6)(1)}{12(1) + 2(6)(1) + 6(1)} = 3.10 \text{ in.}$$

$$I = \frac{1}{12}(12)(1^3) + 12(1)(3.10 - 0.5)^2 + 2\left[\frac{1}{12}(1)(6^3) + (1)(6)(4 - 3.10)^2\right] + \frac{1}{12}(6)(1^3) + 6(1)(6.5 - 3.10)^2 = 197.7 \text{ in}^4$$

$$Q_B = \bar{y}_B' A' = (3.10 - 0.5)(12)(1) = 31.2 \text{ in}^3$$

$$Q_A = \bar{y}_A' A' = (6.5 - 3.10)(6)(1) = 20.4 \text{ in}^3$$

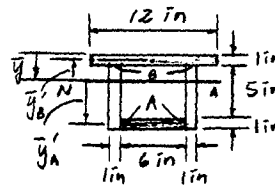

For B :

$$q_B = \frac{VQ_B}{I} = \frac{P(31.2)}{197.7} = 0.1578 P, \quad \text{however } q = \frac{2(50)}{2} = 50 \text{ lb/in.}$$

$$50 = 0.1578 P$$

$$P = 317 \text{ lb (controls) } \quad \text{Ans}$$

For A :

$$q_A = \frac{VQ_A}{I} = \frac{P(20.4)}{197.7} = 0.1032 P \quad \text{However } q = \frac{2(50)}{2} = 50 \text{ lb/in.}$$

$$50 = 0.1032 P$$

$$P = 485 \text{ lb}$$

From *Mechanics of Materials*, Sixth Edition by R. C. Hibbeler, ISBN 0-13-191345-X.

© 2005 R. C. Hibbeler. Published by Pearson Prentice Hall,

Pearson Education, Inc., Upper Saddle River, NJ. All rights reserved.

This material is protected under all copyright laws as they currently exist. No portion of this material may be reproduced, in any form or by any means, without permission in writing from the publisher.

7-51 The box beam is constructed from four boards that are fastened together using nails spaced along the beam every 2 in. If a force $P = 2$ kip is applied to the beam, determine the shear force resisted by each nail at A and B .

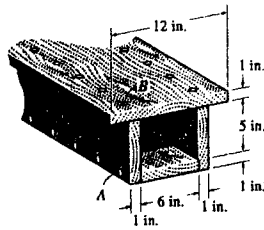
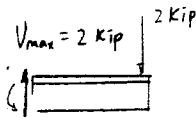
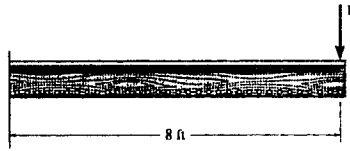

As shown on FBD, $V_{max} = 2$ kip

$$\bar{y} = \frac{\sum \bar{y}A}{\sum A} = \frac{0.5(12)(1) + 2[4(6)(1)] + 6.5(6)(1)}{12(1) + 2(6)(1) + 6(1)} = 3.10 \text{ in.}$$

$$I = \frac{1}{12}(12)(1)^3 + 12(1)(3.10 - 0.5)^2 + 2\left[\frac{1}{12}(1)(6^3) + (1)(6)(4 - 3.10)^2\right] + \frac{1}{12}(6)(1)^3 + 6(1)(6.5 - 3.10)^2 = 197.7 \text{ in}^4$$

$$Q_B = \bar{y}_B' A' = (3.10 - 0.5)(12)(1) = 31.2 \text{ in}^3$$

$$Q_A = \bar{y}_A' A' = (6.5 - 3.10)(6)(1) = 20.4 \text{ in}^3$$

$$V = P = 2 \text{ kip}$$

$$q_B = \frac{1}{2} \left(\frac{VQ_B}{I} \right) = \frac{1}{2} \left[\frac{2(31.2)}{197.7} \right] = 157.81 \text{ lb/in.}$$

$$q_A = \frac{1}{2} \left(\frac{VQ_A}{I} \right) = \frac{1}{2} \left[\frac{2(20.4)}{197.7} \right] = 103.19 \text{ lb/in.}$$

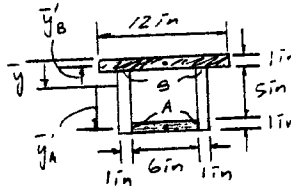

Shear force in nail :

$$F_B = q_B s = 157.81(2) = 316 \text{ lb} \quad \text{Ans}$$

$$F_A = q_A s = 103.19(2) = 206 \text{ lb} \quad \text{Ans}$$

From *Mechanics of Materials*, Sixth Edition by R. C. Hibbeler, ISBN 0-13-191345-X.

© 2005 R. C. Hibbeler. Published by Pearson Prentice Hall,

Pearson Education, Inc., Upper Saddle River, NJ. All rights reserved.

This material is protected under all copyright laws as they currently exist. No portion of this material may be reproduced, in any form or by any means, without permission in writing from the publisher.

*7-52 The beam is constructed from three boards. If it is subjected to loads of $P = 5$ kip, determine the spacing s of the nails within regions AC , CD , and DB used to hold the top and bottom flanges to the web. Each nail can support a shear force of 500 lb.

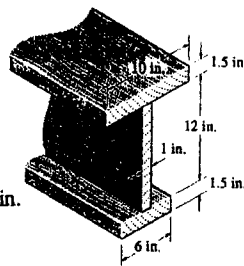
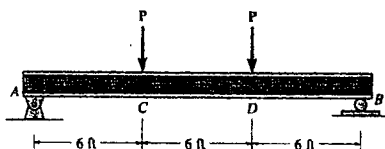

Shear force : Shear force in region BD is equal to shear force in region AC due to the symmetrical loading and geometry

$$\bar{y} = \frac{\sum \bar{y}A}{\sum A} = \frac{0.75(10)(1.5) + 7.5(12)(1) + 14.25(6)(1.5)}{10(1.5) + 12(1) + 6(1.5)} = 6.375 \text{ in.}$$

$$I = \frac{1}{12}(10)(1.5^3) + 10(1.5)(6.375 - 0.75)^2 + \frac{1}{12}(1)(12^3) + 1(12)(7.5 - 6.375)^2 + \frac{1}{12}(6)(1.5^3) + 6(1.5)(14.25 - 6.375)^2 = 1196.4375 \text{ in}^4$$

$$Q_A = \bar{y}'_A A' = 5.625(10)(1.5) = 84.375 \text{ in}^3$$

$$Q_B = \bar{y}'_B A' = 7.875(6)(1.5) = 70.875 \text{ in}^3$$

For region AC and BD , $V = 5$ kip

$$q_A = \frac{VQ_A}{I} = \frac{5(10^3)(84.375)}{1196.4375} = 352.61 \text{ lb/in.}$$

$$q_B = \frac{VQ_B}{I} = \frac{5(10^3)(70.875)}{1196.4375} = 296.19 \text{ lb/in.}$$

Spacing of nails at top flange

$$s_{\text{top}} = \frac{F}{q_A} = \frac{500}{352.61} = 1.42 \text{ in.} \quad (\text{Regions } AC \text{ and } BD) \quad \text{Ans}$$

Spacing of nails at bottom flange,

$$s_{\text{bottom}} = \frac{F}{q_B} = \frac{500}{296.19} = 1.69 \text{ in.} \quad (\text{Regions } AC \text{ and } BD) \quad \text{Ans}$$

For region CD , theoretically no nails are required to hold the flange and web together since $V_{CD} = 0$. However, it is advisable to provide some nails within this region. **Ans**

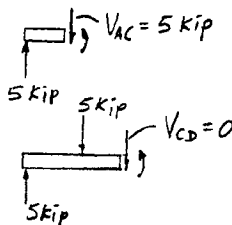
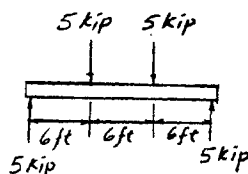
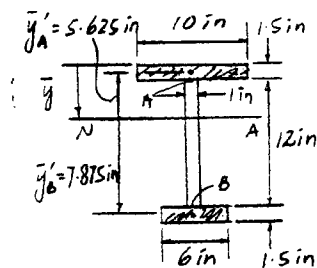

From *Mechanics of Materials*, Sixth Edition by R. C. Hibbeler, ISBN 0-13-191345-X.

© 2005 R. C. Hibbeler. Published by Pearson Prentice Hall,

Pearson Education, Inc., Upper Saddle River, NJ. All rights reserved.

This material is protected under all copyright laws as they currently exist. No portion of this material may be reproduced, in any form or by any means, without permission in writing from the publisher.

7-53 The beam is constructed from three boards. Determine the maximum loads P that it can support if the allowable shear stress for the wood is $\tau_{\text{allow}} = 400$ psi. What is the required spacing s of the nails used to hold the top and bottom flanges to the web if each nail can resist a shear force of 400 lb?

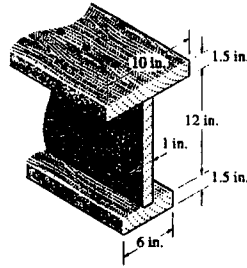
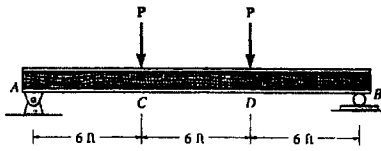

As shown on FBD

$$V_{\text{max}} = P, V_{AC} = V_{DB} = P, V_{CD} = 0$$

$$\bar{y} = \frac{\sum \bar{y}A}{\sum A} = \frac{0.75(10)(1.5) + 7.5(12)(1) + 14.25(6)(1.5)}{10(1.5) + 12(1) + 6(1.5)} = 6.375 \text{ in.}$$

$$I = \frac{1}{12}(10)(1.5^3) + 10(1.5)(6.375 - 0.75)^2 + \frac{1}{12}(1)(12^3) + 1(12)(7.5 - 6.375)^2 + \frac{1}{12}(6)(1.5^3) + 6(1.5)(7.875^2)$$

$$= 1196.4375 \text{ in}^4$$

$$Q_A = \bar{y}_A A' = 5.625(10)(1.5) = 84.375 \text{ in}^3$$

$$Q_B = \bar{y}_B A' = 7.875(6)(1.5) = 70.875 \text{ in}^3$$

$$Q_{\text{max}} = \sum \bar{y}A' = 5.625(10)(1.5) + \frac{4.875}{2}(4.875)(1) = 96.2578 \text{ in}^3$$

Maximum shear stress :

$$\tau_{\text{allow}} = \frac{VQ_{\text{max}}}{It}; \quad 400 = \frac{P(96.2578)}{1196.4375(1)}$$

$$P = 4971.8 \text{ lb} = 4.97 \text{ kip} \quad \text{Ans}$$

For region AC and BD

$$q_A = \frac{VQ_A}{I} = \frac{4971.8(84.375)}{1196.4375} = 350.62 \text{ lb/in.}$$

$$q_B = \frac{VQ_B}{I} = \frac{4971.8(70.875)}{1196.4375} = 294.52 \text{ lb/in.}$$

Nail spacing at top and bottom flange

$$s_{\text{top}} = \frac{F}{q_A} = \frac{400}{350.62} = 1.14 \text{ in.} \quad \text{Ans} \quad (\text{Regions AC and BD})$$

$$s_{\text{bottom}} = \frac{F}{q_B} = \frac{400}{294.52} = 1.36 \text{ in.} \quad \text{Ans} \quad (\text{Regions AC and BD})$$

For region CD, theoretically no nails are required to hold the flange and web together since $V_{CD} = 0$. However, it is advisable to provide some nails within this region. **Ans**

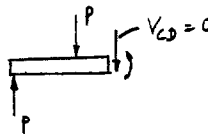
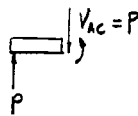
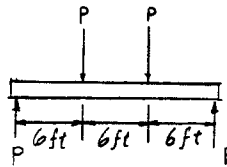
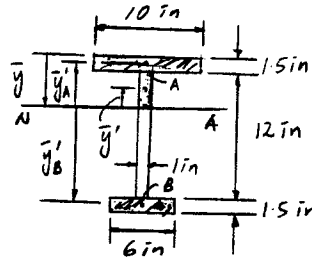

From *Mechanics of Materials*, Sixth Edition by R. C. Hibbeler, ISBN 0-13-191345-X.

© 2005 R. C. Hibbeler. Published by Pearson Prentice Hall,

Pearson Education, Inc., Upper Saddle River, NJ. All rights reserved.

This material is protected under all copyright laws as they currently exist. No portion of this material may be reproduced, in any form or by any means, without permission in writing from the publisher.

7-54 The member consists of two plastic channel strips 0.5 in. thick, bonded together at *A* and *B*. If the glue can support an allowable shear stress of $\tau_{\text{allow}} = 600$ psi, determine the maximum intensity w_0 of the triangular distributed loading that can be applied to the member based on the strength of the glue.

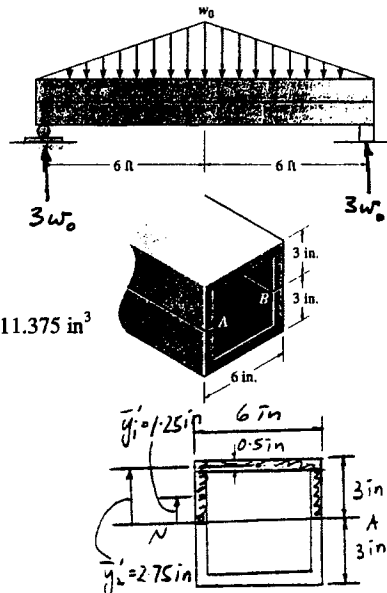

Maximum shear force : $V_{\text{max}} = 3w_0$

$$I = \frac{1}{12}(6)(6^3) - \frac{1}{12}(5)(5^3) = 55.916 \text{ in}^4$$

$$Q = \bar{y}'A' = 2[1.25(2.5)(0.5)] + 2.75(6)(0.5) = 11.375 \text{ in}^3$$

$$q = \tau_{\text{allow}} t = \frac{VQ}{I}$$

$$600(2)(0.5) = \frac{3w_0(11.375)}{55.916}$$

$$w_0 = 983 \text{ lb/ft} \quad \text{Ans}$$

From *Mechanics of Materials*, Sixth Edition by R. C. Hibbeler, ISBN 0-13-191345-X.

© 2005 R. C. Hibbeler. Published by Pearson Prentice Hall,

Pearson Education, Inc., Upper Saddle River, NJ. All rights reserved.

This material is protected under all copyright laws as they currently exist. No portion of this material may be reproduced, in any form or by any means, without permission in writing from the publisher.

7-55 The member consists of two plastic channel strips, 0.5 in. thick, glued together at *A* and *B*. If the distributed load has a maximum intensity of $w_0 = 3$ kip/ft, determine the maximum shear stress resisted by the glue.

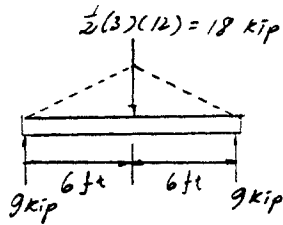

$$V_{max} = 9 \text{ kip}$$

$$I = \frac{1}{12}(6)(6^3) - \frac{1}{12}(5)(5^3) = 55.916 \text{ in}^4$$

$$Q = \Sigma \bar{y}'A' = 2[1.25(2.5)(0.5)] + 2.75(6)(0.5) = 11.375 \text{ in}^3$$

$$\tau_{max} = \frac{VQ_{max}}{It} = \frac{9(11.375)}{55.916(1)} = 1.83 \text{ ksi}$$

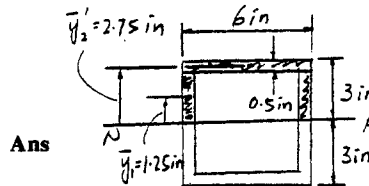
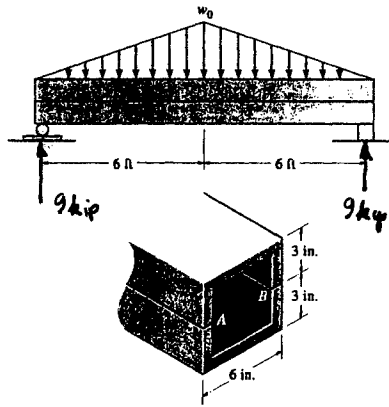

From *Mechanics of Materials*, Sixth Edition by R. C. Hibbeler, ISBN 0-13-191345-X.

© 2005 R. C. Hibbeler. Published by Pearson Prentice Hall,

Pearson Education, Inc., Upper Saddle River, NJ. All rights reserved.

This material is protected under all copyright laws as they currently exist. No portion of this material may be reproduced, in any form or by any means, without permission in writing from the publisher.

*7-56 The H-beam is subjected to a shear of $V = 80$ kN. Determine the shear flow at point A.

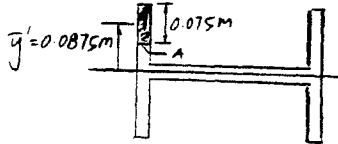
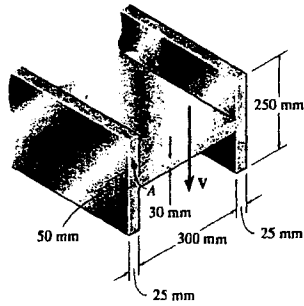

$$I = 2\left[\frac{1}{12}(0.025)(0.25^3) + \frac{1}{12}(0.3)(0.03^3)\right] = 65.7792(10^{-6}) \text{ m}^4$$

$$Q_A = \bar{y}'A' = 0.0875(0.075)(0.025) = 0.1641(10^{-3}) \text{ m}^3$$

$$q_A = \frac{VQ_A}{I} = \frac{80(10^3)(0.1641)(10^{-3})}{65.7792(10^{-6})} = 200 \text{ kN/m} \quad \text{Ans}$$

From *Mechanics of Materials*, Sixth Edition by R. C. Hibbeler, ISBN 0-13-191345-X.

© 2005 R. C. Hibbeler. Published by Pearson Prentice Hall,

Pearson Education, Inc., Upper Saddle River, NJ. All rights reserved.

This material is protected under all copyright laws as they currently exist. No portion of this material may be reproduced, in any form or by any means, without permission in writing from the publisher.

7-57 The I-beam is subjected to a shear of $V = 80$ kN. Sketch the shear stress distribution acting along one of its side segments. Indicate all peak values.

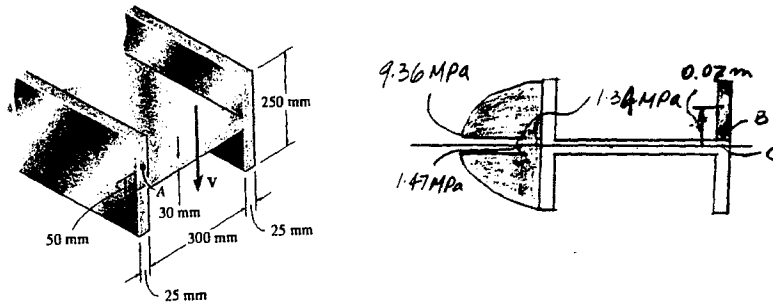

$$I = 2\left[\frac{1}{12}(0.025)(0.25^3) + \frac{1}{12}(0.3)(0.03^3)\right] = 65.7792(10^{-6}) \text{ m}^4$$

$$Q_B = (0.070)(0.025)(0.110) = 0.1925(10^{-3}) \text{ m}^3$$

$$\tau_B = \frac{VQ}{It} = \frac{80(10^3)(0.1925)(10^{-3})}{65.7792(10^{-6})(0.025)} = 9.36 \text{ MPa}$$

$$\tau_B = \frac{VQ}{It} = \frac{80(10^3)[2(0.1925)(10^{-3})]}{65.7792(10^{-6})(0.35)} = 1.3378 \text{ MPa}$$

$$Q_{\max} = 2(0.07)(0.025)(0.110) + (0.0075)(0.35)(0.015) = 0.4244(10^{-3}) \text{ m}^3$$

$$\tau_C = \frac{VQ}{It} = \frac{80(10^3)(0.4244)(10^{-3})}{65.7792(10^{-6})(0.35)} = 1.47 \text{ MPa}$$

From *Mechanics of Materials*, Sixth Edition by R. C. Hibbeler, ISBN 0-13-191345-X.

© 2005 R. C. Hibbeler. Published by Pearson Prentice Hall,

Pearson Education, Inc., Upper Saddle River, NJ. All rights reserved.

This material is protected under all copyright laws as they currently exist. No portion of this material may be reproduced, in any form or by any means, without permission in writing from the publisher.

7-58 The channel is subjected to a shear of $V = 75 \text{ kN}$. Determine the shear flow developed at point A .

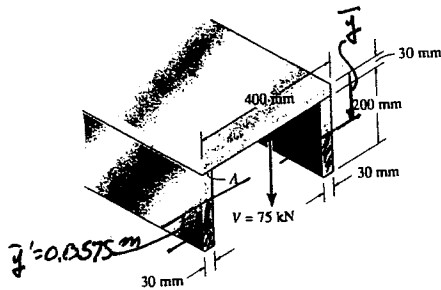

$$\bar{y} = \frac{\Sigma \bar{y}A}{\Sigma A} = \frac{0.015(0.4)(0.03) + 2[0.13(0.2)(0.03)]}{0.4(0.03) + 2(0.2)(0.03)} = 0.0725 \text{ m}$$

$$I = \frac{1}{12}(0.4)(0.03^3) + 0.4(0.03)(0.0725 - 0.015)^2 + 2\left[\frac{1}{12}(0.03)(0.2^3) + 0.03(0.2)(0.13 - 0.0725)^2\right] = 0.12025(10^{-3}) \text{ m}^4$$

$$Q_A = \bar{y}_A A' = 0.0575(0.2)(0.03) = 0.3450(10^{-3}) \text{ m}^3$$

$$q = \frac{VQ}{I}$$

$$q_A = \frac{75(10^3)(0.3450)(10^{-3})}{0.12025(10^{-3})} = 215 \text{ kN/m} \quad \text{Ans}$$

From *Mechanics of Materials*, Sixth Edition by R. C. Hibbeler, ISBN 0-13-191345-X.

© 2005 R. C. Hibbeler. Published by Pearson Prentice Hall,

Pearson Education, Inc., Upper Saddle River, NJ. All rights reserved.

This material is protected under all copyright laws as they currently exist. No portion of this material may be reproduced, in any form or by any means, without permission in writing from the publisher.

7-59 The channel is subjected to a shear of $V = 75 \text{ kN}$. Determine the maximum shear flow in the channel.

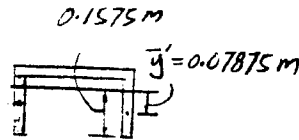
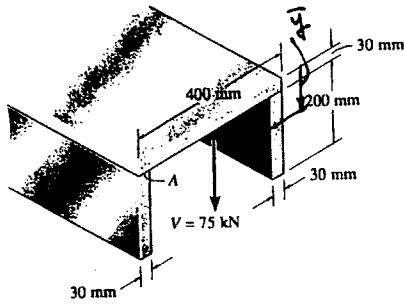

$$\bar{y} = \frac{\sum \bar{y} A}{\Sigma A} = \frac{0.015(0.4)(0.03) + 2[0.13(0.2)(0.03)]}{0.4(0.03) + 2(0.2)(0.03)} = 0.0725 \text{ m}$$

$$I = \frac{1}{12}(0.4)(0.03^3) + 0.4(0.03)(0.0725 - 0.015)^2 + 2\left[\frac{1}{12}(0.03)(0.2^3) + 0.03(0.2)(0.13 - 0.0725)^2\right] = 0.1202(10^{-3}) \text{ m}^4$$

$$Q_{\max} = \bar{y}' A' = 0.07875(0.1575)(0.03) = 0.37209(10^{-3}) \text{ m}^3$$

$$q_{\max} = \frac{75(10^3)(0.37209)(10^{-3})}{0.12025(10^{-3})} = 232 \text{ kN/m} \quad \text{Ans}$$

From *Mechanics of Materials*, Sixth Edition by R. C. Hibbeler, ISBN 0-13-191345-X.

© 2005 R. C. Hibbeler. Published by Pearson Prentice Hall,

Pearson Education, Inc., Upper Saddle River, NJ. All rights reserved.

This material is protected under all copyright laws as they currently exist. No portion of this material may be reproduced, in any form or by any means, without permission in writing from the publisher.

*7-60. The assembly is subjected to a vertical shear of $V = 7$ kip. Determine the shear flow at points A and B and the maximum shear flow in the cross section.

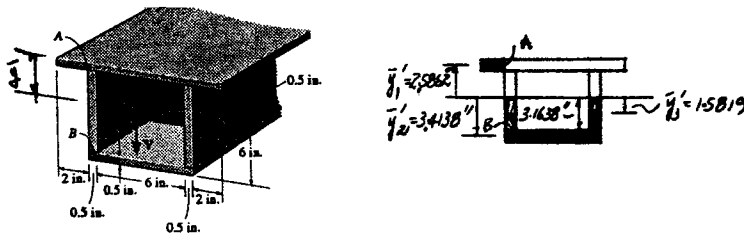

$$\bar{y} = \frac{\Sigma \bar{y}A}{\Sigma A} = \frac{(0.25)(11)(0.5) + 2(3.25)(5.5)(0.5) + 6.25(7)(0.5)}{0.5(11) + 2(0.5)(5.5) + 7(0.5)} = 2.8362 \text{ in.}$$

$$I = \frac{1}{12}(11)(0.5^3) + 11(0.5)(2.8362 - 0.25)^2 + 2\left(\frac{1}{12}\right)(0.5)(5.5^3) + 2(0.5)(5.5)(3.25 - 2.8362)^2 + \frac{1}{12}(7)(0.5^3) + (0.5)(7)(6.25 - 2.8362)^2 = 92.569 \text{ in}^4$$

$$Q_A = \bar{y}_1 'A_1 ' = (2.5862)(2)(0.5) = 2.5862 \text{ in}^3$$

$$Q_B = \bar{y}_2 'A_2 ' = (3.4138)(7)(0.5) = 11.9483 \text{ in}^3$$

$$Q_{\max} = \Sigma \bar{y} 'A ' = (3.4138)(7)(0.5) + 2(1.5819)(3.1638)(0.5) = 16.9531 \text{ in}^3$$

$$q = \frac{VQ}{I}$$

$$q_A = \frac{7(10^3)(2.5862)}{92.569} = 196 \text{ lb/in.} \quad \text{Ans}$$

$$q_B = \frac{1}{2} \left(\frac{7(10^3)(11.9483)}{92.569} \right) = 452 \text{ lb/in.} \quad \text{Ans}$$

$$q_{\max} = \frac{1}{2} \left(\frac{7(10^3)(16.9531)}{92.569} \right) = 641 \text{ lb/in.} \quad \text{Ans}$$

From *Mechanics of Materials*, Sixth Edition by R. C. Hibbeler, ISBN 0-13-191345-X.

© 2005 R. C. Hibbeler. Published by Pearson Prentice Hall,

Pearson Education, Inc., Upper Saddle River, NJ. All rights reserved.

This material is protected under all copyright laws as they currently exist. No portion of this material may be reproduced, in any form or by any means, without permission in writing from the publisher.

7-61 The aluminum strut is 10 mm thick and has the cross section shown. If it is subjected to a shear of $V = 150$ N, determine the shear flow at points A and B .

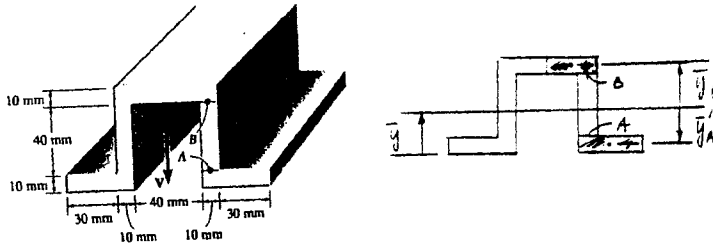

$$\bar{y} = \frac{2[0.005(0.03)(0.01)] + 2[0.03(0.06)(0.01)] + 0.055(0.04)(0.01)}{2(0.03)(0.01) + 2(0.06)(0.01) + 0.04(0.01)} = 0.027727 \text{ m}$$

$$I = 2\left[\frac{1}{12}(0.03)(0.01)^3 + 0.03(0.01)(0.027727 - 0.005)^2\right] + 2\left[\frac{1}{12}(0.01)(0.06)^3 + 0.01(0.06)(0.03 - 0.027727)^2\right] + \frac{1}{12}(0.04)(0.01)^3 + 0.04(0.01)(0.055 - 0.027727)^2 = 0.98197(10^{-6}) \text{ m}^4$$

$$\bar{y}_B' = 0.055 - 0.027727 = 0.027272 \text{ m}$$

$$\bar{y}_A' = 0.027727 - 0.005 = 0.022727 \text{ m}$$

$$Q_A = \bar{y}_A' A' = 0.022727(0.04)(0.01) = 9.0909(10^{-6}) \text{ m}^3$$

$$Q_B = \bar{y}_B' A' = 0.027272(0.03)(0.01) = 8.1818(10^{-6}) \text{ m}^3$$

$$q_A = \frac{VQ_A}{I} = \frac{150(9.0909)(10^{-6})}{0.98197(10^{-6})} = 1.39 \text{ kN/m} \quad \text{Ans}$$

$$q_B = \frac{VQ_B}{I} = \frac{150(8.1818)(10^{-6})}{0.98197(10^{-6})} = 1.25 \text{ kN/m} \quad \text{Ans}$$

From *Mechanics of Materials*, Sixth Edition by R. C. Hibbeler, ISBN 0-13-191345-X.

© 2005 R. C. Hibbeler. Published by Pearson Prentice Hall,

Pearson Education, Inc., Upper Saddle River, NJ. All rights reserved.

This material is protected under all copyright laws as they currently exist. No portion of this material may be reproduced, in any form or by any means, without permission in writing from the publisher.

7-62 The aluminum strut is 10 mm thick and has the cross section shown. If it is subjected to a shear of $V = 150$ N, determine the maximum shear flow in the strut.

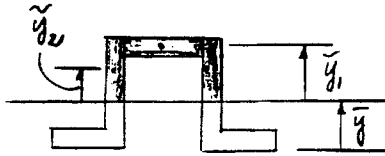
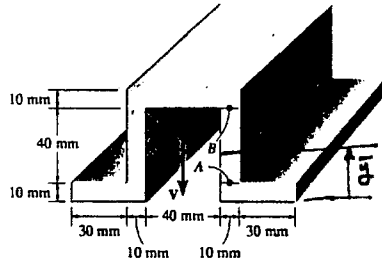

$$\bar{y} = \frac{2[0.005(0.03)(0.01)] + 2[0.03(0.06)(0.01)] + 0.055(0.04)(0.01)}{2(0.03)(0.01) + 2(0.06)(0.01) + 0.04(0.01)}$$

$$= 0.027727 \text{ m}$$

$$I = 2\left[\frac{1}{12}(0.03)(0.01)^3 + 0.03(0.01)(0.027727 - 0.005)^2\right]$$

$$+ 2\left[\frac{1}{12}(0.01)(0.06)^3 + 0.01(0.06)(0.03 - 0.027727)^2\right]$$

$$+ \frac{1}{12}(0.04)(0.01)^3 + 0.04(0.01)(0.055 - 0.027727)^2$$

$$= 0.98197(10^{-6}) \text{ m}^4$$

$$Q_{\max} = (0.055 - 0.027727)(0.04)(0.01) + 2[(0.06 - 0.027727)(0.01)]\left(\frac{0.06 + 0.0277}{2}\right)$$

$$= 21.3(10^{-6}) \text{ m}^3$$

$$q_{\max} = \frac{1}{2}\left(\frac{VQ_{\max}}{I}\right) = \frac{1}{2}\left(\frac{150(21.3(10^{-6}))}{0.98197(10^{-6})}\right) = 1.63 \text{ kN/m} \quad \text{Ans.}$$

From *Mechanics of Materials*, Sixth Edition by R. C. Hibbeler, ISBN 0-13-191345-X.

© 2005 R. C. Hibbeler. Published by Pearson Prentice Hall,

Pearson Education, Inc., Upper Saddle River, NJ. All rights reserved.

This material is protected under all copyright laws as they currently exist. No portion of this material may be reproduced, in any form or by any means, without permission in writing from the publisher.

7-63. The box girder is subjected to a shear of $V = 15$ kN. Determine (a) the shear flow developed at point B and (b) the maximum shear flow in the girder's web AB .

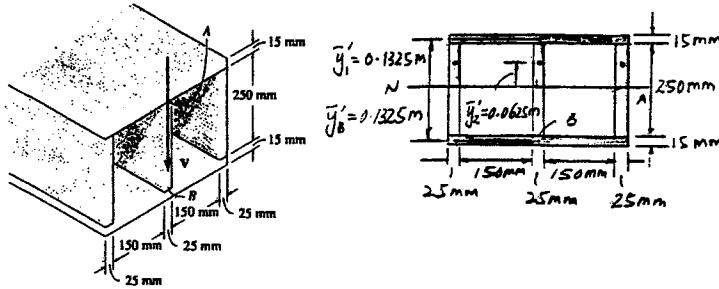

$$I = \frac{1}{12}(0.375)(0.28^3) - \frac{1}{12}(0.3)(0.25^3) = 0.295375(10^{-3}) \text{ m}^4$$

$$Q_B = \bar{y}_B A' = 0.1325(0.375)(0.015) = 0.7453125(10^{-3}) \text{ m}^3$$

$$Q_{\max} = \Sigma \bar{y}' A' = 0.1325(0.375)(0.015) + 3[(0.0625)(0.125)(0.025)] = 1.33125(10^{-3}) \text{ m}^3$$

$$\text{a) } q_B = \frac{1}{3} \left[\frac{V Q_B}{I} \right] = \frac{1}{3} \left[\frac{15(10^3)(0.7453125)(10^{-3})}{0.295375(10^{-3})} \right] = 12.6 \text{ kN/m} \quad \text{Ans}$$

$$\text{b) } q_{\max} = \frac{1}{3} \left[\frac{V Q_{\max}}{I} \right] = \frac{1}{3} \left[\frac{15(10^3)(1.33125)(10^{-3})}{0.295375(10^{-3})} \right] = 22.5 \text{ kN/m} \quad \text{Ans}$$

From *Mechanics of Materials*, Sixth Edition by R. C. Hibbeler, ISBN 0-13-191345-X.

© 2005 R. C. Hibbeler. Published by Pearson Prentice Hall,

Pearson Education, Inc., Upper Saddle River, NJ. All rights reserved.

This material is protected under all copyright laws as they currently exist. No portion of this material may be reproduced, in any form or by any means, without permission in writing from the publisher.

*7-64 The beam is subjected to a shear force of $V = 5$ kip. Determine the shear flow at points A and B .

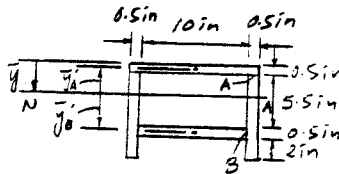
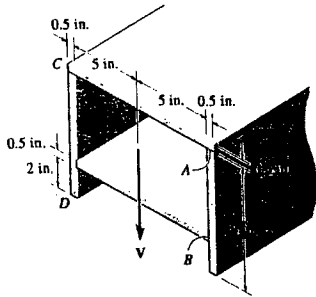

$$\bar{y} = \frac{\sum yA}{\sum A} = \frac{0.25(11)(0.5) + 2[4.5(8)(0.5)] + 6.25(10)(0.5)}{11(0.5) + 2(8)(0.5) + 10(0.5)} = 3.70946 \text{ in.}$$

$$I = \frac{1}{12}(11)(0.5^3) + 11(0.5)(3.70946 - 0.25)^2 + 2\left[\frac{1}{12}(0.5)(8^3) + 0.5(8)(4.5 - 3.70946)^2\right] + \frac{1}{12}(10)(0.5^3) + 10(0.5)(6.25 - 3.70946)^2 = 145.98 \text{ in}^4$$

$$\bar{y}'_A = 3.70946 - 0.25 = 3.45946 \text{ in.}$$

$$\bar{y}'_B = 6.25 - 3.70946 = 2.54054 \text{ in.}$$

$$Q_A = \bar{y}'_A A' = 3.45946(11)(0.5) = 19.02703 \text{ in}^3$$

$$Q_B = \bar{y}'_B A' = 2.54054(10)(0.5) = 12.7027 \text{ in}^3$$

$$q_A = \frac{1}{2}\left(\frac{VQ_A}{I}\right) = \frac{1}{2}\left(\frac{5(10^3)(19.02703)}{145.98}\right) = 326 \text{ lb/in.} \quad \text{Ans}$$

$$q_B = \frac{1}{2}\left(\frac{VQ_B}{I}\right) = \frac{1}{2}\left(\frac{5(10^3)(12.7027)}{145.98}\right) = 218 \text{ lb/in.} \quad \text{Ans}$$

From *Mechanics of Materials*, Sixth Edition by R. C. Hibbeler, ISBN 0-13-191345-X.

© 2005 R. C. Hibbeler. Published by Pearson Prentice Hall,

Pearson Education, Inc., Upper Saddle River, NJ. All rights reserved.

This material is protected under all copyright laws as they currently exist. No portion of this material may be reproduced, in any form or by any means, without permission in writing from the publisher.

7-65 The beam is constructed from four plates and is subjected to a shear force of $V = 5$ kip. Determine the maximum shear flow in the cross section.

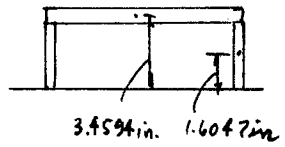
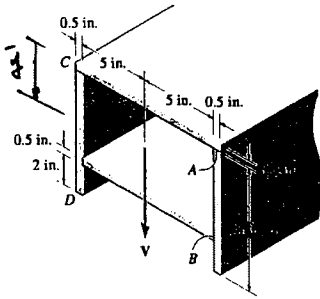

$$\bar{y} = \frac{\sum yA}{\sum A} = \frac{0.25(11)(0.5) + 2[4.5(8)(0.5)] + 6.25(10)(0.5)}{11(0.5) + 2(8)(0.5) + 10(0.5)} = 3.70946 \text{ in.}$$

$$I = \frac{1}{12}(11)(0.5^3) + 11(0.5)(3.4595^2) + 2\left[\frac{1}{12}(0.5)(8^3) + 0.5(8)(0.7905^2)\right] + \frac{1}{12}(10)(0.5^3) + 10(0.5)(2.5405^2) = 145.98 \text{ in}^4$$

$$Q_{\max} = 3.4594(11)(0.5) + 2[(1.6047)(0.5)(3.7094 - 0.5)] = 24.177 \text{ in}^3$$

$$q_{\max} = \frac{1}{2}\left(\frac{VQ_{\max}}{I}\right) = \frac{1}{2}\left(\frac{5(10^3)(24.177)}{145.98}\right) = 414 \text{ lb/in.}$$

Ans

From *Mechanics of Materials*, Sixth Edition by R. C. Hibbeler, ISBN 0-13-191345-X.

© 2005 R. C. Hibbeler. Published by Pearson Prentice Hall,

Pearson Education, Inc., Upper Saddle River, NJ. All rights reserved.

This material is protected under all copyright laws as they currently exist. No portion of this material may be reproduced, in any form or by any means, without permission in writing from the publisher.

7-66 The stiffened beam is constructed from plates having a thickness of 0.25 in. If it is subjected to a shear of $V = 8$ kip, determine the shear-flow distribution in segments AB and CD of the beam. What is the resultant shear supported by these segments? Also, sketch how the shear flow passes through the cross section. The vertical dimensions are measured to the centerline of each horizontal segment.

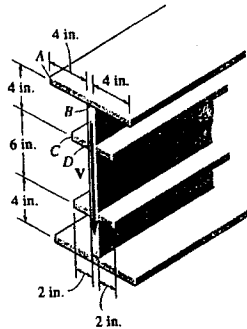

As an approximation :

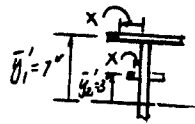

$$I = \frac{1}{12}(0.25)(14^3) + 2(8)(0.25)(7^2) + 2(0.25)(4)(3^2) = 271.167 \text{ in}^4$$

$$Q_{AB} = 7(4-x)(0.25) = 7 - 1.75x$$

$$Q_{CD} = 3(2-x)(0.25) = 1.5 - 0.75x$$

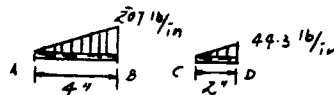

$$q_{AB} = \frac{VQ_{AB}}{I} = \frac{8(10^3)(7 - 1.75x)}{271.167} = 207 - 51.6x \quad \text{Ans}$$

$$q_{CD} = \frac{VQ_{CD}}{I} = \frac{8(10^3)(1.5 - 0.75x)}{271.167} = 44.3 - 22.1x \quad \text{Ans}$$

$$F_{AB} = \int q_{AB} dx = \int_0^4 (207 - 51.6x) dx = 413 \text{ lb} \quad \text{Ans}$$

$$F_{CD} = \int q_{CD} dx = \int_0^2 (44.3 - 22.1x) dx = 44.3 \text{ lb} \quad \text{Ans}$$

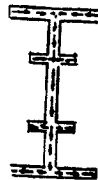

From *Mechanics of Materials*, Sixth Edition by R. C. Hibbeler, ISBN 0-13-191345-X.

© 2005 R. C. Hibbeler. Published by Pearson Prentice Hall,

Pearson Education, Inc., Upper Saddle River, NJ. All rights reserved.

This material is protected under all copyright laws as they currently exist. No portion of this material may be reproduced, in any form or by any means, without permission in writing from the publisher.

7-67 Determine the shear-stress variation over the cross section of the thin-walled tube as a function of elevation y and show that $\tau_{\max} = 2V/A$, where $A = 2\pi R t$. *Hint:* Choose a differential area element $dA = R t d\theta$. Using $dQ = y dA$, formulate Q for a circular section from θ to $(\pi - \theta)$ and show that $Q = 2R^2 t \cos \theta$, where $\cos \theta = \sqrt{R^2 - y^2}/R$.

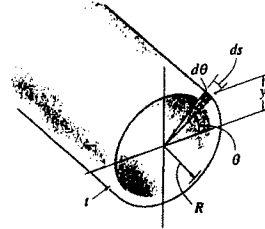

$$dA = R t d\theta$$

$$dQ = y dA = y R t d\theta$$

$$\text{Here } y = R \sin \theta$$

$$\text{Therefore } dQ = R^2 t \sin \theta d\theta$$

$$Q = \int_{\theta}^{\pi-\theta} R^2 t \sin \theta d\theta = R^2 t (-\cos \theta) \Big|_{\theta}^{\pi-\theta}$$

$$= R^2 t [-\cos(\pi - \theta) - (-\cos \theta)] = 2R^2 t \cos \theta$$

$$dI = y^2 dA = y^2 R t d\theta = R^3 t \sin^2 \theta d\theta$$

$$I = \int_0^{2\pi} R^3 t \sin^2 \theta d\theta = R^3 t \int_0^{2\pi} \frac{(1 - \cos 2\theta)}{2} d\theta$$

$$= \frac{R^3 t}{2} \left[\theta - \frac{\sin 2\theta}{2} \right]_0^{2\pi} = \frac{R^3 t}{2} [2\pi - 0] = \pi R^3 t$$

$$\tau = \frac{VQ}{I t} = \frac{V(2R^2 t \cos \theta)}{\pi R^3 t (2t)} = \frac{V \cos \theta}{\pi R t}$$

$$\text{Here } \cos \theta = \frac{\sqrt{R^2 - y^2}}{R}$$

$$\tau = \frac{V}{\pi R^2 t} \sqrt{R^2 - y^2} \quad \text{Ans}$$

τ_{\max} occurs at $y = 0$; therefore

$$\tau_{\max} = \frac{V}{\pi R t}$$

$A = 2\pi R t$; therefore

$$\tau_{\max} = \frac{2V}{A} \quad \text{QED}$$

From *Mechanics of Materials*, Sixth Edition by R. C. Hibbeler, ISBN 0-13-191345-X.

© 2005 R. C. Hibbeler. Published by Pearson Prentice Hall,

Pearson Education, Inc., Upper Saddle River, NJ. All rights reserved.

This material is protected under all copyright laws as they currently exist. No portion of this material may be reproduced, in any form or by any means, without permission in writing from the publisher.

*7-68. Determine the location e of the shear center, point O , for the thin-walled member having the cross section shown where $b_2 > b_1$. The member segments have the same thickness t .

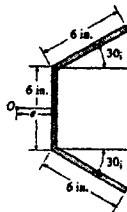

Section Properties :

$$I = \frac{1}{12}t(6^3) + 2\left[\frac{1}{12}\left(\frac{t}{\sin 30^\circ}\right)(6 \sin 30^\circ)^3 + (6t)(3 + 3 \sin 30^\circ)^2\right] = 270t$$

$$\bar{y}' = 3 + 6 \sin 30^\circ - \frac{x}{2} \sin 30^\circ = 6 - \frac{x}{4}$$

$$Q = \bar{y}'A' = \left(6 - \frac{x}{4}\right)(x)(t) = t\left(6x - \frac{x^2}{4}\right)$$

Shear Flow Resultant :

$$q = \frac{VQ}{I} = \frac{P t \left(6x - \frac{x^2}{4}\right)}{270 t} = \frac{P\left(6x - \frac{x^2}{4}\right)}{270}$$

$$F_1 = \int_0^{6 \sin 30^\circ} q dx = \frac{P}{270} \int_0^{6 \sin 30^\circ} \left(6x - \frac{x^2}{4}\right) dx = \frac{1}{3} P$$

Shear Center : Summing moments about point A .

$$P e = F_1 \cos 30^\circ (6)$$

$$P e = \frac{1}{3} P \cos 30^\circ (6)$$

$$e = 1.73 \text{ in.}$$

Ans

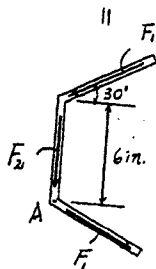
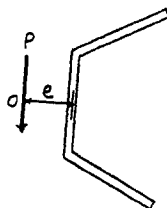
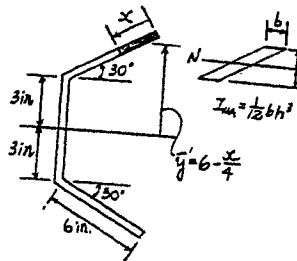

From *Mechanics of Materials*, Sixth Edition by R. C. Hibbeler, ISBN 0-13-191345-X.

© 2005 R. C. Hibbeler. Published by Pearson Prentice Hall,

Pearson Education, Inc., Upper Saddle River, NJ. All rights reserved.

This material is protected under all copyright laws as they currently exist. No portion of this material may be reproduced, in any form or by any means, without permission in writing from the publisher.

7-69. Determine the location e of the shear center, point O , for the thin-walled member having the cross section shown. The member segments have the same thickness t .

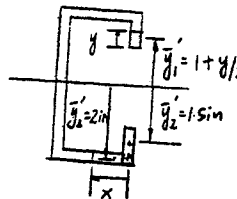
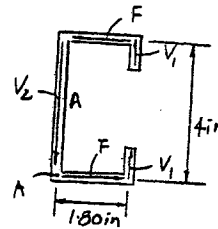
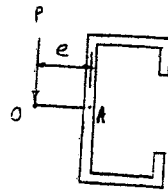
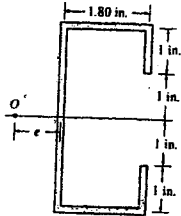

Summing moments about A ,

$$P e = F(4) + 2V_1(1.8) \quad (1)$$

$$I = 2\left[\frac{1}{12}t(4^3)\right] - \frac{1}{12}t(2^3) + 2[(1.80)(t)(2^2)] = 24.4 t \text{ in}^4$$

$$Q_1 = \bar{y}_1 A' = \left(1 + \frac{y}{2}\right)(y t) = t\left(y + \frac{y^2}{2}\right)$$

$$Q_2 = \Sigma \bar{y} A' = 1.5(1)(t) + 2(x)(t) = t(1.5 + 2x)$$

$$q_1 = \frac{V Q_1}{I} = \frac{P t \left(y + \frac{y^2}{2}\right)}{24.4 t} = \frac{P \left(y + \frac{y^2}{2}\right)}{24.4}$$

$$q_2 = \frac{V Q_2}{I} = \frac{P t (1.5 + 2x)}{24.4 t} = \frac{P (1.5 + 2x)}{24.4}$$

$$V_1 = \int q_1 dy = \frac{P}{24.4} \int_0^1 \left(y + \frac{y^2}{2}\right) dy = 0.0273 P$$

$$F = \int q_2 dx = \frac{P}{24.4} \int_0^{1.80} (1.5 + 2x) dx = 0.2434 P$$

From Eq. (1),

$$P e = 0.2434 P(4) + 2(0.0273)P(1.8)$$

$$e = 1.07 \text{ in.} \quad \text{Ans}$$

From *Mechanics of Materials*, Sixth Edition by R. C. Hibbeler, ISBN 0-13-191345-X.

© 2005 R. C. Hibbeler. Published by Pearson Prentice Hall,

Pearson Education, Inc., Upper Saddle River, NJ. All rights reserved.

This material is protected under all copyright laws as they currently exist. No portion of this material may be reproduced, in any form or by any means, without permission in writing from the publisher.

7-70 Determine the location e of the shear center, point O , for the thin-walled member having the cross section shown. The member segments have the same thickness t .

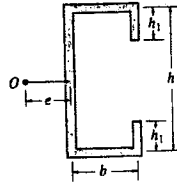

Summing moments about A,

$$Pe = F(h) + 2V(b) \quad (1)$$

$$I = \frac{1}{12}(t)(h^3) + 2b(t)\left(\frac{h}{2}\right)^2 + \frac{1}{12}(t)[h^3 - (h - 2h_1)^3]$$

$$= \frac{th^3}{6} + \frac{bth^2}{2} - \frac{t(h - 2h_1)^3}{12}$$

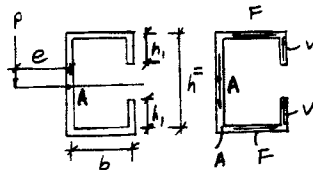

$$Q_1 = \bar{y}'A' = \frac{1}{2}(h - 2h_1 + y)yt = \frac{t(hy - 2h_1y + y^2)}{2}$$

$$q_1 = \frac{VQ}{I} = \frac{Pt(hy - 2h_1y + y^2)}{2I}$$

$$V = \int q_1 dy = \frac{Pt}{2I} \int_0^{h_1} (hy - 2h_1y + y^2) dy = \frac{Pt}{2I} \left[\frac{hh_1^2}{2} - \frac{2}{3}h_1^3 \right]$$

$$Q_2 = \Sigma \bar{y}'A' = \frac{1}{2}(h - h_1)h_1t + \frac{h}{2}(x)(t) = \frac{1}{2}[h_1(h - h_1) + hx]$$

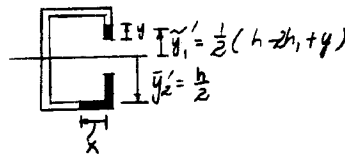

$$q_2 = \frac{VQ_2}{I} = \frac{Pt}{2I}(h_1(h - h_1) + hx)$$

$$F = \int q_2 dx = \frac{Pt}{2I} \int_0^b [h_1(h - h_1) + hx] dx = \frac{Pt}{2I}(h_1hb - h_1^2b + \frac{hb^2}{2})$$

From Eq. (1),

$$Pe = \frac{Pt}{2I}[h_1h^2b - h_1^2hb + \frac{h^2b^2}{2} + hh_1^2b - \frac{4}{3}h_1^3b]$$

$$I = \frac{t}{12}(2h^3 + 6bh^2 - (h - 2h_1)^3)$$

$$e = \frac{t}{12I}(6h_1h^2b + 3h^2b^2 - 8h_1^3b) = \frac{b(6h_1h^2 + 3h^2b - 8h_1^3)}{2h^3 + 6bh^2 - (h - 2h_1)^3} \quad \text{Ans}$$

From *Mechanics of Materials*, Sixth Edition by R. C. Hibbeler, ISBN 0-13-191345-X.

© 2005 R. C. Hibbeler. Published by Pearson Prentice Hall,

Pearson Education, Inc., Upper Saddle River, NJ. All rights reserved.

This material is protected under all copyright laws as they currently exist. No portion of this material may be reproduced, in any form or by any means, without permission in writing from the publisher.

7-71. Determine the location e of the shear center, point O , for the thin-walled member having the cross section shown. The member segments have the same thickness t .

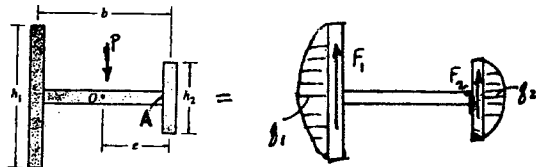

Summing moments about A ,

$$eP = bF_1 \quad (1)$$

$$I = \frac{1}{12}(t)(h_1)^3 + \frac{1}{12}(t)(h_2)^3 = \frac{1}{12}t(h_1^3 + h_2^3)$$

$$q_1 = \frac{P(h_1/2)(t)(h_1/4)}{I} = \frac{Ph_1^2 t}{8I}$$

$$F_1 = \frac{2}{3}q_1(h_1) = \frac{Ph_1^3 t}{12I}$$

From Eq. (1),

$$e = \frac{b}{P} \left(\frac{Ph_1^3 t}{12I} \right)$$

$$= \frac{h_1^3 b}{(h_1^3 + h_2^3)}$$

$$= \frac{b}{1 + (h_2/h_1)^3} \quad \text{Ans}$$

From *Mechanics of Materials*, Sixth Edition by R. C. Hibbeler, ISBN 0-13-191345-X.

© 2005 R. C. Hibbeler. Published by Pearson Prentice Hall,

Pearson Education, Inc., Upper Saddle River, NJ. All rights reserved.

This material is protected under all copyright laws as they currently exist. No portion of this material may be reproduced, in any form or by any means, without permission in writing from the publisher.

***7-72.** Determine the location e of the shear center, point O , for the thin-walled member having the cross section shown, where $b_2 > b_1$. The member segments have the same thickness t .

Section Properties :

$$I = \frac{1}{12} t h^3 + 2 \left[(b_1 + b_2) t \left(\frac{h}{2} \right)^2 \right] = \frac{t h^2}{12} [h + 6(b_1 + b_2)]$$

$$Q_1 = \bar{y}' A' = \frac{h}{2} (x_1) t = \frac{h t}{2} x_1$$

$$Q_2 = \bar{y}' A' = \frac{h}{2} (x_2) t = \frac{h t}{2} x_2$$

Shear Flow Resultant :

$$q_1 = \frac{V Q_1}{I} = \frac{P \left(\frac{h t}{2} x_1 \right)}{\frac{t h^2}{12} [h + 6(b_1 + b_2)]} = \frac{6P}{h [h + 6(b_1 + b_2)]} x_1$$

$$q_2 = \frac{V Q_2}{I} = \frac{P \left(\frac{h t}{2} x_2 \right)}{\frac{t h^2}{12} [h + 6(b_1 + b_2)]} = \frac{6P}{h [h + 6(b_1 + b_2)]} x_2$$

$$\begin{aligned} (F_f)_1 &= \int_0^{b_1} q_1 dx_1 = \frac{6P}{h [h + 6(b_1 + b_2)]} \int_0^{b_1} x_1 dx_1 \\ &= \frac{3P b_1^2}{h [h + 6(b_1 + b_2)]} \end{aligned}$$

$$\begin{aligned} (F_f)_2 &= \int_0^{b_2} q_2 dx_2 = \frac{6P}{h [h + 6(b_1 + b_2)]} \int_0^{b_2} x_2 dx_2 \\ &= \frac{3P b_2^2}{h [h + 6(b_1 + b_2)]} \end{aligned}$$

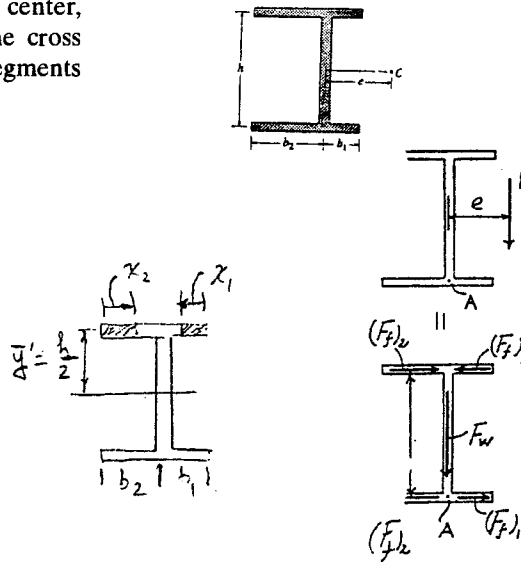

Shear Center : Summing moment about point A.

$$P e = (F_f)_2 h - (F_f)_1 h$$

$$P e = \frac{3P b_2^2}{h [h + 6(b_1 + b_2)]} (h) - \frac{3P b_1^2}{h [h + 6(b_1 + b_2)]} (h)$$

$$e = \frac{3(b_2^2 - b_1^2)}{h + 6(b_1 + b_2)}$$

Ans

Note that if $b_2 = b_1$, $e = 0$ (I shape).

From *Mechanics of Materials*, Sixth Edition by R. C. Hibbeler, ISBN 0-13-191345-X.

© 2005 R. C. Hibbeler. Published by Pearson Prentice Hall,

Pearson Education, Inc., Upper Saddle River, NJ. All rights reserved.

This material is protected under all copyright laws as they currently exist. No portion of this material may be reproduced, in any form or by any means, without permission in writing from the publisher.

7-73. Determine the location e of the shear center, point O , for the thin-walled member having the cross section shown. The member segments have the same thickness t .

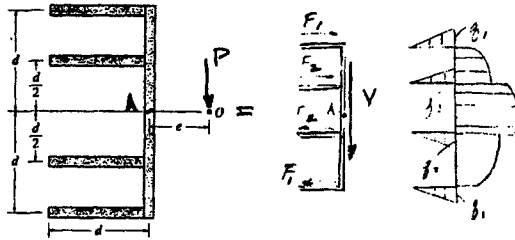

Summing moments about point A :

$$Pe = F_2 d + F_1 (2d) \quad (1)$$

$$I = 2[dt(d)^2] + 2[dt(d/2)^2] = \frac{1}{12}t(2d)^3 = \frac{19}{6}td^3$$

$$q_1 = \frac{P(d)(d)}{\frac{19}{6}td^3} = \frac{6P}{19d}$$

$$F_1 = \frac{1}{2}\left(\frac{6P}{19d}\right)(d) = \frac{3P}{19}$$

$$q_2 = \frac{P(d)(d/2)}{\frac{19}{6}td^3} = \frac{3P}{19d}$$

$$F_2 = \frac{1}{2}\left(\frac{3P}{19d}\right)d = \frac{1.5P}{19}$$

From Eq. (1) :

$$Pe = 2d\left(\frac{3P}{19}\right) + d\left(\frac{1.5P}{19}\right)$$

$$e = \frac{7.5}{19}d = \frac{15}{38}d \quad \text{Ans}$$

From *Mechanics of Materials*, Sixth Edition by R. C. Hibbeler, ISBN 0-13-191345-X.

© 2005 R. C. Hibbeler. Published by Pearson Prentice Hall,

Pearson Education, Inc., Upper Saddle River, NJ. All rights reserved.

This material is protected under all copyright laws as they currently exist. No portion of this material may be reproduced, in any form or by any means, without permission in writing from the publisher.

7-74 Determine the location e of the shear center, point O , for the thin-walled member having the cross section shown. The member segments have the same thickness t .

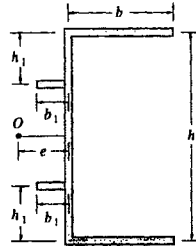

Summing moments about A,

$$Pe = F_2(h) - F_1(h - 2h_1) \quad (1)$$

$$I = \frac{1}{12}(t)h^3 + 2(b)(t)\left(\frac{h}{2}\right)^2 + 2(b_1)(t)\left(\frac{h - 2h_1}{2}\right)^2$$

$$= \frac{1}{12}th^3 + \frac{bth^2}{2} + \frac{b_1t(h - 2h_1)^2}{2}$$

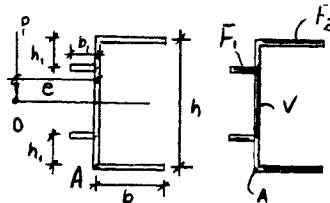

$$Q_1 = \bar{y}_1 'A_1' = \frac{h - 2h_1}{2}(x_1)t$$

$$q_1 = \frac{VQ_1}{I} = \frac{Pt\left(\frac{h - 2h_1}{2}\right)x_1}{I} = \frac{Pt(h - 2h_1)}{2I}x_1$$

$$F_1 = \int_0^{b_1} q_1 dx_1 = \frac{Pt(h - 2h_1)}{2I} \int_0^{b_1} x_1 dx_1 = \frac{Pt b_1^2 (h - 2h_1)}{4I}$$

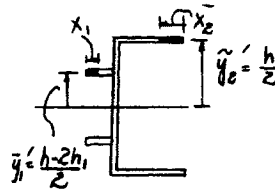

$$Q_2 = \bar{y}_2 'A_2' = \frac{h}{2}(x_2)t$$

$$q_2 = \frac{VQ_2}{I} = \frac{P\left(\frac{h}{2}\right)(x_2)t}{I}$$

$$F_2 = \int q_2 dx_2 = \frac{Ph}{2I} \int_0^b x_2 dx_2 = \frac{Phb^2 t}{4I}$$

From Eq. (1),

$$Pe = \frac{Ph^2 b^2 t}{4I} - \frac{P b_1^2 (h - 2h_1)^2}{4I}$$

$$e = \frac{h^2 b^2 t - b_1^2 (h - 2h_1)^2}{4 \left[\frac{1}{12} t h^3 + \frac{b t h^2}{2} + \frac{b_1 t (h - 2h_1)^2}{2} \right]} = \frac{3[h^2 b^2 - (h - 2h_1)^2 b_1^2]}{h^3 + 6bh^2 + 6b_1(h - 2h_1)^2} \quad \text{Ans}$$

From *Mechanics of Materials*, Sixth Edition by R. C. Hibbeler, ISBN 0-13-191345-X.

© 2005 R. C. Hibbeler. Published by Pearson Prentice Hall,

Pearson Education, Inc., Upper Saddle River, NJ. All rights reserved.

This material is protected under all copyright laws as they currently exist. No portion of this material may be reproduced, in any form or by any means, without permission in writing from the publisher.

7-75 Determine the location e of the shear center, point O , for the thin-walled member having a slit along its side.

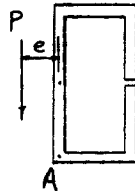
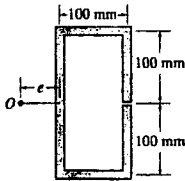

Summing moments about A,

$$P e = 2V_1(100) + F(200) \quad (1)$$

$$I = 2\left[\frac{1}{12}t(0.2^3)\right] + 2[(0.1)(t)(0.1^2)] = 3.3333(10^{-3}) t \text{ m}^4$$

$$Q_1 = \bar{y}_1' A' = \frac{y}{2}(y) t = 0.5y^2 t$$

$$Q_2 = \Sigma \bar{y}' A = 0.05(0.1)(t) + 0.1(x)(t) = 0.005 t + 0.1x t$$

$$q_1 = \frac{VQ_1}{I} = \frac{P(0.5y^2 t)}{3.3333(10^{-3}) t} = 150P y^2$$

$$q_2 = \frac{VQ_2}{I} = \frac{P(0.005 t + 0.1x t)}{3.3333(10^{-3}) t} = 300P(0.005 + 0.1x)$$

$$V_1 = \int_0^{0.1} q_1 dy = 150P \int_0^{0.1} y^2 dy = 150P \left[\frac{y^3}{3} \right]_0^{0.1} = 0.05P$$

$$\begin{aligned} F &= \int_0^{0.1} q_2 dx = 300P \int_0^{0.1} (0.005 + 0.1x) dx \\ &= 300P \left[0.005x + \frac{0.1x^2}{2} \right]_0^{0.1} = 0.3P \end{aligned}$$

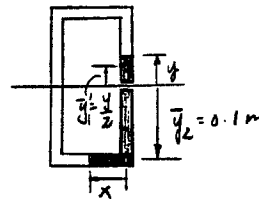
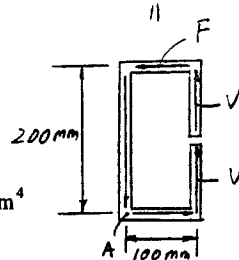

From Eq. (1);

$$P e = 2(0.05P)(100) + 0.3P(200)$$

$$e = 70 \text{ mm} \quad \text{Ans}$$

From *Mechanics of Materials*, Sixth Edition by R. C. Hibbeler, ISBN 0-13-191345-X.

© 2005 R. C. Hibbeler. Published by Pearson Prentice Hall,

Pearson Education, Inc., Upper Saddle River, NJ. All rights reserved.

This material is protected under all copyright laws as they currently exist. No portion of this material may be reproduced, in any form or by any means, without permission in writing from the publisher.

*7-76 Determine the location e of the shear center, point O , for the thin-walled member having the cross section shown. The member segments have the same thickness t .

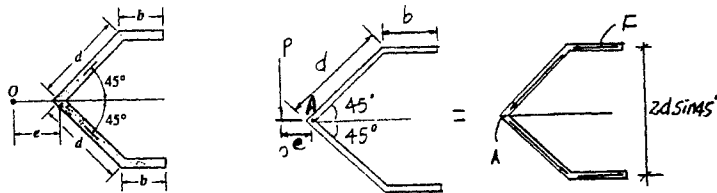

Summing moments about A,

$$Pe = F(2d \sin 45^\circ) \quad (1)$$

$$I = \frac{1}{12} b h^3$$

$$\text{Here } b = \frac{t}{\cos 45^\circ}$$

$$h = 2d \sin 45^\circ$$

$$I = \frac{1}{12} \left(\frac{t}{\cos 45^\circ} \right) (2d \sin 45^\circ)^3 + 2(t)b(d \sin 45^\circ)^2 = \frac{1}{3} t d^3 + t b d^2$$

$$Q = \bar{y}' A' = (d \sin 45^\circ)(x)(t)$$

$$q = \frac{VQ}{I} = \frac{P(0.7071 d t x)}{\frac{1}{3} t d^3 + t b d^2} = \frac{2.1213 P}{d(d + 3b)} x$$

$$F = \int_0^b q dx = \frac{2.1213 P}{d(d + 3b)} \int_0^b x dx = \frac{1.0607 P b^2}{d(d + 3b)}$$

From Eq.(1),

$$Pe = \frac{1.0607 P b^2}{d(d + 3b)} (2d \sin 45^\circ)$$

$$e = \frac{1.5 b^2}{d + 3b} \quad \text{Ans}$$

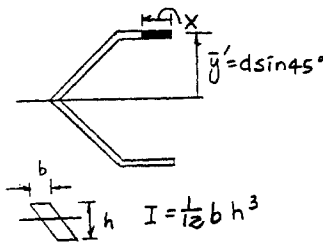

From *Mechanics of Materials*, Sixth Edition by R. C. Hibbeler, ISBN 0-13-191345-X.

© 2005 R. C. Hibbeler. Published by Pearson Prentice Hall,

Pearson Education, Inc., Upper Saddle River, NJ. All rights reserved.

This material is protected under all copyright laws as they currently exist. No portion of this material may be reproduced, in any form or by any means, without permission in writing from the publisher.

7-77 Determine the location e of the shear center, point O , for the thin-walled member having the cross section shown.

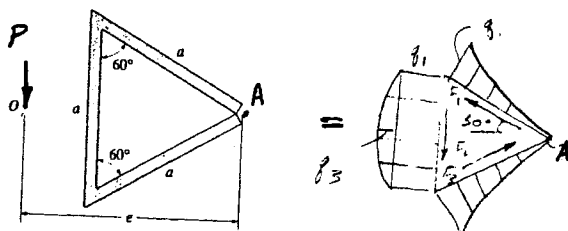

Summing moments about A :

$$Pe = F_2 \left(\frac{\sqrt{3}}{2} a \right)$$

$$I = \frac{1}{12} (t)(a)^3 + \frac{1}{12} \left(\frac{t}{\sin 30^\circ} \right) (a)^3 = \frac{1}{4} t a^3$$

$$q_1 = \frac{V(a)(t)(a/4)}{\frac{1}{4} t a^3} = \frac{V}{a}$$

$$q_2 = q_1 + \frac{V(a/2)(t)(a/4)}{\frac{1}{4} t a^3} = q_1 + \frac{V}{2a}$$

$$F_2 = \frac{V}{a}(a) + \frac{2}{3} \left(\frac{V}{2a} \right) (a) = \frac{4V}{3}$$

$$e = \frac{2\sqrt{3}}{3} a \quad \text{Ans}$$

From *Mechanics of Materials*, Sixth Edition by R. C. Hibbeler, ISBN 0-13-191345-X.

© 2005 R. C. Hibbeler. Published by Pearson Prentice Hall,

Pearson Education, Inc., Upper Saddle River, NJ. All rights reserved.

This material is protected under all copyright laws as they currently exist. No portion of this material may be reproduced, in any form or by any means, without permission in writing from the publisher.

7-78. If the angle has a thickness of 3 mm, a height $h = 100$ mm, and it is subjected to a shear of $V = 50$ N, determine the shear flow at point A and the maximum shear flow in the angle.

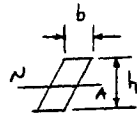
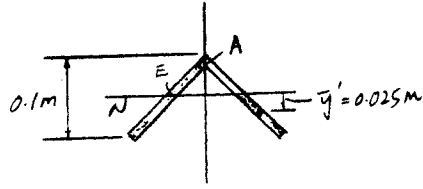
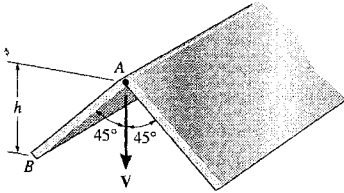

$$I_{NA} = \frac{1}{2} b h^3$$

$$b = \frac{0.003}{\cos 45^\circ} = 0.00424264 \text{ m}$$

$$h = 0.1 \text{ m}$$

$$I = 2 \left[\frac{1}{12} (0.00424264)(0.1^3) \right] = 0.7071(10^{-6}) \text{ m}^4$$

Centroid E of the shaded area lies on the neutral axis.

Therefore, $Q_A = 0$

$$Q_{\max} = \bar{y}'A' = 0.025 \left(\frac{0.05}{\cos 45^\circ} \right) (0.003) = 5.3033(10^{-6}) \text{ m}^3$$

$$q_A = \frac{VQ_A}{I} = 0$$

Ans

$$q_{\max} = \frac{VQ_{\max}}{I} = \frac{50(5.3033)(10^{-6})}{0.7071(10^{-6})} = 375 \text{ N/m} \quad \text{Ans}$$

From *Mechanics of Materials*, Sixth Edition by R. C. Hibbeler, ISBN 0-13-191345-X.

© 2005 R. C. Hibbeler. Published by Pearson Prentice Hall,

Pearson Education, Inc., Upper Saddle River, NJ. All rights reserved.

This material is protected under all copyright laws as they currently exist. No portion of this material may be reproduced, in any form or by any means, without permission in writing from the publisher.

7-79. The angle is subjected to a shear of $V = 2$ kip. Sketch the distribution of shear flow along the leg AB . Indicate numerical values at all peaks. The thickness is 0.25 in. and the legs (AB) are 5 in.

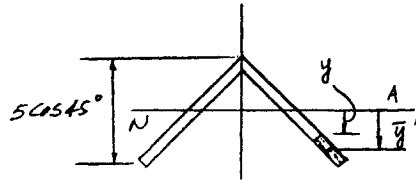
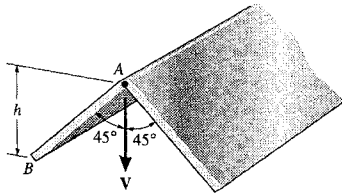

$$b = \frac{0.25}{\cos 45^\circ} = 0.3536 \text{ in.}$$

$$h = 5 \cos 45^\circ = 3.5355 \text{ in.}$$

$$I = 2 \left[\frac{1}{12} (0.3536)(3.5355^3) \right] = 2.6042 \text{ in}^4$$

$$\bar{y}' = y + \frac{2.5 \cos 45^\circ - y}{2} = 0.5y + 0.8839$$

$$A' = (2.5 \cos 45^\circ - y) \left(\frac{0.25}{\cos 45^\circ} \right) = 0.625 - 0.3536 y$$

$$Q = \bar{y}' A' = (0.5y + 0.8839)(0.625 - 0.3536 y) = -0.1768 y^2 + 0.5524$$

$$q = \frac{VQ}{I} = \frac{2(10^3)(-0.1768 y^2 + 0.5524)}{2.6042} = (-136 y^2 + 424) \text{ lb/in.} \quad \text{Ans}$$

$$q_{\max} = 424 \text{ lb/in.} \quad \text{Ans}$$

$$q = (-136y^2 + 424) \text{ lb/in}$$

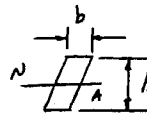
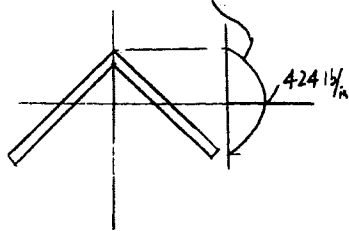

$$I_{NA} = \frac{1}{12} b h^3$$

From *Mechanics of Materials*, Sixth Edition by R. C. Hibbeler, ISBN 0-13-191345-X.

© 2005 R. C. Hibbeler. Published by Pearson Prentice Hall,

Pearson Education, Inc., Upper Saddle River, NJ. All rights reserved.

This material is protected under all copyright laws as they currently exist. No portion of this material may be reproduced, in any form or by any means, without permission in writing from the publisher.

*7-80 Determine the placement e for the force P so that the beam bends downward without twisting. Take $h = 200$ mm.

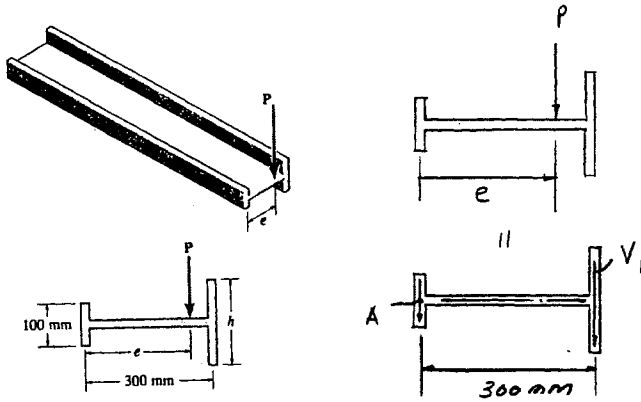

Summing moments about A,

$$P e = 300V \quad (1)$$

$$I = \frac{1}{12} t(0.1^3) + \frac{1}{12} (t)(0.2^3) = 0.75(10^{-3}) t \text{ m}^4$$

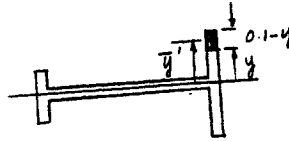

$$\bar{y} = y + \frac{0.1 - y}{2} = \frac{1}{2}(y + 0.1)$$

$$Q = \bar{y}A' = \frac{1}{2}(y + 0.1)(0.1 - y)t = \frac{t}{2}(0.01 - y^2)$$

$$q = \frac{VQ}{I} = \frac{P(\frac{1}{2})(0.01 - y^2)}{0.75(10^{-3})t} = 666.67P(0.01 - y^2)$$

$$\begin{aligned} V_1 &= \int_{-0.1}^{0.1} q dy = 666.67P \int_{-0.1}^{0.1} (0.01 - y^2) dy \\ &= 666.67P \left[0.01y - \frac{y^3}{3} \right]_{-0.1}^{0.1} = 0.8889P \end{aligned}$$

From Eq. (1); $P e = 300(0.8889P)$

$e = 267$ mm **Ans**

From *Mechanics of Materials*, Sixth Edition by R. C. Hibbeler, ISBN 0-13-191345-X.

© 2005 R. C. Hibbeler. Published by Pearson Prentice Hall,

Pearson Education, Inc., Upper Saddle River, NJ. All rights reserved.

This material is protected under all copyright laws as they currently exist. No portion of this material may be reproduced, in any form or by any means, without permission in writing from the publisher.

7-81 A force P is applied to the web of the beam as shown. If $e = 250$ mm, determine the height h of the right flange so that the beam will deflect downward without twisting. The member segments have the same thickness t .

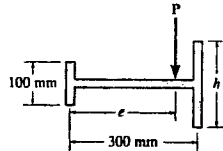
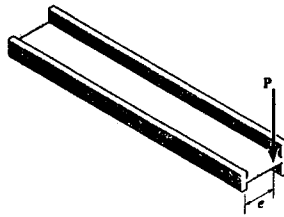

Summing moments about A ,

$$P(250) = V_1(300); \quad V_1 = 0.8333P \quad (1)$$

$$I = \frac{1}{12}t(0.1^3) + \frac{1}{12}(t)(h^3) = \frac{t}{12}(0.001 + h^3)$$

$$\bar{y} = y + \frac{0.5h - y}{2} = \frac{1}{2}(y + 0.5h)$$

$$Q = \bar{y}A' = \frac{1}{2}(y + 0.5h)(0.5h - y)t = \frac{t}{2}(0.25h^2 - y^2)$$

$$q = \frac{VQ}{I} = \frac{P(\frac{t}{2})(0.25h^2 - y^2)}{\frac{t}{12}(0.001 + h^3)} = \frac{6P(0.25h^2 - y^2)}{(0.001 + h^3)}$$

$$V_1 = \int_{-\frac{h}{2}}^h q dy = \frac{6P}{0.001 + h^3} \int_{-\frac{h}{2}}^h (0.25h^2 - y^2) dy$$

$$= \frac{6P}{0.001 + h^3} \left[0.25h^2 y - \frac{y^3}{3} \right]_{-\frac{h}{2}}^h = \frac{P h^3}{0.001 + h^3}$$

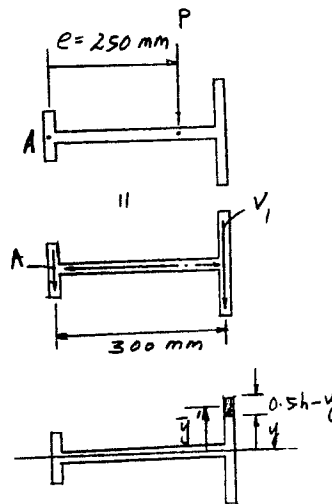

From Eq. (1)

$$0.8333P = \frac{P h^3}{0.001 + h^3}$$

$$h = 0.171 \text{ m} = 171 \text{ mm} \quad \text{Ans}$$

From *Mechanics of Materials*, Sixth Edition by R. C. Hibbeler, ISBN 0-13-191345-X.

© 2005 R. C. Hibbeler. Published by Pearson Prentice Hall,

Pearson Education, Inc., Upper Saddle River, NJ. All rights reserved.

This material is protected under all copyright laws as they currently exist. No portion of this material may be reproduced, in any form or by any means, without permission in writing from the publisher.

7-82. Determine the location e of the shear center, point O , for the thin-walled member having the cross section shown.

Summing moments about A ,

$$P e = r \int dF \quad (1)$$

$$dA = t ds = t r d\theta$$

$$y = r \sin\theta$$

$$dI = y^2 dA = r^2 \sin^2\theta (t r d\theta) = r^3 t \sin^2\theta d\theta$$

$$\begin{aligned} I &= r^3 t \int \sin^2\theta d\theta = r^3 t \int_{\pi-\alpha}^{\pi+\alpha} \frac{1 - \cos 2\theta}{2} d\theta \\ &= \frac{r^3 t}{2} \left(\theta - \frac{\sin 2\theta}{2} \right) \Big|_{\pi-\alpha}^{\pi+\alpha} \\ &= \frac{r^3 t}{2} \left[(\pi + \alpha - \frac{\sin 2(\pi + \alpha)}{2}) - (\pi - \alpha - \frac{\sin 2(\pi - \alpha)}{2}) \right] \\ &= \frac{r^3 t}{2} 2 \sin\alpha \cos\alpha = \frac{r^3 t}{2} (2\alpha - \sin 2\alpha) \end{aligned}$$

$$dQ = y dA = r \sin\theta (t r d\theta) = r^2 t \sin\theta d\theta$$

$$Q = r^2 t \int_{\pi-\alpha}^{\theta} \sin\theta d\theta = r^2 t (-\cos\theta) \Big|_{\pi-\alpha}^{\theta} = r^2 t (-\cos\theta - \cos\alpha) = -r^2 t (\cos\theta + \cos\alpha)$$

$$q = \frac{VQ}{I} = \frac{P(-r^2 t)(\cos\theta + \cos\alpha)}{\frac{r^3 t}{2}(2\alpha - \sin 2\alpha)} = \frac{-2P(\cos\theta + \cos\alpha)}{r(2\alpha - \sin 2\alpha)}$$

$$\int dF = \int q ds = \int q r d\theta$$

$$\begin{aligned} \int dF &= \frac{-2P r}{r(2\alpha - \sin 2\alpha)} \int_{\pi-\alpha}^{\pi+\alpha} (\cos\theta + \cos\alpha) d\theta = \frac{-2P}{2\alpha - \sin 2\alpha} (2\alpha \cos\alpha - 2\sin\alpha) \\ &= \frac{4P}{2\alpha - \sin 2\alpha} (\sin\alpha - \alpha \cos\alpha) \end{aligned}$$

From Eq.(1); $P e = r \left[\frac{4P}{2\alpha - \sin 2\alpha} (\sin\alpha - \alpha \cos\alpha) \right]$

$$e = \frac{4r (\sin\alpha - \alpha \cos\alpha)}{2\alpha - \sin 2\alpha} \quad \text{Ans}$$

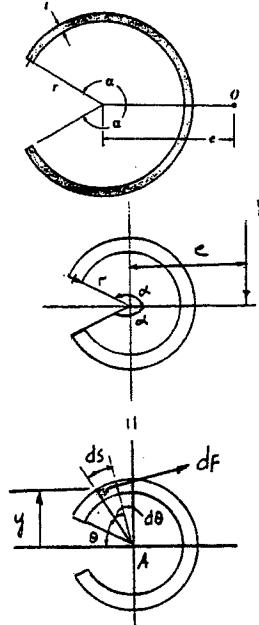

From *Mechanics of Materials*, Sixth Edition by R. C. Hibbeler, ISBN 0-13-191345-X.

© 2005 R. C. Hibbeler. Published by Pearson Prentice Hall,

Pearson Education, Inc., Upper Saddle River, NJ. All rights reserved.

This material is protected under all copyright laws as they currently exist. No portion of this material may be reproduced, in any form or by any means, without permission in writing from the publisher.

7-83 Determine the location e of the shear center, point O , for the beam having the cross section shown. The thickness is t .

$$I = (2) \left[\frac{1}{12} (t) (r/2)^3 + (r/2)(t) \left(r + \frac{r}{4} \right)^2 \right] + I_{\text{semi-circle}}$$

$$= 1.583333t r^3 + I_{\text{semi-circle}}$$

$$I_{\text{semi-circle}} = \int_{-\pi/2}^{\pi/2} (r \sin \theta)^2 t r d\theta = t r^3 \int_{-\pi/2}^{\pi/2} \sin^2 \theta d\theta$$

$$I_{\text{semi-circle}} = t r^3 \left(\frac{\pi}{2} \right)$$

Thus,

$$I = 1.583333t r^3 + t r^3 \left(\frac{\pi}{2} \right) = 3.15413t r^3$$

$$Q = \left(\frac{r}{2} \right) t \left(\frac{r}{4} + r \right) + \int_{\theta}^{\pi/2} r \sin \theta (t r d\theta)$$

$$Q = 0.625 + r^2 + t r^2 \cos \theta$$

$$q = \frac{VQ}{I} = \frac{P(0.625 + \cos \theta) t r^2}{3.15413 t r^3}$$

Summing moments about A :

$$P e = \int_{-\pi/2}^{\pi/2} (q r d\theta) r$$

$$P e = \frac{P r}{3.15413} \int_{-\pi/2}^{\pi/2} (0.625 + \cos \theta) d\theta$$

$$e = \frac{r (1.9634 + 2)}{3.15413}$$

$$e = 1.26 r \quad \text{Ans}$$

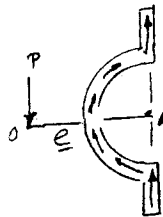
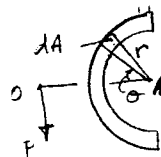
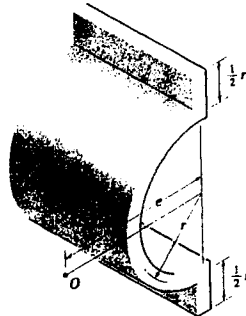

From *Mechanics of Materials*, Sixth Edition by R. C. Hibbeler, ISBN 0-13-191345-X.
 © 2005 R. C. Hibbeler. Published by Pearson Prentice Hall,
 Pearson Education, Inc., Upper Saddle River, NJ. All rights reserved.
 This material is protected under all copyright laws as they currently exist. No portion of this material may be reproduced, in any form or by any means, without permission in writing from the publisher.

***7-84.** Determine the location e of the shear center, point O , for the beam having the cross section shown. The thickness is t .

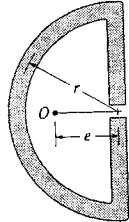

$$I = 2\left(\frac{1}{12}tr^3 + tr(r/2)^2\right) + \int_{-\pi/2}^{\pi/2} (r \sin \theta)^2 tr d\theta$$

$$= 0.6667 tr^3 + tr^3\left(\frac{\pi}{2}\right) = 2.2375 tr^3$$

$$Q = \left(\frac{r}{2}\right)(rt) + \int_{\theta}^{\pi/2} r \sin \theta (tr d\theta)$$

$$= 0.5 tr^2 + tr^2 \cos \theta$$

$$q = \frac{VQ}{I} = \frac{P(0.5 + \cos \theta)tr^2}{2.2375 tr^3}$$

Summing moments about A,

$$Pe = \int_{-\pi/2}^{\pi/2} (qr d\theta)r$$

$$Pe = \frac{Pr}{2.2375} \int_{-\pi/2}^{\pi/2} (0.5 + \cos \theta)d\theta$$

$$e = \frac{r(1.5708 + 2)}{2.2375}$$

$$e = 1.60 r \quad \text{Ans}$$

From *Mechanics of Materials*, Sixth Edition by R. C. Hibbeler, ISBN 0-13-191345-X.

© 2005 R. C. Hibbeler. Published by Pearson Prentice Hall,

Pearson Education, Inc., Upper Saddle River, NJ. All rights reserved.

This material is protected under all copyright laws as they currently exist. No portion of this material may be reproduced, in any form or by any means, without permission in writing from the publisher.

7-85 Determine the shear stress at points B and C on the web of the beam located at section a-a.

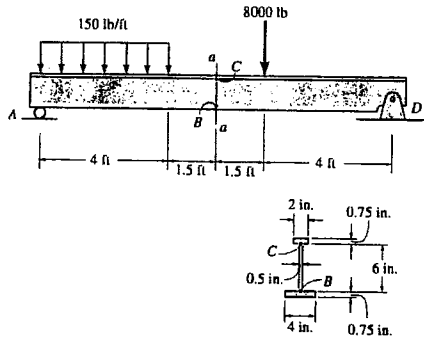

$$\bar{y} = \frac{(0.375)(4)(0.75) + (3.75)(6)(0.5) + (7.125)(2)(0.75)}{4(0.75) + 6(0.5) + 2(0.75)} = 3.075 \text{ in.}$$

$$I = \frac{1}{12} (4)(0.75^3) + 4(0.75)(3.075 - 0.375)^2$$

$$+ \frac{1}{12} (0.5)(6^3) + 0.5(6)(3.75 - 3.075)^2$$

$$+ \frac{1}{12} (2)(0.75^3) + 2(0.75)(7.125 - 3.075)^2$$

$$= 57.05 \text{ in}^4$$

$$Q_B = \bar{y}_B A' = 2.7(4)(0.75) = 8.1 \text{ in}^3$$

$$Q_C = \bar{y}_C A' = 4.05(2)(0.75) = 6.075 \text{ in}^3$$

$$\tau = \frac{VQ}{It}$$

$$\tau_B = \frac{2800(8.1)}{57.05(0.5)} = 795 \text{ psi} \quad \text{Ans}$$

$$\tau_C = \frac{2800(6.075)}{57.05(0.5)} = 596 \text{ psi} \quad \text{Ans}$$

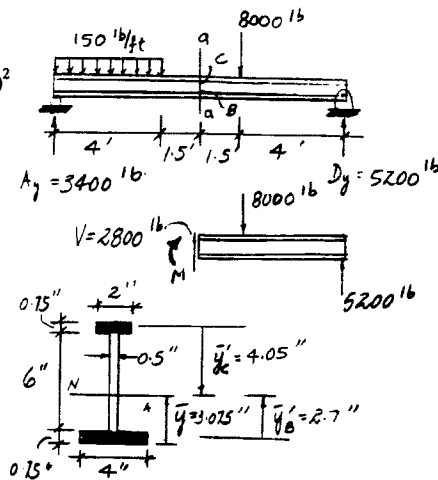

From *Mechanics of Materials*, Sixth Edition by R. C. Hibbeler, ISBN 0-13-191345-X.

© 2005 R. C. Hibbeler. Published by Pearson Prentice Hall,

Pearson Education, Inc., Upper Saddle River, NJ. All rights reserved.

This material is protected under all copyright laws as they currently exist. No portion of this material may be reproduced, in any form or by any means, without permission in writing from the publisher.

7-86. Determine the maximum shear stress acting at section $a-a$ in the beam.

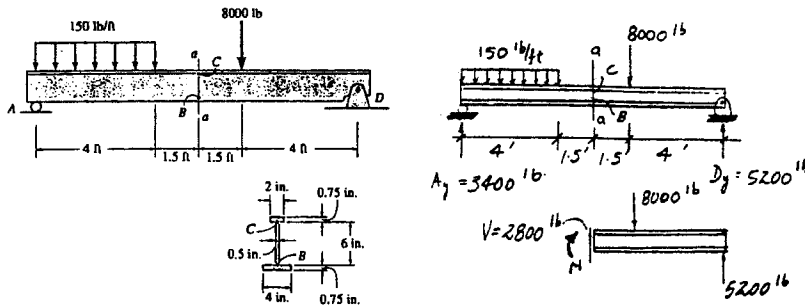

$$\bar{y} = \frac{(0.375)(4)(0.75) + (3.75)(6)(0.5) + (7.125)(2)(0.75)}{4(0.75) + 6(0.5) + 2(0.75)} = 3.075 \text{ in.}$$

$$I = \frac{1}{12} (4)(0.75^3) + 4 (0.75)(3.075 - 0.375)^2$$

$$+ \frac{1}{12} (0.5)(6^3) + 0.5 (6)(3.75 - 3.075)^2$$

$$+ \frac{1}{12} (2)(0.75^3) + 2 (0.75)(7.125 - 3.075)^2$$

$$= 57.05 \text{ in}^4$$

$$Q_{\max} = \Sigma \bar{y}'A'$$

$$= 2.7(4)(0.75) + 2.325 (0.5)(1.1625)$$

$$= 9.4514 \text{ in}^3$$

$$\tau_{\max} = \frac{VQ_{\max}}{It} = \frac{2800(9.4514)}{57.05 (0.5)} = 928 \text{ psi} \quad \text{Ans}$$

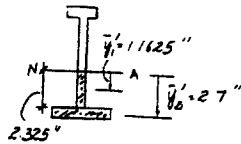

From *Mechanics of Materials*, Sixth Edition by R. C. Hibbeler, ISBN 0-13-191345-X.

© 2005 R. C. Hibbeler. Published by Pearson Prentice Hall,

Pearson Education, Inc., Upper Saddle River, NJ. All rights reserved.

This material is protected under all copyright laws as they currently exist. No portion of this material may be reproduced, in any form or by any means, without permission in writing from the publisher.

7-87 The beam is made from four boards nailed together as shown. If the nails can each support a shear force of 100 lb, determine their required spacings s' and s if the beam is subjected to a shear of $V = 700$ lb.

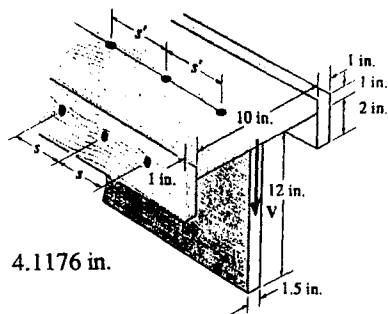

$$\bar{y} = \frac{(0.5)(10)(1) + (2)(1.5)(3)(1) + (7)(12)(1.5)}{(10)(1) + (2)(3)(1) + (12)(1.5)} = 4.1176 \text{ in.}$$

$$I = \frac{1}{12}(10)(1^3) + 10(1)(4.1176 - 0.5)^2 + 2\left[\frac{1}{12}(1)(3^3) + (1)(3)(4.1176 - 1.5)^2\right] + \frac{1}{12}(1.5)(12^3) + (12)(1.5)(7 - 4.1176)^2 = 542.86 \text{ in}^4$$

$$Q_A = \bar{y}_A' A' = 2.6176(3)(1) = 7.8528 \text{ in}^3$$

$$Q_B = \Sigma \bar{y}_B' A' = 2(2.6176)(3)(1) + 3.6176(10)(1) = 51.8816 \text{ in}^3$$

$$q_A = \frac{VQ_A}{I} = \frac{700(7.8528)}{542.86} = 10.126 \text{ lb / in.}$$

$$q_B = \frac{VQ_B}{I} = \frac{700(51.8816)}{542.86} = 66.90 \text{ lb / in.}$$

$$s' = \frac{100}{q_B} = \frac{100}{66.90} = 1.49 \text{ in.} \quad \text{Ans}$$

$$s = \frac{100}{q_A} = \frac{100}{10.126} = 9.88 \text{ in.} \quad \text{Ans}$$

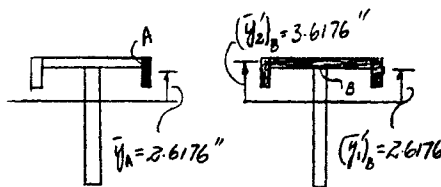

From *Mechanics of Materials*, Sixth Edition by R. C. Hibbeler, ISBN 0-13-191345-X.

© 2005 R. C. Hibbeler. Published by Pearson Prentice Hall,

Pearson Education, Inc., Upper Saddle River, NJ. All rights reserved.

This material is protected under all copyright laws as they currently exist. No portion of this material may be reproduced, in any form or by any means, without permission in writing from the publisher.

*7-88 The beam is made from four boards nailed together as shown. If the beam is subjected to a shear of $V = 1200$ lb, determine the shear force in each nail. The spacing along the side is $s = 3$ in. and at the top, $s' = 4.5$ in.

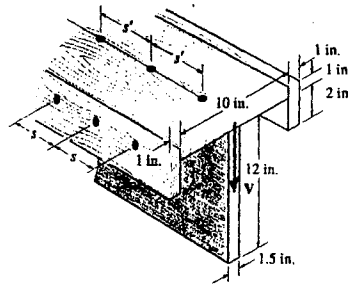
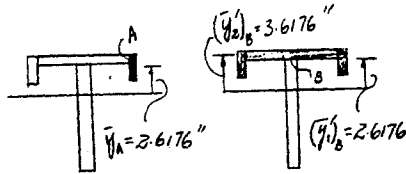

$$\bar{y} = \frac{(0.5)(10)(1) + (2)(1.5)(3)(1) + (7)(12)(1.5)}{(10)(1) + (2)(3)(1) + (12)(1.5)} = 4.1176 \text{ in.}$$

$$I = \frac{1}{12}(10)(1^3) + 10(1)(4.1176 - 0.5)^2 + 2\left[\frac{1}{12}(1)(3^3) + (1)(3)(4.1176 - 1.5)^2\right] + \frac{1}{12}(1.5)(12^3) + (12)(1.5)(7 - 4.1176)^2 = 542.86 \text{ in}^4$$

$$Q_A = \bar{y}_A A' = 2.6176(3)(1) = 7.8528 \text{ in}^3$$

$$Q_B = \Sigma \bar{y}_B A' = 2(2.6176)(3)(1) + 3.6176(10)(1) = 51.8816 \text{ in}^3$$

$$q_A = \frac{VQ_A}{I} = \frac{1200(7.8528)}{542.86} = 17.359 \text{ lb / in.}$$

$$q_B = \frac{VQ_B}{I} = \frac{1200(51.8816)}{542.86} = 114.685 \text{ lb / in.}$$

$$s' = \frac{F'}{q_B}; \quad 4.5 = \frac{F'}{114.685}; \quad F' = 516 \text{ lb} \quad \text{Ans}$$

$$s = \frac{F}{q_A}; \quad 3 = \frac{F}{17.359}; \quad F = 52.1 \text{ lb} \quad \text{Ans}$$

From *Mechanics of Materials*, Sixth Edition by R. C. Hibbeler, ISBN 0-13-191345-X.

© 2005 R. C. Hibbeler. Published by Pearson Prentice Hall,

Pearson Education, Inc., Upper Saddle River, NJ. All rights reserved.

This material is protected under all copyright laws as they currently exist. No portion of this material may be reproduced, in any form or by any means, without permission in writing from the publisher.

7-89 The beam is made from three thin plates welded together as shown. If it is subjected to a shear of $V = 48$ kN, determine the shear flow at points A and B . Also, calculate the maximum shear stress in the beam.

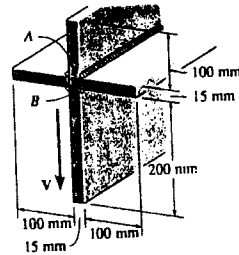

$$\bar{y} = \frac{\Sigma \bar{y}A}{\Sigma A} = \frac{0.1575(0.315)(0.015) + 2[0.2075(0.1)(0.015)]}{0.315(0.015) + 2(0.1)(0.015)} = 0.17692 \text{ m}$$

$$I = \frac{1}{12}(0.015)(0.315^3) + (0.015)(0.315)(0.17692 - 0.1575)^2 + 2\left[\frac{1}{12}(0.1)(0.015^3) + 0.1(0.015)(0.2075 - 0.17692)^2\right] = 43.71347(10^{-6}) \text{ m}^4$$

$$\bar{y}'_A = 0.315 - 0.17692 - 0.05 = 0.08808 \text{ m}$$

$$\bar{y}'_B = 0.315 - 0.17692 - 0.1075 = 0.03058 \text{ m}$$

$$\bar{y}' = \frac{0.17692}{2} = 0.08846 \text{ m}$$

$$Q_A = \bar{y}'_A A' = 0.08808(0.1)(0.015) = 0.13212(10^{-3}) \text{ m}^3$$

$$Q_B = \bar{y}'_B A' = 0.03058(0.1)(0.015) = 45.87(10^{-6}) \text{ m}^3$$

$$Q_{\max} = \bar{y}' A' = 0.08846(0.17692)(0.015) = 0.234755(10^{-3}) \text{ m}^3$$

$$q = \frac{VQ}{I}$$

$$q_A = \frac{48(10^3)(0.13212)(10^{-3})}{43.71347(10^{-6})} = 145 \text{ kN/m} \quad \text{Ans}$$

$$q_B = \frac{48(10^3)(45.87)(10^{-6})}{43.71347(10^{-6})} = 50.4 \text{ kN/m} \quad \text{Ans}$$

$$\tau_{\max} = \frac{VQ_{\max}}{It} = \frac{48(10^3)(0.234755)(10^{-3})}{43.71347(10^{-6})(0.015)} = 17.2 \text{ MPa} \quad \text{Ans}$$

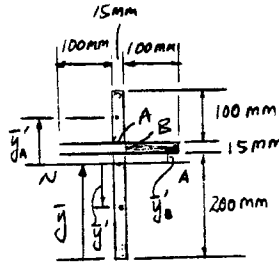

From *Mechanics of Materials*, Sixth Edition by R. C. Hibbeler, ISBN 0-13-191345-X.

© 2005 R. C. Hibbeler. Published by Pearson Prentice Hall,

Pearson Education, Inc., Upper Saddle River, NJ. All rights reserved.

This material is protected under all copyright laws as they currently exist. No portion of this material may be reproduced, in any form or by any means, without permission in writing from the publisher.

7-90. The beam is subjected to a shear of $V = 25$ kN. Determine the shear stress at points A and B and compute the maximum shear stress in the beam. There is a very small gap at C .

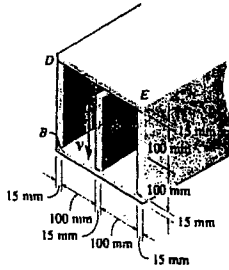
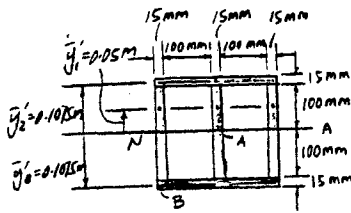

$$I = \frac{1}{12}(0.245)(0.23^3) - \frac{1}{12}(0.2)(0.2^3) = 0.1151(10^{-3}) \text{ m}^4$$

$$Q_A = \Sigma y^1 A^1 = (0.100)(0.015)(0.05) = 75 \times 10^{-6} \text{ m}^3$$

$$Q_B = \bar{y}_B' A' = 0.1075(0.245)(0.015) = 0.3951(10^{-3}) \text{ m}^3$$

$$\tau = \frac{VQ}{I t}$$

$$\tau_A = \frac{25(10^3)(75)(10^{-6})}{0.1151(10^{-3})(0.015)} = 1.09 \text{ MPa} \quad \text{Ans.}$$

$$\tau_B = \frac{25(10^3)(0.3951)(10^{-3})}{0.1151(10^{-3})(2)(0.015)} = 2.86 \text{ MPa} \quad \text{Ans.}$$

$$Q_{\max} = \Sigma y^1 A^1 = (0.1075)(0.245)(0.015) + 2[(0.100)(0.015)(0.05)] + (0)(0.1)(0.015) = 0.5451(10^{-3})$$

$$\tau_{\max} = \frac{25(10^3)(0.5451)(10^{-3})}{0.1151(10^{-3})(2)(0.015)} = 3.95 \text{ MPa} \quad \text{Ans.}$$

From *Mechanics of Materials*, Sixth Edition by R. C. Hibbeler, ISBN 0-13-191345-X.

© 2005 R. C. Hibbeler. Published by Pearson Prentice Hall,

Pearson Education, Inc., Upper Saddle River, NJ. All rights reserved.

This material is protected under all copyright laws as they currently exist. No portion of this material may be reproduced, in any form or by any means, without permission in writing from the publisher.

7-91 The beam is subjected to a shear of $V = 25 \text{ kN}$. Determine the shear stress at points A and B and compute the maximum shear stress in the beam. Assume the gap at C is closed so that the center plate is fixed to the top plate.

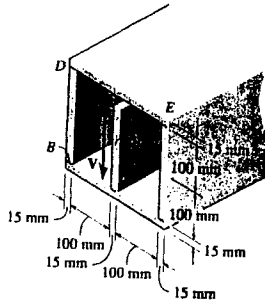
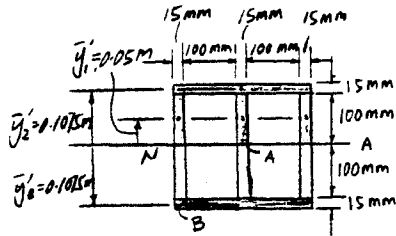

$$I = \frac{1}{12}(0.245)(0.23^3) - \frac{1}{12}(0.2)(0.2^3) = 0.1151(10^{-3}) \text{ m}^4$$

$$Q_A = \sum \bar{y}'A' = 3[0.05(0.1)(0.015)] + 0.1075(0.245)(0.015) = 0.6201(10^{-3}) \text{ m}^3$$

$$Q_B = \bar{y}_B' A' = 0.1075(0.245)(0.015) = 0.3951(10^{-3}) \text{ m}^3$$

$$\tau = \frac{VQ}{It}$$

$$\tau_A = \frac{25(10^3)(0.6201)(10^{-3})}{0.1151(10^{-3})(3)(0.015)} = 2.99 \text{ MPa} \quad \text{Ans}$$

$$\tau_B = \frac{25(10^3)(0.3951)(10^{-3})}{0.1151(10^{-3})(3)(0.015)} = 1.91 \text{ MPa} \quad \text{Ans}$$

$$\tau_{\max} = \tau_A = 2.99 \text{ MPa} \quad \text{Ans}$$

From *Mechanics of Materials*, Sixth Edition by R. C. Hibbeler, ISBN 0-13-191345-X.

© 2005 R. C. Hibbeler. Published by Pearson Prentice Hall,

Pearson Education, Inc., Upper Saddle River, NJ. All rights reserved.

This material is protected under all copyright laws as they currently exist. No portion of this material may be reproduced, in any form or by any means, without permission in writing from the publisher.

*7-92 Determine the location e of the shear center, point O , for the thin-walled member having the cross section shown.

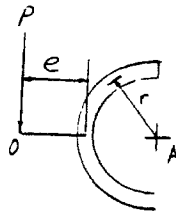
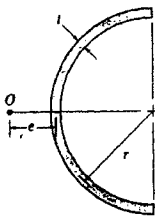

Summing moments about A,

$$P(e + r) = r \int dF \quad (1)$$

$$y = r \cos \theta; \quad dA = t ds$$

$$dI = y^2 dA = r^2 \cos^2 \theta (t) ds; \quad \text{however } ds = r d\theta, \text{ then,}$$

$$\begin{aligned} I &= r^3 t \int_0^\pi \cos^2 \theta d\theta = r^3 t \int_0^\pi \left(\frac{\cos 2\theta + 1}{2} \right) d\theta \\ &= \frac{r^3 t}{2} (\pi) = \frac{\pi r^3 t}{2} \end{aligned}$$

$$dQ = y dA = r \cos \theta (t r d\theta) = r^2 t \cos \theta d\theta$$

$$Q = r^2 t \int_0^\theta \cos \theta d\theta = r^2 t \sin \theta$$

$$q = \frac{VQ}{I} = \frac{P(r^2 t \sin \theta)}{\frac{1}{2} \pi r^3 t} = \frac{2P \sin \theta}{\pi r}$$

$$F = \int dF = \int q ds = \int q r d\theta$$

From Eq. (1)

$$P(e + r) = r \int_0^\pi \frac{2P \sin \theta}{\pi r} (r) d\theta; \quad P(e + r) = \frac{2P r}{\pi} \int_0^\pi \sin \theta d\theta$$

$$e = \frac{2r}{\pi} \int_0^\pi \sin \theta d\theta - r = \frac{4r}{\pi} - r = 0.273r \quad \text{Ans}$$

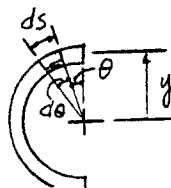
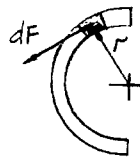

From *Mechanics of Materials*, Sixth Edition by R. C. Hibbeler, ISBN 0-13-191345-X.
 © 2005 R. C. Hibbeler. Published by Pearson Prentice Hall,
 Pearson Education, Inc., Upper Saddle River, NJ. All rights reserved.
 This material is protected under all copyright laws as they currently exist. No portion of this material may be reproduced, in any form or by any means, without permission in writing from the publisher.

7-93 The T-beam is subjected to a shear of $V = 150$ kN. Determine the amount of this force that is supported by the web B .

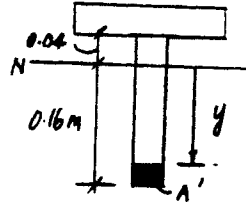
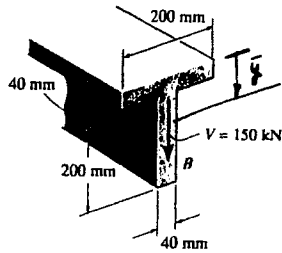

$$\bar{y} = \frac{(0.02)(0.2)(0.04) + (0.14)(0.2)(0.04)}{0.2(0.04) + 0.2(0.04)} = 0.08 \text{ m}$$

$$I = \frac{1}{12}(0.2)(0.04^3) + 0.2(0.04)(0.08 - 0.02)^2 + \frac{1}{12}(0.04)(0.2^3) + 0.2(0.04)(0.14 - 0.08)^2 = 85.3333 (10^{-6}) \text{ m}^4$$

$$A' = 0.04(0.16 - y)$$

$$\bar{y}' = y + \frac{(0.16 - y)}{2} = \frac{(0.16 + y)}{2}$$

$$Q = \bar{y}'A' = 0.02(0.0256 - y^2)$$

$$\tau = \frac{VQ}{It} = \frac{150(10^3)(0.02)(0.0256 - y^2)}{85.3333(10^{-6})(0.04)} = 22.5(10^6) - 878.9(10^6)y^2$$

$$V = \int \tau dA, \quad dA = 0.04 dy$$

$$V = \int_{-0.04}^{0.16} (22.5(10^6) - 878.9(10^6)y^2) 0.04 dy$$

$$= \int_{-0.04}^{0.16} (900(10^3) - 35.156(10^6)y^2) dy$$

$$= 131\,250 \text{ N} = 131 \text{ kN} \quad \mathbf{Ans}$$

From *Mechanics of Materials*, Sixth Edition by R. C. Hibbeler, ISBN 0-13-191345-X.

© 2005 R. C. Hibbeler. Published by Pearson Prentice Hall,

Pearson Education, Inc., Upper Saddle River, NJ. All rights reserved.

This material is protected under all copyright laws as they currently exist. No portion of this material may be reproduced, in any form or by any means, without permission in writing from the publisher.

8-1 A spherical gas tank has an inner radius of $r = 1.5$ m. If it is subjected to an internal pressure of $p = 300$ kPa, determine its required thickness if the maximum normal stress is not to exceed 12 MPa.

$$\sigma_{\text{allow}} = \frac{pr}{2t}; \quad 12(10^6) = \frac{300(10^3)(1.5)}{2t}$$

$$t = 0.0188 \text{ m} = 18.8 \text{ mm} \quad \text{Ans}$$

From *Mechanics of Materials*, Sixth Edition by R. C. Hibbeler, ISBN 0-13-191345-X.

© 2005 R. C. Hibbeler. Published by Pearson Prentice Hall,

Pearson Education, Inc., Upper Saddle River, NJ. All rights reserved.

This material is protected under all copyright laws as they currently exist. No portion of this material may be reproduced, in any form or by any means, without permission in writing from the publisher.

8-2 A pressurized spherical tank is to be made of 0.5-in.-thick steel. If it is subjected to an internal pressure of $p = 200$ psi, determine its outer radius if the maximum normal stress is not to exceed 15 ksi.

$$\sigma_{\text{allow}} = \frac{p r}{2 t}; \quad 15(10^3) = \frac{200 r_i}{2(0.5)}$$

$$r_i = 75 \text{ in.}$$

$$r_o = 75 \text{ in.} + 0.5 \text{ in.} = 75.5 \text{ in.} \quad \mathbf{Ans}$$

From *Mechanics of Materials*, Sixth Edition by R. C. Hibbeler, ISBN 0-13-191345-X.

© 2005 R. C. Hibbeler. Published by Pearson Prentice Hall,

Pearson Education, Inc., Upper Saddle River, NJ. All rights reserved.

This material is protected under all copyright laws as they currently exist. No portion of this material may be reproduced, in any form or by any means, without permission in writing from the publisher.

8-3. The tank of a cylindrical air compressor is subjected to an internal pressure of 90 psi. If the internal diameter of the tank is 22 in., and the wall thickness is 0.25 in., determine the stress components acting at a point. Draw a volume element of the material at this point, and show the results on the element.

$$\sigma_1 = \frac{p r}{t} = \frac{90(11)}{0.25} = 3960 \text{ psi} = 3.96 \text{ ksi} \quad \text{Ans}$$

$$\sigma_2 = \frac{p r}{2 t} = \frac{90(11)}{2(0.25)} = 1980 \text{ psi} = 1.98 \text{ ksi} \quad \text{Ans}$$

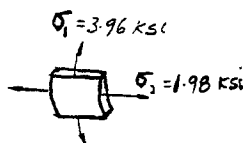

From *Mechanics of Materials*, Sixth Edition by R. C. Hibbeler, ISBN 0-13-191345-X.

© 2005 R. C. Hibbeler. Published by Pearson Prentice Hall,

Pearson Education, Inc., Upper Saddle River, NJ. All rights reserved.

This material is protected under all copyright laws as they currently exist. No portion of this material may be reproduced, in any form or by any means, without permission in writing from the publisher.

*8-4 The thin-walled cylinder can be supported in one of two ways as shown. Determine the state of stress in the wall of the cylinder for both cases if the piston P causes the internal pressure to be 65 psi. The wall has a thickness of 0.25 in. and the inner diameter of the cylinder is 8 in.

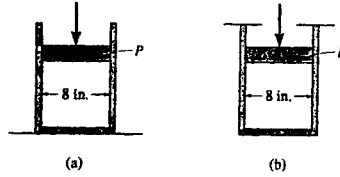

Case (a) :

$$\sigma_1 = \frac{pr}{t}; \quad \sigma_1 = \frac{65(4)}{0.25} = 1.04 \text{ ksi} \quad \text{Ans}$$

$$\sigma_2 = 0 \quad \text{Ans}$$

Case (b) :

$$\sigma_1 = \frac{pr}{t}; \quad \sigma_1 = \frac{65(4)}{0.25} = 1.04 \text{ ksi} \quad \text{Ans}$$

$$\sigma_2 = \frac{pr}{2t}; \quad \sigma_2 = \frac{65(4)}{2(0.25)} = 520 \text{ psi} \quad \text{Ans}$$

From *Mechanics of Materials*, Sixth Edition by R. C. Hibbeler, ISBN 0-13-191345-X.

© 2005 R. C. Hibbeler. Published by Pearson Prentice Hall,

Pearson Education, Inc., Upper Saddle River, NJ. All rights reserved.

This material is protected under all copyright laws as they currently exist. No portion of this material may be reproduced, in any form or by any means, without permission in writing from the publisher.

8-5 The gas pipe line is supported every 20 ft by concrete piers and also lays on the ground. If there are rigid retainers at the piers that hold the pipe fixed, determine the longitudinal and hoop stress in the pipe if the temperature rises 60°F from the temperature at which it was installed. The gas within the pipe is at a pressure of 600 lb/in². The pipe has an inner diameter of 20 in. and thickness of 0.25 in. The material is A-36 steel.

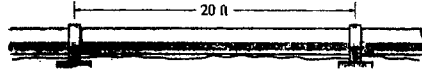

Require,

$$\delta_F = \delta_T; \quad \delta_F = \frac{PL}{AE} = \frac{\sigma L}{E}, \quad \delta_T = \alpha \Delta TL$$

$$\frac{\sigma_2(20)(12)}{29(10^6)} = (6.60)(10^{-6})(60)(20)(12)$$

$$\sigma_2 = 11.5 \text{ ksi} \quad \text{Ans}$$

$$\sigma_1 = \frac{pr}{t} = \frac{600(10)}{0.25} = 24 \text{ ksi} \quad \text{Ans}$$

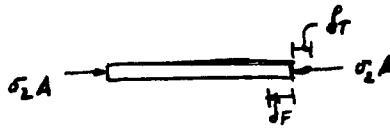

From *Mechanics of Materials*, Sixth Edition by R. C. Hibbeler, ISBN 0-13-191345-X.

© 2005 R. C. Hibbeler. Published by Pearson Prentice Hall,

Pearson Education, Inc., Upper Saddle River, NJ. All rights reserved.

This material is protected under all copyright laws as they currently exist. No portion of this material may be reproduced, in any form or by any means, without permission in writing from the publisher.

8-6. The open-ended polyvinyl chloride pipe has an inner diameter of 4 in. and thickness of 0.2 in. If it carries flowing water at 60 psi pressure, determine the state of stress in the walls of the pipe.



$$\sigma_1 = \frac{p r}{t} = \frac{60(2)}{0.2} = 600 \text{ psi} \quad \text{Ans}$$

$$\sigma_2 = 0 \quad \text{Ans}$$

There is no stress component in the longitudinal direction since the pipe has open ends.

From *Mechanics of Materials*, Sixth Edition by R. C. Hibbeler, ISBN 0-13-191345-X.

© 2005 R. C. Hibbeler. Published by Pearson Prentice Hall,

Pearson Education, Inc., Upper Saddle River, NJ. All rights reserved.

This material is protected under all copyright laws as they currently exist. No portion of this material may be reproduced, in any form or by any means, without permission in writing from the publisher.

8-7. If the flow of water within the pipe in Prob. 8-6 is stopped due to the closing of a valve, determine the state of stress in the walls of the pipe. Neglect the weight of the water. Assume the supports only exert vertical forces on the pipe.



$$\sigma_1 = \frac{p r}{t} = \frac{60(2)}{0.2} = 600 \text{ psi} \quad \text{Ans}$$

$$\sigma_2 = \frac{p r}{2 t} = \frac{60(2)}{2(0.2)} = 300 \text{ psi} \quad \text{Ans}$$

From *Mechanics of Materials*, Sixth Edition by R. C. Hibbeler, ISBN 0-13-191345-X.

© 2005 R. C. Hibbeler. Published by Pearson Prentice Hall,

Pearson Education, Inc., Upper Saddle River, NJ. All rights reserved.

This material is protected under all copyright laws as they currently exist. No portion of this material may be reproduced, in any form or by any means, without permission in writing from the publisher.

***8-8.** The A-36-steel band is 2 in. wide and is secured around the smooth rigid cylinder. If the bolts are tightened so that the tension in them is 400 lb, determine the normal stress in the band, the pressure exerted on the cylinder, and the distance half the band stretches.

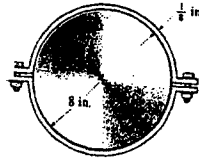

$$\sigma_1 = \frac{400}{2(1/8)(1)} = 1600 \text{ psi}$$

$$\sigma_1 = \frac{pr}{t}; \quad 1600 = \frac{p(8)}{(1/8)}$$

$$p = 25 \text{ psi} \quad \text{Ans}$$

$$\epsilon_1 = \frac{\sigma_1}{E} = \frac{1600}{29(10^6)} = 55.1724(10^{-6})$$

$$\delta = \epsilon_1 L = 55.1724(10^{-6})(\pi)(8 + \frac{1}{16}) = 0.00140 \text{ in.} \quad \text{Ans}$$

From *Mechanics of Materials*, Sixth Edition by R. C. Hibbeler, ISBN 0-13-191345-X.

© 2005 R. C. Hibbeler. Published by Pearson Prentice Hall,

Pearson Education, Inc., Upper Saddle River, NJ. All rights reserved.

This material is protected under all copyright laws as they currently exist. No portion of this material may be reproduced, in any form or by any means, without permission in writing from the publisher.

8-9. A pressure-vessel head is fabricated by gluing the circular plate to the end of the vessel as shown. If the vessel sustains an internal pressure of 450 kPa, determine the average shear stress in the glue and the state of stress in the wall of the vessel.

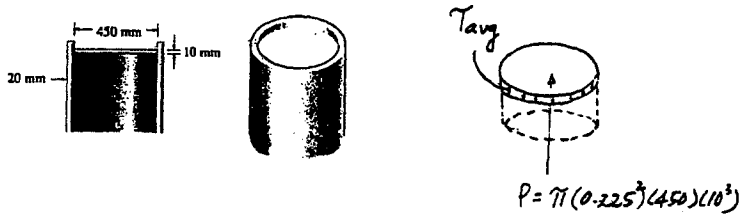

$$+\uparrow \Sigma F_y = 0; \quad \pi(0.225)^2 450(10^3) - \tau_{avg}(2\pi)(0.225)(0.01) = 0;$$

$$\tau_{avg} = 5.06 \text{ MPa} \quad \text{Ans}$$

$$\sigma_1 = \frac{pr}{t} = \frac{450(10^3)(0.225)}{0.02} = 5.06 \text{ MPa} \quad \text{Ans}$$

$$\sigma_2 = \frac{pr}{2t} = \frac{450(10^3)(0.225)}{2(0.02)} = 2.53 \text{ MPa} \quad \text{Ans}$$

From *Mechanics of Materials*, Sixth Edition by R. C. Hibbeler, ISBN 0-13-191345-X.

© 2005 R. C. Hibbeler. Published by Pearson Prentice Hall,

Pearson Education, Inc., Upper Saddle River, NJ. All rights reserved.

This material is protected under all copyright laws as they currently exist. No portion of this material may be reproduced, in any form or by any means, without permission in writing from the publisher.

8-10. An A-36-steel hoop has an inner diameter of 23.99 in., thickness of 0.25 in., and width of 1 in. If it and the 24-in.-diameter rigid cylinder have a temperature of 65° F, determine the temperature to which the hoop should be heated in order for it to just slip over the cylinder. What is the pressure the hoop exerts on the cylinder, and the tensile stress in the ring when it cools back down to 65° F?

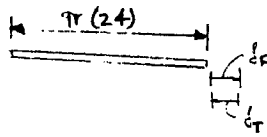
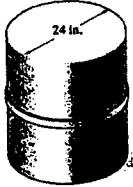

$$\delta_T = \alpha \Delta T L$$

$$\pi(24) - \pi(23.99) = 6.60(10^{-6})(T_1 - 65)(\pi)(23.99)$$

$$T_1 = 128.16^\circ F = 128^\circ \quad \text{Ans}$$

Cool down :

$$\delta_F = \delta_T$$

$$\frac{FL}{AE} = \alpha \Delta T L$$

$$\frac{F(\pi)(24)}{(1)(0.25)(29)(10^6)} = 6.60(10^{-6})(128.16 - 65)(\pi)(24)$$

$$F = 3022.21 \text{ lb}$$

$$\sigma_1 = \frac{F}{A}; \quad \sigma_1 = \frac{3022.21}{(1)(0.25)} = 12\,088 \text{ psi} = 12.1 \text{ ksi} \quad \text{Ans}$$

$$\sigma_1 = \frac{pr}{t}; \quad 12\,088 = \frac{p(12)}{(0.25)}$$

$$p = 252 \text{ psi} \quad \text{Ans}$$

From *Mechanics of Materials*, Sixth Edition by R. C. Hibbeler, ISBN 0-13-191345-X.

© 2005 R. C. Hibbeler. Published by Pearson Prentice Hall,

Pearson Education, Inc., Upper Saddle River, NJ. All rights reserved.

This material is protected under all copyright laws as they currently exist. No portion of this material may be reproduced, in any form or by any means, without permission in writing from the publisher.

8-11 The staves or vertical members of the wooden tank are held together using semicircular hoops having a thickness of 0.5 in. and a width of 2 in. Determine the normal stress in hoop AB if the tank is subjected to an internal gauge pressure of 2 psi and this loading is transmitted directly to the hoops. Also, if 0.25-in.-diameter bolts are used to connect each hoop together, determine the tensile stress in each bolt at A and B . Assume hoop AB supports the pressure loading within a 12-in. length of the tank as shown.

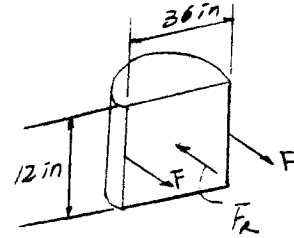
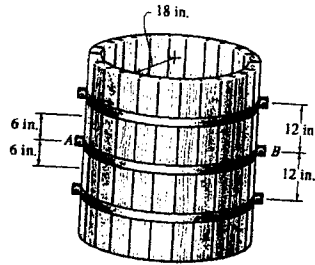

$$F_R = 2(36)(12) = 864 \text{ lb}$$

$$\Sigma F = 0; \quad 864 - 2F = 0; \quad F = 432 \text{ lb}$$

$$\sigma_h = \frac{F}{A_h} = \frac{432}{0.5(2)} = 432 \text{ psi} \quad \text{Ans.}$$

$$\sigma_b = \frac{F}{A_b} = \frac{432}{\frac{\pi}{4}(0.25)^2} = 8801 \text{ psi} = 8.80 \text{ ksi} \quad \text{Ans.}$$

From *Mechanics of Materials*, Sixth Edition by R. C. Hibbeler, ISBN 0-13-191345-X.

© 2005 R. C. Hibbeler. Published by Pearson Prentice Hall,

Pearson Education, Inc., Upper Saddle River, NJ. All rights reserved.

This material is protected under all copyright laws as they currently exist. No portion of this material may be reproduced, in any form or by any means, without permission in writing from the publisher.

***8-12.** A boiler is constructed of 8-mm steel plates that are fastened together at their ends using a butt joint consisting of two 8-mm cover plates and rivets having a diameter of 10 mm and spaced 50 mm apart as shown. If the steam pressure in the boiler is 1.35 MPa, determine (a) the circumferential stress in the boiler's plate apart from the seam, (b) the circumferential stress in the outer cover plate along the rivet line *a-a*, and (c) the shear stress in the rivets.

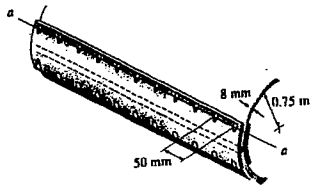

a) $\sigma_1 = \frac{pr}{t} = \frac{1.35(10^6)(0.75)}{0.008} = 126.56(10^6) = 127 \text{ MPa}$ **Ans**

b) $126.56(10^6)(0.05)(0.008) = \sigma_1'(2)(0.04)(0.008)$
 $\sigma_1' = 79.1 \text{ MPa}$ **Ans**

c) From FBD (a)

$+\uparrow \Sigma F_y = 0; F_b - 79.1(10^6)[(0.008)(0.04)] = 0$
 $F_b = 25.3 \text{ kN}$

$(\tau_{avg})_b = \frac{F_b}{A} = \frac{25312.5}{\frac{\pi}{4}(0.01)^2} = 322 \text{ MPa}$ **Ans**

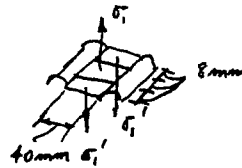
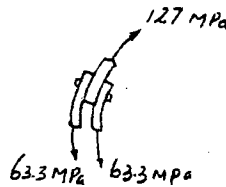

From *Mechanics of Materials*, Sixth Edition by R. C. Hibbeler, ISBN 0-13-191345-X.
 © 2005 R. C. Hibbeler. Published by Pearson Prentice Hall,
 Pearson Education, Inc., Upper Saddle River, NJ. All rights reserved.
 This material is protected under all copyright laws as they currently exist. No portion of this material may be reproduced, in any form or by any means, without permission in writing from the publisher.

8-13 In order to increase the strength of the pressure vessel, filament winding of the same material is wrapped around the circumference of the vessel as shown. If the pretension in the filament is T , and the vessel is subjected to an internal pressure p , determine the hoop stresses in the filament and in the wall of the vessel. Use the free-body diagram shown, and assume the filament winding has a thickness t' and width w for every length L of the vessel.

$$\sigma_{fil} = \frac{T}{t'w}$$

Equilibrium over entire length of the cylinder without internal pressure p .

$$-2\sigma_1'(L)(t) + 2T\left(\frac{L}{w}\right) = 0$$

$$\sigma_1' = \frac{T}{wt}$$

After applying the internal pressure p , the stress in the filament is

$$\sigma_{fil} = \frac{pr}{(t+t')} + \frac{T}{wt} \quad \text{Ans}$$

And for the cylinder ,

$$\sigma_1 = \frac{pr}{(t+t')} - \frac{T}{wt} \quad \text{Ans}$$

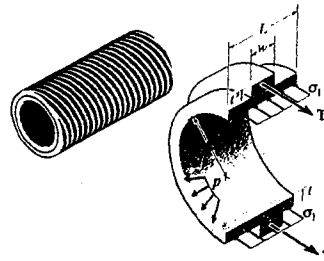

From *Mechanics of Materials*, Sixth Edition by R. C. Hibbeler, ISBN 0-13-191345-X.

© 2005 R. C. Hibbeler. Published by Pearson Prentice Hall,

Pearson Education, Inc., Upper Saddle River, NJ. All rights reserved.

This material is protected under all copyright laws as they currently exist. No portion of this material may be reproduced, in any form or by any means, without permission in writing from the publisher.

8-14. A closed-ended pressure vessel is fabricated by cross winding glass filaments over a mandrel, so that the wall thickness t of the vessel is composed entirely of filament and an epoxy binder as shown. Consider a segment of the vessel of width w and wrapped at an angle θ . If the vessel is subjected to an internal pressure p , show that the force in the segment is $F_\theta = \sigma_0 w t$, where σ_0 is the stress in the filaments. Also, show that the stresses in the hoop and longitudinal directions are $\sigma_h = \sigma_0 \sin^2 \theta$ and $\sigma_l = \sigma_0 \cos^2 \theta$, respectively. At what angle θ (optimum winding angle) would the filaments have to be wound so that the hoop and longitudinal stresses are equivalent?

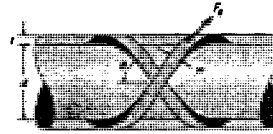

The Hoop and Longitudinal Stresses : Applying Eq.8-1 and Eq.8-2

$$\sigma_1 = \frac{pr}{t} = \frac{p(\frac{d}{2})}{t} = \frac{pd}{2t}$$

$$\sigma_2 = \frac{pr}{2t} = \frac{p(\frac{d}{2})}{2t} = \frac{pd}{4t}$$

The Hoop and Longitudinal Force for Filament :

$$F_h = \sigma_1 A = \frac{pd}{2t} \left(\frac{w}{\sin \theta} t \right) = \frac{pdw}{2 \sin \theta}$$

$$F_l = \sigma_2 A = \frac{pd}{4t} \left(\frac{w}{\cos \theta} t \right) = \frac{pdw}{4 \cos \theta}$$

Hence,

$$F_\theta = \sqrt{F_h^2 + F_l^2}$$

$$= \sqrt{\left(\frac{pdw}{2 \sin \theta} \right)^2 + \left(\frac{pdw}{4 \cos \theta} \right)^2}$$

$$= \frac{pdw}{4} \sqrt{\frac{4}{\sin^2 \theta} + \frac{1}{\cos^2 \theta}}$$

$$= \frac{pdw}{4} \sqrt{\frac{4 \cos^2 \theta + \sin^2 \theta}{\sin^2 \theta \cos^2 \theta}}$$

$$= \frac{pdw}{2 \sqrt{2} \sin 2\theta} \sqrt{3 \cos 2\theta + 5}$$

$$\sigma_\theta = \frac{F_\theta}{A} = \frac{\frac{pdw}{2 \sqrt{2} \sin 2\theta} \sqrt{3 \cos 2\theta + 5}}{wt}$$

$$= \frac{pd}{2 \sqrt{2} t} \left(\frac{\sqrt{3 \cos 2\theta + 5}}{\sin 2\theta} \right) \quad (Q. E. D.)$$

$\frac{d\sigma_\theta}{d\theta} = 0$ when σ_θ is minimum.

$$\frac{d\sigma_\theta}{d\theta} = \frac{pd}{2 \sqrt{2} t} \left[\frac{-2 \cos 2\theta}{\sin^2 2\theta} (\sqrt{3 \cos 2\theta + 5}) - \frac{3}{\sqrt{3 \cos 2\theta + 5}} \right] = 0$$

$$\frac{2 \cos 2\theta}{\sin^2 2\theta} (\sqrt{3 \cos 2\theta + 5}) + \frac{3}{\sqrt{3 \cos 2\theta + 5}} = 0$$

$$(\sqrt{3 \cos 2\theta + 5}) \left(\frac{2 \cos \theta}{\sin^2 2\theta} + \frac{3}{3 \cos 2\theta + 5} \right) = 0$$

$$(\sqrt{3 \cos 2\theta + 5}) \left[\frac{3 \cos^2 2\theta + 10 \cos 2\theta + 3}{\sin^2 2\theta (3 \cos 2\theta + 5)} \right] = 0$$

However, $\sqrt{3 \cos 2\theta + 5} \neq 0$. Therefore,

$$\frac{3 \cos^2 2\theta + 10 \cos 2\theta + 3}{\sin^2 2\theta (3 \cos 2\theta + 5)} = 0$$

$$3 \cos^2 2\theta + 10 \cos 2\theta + 3 = 0$$

$$\cos 2\theta = \frac{-10 \pm \sqrt{10^2 - 4(3)(3)}}{2(3)}$$

$$\cos 2\theta = -0.3333$$

$$\theta = 54.7^\circ \quad \text{Ans}$$

Force in θ Direction : Consider a portion of the cylinder. For a filament wire the cross-sectional area is $A = wt$, then

$$F_\theta = \sigma_0 w t \quad (Q. E. D.)$$

Hoop Stress : The force in hoop direction is $F_h = F_\theta \sin \theta = \sigma_0 w \sin \theta$ and the area is $A = \frac{wt}{\sin \theta}$. Then due to the internal pressure p ,

$$\sigma_h = \frac{F_h}{A} = \frac{\sigma_0 w t \sin \theta}{wt / \sin \theta}$$

$$= \sigma_0 \sin^2 \theta \quad (Q. E. D.)$$

Longitudinal Stress : The force in the longitudinal direction is $F_l = F_\theta \cos \theta = \sigma_0 w \cos \theta$ and the area is $A = \frac{wt}{\cos \theta}$. Then due to the internal pressure p ,

$$\sigma_l = \frac{F_l}{A} = \frac{\sigma_0 w t \cos \theta}{wt / \cos \theta}$$

$$= \sigma_0 \cos^2 \theta \quad (Q. E. D.)$$

Optimum Wrap Angle : This require $\frac{\sigma_h}{\sigma_l} = \frac{pd/2t}{pd/4t} = 2$. Then

$$\frac{\sigma_h}{\sigma_l} = \frac{\sigma_0 \sin^2 \theta}{\sigma_0 \cos^2 \theta} = 2$$

$$\tan^2 \theta = 2$$

$$\theta = 54.7^\circ \quad \text{Ans}$$

From *Mechanics of Materials*, Sixth Edition by R. C. Hibbeler, ISBN 0-13-191345-X.

© 2005 R. C. Hibbeler. Published by Pearson Prentice Hall,

Pearson Education, Inc., Upper Saddle River, NJ. All rights reserved.

This material is protected under all copyright laws as they currently exist. No portion of this material may be reproduced, in any form or by any means, without permission in writing from the publisher.

8-15. The screw of the clamp exerts a compressive force of 500 lb on the wood blocks. Determine the maximum normal stress developed along section $a-a$. The cross section there is rectangular, 0.75 in. by 0.50 in.

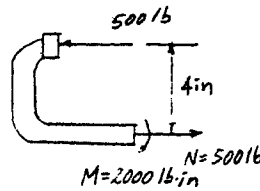
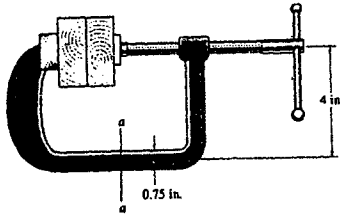

$$A = 0.75(0.5) = 0.375 \text{ in}^2$$

$$I = \frac{1}{12}(0.5)(0.75^3) = 0.017578 \text{ in}^4$$

$$\begin{aligned} \sigma_{\max} &= \frac{P}{A} + \frac{Mc}{I} \\ &= \frac{500}{0.375} + \frac{2000(0.375)}{0.017578} = 44.0 \text{ ksi (T)} \end{aligned} \quad \text{Ans}$$

From *Mechanics of Materials*, Sixth Edition by R. C. Hibbeler, ISBN 0-13-191345-X.

© 2005 R. C. Hibbeler. Published by Pearson Prentice Hall,

Pearson Education, Inc., Upper Saddle River, NJ. All rights reserved.

This material is protected under all copyright laws as they currently exist. No portion of this material may be reproduced, in any form or by any means, without permission in writing from the publisher.

***8-16.** The screw of the clamp exerts a compressive force of 500 lb on the wood blocks. Sketch the stress distribution along section $a-a$ of the clamp. The cross section there is rectangular, 0.75 in. by 0.50 in.

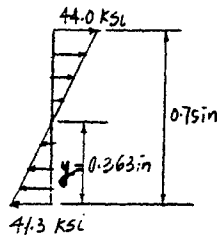
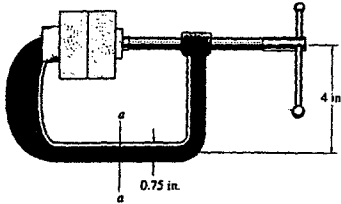

$$A = 0.75(0.5) = 0.375 \text{ in}^2$$

$$I = \frac{1}{12}(0.5)(0.75^3) = 0.017578 \text{ in}^4$$

$$\sigma_{\max} = \frac{P}{A} + \frac{M c}{I} = \frac{500}{0.375} + \frac{2000(0.375)}{0.017578} = 44.0 \text{ ksi (T)}$$

$$\sigma_{\min} = \frac{P}{A} - \frac{M c}{I} = \frac{500}{0.375} - \frac{2000(0.375)}{0.017578} = -41.3 \text{ ksi (C)}$$

$$\frac{y}{41.33} = \frac{(0.75 - y)}{44.0}$$

$$y = 0.363 \text{ in.}$$

From *Mechanics of Materials*, Sixth Edition by R. C. Hibbeler, ISBN 0-13-191345-X.

© 2005 R. C. Hibbeler. Published by Pearson Prentice Hall,

Pearson Education, Inc., Upper Saddle River, NJ. All rights reserved.

This material is protected under all copyright laws as they currently exist. No portion of this material may be reproduced, in any form or by any means, without permission in writing from the publisher.

8-17 The clamp is made from members AB and AC , which are pin connected at A . If it exerts a compressive force at C and B of 180 N , determine the maximum compressive stress in the clamp at section $a-a$. The screw EF is subjected only to a tensile force along its axis.

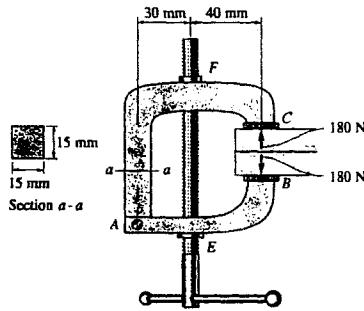
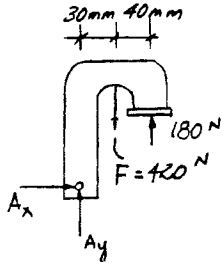

There is no moment in this problem. Therefore, the compressive stress is produced by axial force only.

$$\sigma_{\max} = \frac{P}{A} = \frac{240}{(0.015)(0.015)} = 1.07 \text{ MPa} \quad \text{Ans}$$

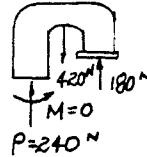

From *Mechanics of Materials*, Sixth Edition by R. C. Hibbeler, ISBN 0-13-191345-X.
 © 2005 R. C. Hibbeler. Published by Pearson Prentice Hall,
 Pearson Education, Inc., Upper Saddle River, NJ. All rights reserved.
 This material is protected under all copyright laws as they currently exist. No portion of this material may be reproduced, in any form or by any means, without permission in writing from the publisher.

8-18 The clamp is made from members AB and AC , which are pin connected at A . If it exerts a compressive force at C and B of 180 N , sketch the stress distribution acting over section $a-a$. The screw EF is subjected only to a tensile force along its axis.

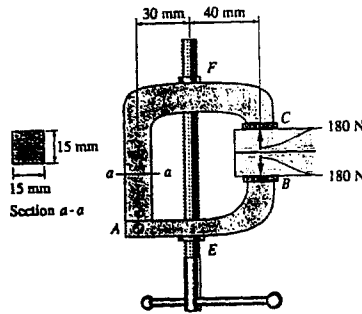
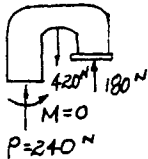

There is no moment in this problem. Therefore, the compressive stress is produced by axial force only.

$$\sigma_{\max} = \frac{P}{A} = \frac{240}{(0.015)(0.015)} = 1.07 \text{ MPa}$$



From *Mechanics of Materials*, Sixth Edition by R. C. Hibbeler, ISBN 0-13-191345-X.

© 2005 R. C. Hibbeler. Published by Pearson Prentice Hall,

Pearson Education, Inc., Upper Saddle River, NJ. All rights reserved.

This material is protected under all copyright laws as they currently exist. No portion of this material may be reproduced, in any form or by any means, without permission in writing from the publisher.

8-19 The coping saw has an adjustable blade that is tightened with a tension of 40 N. Determine the state of stress in the frame at points A and B.

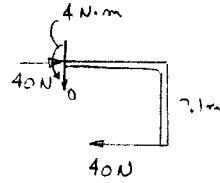
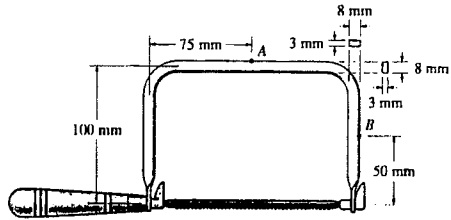

$$\sigma_A = -\frac{P}{A} + \frac{Mc}{I} = -\frac{40}{(0.008)(0.003)} + \frac{4(0.004)}{\frac{1}{12}(0.003)(0.008)^3} = 123 \text{ MPa} \quad \text{Ans.}$$

$$\sigma_B = \frac{Mc}{I} = \frac{2(0.004)}{\frac{1}{12}(0.003)(0.008)^3} = 62.5 \text{ MPa} \quad \text{Ans}$$

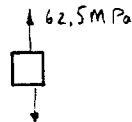
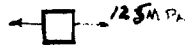
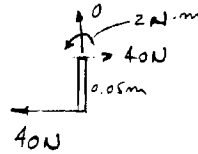

From *Mechanics of Materials*, Sixth Edition by R. C. Hibbeler, ISBN 0-13-191345-X.

© 2005 R. C. Hibbeler. Published by Pearson Prentice Hall,

Pearson Education, Inc., Upper Saddle River, NJ. All rights reserved.

This material is protected under all copyright laws as they currently exist. No portion of this material may be reproduced, in any form or by any means, without permission in writing from the publisher.

***8-20.** The offset link supports the loading of $P = 30$ kN. Determine its required width w if the allowable normal stress is $\sigma_{\text{allow}} = 73$ MPa. The link has a thickness of 40 mm.

σ due to axial force:

$$\sigma_a = \frac{P}{A} = \frac{30 (10^3)}{(w)(0.04)} = \frac{750 (10^3)}{w}$$

σ due to bending:

$$\sigma_b = \frac{M c}{I} = \frac{30 (10^3)(0.05 + \frac{w}{2})(\frac{w}{2})}{\frac{1}{12}(0.04)(w)^3}$$

$$= \frac{4500 (10^3)(0.05 + \frac{w}{2})}{w^2}$$

$$\sigma_{\text{max}} = \sigma_{\text{allow}} = \sigma_a + \sigma_b$$

$$73 (10^6) = \frac{750 (10^3)}{w} + \frac{4500 (10^3)(0.05 + \frac{w}{2})}{w^2}$$

$$73 w^2 = 0.75 w + 0.225 + 2.25 w$$

$$73 w^2 - 3 w - 0.225 = 0$$

$$w = 0.0797 \text{ m} = 79.7 \text{ mm} \quad \text{Ans}$$

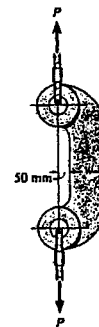
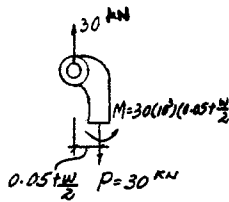

From *Mechanics of Materials*, Sixth Edition by R. C. Hibbeler, ISBN 0-13-191345-X.

© 2005 R. C. Hibbeler. Published by Pearson Prentice Hall,

Pearson Education, Inc., Upper Saddle River, NJ. All rights reserved.

This material is protected under all copyright laws as they currently exist. No portion of this material may be reproduced, in any form or by any means, without permission in writing from the publisher.

8-21 The offset link has a width of $w = 200$ mm and a thickness of 40 mm. If the allowable normal stress is $\sigma_{allow} = 75$ MPa, determine the maximum load P that can be applied to the cables.

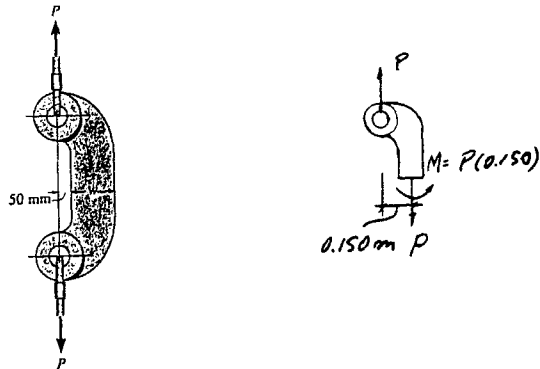

$$A = 0.2(0.04) = 0.008 \text{ m}^2$$

$$I = \frac{1}{12}(0.04)(0.2)^3 = 26.6667(10^{-6}) \text{ m}^4$$

$$\sigma = \frac{P}{A} + \frac{M c}{I}$$

$$75(10^6) = \frac{P}{0.008} + \frac{0.150 P(0.1)}{26.6667(10^{-6})}$$

$$P = 109 \text{ kN} \quad \text{Ans}$$

From *Mechanics of Materials*, Sixth Edition by R. C. Hibbeler, ISBN 0-13-191345-X.

© 2005 R. C. Hibbeler. Published by Pearson Prentice Hall,

Pearson Education, Inc., Upper Saddle River, NJ. All rights reserved.

This material is protected under all copyright laws as they currently exist. No portion of this material may be reproduced, in any form or by any means, without permission in writing from the publisher.

8-22 The joint is subjected to a force of $P = 80$ lb and $F = 0$. Sketch the normal-stress distribution acting over section $a-a$ if the member has a rectangular cross-sectional area of width 2 in. and thickness 0.5 in.

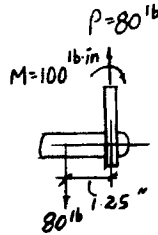
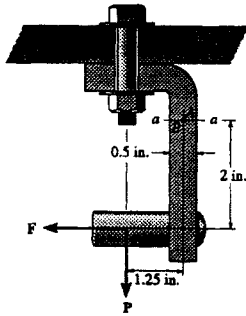

σ due to axial force :

$$\sigma = \frac{P}{A} = \frac{80}{(0.5)(2)} = 80 \text{ psi}$$

σ due to bending :

$$\sigma = \frac{M c}{I} = \frac{100 (0.25)}{\frac{1}{12} (2)(0.5)^3} = 1200 \text{ psi}$$

$$(\sigma_{\max})_t = 80 + 1200 = 1280 \text{ psi} = 1.28 \text{ ksi} \quad \text{Ans}$$

$$(\sigma_{\max})_c = 1200 - 80 = 1120 \text{ psi} = 1.12 \text{ ksi} \quad \text{Ans}$$

$$\frac{y}{1.25} = \frac{(0.5 - y)}{1.12}$$

$$y = 0.264 \text{ in.}$$

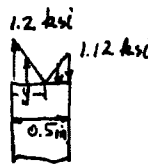

From *Mechanics of Materials*, Sixth Edition by R. C. Hibbeler, ISBN 0-13-191345-X.

© 2005 R. C. Hibbeler. Published by Pearson Prentice Hall,

Pearson Education, Inc., Upper Saddle River, NJ. All rights reserved.

This material is protected under all copyright laws as they currently exist. No portion of this material may be reproduced, in any form or by any means, without permission in writing from the publisher.

8-23 The joint is subjected to a force of $P = 200$ lb and $F = 150$ lb. Determine the state of stress at points A and B and sketch the results on differential elements located at these points. The member has a rectangular cross-sectional area of width 0.75 in. and thickness 0.5 in.

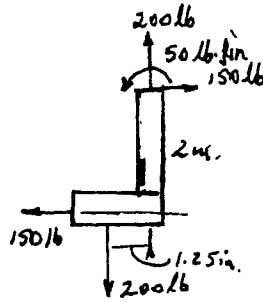
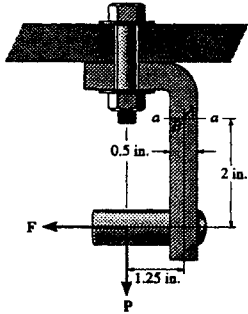

$$A = 0.5(0.75) = 0.375 \text{ in}^2$$

$$Q_A = \bar{y}'_A A' = 0.125(0.75)(0.25) = 0.0234375 \text{ in}^3; \quad Q_B = 0$$

$$I = \frac{1}{12}(0.75)(0.5^3) = 0.0078125 \text{ in}^4$$

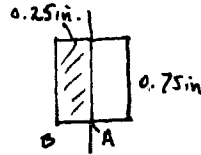

Normal Stress :

$$\sigma = \frac{N}{A} + \frac{My}{I}$$

$$\sigma_A = \frac{200}{0.375} + 0 = 533 \text{ psi (T)} \quad \text{Ans}$$

$$\sigma_B = \frac{200}{0.375} - \frac{50(0.25)}{0.0078125} = -1067 \text{ psi} = 1067 \text{ psi (C)}$$

Ans

Shear stress :

$$\tau = \frac{VQ}{It}$$

$$\tau_A = \frac{150(0.0234375)}{(0.0078125)(0.75)} = 600 \text{ psi} \quad \text{Ans}$$

$$\tau_B = 0 \quad \text{Ans}$$

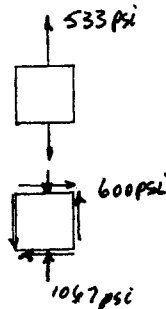

From *Mechanics of Materials*, Sixth Edition by R. C. Hibbeler, ISBN 0-13-191345-X.

© 2005 R. C. Hibbeler. Published by Pearson Prentice Hall,

Pearson Education, Inc., Upper Saddle River, NJ. All rights reserved.

This material is protected under all copyright laws as they currently exist. No portion of this material may be reproduced, in any form or by any means, without permission in writing from the publisher.

*8-24 The gondola and passengers have a weight of 1500 lb and center of gravity at G . The suspender arm AE has a square cross-sectional area of 1.5 in. by 1.5 in., and is pin connected at its ends A and E . Determine the largest tensile stress developed in regions AB and DC of the arm.

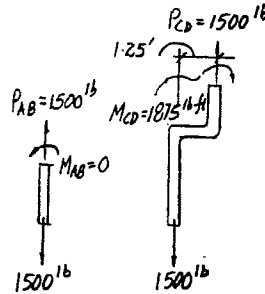
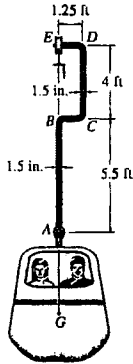

Segment AB :

$$(\sigma_{\max})_{AB} = \frac{P_{AB}}{A} = \frac{1500}{(1.5)(1.5)} = 667 \text{ psi} \quad \text{Ans}$$

Segment CD :

$$\sigma_a = \frac{P_{CD}}{A} = \frac{1500}{(1.5)(1.5)} = 666.67 \text{ psi}$$

$$\sigma_b = \frac{Mc}{I} = \frac{1875(12)(0.75)}{\frac{1}{12}(1.5)(1.5^3)} = 40\,000 \text{ psi}$$

$$(\sigma_{\max})_{CD} = \sigma_a + \sigma_b = 666.67 + 40\,000 = 40\,666.67 \text{ psi} = 40.7 \text{ ksi} \quad \text{Ans}$$

From *Mechanics of Materials*, Sixth Edition by R. C. Hibbeler, ISBN 0-13-191345-X.

© 2005 R. C. Hibbeler. Published by Pearson Prentice Hall,

Pearson Education, Inc., Upper Saddle River, NJ. All rights reserved.

This material is protected under all copyright laws as they currently exist. No portion of this material may be reproduced, in any form or by any means, without permission in writing from the publisher.

8-25 The vertical force P acts on the bottom of the plate having a negligible weight. Determine the shortest distance d to the edge of the plate at which it can be applied so that it produces no compressive stresses on the plate at section $a-a$. The plate has a thickness of 10 mm and P acts along the center line of this thickness.

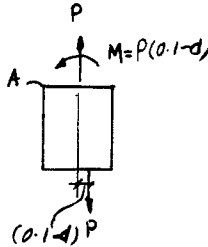
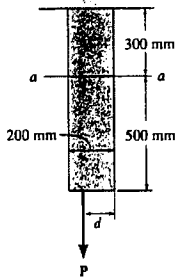

$$\sigma_A = 0 = \sigma_a - \sigma_b$$

$$0 = \frac{P}{A} - \frac{M c}{I}$$

$$0 = \frac{P}{(0.2)(0.01)} - \frac{P(0.1 - d)(0.1)}{\frac{1}{12}(0.01)(0.2^3)}$$

$$P(-1000 + 15000 d) = 0$$

$$d = 0.0667\text{m} = 66.7 \text{ mm} \quad \text{Ans}$$

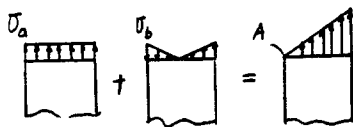

From *Mechanics of Materials*, Sixth Edition by R. C. Hibbeler, ISBN 0-13-191345-X.

© 2005 R. C. Hibbeler. Published by Pearson Prentice Hall,

Pearson Education, Inc., Upper Saddle River, NJ. All rights reserved.

This material is protected under all copyright laws as they currently exist. No portion of this material may be reproduced, in any form or by any means, without permission in writing from the publisher.

8-26. The bar has a diameter of 40 mm. If it is subjected to a force of 800 N as shown, determine the stress components that act at point A and show the results on a volume element located at this point.

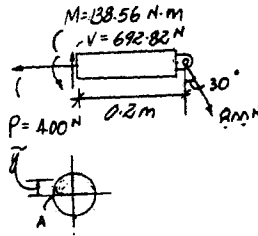
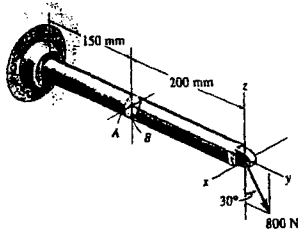

$$I = \frac{1}{4} \pi r^4 = \frac{1}{4} (\pi)(0.02^4) = 0.1256637 (10^{-6}) \text{ m}^4$$

$$A = \pi r^2 = \pi (0.02^2) = 1.256637 (10^{-3}) \text{ m}^2$$

$$Q_A = \bar{y}' A' = \left(\frac{4(0.02)}{3\pi} \right) \left(\frac{\pi(0.02)^2}{2} \right) = 5.3333 (10^{-6}) \text{ m}^3$$

$$\sigma_A = \frac{P}{A} + \frac{Mz}{I} = \frac{400}{1.256637 (10^{-3})} + 0 = 0.318 \text{ MPa} \quad \text{Ans}$$

$$\tau_A = \frac{VQ_A}{I t} = \frac{692.82 (5.3333) (10^{-6})}{0.1256637 (10^{-6})(0.04)} = 0.735 \text{ MPa} \quad \text{Ans}$$

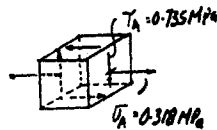

From *Mechanics of Materials*, Sixth Edition by R. C. Hibbeler, ISBN 0-13-191345-X.

© 2005 R. C. Hibbeler. Published by Pearson Prentice Hall,

Pearson Education, Inc., Upper Saddle River, NJ. All rights reserved.

This material is protected under all copyright laws as they currently exist. No portion of this material may be reproduced, in any form or by any means, without permission in writing from the publisher.

8-27. Solve Prob. 8-26 for point B.

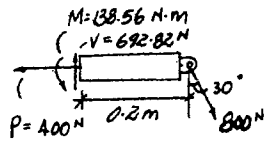
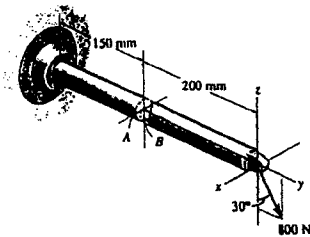

$$I = \frac{1}{4} \pi r^4 = \frac{1}{4} (\pi)(0.02^4) = 0.1256637 (10^{-6}) \text{ m}^4$$

$$A = \pi r^2 = \pi (0.02^2) = 1.256637 (10^{-3}) \text{ m}^2$$

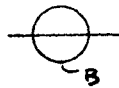

$$Q_B = 0$$

$$\sigma_B = \frac{P}{A} - \frac{M c}{I} = \frac{400}{1.256637 (10^{-3})} - \frac{138.56 (0.02)}{0.1256637 (10^{-6})} = -21.7 \text{ MPa} \quad \text{Ans}$$

$$\tau_B = 0 \quad \text{Ans}$$

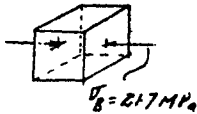

From *Mechanics of Materials*, Sixth Edition by R. C. Hibbeler, ISBN 0-13-191345-X.

© 2005 R. C. Hibbeler. Published by Pearson Prentice Hall,

Pearson Education, Inc., Upper Saddle River, NJ. All rights reserved.

This material is protected under all copyright laws as they currently exist. No portion of this material may be reproduced, in any form or by any means, without permission in writing from the publisher.

*8-28 The cylindrical post, having a diameter of 40 mm, is being pulled from the ground using a sling of negligible thickness. If the rope is subjected to a vertical force of $P = 500 \text{ N}$, determine the stress at points A and B . Show the results on a volume element located at each of these points.

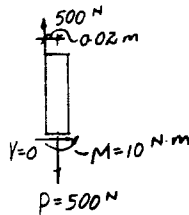
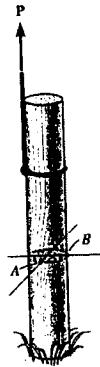

$$I = \frac{1}{4} \pi r^4 = \frac{1}{4} (\pi)(0.02^4) = 0.1256637 (10^{-6}) \text{ m}^4$$

$$A = \pi r^2 = \pi (0.02^2) = 1.256637 (10^{-3}) \text{ m}^2$$

$$\sigma_A = \frac{P}{A} + \frac{Mx}{I}$$

$$= \frac{500}{1.256637 (10^{-3})} + 0 = 0.398 \text{ MPa} \quad \text{Ans}$$

$$\sigma_B = \frac{P}{A} - \frac{Mc}{I}$$

$$= \frac{500}{1.256637 (10^{-3})} - \frac{10 (0.02)}{0.1256637 (10^{-6})}$$

$$= -1.19 \text{ MPa} \quad \text{Ans}$$

$$\sigma_A = 0.398 \text{ MPa}$$

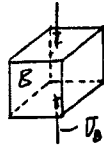
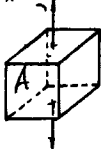

From *Mechanics of Materials*, Sixth Edition by R. C. Hibbeler, ISBN 0-13-191345-X.

© 2005 R. C. Hibbeler. Published by Pearson Prentice Hall,

Pearson Education, Inc., Upper Saddle River, NJ. All rights reserved.

This material is protected under all copyright laws as they currently exist. No portion of this material may be reproduced, in any form or by any means, without permission in writing from the publisher.

8-29 Determine the maximum load P that can be applied to the sling having a negligible thickness so that the normal stress in the post does not exceed $\sigma_{\text{allow}} = 30 \text{ MPa}$. The post has a diameter of 50 mm.

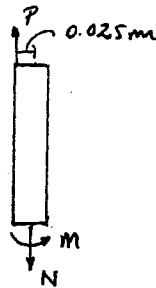
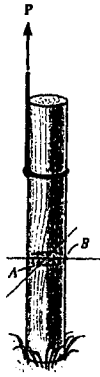

$$+\downarrow \Sigma F = 0; \quad N - P = 0; \quad N = P$$

$$\curvearrowright \Sigma M = 0; \quad M - P(0.025) = 0; \quad M = 0.025P$$

$$A = \frac{\pi}{4} d^2 = \pi (0.025^2) = 0.625 (10^{-3}) \pi \text{ m}^2$$

$$I = \frac{\pi}{4} r^4 = \frac{\pi}{4} (0.025^4) = 97.65625 (10^{-9}) \pi \text{ m}^4$$

$$\sigma = \frac{N}{A} + \frac{M y}{I}$$

$$\sigma = 30(10^6) = \frac{P}{0.625 (10^{-3}) \pi} + \frac{P(0.025)(0.025)}{97.65625 (10^{-9}) \pi}$$

$$P = 11.8 \text{ kN} \quad \text{Ans}$$

From *Mechanics of Materials*, Sixth Edition by R. C. Hibbeler, ISBN 0-13-191345-X.

© 2005 R. C. Hibbeler. Published by Pearson Prentice Hall,

Pearson Education, Inc., Upper Saddle River, NJ. All rights reserved.

This material is protected under all copyright laws as they currently exist. No portion of this material may be reproduced, in any form or by any means, without permission in writing from the publisher.

8-30 The $\frac{1}{4}$ -in.-diameter bolt hook is subjected to the load of $F = 150$ lb. Determine the stress components at point A on the shank. Show the results on a volume element located at this point.

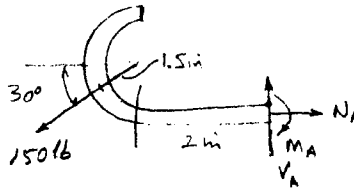
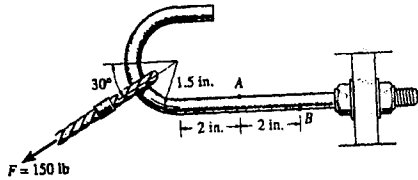

$$\rightarrow \Sigma F_x = 0; \quad N_A - 150 \cos 30^\circ = 0$$

$$N_A = 129.9038 \text{ lb}$$

$$+\uparrow \Sigma F_y = 0; \quad V_A - 150 \sin 30^\circ = 0$$

$$V_A = 75 \text{ lb}$$

$$\curvearrowleft \Sigma M_A = 0; \quad 150 \cos 30^\circ(1.5) + 150 \sin 30^\circ(2) - M_A = 0$$

$$M_A = 344.8557 \text{ lb} \cdot \text{in.}$$

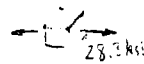

$$\sigma_A = \frac{P}{A} + \frac{Mc}{I} = \frac{129.9038}{\pi(\frac{1}{4})^2} + \frac{344.8557(\frac{1}{4})}{\frac{\pi}{4}(\frac{1}{4})^4} = 28.8 \text{ ksi} \quad \text{Ans}$$

$$\tau_A = 0 \quad (\text{since } Q_A = 0) \quad \text{Ans}$$

From *Mechanics of Materials*, Sixth Edition by R. C. Hibbeler, ISBN 0-13-191345-X.

© 2005 R. C. Hibbeler. Published by Pearson Prentice Hall,

Pearson Education, Inc., Upper Saddle River, NJ. All rights reserved.

This material is protected under all copyright laws as they currently exist. No portion of this material may be reproduced, in any form or by any means, without permission in writing from the publisher.

8-31 The $\frac{1}{4}$ -in.-diameter bolt hook is subjected to the load of $F = 150$ lb. Determine the stress components at point B on the shank. Show the results on a volume element located at this point.

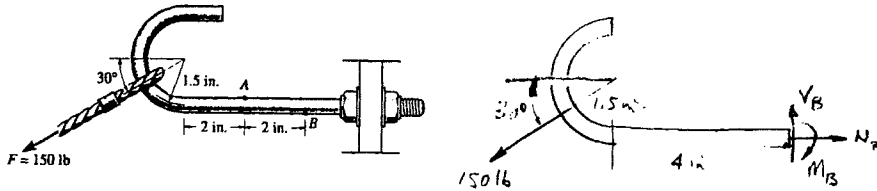

$$\rightarrow \Sigma F_x = 0; \quad N_B - 150 \cos 30^\circ = 0; \quad N_B = 129.9038$$

$$+ \uparrow \Sigma F_y = 0; \quad V_B - 150 \sin 30^\circ = 0; \quad V_B = 75 \text{ lb}$$

$$\curvearrowright \Sigma M_B = 0; \quad 150 \cos 30^\circ(1.5) + 150 \sin 30^\circ(4) - M_B = 0$$

$$M_B = 494.8557 \text{ lb} \cdot \text{in.}$$

$$\sigma_B = \frac{P}{A} - \frac{Mc}{I} = \frac{129.9038}{\pi(\frac{1}{4})^2} - \frac{494.8557(\frac{1}{4})}{\frac{\pi}{4}(\frac{1}{4})^4} = -39.7 \text{ ksi} \quad \text{Ans}$$

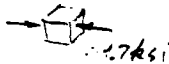

From *Mechanics of Materials*, Sixth Edition by R. C. Hibbeler, ISBN 0-13-191345-X.
 © 2005 R. C. Hibbeler. Published by Pearson Prentice Hall,
 Pearson Education, Inc., Upper Saddle River, NJ. All rights reserved.
 This material is protected under all copyright laws as they currently exist. No portion of this material may be reproduced, in any form or by any means, without permission in writing from the publisher.

***8-32.** The pin support is made from a steel rod and has a diameter of 20 mm. Determine the stress components at points *A* and *B* and represent the results on a volume element located at each of these points.

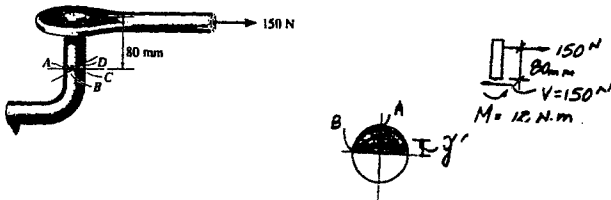

$$I = \frac{1}{4} (\pi)(0.01^4) = 7.85398 (10^{-9}) \text{ m}^4$$

$$Q_B = \bar{y}A' = \frac{4(0.01)}{3\pi} \left(\frac{1}{2}\right)(\pi)(0.01^2) = 0.66667 (10^{-6}) \text{ m}^3$$

$$Q_A = 0$$

$$\sigma_A = \frac{M c}{I} = \frac{12(0.01)}{7.85398 (10^{-9})} = 15.3 \text{ MPa} \quad \text{Ans}$$

$$\tau_A = 0 \quad \text{Ans}$$

$$\sigma_B = 0 \quad \text{Ans}$$

$$\tau_B = \frac{V Q_B}{I t} = \frac{150 (0.66667)(10^{-6})}{7.85398 (10^{-9})(0.02)} = 0.637 \text{ MPa} \quad \text{Ans}$$

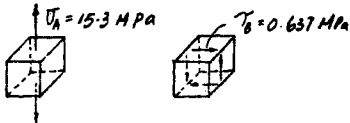

From *Mechanics of Materials*, Sixth Edition by R. C. Hibbeler, ISBN 0-13-191345-X.

© 2005 R. C. Hibbeler. Published by Pearson Prentice Hall,

Pearson Education, Inc., Upper Saddle River, NJ. All rights reserved.

This material is protected under all copyright laws as they currently exist. No portion of this material may be reproduced, in any form or by any means, without permission in writing from the publisher.

8-33 Solve Prob. 8-32 for points C and D.

$$I = \frac{1}{4} (\pi)(0.01^4) = 7.85398 (10^{-9}) \text{ m}^4$$

$$Q_D = \bar{y}'A' = \frac{4(0.01)}{3\pi} \left(\frac{1}{2}\right)(\pi)(0.01^2) = 0.66667 (10^{-6}) \text{ m}^3$$

$$Q_C = 0$$

$$\sigma_C = \frac{Mc}{I} = \frac{12(0.01)}{7.85398(10^{-9})} = 15.3 \text{ MPa} \quad \text{Ans}$$

$$\tau_C = 0 \quad \text{Ans}$$

$$\sigma_D = 0 \quad \text{Ans}$$

$$\tau_D = \frac{VQ_D}{It} = \frac{150(0.66667)(10^{-6})}{7.8539(10^{-9})(0.02)} = 0.637 \text{ MPa} \quad \text{Ans}$$

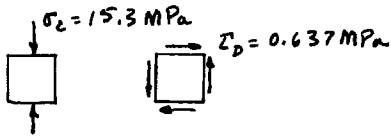
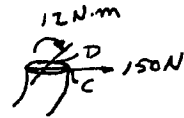
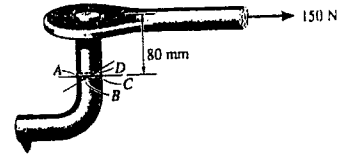

From *Mechanics of Materials*, Sixth Edition by R. C. Hibbeler, ISBN 0-13-191345-X.
 © 2005 R. C. Hibbeler. Published by Pearson Prentice Hall,
 Pearson Education, Inc., Upper Saddle River, NJ. All rights reserved.
 This material is protected under all copyright laws as they currently exist. No portion of this material may be
 reproduced, in any form or by any means, without permission in writing from the publisher.

8-34 The wide-flange beam is subjected to the loading shown. Determine the stress components at points *A* and *B* and show the results on a volume element at each of these points. Use the shear formula to compute the shear stress.

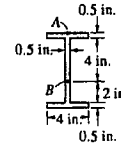
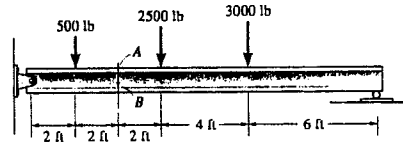

$$I = \frac{1}{12}(4)(7^3) - \frac{1}{12}(3.5)(6^3) = 51.33 \text{ in}^4$$

$$A = 2(0.5)(4) + 6(0.5) = 7 \text{ in}^2$$

$$Q_B = \Sigma \bar{y}'A' = 3.25(4)(0.5) + 2(2)(0.5) = 8.5 \text{ in}^3$$

$$Q_A = 0$$

$$\sigma_A = \frac{-M c}{I} = \frac{-11500(12)(3.5)}{51.33} = -9.41 \text{ ksi} \quad \text{Ans}$$

$$\tau_A = 0 \quad \text{Ans}$$

$$\sigma_B = \frac{M y}{I} = \frac{11500(12)(1)}{51.33} = 2.69 \text{ ksi} \quad \text{Ans}$$

$$\tau_B = \frac{V Q_B}{I t} = \frac{2625(8.5)}{51.33(0.5)} = 0.869 \text{ ksi} \quad \text{Ans}$$

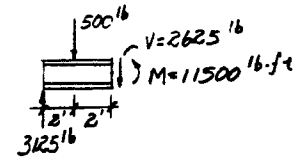
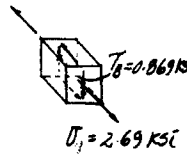
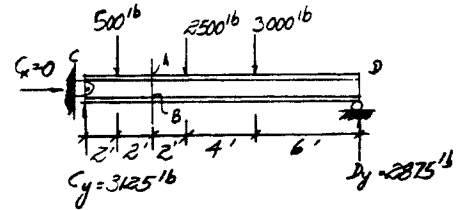
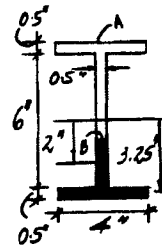

From *Mechanics of Materials*, Sixth Edition by R. C. Hibbeler, ISBN 0-13-191345-X.

© 2005 R. C. Hibbeler. Published by Pearson Prentice Hall,

Pearson Education, Inc., Upper Saddle River, NJ. All rights reserved.

This material is protected under all copyright laws as they currently exist. No portion of this material may be reproduced, in any form or by any means, without permission in writing from the publisher.

8-35 The cantilevered beam is used to support the load of 8 kN. Determine the state of stress at points A and B, and sketch the results on differential elements located at each of these points.

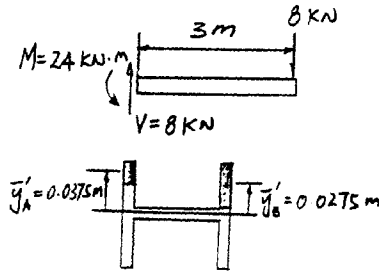
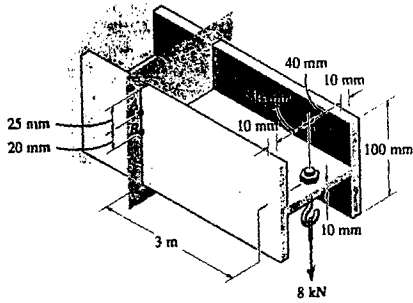

$$I = 2\left[\frac{1}{12}(0.01)(0.1^3)\right] + \frac{1}{12}(0.08)(0.01^3) = 1.6733(10^{-6}) \text{ m}^4$$

$$A = 2[0.01(0.1)] + 0.08(0.01) = 0.0028 \text{ m}^2$$

$$Q_A = \bar{y}'_A A = 0.0375(0.025)(0.01) = 9.375(10^{-6}) \text{ m}^3$$

$$Q_B = \bar{y}'_B A = 0.0275(0.045)(0.01) = 12.375(10^{-6}) \text{ m}^3$$

$$\sigma = \frac{M y}{I}$$

$$\sigma_A = \frac{24(10^3)(0.025)}{1.6733(10^{-6})} = 359 \text{ MPa (T)}$$

Ans

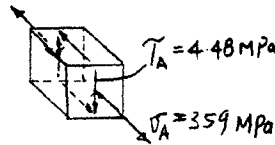

$$\sigma_B = \frac{24(10^3)(0.005)}{1.6733(10^{-6})} = 71.7 \text{ MPa (T)}$$

Ans

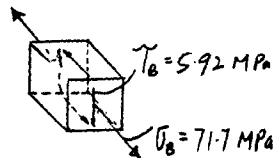

$$\tau = \frac{VQ}{It}$$

$$\tau_A = \frac{8(10^3)(9.375)(10^{-6})}{1.6733(10^{-6})(0.01)} = 4.48 \text{ MPa}$$

Ans

$$\tau_B = \frac{8(10^3)(12.375)(10^{-6})}{1.6733(10^{-6})(0.01)} = 5.92 \text{ MPa}$$

Ans

From *Mechanics of Materials*, Sixth Edition by R. C. Hibbeler, ISBN 0-13-191345-X.

© 2005 R. C. Hibbeler. Published by Pearson Prentice Hall,

Pearson Education, Inc., Upper Saddle River, NJ. All rights reserved.

This material is protected under all copyright laws as they currently exist. No portion of this material may be reproduced, in any form or by any means, without permission in writing from the publisher.

*8-36 The frame supports a centrally applied distributed load of 1.8 kip/ft. Determine the state of stress at points A and B on member CD and indicate the results on a volume element located at each of these points. The pins at C and D are at the same location as the neutral axis for the cross section.

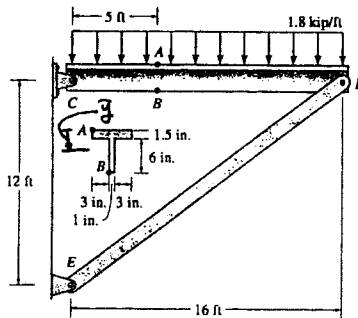

Member CD :

$$\begin{aligned} +\circlearrowleft \Sigma M_C = 0; & \quad \frac{3}{5}F_{DE}(16) - 28.8(8) = 0; \\ & \quad F_{DE} = 24.0 \text{ kip} \end{aligned}$$

Segment :

$$\leftarrow \Sigma F_x = 0; \quad N - \frac{4}{5}(24.0) = 0; \quad N = 19.2 \text{ kip}$$

$$+\uparrow \Sigma F_y = 0; \quad V + \frac{3}{5}(24.0) - 19.8 = 0; \quad V = 5.40 \text{ kip}$$

$$\begin{aligned} (+\circlearrowleft \Sigma M_O = 0; & \quad -M - 19.8(5.5) + \frac{3}{5}(24.0)(11) = 0; \\ & \quad M = 49.5 \text{ kip} \cdot \text{ft} \end{aligned}$$

$$A = 7(1.5) + 6(1) = 16.5 \text{ in}^2$$

$$\bar{y} = \frac{\Sigma \bar{y}A}{\Sigma A} = \frac{0.75(1.5)(7) + 4.5(6)(1)}{16.5} = 2.1136 \text{ in.}$$

$$\begin{aligned} I &= \frac{1}{12}(7)(1.5^3) + 7(1.5)(2.1136 - 0.75)^2 \\ &\quad + \frac{1}{12}(1)(6^3) + 1(6)(4.5 - 2.1136)^2 \\ &= 73.662 \text{ in}^4 \end{aligned}$$

$$Q_A = Q_B = 0$$

Normal Stress :

$$\sigma = \frac{N}{A} + \frac{My}{I}$$

$$\sigma_A = \frac{19.2}{16.5} - \frac{49.5(12)(7.5 - 2.1136)}{73.662} = -15.9 \text{ ksi} = 15.9 \text{ ksi(C)} \quad \text{Ans}$$

$$\sigma_B = \frac{19.2}{16.5} + \frac{49.5(12)(5.3864)}{73.662} = 44.6 \text{ ksi(T)} \quad \text{Ans}$$

Shear Stress : Since $Q_A = Q_B = 0$,

$$\tau_A = \tau_B = 0 \quad \text{Ans}$$

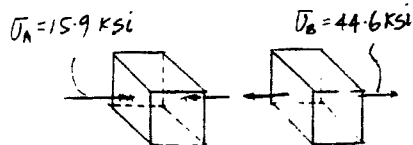
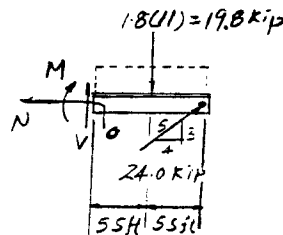
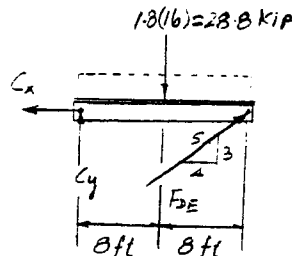

From *Mechanics of Materials*, Sixth Edition by R. C. Hibbeler, ISBN 0-13-191345-X.

© 2005 R. C. Hibbeler. Published by Pearson Prentice Hall,

Pearson Education, Inc., Upper Saddle River, NJ. All rights reserved.

This material is protected under all copyright laws as they currently exist. No portion of this material may be reproduced, in any form or by any means, without permission in writing from the publisher.

8-37 The coiled spring is subjected to a force P . If we assume the shear stress caused by the shear force at any vertical section of the coil wire to be uniform, show that the maximum shear stress in the coil is $\tau_{\max} = P/A + PRr/J$, where J is the polar moment of inertia of the coil wire and A is its cross-sectional area.

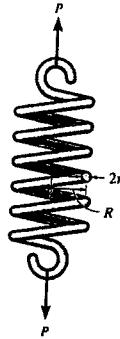

$$\tau_{\max} = \frac{V}{A} + \frac{Tc}{J} = \frac{P}{A} + \frac{PRr}{J}$$

QED

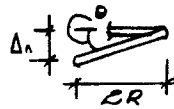

$$\Delta n = 2R\theta$$

$$\tau_{\max} = \frac{VQ_{\max}}{It} + \frac{Tc}{J}$$

$$\frac{VQ}{It} = \frac{4}{3} \frac{V}{A}$$

$$\frac{Tc}{J} = \text{max on perimeter} = \frac{PRr}{J}$$

From *Mechanics of Materials*, Sixth Edition by R. C. Hibbeler, ISBN 0-13-191345-X.

© 2005 R. C. Hibbeler. Published by Pearson Prentice Hall,

Pearson Education, Inc., Upper Saddle River, NJ. All rights reserved.

This material is protected under all copyright laws as they currently exist. No portion of this material may be reproduced, in any form or by any means, without permission in writing from the publisher.

8-38 The metal link is subjected to the axial force of $P = 7 \text{ kN}$. Its original cross section is to be altered by cutting a circular groove into one side. Determine the distance a the groove can penetrate into the cross section so that the tensile stress does not exceed $\sigma_{\text{allow}} = 175 \text{ MPa}$. Offer a better way to remove this depth of material from the cross section and calculate the tensile stress for this case. Neglect the effects of stress concentration.

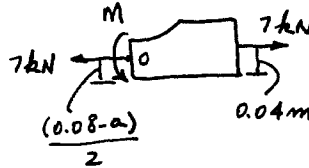
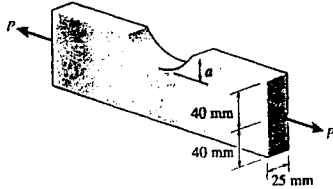

$$\sum M_O = 0; \quad M - 7(10^3)(0.04 - \frac{0.08 - a}{2}) = 0$$

$$M = 3.5(10^3)a$$

$$\sigma_{\text{max}} = \frac{P}{A} + \frac{Mc}{I}$$

$$175(10^6) = \frac{7(10^3)}{(0.025)(0.08 - a)} + \frac{3.5(10^3)a(0.08 - a)/2}{\frac{1}{12}(0.025)(0.08 - a)^3}$$

$$\text{Set } x = 0.08 - a$$

$$4375 = \frac{7}{x} + \frac{21(0.08 - x)}{x^2}$$

$$4375x^2 + 14x - 1.68 = 0$$

Choose positive root :

$$x = 0.01806$$

$$a = 0.08 - 0.01806 = 0.0619 \text{ m}$$

$$a = 61.9 \text{ mm} \quad \text{Ans}$$

Remove material equally from both sides.

$$\sigma = \frac{7(10^3)}{(0.025)(0.01806)} = 15.5 \text{ MPa} \quad \text{Ans}$$



From *Mechanics of Materials*, Sixth Edition by R. C. Hibbeler, ISBN 0-13-191345-X.

© 2005 R. C. Hibbeler. Published by Pearson Prentice Hall,

Pearson Education, Inc., Upper Saddle River, NJ. All rights reserved.

This material is protected under all copyright laws as they currently exist. No portion of this material may be reproduced, in any form or by any means, without permission in writing from the publisher.

8-39 The control lever is subjected to a horizontal force of 20 lb on the handle. Determine the state of stress at points A and B. Sketch the results on differential elements located at each of these points. The assembly is pin-connected at C and attached to a cable at D.

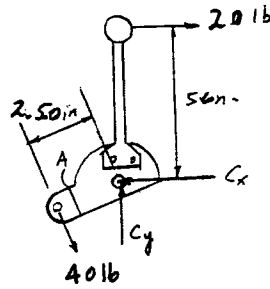
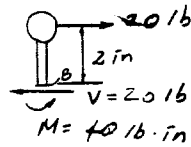
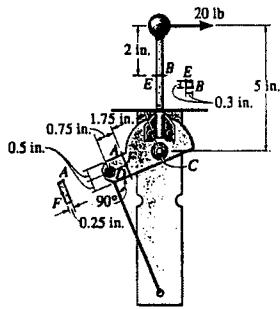

For point B :

$$I = \frac{1}{12}(0.3)(0.3^3) = 0.675(10^{-3}) \text{ in}^4$$

$$\sigma_B = \frac{Mc}{I} = \frac{40(0.15)}{0.675(10^{-3})} = 8.89 \text{ ksi (C)}$$

Ans

$\tau_B = 0$ (since $Q_B = 0$)

Ans

For point A :

$$I = \frac{1}{12}(0.25)(1^3) = 0.020833 \text{ in}^4$$

$$\sigma_A = \frac{Mc}{I} = \frac{30(0.5)}{0.020833} = 720 \text{ psi (T)}$$

Ans

$\tau_A = 0$ (since $Q_A = 0$)

Ans

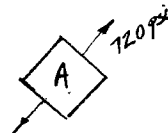
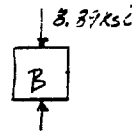
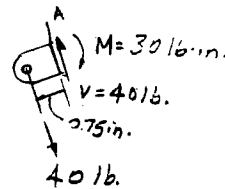

From *Mechanics of Materials*, Sixth Edition by R. C. Hibbeler, ISBN 0-13-191345-X.

© 2005 R. C. Hibbeler. Published by Pearson Prentice Hall,

Pearson Education, Inc., Upper Saddle River, NJ. All rights reserved.

This material is protected under all copyright laws as they currently exist. No portion of this material may be reproduced, in any form or by any means, without permission in writing from the publisher.

*8-40 The control lever is subjected to a horizontal force of 20 lb on the handle. Determine the state of stress at points *E* and *F*. Sketch the results on differential elements located at each of these points. The assembly is pin-connected at *C* and attached to a cable at *D*.

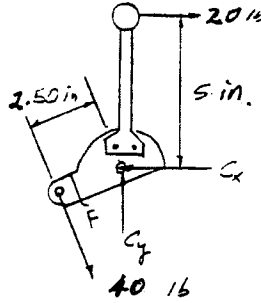
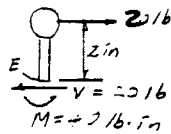
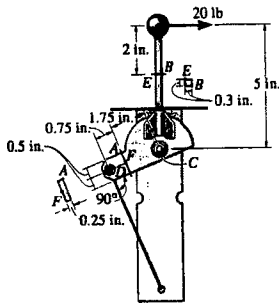

For point *E* :

$$I = \frac{1}{12}(0.3)(0.3^3) = 0.675(10^{-3}) \text{ in}^4$$

$$\sigma_E = \frac{Mc}{I} = \frac{40(0.15)}{0.675(10^{-3})} = 8.89 \text{ ksi (T)}$$

Ans

$$\tau_E = 0 \quad (\text{since } Q_E = 0)$$

Ans

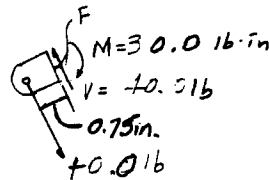

For point *F* :

$$I = \frac{1}{12}(0.25)(1^3) = 0.020833 \text{ in}^4$$

$$\sigma_F = 0 \quad \text{Ans}$$

$$\tau_F = \frac{VQ}{It} = \frac{40(0.25)(0.5)(0.25)}{\frac{1}{12}(0.25)(1)^3(0.25)} = 240 \text{ psi}$$

Ans

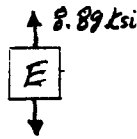

From *Mechanics of Materials*, Sixth Edition by R. C. Hibbeler, ISBN 0-13-191345-X.

© 2005 R. C. Hibbeler. Published by Pearson Prentice Hall,

Pearson Education, Inc., Upper Saddle River, NJ. All rights reserved.

This material is protected under all copyright laws as they currently exist. No portion of this material may be reproduced, in any form or by any means, without permission in writing from the publisher.

8-41 The bearing pin supports the load of 700 lb. Determine the stress components in the support member at point A. The support is 0.5 in. thick.

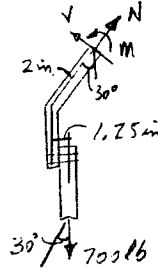
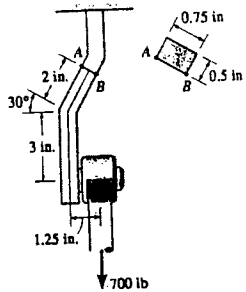

$$\Sigma F_x = 0; \quad N - 700 \cos 30^\circ = 0; \quad N = 606.218 \text{ lb}$$

$$\Sigma F_y = 0; \quad V - 700 \sin 30^\circ = 0; \quad V = 350 \text{ lb}$$

$$(+ \Sigma M = 0; \quad M - 700(1.25 - 2 \sin 30^\circ) = 0; \quad M = 175 \text{ lb} \cdot \text{in.}$$

$$\sigma_A = \frac{N}{A} - \frac{Mc}{I} = \frac{606.218}{(0.75)(0.5)} - \frac{(175)(0.375)}{\frac{1}{12}(0.5)(0.75)^3}$$

$$\sigma_A = -2.12 \text{ ksi} \quad \text{Ans}$$

$$\tau_A = 0 \quad (\text{since } Q_A = 0) \quad \text{Ans}$$

From *Mechanics of Materials*, Sixth Edition by R. C. Hibbeler, ISBN 0-13-191345-X.

© 2005 R. C. Hibbeler. Published by Pearson Prentice Hall,

Pearson Education, Inc., Upper Saddle River, NJ. All rights reserved.

This material is protected under all copyright laws as they currently exist. No portion of this material may be reproduced, in any form or by any means, without permission in writing from the publisher.

8-42 The bearing pin supports the load of 700 lb. Determine the stress components in the support member at point *B*. The support is 0.5 in. thick.

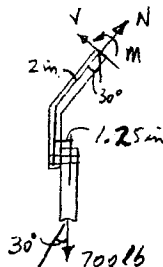
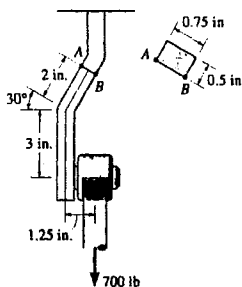

$$\Sigma F_x = 0; \quad N - 700 \cos 30^\circ = 0; \quad N = 606.218 \text{ lb}$$

$$\Sigma F_y = 0; \quad V - 700 \sin 30^\circ = 0; \quad V = 350 \text{ lb}$$

$$\Sigma M = 0; \quad M - 700(1.25 - 2 \sin 30^\circ) = 0; \quad M = 175 \text{ lb} \cdot \text{in.}$$

$$\sigma_B = \frac{N}{A} + \frac{Mc}{I} = \frac{606.218}{(0.75)(0.5)} + \frac{175(0.375)}{\frac{1}{12}(0.5)(0.75)^3}$$

$$\sigma_B = 5.35 \text{ ksi} \quad \text{Ans}$$

$$\tau_B = 0 \quad (\text{since } Q_B = 0) \quad \text{Ans}$$

From *Mechanics of Materials*, Sixth Edition by R. C. Hibbeler, ISBN 0-13-191345-X.

© 2005 R. C. Hibbeler. Published by Pearson Prentice Hall,

Pearson Education, Inc., Upper Saddle River, NJ. All rights reserved.

This material is protected under all copyright laws as they currently exist. No portion of this material may be reproduced, in any form or by any means, without permission in writing from the publisher.

8-43. The frame supports the distributed load shown. Determine the state of stress acting at point *D*. Show the results on a differential element located at this point.

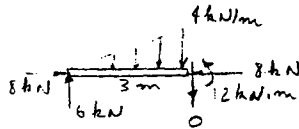
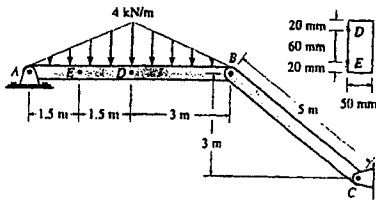

$$\sigma_D = \frac{P}{A} - \frac{My}{I} = \frac{8(10^3)}{(0.1)(0.05)} - \frac{12(10^3)(0.03)}{\frac{1}{12}(0.05)(0.1)^3}$$

$$\sigma_D = -88.0 \text{ MPa} \quad \text{Ans}$$

$$\tau_D = 0 \quad \text{Ans}$$

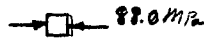

From *Mechanics of Materials*, Sixth Edition by R. C. Hibbeler, ISBN 0-13-191345-X.
 © 2005 R. C. Hibbeler. Published by Pearson Prentice Hall,
 Pearson Education, Inc., Upper Saddle River, NJ. All rights reserved.
 This material is protected under all copyright laws as they currently exist. No portion of this material may be reproduced, in any form or by any means, without permission in writing from the publisher.

***8-44.** The frame supports the distributed load shown. Determine the state of stress acting at point *E*. Show the results on a differential element located at this point.

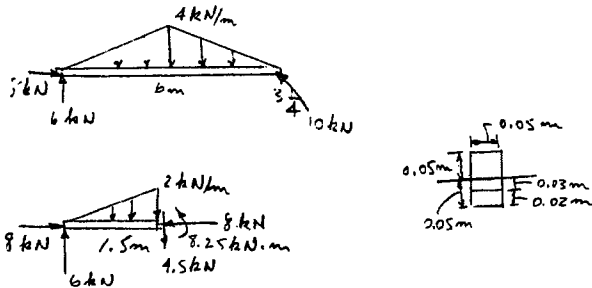
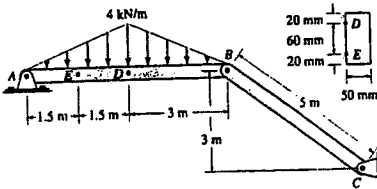

$$\sigma_E = \frac{P}{A} - \frac{My}{I} = \frac{8(10^3)}{(0.1)(0.05)} + \frac{8.25(10^3)(0.03)}{\frac{1}{12}(0.05)(0.1)^3} = 57.8 \text{ MPa} \quad \text{Ans}$$

$$\tau_E = \frac{VQ}{It} = \frac{4.5(10^3)(0.04)(0.02)(0.05)}{\frac{1}{12}(0.05)(0.1)^3(0.05)} = 864 \text{ kPa} \quad \text{Ans}$$

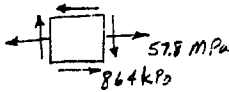

From *Mechanics of Materials*, Sixth Edition by R. C. Hibbeler, ISBN 0-13-191345-X.

© 2005 R. C. Hibbeler. Published by Pearson Prentice Hall,

Pearson Education, Inc., Upper Saddle River, NJ. All rights reserved.

This material is protected under all copyright laws as they currently exist. No portion of this material may be reproduced, in any form or by any means, without permission in writing from the publisher.

8-45 The pliers are made from two steel parts pinned together at *A*. If a smooth bolt is held in the jaws and a gripping force of 10 lb is applied at the handles, determine the state of stress developed in the pliers at points *B* and *C*. Here the cross section is rectangular, having the dimensions shown in the figure.

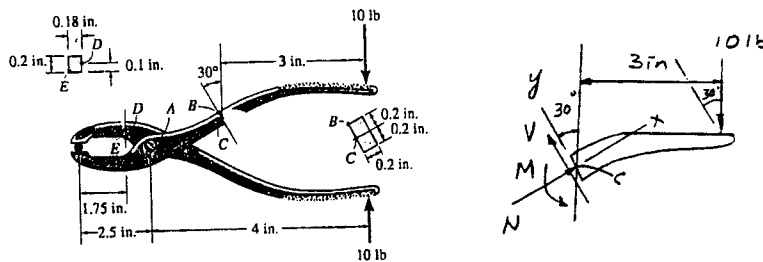

$$+\Sigma F_x = 0; \quad N - 10 \sin 30^\circ = 0; \quad N = 5.0 \text{ lb}$$

$$+\Sigma F_y = 0; \quad V - 10 \cos 30^\circ = 0; \quad V = 8.660 \text{ lb}$$

$$(+\Sigma M_C = 0; \quad M - 10(3) = 0; \quad M = 30 \text{ lb} \cdot \text{in.}$$

$$A = 0.2(0.4) = 0.08 \text{ in}^2$$

$$I = \frac{1}{12}(0.2)(0.4^3) = 1.0667(10^{-3}) \text{ in}^4$$

$$Q_B = 0$$

$$Q_C = \bar{y}'A' = 0.1(0.2)(0.2) = 4(10^{-3}) \text{ in}^3$$

Point *B* :

$$\sigma_B = \frac{N}{A} + \frac{My}{I} = \frac{-5.0}{0.08} + \frac{30(0.2)}{1.0667(10^{-3})} = 5.56 \text{ ksi(T)} \quad \text{Ans}$$

$$\tau_B = \frac{VQ}{It} = 0 \quad \text{Ans}$$

Point *C* :

$$\sigma_C = \frac{N}{A} + \frac{My}{I} = \frac{-5.0}{0.08} + 0 = -62.5 \text{ psi} = 62.5 \text{ psi(C)} \quad \text{Ans}$$

Shear Stress :

$$\tau_C = \frac{VQ}{It} = \frac{8.660(4)(10^{-3})}{1.0667(10^{-3})(0.2)} = 162 \text{ psi} \quad \text{Ans}$$

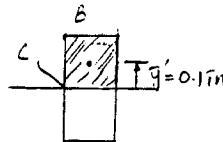

From *Mechanics of Materials*, Sixth Edition by R. C. Hibbeler, ISBN 0-13-191345-X.

© 2005 R. C. Hibbeler. Published by Pearson Prentice Hall,

Pearson Education, Inc., Upper Saddle River, NJ. All rights reserved.

This material is protected under all copyright laws as they currently exist. No portion of this material may be reproduced, in any form or by any means, without permission in writing from the publisher.

8-46 Solve Prob. 8-45 for points *D* and *E*.

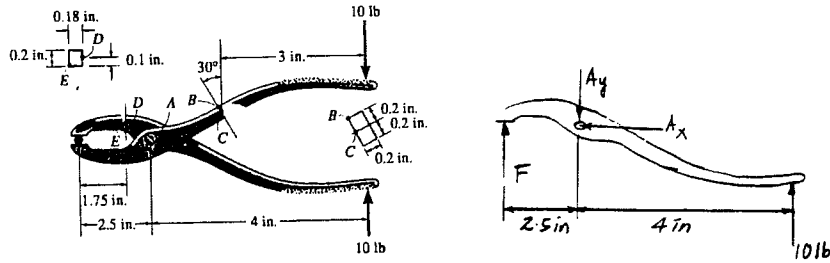

$$(+ \Sigma M_A = 0; \quad -F(2.5) + 4(10) = 0; \quad F = 16 \text{ lb}$$

Point *D* :

$$\tau_D = 0$$

$$\tau_D = \frac{VQ}{It} = \frac{16(0.05)(0.1)(0.18)}{[\frac{1}{12}(0.18)(0.2)^3](0.18)} = 667 \text{ psi}$$

Point *E* :

$$\sigma_E = \frac{My}{I} = \frac{28(0.1)}{\frac{1}{12}(0.18)(0.2)^3} = 23.3 \text{ ksi (C)}$$

$$\tau_E = 0$$

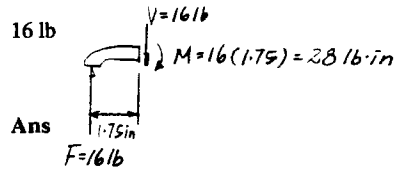

Ans

Ans

Ans

Ans

From *Mechanics of Materials*, Sixth Edition by R. C. Hibbeler, ISBN 0-13-191345-X.

© 2005 R. C. Hibbeler. Published by Pearson Prentice Hall,

Pearson Education, Inc., Upper Saddle River, NJ. All rights reserved.

This material is protected under all copyright laws as they currently exist. No portion of this material may be reproduced, in any form or by any means, without permission in writing from the publisher.

8-47 The beveled gear is subjected to the loads shown. Determine the stress components acting on the shaft at point A, and show the results on a volume element located at this point. The shaft has a diameter of 1 in. and is fixed to the wall at C.

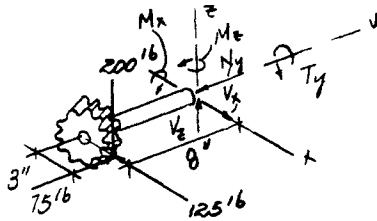
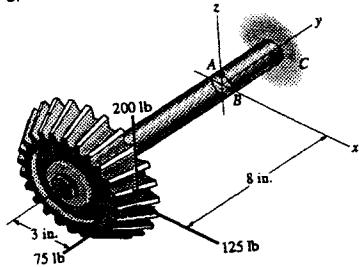

$$\begin{aligned} \Sigma F_x &= 0; & V_x - 125 &= 0; & V_x &= 125 \text{ lb} \\ \Sigma F_y &= 0; & 75 - N_y &= 0; & N_y &= 75 \text{ lb} \\ \Sigma F_z &= 0; & V_z - 200 &= 0; & V_z &= 200 \text{ lb} \\ \Sigma M_x &= 0; & 200(8) - M_x &= 0; & M_x &= 1600 \text{ lb} \cdot \text{in.} \\ \Sigma M_y &= 0; & 200(3) - T_y &= 0; & T_y &= 600 \text{ lb} \cdot \text{in.} \\ \Sigma M_z &= 0; & M_z + 75(3) - 125(8) &= 0; & M_z &= 775 \text{ lb} \cdot \text{in.} \end{aligned}$$

$$\begin{aligned} A &= \pi(0.5^2) = 0.7854 \text{ in}^2 \\ J &= \frac{\pi}{2}(0.5^4) = 0.098175 \text{ in}^4 \\ I &= \frac{\pi}{4}(0.5^4) = 0.049087 \text{ in}^4 \end{aligned}$$

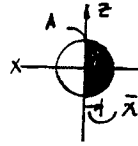

$$\begin{aligned} (Q_A)_x &= 0 \\ (Q_A)_z &= \frac{4(0.5)}{3\pi} \left(\frac{1}{2}\right) (\pi)(0.5^2) = 0.08333 \text{ in}^3 \\ (\sigma_A)_y &= -\frac{N_y}{A} + \frac{M_x c}{I} \\ &= -\frac{75}{0.7854} + \frac{1600(0.5)}{0.049087} \\ &= 16202 \text{ psi} = 16.2 \text{ ksi (T)} \quad \text{Ans} \end{aligned}$$

$$\begin{aligned} (\tau_A)_{yx} &= (\tau_A)_v - (\tau_A)_{\text{twist}} \\ &= \frac{V_z(Q_A)_z}{It} - \frac{T_y c}{J} \\ &= \frac{125(0.08333)}{0.049087(1)} - \frac{600(0.5)}{0.098175} \\ &= -2843 \text{ psi} = -2.84 \text{ ksi} \quad \text{Ans} \end{aligned}$$

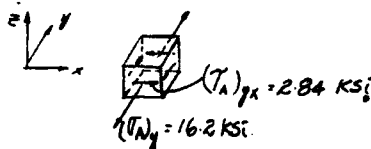

$$(\tau_A)_{yz} = \frac{V_z(Q_A)_x}{It} = 0 \quad \text{Ans}$$

From *Mechanics of Materials*, Sixth Edition by R. C. Hibbeler, ISBN 0-13-191345-X.
 © 2005 R. C. Hibbeler. Published by Pearson Prentice Hall,
 Pearson Education, Inc., Upper Saddle River, NJ. All rights reserved.
 This material is protected under all copyright laws as they currently exist. No portion of this material may be reproduced, in any form or by any means, without permission in writing from the publisher.

*8-48 The beveled gear is subjected to the loads shown. Determine the stress components acting on the shaft at point B, and show the results on a volume element located at this point. The shaft has a diameter of 1 in. and is fixed to the wall at C.

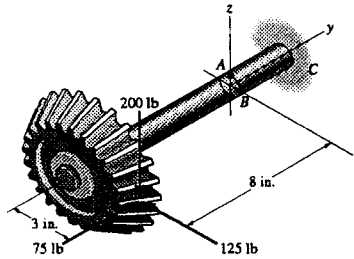

$$\begin{aligned} \Sigma F_x &= 0; & V_x - 125 &= 0; & V_x &= 125 \text{ lb} \\ \Sigma F_y &= 0; & 75 - N_y &= 0; & N_y &= 75 \text{ lb} \\ \Sigma F_z &= 0; & V_z - 200 &= 0; & V_z &= 200 \text{ lb} \\ \Sigma M_x &= 0; & 200(8) - M_x &= 0; & M_x &= 1600 \text{ lb} \cdot \text{in.} \\ \Sigma M_y &= 0; & 200(3) - T_y &= 0; & T_y &= 600 \text{ lb} \cdot \text{in.} \\ \Sigma M_z &= 0; & M_z + 75(3) - 125(8) &= 0; & M_z &= 775 \text{ lb} \cdot \text{in.} \end{aligned}$$

$$A = \pi(0.5^2) = 0.7854 \text{ in}^2$$

$$J = \frac{\pi}{2}(0.5^4) = 0.098175 \text{ in}^4$$

$$I = \frac{\pi}{4}(0.5^4) = 0.049087 \text{ in}^4$$

$$(Q_B)_z = 0$$

$$(Q_B)_x = \frac{4(0.5)}{3\pi} \left(\frac{1}{2} \right) (\pi)(0.5^2) = 0.08333 \text{ in}^3$$

$$\begin{aligned} (\sigma_B)_y &= -\frac{P_y}{A} + \frac{M_z c}{I} \\ &= -\frac{75}{0.7854} + \frac{775(0.5)}{0.049087} \\ &= 7.80 \text{ ksi (T)} \quad \text{Ans} \end{aligned}$$

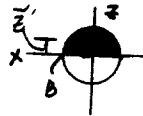
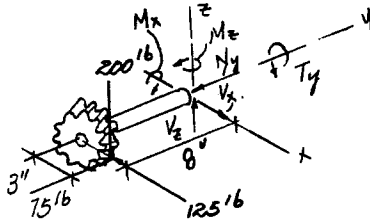

$$\begin{aligned} (\tau_B)_{yz} &= (\tau_B)_v + (\tau_B)_{\text{twist}} \\ &= \frac{V_z(Q_B)_x}{I_t} + \frac{T_y c}{J} \\ &= \frac{200(0.08333)}{0.049087(1)} + \frac{600(0.5)}{0.098175} \\ &= 3395 \text{ psi} = 3.40 \text{ ksi} \quad \text{Ans} \end{aligned}$$

$$(\tau_B)_{yx} = \frac{V_z(Q_B)_z}{I_t} = 0 \quad \text{Ans}$$

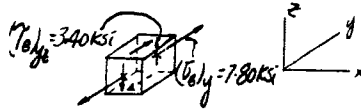

From *Mechanics of Materials*, Sixth Edition by R. C. Hibbeler, ISBN 0-13-191345-X.

© 2005 R. C. Hibbeler. Published by Pearson Prentice Hall,

Pearson Education, Inc., Upper Saddle River, NJ. All rights reserved.

This material is protected under all copyright laws as they currently exist. No portion of this material may be reproduced, in any form or by any means, without permission in writing from the publisher.

8-49. The sign is subjected to the uniform wind loading. Determine the stress components at points *A* and *B* on the 100-mm-diameter supporting post. Show the results on a volume element located at each of these points.

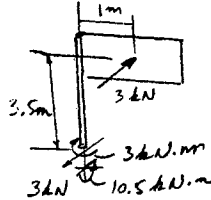
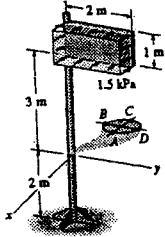

Point *A* :

$$\sigma_A = \frac{Mc}{I} = \frac{10.5(10^3)(0.05)}{\frac{\pi}{4}(0.05)^4} = 107 \text{ MPa} \quad \text{Ans}$$

$$\tau_A = \frac{Tc}{J} = \frac{3(10^3)(0.05)}{\frac{\pi}{2}(0.05)^4} = 15.279(10^6) = 15.3 \text{ MPa} \quad \text{Ans}$$

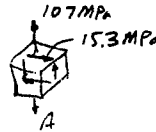

Point *B* :

$$\sigma_B = 0 \quad \text{Ans}$$

$$\tau_B = \frac{Tc}{J} - \frac{VQ}{It} = 15.279(10^6) - \frac{3000(4(0.05)/3\pi)(\frac{1}{2})(\pi)(0.05)^2}{\frac{\pi}{4}(0.05)^4(0.1)}$$

$$\tau_B = 14.8 \text{ MPa} \quad \text{Ans}$$

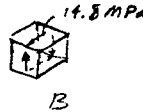

From *Mechanics of Materials*, Sixth Edition by R. C. Hibbeler, ISBN 0-13-191345-X.

© 2005 R. C. Hibbeler. Published by Pearson Prentice Hall,

Pearson Education, Inc., Upper Saddle River, NJ. All rights reserved.

This material is protected under all copyright laws as they currently exist. No portion of this material may be reproduced, in any form or by any means, without permission in writing from the publisher.

8-50. The sign is subjected to the uniform wind loading. Determine the stress components at points C and D on the 100-mm-diameter supporting post. Show the results on a volume element located at each of these points.

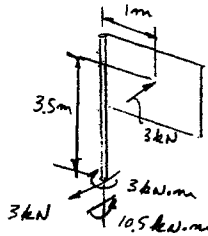
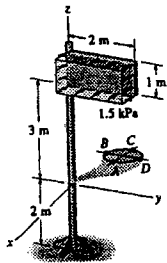

Point C:

$$\sigma_c = \frac{Mc}{I} = \frac{10.5(10^3)(0.05)}{\frac{\pi}{4}(0.05)^4} = 107 \text{ MPa (C)} \quad \text{Ans}$$

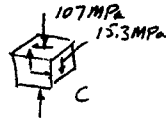

$$\tau_c = \frac{Tc}{J} = \frac{3(10^3)(0.05)}{\frac{\pi}{2}(0.05)^4} = 15.279(10^6) = 15.3 \text{ MPa} \quad \text{Ans}$$

Point D:

$$\sigma_D = 0 \quad \text{Ans}$$



$$\tau_D = \frac{Tc}{J} + \frac{VQ}{It} = 15.279(10^6) + \frac{3(10^3)(4(0.05)/3\pi)(\frac{1}{2})(\pi)(0.05)^2}{\frac{\pi}{4}(0.05)^4(0.1)} = 15.8 \text{ MPa} \quad \text{Ans}$$

From *Mechanics of Materials*, Sixth Edition by R. C. Hibbeler, ISBN 0-13-191345-X.

© 2005 R. C. Hibbeler. Published by Pearson Prentice Hall,

Pearson Education, Inc., Upper Saddle River, NJ. All rights reserved.

This material is protected under all copyright laws as they currently exist. No portion of this material may be reproduced, in any form or by any means, without permission in writing from the publisher.

8-51 The $\frac{3}{4}$ -in.-diameter shaft is subjected to the loading shown. Determine the stress components at point A. Sketch the results on a volume element located at this point. The journal bearing at C can exert only force components C_y and C_z on the shaft, and the thrust bearing at D can exert force components D_x , D_y , and D_z on the shaft.

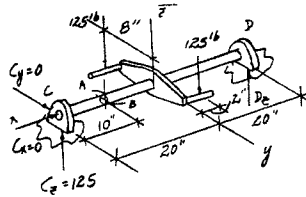
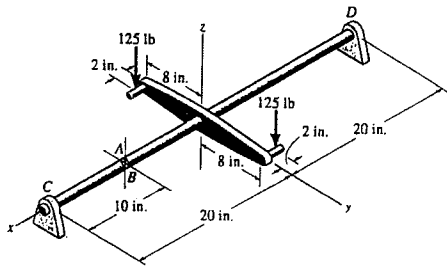

$$A = \frac{\pi}{4}(0.75^2) = 0.44179 \text{ in}^2$$

$$I = \frac{\pi}{4}(0.375^4) = 0.015531 \text{ in}^4$$

$$Q_A = 0$$

$$\tau_A = 0$$

Ans

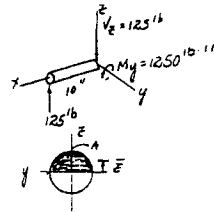

$$\sigma_A = \frac{M_y c}{I} = \frac{-1250(0.375)}{0.015531} = -30.2 \text{ ksi} = 30.2 \text{ ksi (C)}$$

Ans

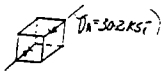

From *Mechanics of Materials*, Sixth Edition by R. C. Hibbeler, ISBN 0-13-191345-X.
 © 2005 R. C. Hibbeler. Published by Pearson Prentice Hall,
 Pearson Education, Inc., Upper Saddle River, NJ. All rights reserved.
 This material is protected under all copyright laws as they currently exist. No portion of this material may be reproduced, in any form or by any means, without permission in writing from the publisher.

*8-52 Solve Prob. 8-51 for the stress components at point B.

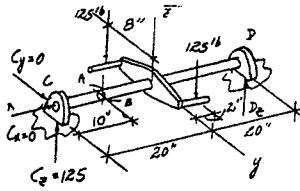
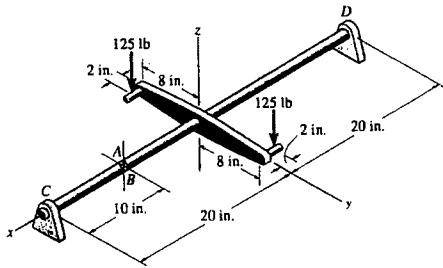

$$A = \frac{\pi}{4}(0.75^2) = 0.44179 \text{ in}^2$$

$$I = \frac{\pi}{4}(0.375^4) = 0.015531 \text{ in}^4$$

$$Q_B = y'A' = \frac{4(0.375)}{3\pi} \left(\frac{1}{2}\right)(\pi)(0.375^2) = 0.035156 \text{ in}^3$$

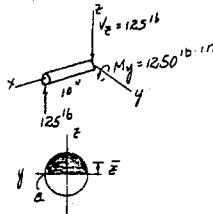

$$\sigma_B = 0$$

$$\tau_B = \frac{VQ_B}{It} = \frac{125(0.035156)}{0.015531(0.75)} = 0.377 \text{ ksi}$$

Ans

Ans

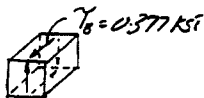

From *Mechanics of Materials*, Sixth Edition by R. C. Hibbeler, ISBN 0-13-191345-X.
 © 2005 R. C. Hibbeler. Published by Pearson Prentice Hall,
 Pearson Education, Inc., Upper Saddle River, NJ. All rights reserved.
 This material is protected under all copyright laws as they currently exist. No portion of this material may be reproduced, in any form or by any means, without permission in writing from the publisher.

8-53 The bent shaft is fixed in the wall at A. If a force F is applied at B, determine the stress components at points D and E. Show the results on a differential element located at each of these points. Take $F = 12$ lb and $\theta = 0^\circ$.

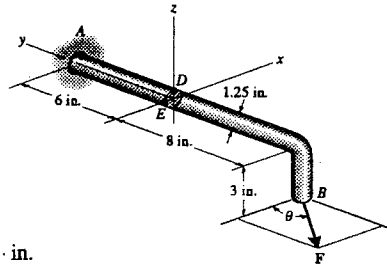

$$\Sigma F_x = 0; \quad V_x - 12 = 0; \quad V_x = 12 \text{ lb}$$

$$\Sigma M_y = 0; \quad -T_y + 12(3) = 0; \quad T_y = 36 \text{ lb} \cdot \text{in.}$$

$$\Sigma M_z = 0; \quad M_z - 12(8) = 0; \quad M_z = 96 \text{ lb} \cdot \text{in.}$$

$$A = \pi (0.625^2) = 1.2272 \text{ in}^2$$

$$I = \frac{1}{4} \pi (0.625^4) = 0.1198 \text{ in}^4$$

$$J = \frac{1}{2} \pi (0.625^4) = 0.2397 \text{ in}^4$$

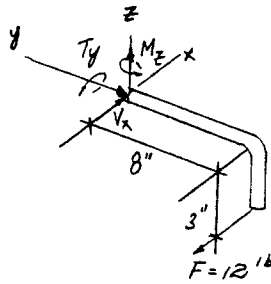

Point D :

$$(Q_D)_z = \frac{4(0.625)}{3\pi} \frac{1}{2} (\pi)(0.625^2) = 0.1628 \text{ in}^3$$

$$\sigma_D = \frac{M_z x}{I} = 0 \quad \text{Ans}$$

$$\begin{aligned} (\tau_D)_{yx} &= (\tau_D)_V - (\tau_D)_{\text{twist}} \\ &= \frac{V_x (Q_D)_z}{I t} - \frac{T_y c}{J} \\ &= \frac{12(0.1628)}{0.1198(1.25)} - \frac{36(0.625)}{0.2397} = -80.8 \text{ psi} \end{aligned}$$

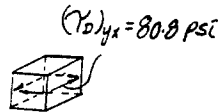

Ans

Point E :

$$(\sigma_E)_y = \frac{M_z x}{I} = \frac{-96(0.625)}{0.1198} = -501 \text{ psi} \quad \text{Ans}$$

$$\begin{aligned} (\tau_E)_{yz} &= (\tau_E)_V - (\tau_E)_{\text{twist}} \\ &= 0 - \frac{T_y c}{J} = \frac{-36(0.625)}{0.2397} \\ &= -93.9 \text{ psi} \quad \text{Ans} \end{aligned}$$

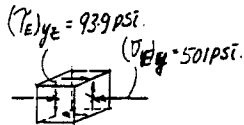

From *Mechanics of Materials*, Sixth Edition by R. C. Hibbeler, ISBN 0-13-191345-X.
 © 2005 R. C. Hibbeler. Published by Pearson Prentice Hall,
 Pearson Education, Inc., Upper Saddle River, NJ. All rights reserved.
 This material is protected under all copyright laws as they currently exist. No portion of this material may be reproduced, in any form or by any means, without permission in writing from the publisher.

8-54. The bent shaft is fixed in the wall at A. If a force F is applied at B, determine the stress components at points D and E. Show the results on a differential element located at each of these points. Take $F = 12$ lb and $\theta = 90^\circ$.

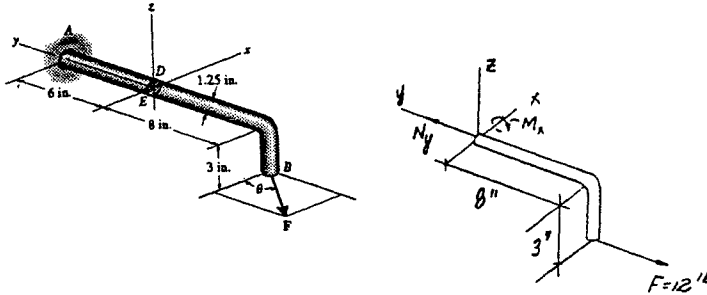

$$\Sigma F_y = 0; \quad N_y - 12 = 0; \quad N_y = 12 \text{ lb}$$

$$\Sigma M_x = 0; \quad M_x - 12(3) = 0; \quad M_x = 36 \text{ lb} \cdot \text{in.}$$

$$A = \pi (0.625^2) = 1.2272 \text{ in}^2$$

$$I = \frac{1}{4} \pi (0.625^4) = 0.1198 \text{ in}^4$$

Point D :

$$(\sigma_D)_y = \frac{N_y}{A} - \frac{M_x z}{I} = \frac{12}{1.2272} - \frac{36(0.625)}{0.1198}$$

$$= -178 \text{ psi} \quad \text{Ans}$$

$$(\tau_D)_{yx} = (\tau_D)_{yz} = 0 \quad \text{Ans}$$

Point E :

$$(\sigma_E)_y = \frac{N_y}{A} + \frac{M_x z}{I} = \frac{12}{1.2272}$$

$$= 9.78 \text{ psi} \quad \text{Ans}$$

$$(\tau_E)_{yx} = (\tau_E)_{yz} = 0 \quad \text{Ans}$$

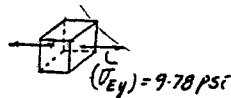
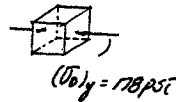

From *Mechanics of Materials*, Sixth Edition by R. C. Hibbeler, ISBN 0-13-191345-X.

© 2005 R. C. Hibbeler. Published by Pearson Prentice Hall,

Pearson Education, Inc., Upper Saddle River, NJ. All rights reserved.

This material is protected under all copyright laws as they currently exist. No portion of this material may be reproduced, in any form or by any means, without permission in writing from the publisher.

8-55. The bent shaft is fixed in the wall at *A*. If a force **F** is applied at *B*, determine the stress components at points *D* and *E*. Show the results on a volume element located at each of these points. Take $F = 12 \text{ lb}$ and $\theta = 45^\circ$.

$$\Sigma F_x = 0; \quad V_x - 12 \cos 45^\circ = 0; \quad V_x = 8.485 \text{ lb}$$

$$\Sigma F_y = 0; \quad N_y - 12 \sin 45^\circ = 0; \quad N_y = 8.485 \text{ lb}$$

$$\Sigma M_x = 0; \quad M_x - 12 \sin 45^\circ(3) = 0; \\ M_x = 25.456 \text{ lb} \cdot \text{in.}$$

$$\Sigma M_y = 0; \quad -T_y + 12 \cos 45^\circ(3) = 0; \quad T_y = 25.456 \text{ lb} \cdot \text{in.}$$

$$\Sigma M_z = 0; \quad M_z - 12 \cos 45^\circ(8) = 0; \quad M_z = 67.882 \text{ lb} \cdot \text{in.}$$

$$A = \pi(0.625^2) = 1.2272 \text{ in}^2$$

$$I = \frac{1}{4}\pi(0.625^4) = 0.1198 \text{ in}^4$$

$$J = \frac{1}{2}\pi(0.625^4) = 0.2397 \text{ in}^4$$

Point *D* :

$$(Q_D)_z = \frac{4(0.625)}{3\pi} \frac{1}{2} (\pi)(0.625^2) = 0.1628 \text{ in}^3$$

$$(\sigma_D)_y = \frac{N_y}{A} - \frac{M_z x}{I} = \frac{8.485}{1.2272} - \frac{25.456(0.625)}{0.1198} \\ = -126 \text{ psi} \quad \text{Ans}$$

$$(\tau_D)_{yx} = \frac{V_x(Q_D)_z}{I t} - \frac{T_y c}{J} \\ = \frac{8.485(0.1628)}{0.1198(1.25)} - \frac{(25.456)(0.625)}{0.2397} \\ = -57.2 \text{ psi} \quad \text{Ans}$$

Point *E* :

$$(\sigma_E)_z = 0$$

$$(\sigma_E)_x = \frac{N_x}{A} - \frac{M_z x}{I} = \frac{8.485}{1.2272} - \frac{(67.882)(0.625)}{0.1198} \\ = -347 \text{ psi} \quad \text{Ans}$$

$$(\tau_E)_{xz} = \frac{V_x Q_x}{I t} - \frac{T c}{J} \\ = 0 - \frac{(25.456)(0.625)}{0.2397} \\ = -66.4 \text{ psi} \quad \text{Ans}$$

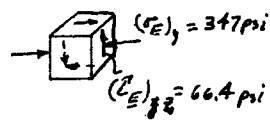
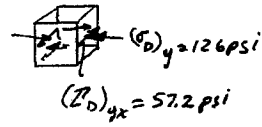
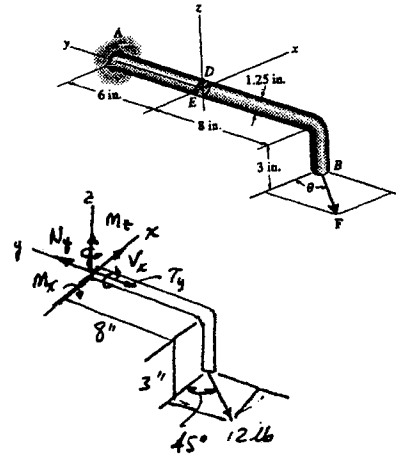

From *Mechanics of Materials*, Sixth Edition by R. C. Hibbeler, ISBN 0-13-191345-X.
 © 2005 R. C. Hibbeler. Published by Pearson Prentice Hall,
 Pearson Education, Inc., Upper Saddle River, NJ. All rights reserved.
 This material is protected under all copyright laws as they currently exist. No portion of this material may be reproduced, in any form or by any means, without permission in writing from the publisher.

*8-56. The 1-in.-diameter rod is subjected to the loads shown. Determine the state of stress at point A, and show the results on a differential element located at this point.

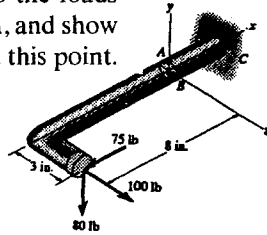

$$\begin{aligned} \Sigma F_x &= 0; & V_y + 100 &= 0; & V_y &= -100 \text{ lb} \\ \Sigma F_y &= 0; & N_x - 75 &= 0; & N_x &= 75 \text{ lb} \\ \Sigma F_z &= 0; & V_z - 80 &= 0; & V_z &= 80 \text{ lb} \\ \Sigma M_x &= 0; & M_x + 80(8) &= 0; & M_x &= -640 \text{ lb}\cdot\text{in.} \\ \Sigma M_y &= 0; & T_x + 80(3) &= 0; & T_x &= -240 \text{ lb}\cdot\text{in.} \\ \Sigma M_z &= 0; & M_z + 100(8) - 75(3) &= 0; & M_z &= -575 \text{ lb}\cdot\text{in.} \end{aligned}$$

$$A = \frac{\pi}{4} d^2 = \frac{\pi}{4} (1^2) = \frac{1}{4} \pi \text{ in}^2$$

$$J = \frac{\pi}{2} c^4 = \frac{\pi}{2} (0.5^4) = 0.03125 \pi \text{ in}^4$$

$$(Q_z)_A = 0$$

$$(Q_z)_A = \bar{y}A = \frac{4(0.5)}{3\pi} \frac{1}{2} (\pi)(0.5^2) = 0.08333 \text{ in}^3$$

$$I_y = I_z = \frac{\pi}{4} r^4 = \frac{\pi}{4} (0.5^4) = 0.015625 \pi \text{ in}^4$$

$$\text{Normal stress: } \sigma = \frac{P}{A} + \frac{M_y y}{I_y} + \frac{M_z z}{I_z}$$

$$\sigma_A = \frac{75}{\frac{1}{4}\pi} + \frac{640(0.5)}{0.0156\pi} + 0 = 6.61 \text{ ksi (T)}$$

Ans

Shear stress:

$$\tau = \frac{VQ}{It} + \frac{Tc}{J}$$

$$(\tau_{xz})_A = \frac{100(0.08333)}{0.0156\pi(1)} + \frac{240(0.5)}{0.0312\pi} = 1.39 \text{ ksi}$$

Ans

$$(\tau_{xy})_A = 0$$

Ans

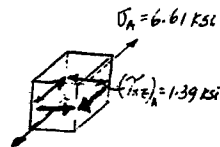
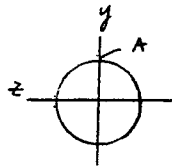
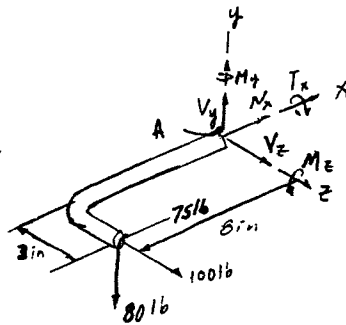

From *Mechanics of Materials*, Sixth Edition by R. C. Hibbeler, ISBN 0-13-191345-X.

© 2005 R. C. Hibbeler. Published by Pearson Prentice Hall,

Pearson Education, Inc., Upper Saddle River, NJ. All rights reserved.

This material is protected under all copyright laws as they currently exist. No portion of this material may be reproduced, in any form or by any means, without permission in writing from the publisher.

8-57. The 1-in.-diameter rod is subjected to the loads shown. Determine the state of stress at point B, and show the results on a differential element located at this point.

$$\begin{aligned} \Sigma F_x = 0; \quad V_x + 100 &= 0; \quad V_x = -100 \text{ lb} \\ \Sigma F_z = 0; \quad N_x - 75 &= 0; \quad N_x = 75.0 \text{ lb} \\ \Sigma F_y = 0; \quad V_y - 80 &= 0; \quad V_y = 80 \text{ lb} \\ \Sigma M_x = 0; \quad M_x + 80(8) &= 0; \quad M_x = -640 \text{ lb}\cdot\text{in.} \\ \Sigma M_z = 0; \quad T_z + 80(3) &= 0; \quad T_z = -240 \text{ lb}\cdot\text{in.} \\ \Sigma M_y = 0; \quad M_y + 100(8) - 75(3) &= 0; \quad M_y = -575 \text{ lb}\cdot\text{in.} \end{aligned}$$

$$A = \frac{\pi}{4} d^2 = \frac{\pi}{4} (1^2) = \frac{\pi}{4} \text{ in}^2$$

$$J = \frac{\pi}{2} c^4 = \frac{\pi}{2} (0.5^4) = 0.03125 \pi \text{ in}^4$$

$$(Q_x)_B = \frac{4(0.5)}{3\pi} \frac{1}{2} \left(\frac{\pi}{4}\right) (1^2) = 0.08333 \text{ in}^3$$

$$I_x = I_z = \frac{\pi}{4} r^4 = \frac{\pi}{4} (0.5^4) = 0.015625 \pi \text{ in}^4$$

Normal stress :

$$\sigma = \frac{P}{A} + \frac{M_x y}{I_x} + \frac{M_z z}{I_z}$$

$$\sigma_B = \frac{75}{\frac{\pi}{4}} + 0 - \frac{575(0.5)}{0.015625\pi} = -5.76 \text{ ksi} = 5.76 \text{ ksi (C)}$$

Shear stress :

$$\tau = \frac{VQ}{It} \text{ and } \tau = \frac{Tc}{J}$$

$$(\tau_{xy})_B = \frac{Tc}{J} - \frac{VQ}{It} = \frac{240(0.5)}{0.03125\pi} + \frac{80(0.0833)}{0.015625\pi(1)} = 1.36 \text{ ksi} \quad \text{Ans}$$

$$(\tau_{xz})_B = 0$$

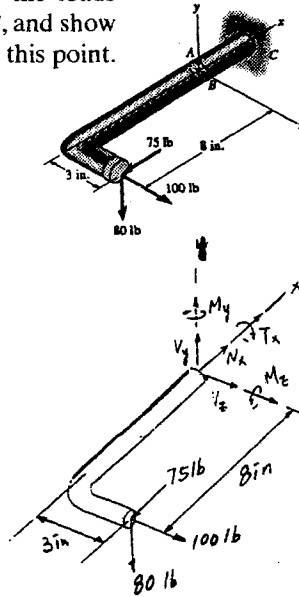

Ans

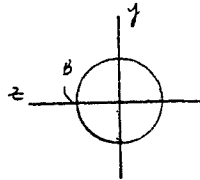

Ans

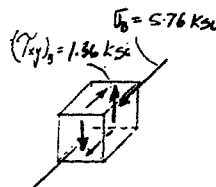

From *Mechanics of Materials*, Sixth Edition by R. C. Hibbeler, ISBN 0-13-191345-X.

© 2005 R. C. Hibbeler. Published by Pearson Prentice Hall,

Pearson Education, Inc., Upper Saddle River, NJ. All rights reserved.

This material is protected under all copyright laws as they currently exist. No portion of this material may be reproduced, in any form or by any means, without permission in writing from the publisher.

8-58 The post has a circular cross section of radius c . Determine the maximum radius e at which the load can be applied so that no part of the post experiences a tensile stress. Neglect the weight of the post.

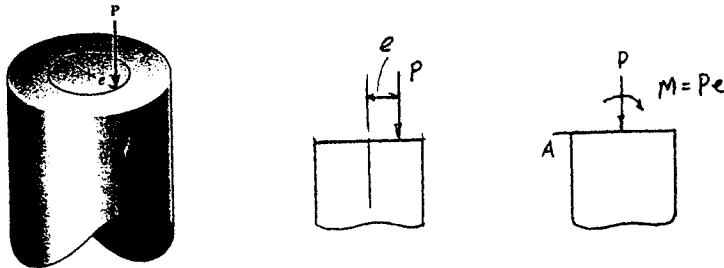

Require $\sigma_A = 0$

$$\sigma_A = 0 = \frac{P}{A} + \frac{M c}{I}; \quad 0 = \frac{-P}{\pi c^2} + \frac{(P e) c}{\frac{\pi}{4} c^4}$$

$$e = \frac{c}{4} \quad \text{Ans}$$

From *Mechanics of Materials*, Sixth Edition by R. C. Hibbeler, ISBN 0-13-191345-X.

© 2005 R. C. Hibbeler. Published by Pearson Prentice Hall,

Pearson Education, Inc., Upper Saddle River, NJ. All rights reserved.

This material is protected under all copyright laws as they currently exist. No portion of this material may be reproduced, in any form or by any means, without permission in writing from the publisher.

8-59 The masonry pier is subjected to the 800-kN load. For the range $y > 0, x > 0$, determine the equation of the line $y = f(x)$ along which the load can be placed without causing a tensile stress in the pier. Neglect the weight of the pier.

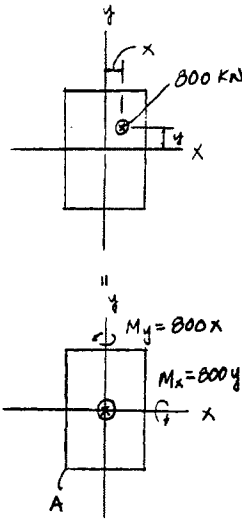
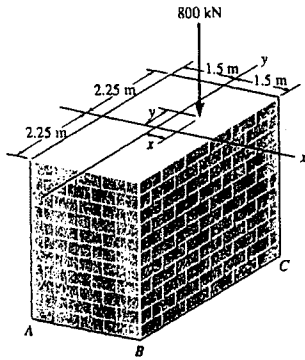

$$A = 3(4.5) = 13.5 \text{ m}^2$$

$$I_x = \frac{1}{12}(3)(4.5^3) = 22.78125 \text{ m}^4$$

$$I_y = \frac{1}{12}(4.5)(3^3) = 10.125 \text{ m}^4$$

Normal stress : Require $\sigma_A = 0$

$$\sigma_A = \frac{P}{A} + \frac{M_x y}{I_x} + \frac{M_y x}{I_y}$$

$$0 = \frac{-800(10^3)}{13.5} + \frac{800(10^3)y(2.25)}{22.78125} + \frac{800(10^3)x(1.5)}{10.125}$$

$$0 = 0.148x + 0.0988y - 0.0741$$

$$y = 0.75 - 1.5x \quad \text{Ans}$$

From *Mechanics of Materials*, Sixth Edition by R. C. Hibbeler, ISBN 0-13-191345-X.

© 2005 R. C. Hibbeler. Published by Pearson Prentice Hall,

Pearson Education, Inc., Upper Saddle River, NJ. All rights reserved.

This material is protected under all copyright laws as they currently exist. No portion of this material may be reproduced, in any form or by any means, without permission in writing from the publisher.

*8-60 The masonry pier is subjected to the 800-kN load. If $x = 0.25$ m and $y = 0.5$ m, determine the normal stress at each corner A, B, C, D (not shown) and plot the stress distribution over the cross section. Neglect the weight of the pier.

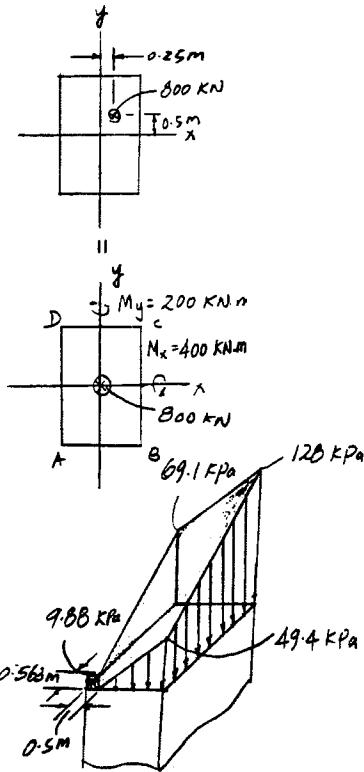
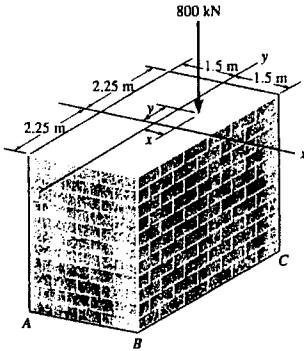

$$A = 3(4.5) = 13.5 \text{ m}^2$$

$$I_x = \frac{1}{12}(3)(4.5^3) = 22.78125 \text{ m}^4$$

$$I_y = \frac{1}{12}(4.5)(3^3) = 10.125 \text{ m}^4$$

$$\sigma = \frac{P}{A} + \frac{M_x y}{I_x} + \frac{M_y x}{I_y}$$

$$\sigma_A = \frac{-800(10^3)}{13.5} + \frac{400(10^3)(2.25)}{22.78125} + \frac{200(10^3)(1.5)}{10.125}$$

$$= 9.88 \text{ kPa (T)}$$

Ans

$$\sigma_B = \frac{-800(10^3)}{13.5} + \frac{400(10^3)(2.25)}{22.78125} - \frac{200(10^3)(1.5)}{10.125}$$

$$= -49.4 \text{ kPa} = 49.4 \text{ kPa (C)}$$

Ans

$$\sigma_C = \frac{-800(10^3)}{13.5} - \frac{400(10^3)(2.25)}{22.78125} - \frac{200(10^3)(1.5)}{10.125}$$

$$= -128 \text{ kPa} = 128 \text{ kPa (C)}$$

Ans

$$\sigma_D = \frac{-800(10^3)}{13.5} - \frac{400(10^3)(2.25)}{22.78125} + \frac{200(10^3)(1.5)}{10.125}$$

$$= -69.1 \text{ kPa} = 69.1 \text{ kPa (C)}$$

Ans

From *Mechanics of Materials*, Sixth Edition by R. C. Hibbeler, ISBN 0-13-191345-X.
 © 2005 R. C. Hibbeler. Published by Pearson Prentice Hall,
 Pearson Education, Inc., Upper Saddle River, NJ. All rights reserved.
 This material is protected under all copyright laws as they currently exist. No portion of this material may be reproduced, in any form or by any means, without permission in writing from the publisher.

8-61 The eye hook has the dimensions shown. If it supports a cable loading of 80 kN, determine the maximum normal stress at section $a-a$ and sketch the stress distribution acting over the cross section.

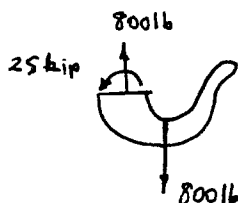
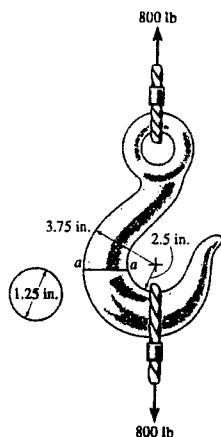

$$\int \frac{dA}{r} = 2\pi (3.125 - \sqrt{(3.125)^2 - (0.625)^2}) = 0.395707$$

$$R = \frac{A}{\int \frac{dA}{r}} = \frac{\pi (0.625)^2}{0.395707} = 3.09343 \text{ in.}$$

$$M = 800(3.125) = 2.5(10^3)$$

$$\sigma = \frac{M(R-r)}{Ar(\bar{r}-R)} + \frac{P}{A}$$

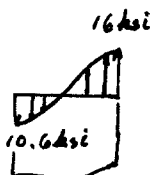

$$(\sigma_t)_{\max} = \frac{2.5(10^3)(3.09343 - 2.5)}{\pi (0.625)^2 (2.5)(3.125 - 3.09343)} + \frac{800}{\pi (0.625)^2} = 16.0 \text{ ksi} \quad \text{Ans}$$

$$(\sigma_c)_{\max} = \frac{2.5(10^3)(3.09343 - 3.75)}{\pi (0.625)^2 (3.75)(3.125 - 3.09343)} + \frac{800}{\pi (0.625)^2} = -10.6 \text{ ksi} \quad \text{Ans}$$

From *Mechanics of Materials*, Sixth Edition by R. C. Hibbeler, ISBN 0-13-191345-X.

© 2005 R. C. Hibbeler. Published by Pearson Prentice Hall,

Pearson Education, Inc., Upper Saddle River, NJ. All rights reserved.

This material is protected under all copyright laws as they currently exist. No portion of this material may be reproduced, in any form or by any means, without permission in writing from the publisher.

8-62. The C-clamp applies a compressive stress on the cylindrical block of 80 psi. Determine the maximum normal stress developed in the clamp.

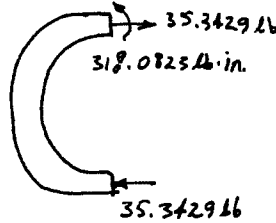
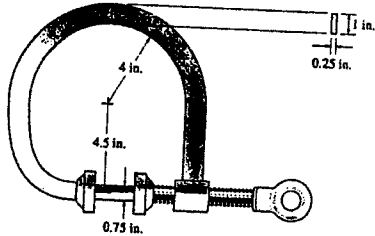

$$\int_A \frac{dA}{r} = 0.25 \ln \frac{5}{4} = 0.055786$$

$$R = \frac{A}{\int \frac{dA}{r}} = \frac{1(0.25)}{0.055786} = 4.48142$$

$$P = \sigma_b A = 80\pi (0.375)^2 = 35.3429 \text{ lb}$$

$$M = 35.3429(9) = 318.0863 \text{ kip} \cdot \text{in.}$$

$$\sigma = \frac{M(R - r)}{Ar(\bar{r} - R)} + \frac{P}{A}$$

$$(\sigma_t)_{\max} = \frac{318.0863(4.48142 - 4)}{(1)(0.25)(4)(4.5 - 4.48142)} + \frac{35.3429}{(1)(0.25)} = 8.38 \text{ ksi} \quad \text{Ans}$$

$$(\sigma_c)_{\max} = \frac{318.0863(4.48142 - 5)}{1(0.25)(5)(4.5 - 4.48142)} + \frac{35.3429}{(1)(0.25)} = -6.96 \text{ ksi}$$

From *Mechanics of Materials*, Sixth Edition by R. C. Hibbeler, ISBN 0-13-191345-X.

© 2005 R. C. Hibbeler. Published by Pearson Prentice Hall,

Pearson Education, Inc., Upper Saddle River, NJ. All rights reserved.

This material is protected under all copyright laws as they currently exist. No portion of this material may be reproduced, in any form or by any means, without permission in writing from the publisher.

8-63 The handle of the press is subjected to a force of 20 lb. Due to internal gearing, this causes the block to be subjected to a compressive force of 80 lb. Determine the normal stress acting in the frame at points along the outside flanges A and B. Use the curved-beam formula to compute the bending stress.

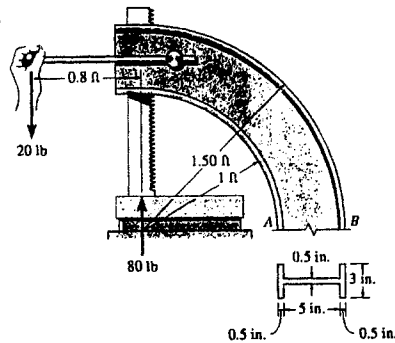

Normal stress due to axial force :

$$A = 2[0.5(3)] + 5(0.5) = 5.5 \text{ in}^2$$

$$\sigma_A = \frac{P}{A} = \frac{60}{5.5} = 10.9090 \text{ psi} \quad (\text{T})$$

Normal stress due to bending :

$$\bar{r} = 15 \text{ in.} \quad r_A = 12 \text{ in.} \quad r_B = 18 \text{ in.}$$

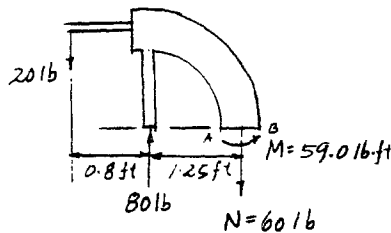

$$\Sigma \int \frac{dA}{r} = \Sigma b \ln \frac{r_2}{r_1} = 3 \ln \frac{12.5}{12} + 0.5 \ln \frac{17.5}{12.5} + 3 \ln \frac{18}{17.5} = 0.3752 \text{ in.}$$

$$R = \frac{A}{\int \frac{dA}{r}} = \frac{5.5}{0.3752} = 14.6583 \text{ in.}$$

$$\bar{r} - R = 0.3417 \text{ in.}$$

$$(\sigma_A)_b = \frac{M(R - r_A)}{Ar_A(\bar{r} - R)} = \frac{59.0(12)(14.6583 - 12)}{5.5(12)(0.3417)} = 83.4468 \text{ psi (T)}$$

$$(\sigma_B)_b = \frac{M(R - r_B)}{Ar_B(\bar{r} - R)} = \frac{59.0(12)(14.6583 - 18)}{5.5(18)(0.3417)} = -69.9342 \text{ psi} = 69.9342 \text{ psi (C)}$$

$$\sigma_A = 83.4468 + 10.9090 = 94.4 \text{ psi (T)} \quad \text{Ans}$$

$$\sigma_B = 69.9342 - 10.9090 = 59.0 \text{ psi (C)} \quad \text{Ans}$$

From *Mechanics of Materials*, Sixth Edition by R. C. Hibbeler, ISBN 0-13-191345-X.

© 2005 R. C. Hibbeler. Published by Pearson Prentice Hall,

Pearson Education, Inc., Upper Saddle River, NJ. All rights reserved.

This material is protected under all copyright laws as they currently exist. No portion of this material may be reproduced, in any form or by any means, without permission in writing from the publisher.

*8-64 The block is subjected to the three axial loads shown. Determine the normal stress developed at points *A* and *B*. Neglect the weight of the block.

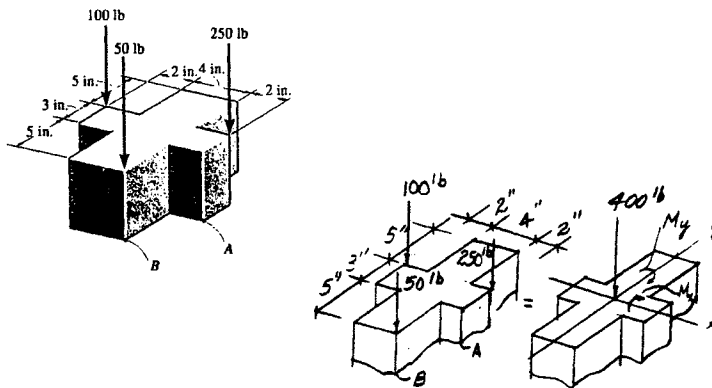

$$M_x = -250(1.5) - 100(1.5) + 50(6.5) = -200 \text{ lb} \cdot \text{in.}$$

$$M_y = 250(4) + 50(2) - 100(4) = 700 \text{ lb} \cdot \text{in.}$$

$$I_x = \frac{1}{12} (4)(13^3) + 2\left(\frac{1}{12}\right)(2)(3^3) = 741.33 \text{ in}^4$$

$$I_y = \frac{1}{12} (3)(8^3) + 2\left(\frac{1}{12}\right)(5)(4^3) = 181.33 \text{ in}^4$$

$$A = 4(13) + 2(2)(3) = 64 \text{ in}^2$$

$$\sigma = \frac{P}{A} - \frac{M_y x}{I_y} + \frac{M_x y}{I_x}$$

$$\sigma_A = -\frac{400}{64} - \frac{700(4)}{181.33} + \frac{-200(-1.5)}{741.33}$$

$$= -21.3 \text{ psi} \quad \text{Ans}$$

$$\sigma_B = -\frac{400}{64} - \frac{700(2)}{181.33} + \frac{-200(-6.5)}{741.33}$$

$$= -12.2 \text{ psi} \quad \text{Ans}$$

From *Mechanics of Materials*, Sixth Edition by R. C. Hibbeler, ISBN 0-13-191345-X.

© 2005 R. C. Hibbeler. Published by Pearson Prentice Hall,

Pearson Education, Inc., Upper Saddle River, NJ. All rights reserved.

This material is protected under all copyright laws as they currently exist. No portion of this material may be reproduced, in any form or by any means, without permission in writing from the publisher.

8-65 The C-frame is used in a riveting machine. If the force at the ram on the clamp at D is $P = 8 \text{ kN}$, sketch the stress distribution acting over the section $a-a$.

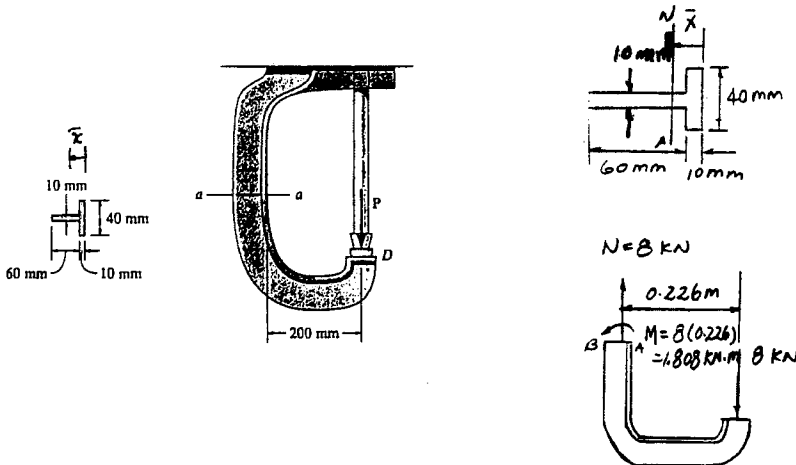

$$\bar{x} = \frac{\sum \bar{x} A}{\sum A} = \frac{(0.005)(0.04)(0.01) + 0.04(0.06)(0.01)}{0.04(0.01) + 0.06(0.01)} = 0.026 \text{ m}$$

$$A = 0.04(0.01) + 0.06(0.01) = 0.001 \text{ m}^2$$

$$I = \frac{1}{12}(0.04)(0.01^3) + (0.04)(0.01)(0.026 - 0.005)^2 + \frac{1}{12}(0.01)(0.06^3) + 0.01(0.06)(0.040 - 0.026)^2 = 0.4773(10^{-6}) \text{ m}^4$$

$$(\sigma_{\max})_t = \frac{P}{A} + \frac{Mx}{I} = \frac{8(10^3)}{0.001} + \frac{1.808(10^3)(0.07 - 0.26)}{0.4773(10^{-6})} = 106.48 \text{ MPa} = 106 \text{ MPa}$$

$$(\sigma_{\max})_c = \frac{P}{A} - \frac{Mx}{I} = \frac{8(10^3)}{0.001} - \frac{1.808(10^3)(0.070 - 0.026)}{0.4773(10^{-6})} = -158.66 \text{ MPa} = -159 \text{ MPa}$$

$$\frac{x}{158.66} = \frac{70 - x}{106.48}; \quad x = 41.9 \text{ mm}$$

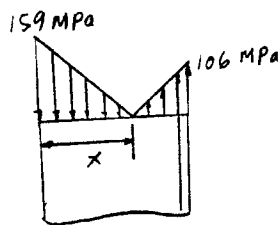

From *Mechanics of Materials*, Sixth Edition by R. C. Hibbeler, ISBN 0-13-191345-X.
 © 2005 R. C. Hibbeler. Published by Pearson Prentice Hall,
 Pearson Education, Inc., Upper Saddle River, NJ. All rights reserved.
 This material is protected under all copyright laws as they currently exist. No portion of this material may be reproduced, in any form or by any means, without permission in writing from the publisher.

8-66 Determine the maximum ram force P that can be applied to the clamp at D if the allowable normal stress for the material is $\sigma_{\text{allow}} = 180 \text{ MPa}$.

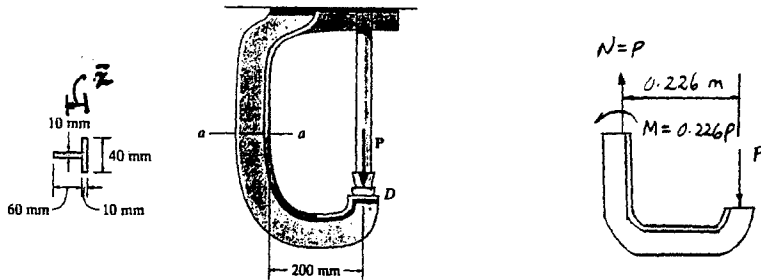

$$\bar{x} = \frac{\Sigma \bar{x}A}{\Sigma A} = \frac{(0.005)(0.04)(0.01) + 0.04(0.06)(0.01)}{0.04(0.01) + 0.06(0.01)} = 0.026 \text{ m}$$

$$A = 0.04(0.01) + 0.06(0.01) = 0.001 \text{ m}^2$$

$$I = \frac{1}{12}(0.04)(0.01^3) + (0.04)(0.01)(0.026 - 0.005)^2 + \frac{1}{12}(0.01)(0.06^3) + 0.01(0.06)(0.040 - 0.026)^2 = 0.4773(10^{-6}) \text{ m}^4$$

$$\sigma = \frac{P}{A} \pm \frac{Mx}{I}$$

Assume tension failure,

$$180(10^6) = \frac{P}{0.001} + \frac{0.226 P(0.026)}{0.4773(10^{-6})}$$

$$P = 13524 \text{ N} = 13.5 \text{ kN}$$

Assume compression failure,

$$-180(10^6) = \frac{P}{0.001} - \frac{0.226 P(0.070 - 0.026)}{0.4773(10^{-6})}$$

$$P = 9076 \text{ N} = 9.08 \text{ kN (controls)} \quad \mathbf{Ans}$$

From *Mechanics of Materials*, Sixth Edition by R. C. Hibbeler, ISBN 0-13-191345-X.

© 2005 R. C. Hibbeler. Published by Pearson Prentice Hall,

Pearson Education, Inc., Upper Saddle River, NJ. All rights reserved.

This material is protected under all copyright laws as they currently exist. No portion of this material may be reproduced, in any form or by any means, without permission in writing from the publisher.

8-67. Air pressure in the cylinder is increased by exerting forces $P = 2 \text{ kN}$ on the two pistons, each having a radius of 45 mm. If the cylinder has a wall thickness of 2 mm, determine the state of stress in the wall of the cylinder.

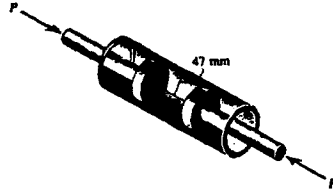

$$p = \frac{P}{A} = \frac{2(10^3)}{\pi(0.045^2)} = 314\,380.13 \text{ Pa}$$

$$\sigma_1 = \frac{p r}{t} = \frac{314\,380.13(0.045)}{0.002} = 7.07 \text{ MPa} \quad \text{Ans}$$

$$\sigma_2 = 0 \quad \text{Ans}$$

The pressure p is supported by the surface of the pistons in the longitudinal direction.

From *Mechanics of Materials*, Sixth Edition by R. C. Hibbeler, ISBN 0-13-191345-X.

© 2005 R. C. Hibbeler. Published by Pearson Prentice Hall,

Pearson Education, Inc., Upper Saddle River, NJ. All rights reserved.

This material is protected under all copyright laws as they currently exist. No portion of this material may be reproduced, in any form or by any means, without permission in writing from the publisher.

***8-68.** Determine the maximum force P that can be exerted on each of the two pistons so that the circumferential stress component in the cylinder does not exceed 3 MPa. Each piston has a radius of 45 mm and the cylinder has a wall thickness of 2 mm.

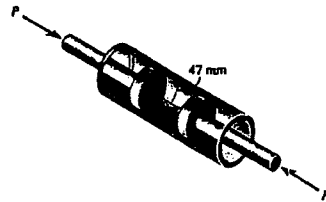

$$\sigma = \frac{p r}{t}; \quad 3(10^6) = \frac{p(0.045)}{0.002}$$

$$p = 133.3 \text{ kPa} \quad \text{Ans}$$

$$P = pA = 133.3(10^3)(\pi)(0.045)^2 = 848 \text{ N} \quad \text{Ans}$$

From *Mechanics of Materials*, Sixth Edition by R. C. Hibbeler, ISBN 0-13-191345-X.

© 2005 R. C. Hibbeler. Published by Pearson Prentice Hall,

Pearson Education, Inc., Upper Saddle River, NJ. All rights reserved.

This material is protected under all copyright laws as they currently exist. No portion of this material may be reproduced, in any form or by any means, without permission in writing from the publisher.

8-69. The wall hanger has a thickness of 0.25 in. and is used to support the vertical reactions of the beam that is loaded as shown. If the load is transferred uniformly to each strap of the hanger, determine the state of stress at points C and D on the strap at A. Assume the vertical reaction F at this end acts in the center and on the edge of the bracket as shown.

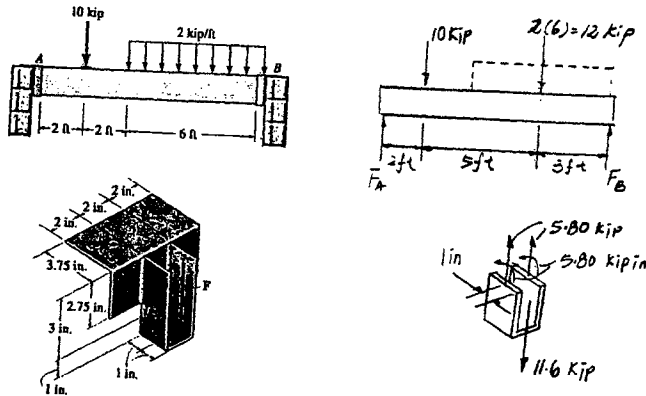

$$\sum M_B = 0; \quad 12(3) + 10(8) - F_A(10) = 0$$

$$F_A = 11.60 \text{ kip}$$

$$I = 2 \left[\frac{1}{12} (0.25)(2)^3 \right] = 0.333 \text{ in}^4$$

$$A = 2(0.25)(2) = 1 \text{ in}^2$$

At point C,

$$\sigma_C = \frac{P}{A} = \frac{2(5.80)}{1} = 11.6 \text{ ksi}$$

$$\tau_C = 0$$

Ans

Ans

At point D,

$$\sigma_D = \frac{P}{A} - \frac{M c}{I} = \frac{2(5.80)}{1} - \frac{[2(5.80)](1)}{0.333} = -23.2 \text{ ksi}$$

$$\tau_D = 0$$

Ans

Ans

From *Mechanics of Materials*, Sixth Edition by R. C. Hibbeler, ISBN 0-13-191345-X.

© 2005 R. C. Hibbeler. Published by Pearson Prentice Hall,

Pearson Education, Inc., Upper Saddle River, NJ. All rights reserved.

This material is protected under all copyright laws as they currently exist. No portion of this material may be reproduced, in any form or by any means, without permission in writing from the publisher.

8-70 The wall hanger has a thickness of 0.25 in. and is used to support the vertical reactions of the beam that is loaded as shown. If the load is transferred uniformly to each strap of the hanger, determine the state of stress at points C and D of the strap at B. Assume the vertical reaction F at this end acts in the center and on the edge of the bracket as shown.

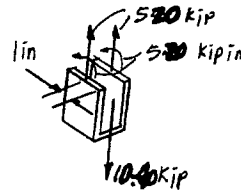
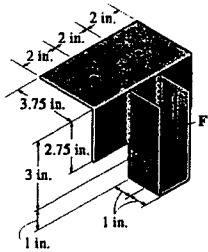
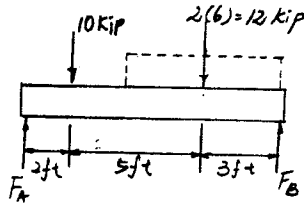
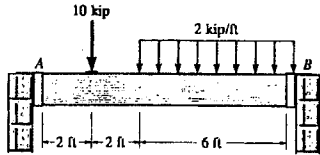

$$\sum M_A = 0; \quad F_B(10) - 10(2) - 12(7) = 0; \quad F_B = 10.40 \text{ kip}$$

$$I = 2\left[\frac{1}{12}(0.25)(2)^3\right] = 0.333 \text{ in}^4; \quad A = 2(0.25)(2) = 1 \text{ in}^2$$

At point C :

$$\sigma_C = \frac{P}{A} = \frac{2(5.20)}{1} = 10.4 \text{ ksi} \quad \text{Ans}$$

$$\tau_C = 0 \quad \text{Ans}$$

At point D :

$$\sigma_D = \frac{P}{A} - \frac{M_C}{I} = \frac{2(5.20)}{1} - \frac{[2(5.20)](1)}{0.333} = -20.8 \text{ ksi} \quad \text{Ans}$$

$$\tau_D = 0 \quad \text{Ans}$$

From *Mechanics of Materials*, Sixth Edition by R. C. Hibbeler, ISBN 0-13-191345-X.

© 2005 R. C. Hibbeler. Published by Pearson Prentice Hall,

Pearson Education, Inc., Upper Saddle River, NJ. All rights reserved.

This material is protected under all copyright laws as they currently exist. No portion of this material may be reproduced, in any form or by any means, without permission in writing from the publisher.

8-71 A bar having a square cross section of 30 mm by 30 mm is 2 m long and is held upward. If it has a mass of 5 kg/m, determine the largest angle θ , measured from the vertical, at which it can be supported before it is subjected to a tensile stress along its axis near the grip.

$$A = 0.03(0.03) = 0.9(10^{-3}) \text{ m}^2$$

$$I = \frac{1}{12}(0.03)(0.03^3) = 67.5(10^{-9}) \text{ m}^4$$

Require $\sigma_A = 0$

$$\sigma_A = 0 = \frac{P}{A} + \frac{M c}{I}$$

$$0 = \frac{-98.1 \cos \theta}{0.9(10^{-3})} + \frac{98.1 \sin \theta (0.015)}{67.5(10^{-9})}$$

$$0 = -1111.11 \cos \theta + 222222.22 \sin \theta$$

$$\tan \theta = 0.005; \quad \theta = 0.286^\circ \quad \text{Ans}$$

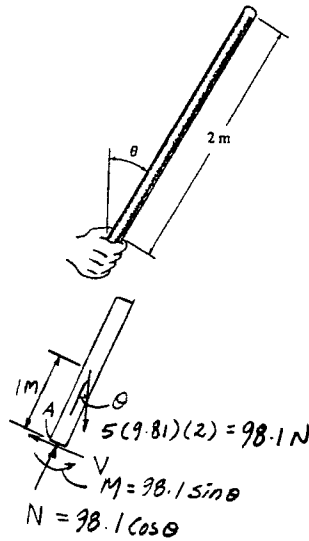

From *Mechanics of Materials*, Sixth Edition by R. C. Hibbeler, ISBN 0-13-191345-X.

© 2005 R. C. Hibbeler. Published by Pearson Prentice Hall,

Pearson Education, Inc., Upper Saddle River, NJ. All rights reserved.

This material is protected under all copyright laws as they currently exist. No portion of this material may be reproduced, in any form or by any means, without permission in writing from the publisher.

*8-72 Solve Prob. 8-71 if the bar has a circular cross section of 30-mm diameter.

$$A = \frac{\pi}{4}(0.03^2) = 0.225\pi(10^{-3}) \text{ m}^2$$

$$I = \frac{\pi}{4}(0.015^4) = 12.65625\pi(10^{-9}) \text{ m}^4$$

Require $\sigma_A = 0$

$$\sigma_A = 0 = \frac{P}{A} + \frac{M c}{I}$$

$$0 = \frac{-98.1 \cos \theta}{0.225\pi(10^{-3})} + \frac{98.1 \sin \theta(0.015)}{12.65625 \pi(10^{-9})}$$

$$0 = -4444.44 \cos \theta + 1185185.185 \sin \theta$$

$$\tan \theta = 0.00375$$

$$\theta = 0.215^\circ \quad \text{Ans}$$

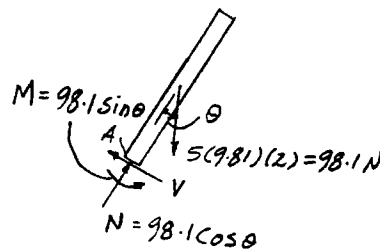
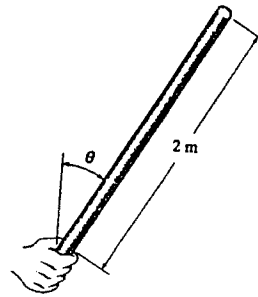

From *Mechanics of Materials*, Sixth Edition by R. C. Hibbeler, ISBN 0-13-191345-X.
 © 2005 R. C. Hibbeler. Published by Pearson Prentice Hall,
 Pearson Education, Inc., Upper Saddle River, NJ. All rights reserved.
 This material is protected under all copyright laws as they currently exist. No portion of this material may be reproduced, in any form or by any means, without permission in writing from the publisher.

8-73. The cap on the cylindrical tank is bolted to the tank along the flanges. The tank has an inner diameter of 1.5 m and a wall thickness of 18 mm. If the largest normal stress is not to exceed 150 MPa, determine the maximum pressure the tank can sustain. Also, compute the number of bolts required to attach the cap to the tank if each bolt has a diameter of 20 mm. The allowable stress for the bolts is $(\sigma_{\text{allow}})_b = 180 \text{ MPa}$.

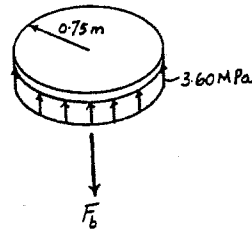
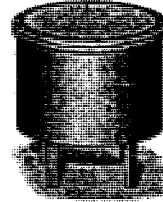

Hoop Stress for Cylindrical Tank : Since $\frac{r}{t} = \frac{750}{18}$
 $= 41.6 > 10$, then *thin wall* analysis can be used. Applying Eq. 8-1

$$\sigma_t = \sigma_{\text{allow}} = \frac{pr}{t}$$

$$150(10^6) = \frac{p(750)}{18}$$

$$p = 3.60 \text{ MPa} \quad \text{Ans}$$

Force Equilibrium for the Cap :

$$+\uparrow \Sigma F_y = 0; \quad 3.60(10^6) [\pi(0.75^2)] - F_b = 0$$

$$F_b = 6.3617(10^6) \text{ N}$$

Allowable Normal Stress for Bolts :

$$(\sigma_{\text{allow}})_b = \frac{P}{A}$$

$$180(10^6) = \frac{6.3617(10^6)}{n \left[\frac{\pi}{4} (0.02^2) \right]}$$

$$n = 112.5$$

$$\text{Use } n = 113 \text{ bolts} \quad \text{Ans}$$

From *Mechanics of Materials*, Sixth Edition by R. C. Hibbeler, ISBN 0-13-191345-X.

© 2005 R. C. Hibbeler. Published by Pearson Prentice Hall,

Pearson Education, Inc., Upper Saddle River, NJ. All rights reserved.

This material is protected under all copyright laws as they currently exist. No portion of this material may be reproduced, in any form or by any means, without permission in writing from the publisher.

8-74. The cap on the cylindrical tank is bolted to the tank along the flanges. The tank has an inner diameter of 1.5 m and a wall thickness of 18 mm. If the pressure in the tank is $p = 1.20$ MPa, determine the force in the 16 bolts that are used to attach the cap to the tank. Also, specify the state of stress in the wall of the tank.

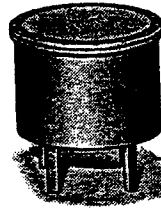

Hoop Stress for Cylindrical Tank : Since $\frac{r}{t} = \frac{750}{18}$
 $= 41.6 > 10$, then *thin wall* analysis can be used. Applying Eq. 8-1

$$\sigma_1 = \frac{pr}{t} = \frac{1.20(10^6)(750)}{18} = 50.0 \text{ MPa} \quad \text{Ans}$$

Longitudinal Stress for Cylindrical Tank :

$$\sigma_2 = \frac{pr}{2t} = \frac{1.20(10^6)(750)}{2(18)} = 25.0 \text{ MPa} \quad \text{Ans}$$

Force Equilibrium for the Cap :

$$+\uparrow \Sigma F_y = 0; \quad 1.20(10^6) [\pi(0.75^2)] - 16F_b = 0$$

$$F_b = 132536 \text{ N} = 133 \text{ kN} \quad \text{Ans}$$

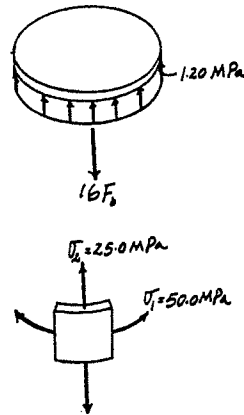

From *Mechanics of Materials*, Sixth Edition by R. C. Hibbeler, ISBN 0-13-191345-X.

© 2005 R. C. Hibbeler. Published by Pearson Prentice Hall,

Pearson Education, Inc., Upper Saddle River, NJ. All rights reserved.

This material is protected under all copyright laws as they currently exist. No portion of this material may be reproduced, in any form or by any means, without permission in writing from the publisher.

8-75. The crowbar is used to pull out the nail at A. If a force of 8 lb is required, determine the stress components in the bar at points D and E. Show the results on a differential volume element located at each of these points. The bar has a circular cross section with a diameter of 0.5 in. No slipping occurs at B.

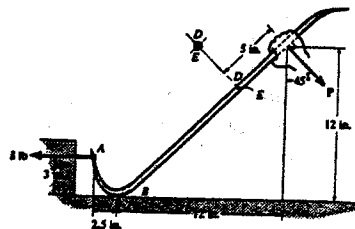

Support Reactions :

$$\left(+\Sigma M_B = 0; \quad 8(3) - P(16.97) = 0 \quad P = 1.414 \text{ lb} \right)$$

Internal Forces and Moment :

$$\begin{aligned} \left(+\Sigma F_x = 0; \quad N = 0 \right. \\ \left. +\Sigma F_y = 0; \quad V - 1.414 = 0 \quad V = 1.414 \text{ lb} \right. \\ \left. +\Sigma M_O = 0; \quad M - 1.414(5) = 0 \quad M = 7.071 \text{ lb} \cdot \text{in.} \right) \end{aligned}$$

Section Properties :

$$\begin{aligned} A &= \pi (0.25^2) = 0.0625\pi \text{ in}^2 \\ I &= \frac{\pi}{4} (0.25^4) = 0.9765625\pi (10^{-3}) \text{ in}^4 \\ Q_D &= 0 \\ Q_E &= \bar{y}'A' = \frac{4(0.25)}{3\pi} \left[\frac{1}{2} (\pi) (0.25^2) \right] = 0.0104167 \text{ m}^3 \end{aligned}$$

Normal Stress : Since $N = 0$, the normal stress is caused by bending stress only.

$$\sigma_D = \frac{Mc}{I} = \frac{7.071(0.25)}{0.9765625\pi(10^{-3})} = 576 \text{ psi (T)} \quad \text{Ans}$$

$$\sigma_E = \frac{My}{I} = \frac{7.071(0)}{0.9765625\pi(10^{-3})} = 0 \quad \text{Ans}$$

Shear Stress : Applying the shear formul.

$$\tau_D = \frac{VQ_D}{It} = 0 \quad \text{Ans}$$

$$\tau_E = \frac{VQ_E}{It} = \frac{1.414(0.0104167)}{0.9765625\pi(10^{-3})(0.5)} = 9.60 \text{ psi} \quad \text{Ans}$$

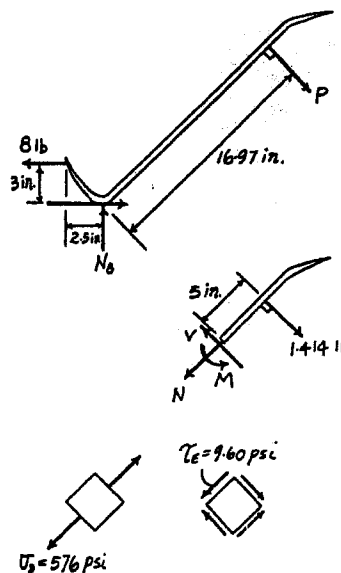

From *Mechanics of Materials*, Sixth Edition by R. C. Hibbeler, ISBN 0-13-191345-X.
 © 2005 R. C. Hibbeler. Published by Pearson Prentice Hall,
 Pearson Education, Inc., Upper Saddle River, NJ. All rights reserved.
 This material is protected under all copyright laws as they currently exist. No portion of this material may be reproduced, in any form or by any means, without permission in writing from the publisher.

***8-76.** The steel bracket is used to connect the ends of two cables. If the applied force $P = 500$ lb, determine the maximum normal stress in the bracket. The bracket has a thickness of 0.5 in. and a width of 0.75 in.

Internal Force and Moment : As shown on FBD.

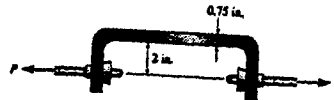

Section Properties :

$$A = 0.5(0.75) = 0.375 \text{ in}^2$$

$$I = \frac{1}{12}(0.5)(0.75^3) = 0.01758 \text{ in}^4$$

Maximum Normal Stress : The maximum normal stress occurs at the bottom of the steel bracket.

$$\begin{aligned} \sigma_{\max} &= \frac{N}{A} + \frac{Mc}{I} \\ &= \frac{500}{0.375} + \frac{1187.5(0.375)}{0.01758} \\ &= 26.7 \text{ ksi} \end{aligned}$$

Ans

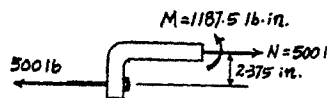

From *Mechanics of Materials*, Sixth Edition by R. C. Hibbeler, ISBN 0-13-191345-X.

© 2005 R. C. Hibbeler. Published by Pearson Prentice Hall,

Pearson Education, Inc., Upper Saddle River, NJ. All rights reserved.

This material is protected under all copyright laws as they currently exist. No portion of this material may be reproduced, in any form or by any means, without permission in writing from the publisher.

8-77. The clamp is made from members AB and AC , which are pin connected at A . If the compressive force at C and B is 180 N , determine the state of stress at point F , and indicate the results on a differential volume element. The screw DE is subjected only to a tensile force along its axis.

Support Reactions :

$$\begin{aligned} \curvearrowleft + \Sigma M_A = 0; & \quad 180(0.07) - T_{DE}(0.03) = 0 \\ & \quad T_{DE} = 420\text{ N} \end{aligned}$$

Internal Forces and Moment :

$$\begin{aligned} \rightarrow \Sigma F_x = 0; & \quad 420 - 180 - V = 0 \quad V = 240\text{ N} \\ + \uparrow \Sigma F_y = 0; & \quad N = 0 \\ + \Sigma M_O = 0; & \quad 180(0.055) - 420(0.015) - M = 0 \\ & \quad M = 3.60\text{ N}\cdot\text{m} \end{aligned}$$

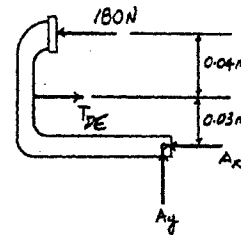
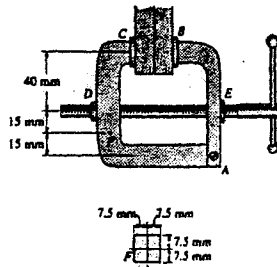

Section Properties :

$$\begin{aligned} A &= 0.015(0.015) = 0.225(10^{-3})\text{ m}^2 \\ I &= \frac{1}{12}(0.015)(0.015^3) = 4.21875(10^{-9})\text{ m}^4 \\ Q_F &= 0 \end{aligned}$$

Normal Stress : Since $N = 0$, the normal stress is caused by bending stress only.

$$\sigma_F = \frac{Mc}{I} = \frac{3.60(0.0075)}{4.21875(10^{-9})} = 6.40\text{ MPa (C)} \quad \text{Ans}$$

Shear Stress : Applying shear formula, we have

$$\tau_F = \frac{VQ_F}{It} = 0 \quad \text{Ans}$$

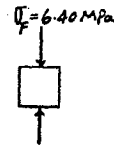
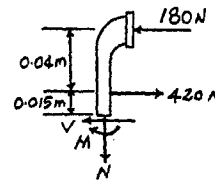

From *Mechanics of Materials*, Sixth Edition by R. C. Hibbeler, ISBN 0-13-191345-X.
 © 2005 R. C. Hibbeler. Published by Pearson Prentice Hall,
 Pearson Education, Inc., Upper Saddle River, NJ. All rights reserved.
 This material is protected under all copyright laws as they currently exist. No portion of this material may be reproduced, in any form or by any means, without permission in writing from the publisher.

8-78. The clamp is made from members AB and AC , which are pin-connected at A . If the compressive force at C and B is 180 N, determine the state of stress at point G , and indicate the results on a differential volume element. The screw DE is subjected only to a tensile force along its axis.

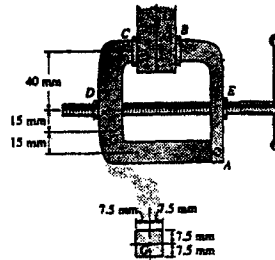

Support Reactions :

$$\left(+ \Sigma M_A = 0; \quad 180(0.07) - T_{DE}(0.03) = 0 \right. \\ \left. T_{DE} = 420 \text{ N} \right.$$

Internal Forces and Moment :

$$\begin{aligned} \rightarrow \Sigma F_x = 0; \quad 420 - 180 - V = 0 \quad V = 240 \text{ N} \\ + \uparrow \Sigma F_y = 0; \quad N = 0 \\ \curvearrowleft + \Sigma M_O = 0; \quad 180(0.055) - 420(0.015) - M = 0 \\ M = 3.60 \text{ N} \cdot \text{m} \end{aligned}$$

Section Properties :

$$\begin{aligned} A &= 0.015(0.015) = 0.225(10^{-3}) \text{ m}^2 \\ I &= \frac{1}{12}(0.015)(0.015^3) = 4.21875(10^{-9}) \text{ m}^4 \\ Q_G &= \bar{y}'A' = 0.00375(0.0075)(0.015) = 0.421875(10^{-6}) \text{ m}^3 \end{aligned}$$

Normal Stress : Since $N = 0$, the normal stress is caused by bending stress only.

$$\sigma_G = \frac{My}{I} = \frac{3.60(0)}{4.21875(10^{-9})} = 0 \quad \text{Ans}$$

Shear Stress : Applying shear formula, we have

$$\tau_G = \frac{VQ_G}{It} = \frac{240[0.421875(10^{-6})]}{4.21875(10^{-9})(0.015)} = 1.60 \text{ MPa} \quad \text{Ans}$$

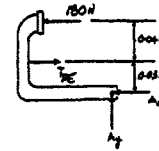

From *Mechanics of Materials*, Sixth Edition by R. C. Hibbeler, ISBN 0-13-191345-X.

© 2005 R. C. Hibbeler. Published by Pearson Prentice Hall,

Pearson Education, Inc., Upper Saddle River, NJ. All rights reserved.

This material is protected under all copyright laws as they currently exist. No portion of this material may be reproduced, in any form or by any means, without permission in writing from the publisher.

8-79. The wide-flange beam is subjected to the loading shown. Determine the state of stress at points *A* and *B*, and show the results on a differential volume element located at each of these points.

Support Reactions : As shown on FBD.

Internal Forces and Moment : As shown on FBD.

Section Properties :

$$A = 4(7) - 3.5(6) = 7.00 \text{ in}^2$$

$$I = \frac{1}{12}(4)(7^3) - \frac{1}{12}(3.5)(6^3) = 51.333 \text{ in}^4$$

$$Q_A = 0$$

$$Q_B = \Sigma \bar{y}'A' = 3.25(0.5)(4) + 2.00(0.5)(2) = 8.50 \text{ in}^3$$

Normal Stress : Since $N = 0$, the normal stress is contributed by bending stress only.

$$\sigma_A = \frac{Mc}{I} = \frac{7.20(12)(3.5)}{51.333} = 5.89 \text{ ksi (C) Ans}$$

$$\sigma_B = \frac{My}{I} = \frac{7.20(12)(1)}{51.333} = 1.68 \text{ ksi (T) Ans}$$

Shear Stress : Applying the shear formula.

$$\tau_A = \frac{VQ_A}{It} = 0 \text{ Ans}$$

$$\tau_B = \frac{VQ_B}{It} = \frac{1.20(8.50)}{51.333(0.5)} = 0.397 \text{ ksi Ans}$$

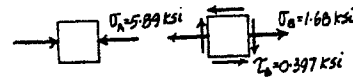
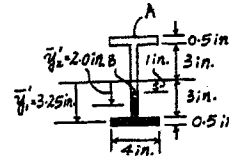
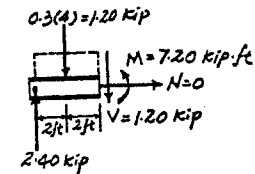
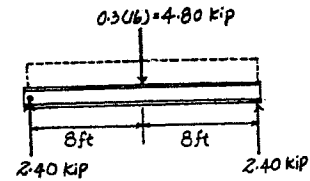
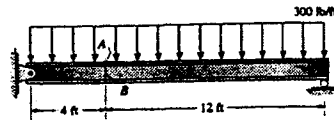

From *Mechanics of Materials*, Sixth Edition by R. C. Hibbeler, ISBN 0-13-191345-X.

© 2005 R. C. Hibbeler. Published by Pearson Prentice Hall,

Pearson Education, Inc., Upper Saddle River, NJ. All rights reserved.

This material is protected under all copyright laws as they currently exist. No portion of this material may be reproduced, in any form or by any means, without permission in writing from the publisher.

9-1. Prove that the sum of the normal stresses $\sigma_x + \sigma_y = \sigma_{x'} + \sigma_{y'}$ is constant.

Stress Transformation Equations : Applying Eqs. 9-1 and 9-3 of the text

$$\begin{aligned} \sigma_{x'} + \sigma_{y'} &= \frac{\sigma_x + \sigma_y}{2} + \frac{\sigma_x - \sigma_y}{2} \cos 2\theta + \tau_{xy} \sin 2\theta \\ &\quad + \frac{\sigma_x + \sigma_y}{2} - \frac{\sigma_x - \sigma_y}{2} \cos 2\theta - \tau_{xy} \sin 2\theta \end{aligned}$$

$$\sigma_{x'} + \sigma_{y'} = \sigma_x + \sigma_y \quad (Q. E. D.)$$

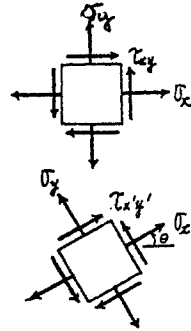

From *Mechanics of Materials*, Sixth Edition by R. C. Hibbeler, ISBN 0-13-191345-X.

© 2005 R. C. Hibbeler. Published by Pearson Prentice Hall,

Pearson Education, Inc., Upper Saddle River, NJ. All rights reserved.

This material is protected under all copyright laws as they currently exist. No portion of this material may be reproduced, in any form or by any means, without permission in writing from the publisher.

9-2. The state of stress at a point in a member is shown on the element. Determine the stress components acting on the inclined plane AB . Solve the problem using the method of equilibrium described in Sec. 9.1.

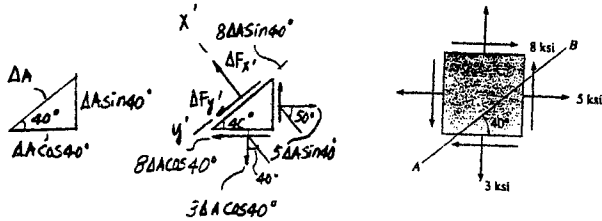

$$\begin{aligned} \sum F_{x'} = 0 \quad \Delta F_{x'} + (8\Delta A \sin 40^\circ) \cos 40^\circ - (5\Delta A \sin 40^\circ) \cos 50^\circ - (3\Delta A \cos 40^\circ) \cos 40^\circ + \\ (8\Delta A \cos 40^\circ) \cos 50^\circ = 0 \\ \Delta F_{x'} = -4.052\Delta A \end{aligned}$$

$$\begin{aligned} \sum F_{y'} = 0 \quad \Delta F_{y'} - (8\Delta A \sin 40^\circ) \sin 40^\circ - (5\Delta A \sin 40^\circ) \sin 50^\circ + (3\Delta A \cos 40^\circ) \sin 40^\circ + \\ (8\Delta A \cos 40^\circ) \sin 50^\circ = 0 \\ \Delta F_{y'} = -0.4044\Delta A \end{aligned}$$

$$\sigma_{x'} = \lim_{\Delta A \rightarrow 0} \frac{\Delta F_{x'}}{\Delta A} = -4.05 \text{ ksi} \quad \text{Ans}$$

$$\tau_{x'y'} = \lim_{\Delta A \rightarrow 0} \frac{\Delta F_{y'}}{\Delta A} = -0.404 \text{ ksi} \quad \text{Ans}$$

The negative signs indicate that the sense of $\sigma_{x'}$ and $\tau_{x'y'}$ are opposite to that shown on FBD

From *Mechanics of Materials*, Sixth Edition by R. C. Hibbeler, ISBN 0-13-191345-X.

© 2005 R. C. Hibbeler. Published by Pearson Prentice Hall,

Pearson Education, Inc., Upper Saddle River, NJ. All rights reserved.

This material is protected under all copyright laws as they currently exist. No portion of this material may be reproduced, in any form or by any means, without permission in writing from the publisher.

9-3 The state of stress at a point in a member is shown on the element. Determine the stress components acting on the inclined plane AB . Solve the problem using the method of equilibrium described in Sec. 9.1.

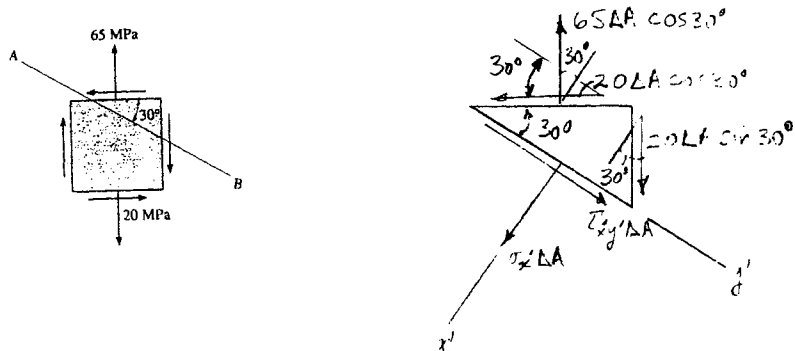

$$\begin{aligned} \sum F_x = 0; \quad & \sigma_x \Delta A + 20\Delta A \sin 30^\circ \cos 30^\circ + 20\Delta A \cos 30^\circ \cos 60^\circ - 65\Delta A \cos 30^\circ \cos 30^\circ = 0 \\ & \sigma_x = 31.4 \text{ MPa} \quad \text{Ans} \end{aligned}$$

$$\begin{aligned} \sum F_y = 0; \quad & \tau_{x'y'} \Delta A + 20\Delta A \sin 30^\circ \sin 30^\circ - 20\Delta A \cos 30^\circ \sin 60^\circ - 65 \Delta A \cos 30^\circ \sin 30^\circ = 0 \\ & \tau_{x'y'} = 38.1 \text{ MPa} \quad \text{Ans} \end{aligned}$$

From *Mechanics of Materials*, Sixth Edition by R. C. Hibbeler, ISBN 0-13-191345-X.

© 2005 R. C. Hibbeler. Published by Pearson Prentice Hall,

Pearson Education, Inc., Upper Saddle River, NJ. All rights reserved.

This material is protected under all copyright laws as they currently exist. No portion of this material may be reproduced, in any form or by any means, without permission in writing from the publisher.

***9-4.** The state of stress at a point in a member is shown on the element. Determine the stress components acting on the inclined plane AB . Solve the problem using the method of equilibrium described in Sec. 9.1.

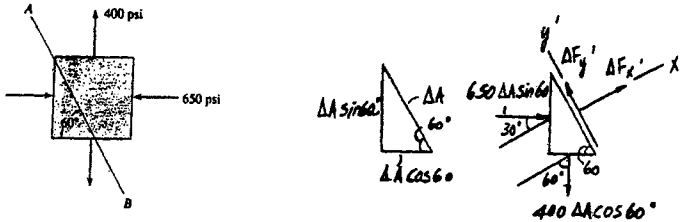

$$\begin{aligned} \sum F_x = 0 \quad \Delta F_x - 400(\Delta A \cos 60^\circ) \cos 60^\circ + 650(\Delta A \sin 60^\circ) \cos 30^\circ = 0 \\ \Delta F_x = -387.5 \Delta A \end{aligned}$$

$$\begin{aligned} \sum F_y = 0 \quad \Delta F_y - 650(\Delta A \sin 60^\circ) \sin 30^\circ - 400(\Delta A \cos 60^\circ) \sin 60^\circ = 0 \\ \Delta F_y = 455 \Delta A \end{aligned}$$

$$\sigma_x = \lim_{\Delta A \rightarrow 0} \frac{\Delta F_x}{\Delta A} = -388 \text{ psi} \quad \text{Ans}$$

$$\tau_{xy} = \lim_{\Delta A \rightarrow 0} \frac{\Delta F_y}{\Delta A} = 455 \text{ psi} \quad \text{Ans}$$

The negative sign indicates that the sense of σ_x is opposite to that shown on FBD.

From *Mechanics of Materials*, Sixth Edition by R. C. Hibbeler, ISBN 0-13-191345-X.

© 2005 R. C. Hibbeler. Published by Pearson Prentice Hall,

Pearson Education, Inc., Upper Saddle River, NJ. All rights reserved.

This material is protected under all copyright laws as they currently exist. No portion of this material may be reproduced, in any form or by any means, without permission in writing from the publisher.

9-5 The state of stress at a point in a member is shown on the element. Determine the stress components acting on the inclined plane AB . Solve the problem using the method of equilibrium described in Sec. 9.1.

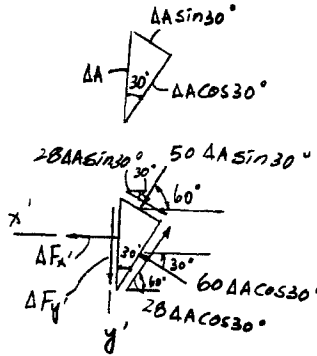
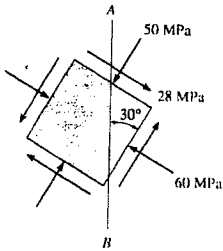

$$\begin{aligned}
 + \Sigma F_{x'} = 0; \quad & \Delta F_{x'} + 60 \Delta A \cos 30^\circ \cos 30^\circ - 28 \Delta A \cos 30^\circ \cos 60^\circ \\
 & + 50 \Delta A \sin 30^\circ \cos 60^\circ - 28 \Delta A \sin 30^\circ \cos 30^\circ = 0 \\
 & \Delta F_{x'} = -33.251 \Delta A
 \end{aligned}$$

$$\begin{aligned}
 + \downarrow \Sigma F_{y'} = 0; \quad & \Delta F_{y'} - 28 \Delta A \cos 30^\circ \sin 60^\circ - 60 \Delta A \cos 30^\circ \sin 30^\circ \\
 & + 50 \Delta A \sin 30^\circ \sin 60^\circ + 28 \Delta A \sin 30^\circ \sin 30^\circ = 0 \\
 & \Delta F_{y'} = 18.33 \Delta A
 \end{aligned}$$

$$\sigma_{x'} = \lim_{\Delta A \rightarrow 0} \frac{\Delta F_{x'}}{\Delta A} = -33.3 \text{ MPa} \quad \text{Ans}$$

$$\tau_{x'y'} = \lim_{\Delta A \rightarrow 0} \frac{\Delta F_{y'}}{\Delta A} = 18.3 \text{ MPa} \quad \text{Ans}$$

The negative sign indicates that the sense of $\sigma_{x'}$ is opposite to that shown on FBD.

From *Mechanics of Materials*, Sixth Edition by R. C. Hibbeler, ISBN 0-13-191345-X.

© 2005 R. C. Hibbeler. Published by Pearson Prentice Hall,

Pearson Education, Inc., Upper Saddle River, NJ. All rights reserved.

This material is protected under all copyright laws as they currently exist. No portion of this material may be reproduced, in any form or by any means, without permission in writing from the publisher.

9-6 The state of stress at a point in a member is shown on the element. Determine the stress components acting on the inclined plane AB . Solve the problem using the method of equilibrium described in Sec. 9.1.

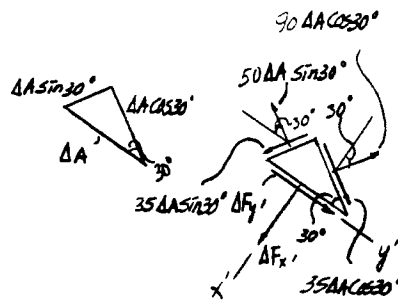
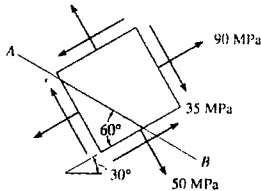

$$\begin{aligned} \sum F_{y'} = 0 \quad & \Delta F_{y'} - 50\Delta A \sin 30^\circ \cos 30^\circ - 35\Delta A \sin 30^\circ \cos 60^\circ + \\ & 90\Delta A \cos 30^\circ \sin 30^\circ + 35\Delta A \cos 30^\circ \sin 60^\circ = 0 \\ & \Delta F_{y'} = -34.82\Delta A \end{aligned}$$

$$\begin{aligned} \sum F_{x'} = 0 \quad & \Delta F_{x'} - 50\Delta A \sin 30^\circ \sin 30^\circ + 35\Delta A \sin 30^\circ \sin 60^\circ - \\ & - 90\Delta A \cos 30^\circ \cos 30^\circ + 35\Delta A \cos 30^\circ \cos 60^\circ = 0 \\ & \Delta F_{x'} = 49.69 \Delta A \end{aligned}$$

$$\sigma_{x'} = \lim_{\Delta A \rightarrow 0} \frac{\Delta F_{x'}}{\Delta A} = 49.7 \text{ MPa} \quad \text{Ans}$$

$$\tau_{x'y'} = \lim_{\Delta A \rightarrow 0} \frac{\Delta F_{y'}}{\Delta A} = -34.8 \text{ MPa} \quad \text{Ans}$$

The negative signs indicate that the sense of $\sigma_{x'}$ and $\tau_{x'y'}$ are opposite to that shown on FBD.

From *Mechanics of Materials*, Sixth Edition by R. C. Hibbeler, ISBN 0-13-191345-X.
 © 2005 R. C. Hibbeler. Published by Pearson Prentice Hall,
 Pearson Education, Inc., Upper Saddle River, NJ. All rights reserved.
 This material is protected under all copyright laws as they currently exist. No portion of this material may be reproduced, in any form or by any means, without permission in writing from the publisher.

9-7 Solve Prob. 9-2 using the stress-transformation equations developed in Sec. 9.2.

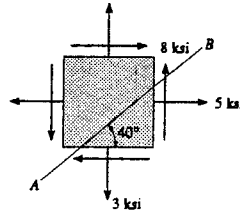

$$\sigma_x = 5 \text{ ksi} \quad \sigma_y = 3 \text{ ksi} \quad \tau_{xy} = 8 \text{ ksi} \quad \theta = 130^\circ$$

$$\sigma_{x'} = \frac{\sigma_x + \sigma_y}{2} + \frac{\sigma_x - \sigma_y}{2} \cos 2\theta + \tau_{xy} \sin 2\theta$$

$$= \frac{5+3}{2} + \frac{5-3}{2} \cos 260^\circ + 8 \sin 260^\circ = -4.05 \text{ ksi} \quad \text{Ans}$$

The negative sign indicates $\sigma_{x'}$ is a compressive stress.

$$\tau_{x'y'} = -\frac{\sigma_x - \sigma_y}{2} \sin 2\theta + \tau_{xy} \cos 2\theta$$

$$= -\left(\frac{5-3}{2}\right) \sin 260^\circ + 8 \cos 260^\circ = -0.404 \text{ ksi} \quad \text{Ans}$$

The negative sign indicates $\tau_{x'y'}$ is in the $-y'$ direction.

From *Mechanics of Materials*, Sixth Edition by R. C. Hibbeler, ISBN 0-13-191345-X.
 © 2005 R. C. Hibbeler. Published by Pearson Prentice Hall,
 Pearson Education, Inc., Upper Saddle River, NJ. All rights reserved.
 This material is protected under all copyright laws as they currently exist. No portion of this material may be reproduced, in any form or by any means, without permission in writing from the publisher.

*9-8 Solve Prob. 9-4 using the stress-transformation equations developed in Sec. 9.2.

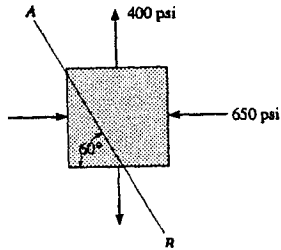

$$\begin{aligned} \sigma_x &= -650 \text{ psi} & \sigma_y &= 400 \text{ psi} & \tau_{xy} &= 0 & \theta &= 30^\circ \\ \sigma_{x'} &= \frac{\sigma_x + \sigma_y}{2} + \frac{\sigma_x - \sigma_y}{2} \cos 2\theta + \tau_{xy} \sin 2\theta \\ &= \frac{-650 + 400}{2} + \frac{-650 - 400}{2} \cos 60^\circ + 0 = -388 \text{ psi} \quad \text{Ans} \end{aligned}$$

The negative sign indicates $\sigma_{x'}$ is a compressive stress.

$$\begin{aligned} \tau_{x'y'} &= -\frac{\sigma_x - \sigma_y}{2} \sin 2\theta + \tau_{xy} \cos 2\theta \\ &= -\left(\frac{-650 - 400}{2}\right) \sin 60^\circ = 455 \text{ psi} \quad \text{Ans} \end{aligned}$$

From *Mechanics of Materials*, Sixth Edition by R. C. Hibbeler, ISBN 0-13-191345-X.

© 2005 R. C. Hibbeler. Published by Pearson Prentice Hall,

Pearson Education, Inc., Upper Saddle River, NJ. All rights reserved.

This material is protected under all copyright laws as they currently exist. No portion of this material may be reproduced, in any form or by any means, without permission in writing from the publisher.

9-9 Solve Prob. 9-6 using the stress-transformation equations developed in Sec. 9.2.

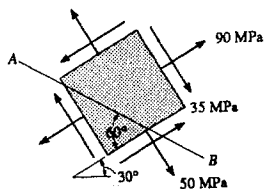

$$\sigma_x = 90 \text{ MPa} \quad \sigma_y = 50 \text{ MPa} \quad \tau_{xy} = -35 \text{ MPa} \quad \theta = -150^\circ$$

$$\begin{aligned} \sigma_{x'} &= \frac{\sigma_x + \sigma_y}{2} + \frac{\sigma_x - \sigma_y}{2} \cos 2\theta + \tau_{xy} \sin 2\theta \\ &= \frac{90 + 50}{2} + \frac{90 - 50}{2} \cos(-300^\circ) + (-35) \sin(-300^\circ) \\ &= 49.7 \text{ MPa} \quad \text{Ans} \end{aligned}$$

$$\begin{aligned} \tau_{x'y'} &= -\frac{\sigma_x - \sigma_y}{2} \sin 2\theta + \tau_{xy} \cos 2\theta \\ &= -\left(\frac{90 - 50}{2}\right) \sin(-300^\circ) + (-35) \cos(-300^\circ) = -34.8 \text{ MPa} \quad \text{Ans} \end{aligned}$$

The negative sign indicates $\tau_{x'y'}$ acts in $-y'$ direction.

From *Mechanics of Materials*, Sixth Edition by R. C. Hibbeler, ISBN 0-13-191345-X.

© 2005 R. C. Hibbeler. Published by Pearson Prentice Hall,

Pearson Education, Inc., Upper Saddle River, NJ. All rights reserved.

This material is protected under all copyright laws as they currently exist. No portion of this material may be reproduced, in any form or by any means, without permission in writing from the publisher.

9-10 Determine the equivalent state of stress on an element if the element is oriented 30° clockwise from the element shown. Use the stress-transformation equations.

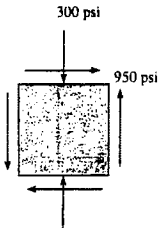

$$\sigma_x = 0 \quad \sigma_y = -300 \text{ psi} \quad \tau_{xy} = 950 \text{ psi} \quad \theta = -30^\circ$$

$$\begin{aligned} \sigma_{x'} &= \frac{\sigma_x + \sigma_y}{2} + \frac{\sigma_x - \sigma_y}{2} \cos 2\theta + \tau_{xy} \sin 2\theta \\ &= \frac{0 - 300}{2} + \frac{0 - (-300)}{2} \cos (-60^\circ) + 950 \sin (-60^\circ) = -898 \text{ psi} \quad \text{Ans} \end{aligned}$$

$$\begin{aligned} \tau_{x'y'} &= -\left(\frac{\sigma_x - \sigma_y}{2}\right) \sin 2\theta + \tau_{xy} \cos 2\theta \\ &= -\left(\frac{0 - (-300)}{2}\right) \sin (-60^\circ) + 950 \cos (-60^\circ) = 605 \text{ psi} \quad \text{Ans} \end{aligned}$$

$$\begin{aligned} \sigma_{y'} &= \frac{\sigma_x + \sigma_y}{2} - \frac{\sigma_x - \sigma_y}{2} \cos 2\theta - \tau_{xy} \sin 2\theta \\ &= \frac{0 - 300}{2} - \left(\frac{0 - (-300)}{2}\right) \cos (-60^\circ) - 950 \sin (-60^\circ) = 598 \text{ psi} \quad \text{Ans} \end{aligned}$$

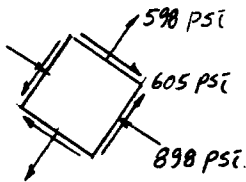

From *Mechanics of Materials*, Sixth Edition by R. C. Hibbeler, ISBN 0-13-191345-X.

© 2005 R. C. Hibbeler. Published by Pearson Prentice Hall,

Pearson Education, Inc., Upper Saddle River, NJ. All rights reserved.

This material is protected under all copyright laws as they currently exist. No portion of this material may be reproduced, in any form or by any means, without permission in writing from the publisher.

9-11. Determine the equivalent state of stress on an element if it is oriented 50° counterclockwise from the element shown. Use the stress-transformation equations.



$$\sigma_x = -10 \text{ ksi} \quad \sigma_y = 0 \quad \tau_{xy} = -16 \text{ ksi}$$

$$\theta = +50^\circ$$

$$\sigma_{x'} = \frac{\sigma_x + \sigma_y}{2} + \frac{\sigma_x - \sigma_y}{2} \cos 2\theta + \tau_{xy} \sin 2\theta$$

$$= \frac{-10 + 0}{2} + \frac{-10 - 0}{2} \cos 100^\circ + (-16) \sin 100^\circ = -19.9 \text{ ksi} \quad \text{Ans}$$

$$\tau_{x'y'} = -\left(\frac{\sigma_x - \sigma_y}{2}\right) \sin 2\theta + \tau_{xy} \cos 2\theta$$

$$= -\left(\frac{-10 - 0}{2}\right) \sin 100^\circ + (-16) \cos 100^\circ = 7.70 \text{ ksi} \quad \text{Ans}$$

$$\sigma_{y'} = \frac{\sigma_x + \sigma_y}{2} - \frac{\sigma_x - \sigma_y}{2} \cos 2\theta - \tau_{xy} \sin 2\theta$$

$$= \frac{-10 + 0}{2} - \left(\frac{-10 - 0}{2}\right) \cos 100^\circ - (-16) \sin 100^\circ = 9.89 \text{ ksi} \quad \text{Ans}$$

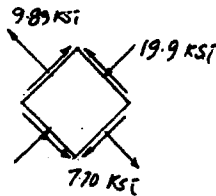

From *Mechanics of Materials*, Sixth Edition by R. C. Hibbeler, ISBN 0-13-191345-X.

© 2005 R. C. Hibbeler. Published by Pearson Prentice Hall,

Pearson Education, Inc., Upper Saddle River, NJ. All rights reserved.

This material is protected under all copyright laws as they currently exist. No portion of this material may be reproduced, in any form or by any means, without permission in writing from the publisher.

*9-12 Solve Prob. 9-6 using the stress-transformation equations.

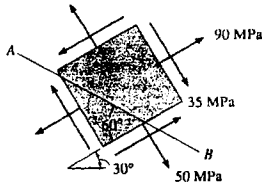

$$\theta = 120^\circ \quad \sigma_x = 50 \text{ MPa} \quad \sigma_y = 90 \text{ MPa} \quad \tau_{xy} = 35 \text{ MPa}$$

$$\begin{aligned} \sigma_{x'} &= \frac{\sigma_x + \sigma_y}{2} + \frac{\sigma_x - \sigma_y}{2} \cos 2\theta + \tau_{xy} \sin 2\theta \\ &= \frac{50 + 90}{2} + \frac{50 - 90}{2} \cos 240^\circ + (35) \sin 240^\circ \\ &= 49.7 \text{ MPa} \end{aligned}$$

Ans

The negative sign indicates $\sigma_{x'}$ is a compressive stress

$$\begin{aligned} \tau_{x'y'} &= -\frac{\sigma_x - \sigma_y}{2} \sin 2\theta + \tau_{xy} \cos 2\theta \\ &= -\frac{50 - 90}{2} \sin 240^\circ + (35) \cos 240^\circ = -34.8 \text{ MPa} \end{aligned}$$

Ans

From *Mechanics of Materials*, Sixth Edition by R. C. Hibbeler, ISBN 0-13-191345-X.

© 2005 R. C. Hibbeler. Published by Pearson Prentice Hall,

Pearson Education, Inc., Upper Saddle River, NJ. All rights reserved.

This material is protected under all copyright laws as they currently exist. No portion of this material may be reproduced, in any form or by any means, without permission in writing from the publisher.

9-13 The state of stress at a point is shown on the element. Determine (a) the principal stresses and (b) the maximum in-plane shear stress and average normal stress at the point. Specify the orientation of the element in each case.

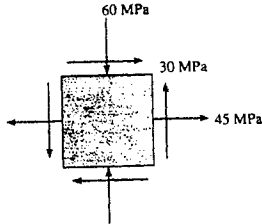

$$\sigma_x = 45 \text{ MPa} \quad \sigma_y = -60 \text{ MPa} \quad \tau_{xy} = 30 \text{ MPa}$$

$$a) \quad \sigma_{1,2} = \frac{\sigma_x + \sigma_y}{2} \pm \sqrt{\left(\frac{\sigma_x - \sigma_y}{2}\right)^2 + \tau_{xy}^2}$$

$$= \frac{45 - 60}{2} \pm \sqrt{\left(\frac{45 - (-60)}{2}\right)^2 + (30)^2}$$

$$\sigma_1 = 53.0 \text{ MPa} \quad \text{Ans} \quad \sigma_2 = -68.0 \text{ MPa} \quad \text{Ans}$$

Orientation of principal stress :

$$\tan 2\theta_p = \frac{\tau_{xy}}{(\sigma_x - \sigma_y)/2} = \frac{30}{(45 - (-60))/2} = 0.5714$$

$$\theta_p = 14.87, \quad -75.13$$

Use Eq. 9-1 to determine the principal plane of σ_1 and σ_2 :

$$\sigma_x = \frac{\sigma_x + \sigma_y}{2} + \frac{\sigma_x - \sigma_y}{2} \cos 2\theta + \tau_{xy} \sin 2\theta, \quad \text{where } \theta = 14.87^\circ$$

$$= \frac{45 + (-60)}{2} + \frac{45 - (-60)}{2} \cos 29.74^\circ + 30 \sin 29.74^\circ = 53.0 \text{ MPa}$$

Therefore $\theta_{p1} = 14.9^\circ$ Ans and $\theta_{p2} = -75.1^\circ$ Ans

b)

$$\tau_{\max} = \sqrt{\left(\frac{\sigma_x - \sigma_y}{2}\right)^2 + \tau_{xy}^2} = \sqrt{\left(\frac{45 - (-60)}{2}\right)^2 + 30^2} = 60.5 \text{ MPa} \quad \text{Ans}$$

$$\sigma_{\text{avg}} = \frac{\sigma_x + \sigma_y}{2} = \frac{45 + (-60)}{2} = -7.50 \text{ MPa} \quad \text{Ans}$$

Orientation of maximum in - plane shear stress :

$$\tan 2\theta_s = \frac{-(\sigma_x - \sigma_y)/2}{\tau_{xy}} = \frac{-(45 - (-60))/2}{30} = -1.75$$

$$\theta_s = -30.1^\circ \quad \text{Ans} \quad \text{and} \quad \theta_s = 59.9^\circ \quad \text{Ans}$$

By observation, in order to preserve equilibrium along AB, τ_{\max} has to act in the direction shown.

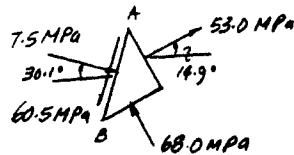
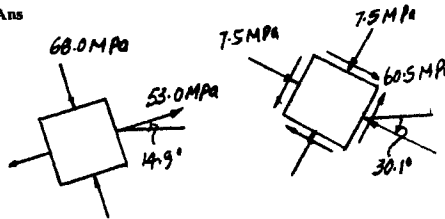

From *Mechanics of Materials*, Sixth Edition by R. C. Hibbeler, ISBN 0-13-191345-X.

© 2005 R. C. Hibbeler. Published by Pearson Prentice Hall,

Pearson Education, Inc., Upper Saddle River, NJ. All rights reserved.

This material is protected under all copyright laws as they currently exist. No portion of this material may be reproduced, in any form or by any means, without permission in writing from the publisher.

9-14 The state of stress at a point is shown on the element. Determine (a) the principal stresses and (b) the maximum in-plane shear stress and average normal stress at the point. Specify the orientation of the element in each case.

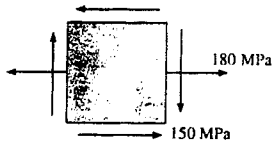

$$\sigma_x = 180 \text{ MPa} \quad \sigma_y = 0 \quad \tau_{xy} = -150 \text{ MPa}$$

$$\begin{aligned} \text{a) } \sigma_{1,2} &= \frac{\sigma_x + \sigma_y}{2} \pm \sqrt{\left(\frac{\sigma_x - \sigma_y}{2}\right)^2 + \tau_{xy}^2} \\ &= \frac{180+0}{2} \pm \sqrt{\left(\frac{180-0}{2}\right)^2 + (-150)^2} \end{aligned}$$

$$\sigma_1 = 265 \text{ MPa} \quad \text{Ans} \quad \sigma_2 = -84.9 \text{ MPa} \quad \text{Ans}$$

Orientation of principal stress :

$$\tan 2\theta_p = \frac{\tau_{xy}}{(\sigma_x - \sigma_y)/2} = \frac{-150}{(180-0)/2} = -1.6667$$

$$\theta_p = 60.482^\circ \quad \text{and} \quad -29.518^\circ$$

Use Eq. 9-1 to determine the principal plane of σ_1 and σ_2 :

$$\sigma_x' = \frac{\sigma_x + \sigma_y}{2} + \frac{\sigma_x - \sigma_y}{2} \cos 2\theta + \tau_{xy} \sin 2\theta, \quad \text{where } \theta = 60.482^\circ$$

$$= \frac{180+0}{2} + \frac{180-0}{2} \cos 2(60.482^\circ) + (-150) \sin 2(60.482^\circ) = -84.9 \text{ MPa}$$

Therefore $\theta_{p1} = 60.5^\circ$ Ans and $\theta_{p2} = -29.5^\circ$ Ans

b)

$$\tau_{\max \text{ in-plane}} = \sqrt{\left(\frac{\sigma_x - \sigma_y}{2}\right)^2 + \tau_{xy}^2} = \sqrt{\left(\frac{180-0}{2}\right)^2 + (-150)^2} = 175 \text{ MPa} \quad \text{Ans}$$

$$\sigma_{\text{avg}} = \frac{\sigma_x + \sigma_y}{2} = \frac{180+0}{2} = 90.0 \text{ MPa} \quad \text{Ans}$$

Orientation of maximum in-plane shear stress :

$$\tan 2\theta_s = \frac{-(\sigma_x - \sigma_y)/2}{\tau_{xy}} = \frac{-(180-0)/2}{-150} = 0.6$$

$$\theta_s = 15.5^\circ \quad \text{Ans} \quad \text{and} \quad \theta = -74.5^\circ \quad \text{Ans}$$

By observation, in order to preserve equilibrium along AB, τ_{\max} has to act in the direction shown.

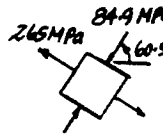

9-15 The state of stress at a point is shown on the element. Determine (a) the principal stresses and (b) the maximum in-plane shear stress and average normal stress at the point. Specify the orientation of the element in each case.

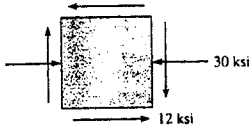

$$\sigma_x = -30 \text{ ksi} \quad \sigma_y = 0 \quad \tau_{xy} = -12 \text{ ksi}$$

a)

$$\sigma_{1,2} = \frac{\sigma_x + \sigma_y}{2} \pm \sqrt{\left(\frac{\sigma_x - \sigma_y}{2}\right)^2 + \tau_{xy}^2} = \frac{-30 + 0}{2} \pm \sqrt{\left(\frac{-30 - 0}{2}\right)^2 + (-12)^2}$$

$$\sigma_1 = 4.21 \text{ ksi} \quad \text{Ans} \quad \sigma_2 = -34.2 \text{ ksi} \quad \text{Ans}$$

Orientation of principal stress :

$$\tan 2\theta_p = \frac{\tau_{xy}}{(\sigma_x - \sigma_y)/2} = \frac{-12}{(-30 - 0)/2} = 0.8$$

$$\theta_p = 19.33^\circ \quad \text{and} \quad -70.67^\circ$$

Use Eq. 9-1 to determine the principal plane of σ_1 and σ_2 .

$$\sigma_1 = \frac{\sigma_x + \sigma_y}{2} + \frac{\sigma_x - \sigma_y}{2} \cos 2\theta + \tau_{xy} \sin 2\theta$$

$$\theta = 19.33^\circ$$

$$\sigma_1 = \frac{-30 + 0}{2} + \frac{-30 - 0}{2} \cos 2(19.33^\circ) + (-12) \sin 2(19.33^\circ) = -34.2 \text{ ksi}$$

$$\text{Therefore } \theta_{\sigma_1} = 19.3^\circ \quad \text{Ans} \quad \text{and } \theta_{\sigma_2} = -70.7^\circ \quad \text{Ans}$$

b)

$$\tau_{\max, \text{in-plane}} = \sqrt{\left(\frac{\sigma_x - \sigma_y}{2}\right)^2 + \tau_{xy}^2} = \sqrt{\left(\frac{-30 - 0}{2}\right)^2 + (-12)^2} = 19.2 \text{ ksi} \quad \text{Ans}$$

$$\sigma_{\text{avg}} = \frac{\sigma_x + \sigma_y}{2} = \frac{-30 + 0}{2} = -15 \text{ ksi} \quad \text{Ans}$$

Orientation of max. in - plane shear stress :

$$\tan 2\theta_s = \frac{-(\sigma_x - \sigma_y)/2}{\tau_{xy}} = \frac{-(-30 - 0)/2}{-12} = -1.25$$

$$\theta_s = -25.7^\circ \quad \text{and} \quad 64.3^\circ \quad \text{Ans}$$

By observation, in order to preserve equilibrium along AB, τ_{\max} has to act in the direction shown in the figure.

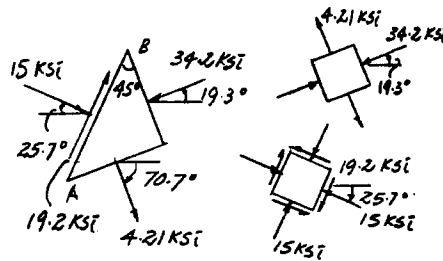

From *Mechanics of Materials*, Sixth Edition by R. C. Hibbeler, ISBN 0-13-191345-X.

© 2005 R. C. Hibbeler. Published by Pearson Prentice Hall,

Pearson Education, Inc., Upper Saddle River, NJ. All rights reserved.

This material is protected under all copyright laws as they currently exist. No portion of this material may be reproduced, in any form or by any means, without permission in writing from the publisher.

*9-16 The state of stress at a point is shown on the element. Determine (a) the principal stresses and (b) the maximum in-plane shear stress and average normal stress at the point. Specify the orientation of the element in each case.

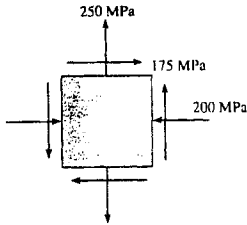

a) $\sigma_x = -200 \text{ MPa}$ $\sigma_y = 250 \text{ MPa}$ $\tau_{xy} = 175 \text{ MPa}$

$$\sigma_{1,2} = \frac{\sigma_x + \sigma_y}{2} \pm \sqrt{\left(\frac{\sigma_x - \sigma_y}{2}\right)^2 + \tau_{xy}^2}$$

$$= \frac{-200 + 250}{2} \pm \sqrt{\left(\frac{-200 - 250}{2}\right)^2 + 175^2}$$

$\sigma_1 = 310 \text{ MPa}$ $\sigma_2 = -260 \text{ MPa}$

Orientation of principal stress :

$$\tan 2\theta_p = \frac{\tau_{xy}}{\frac{\sigma_x - \sigma_y}{2}} = \frac{175}{\frac{-200 - 250}{2}} = -0.7777$$

$\theta_p = -18.94^\circ$ and 71.06°

Use Eq. 9-1 to determine the principal plane of σ_1 and σ_2

$$\sigma_{x'} = \frac{\sigma_x + \sigma_y}{2} + \frac{\sigma_x - \sigma_y}{2} \cos 2\theta + \tau_{xy} \sin 2\theta$$

$\theta = \theta_p = -18.94^\circ$

$$\sigma_{x'} = \frac{-200 + 250}{2} + \frac{-200 - 250}{2} \cos(-37.88^\circ) + 175 \sin(-37.88^\circ) = -260 \text{ MPa} = \sigma_2$$

Therefore $\theta_{p_1} = 71.1^\circ$ $\theta_{p_2} = -18.9^\circ$

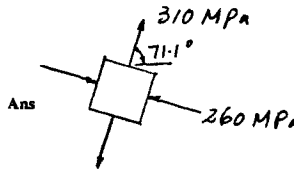

Ans

b) $\tau_{\max \text{ in plane}} = \sqrt{\left(\frac{\sigma_x - \sigma_y}{2}\right)^2 + \tau_{xy}^2} = \sqrt{\left(\frac{-200 - 250}{2}\right)^2 + 175^2} = 285 \text{ MPa}$ Ans

$$\sigma_{s,vs} = \frac{\sigma_x + \sigma_y}{2} = \frac{-200 + 250}{2} = 25.0 \text{ MPa}$$

Orientation of maximum in-plane shear stress :

$$\tan 2\theta_s = -\frac{(\sigma_x - \sigma_y)}{\tau_{xy}} = -\frac{-200 - 250}{175} = 1.2857$$

$\theta_s = 26.1^\circ$ Ans and -63.9°

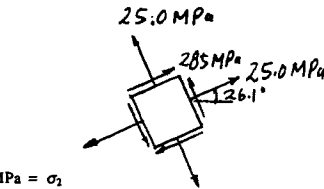

Ans

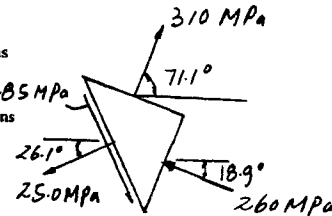

Ans

By observation, in order to preserve equilibrium, $\tau_{\max} = 285 \text{ MPa}$ has to act in the direction shown in the figure.

9-17. A point on a thin plate is subjected to the two successive states of stress shown. Determine the resultant state of stress represented on the element oriented as shown on the right.

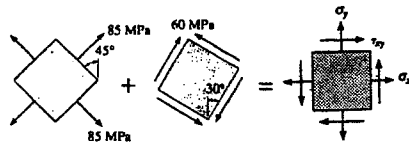

For element a :
 $\sigma_x = \sigma_y = 85 \text{ MPa}$ $\tau_{xy} = 0$ $\theta = -45^\circ$

$$(\sigma_x)_a = \frac{\sigma_x + \sigma_y}{2} + \frac{\sigma_x - \sigma_y}{2} \cos 2\theta + \tau_{xy} \sin 2\theta$$

$$= \frac{85 + 85}{2} + \frac{85 - 85}{2} \cos(-90^\circ) + 0 = 85 \text{ MPa}$$

$$(\sigma_y)_a = \frac{\sigma_x + \sigma_y}{2} - \frac{\sigma_x - \sigma_y}{2} \cos 2\theta - \tau_{xy} \sin 2\theta$$

$$= \frac{85 + 85}{2} - \frac{85 - 85}{2} \cos(-90^\circ) - 0 = 85 \text{ MPa}$$

$$(\tau_{xy})_a = -\frac{\sigma_x - \sigma_y}{2} \sin 2\theta + \tau_{xy} \cos 2\theta$$

$$= -\frac{85 - 85}{2} \sin(-90^\circ) + 0 = 0$$

For element b :
 $\sigma_x = \sigma_y = 0$ $\tau_{xy} = 60 \text{ MPa}$ $\theta = -60^\circ$

$$(\sigma_x)_b = \frac{\sigma_x + \sigma_y}{2} + \frac{\sigma_x - \sigma_y}{2} \cos 2\theta + \tau_{xy} \sin 2\theta$$

$$= 0 + 0 + 60 \sin(-120^\circ) = -51.96 \text{ MPa}$$

$$(\sigma_y)_b = \frac{\sigma_x + \sigma_y}{2} - \frac{\sigma_x - \sigma_y}{2} \cos 2\theta - \tau_{xy} \sin 2\theta$$

$$= 0 - 0 - 60 \sin(-120^\circ) = 51.96 \text{ MPa}$$

$$(\tau_{xy})_b = -\frac{\sigma_x - \sigma_y}{2} \sin 2\theta + \tau_{xy} \cos 2\theta$$

$$= -\frac{85 - 85}{2} \sin(-120^\circ) + 60 \cos(-120^\circ) = -30 \text{ MPa}$$

$$\sigma_x = (\sigma_x)_a + (\sigma_x)_b = 85 + (-51.96) = 33.0 \text{ MPa} \quad \text{Ans}$$

$$\sigma_y = (\sigma_y)_a + (\sigma_y)_b = 85 + 51.96 = 137 \text{ MPa} \quad \text{Ans}$$

$$\tau_{xy} = (\tau_{xy})_a + (\tau_{xy})_b = 0 + (-30) = -30 \text{ MPa} \quad \text{Ans}$$

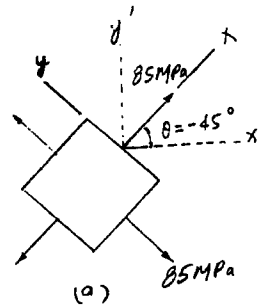

+

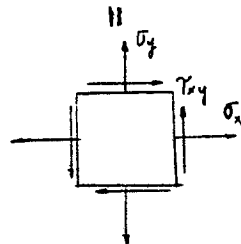
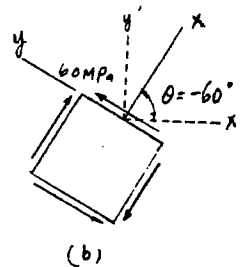

From *Mechanics of Materials*, Sixth Edition by R. C. Hibbeler, ISBN 0-13-191345-X.

© 2005 R. C. Hibbeler. Published by Pearson Prentice Hall,

Pearson Education, Inc., Upper Saddle River, NJ. All rights reserved.

This material is protected under all copyright laws as they currently exist. No portion of this material may be reproduced, in any form or by any means, without permission in writing from the publisher.

9-18 A point on a thin plate is subjected to the two successive states of stress shown. Determine the resultant state of stress represented on the element oriented as shown on the right.

For element a :

$$\sigma_x = \frac{\sigma_x + \sigma_y}{2} + \frac{\sigma_x - \sigma_y}{2} \cos 2\theta + \tau_{xy} \sin 2\theta$$

$$-200 = 0.5(\sigma_x)_a + 0.5(\sigma_y)_a + 0.25(\sigma_x)_a - 0.25(\sigma_y)_a + 0.8660(\tau_{xy})_a$$

$$-200 = 0.75(\sigma_x)_a + 0.25(\sigma_y)_a + 0.866(\tau_{xy})_a \quad (1)$$

$$-350 = 0.5(\sigma_x)_a + 0.5(\sigma_y)_a + 0.25(\sigma_y)_a - 0.25(\sigma_x)_a - 0.8660(\tau_{xy})_a$$

$$-350 = 0.25(\sigma_x)_a + 0.75(\sigma_y)_a - 0.866(\tau_{xy})_a \quad (2)$$

$$\tau_{x'y'} = -\frac{\sigma_x - \sigma_y}{2} \sin 2\theta + \tau_{xy} \cos 2\theta$$

$$0 = -0.4330(\sigma_x)_a + 0.4330(\sigma_y)_a + 0.5(\tau_{xy})_a \quad (3)$$

Solving Eqs. (1), (2), and (3) yields :

$$(\sigma_x)_a = -237.5 \text{ MPa}$$

$$(\sigma_y)_a = -312.5 \text{ MPa}$$

$$(\tau_{xy})_a = 64.95 \text{ MPa}$$

For element b :

$$\sigma_x = \frac{\sigma_x + \sigma_y}{2} + \frac{\sigma_x - \sigma_y}{2} \cos 2\theta + \tau_{xy} \sin 2\theta$$

$$\sigma_x = 0 \quad \theta = -25^\circ$$

$$0 = 0.5(\sigma_x)_b + 0.5(\sigma_y)_b + 0.3214(\sigma_x)_b - 0.3214(\sigma_y)_b - 0.7660(\tau_{xy})_b$$

$$0 = 0.8214(\sigma_x)_b + 0.1768(\sigma_y)_b - 0.7660(\tau_{xy})_b \quad (4)$$

$$\sigma_x = 0 \quad \theta = 65^\circ$$

$$0 = 0.5(\sigma_x)_b + 0.5(\sigma_y)_b - 0.3214(\sigma_x)_b + 0.3214(\sigma_y)_b + 0.766(\tau_{xy})_b$$

$$0 = 0.1786(\sigma_x)_b + 0.8214(\sigma_y)_b + 0.766(\tau_{xy})_b \quad (5)$$

$$\tau_{x'y'} = -\frac{\sigma_x - \sigma_y}{2} \sin 2\theta + \tau_{xy} \cos 2\theta$$

$$\theta = -25^\circ \quad \tau_{x'y'} = 58 \text{ MPa}$$

$$58 = 0.3830(\sigma_x)_b - 0.3830(\sigma_y)_b + 0.6428(\tau_{xy})_b \quad (6)$$

Solving Eqs. (4), (5), and (6) yields :

$$(\sigma_x)_b = 44.43 \text{ MPa}$$

$$(\sigma_y)_b = -44.43 \text{ MPa}$$

$$(\tau_{xy})_b = 37.28 \text{ MPa}$$

$$\sigma_x = (\sigma_x)_a + (\sigma_x)_b$$

$$= -237.5 + 44.43 = -193 \text{ MPa} \quad \text{Ans}$$

$$\sigma_y = (\sigma_y)_a + (\sigma_y)_b$$

$$= -312.5 - 44.43 = -357 \text{ MPa} \quad \text{Ans}$$

$$\tau_{xy} = (\tau_{xy})_a + (\tau_{xy})_b$$

$$= 64.95 + 37.28 = 102 \text{ MPa} \quad \text{Ans}$$

Note : This problem can also be solved by using $\sigma_x = -200 \text{ MPa}$

$$\sigma_y = -350 \text{ MPa}, \tau_{xy} = 0, \text{ and } \theta = -30^\circ$$

for element a, and $\sigma_x = 0, \sigma_y = 0, \tau_{xy} = 58 \text{ MPa}$ and

$\theta = 25^\circ$ for element b.

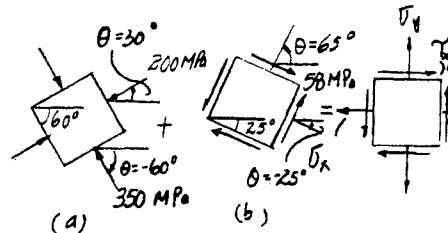
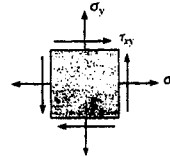
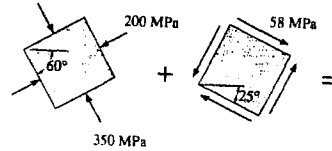

From *Mechanics of Materials*, Sixth Edition by R. C. Hibbeler, ISBN 0-13-191345-X.

© 2005 R. C. Hibbeler. Published by Pearson Prentice Hall,

Pearson Education, Inc., Upper Saddle River, NJ. All rights reserved.

This material is protected under all copyright laws as they currently exist. No portion of this material may be reproduced, in any form or by any means, without permission in writing from the publisher.

9-19 The stress along two planes at a point is indicated. Determine the normal stresses on plane $b-b$ and the principal stresses.

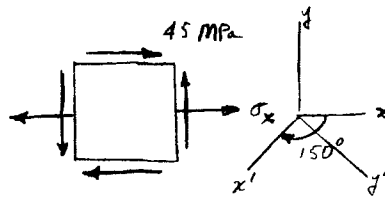
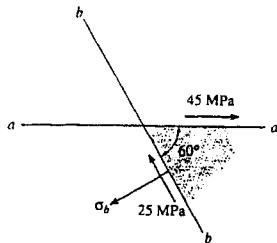

$$\tau_b = -\frac{\sigma_x - \sigma_y}{2} \sin 2\theta + \tau_{xy} \cos 2\theta$$

$$-25 = -\frac{(\sigma_x - 0)}{2} \sin(-300^\circ) + 45 \cos(-300^\circ)$$

$$\sigma_x = 109.70 \text{ MPa}$$

$$\sigma_b = \frac{\sigma_x + \sigma_y}{2} + \frac{\sigma_x - \sigma_y}{2} \cos 2\theta + \tau_{xy} \sin 2\theta$$

$$= \frac{109.70 + 0}{2} + \frac{109.70 - 0}{2} \cos(-300^\circ) + 45 \sin(-300^\circ)$$

$$\sigma_b = 121 \text{ MPa} \quad \text{Ans}$$

$$\sigma_{1,2} = \frac{\sigma_x + \sigma_y}{2} \pm \sqrt{\left(\frac{\sigma_x - \sigma_y}{2}\right)^2 + \tau_{xy}^2}$$

$$= \frac{109.70 + 0}{2} \pm \sqrt{\left(\frac{109.70 - 0}{2}\right)^2 + (45)^2}$$

$$\sigma_1 = 126 \text{ MPa} \quad \text{Ans}$$

$$\sigma_2 = -16.1 \text{ MPa} \quad \text{Ans}$$

From *Mechanics of Materials*, Sixth Edition by R. C. Hibbeler, ISBN 0-13-191345-X.

© 2005 R. C. Hibbeler. Published by Pearson Prentice Hall,

Pearson Education, Inc., Upper Saddle River, NJ. All rights reserved.

This material is protected under all copyright laws as they currently exist. No portion of this material may be reproduced, in any form or by any means, without permission in writing from the publisher.

***9-20.** The stress acting on two planes at a point is indicated. Determine the shear stress on plane *a-a* and the principal stresses at the point.

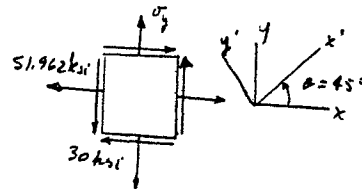
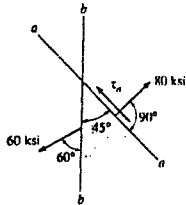

$$\sigma_x = 60 \sin 60^\circ = 51.962 \text{ ksi}$$

$$\tau_{xy} = 60 \cos 60^\circ = 30 \text{ ksi}$$

$$\sigma_a = \frac{\sigma_x + \sigma_y}{2} + \frac{\sigma_x - \sigma_y}{2} \cos 2\theta + \tau_{xy} \sin 2\theta$$

$$80 = \frac{51.962 + \sigma_y}{2} + \frac{51.962 - \sigma_y}{2} \cos (90^\circ) + 30 \sin (90^\circ)$$

$$\sigma_y = 48.038 \text{ ksi}$$

$$\tau_a = -\left(\frac{\sigma_x - \sigma_y}{2}\right) \sin 2\theta + \tau_{xy} \cos \theta$$

$$= -\left(\frac{51.962 - 48.038}{2}\right) \sin (90^\circ) + 30 \cos (90^\circ)$$

$$\tau_a = -1.96 \text{ ksi} \quad \text{Ans}$$

$$\sigma_{1,2} = \frac{\sigma_x + \sigma_y}{2} \pm \sqrt{\left(\frac{\sigma_x - \sigma_y}{2}\right)^2 + \tau_{xy}^2}$$

$$= \frac{51.962 + 48.038}{2} \pm \sqrt{\left(\frac{51.962 - 48.038}{2}\right)^2 + (30)^2}$$

$$\sigma_1 = 80.1 \text{ ksi} \quad \text{Ans}$$

$$\sigma_2 = 19.9 \text{ ksi} \quad \text{Ans}$$

From *Mechanics of Materials*, Sixth Edition by R. C. Hibbeler, ISBN 0-13-191345-X.

© 2005 R. C. Hibbeler. Published by Pearson Prentice Hall,

Pearson Education, Inc., Upper Saddle River, NJ. All rights reserved.

This material is protected under all copyright laws as they currently exist. No portion of this material may be reproduced, in any form or by any means, without permission in writing from the publisher.

9-21. The stress acting on two planes at a point is indicated. Determine the normal stress σ_b and the principal stresses at the point.

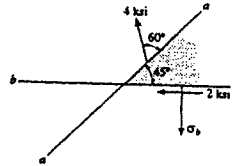

Stress Transformation Equations : Applying Eqs. 9-3 and 9-1 with $\theta = -135^\circ$, $\sigma_x = 3.464$ ksi, $\tau_{xy} = 2.00$ ksi, $\tau_{x'y'} = -2$ ksi, and $\sigma_{x'} = \sigma_b$,

$$\begin{aligned}\tau_{x'y'} &= -\frac{\sigma_x - \sigma_y}{2} \sin 2\theta + \tau_{xy} \cos 2\theta \\ -2 &= -\frac{\sigma_x - 3.464}{2} \sin (-270^\circ) + 2 \cos (-270^\circ) \\ \sigma_x &= 7.464 \text{ ksi}\end{aligned}$$

$$\begin{aligned}\sigma_{x'} &= \frac{\sigma_x + \sigma_y}{2} + \frac{\sigma_x - \sigma_y}{2} \cos 2\theta + \tau_{xy} \sin 2\theta \\ \sigma_b &= \frac{7.464 + 3.464}{2} + \frac{7.464 - 3.464}{2} \cos (-270^\circ) + 2 \sin (-270^\circ) \\ &= 7.46 \text{ ksi} \quad \text{Ans}\end{aligned}$$

In - Plane Principal Stress : Applying Eq. 9-5,

$$\begin{aligned}\sigma_{1,2} &= \frac{\sigma_x + \sigma_y}{2} \pm \sqrt{\left(\frac{\sigma_x - \sigma_y}{2}\right)^2 + \tau_{xy}^2} \\ &= \frac{7.464 + 3.464}{2} \pm \sqrt{\left(\frac{7.464 - 3.464}{2}\right)^2 + 2^2} \\ &= 5.464 \pm 2.828\end{aligned}$$

$$\sigma_1 = 8.29 \text{ ksi} \quad \sigma_2 = 2.64 \text{ ksi} \quad \text{Ans}$$

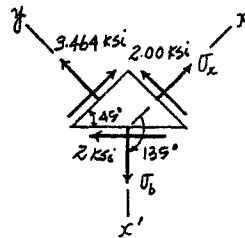

From *Mechanics of Materials*, Sixth Edition by R. C. Hibbeler, ISBN 0-13-191345-X.

© 2005 R. C. Hibbeler. Published by Pearson Prentice Hall,

Pearson Education, Inc., Upper Saddle River, NJ. All rights reserved.

This material is protected under all copyright laws as they currently exist. No portion of this material may be reproduced, in any form or by any means, without permission in writing from the publisher.

9-22. The wood beam is subjected to a load of 12 kN. If grains of wood in the beam at point A make an angle of 25° with the horizontal as shown, determine the normal and shear stress that act perpendicular to the grains due to the loading.

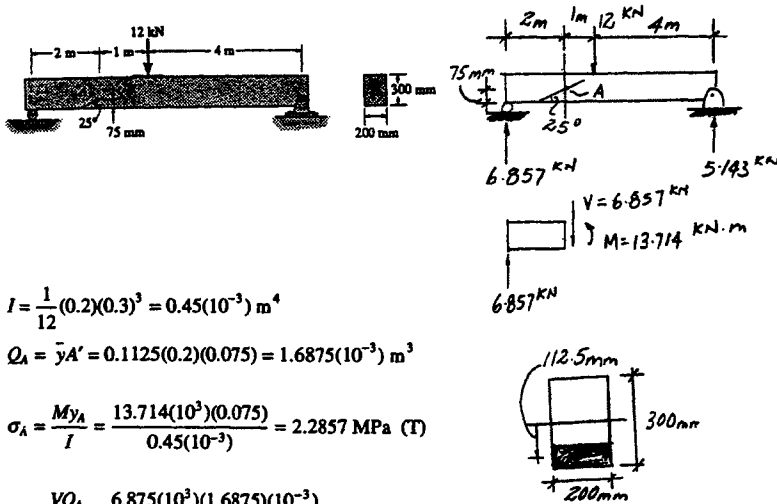

$$I = \frac{1}{12}(0.2)(0.3)^3 = 0.45(10^{-3}) \text{ m}^4$$

$$Q_A = \bar{y}A' = 0.1125(0.2)(0.075) = 1.6875(10^{-3}) \text{ m}^3$$

$$\sigma_A = \frac{My_A}{I} = \frac{13.714(10^3)(0.075)}{0.45(10^{-3})} = 2.2857 \text{ MPa (T)}$$

$$\tau_A = \frac{VQ_A}{It} = \frac{6.875(10^3)(1.6875)(10^{-3})}{0.45(10^{-3})(0.2)} = 0.1286 \text{ MPa}$$

$$\sigma_x = 2.2857 \text{ MPa} \quad \sigma_y = 0 \quad \tau_{xy} = -0.1286 \text{ MPa} \quad \theta = 115^\circ$$

$$\sigma_{x'} = \frac{\sigma_x + \sigma_y}{2} + \frac{\sigma_x - \sigma_y}{2} \cos 2\theta + \tau_{xy} \sin 2\theta$$

$$\sigma_{x'} = \frac{2.2857 + 0}{2} + \frac{2.2857 - 0}{2} \cos 230^\circ + (-0.1286) \sin 230^\circ$$

$$= 0.507 \text{ MPa} \quad \text{Ans}$$

$$\tau_{x'y'} = -\frac{\sigma_x - \sigma_y}{2} \sin 2\theta + \tau_{xy} \cos 2\theta$$

$$= -\left(\frac{2.2857 - 0}{2}\right) \sin 230^\circ + (-0.1286) \cos 230^\circ$$

$$= 0.958 \text{ MPa} \quad \text{Ans}$$

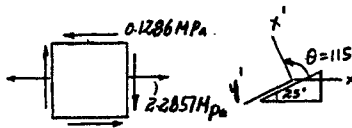

From *Mechanics of Materials*, Sixth Edition by R. C. Hibbeler, ISBN 0-13-191345-X.

© 2005 R. C. Hibbeler. Published by Pearson Prentice Hall,

Pearson Education, Inc., Upper Saddle River, NJ. All rights reserved.

This material is protected under all copyright laws as they currently exist. No portion of this material may be reproduced, in any form or by any means, without permission in writing from the publisher.

9-23. The wood beam is subjected to a distributed loading. Determine the principal stresses at point A and specify the orientation of the element.

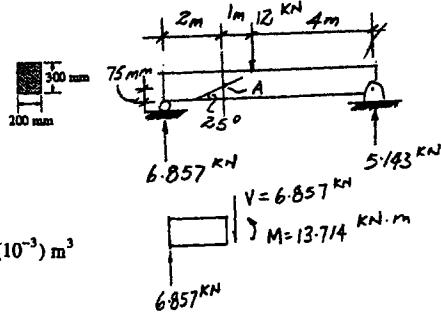
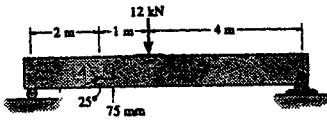

$$I = \frac{1}{12}(0.2)(0.3)^3 = 0.45(10^{-3}) \text{ m}^4$$

$$Q_A = \bar{y}A' = 0.1125(0.2)(0.075) = 1.6875(10^{-3}) \text{ m}^3$$

$$\sigma_A = \frac{My_A}{I} = \frac{13.714(10^3)(0.075)}{0.45(10^{-3})} = 2.2857 \text{ MPa (T)}$$

$$\tau_A = \frac{VQ_A}{It} = \frac{6.875(10^3)(1.6875)(10^{-3})}{0.45(10^{-3})(0.2)} = 0.1286 \text{ MPa}$$

$$\sigma_x = 2.2857 \text{ MPa} \quad \sigma_y = 0 \quad \tau_{xy} = -0.1286 \text{ MPa}$$

$$\sigma_{1,2} = \frac{\sigma_x + \sigma_y}{2} \pm \sqrt{\left(\frac{\sigma_x - \sigma_y}{2}\right)^2 + \tau_{xy}^2}$$

$$= \frac{2.2857 + 0}{2} \pm \sqrt{\left(\frac{2.2857 - 0}{2}\right)^2 + (-0.1286)^2}$$

$$\sigma_1 = 2.29 \text{ MPa} \quad \text{Ans}$$

$$\sigma_2 = -7.20 \text{ kPa} \quad \text{Ans}$$

$$\tan 2\theta_p = \frac{\tau_{xy}}{(\sigma_x - \sigma_y)/2} = \frac{-0.1286}{(2.2857 - 0)/2}$$

$$\theta_p = -3.21^\circ$$

Check direction of principal stress :

$$\sigma_{x'} = \frac{\sigma_x + \sigma_y}{2} + \frac{\sigma_x - \sigma_y}{2} \cos 2\theta + \tau_{xy} \sin 2\theta$$

$$= \frac{2.2857 + 0}{2} + \frac{2.2857 - 0}{2} \cos(-6.42^\circ) - 0.1285 \sin(-6.42)$$

$$= 2.29 \text{ MPa}$$

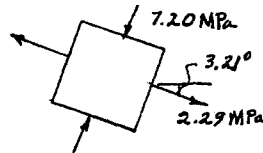
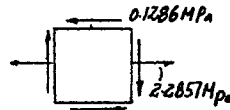
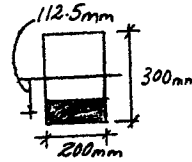

From *Mechanics of Materials*, Sixth Edition by R. C. Hibbeler, ISBN 0-13-191345-X.

© 2005 R. C. Hibbeler. Published by Pearson Prentice Hall,

Pearson Education, Inc., Upper Saddle River, NJ. All rights reserved.

This material is protected under all copyright laws as they currently exist. No portion of this material may be reproduced, in any form or by any means, without permission in writing from the publisher.

*9-24. The grains of wood in the board make an angle of 20° with the horizontal as shown. Determine the normal and shear stress that act perpendicular to the grains if the board is subjected to an axial load of 250 N.

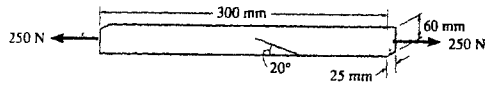

$$\sigma_x = \frac{P}{A} = \frac{250}{(0.06)(0.025)} = 166.67 \text{ kPa}$$

$$\sigma_y = 0 \quad \tau_{xy} = 0$$

$$\theta = 110^\circ$$

$$\sigma_{x'} = \frac{\sigma_x + \sigma_y}{2} + \frac{\sigma_x - \sigma_y}{2} \cos 2\theta + \tau_{xy} \sin 2\theta$$

$$= \frac{166.67 + 0}{2} + \frac{166.67 - 0}{2} \cos 220^\circ + 0 = 19.5 \text{ kPa} \quad \text{Ans}$$

$$\tau_{x'y'} = -\left(\frac{\sigma_x - \sigma_y}{2}\right) \sin 2\theta + \tau_{xy} \cos 2\theta$$

$$= -\left(\frac{166.67 - 0}{2}\right) \sin 220^\circ + 0 = 53.6 \text{ kPa} \quad \text{Ans}$$

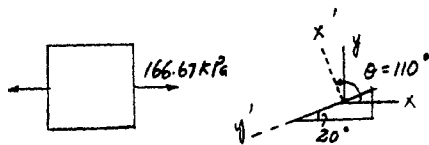

From *Mechanics of Materials*, Sixth Edition by R. C. Hibbeler, ISBN 0-13-191345-X.

© 2005 R. C. Hibbeler. Published by Pearson Prentice Hall,

Pearson Education, Inc., Upper Saddle River, NJ. All rights reserved.

This material is protected under all copyright laws as they currently exist. No portion of this material may be reproduced, in any form or by any means, without permission in writing from the publisher.

9-25 The wooden block will fail if the shear stress acting along the grain is 550 psi. If the normal stress $\sigma_x = 400$ psi, determine the necessary compressive stress σ_y that will cause failure.

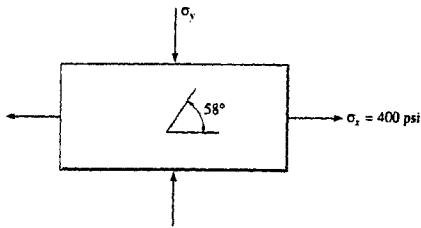

$$\tau_{x'y'} = -\left(\frac{\sigma_x - \sigma_y}{2}\right) \sin 2\theta + \tau_{xy} \cos 2\theta$$

$$550 = -\left(\frac{400 - \sigma_y}{2}\right) \sin 296^\circ + 0$$

$$\sigma_y = -824 \text{ psi} \quad \text{Ans}$$

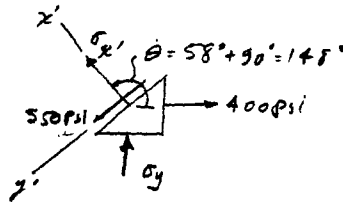

From *Mechanics of Materials*, Sixth Edition by R. C. Hibbeler, ISBN 0-13-191345-X.

© 2005 R. C. Hibbeler. Published by Pearson Prentice Hall,

Pearson Education, Inc., Upper Saddle River, NJ. All rights reserved.

This material is protected under all copyright laws as they currently exist. No portion of this material may be reproduced, in any form or by any means, without permission in writing from the publisher.

9-26. The square steel plate has a thickness of 10 mm and is subjected to the edge loading shown. Determine the maximum in-plane shear stress and the average normal stress developed in the steel.

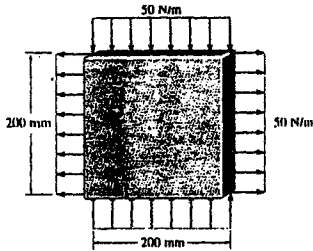

$$\sigma_x = 5 \text{ kPa} \quad \sigma_y = -5 \text{ kPa} \quad \tau_{xy} = 0$$

$$\begin{aligned} \tau_{\max \text{ in-plane}} &= \sqrt{\left(\frac{\sigma_x - \sigma_y}{2}\right)^2 + \tau_{xy}^2} \\ &= \sqrt{\left(\frac{5 + 5}{2}\right)^2 + 0} = 5 \text{ kPa} \quad \text{Ans} \end{aligned}$$

$$\sigma_{avg} = \frac{\sigma_x + \sigma_y}{2} = \frac{5 - 5}{2} = 0 \quad \text{Ans}$$

Note :

$$\tan 2\theta_s = \frac{-(\sigma_x - \sigma_y)/2}{\tau_{xy}}$$

$$\tan 2\theta_s = \frac{-(-5 + 5)/2}{0} = \infty$$

$$\theta_s = 45^\circ$$

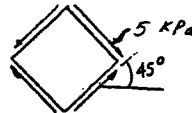
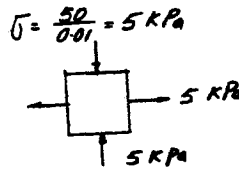

From *Mechanics of Materials*, Sixth Edition by R. C. Hibbeler, ISBN 0-13-191345-X.
 © 2005 R. C. Hibbeler. Published by Pearson Prentice Hall,
 Pearson Education, Inc., Upper Saddle River, NJ. All rights reserved.
 This material is protected under all copyright laws as they currently exist. No portion of this material may be reproduced, in any form or by any means, without permission in writing from the publisher.

9-27 The square steel plate has a thickness of 0.5 in. and is subjected to the edge loading shown. Determine the principal stresses developed in the steel.

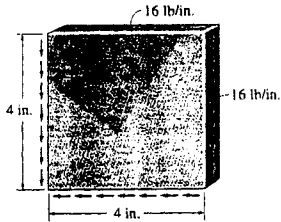

$$\sigma_x = 0 \quad \sigma_y = 0 \quad \tau_{xy} = 32 \text{ psi}$$

$$\sigma_{1,2} = \frac{\sigma_x + \sigma_y}{2} \pm \sqrt{\left(\frac{\sigma_x - \sigma_y}{2}\right)^2 + \tau_{xy}^2}$$

$$= 0 \pm \sqrt{0 + 32^2}$$

$$\sigma_1 = 32 \text{ psi} \quad \text{Ans}$$

$$\sigma_2 = -32 \text{ psi} \quad \text{Ans}$$

Note:

$$\tan 2\theta_p = \frac{\tau_{xy}}{(\sigma_x - \sigma_y)/2} = \frac{32}{0} = \infty$$

$$\theta_p = 45^\circ$$

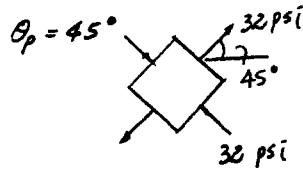
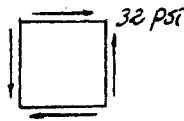

From *Mechanics of Materials*, Sixth Edition by R. C. Hibbeler, ISBN 0-13-191345-X.

© 2005 R. C. Hibbeler. Published by Pearson Prentice Hall,

Pearson Education, Inc., Upper Saddle River, NJ. All rights reserved.

This material is protected under all copyright laws as they currently exist. No portion of this material may be reproduced, in any form or by any means, without permission in writing from the publisher.

*9-28 The simply supported beam is subjected to the traction stress τ_0 on its top surface. Determine the principal stresses at points A and B.

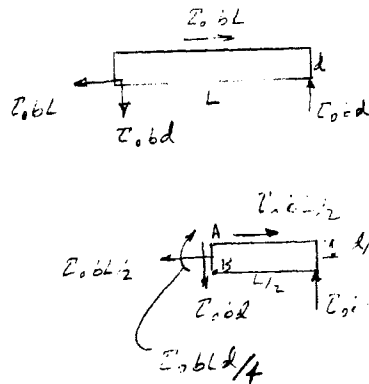
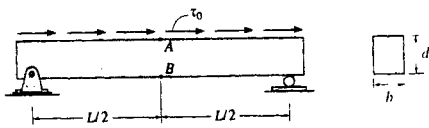

Point A :

$$\sigma_A = \frac{Mc}{I} + \frac{P}{A} = -\frac{(\tau_0 b L d / 4)(d/2)}{\frac{1}{12}(b)(d)^3} + \frac{\tau_0 b L / 2}{bd} = -\frac{\tau_0 L}{d}$$

$$\tau_A = \tau_0$$

Thus,

$$\sigma_{1,2} = \frac{-\tau_0 L}{2d} \pm \sqrt{\left(\frac{\tau_0 L}{2d}\right)^2 + \tau_0^2}$$

$$\sigma_{1,2} = \frac{-\tau_0 L}{2d} \pm \tau_0 \sqrt{\left(\frac{L}{2d}\right)^2 + 1} \quad \text{Ans}$$

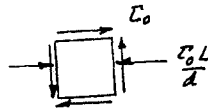

Point B :

$$\sigma_B = \frac{Mc}{I} + \frac{P}{A} = \frac{(\tau_0 b L d / 4)(d/2)}{\frac{1}{12} b d^3} + \frac{\tau_0 b L / 2}{bd} = \frac{2\tau_0 L}{d}$$

$$\tau_B = 0$$

$$\sigma_1 = \frac{2\tau_0 L}{d} \quad \text{Ans}$$

$$\sigma_2 = 0 \quad \text{Ans}$$



From *Mechanics of Materials*, Sixth Edition by R. C. Hibbeler, ISBN 0-13-191345-X.

© 2005 R. C. Hibbeler. Published by Pearson Prentice Hall,

Pearson Education, Inc., Upper Saddle River, NJ. All rights reserved.

This material is protected under all copyright laws as they currently exist. No portion of this material may be reproduced, in any form or by any means, without permission in writing from the publisher.

9-29 The bell crank is pinned at A and supported by a short link BC. If it is subjected to the force of 80 N, determine the principal stresses at (a) point D and (b) point E. The crank is constructed from an aluminum plate having a thickness of 20 mm.

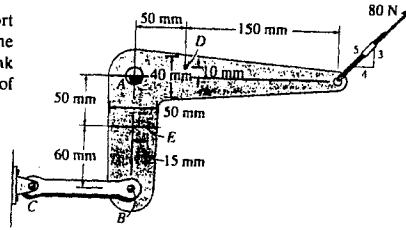

Point D :

$$A = 0.04(0.02) = 0.8(10^{-3}) \text{ m}^2$$

$$I = \frac{1}{12}(0.02)(0.04^3) = 0.1067(10^{-6}) \text{ m}^4$$

$$Q_D = \bar{y}A' = 0.015(0.02)(0.01) = 3(10^{-6}) \text{ m}^3$$

Normal stress :

$$\sigma_D = \frac{P}{A} + \frac{My}{I} = \frac{64}{0.8(10^{-3})} - \frac{7.2(0.01)}{0.1067(10^{-6})} = -0.595 \text{ MPa}$$

Shear stress :

$$\tau_D = \frac{VQ}{It} = \frac{48(3)(10^{-6})}{0.1067(10^{-6})(0.02)} = 0.0675 \text{ MPa}$$

Principal stress : $\sigma_x = -0.595 \text{ MPa}$ $\sigma_y = 0$ $\tau_{xy} = 0.0675 \text{ MPa}$

$$\sigma_{1,2} = \frac{\sigma_x + \sigma_y}{2} \pm \sqrt{\left(\frac{\sigma_x - \sigma_y}{2}\right)^2 + \tau_{xy}^2}$$

$$= \frac{-0.595 + 0}{2} \pm \sqrt{\left(\frac{-0.595 - 0}{2}\right)^2 + 0.0675^2}$$

$$\sigma_1 = 7.56 \text{ kPa} \quad \text{Ans}$$

$$\sigma_2 = -603 \text{ kPa} \quad \text{Ans}$$

Point E :

$$I = \frac{1}{12}(0.02)(0.05^3) = 0.2083(10^{-6}) \text{ m}^4$$

$$Q_E = \bar{y}A' = 0.02(0.01)(0.02) = 4.0(10^{-6}) \text{ m}^3$$

Normal stress :

$$\sigma_E = \frac{My}{I} = \frac{5.2364(0.015)}{0.2083(10^{-6})} = 377.0 \text{ kPa}$$

Shear stress :

$$\tau_E = \frac{VQ}{It} = \frac{87.273(4.0)(10^{-6})}{0.2083(10^{-6})(0.02)} = 83.78 \text{ kPa}$$

Principal stress : $\sigma_x = 0$ $\sigma_y = 377.0 \text{ kPa}$ $\tau_{xy} = 83.78 \text{ kPa}$

$$\sigma_{1,2} = \frac{\sigma_x + \sigma_y}{2} \pm \sqrt{\left(\frac{\sigma_x - \sigma_y}{2}\right)^2 + \tau_{xy}^2}$$

$$= \frac{0 + 377.0}{2} \pm \sqrt{\left(\frac{0 - 377.0}{2}\right)^2 + 83.78^2}$$

$$\sigma_1 = 395 \text{ kPa} \quad \text{Ans}$$

$$\sigma_2 = -17.8 \text{ kPa} \quad \text{Ans}$$

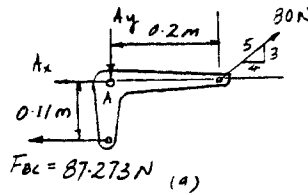

$$F_{bc} = 87.273 \text{ N} \quad (a)$$

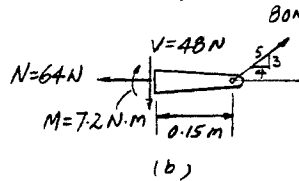

(b)

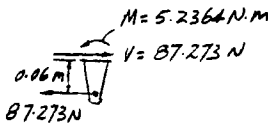

(c)

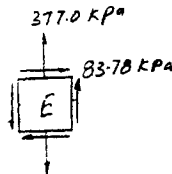
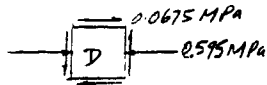

From *Mechanics of Materials*, Sixth Edition by R. C. Hibbeler, ISBN 0-13-191345-X.

© 2005 R. C. Hibbeler. Published by Pearson Prentice Hall,

Pearson Education, Inc., Upper Saddle River, NJ. All rights reserved.

This material is protected under all copyright laws as they currently exist. No portion of this material may be reproduced, in any form or by any means, without permission in writing from the publisher.

9-30 The clamp bears down on the smooth surfaces at C and D when the bolt is tightened. If the tensile force in the bolt is 40 kN, determine the principal stresses at points A and B and show the results on elements located at each of these points. The cross-sectional area at A and B is shown in the adjacent figure.

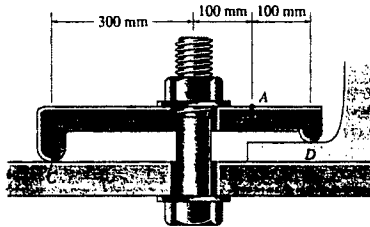
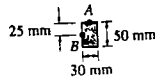

$$I = \frac{1}{12}(0.03)(0.05^3) = 0.3125(10^{-6}) \text{ m}^4$$

$$Q_A = 0$$

$$Q_B = (0.0125)(0.025)(0.03) = 9.375(10^{-6}) \text{ m}^3$$

Point A :

$$\sigma_A = \frac{-Mc}{I} = \frac{-2.4(10^3)(0.025)}{0.3125(10^{-6})} = -192 \text{ MPa}$$

Here,

$$\sigma_1 = 0 \quad \text{Ans}$$

$$\sigma_2 = -192 \text{ MPa} \quad \text{Ans}$$

Point B :

$$\sigma_B = \frac{My}{I} = 0$$

$$\tau_B = \frac{VQ_B}{It} = \frac{24(10^3)(9.375)(10^{-6})}{0.3125(10^{-6})(0.03)} = 24.0 \text{ MPa}$$

$$\sigma_x = 0 \quad \sigma_y = 0 \quad \tau_{xy} = -24 \text{ MPa}$$

$$\sigma_{1,2} = \frac{\sigma_x + \sigma_y}{2} \pm \sqrt{\left(\frac{\sigma_x - \sigma_y}{2}\right)^2 + \tau_{xy}^2}$$

$$= 0 \pm \sqrt{0 + (24)^2}$$

$$\sigma_1 = 24.0 \text{ MPa} \quad \text{Ans}$$

$$\sigma_2 = -24.0 \text{ MPa} \quad \text{Ans}$$

$$\tan 2\theta_p = \frac{\tau_{xy}}{(\sigma_x - \sigma_y)/2} = \frac{24}{0} = \infty$$

$$\theta_p = 45^\circ \quad \text{and} \quad \theta_p = -45^\circ$$

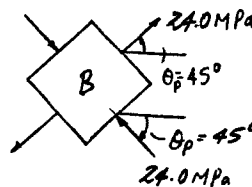
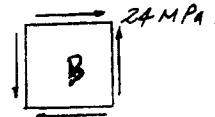
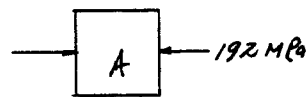
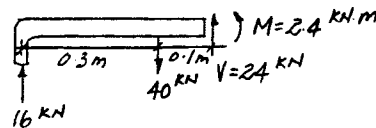
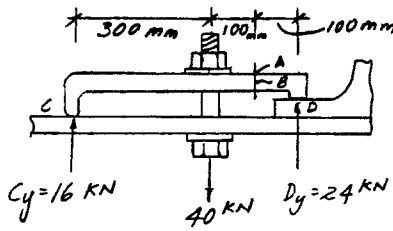

From *Mechanics of Materials*, Sixth Edition by R. C. Hibbeler, ISBN 0-13-191345-X.

© 2005 R. C. Hibbeler. Published by Pearson Prentice Hall,

Pearson Education, Inc., Upper Saddle River, NJ. All rights reserved.

This material is protected under all copyright laws as they currently exist. No portion of this material may be reproduced, in any form or by any means, without permission in writing from the publisher.

9-31 The cantilevered rectangular bar is subjected to the force of 5 kip. Determine the principal stresses at points A and B.

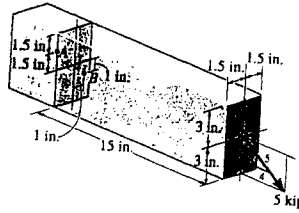

$$I = \frac{1}{12}(3)(6^3) = 54 \text{ in}^4 \quad A = (6)(3) = 18 \text{ in}^2$$

$$Q_A = 2.25(1.5)(3) = 10.125 \text{ in}^3 \quad Q_B = 2(2)(3) = 12 \text{ in}^3$$

Point A:

$$\sigma_A = \frac{P}{A} + \frac{M_x z}{I} = \frac{4}{18} + \frac{45(1.5)}{54} = 1.472 \text{ ksi}$$

$$\tau_A = \frac{V_y Q_A}{I t} = \frac{3(10.125)}{54(3)} = 0.1875 \text{ ksi}$$

$$\sigma_x = 1.472 \text{ ksi} \quad \sigma_y = 0 \quad \tau_{xy} = 0.1875 \text{ ksi}$$

$$\begin{aligned} \sigma_{1,2} &= \frac{\sigma_x + \sigma_y}{2} \pm \sqrt{\left(\frac{\sigma_x - \sigma_y}{2}\right)^2 + \tau_{xy}^2} \\ &= \frac{1.472 + 0}{2} \pm \sqrt{\left(\frac{1.472 - 0}{2}\right)^2 + 0.1875^2} \end{aligned}$$

$$\begin{aligned} \sigma_1 &= 1.50 \text{ ksi} \quad \text{Ans} \\ \sigma_2 &= -0.0235 \text{ ksi} \quad \text{Ans} \end{aligned}$$

Point B:

$$\sigma_B = \frac{P}{A} - \frac{M_x z}{I} = \frac{4}{18} - \frac{45(1)}{54} = -0.6111 \text{ ksi}$$

$$\tau_B = \frac{V_y Q_B}{I t} = \frac{3(12)}{54(3)} = 0.2222 \text{ ksi}$$

$$\sigma_x = -0.6111 \text{ ksi} \quad \sigma_y = 0 \quad \tau_{xy} = 0.2222 \text{ ksi}$$

$$\begin{aligned} \sigma_{1,2} &= \frac{\sigma_x + \sigma_y}{2} \pm \sqrt{\left(\frac{\sigma_x - \sigma_y}{2}\right)^2 + \tau_{xy}^2} \\ &= \frac{-0.611 + 0}{2} \pm \sqrt{\left(\frac{-0.6111 - 0}{2}\right)^2 + 0.2222^2} \end{aligned}$$

$$\begin{aligned} \sigma_1 &= 0.0723 \text{ ksi} \quad \text{Ans} \\ \sigma_2 &= -0.683 \text{ ksi} \quad \text{Ans} \end{aligned}$$

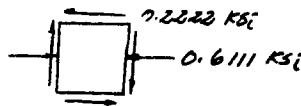
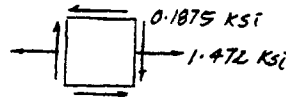
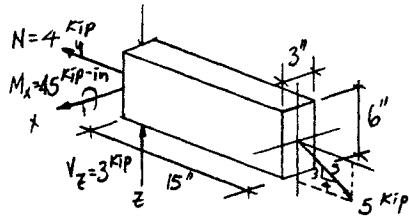

From *Mechanics of Materials*, Sixth Edition by R. C. Hibbeler, ISBN 0-13-191345-X.
 © 2005 R. C. Hibbeler. Published by Pearson Prentice Hall,
 Pearson Education, Inc., Upper Saddle River, NJ. All rights reserved.
 This material is protected under all copyright laws as they currently exist. No portion of this material may be reproduced, in any form or by any means, without permission in writing from the publisher.

*9-32 A paper tube is formed by rolling a paper strip in a spiral and then gluing the edges together as shown. Determine the shear stress acting along the seam, which is at 30° from the vertical, when the tube is subjected to an axial force of 10 N. The paper is 1 mm thick and the tube has an outer diameter of 30 mm.

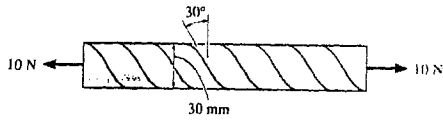

$$\sigma = \frac{P}{A} = \frac{10}{\frac{\pi}{4}(0.03^2 - 0.028^2)} = 109.76 \text{ kPa}$$

$$\sigma_x = 109.76 \text{ kPa} \quad \sigma_y = 0 \quad \tau_{xy} = 0 \quad \theta = 30^\circ$$

$$\begin{aligned} \tau_{x'y'} &= -\frac{\sigma_x - \sigma_y}{2} \sin 2\theta + \tau_{xy} \cos 2\theta \\ &= -\frac{109.76 - 0}{2} \sin 60^\circ + 0 = -47.5 \text{ kPa} \end{aligned}$$

Ans

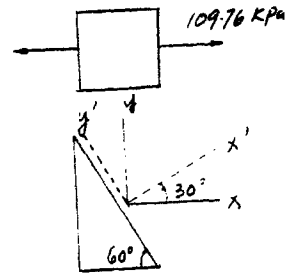

From *Mechanics of Materials*, Sixth Edition by R. C. Hibbeler, ISBN 0-13-191345-X.

© 2005 R. C. Hibbeler. Published by Pearson Prentice Hall,

Pearson Education, Inc., Upper Saddle River, NJ. All rights reserved.

This material is protected under all copyright laws as they currently exist. No portion of this material may be reproduced, in any form or by any means, without permission in writing from the publisher.

9-33 Solve Prob. 9-32 for the normal stress acting perpendicular to the seam.

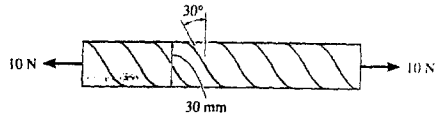

$$\sigma = \frac{P}{A} = \frac{10}{\frac{\pi}{4}(0.03^2 - 0.028^2)} = 109.76 \text{ kPa}$$

$$\begin{aligned} \sigma_n &= \frac{\sigma_x + \sigma_y}{2} + \frac{\sigma_x - \sigma_y}{2} \cos 2\theta + \tau_{xy} \sin 2\theta \\ &= \frac{109.76 + 0}{2} + \frac{109.76 - 0}{2} \cos (60^\circ) + 0 = 82.3 \text{ kPa} \end{aligned} \quad \text{Ans}$$

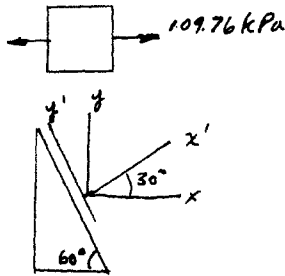

From *Mechanics of Materials*, Sixth Edition by R. C. Hibbeler, ISBN 0-13-191345-X.
 © 2005 R. C. Hibbeler. Published by Pearson Prentice Hall,
 Pearson Education, Inc., Upper Saddle River, NJ. All rights reserved.
 This material is protected under all copyright laws as they currently exist. No portion of this material may be reproduced, in any form or by any means, without permission in writing from the publisher.

9-34. A rod has a circular cross section with a diameter of 2 in. It is subjected to a torque of 12 kip·in. and a bending moment M . The greater principal stress at the point of maximum flexural stress is 15 ksi. Determine the magnitude of the bending moment.

$$J = \frac{\pi}{2}(1)^4 = 1.5708 \text{ in}^4$$

$$I = \frac{\pi}{4}(1)^4 = 0.7854 \text{ in}^4$$

$$\tau = \frac{Tc}{J} = \frac{12(1)}{1.5708} = 7.639 \text{ ksi}$$

$$\sigma_x = \frac{Mc}{I} = \frac{M(1)}{0.7854} = 1.2732M$$

$$\sigma_1 = \frac{\sigma_x + \sigma_y}{2} + \sqrt{\left(\frac{\sigma_x - \sigma_y}{2}\right)^2 + \tau_{xy}^2}$$

$$15 = \frac{1.2732M}{2} + \sqrt{\left(\frac{-1.2732M}{2}\right)^2 + 7.639^2}$$

$$M = 8.73 \text{ kip} \cdot \text{in.} \quad \text{Ans}$$

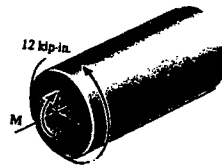

From *Mechanics of Materials*, Sixth Edition by R. C. Hibbeler, ISBN 0-13-191345-X.

© 2005 R. C. Hibbeler. Published by Pearson Prentice Hall,

Pearson Education, Inc., Upper Saddle River, NJ. All rights reserved.

This material is protected under all copyright laws as they currently exist. No portion of this material may be reproduced, in any form or by any means, without permission in writing from the publisher.

9-35 Determine the principal stresses acting at point A of the supporting frame. Show the results on a properly oriented element located at this point.

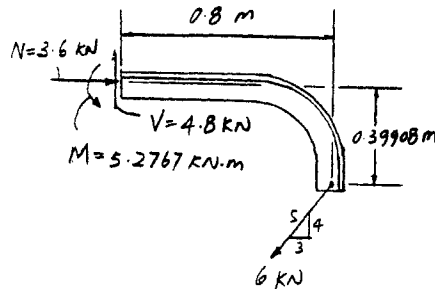
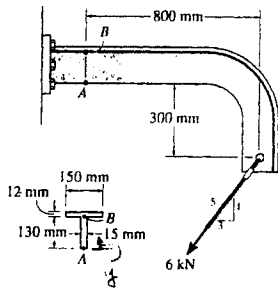

$$\bar{y} = \frac{\Sigma \bar{y} A}{\Sigma A} = \frac{0.065(0.13)(0.015) + 0.136(0.15)(0.012)}{0.13(0.015) + 0.15(0.012)} = 0.0991 \text{ m}$$

$$I = \frac{1}{12}(0.015)(0.13^3) + 0.015(0.13)(0.0991 - 0.065)^2 + \frac{1}{12}(0.15)(0.012^3) + 0.15(0.012)(0.136 - 0.0991)^2 = 7.4862(10^{-6}) \text{ m}^4$$

$$Q_A = 0$$

$$A = 0.13(0.015) + 0.15(0.012) = 3.75(10^{-3}) \text{ m}^2$$

Normal stress :

$$\sigma = \frac{P}{A} + \frac{M c}{I}$$

$$\sigma_A = \frac{-3.6(10^3)}{3.75(10^{-3})} - \frac{5.2767(10^3)(0.0991)}{7.4862(10^{-6})} = -70.80 \text{ MPa}$$



Shear stress :

$$\tau_A = 0$$

Principal stress :

$$\sigma_1 = 0 \quad \text{Ans}$$

$$\sigma_2 = -70.8 \text{ MPa} \quad \text{Ans}$$

From *Mechanics of Materials*, Sixth Edition by R. C. Hibbeler, ISBN 0-13-191345-X.

© 2005 R. C. Hibbeler. Published by Pearson Prentice Hall,

Pearson Education, Inc., Upper Saddle River, NJ. All rights reserved.

This material is protected under all copyright laws as they currently exist. No portion of this material may be reproduced, in any form or by any means, without permission in writing from the publisher.

*9-36 Determine the principal stresses acting at point B, which is located just on the web, below the horizontal segment on the cross section. Show the results on a properly oriented element located at this point. Although it is not very accurate, use the shear formula to calculate the shear stress.

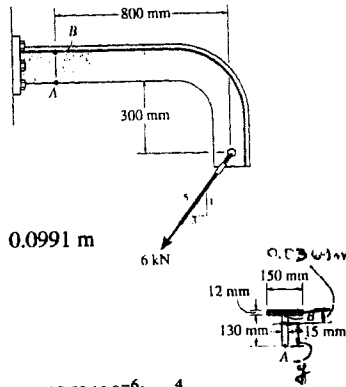

$$\bar{y} = \frac{\sum \bar{y} A}{\sum A} = \frac{0.065(0.13)(0.015) + 0.136(0.15)(0.012)}{0.13(0.015) + 0.15(0.012)} = 0.0991 \text{ m}$$

$$I = \frac{1}{12}(0.015)(0.13^3) + 0.015(0.13)(0.0991 - 0.065)^2 + \frac{1}{12}(0.15)(0.012^3) + 0.15(0.012)(0.136 - 0.0991)^2 = 7.4862(10^{-6}) \text{ m}^4$$

$$A = 0.13(0.015) + 0.15(0.012) = 3.75(10^{-3}) \text{ m}^2$$

Normal stress :

$$\sigma = \frac{P}{A} + \frac{M c}{I}$$

$$\sigma_B = -\frac{3.6(10^3)}{3.75(10^{-3})} + \frac{5.2767(10^3)(0.130 - 0.0991)}{7.4862(10^{-6})} = 20.834 \text{ MPa}$$

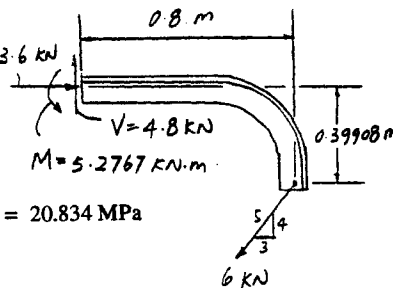

Shear stress :

$$\tau_B = \frac{VQ}{I t} = \frac{-4.8(10^3)(0.0369)(0.15)(0.012)(0.0369)}{7.4862(10^{-6})(0.015)} = -2.84 \text{ MPa}$$

Principal stress :

$$\sigma_{1,2} = \left(\frac{20.834 + 0}{2} \right) \pm \sqrt{\left(\frac{20.834 - 0}{2} \right)^2 + (-2.84)^2}$$

$$\sigma_1 = 21.2 \text{ MPa} \quad \text{Ans}$$

$$\sigma_2 = -0.380 \text{ MPa} \quad \text{Ans}$$

$$\tan 2\theta_p = \frac{-2.84}{\left(\frac{20.834 - 0}{2} \right)}$$

$$\theta_p = -7.63^\circ \quad \text{Ans}$$

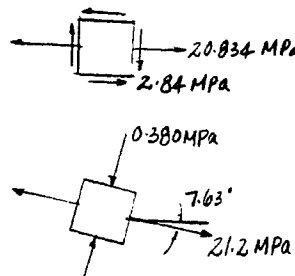

From *Mechanics of Materials*, Sixth Edition by R. C. Hibbeler, ISBN 0-13-191345-X.

© 2005 R. C. Hibbeler. Published by Pearson Prentice Hall,

Pearson Education, Inc., Upper Saddle River, NJ. All rights reserved.

This material is protected under all copyright laws as they currently exist. No portion of this material may be reproduced, in any form or by any means, without permission in writing from the publisher.

9-37 The box beam is subjected to the 26-kN force that is applied at the center of its width, 75 mm from each side. Determine the principal stresses at point A and show the results on an element located at this point. Use the shear formula to compute the shear stress.

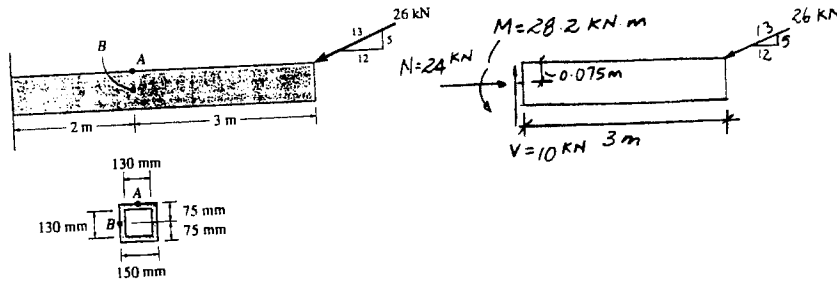

$$I = \frac{1}{12}(0.15)(0.15^3) - \frac{1}{12}(0.13)(0.13^3) = 18.38667(10^{-6}) \text{ m}^4$$

$$A = 0.15^2 - 0.13^2 = 5.6(10^{-3}) \text{ m}^2$$

$$Q_A = 0$$

$$\tau_A = 0$$

$$\sigma_A = -\frac{P}{A} + \frac{Mc}{I} = \frac{-24(10^3)}{5.6(10^{-3})} + \frac{28.2(10^3)(0.075)}{18.38667(10^{-6})} = 111 \text{ MPa}$$

$$\sigma_1 = 111 \text{ MPa} \quad \text{Ans}$$

$$\sigma_2 = 0 \quad \text{Ans}$$

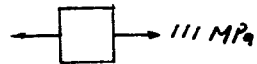

From *Mechanics of Materials*, Sixth Edition by R. C. Hibbeler, ISBN 0-13-191345-X.
 © 2005 R. C. Hibbeler. Published by Pearson Prentice Hall,
 Pearson Education, Inc., Upper Saddle River, NJ. All rights reserved.
 This material is protected under all copyright laws as they currently exist. No portion of this material may be reproduced, in any form or by any means, without permission in writing from the publisher.

9-38 Solve Prob. 9-37 for point B.

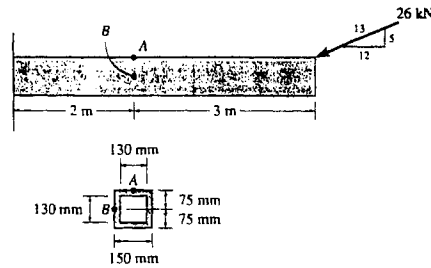

$$I = \frac{1}{12}(0.15)(0.15^3) - \frac{1}{12}(0.13)(0.13^3) = 18.38667(10^{-6}) \text{ m}^4$$

$$A = 0.15^2 - 0.13^2 = 5.6(10^{-3}) \text{ m}^2$$

$$Q_B = (0.07)(0.15)(0.01) + 2(0.0325)(0.065)(0.01) = 0.14725(10^{-3}) \text{ m}^3$$

$$\sigma_B = \frac{P}{A} = \frac{24(10^3)}{5.6(10^{-3})} = -4.286 \text{ MPa}$$

$$\tau_B = \frac{VQ_B}{It} = \frac{10(10^3)(0.14725)(10^{-3})}{18.38667(10^{-6})(0.02)} = 4.004 \text{ MPa}$$

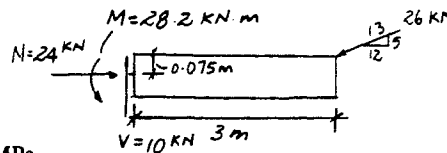

$$\sigma_x = -4.286 \text{ MPa} \quad \sigma_y = 0 \quad \tau_{xy} = -4.004 \text{ MPa}$$

$$\sigma_{1,2} = \frac{\sigma_x + \sigma_y}{2} \pm \sqrt{\left(\frac{\sigma_x - \sigma_y}{2}\right)^2 + \tau_{xy}^2}$$

$$= \frac{-4.286 + 0}{2} \pm \sqrt{\left(\frac{-4.286 - 0}{2}\right)^2 + (-4.004)^2}$$

$$\sigma_1 = 2.40 \text{ MPa} \quad \text{Ans} \quad \sigma_2 = -6.68 \text{ MPa} \quad \text{Ans}$$

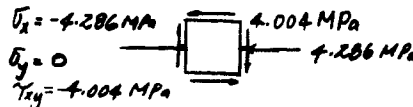

$$\tan 2\theta_p = \frac{\tau_{xy}}{(\sigma_x - \sigma_y)/2} = \frac{-4.004}{(-4.286 - 0)/2}$$

$$\theta_p = 30.9^\circ \quad \text{or} \quad -59.1^\circ$$

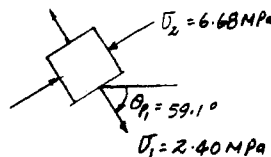

Use Eq 9-1,

$$\theta_{p1} = -59.1^\circ \quad \theta_{p2} = 30.9^\circ$$

From *Mechanics of Materials*, Sixth Edition by R. C. Hibbeler, ISBN 0-13-191345-X.

© 2005 R. C. Hibbeler. Published by Pearson Prentice Hall,

Pearson Education, Inc., Upper Saddle River, NJ. All rights reserved.

This material is protected under all copyright laws as they currently exist. No portion of this material may be reproduced, in any form or by any means, without permission in writing from the publisher.

9-39 The wide-flange beam is subjected to the 50-kN force. Determine the principal stresses in the beam at point A located on the web at the bottom of the upper flange. Although not very accurate, use the shear formula to compute the shear stress.

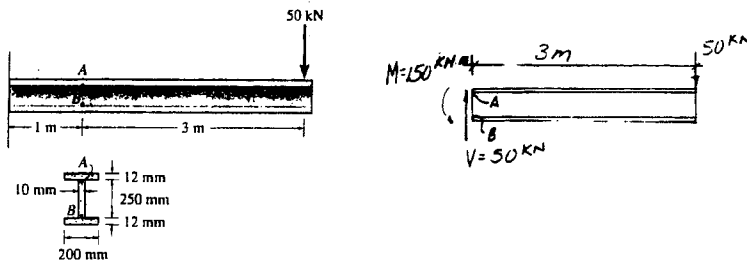

$$I = \frac{1}{12}(0.2)(0.274)^3 - \frac{1}{12}(0.19)(0.25)^3 = 95.451233(10^{-6}) \text{ m}^4$$

$$Q_A = (0.131)(0.012)(0.2) = 0.3144(10^{-3}) \text{ m}^3$$

$$\sigma_A = \frac{My}{I} = \frac{150(10^3)(0.125)}{95.451233(10^{-6})} = 196.43 \text{ MPa}$$

$$\tau_A = \frac{VQ_A}{It} = \frac{50(10^3)(0.3144)(10^{-3})}{95.451233(10^{-6})(0.01)} = 16.47 \text{ MPa}$$

$$\sigma_x = 196.43 \text{ MPa} \quad \sigma_y = 0 \quad \tau_{xy} = -16.47 \text{ MPa}$$

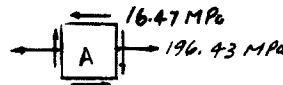

$$\begin{aligned} \sigma_{1,2} &= \frac{\sigma_x + \sigma_y}{2} \pm \sqrt{\left(\frac{\sigma_x - \sigma_y}{2}\right)^2 + \tau_{xy}^2} \\ &= \frac{196.43 + 0}{2} \pm \sqrt{\left(\frac{196.43 - 0}{2}\right)^2 + (-16.47)^2} \\ \sigma_1 &= 198 \text{ MPa} \quad \text{Ans} \\ \sigma_2 &= -1.37 \text{ MPa} \quad \text{Ans} \end{aligned}$$

From *Mechanics of Materials*, Sixth Edition by R. C. Hibbeler, ISBN 0-13-191345-X.

© 2005 R. C. Hibbeler. Published by Pearson Prentice Hall,

Pearson Education, Inc., Upper Saddle River, NJ. All rights reserved.

This material is protected under all copyright laws as they currently exist. No portion of this material may be reproduced, in any form or by any means, without permission in writing from the publisher.

*9-40 Solve Prob. 9-39 for point B located on the web at the top of the bottom flange.

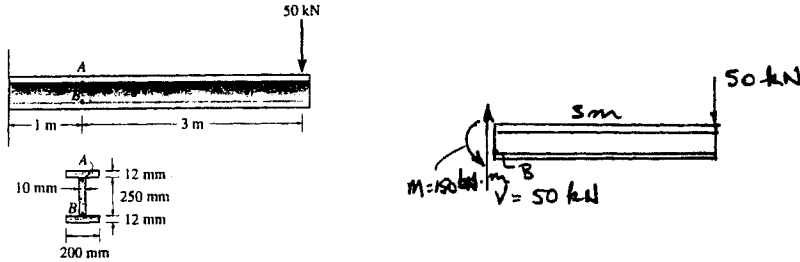

$$I = \frac{1}{12}(0.2)(0.247)^3 - \frac{1}{12}(0.19)(0.25)^3 = 95.451233(10^{-6}) \text{ m}^4$$

$$Q_B = (0.131)(0.012)(0.2) = 0.3144(10^{-3})$$

$$\sigma_B = -\frac{My}{I} = -\frac{150(10^3)(0.125)}{95.451233(10^{-6})} = -196.43 \text{ MPa}$$

$$\tau_B = \frac{VQ_B}{It} = \frac{50(10^3)(0.3144)(10^{-3})}{95.451233(10^{-6})(0.01)} = 16.47 \text{ MPa}$$

$$\sigma_x = -196.43 \text{ MPa} \quad \sigma_y = 0 \quad \tau_{xy} = -16.47 \text{ MPa}$$

$$\sigma_{1,2} = \frac{\sigma_x + \sigma_y}{2} \pm \sqrt{\left(\frac{\sigma_x - \sigma_y}{2}\right)^2 + \tau_{xy}^2}$$

$$= \frac{-196.43 + 0}{2} \pm \sqrt{\left(\frac{-196.43 - 0}{2}\right)^2 + (-16.47)^2}$$

$$\sigma_1 = 1.37 \text{ MPa} \quad \text{Ans}$$

$$\sigma_2 = -198 \text{ MPa} \quad \text{Ans}$$

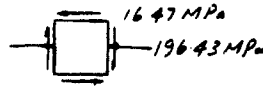

From *Mechanics of Materials*, Sixth Edition by R. C. Hibbeler, ISBN 0-13-191345-X.

© 2005 R. C. Hibbeler. Published by Pearson Prentice Hall,

Pearson Education, Inc., Upper Saddle River, NJ. All rights reserved.

This material is protected under all copyright laws as they currently exist. No portion of this material may be reproduced, in any form or by any means, without permission in writing from the publisher.

9-41 The bolt is fixed to its support at C. If a force of 18 lb is applied to the wrench to tighten it, determine the principal stresses developed in the bolt shank at point A. Represent the results on an element located at this point. The shank has a diameter of 0.25 in.

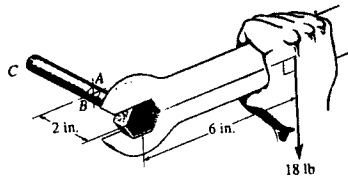

$$I_x = I_y = \frac{\pi}{4} (0.125^4) = 0.1917476(10^{-3}) \text{ in}^4$$

$$J = \frac{\pi}{2} (0.125^4) = 0.383495(10^{-3}) \text{ in}^4$$

$$\sigma_A = \frac{M_x c}{I} = \frac{36(0.125)}{0.1917476(10^{-3})} = 23.47 \text{ ksi}$$

$$\tau_A = \frac{T_y c}{J} = \frac{108(0.125)}{0.383495(10^{-3})} = 35.20 \text{ ksi}$$

$$\sigma_x = 23.47 \text{ ksi}, \quad \sigma_y = 0, \quad \tau_{xy} = 35.20 \text{ ksi}$$

$$\sigma_{1,2} = \frac{\sigma_x + \sigma_y}{2} \pm \sqrt{\left(\frac{\sigma_x - \sigma_y}{2}\right)^2 + \tau_{xy}^2}$$

$$= \frac{23.47 + 0}{2} \pm \sqrt{\left(\frac{23.47 - 0}{2}\right)^2 + 35.2^2}$$

$$\sigma_1 = 48.8 \text{ ksi} \quad \text{Ans}$$

$$\sigma_2 = -25.4 \text{ ksi} \quad \text{Ans}$$

$$\tan 2\theta_p = \frac{\tau_{xy}}{(\sigma_x - \sigma_y)/2} = \frac{35.20}{(23.47 - 0)/2}$$

$$\theta_p = 35.78^\circ \quad \text{and} \quad \theta_p = -54.22^\circ$$

Use Eq. 9-1 to determine the principal planes for σ_1 and σ_2 :

$$\sigma_x = \frac{\sigma_x + \sigma_y}{2} + \frac{\sigma_x - \sigma_y}{2} \cos 2\theta + \tau_{xy} \sin 2\theta$$

$$= \frac{23.47 + 0}{2} + \frac{23.47 - 0}{2} \cos 71.56^\circ + 35.20 \sin 71.56^\circ = 48.8 \text{ ksi}$$

$$\theta_{p1} = 35.78^\circ \quad \theta_{p2} = -54.22^\circ$$

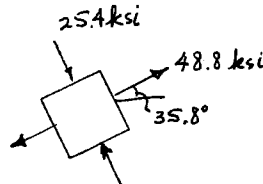
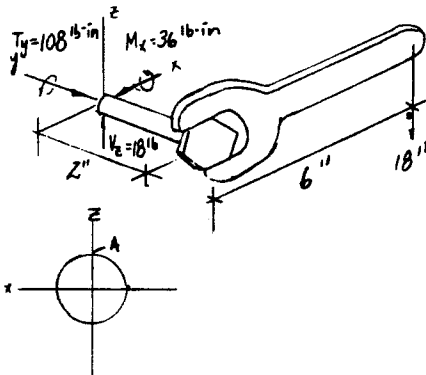

From *Mechanics of Materials*, Sixth Edition by R. C. Hibbeler, ISBN 0-13-191345-X.
 © 2005 R. C. Hibbeler. Published by Pearson Prentice Hall,
 Pearson Education, Inc., Upper Saddle River, NJ. All rights reserved.
 This material is protected under all copyright laws as they currently exist. No portion of this material may be reproduced, in any form or by any means, without permission in writing from the publisher.

9-42 Solve Prob. 9-41 for point B.

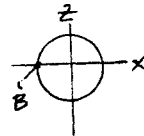
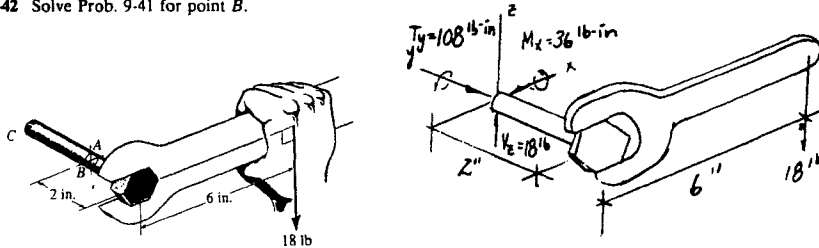

$$I_x = I_z = \frac{\pi}{4}(0.125^4) = 0.1917476(10^{-3}) \text{ in}^4$$

$$J = \frac{\pi}{2}(0.125)^4 = 0.383495(10^{-3}) \text{ in}^4$$

$$\sigma_B = 0$$

$$Q_B = \bar{y}'A' = \frac{4(0.125)}{3\pi} \left(\frac{1}{2}\right)(\pi)(0.125^2) = 1.3020833(10^{-3}) \text{ in}^3$$

$$\tau_B = \frac{V_y Q_B}{I_t} - \frac{T_y c}{J} = \frac{18(1.3020833)(10^{-3})}{0.1917476(10^{-3})(0.25)} - \frac{108(0.125)}{0.383495(10^{-3})} = -34.71 \text{ ksi}$$

$$\sigma_x = 0 \quad \sigma_y = 0 \quad \tau_{xy} = 34.71 \text{ ksi}$$

$$\sigma_{1,2} = \frac{\sigma_x + \sigma_y}{2} \pm \sqrt{\left(\frac{\sigma_x - \sigma_y}{2}\right)^2 + \tau_{xy}^2}$$

$$= 0 \pm \sqrt{(0)^2 + (34.71)^2}$$

$$\sigma_1 = 34.7 \text{ ksi} \quad \text{Ans}$$

$$\sigma_2 = -34.7 \text{ ksi} \quad \text{Ans}$$

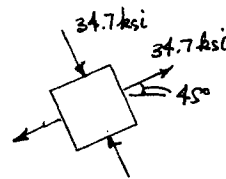

From *Mechanics of Materials*, Sixth Edition by R. C. Hibbeler, ISBN 0-13-191345-X.

© 2005 R. C. Hibbeler. Published by Pearson Prentice Hall,

Pearson Education, Inc., Upper Saddle River, NJ. All rights reserved.

This material is protected under all copyright laws as they currently exist. No portion of this material may be reproduced, in any form or by any means, without permission in writing from the publisher.

9-43 The nose wheel of the plane is subjected to a design load of 12 kN. Determine the principal stresses acting on the aluminum wheel support at point A.

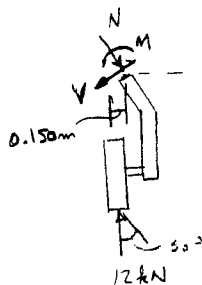
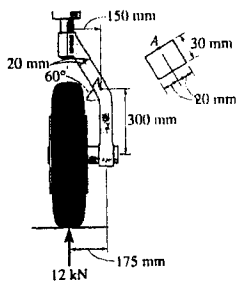

$$\uparrow + \Sigma F_y = 0; \quad 12 \cos 30^\circ - N = 0; \quad N = 10.392 \text{ kN}$$

$$\leftarrow + \Sigma F_x = 0; \quad -12 \sin 30^\circ + V = 0; \quad V = 6 \text{ kN}$$

$$\curvearrow + \Sigma M_A = 0; \quad M - (12)(0.150) = 0; \quad M = 1.80 \text{ kN} \cdot \text{m}$$

$$\sigma = \frac{P}{A} = \frac{10.392(10^3)}{(0.03)(0.04)} = 8.66 \text{ MPa} \quad (C)$$

$$\tau = \frac{VQ}{It} = \frac{6(10^3)(0.01)(0.03)(0.02)}{\frac{1}{12}(0.03)(0.04)^3(0.03)} = 7.50 \text{ MPa}$$

$$\sigma_{1,2} = \frac{\sigma_x + \sigma_y}{2} \pm \sqrt{\left(\frac{\sigma_x - \sigma_y}{2}\right)^2 + \tau_{xy}^2}$$

$$= \frac{8.66 + 0}{2} \pm \sqrt{\left(\frac{8.66 - 0}{2}\right)^2 + (7.50)^2}$$

$$= 4.33 \pm 8.66025$$

$$\sigma_1 = -12.990 \Rightarrow 13.0 \text{ MPa} \quad \text{Ans}$$

$$\sigma_2 = 4.33 \text{ MPa} \quad \text{Ans}$$

From *Mechanics of Materials*, Sixth Edition by R. C. Hibbeler, ISBN 0-13-191345-X.

© 2005 R. C. Hibbeler. Published by Pearson Prentice Hall,

Pearson Education, Inc., Upper Saddle River, NJ. All rights reserved.

This material is protected under all copyright laws as they currently exist. No portion of this material may be reproduced, in any form or by any means, without permission in writing from the publisher.

*9-44 The solid shaft is subjected to a torque, bending moment, and shear force as shown. Determine the principal stresses acting at point A.

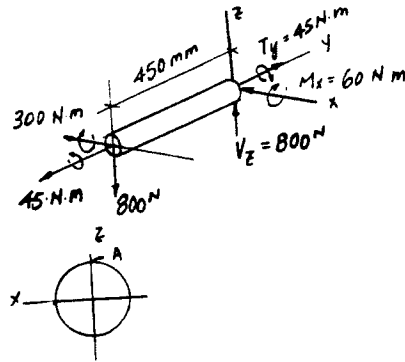
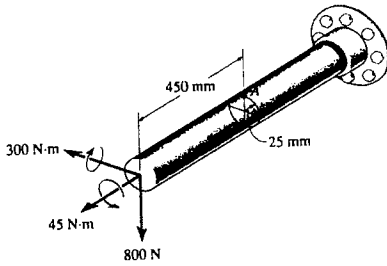

$$I_x = I_y = \frac{\pi}{4}(0.025)^4 = 0.306796(10^{-6}) \text{ m}^4$$

$$J = \frac{\pi}{2}(0.025)^4 = 0.613592(10^{-6}) \text{ m}^4$$

$$Q_A = 0$$

$$\sigma_A = \frac{M_x c}{I} = \frac{60(0.025)}{0.306796(10^{-6})} = 4.889 \text{ MPa}$$

$$\tau_A = \frac{T_y c}{J} = \frac{45(0.025)}{0.613592(10^{-6})} = 1.833 \text{ MPa}$$

$$\sigma_x = 4.889 \text{ MPa} \quad \sigma_y = 0 \quad \tau_{xy} = -1.833 \text{ MPa}$$

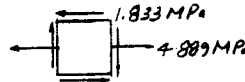

$$\sigma_{1,2} = \frac{\sigma_x + \sigma_y}{2} \pm \sqrt{\left(\frac{\sigma_x - \sigma_y}{2}\right)^2 + \tau_{xy}^2}$$

$$= \frac{4.889 + 0}{2} \pm \sqrt{\left(\frac{4.889 - 0}{2}\right)^2 + (-1.833)^2}$$

$$\sigma_1 = 5.50 \text{ MPa} \quad \text{Ans}$$

$$\sigma_2 = -0.611 \text{ MPa} \quad \text{Ans}$$

From *Mechanics of Materials*, Sixth Edition by R. C. Hibbeler, ISBN 0-13-191345-X.

© 2005 R. C. Hibbeler. Published by Pearson Prentice Hall,

Pearson Education, Inc., Upper Saddle River, NJ. All rights reserved.

This material is protected under all copyright laws as they currently exist. No portion of this material may be reproduced, in any form or by any means, without permission in writing from the publisher.

9-45 Solve prob. 9-44 for point B.

$$I_x = I_y = \frac{\pi}{4}(0.025)^4 = 0.306796(10^{-6}) \text{ m}^4$$

$$J = \frac{\pi}{2}(0.025)^4 = 0.613592(10^{-6}) \text{ m}^4$$

$$Q_B = \bar{y}A' = \frac{4(0.025)}{3\pi} \left(\frac{1}{2}\right)\pi(0.025)^2 = 10.4167(10^{-6}) \text{ m}$$

$$\sigma_B = 0$$

$$\tau_B = \frac{V_z Q_B}{I_t} - \frac{T_y c}{J} = \frac{800(10.4167)(10^{-6})}{0.306796(10^{-6})(0.05)} - \frac{45(0.025)}{0.61359(10^{-6})} = -1.290 \text{ MPa}$$

$$\sigma_x = 0 \quad \sigma_y = 0 \quad \tau_{xy} = -1.290 \text{ MPa}$$

$$\sigma_{1,2} = \frac{\sigma_x + \sigma_y}{2} \pm \sqrt{\left(\frac{\sigma_x - \sigma_y}{2}\right)^2 + \tau_{xy}^2}$$

$$= 0 \pm \sqrt{(0)^2 + (-1.290)^2}$$

$$\sigma_1 = 1.29 \text{ MPa} \quad \text{Ans}$$

$$\sigma_2 = -1.29 \text{ MPa} \quad \text{Ans}$$

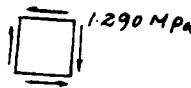
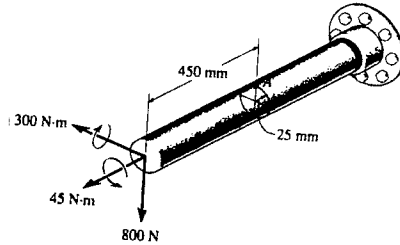
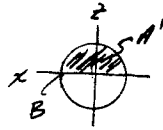

From *Mechanics of Materials*, Sixth Edition by R. C. Hibbeler, ISBN 0-13-191345-X.

© 2005 R. C. Hibbeler. Published by Pearson Prentice Hall,

Pearson Education, Inc., Upper Saddle River, NJ. All rights reserved.

This material is protected under all copyright laws as they currently exist. No portion of this material may be reproduced, in any form or by any means, without permission in writing from the publisher.

9-46. The internal loadings at a cross section through the 6-in.-diameter drive shaft of a turbine consist of an axial force of 2500 lb, a bending moment of 800 lb · ft, and a torsional moment of 1500 lb · ft. Determine the principal stresses at point A. Also calculate the maximum in-plane shear stress at this point.

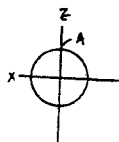
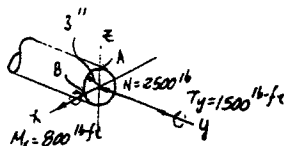
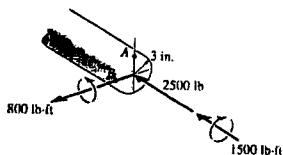

$$A = \pi (3)^2 = 28.274 \text{ in}^2$$

$$J = \frac{\pi}{2} (3^4) = 127.23 \text{ in}^4$$

$$I = \frac{\pi}{4} (3^4) = 63.62 \text{ in}^4$$

$$\sigma_A = \frac{P}{A} - \frac{M_x c}{I} = \frac{2500}{28.274} - \frac{800(12)(3)}{63.62} = -541.1 \text{ psi}$$

$$\tau_A = \frac{T_y c}{J} = \frac{1500(12)(3)}{127.23} = 424.4 \text{ psi}$$

$$\sigma_x = -541.1 \text{ psi} \quad \sigma_y = 0 \quad \tau_{xy} = 424.4 \text{ psi}$$

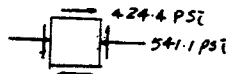

$$\sigma_{1,2} = \frac{\sigma_x + \sigma_y}{2} \pm \sqrt{\left(\frac{\sigma_x - \sigma_y}{2}\right)^2 + \tau_{xy}^2}$$

$$= \frac{-541.1 + 0}{2} \pm \sqrt{\left(\frac{-541.1 - 0}{2}\right)^2 + (424.4)^2}$$

$$\sigma_1 = 233 \text{ psi} \quad \text{Ans}$$

$$\sigma_2 = -774 \text{ psi} \quad \text{Ans}$$

$$\tau_{\text{max in-plane}} = \sqrt{\left(\frac{\sigma_x - \sigma_y}{2}\right)^2 + \tau_{xy}^2}$$

$$= \sqrt{\left(\frac{-541.1 - 0}{2}\right)^2 + (424.4)^2} = 503 \text{ psi} \quad \text{Ans}$$

From *Mechanics of Materials*, Sixth Edition by R. C. Hibbeler, ISBN 0-13-191345-X.

© 2005 R. C. Hibbeler. Published by Pearson Prentice Hall,

Pearson Education, Inc., Upper Saddle River, NJ. All rights reserved.

This material is protected under all copyright laws as they currently exist. No portion of this material may be reproduced, in any form or by any means, without permission in writing from the publisher.

9-47. The internal loadings at a cross section through the 6-in.-diameter drive shaft of a turbine consist of an axial force of 2500 lb, a bending moment of 800 lb · ft, and a torsional moment of 1500 lb · ft. Determine the principal stresses at point *B*. Also calculate the maximum in-plane shear stress at this point.

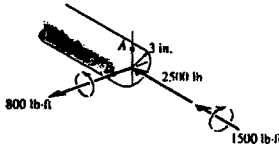

$$A = \pi (3)^2 = 28.274 \text{ in}^2$$

$$J = \frac{\pi}{2} (3^4) = 127.23 \text{ in}^4$$

$$I = \frac{\pi}{4} (3^4) = 63.62 \text{ in}^4$$

$$\sigma_B = -\frac{P}{A} = -\frac{2500}{28.274} = -88.42 \text{ psi}$$

$$\tau_B = \frac{T_y c}{J} = \frac{1500(12)(3)}{127.23} = 424.42$$

$$\sigma_x = -88.42 \text{ psi} \quad \sigma_y = 0 \quad \tau_{xy} = 424.4 \text{ psi}$$

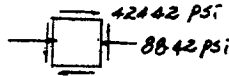

$$\sigma_{1,2} = \frac{\sigma_x + \sigma_y}{2} \pm \sqrt{\left(\frac{\sigma_x - \sigma_y}{2}\right)^2 + \tau_{xy}^2}$$

$$= \frac{-88.42 + 0}{2} \pm \sqrt{\left(\frac{-88.42 - 0}{2}\right)^2 + (424.4)^2}$$

$$\sigma_1 = 382 \text{ psi} \quad \text{Ans}$$

$$\sigma_2 = -471 \text{ psi} \quad \text{Ans}$$

$$\tau_{\text{max in-plane}} = \sqrt{\left(\frac{\sigma_x - \sigma_y}{2}\right)^2 + \tau_{xy}^2}$$

$$= \sqrt{\left(\frac{-88.42 - 0}{2}\right)^2 + (424.42)^2} = 427 \text{ psi} \quad \text{Ans}$$

From *Mechanics of Materials*, Sixth Edition by R. C. Hibbeler, ISBN 0-13-191345-X.

© 2005 R. C. Hibbeler. Published by Pearson Prentice Hall,

Pearson Education, Inc., Upper Saddle River, NJ. All rights reserved.

This material is protected under all copyright laws as they currently exist. No portion of this material may be reproduced, in any form or by any means, without permission in writing from the publisher.

*9-48 The 2-in.-diameter drive shaft AB on the helicopter is subjected to an axial tension of 10 000 lb and a torque of 300 lb · ft. Determine the principal stresses and the maximum in-plane shear stress that act at a point on the surface of the shaft.

$$\sigma = \frac{P}{A} = \frac{10\,000}{\pi(1)^2} = 3.183 \text{ ksi}$$

$$\tau = \frac{Tc}{J} = \frac{300(12)(1)}{\frac{\pi}{2}(1)^4} = 2.292 \text{ ksi}$$

$$\begin{aligned}\sigma_{1,2} &= \frac{\sigma_x + \sigma_y}{2} \pm \sqrt{\left(\frac{\sigma_x - \sigma_y}{2}\right)^2 + \tau_{xy}^2} \\ &= \frac{3.183 + 0}{2} \pm \sqrt{\left(\frac{3.183 - 0}{2}\right)^2 + (2.292)^2}\end{aligned}$$

$$\sigma_1 = 4.38 \text{ ksi} \quad \text{Ans}$$

$$\sigma_2 = -1.20 \text{ ksi} \quad \text{Ans}$$

$$\begin{aligned}\tau_{\text{max in-plane}} &= \sqrt{\left(\frac{\sigma_x - \sigma_y}{2}\right)^2 + \tau_{xy}^2} \\ &= \sqrt{\left(\frac{3.183 - 0}{2}\right)^2 + (2.292)^2} \\ &= 2.79 \text{ ksi} \quad \text{Ans}\end{aligned}$$

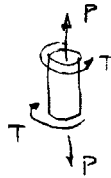
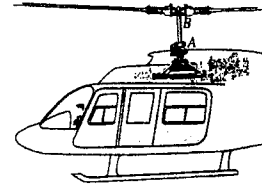

From *Mechanics of Materials*, Sixth Edition by R. C. Hibbeler, ISBN 0-13-191345-X.

© 2005 R. C. Hibbeler. Published by Pearson Prentice Hall,

Pearson Education, Inc., Upper Saddle River, NJ. All rights reserved.

This material is protected under all copyright laws as they currently exist. No portion of this material may be reproduced, in any form or by any means, without permission in writing from the publisher.

9-49 The box beam is subjected to the loading shown. Determine the principal stresses in the beam at points A and B.

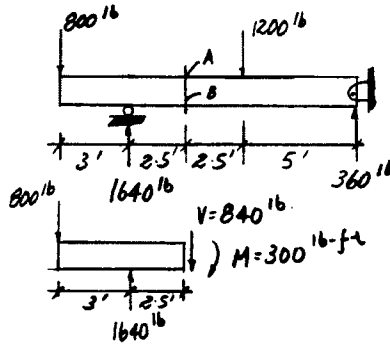
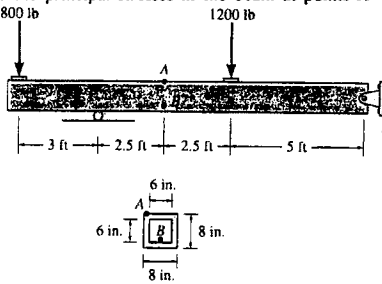

$$I = \frac{1}{12}(8)(8)^3 - \frac{1}{12}(6)(6)^3 = 233.33 \text{ in}^4$$

$$Q_A = 0$$

$$Q_B = 0$$

For point A :

$$\tau_A = 0$$

$$\sigma_A = \frac{Mc}{I} = \frac{300(12)(4)}{233.33} = 61.7 \text{ psi}$$

$$\sigma_1 = 61.7 \text{ psi} \quad \text{Ans}$$

$$\sigma_2 = 0 \quad \text{Ans}$$

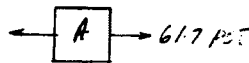

For point B :

$$\tau_B = 0$$

$$\sigma_B = -\frac{My}{I} = \frac{-300(12)(3)}{233.33} = -46.3 \text{ psi}$$

$$\sigma_1 = 0 \quad \text{Ans}$$

$$\sigma_2 = -46.3 \text{ psi} \quad \text{Ans}$$

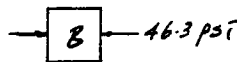

From *Mechanics of Materials*, Sixth Edition by R. C. Hibbeler, ISBN 0-13-191345-X.

© 2005 R. C. Hibbeler. Published by Pearson Prentice Hall,

Pearson Education, Inc., Upper Saddle River, NJ. All rights reserved.

This material is protected under all copyright laws as they currently exist. No portion of this material may be reproduced, in any form or by any means, without permission in writing from the publisher.

9-50 A bar has a circular cross section with a diameter of 1 in. It is subjected to a torque and a bending moment. At the point of maximum bending stress the principal stresses are 20 ksi and -10 ksi. Determine the torque and the bending moment.

$$\sigma_{1,2} = \frac{\sigma_x + \sigma_y}{2} \pm \sqrt{\left(\frac{\sigma_x - \sigma_y}{2}\right)^2 + \tau_{xy}^2}$$

In this problem $\sigma_y = 0$

$$20 = \frac{\sigma_x}{2} + \sqrt{\left(\frac{\sigma_x}{2}\right)^2 + \tau_{xy}^2}$$

$$\left(20 - \frac{\sigma_x}{2}\right)^2 = \frac{\sigma_x^2}{4} + \tau_{xy}^2$$

$$400 + \frac{\sigma_x^2}{4} - 20\sigma_x = \frac{\sigma_x^2}{4} + \tau_{xy}^2$$

$$400 - 20\sigma_x = \tau_{xy}^2 \quad (1)$$

$$-10 = \frac{\sigma_x}{2} - \sqrt{\left(\frac{\sigma_x}{2}\right)^2 + \tau_{xy}^2}$$

$$\left(-10 - \frac{\sigma_x}{2}\right)^2 = \frac{\sigma_x^2}{4} + \tau_{xy}^2$$

$$100 + \frac{\sigma_x^2}{4} + 10\sigma_x = \frac{\sigma_x^2}{4} + \tau_{xy}^2$$

$$100 + 10\sigma_x = \tau_{xy}^2 \quad (2)$$

Solving Eqs. (1) and (2) :

$$\sigma_x = 10 \text{ ksi} \quad \tau_{xy} = 14.14 \text{ ksi}$$

$$\tau_{xy} = \frac{Tc}{J}; \quad 14.14 = \frac{T(0.5)}{\frac{\pi}{2}(0.5^4)}$$

$$T = 2.776 \text{ kip} \cdot \text{in.} = 231 \text{ lb} \cdot \text{ft} \quad \text{Ans}$$

$$\sigma = \frac{Mc}{I}; \quad 10 = \frac{M(0.5)}{\frac{\pi}{2}(0.5^4)}$$

$$M = 0.981 \text{ kip} \cdot \text{in.} = 81.8 \text{ lb} \cdot \text{ft} \quad \text{Ans}$$

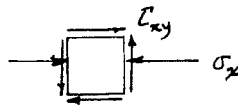

From *Mechanics of Materials*, Sixth Edition by R. C. Hibbeler, ISBN 0-13-191345-X.

© 2005 R. C. Hibbeler. Published by Pearson Prentice Hall,

Pearson Education, Inc., Upper Saddle River, NJ. All rights reserved.

This material is protected under all copyright laws as they currently exist. No portion of this material may be reproduced, in any form or by any means, without permission in writing from the publisher.

9-51 The internal loadings at a section of the beam consist of an axial force of 500 N, a shear force of 800 N, and two moment components of 30 N · m and 40 N · m. Determine the principal stresses at point A. Also compute the maximum in-plane shear stress at this point.

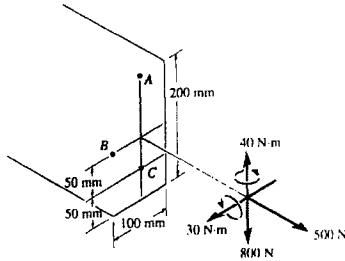

$$I_x = \frac{1}{12}(0.1)(0.2)^3 = 66.67(10^{-6}) \text{ m}^4$$

$$Q_A = 0$$

$$\sigma_A = \frac{P}{A} - \frac{Mz}{I_x} = \frac{500}{(0.1)(0.2)} - \frac{30(0.1)}{66.67(10^{-6})} = -20 \text{ kPa}$$



$$\tau_A = 0$$

Here, the principal stresses are

$$\sigma_1 = \sigma_y = 0 \quad \text{Ans} \quad \sigma_2 = \sigma_x = -20 \text{ kPa} \quad \text{Ans}$$

$$\tau_{\text{max in-plane}} = \sqrt{\left(\frac{\sigma_x - \sigma_y}{2}\right)^2 + \tau_{xy}^2}$$

$$= \sqrt{\left(\frac{-20 - 0}{2}\right)^2 + 0} = 10 \text{ kPa} \quad \text{Ans}$$

From *Mechanics of Materials*, Sixth Edition by R. C. Hibbeler, ISBN 0-13-191345-X.

© 2005 R. C. Hibbeler. Published by Pearson Prentice Hall,

Pearson Education, Inc., Upper Saddle River, NJ. All rights reserved.

This material is protected under all copyright laws as they currently exist. No portion of this material may be reproduced, in any form or by any means, without permission in writing from the publisher.

*9-52 The internal loadings at a section of the beam consist of an axial force of 500 N, a shear force of 800 N, and two moment components of 30 N·m and 40 N·m. Determine the principal stresses at point B. Also compute the maximum in-plane shear stress at this point.

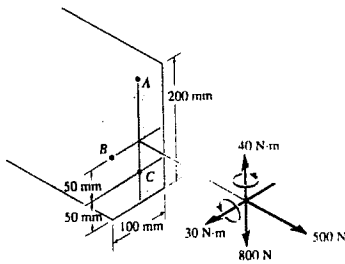

$$I_x = \frac{1}{12} (0.1)(0.2)^3 = 66.67(10^{-6}) \text{ m}^4$$

$$I_z = \frac{1}{12} (0.2)(0.1)^3 = 16.67(10^{-6}) \text{ m}^4$$

$$Q_B = \bar{z}'A' = (0.05)(0.1)(0.1) = 0.5(10^{-3}) \text{ m}^3$$

$$\sigma_B = \frac{P}{A} + \frac{M_z x}{I} = \frac{500}{(0.1)(0.2)} + \frac{40(0.05)}{16.67(10^{-6})} = 145 \text{ kPa}$$

$$\tau_B = \frac{V_z Q_B}{I_x t} = \frac{800(0.5)(10^{-3})}{66.67(10^{-6})(0.1)} = 60 \text{ kPa}$$

$$\sigma_x = 145 \text{ kPa} \quad \sigma_y = 0 \quad \tau_{xy} = -60 \text{ kPa}$$

$$\begin{aligned} \sigma_{1,2} &= \frac{\sigma_x + \sigma_y}{2} \pm \sqrt{\left(\frac{\sigma_x - \sigma_y}{2}\right)^2 + \tau_{xy}^2} \\ &= \frac{145 + 0}{2} \pm \sqrt{\left(\frac{145 - 0}{2}\right)^2 + (-60)^2} \end{aligned}$$

$$\sigma_1 = 167 \text{ kPa} \quad \text{Ans}$$

$$\sigma_2 = -21.6 \text{ kPa} \quad \text{Ans}$$

$$\tau_{\max \text{ in-plane}} = \sqrt{\left(\frac{\sigma_x - \sigma_y}{2}\right)^2 + \tau_{xy}^2}$$

$$= \sqrt{\left(\frac{145 - 0}{2}\right)^2 + (-60)^2} = 94.1 \text{ kPa} \quad \text{Ans}$$

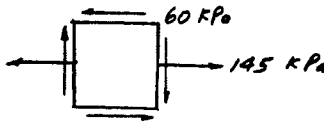

From *Mechanics of Materials*, Sixth Edition by R. C. Hibbeler, ISBN 0-13-191345-X.

© 2005 R. C. Hibbeler. Published by Pearson Prentice Hall,

Pearson Education, Inc., Upper Saddle River, NJ. All rights reserved.

This material is protected under all copyright laws as they currently exist. No portion of this material may be reproduced, in any form or by any means, without permission in writing from the publisher.

9-53 The internal loadings at a section of the beam consist of an axial force of 500 N, a shear force of 800 N, and two moment components of 30 N·m and 40 N·m. Determine the principal stresses at point C. Also compute the maximum in-plane shear stress at this point.

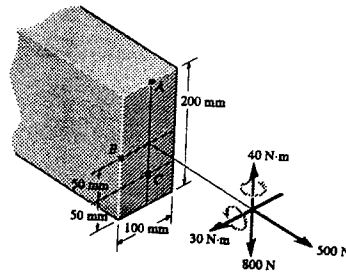

$$I_x = \frac{1}{12}(0.1)(0.2)^3 = 66.67(10^{-6})\text{m}^4$$

$$I_z = \frac{1}{12}(0.2)(0.1)^3 = 16.67(10^{-6})\text{m}^4$$

$$Q_C = (0.075)(0.05)(0.1) = 0.375(10^{-3})\text{m}^3$$

$$\sigma_C = \frac{P}{A} + \frac{M_z}{I_x} = \frac{500}{(0.1)(0.2)} + \frac{30(0.05)}{66.67(10^{-6})} = 47.5 \text{ kPa}$$

$$\tau_C = \frac{V_x Q_C}{I_x t} = \frac{800(0.375)(10^{-3})}{66.67(10^{-6})(0.1)} = 45 \text{ kPa}$$

$$\sigma_x = 47.5 \text{ kPa} \quad \sigma_y = 0 \quad \tau_{xy} = -45 \text{ kPa}$$

$$\begin{aligned} \sigma_{1,2} &= \frac{\sigma_x + \sigma_y}{2} \pm \sqrt{\left(\frac{\sigma_x - \sigma_y}{2}\right)^2 + \tau_{xy}^2} \\ &= \frac{47.5 + 0}{2} \pm \sqrt{\left(\frac{47.5 - 0}{2}\right)^2 + (-45)^2} \end{aligned}$$

$$\sigma_1 = 74.6 \text{ kPa} \quad \text{Ans}$$

$$\sigma_2 = -27.1 \text{ kPa} \quad \text{Ans}$$

$$\tau_{\text{max in-plane}} = \sqrt{\left(\frac{\sigma_x - \sigma_y}{2}\right)^2 + \tau_{xy}^2}$$

$$= \sqrt{\left(\frac{47.5 - 0}{2}\right)^2 + (-45)^2} = 50.9 \text{ kPa} \quad \text{Ans}$$

From *Mechanics of Materials*, Sixth Edition by R. C. Hibbeler, ISBN 0-13-191345-X.

© 2005 R. C. Hibbeler. Published by Pearson Prentice Hall,

Pearson Education, Inc., Upper Saddle River, NJ. All rights reserved.

This material is protected under all copyright laws as they currently exist. No portion of this material may be reproduced, in any form or by any means, without permission in writing from the publisher.

Because of the number and variety of potential correct solutions to this problem, no solution is being given.

From *Mechanics of Materials*, Sixth Edition by R. C. Hibbeler, ISBN 0-13-191345-X.

© 2005 R. C. Hibbeler. Published by Pearson Prentice Hall,

Pearson Education, Inc, Upper Saddle River, NJ. All rights reserved.

This material is protected under all copyright laws as they currently exist. No portion of this material may be reproduced, in any form or by any means, without permission in writing from the publisher.

Because of the number and variety of potential correct solutions to this problem, no solution is being given.

From *Mechanics of Materials*, Sixth Edition by R. C. Hibbeler, ISBN 0-13-191345-X.

© 2005 R. C. Hibbeler. Published by Pearson Prentice Hall,

Pearson Education, Inc, Upper Saddle River, NJ. All rights reserved.

This material is protected under all copyright laws as they currently exist. No portion of this material may be reproduced, in any form or by any means, without permission in writing from the publisher.

*9-56 Solve Prob. 9-4 using Mohr's circle.

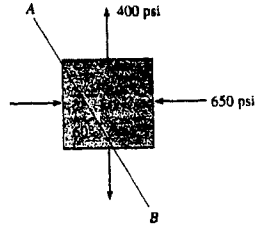

$$\frac{\sigma_x + \sigma_y}{2} = \frac{-650 + 400}{2} = -125$$

$$A(-650,0) \quad B(400,0) \quad C(-125,0)$$

$$R = CA = 650 - 125 = 525$$

$$\sigma_{x'} = -125 - 525 \cos 60^\circ = -388 \text{ psi} \quad \text{Ans}$$

$$\tau_{x'y'} = 525 \sin 60^\circ = 455 \text{ psi} \quad \text{Ans}$$

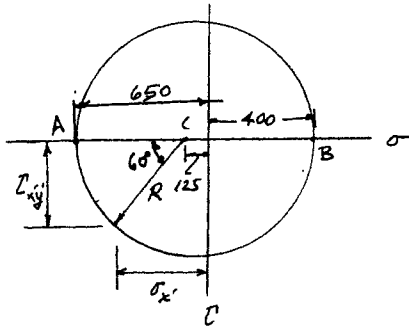

From *Mechanics of Materials*, Sixth Edition by R. C. Hibbeler, ISBN 0-13-191345-X.

© 2005 R. C. Hibbeler. Published by Pearson Prentice Hall,

Pearson Education, Inc., Upper Saddle River, NJ. All rights reserved.

This material is protected under all copyright laws as they currently exist. No portion of this material may be reproduced, in any form or by any means, without permission in writing from the publisher.

9-57 Solve Prob. 9-2 using Mohr's circle.

$$\frac{\sigma_x + \sigma_y}{2} = \frac{5 + 3}{2} = 4 \text{ ksi}$$

$$R = \sqrt{(5-4)^2 + 8^2} = 8.0623$$

$$\phi = \tan^{-1} \frac{8}{(5-4)} = 82.875^\circ$$

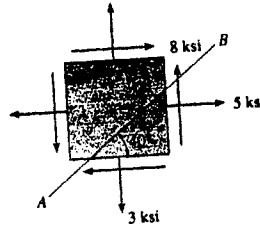

$$2\theta = 2(130^\circ) = 260^\circ$$

$$360^\circ - 260^\circ = 100^\circ$$

$$\alpha = 100^\circ + 82.875^\circ - 180^\circ = 2.875^\circ$$

$$\sigma_{x'} = 8.0623 \cos 2.875^\circ - 4 = -4.05 \text{ ksi} \quad \text{Ans}$$

$$\tau_{x'y'} = -8.0623 \sin 2.875^\circ = -0.404 \text{ ksi} \quad \text{Ans}$$

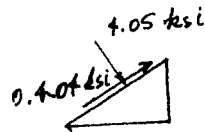
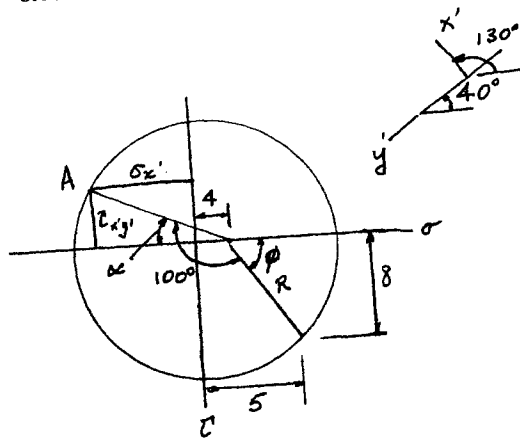

From *Mechanics of Materials*, Sixth Edition by R. C. Hibbeler, ISBN 0-13-191345-X.
 © 2005 R. C. Hibbeler. Published by Pearson Prentice Hall,
 Pearson Education, Inc., Upper Saddle River, NJ. All rights reserved.
 This material is protected under all copyright laws as they currently exist. No portion of this material may be reproduced, in any form or by any means, without permission in writing from the publisher.

9-58 Solve Prob. 9-3 using Mohr's circle.

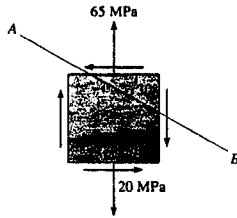

$$\frac{\sigma_x + \sigma_y}{2} = \frac{0 + 65}{2} = 32.5 \text{ MPa}$$

$$R = \sqrt{(32.5)^2 + (20)^2} = 38.1608$$

$$\phi = \tan^{-1} \frac{20}{32.5} = 31.6075^\circ$$

$$\alpha = 120^\circ - 31.6075^\circ = 88.392^\circ$$

$$\sigma_{x'} = 32.5 - 38.1608 \cos 88.392^\circ = 31.4 \text{ MPa} \quad \text{Ans}$$

$$\tau_{x'y'} = 38.1608 \sin 88.392^\circ = 38.1 \text{ MPa} \quad \text{Ans}$$

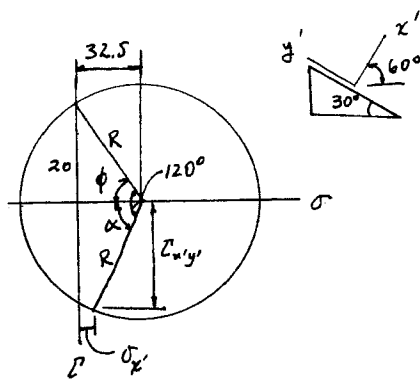

From *Mechanics of Materials*, Sixth Edition by R. C. Hibbeler, ISBN 0-13-191345-X.

© 2005 R. C. Hibbeler. Published by Pearson Prentice Hall,

Pearson Education, Inc., Upper Saddle River, NJ. All rights reserved.

This material is protected under all copyright laws as they currently exist. No portion of this material may be reproduced, in any form or by any means, without permission in writing from the publisher.

9-59 Solve Prob. 9-10 using Mohr's circle.

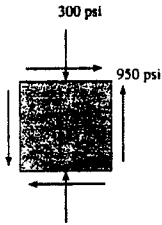

$$\frac{\sigma_x + \sigma_y}{2} = \frac{0 - 300}{2} = -150 \text{ psi}$$

$$R = \sqrt{(150)^2 + (950)^2} = 961.769 \text{ psi}$$

$$\phi = \tan^{-1} \frac{950}{150} = 81.0274^\circ$$

$$\alpha = 180^\circ - 60^\circ - 81.0274^\circ = 38.973^\circ$$

$$\sigma_{x'} = -961.769 \cos 38.973^\circ - 150 = -898 \text{ psi} \quad \text{Ans}$$

$$\tau_{x'y'} = 961.769 \sin 38.973^\circ = 605 \text{ psi} \quad \text{Ans}$$

$$\sigma_{y'} = 961.769 \cos 38.973^\circ - 150 = 598 \text{ psi} \quad \text{Ans}$$

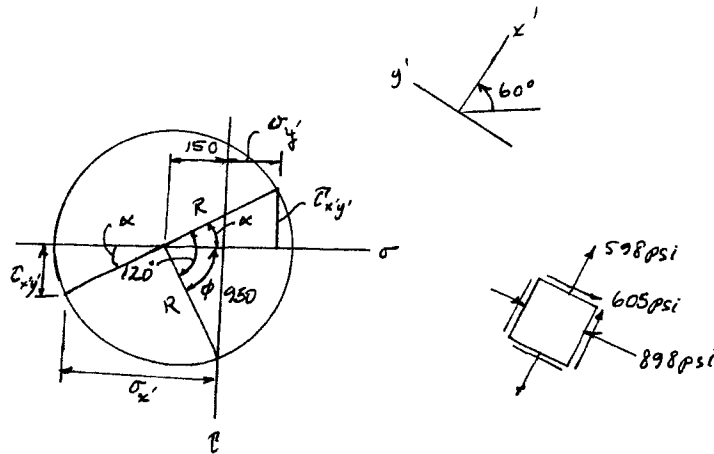

From *Mechanics of Materials*, Sixth Edition by R. C. Hibbeler, ISBN 0-13-191345-X.
 © 2005 R. C. Hibbeler. Published by Pearson Prentice Hall,
 Pearson Education, Inc., Upper Saddle River, NJ. All rights reserved.
 This material is protected under all copyright laws as they currently exist. No portion of this material may be reproduced, in any form or by any means, without permission in writing from the publisher.

*9-60 Solve Prob. 9-6 using Mohr's circle.

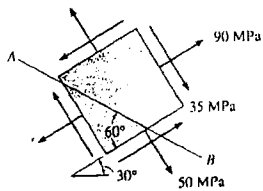

$$\sigma_x = 90 \text{ MPa} \quad \sigma_y = 50 \text{ MPa} \quad \tau_{xy} = -35 \text{ MPa} \quad A(90, -35)$$

$$\frac{\sigma_x + \sigma_y}{2} = \frac{90 + 50}{2} = 70$$

$$R = \sqrt{(90 - 70)^2 + (35)^2} = 40.311$$

Coordinates of point B :

$$\phi = \tan^{-1}\left(\frac{35}{20}\right) = 60.255^\circ$$

$$\psi = 300^\circ - 180^\circ - 60.255^\circ = 59.745^\circ$$

$$\sigma_x' = 70 - 40.311 \cos 59.745^\circ = 49.7 \text{ MPa} \quad \text{Ans}$$

$$\tau_x' = -40.311 \sin 59.745^\circ = -34.8 \text{ MPa} \quad \text{Ans}$$

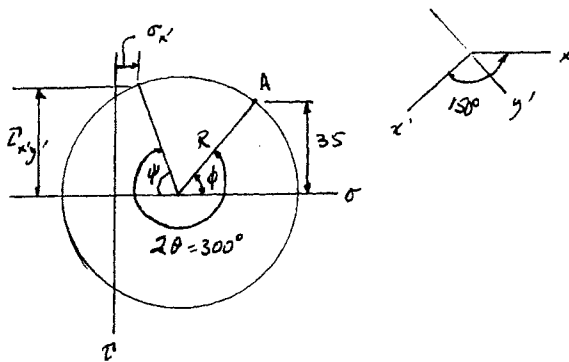

From *Mechanics of Materials*, Sixth Edition by R. C. Hibbeler, ISBN 0-13-191345-X.

© 2005 R. C. Hibbeler. Published by Pearson Prentice Hall,

Pearson Education, Inc., Upper Saddle River, NJ. All rights reserved.

This material is protected under all copyright laws as they currently exist. No portion of this material may be reproduced, in any form or by any means, without permission in writing from the publisher.

9-61 Solve Prob. 9-11 using Mohr's circle.

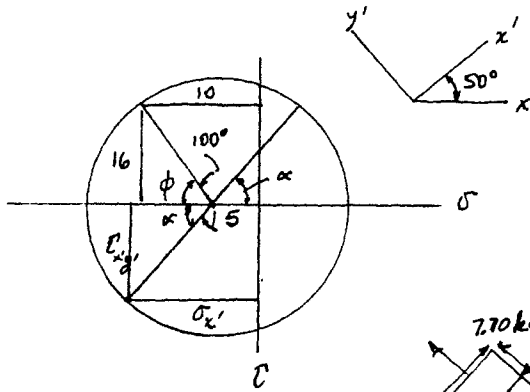
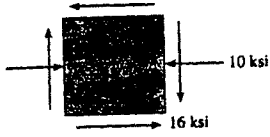

$$\frac{\sigma_x + \sigma_y}{2} = \frac{-10 + 0}{2} = -5 \text{ ksi}$$

$$R = \sqrt{(10 - 5)^2 + (16)^2} = 16.763 \text{ ksi}$$

$$\phi = \tan^{-1} \frac{16}{(10)(5)} = 72.646^\circ$$

$$\alpha = 100 - 72.646 = 27.354^\circ$$

$$\sigma_{x'} = -5 - 16.763 \cos 27.354^\circ = -19.9 \text{ ksi} \quad \text{Ans}$$

$$\tau_{x'y'} = 16.763 \sin 27.354^\circ = 7.70 \text{ ksi} \quad \text{Ans}$$

$$\sigma_{y'} = 16.763 \cos 27.354^\circ - 5 = 9.89 \text{ ksi}$$

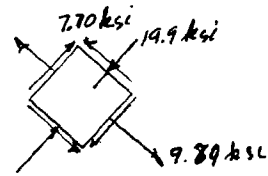

From *Mechanics of Materials*, Sixth Edition by R. C. Hibbeler, ISBN 0-13-191345-X.
 © 2005 R. C. Hibbeler. Published by Pearson Prentice Hall,
 Pearson Education, Inc., Upper Saddle River, NJ. All rights reserved.
 This material is protected under all copyright laws as they currently exist. No portion of this material may be reproduced, in any form or by any means, without permission in writing from the publisher.

9-62 Solve Prob. 9-13 using Mohr's circle.

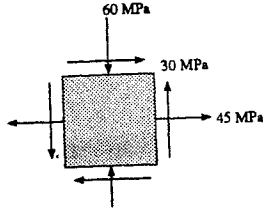

$$\frac{\sigma_x + \sigma_y}{2} = \frac{45 - 60}{2} = -7.5 \text{ MPa}$$

$$R = \sqrt{(45 + 7.5)^2 + (30)^2} = 60.467 \text{ MPa}$$

$$\sigma_1 = 60.467 - 7.5 = 53.0 \text{ MPa} \quad \text{Ans}$$

$$\sigma_2 = -60.467 - 7.5 = -68.0 \text{ MPa} \quad \text{Ans}$$

$$2\theta_{p1} = \tan^{-1} \frac{30}{(45 + 7.5)}$$

$$\theta_{p1} = 14.9^\circ \quad \text{counterclockwise} \quad \text{Ans}$$

$$\tau_{\text{max in-plane}} = 60.5 \text{ MPa} \quad \text{Ans}$$

$$\sigma_{\text{avg}} = -7.50 \text{ MPa} \quad \text{Ans}$$

$$2\theta_{s1} = 90^\circ - \tan^{-1} \frac{30}{(45 + 7.5)}$$

$$\theta_{s1} = 30.1^\circ \quad \text{clockwise} \quad \text{Ans}$$

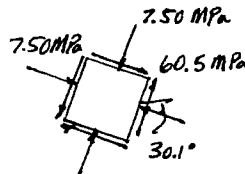
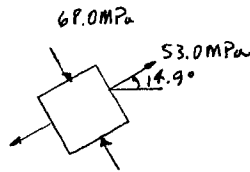
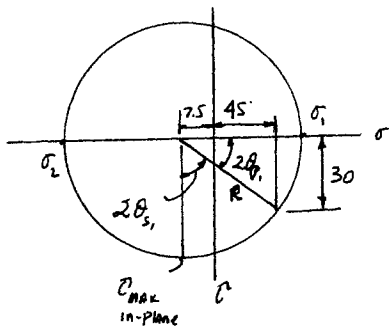

From *Mechanics of Materials*, Sixth Edition by R. C. Hibbeler, ISBN 0-13-191345-X.

© 2005 R. C. Hibbeler. Published by Pearson Prentice Hall,

Pearson Education, Inc., Upper Saddle River, NJ. All rights reserved.

This material is protected under all copyright laws as they currently exist. No portion of this material may be reproduced, in any form or by any means, without permission in writing from the publisher.

9-63 Solve Prob. 9-14 using Mohr's circle.

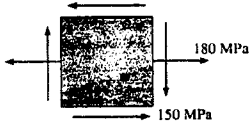

$A(180, -150)$ $B(0, 150)$ $C(90, 0)$

$$R = CA = \sqrt{90^2 + 150^2} = 174.93$$

$$\sigma_1 = 90 + 174.93 = 265 \text{ MPa} \quad \text{Ans}$$

$$\sigma_2 = 90 - 174.93 = -84.9 \text{ MPa} \quad \text{Ans}$$

$$\tan 2\theta_p = \frac{150}{90}; \quad 2\theta_p = 59.04^\circ$$

$$\theta_p = 29.5^\circ \text{ clockwise} \quad \text{Ans}$$

$$\tau_{\max \text{ in-plane}} = R = 174.93 = 175 \text{ MPa} \quad \text{Ans}$$

$$\sigma_{\text{avg}} = 90 \text{ MPa} \quad \text{Ans}$$

$$2\theta_s = 90 - 59.04$$

$$\theta_s = 15.5^\circ \text{ counterclockwise} \quad \text{Ans}$$

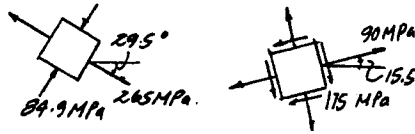
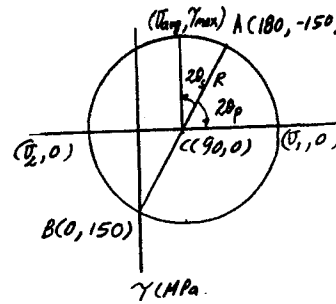

From *Mechanics of Materials*, Sixth Edition by R. C. Hibbeler, ISBN 0-13-191345-X.

© 2005 R. C. Hibbeler. Published by Pearson Prentice Hall,

Pearson Education, Inc., Upper Saddle River, NJ. All rights reserved.

This material is protected under all copyright laws as they currently exist. No portion of this material may be reproduced, in any form or by any means, without permission in writing from the publisher.

*9-64 Solve Prob. 9-16 using Mohr's circle.

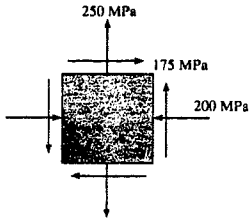

$A(-200, 175) \quad B(250, -175) \quad C(25, 0)$

$R = CA = \sqrt{(200 + 25)^2 + 175^2} = 285.04$

$\tan 2\theta_p = \frac{175}{(200 + 25)} = 0.7777$

$\theta_p = 18.9^\circ$ **Ans**

$\sigma_1 = 25 + 285.04 = 310 \text{ MPa}$ **Ans**

$\sigma_2 = 25 - 285.04 = -260 \text{ MPa}$ **Ans**

$\tau_{\text{max in-plane}} = R = 285 \text{ MPa}$ **Ans**

$\tan 2\theta_s = \frac{200 + 25}{175} = 1.2857$

$\theta_s = 26.1^\circ$ **Ans**

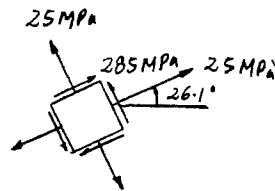
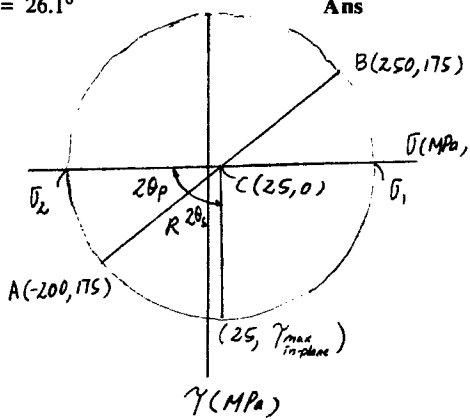
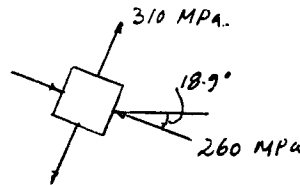

From *Mechanics of Materials*, Sixth Edition by R. C. Hibbeler, ISBN 0-13-191345-X.
 © 2005 R. C. Hibbeler. Published by Pearson Prentice Hall,
 Pearson Education, Inc., Upper Saddle River, NJ. All rights reserved.
 This material is protected under all copyright laws as they currently exist. No portion of this material may be reproduced, in any form or by any means, without permission in writing from the publisher.

9-65 Solve Prob. 9-15 using Mohr's circle.

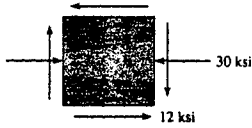

$$\frac{\sigma_x + \sigma_y}{2} = \frac{-30 + 0}{2} = -15$$

$$R = \sqrt{(30 - 15)^2 + (12)^2} = 19.21 \text{ ksi}$$

$$\sigma_1 = 19.21 - 15 = 4.21 \text{ ksi} \quad \text{Ans}$$

$$\sigma_2 = -19.21 - 15 = -34.2 \text{ ksi} \quad \text{Ans}$$

$$2\theta_{p2} = \tan^{-1} \frac{12}{(30 - 15)}; \quad \theta_{p2} = 19.3^\circ$$

$$\tau_{\max \text{ in-plane}} = R = 19.2 \text{ ksi} \quad \text{Ans}$$

$$\sigma_{\text{avg}} = -15 \text{ ksi} \quad \text{Ans}$$

$$2\theta_{s2} = \tan^{-1} \frac{12}{(30 - 15)} + 90^\circ; \quad \theta_{s2} = 64.3^\circ$$

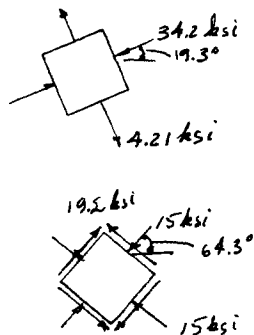
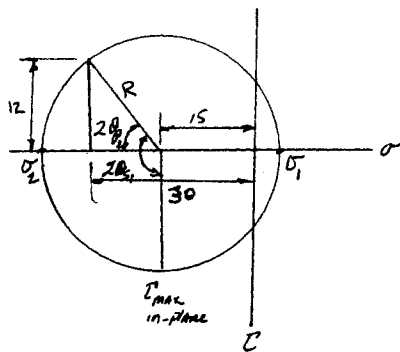

From *Mechanics of Materials*, Sixth Edition by R. C. Hibbeler, ISBN 0-13-191345-X.

© 2005 R. C. Hibbeler. Published by Pearson Prentice Hall,

Pearson Education, Inc., Upper Saddle River, NJ. All rights reserved.

This material is protected under all copyright laws as they currently exist. No portion of this material may be reproduced, in any form or by any means, without permission in writing from the publisher.

9-66 Determine the equivalent state of stress if an element is oriented 60° clockwise from the element shown.

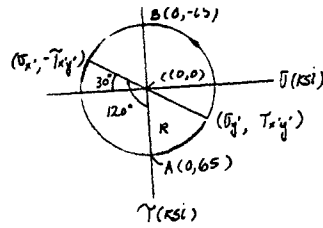
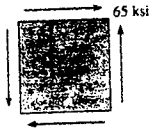

$A(0,65) \quad B(0, - 65) \quad C(10,0)$

$R = 65$

$\sigma_{x'} = 0 - 65 \cos 30^\circ = - 56.3 \text{ ksi} \quad \text{Ans}$

$\sigma_{y'} = 0 + 65 \cos 30^\circ = 56.3 \text{ ksi} \quad \text{Ans}$

$\tau_{x'y'} = -65 \sin 30^\circ = -32.5 \text{ ksi} \quad \text{Ans}$

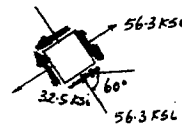

From *Mechanics of Materials*, Sixth Edition by R. C. Hibbeler, ISBN 0-13-191345-X.
 © 2005 R. C. Hibbeler. Published by Pearson Prentice Hall,
 Pearson Education, Inc., Upper Saddle River, NJ. All rights reserved.
 This material is protected under all copyright laws as they currently exist. No portion of this material may be reproduced, in any form or by any means, without permission in writing from the publisher.

9-67. Determine the equivalent state of stress if an element is oriented 60° counterclockwise from the element shown.

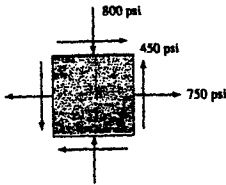

$$A(750, 450) \quad B(-800, -450) \quad C(-25, 0)$$

$$R = CA = CB = \sqrt{775^2 + 450^2} = 896.17$$

$$\sigma_x = 25 + 896.17 \sin 0.141^\circ = -22.8 \text{ psi} \quad \text{Ans}$$

$$\tau_{x'y'} = -896.17 \cos 0.141^\circ = -896 \text{ psi} \quad \text{Ans}$$

$$\sigma_{y'} = -25 - 896.17 \sin 0.141^\circ = -27.2 \text{ psi} \quad \text{Ans}$$

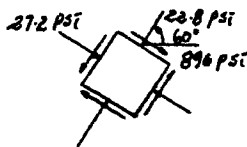
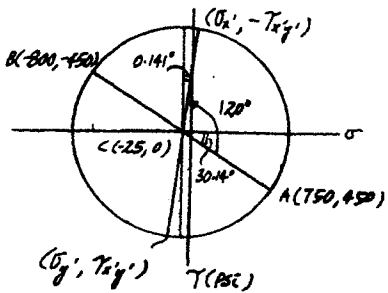

From *Mechanics of Materials*, Sixth Edition by R. C. Hibbeler, ISBN 0-13-191345-X.

© 2005 R. C. Hibbeler. Published by Pearson Prentice Hall,

Pearson Education, Inc., Upper Saddle River, NJ. All rights reserved.

This material is protected under all copyright laws as they currently exist. No portion of this material may be reproduced, in any form or by any means, without permission in writing from the publisher.

*9-68. Determine the equivalent state of stress if an element is oriented 30° clockwise from the element shown.

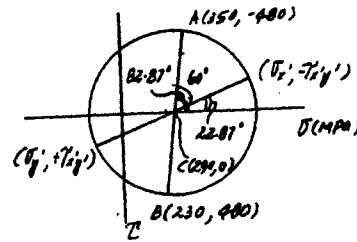
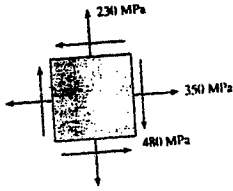

$A(350, -480)$ $B(230, 480)$ $C(290, 0)$

$$R = \sqrt{60^2 + 480^2} = 483.73$$

$$\sigma_x = 290 + 483.73 \cos 22.87^\circ = 736 \text{ MPa} \quad \text{Ans}$$

$$\sigma_y = 290 - 483.73 \cos 22.87^\circ = -156 \text{ MPa} \quad \text{Ans}$$

$$\tau_{x,y} = 483.73 \sin 22.87^\circ = 188 \text{ MPa} \quad \text{Ans}$$

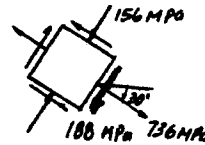

From *Mechanics of Materials*, Sixth Edition by R. C. Hibbeler, ISBN 0-13-191345-X.

© 2005 R. C. Hibbeler. Published by Pearson Prentice Hall,

Pearson Education, Inc., Upper Saddle River, NJ. All rights reserved.

This material is protected under all copyright laws as they currently exist. No portion of this material may be reproduced, in any form or by any means, without permission in writing from the publisher.

9-69 Determine the equivalent state of stress if an element is oriented 25° counterclockwise from the element shown.

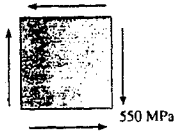

$$A(0, -550) \quad B(0, 550) \quad C(0, 0)$$

$$R = CA = CB = 550$$

$$\sigma_x = -550 \sin 50^\circ = -421 \text{ MPa} \quad \text{Ans}$$

$$\tau_{xy} = -550 \cos 50^\circ = -354 \text{ MPa} \quad \text{Ans}$$

$$\sigma_y = 550 \sin 50^\circ = 421 \text{ MPa} \quad \text{Ans}$$

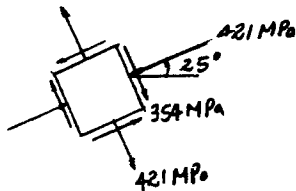
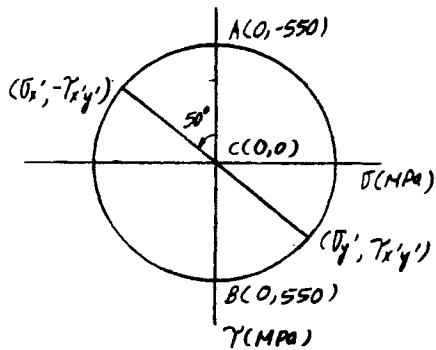

From *Mechanics of Materials*, Sixth Edition by R. C. Hibbeler, ISBN 0-13-191345-X.

© 2005 R. C. Hibbeler. Published by Pearson Prentice Hall,

Pearson Education, Inc., Upper Saddle River, NJ. All rights reserved.

This material is protected under all copyright laws as they currently exist. No portion of this material may be reproduced, in any form or by any means, without permission in writing from the publisher.

9-70 Determine (a) the principal stresses and (b) the maximum in-plane shear stress and average normal stress. Specify the orientation of the element in each case.

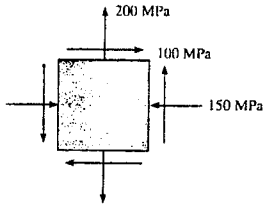

$A(-150, 100)$ $B(200, -100)$ $C(25, 0)$

$R = CA = \sqrt{(150 + 25)^2 + 100^2} = 201.556$

$\tan 2\theta_p = \frac{100}{150 + 25} = 0.5714$

$\theta_p = -14.9^\circ$ **Ans**

$\sigma_1 = 25 + 201.556 = 227 \text{ MPa}$ **Ans**

$\sigma_2 = 25 - 201.556 = -177 \text{ MPa}$ **Ans**

$\tau_{\max \text{ in-plane}} = R = 202 \text{ MPa}$ **Ans**

$\sigma_{\text{avg}} = 25 \text{ MPa}$ **Ans**

$\tan 2\theta_s = \frac{150 + 25}{100} = 1.75$

$\theta_s = 30.1^\circ$ **Ans**

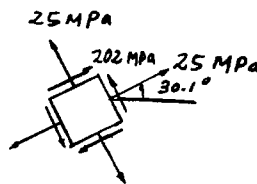
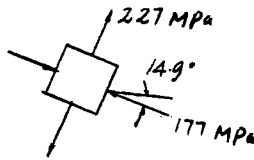
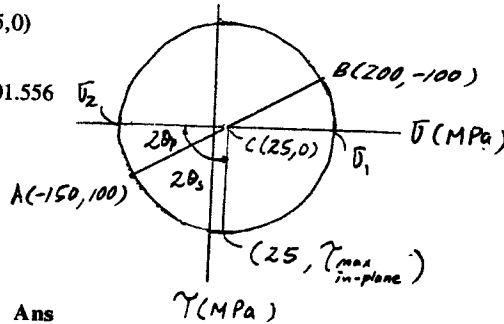

From *Mechanics of Materials*, Sixth Edition by R. C. Hibbeler, ISBN 0-13-191345-X.
 © 2005 R. C. Hibbeler. Published by Pearson Prentice Hall,
 Pearson Education, Inc., Upper Saddle River, NJ. All rights reserved.
 This material is protected under all copyright laws as they currently exist. No portion of this material may be reproduced, in any form or by any means, without permission in writing from the publisher.

9-71 Determine (a) the principal stresses and (b) the maximum in-plane shear stress and average normal stress. Specify the orientation of the element in each case.

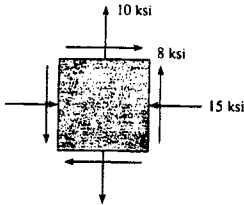

$A(-15,8), \quad B(10,-8), \quad C(-2.5,0)$

$R = CA = CB = \sqrt{12.5^2 + 8^2} = 14.84$

a)

$\sigma_1 = -2.5 + 14.84 = 12.3 \text{ ksi} \quad \text{Ans}$
 $\sigma_2 = -2.5 - 14.84 = -17.3 \text{ ksi} \quad \text{Ans}$

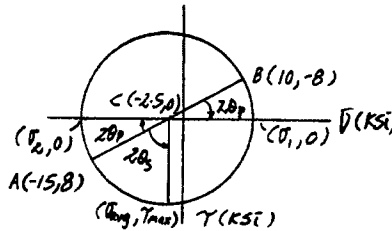

$\tan 2\theta_p = \frac{8}{12.5} \quad 2\theta_p = 32.62^\circ \quad \theta_p = 16.3^\circ \quad \text{Ans}$

b)

$\tau_{\text{max in-plane}} = R = 14.8 \text{ ksi} \quad \text{Ans}$
 $\sigma_{\text{avg}} = -2.5 \text{ ksi} \quad \text{Ans}$
 $2\theta_s = 90 - 2\theta_p$
 $\theta_s = 28.7^\circ$

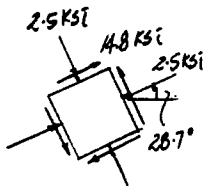
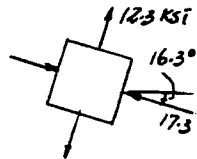

From *Mechanics of Materials*, Sixth Edition by R. C. Hibbeler, ISBN 0-13-191345-X.
 © 2005 R. C. Hibbeler. Published by Pearson Prentice Hall,
 Pearson Education, Inc., Upper Saddle River, NJ. All rights reserved.
 This material is protected under all copyright laws as they currently exist. No portion of this material may be reproduced, in any form or by any means, without permission in writing from the publisher.

*9-72 Determine (a) the principal stresses and (b) the maximum in-plane shear stress and average normal stress. Specify the orientation of the element in each case.

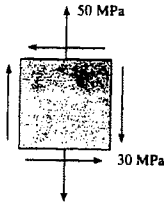

$A(0, -30)$ $B(50, 30)$ $C(25, 0)$

$$R = CA = CB = \sqrt{25^2 + 30^2} = 39.05$$

a)

$$\sigma_1 = 25 + 39.05 = 64.1 \text{ MPa} \quad \text{Ans}$$

$$\sigma_2 = 25 - 39.05 = -14.1 \text{ MPa} \quad \text{Ans}$$

$$\tan 2\theta_p = \frac{30}{25} \quad 2\theta_p = 50.19^\circ \quad \theta_p = 25.1^\circ$$

b)

$$\tau_{\text{max in-plane}} = R = 39.1 \text{ MPa} \quad \text{Ans}$$

$$\sigma_{\text{avg}} = 25 \text{ MPa} \quad \text{Ans}$$

$$2\theta_s = 90 - 2\theta_p$$

$$\theta_s = -19.9^\circ$$

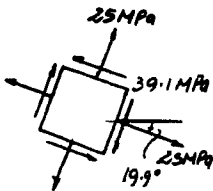
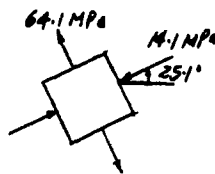
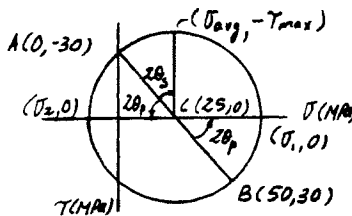

From *Mechanics of Materials*, Sixth Edition by R. C. Hibbeler, ISBN 0-13-191345-X.

© 2005 R. C. Hibbeler. Published by Pearson Prentice Hall,

Pearson Education, Inc., Upper Saddle River, NJ. All rights reserved.

This material is protected under all copyright laws as they currently exist. No portion of this material may be reproduced, in any form or by any means, without permission in writing from the publisher.

9-73 Determine (a) the principal stresses and (b) the maximum in-plane shear stress and average normal stress. Specify the orientation of the element in each case.

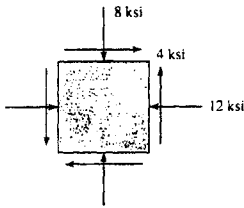

$A(-12,4)$ $B(-8,-4)$ $C(-10,0)$

$R = CA = CB = \sqrt{2^2 + 4^2} = 4.472$

a)

$\sigma_1 = -10 + 4.472 = -5.53 \text{ ksi}$ **Ans**
 $\sigma_2 = -10 - 4.472 = -14.5 \text{ ksi}$ **Ans**

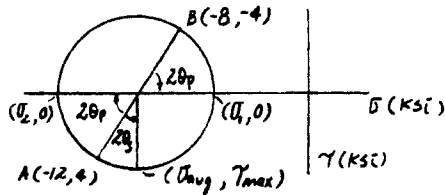

$\tan 2\theta_p = \frac{4}{2}$ $2\theta_p = 63.43^\circ$ $\theta_p = 31.7^\circ$

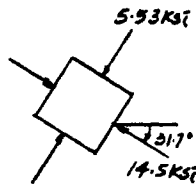

b)

$\tau_{\max \text{ in-plane}} = R = 4.47 \text{ ksi}$ **Ans**
 $\sigma_{\text{avg}} = -10 \text{ ksi}$ **Ans**
 $2\theta_s = 90 - 2\theta_p$
 $\theta_s = 13.3^\circ$

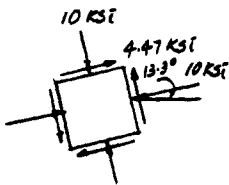

From *Mechanics of Materials*, Sixth Edition by R. C. Hibbeler, ISBN 0-13-191345-X.
 © 2005 R. C. Hibbeler. Published by Pearson Prentice Hall,
 Pearson Education, Inc., Upper Saddle River, NJ. All rights reserved.
 This material is protected under all copyright laws as they currently exist. No portion of this material may be reproduced, in any form or by any means, without permission in writing from the publisher.

9-74 Determine (a) the principal stresses and (b) the maximum in-plane shear stress and average normal stress. Specify the orientation of the element in each case.

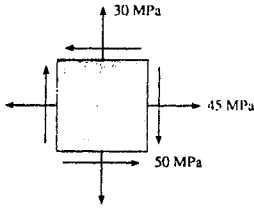

$A(45, -50) \quad B(30, 50) \quad C(37.5, 0)$

$R = CA = CB = \sqrt{7.5^2 + 50^2} = 50.56$

a)

$\sigma_1 = 37.5 + 50.56 = 88.1 \text{ MPa} \quad \text{Ans}$
 $\sigma_2 = 37.5 - 50.56 = -13.1 \text{ MPa} \quad \text{Ans}$

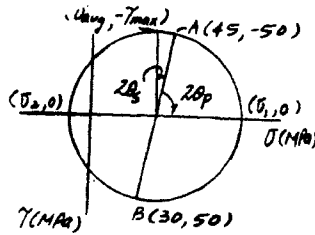

$\tan 2\theta_p = \frac{50}{7.5} \quad 2\theta_p = 81.47^\circ \quad \theta_p = -40.7^\circ$

b)

$\tau_{\text{max in-plane}} = R = 50.6 \text{ MPa} \quad \text{Ans}$
 $\sigma_{\text{avg}} = 37.5 \text{ MPa} \quad \text{Ans}$
 $2\theta_s = 90 - 2\theta_p$
 $\theta_s = 4.27^\circ$

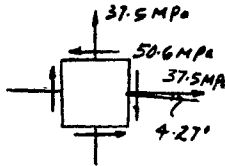
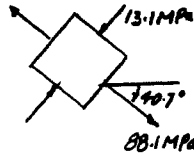

From *Mechanics of Materials*, Sixth Edition by R. C. Hibbeler, ISBN 0-13-191345-X.
 © 2005 R. C. Hibbeler. Published by Pearson Prentice Hall,
 Pearson Education, Inc., Upper Saddle River, NJ. All rights reserved.
 This material is protected under all copyright laws as they currently exist. No portion of this material may be reproduced, in any form or by any means, without permission in writing from the publisher.

9-75 Determine (a) the principal stresses and (b) the maximum in-plane shear stress and average normal stress. Specify the orientation of the element in each case.

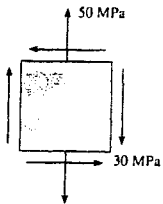

$A(0, -30) \quad B(50, 30) \quad C(25, 0)$

$R = CA = \sqrt{(25 - 0)^2 + 30^2} = 39.05$

$\sigma_1 = 25 + 39.05 = 64.1 \text{ MPa} \quad \text{Ans}$

$\sigma_2 = 25 - 39.05 = -14.1 \text{ MPa} \quad \text{Ans}$

$\tan 2\theta_p = \frac{30}{25 - 0} = 1.2$

$\theta_p = 25.1^\circ \quad \text{Ans}$

$\sigma_{avg} = 25.0 \text{ MPa} \quad \text{Ans}$

$\tau_{max \text{ in-plane}} = R = 39.1 \text{ MPa} \quad \text{Ans}$

$\tan 2\theta_s = \frac{25 - 0}{30} = 0.8333$

$\theta_s = -19.9^\circ \quad \text{Ans}$

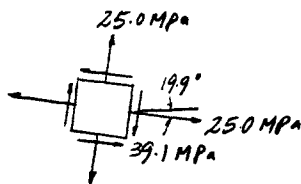
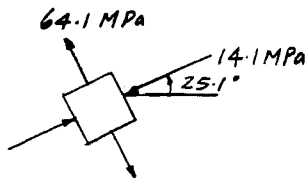
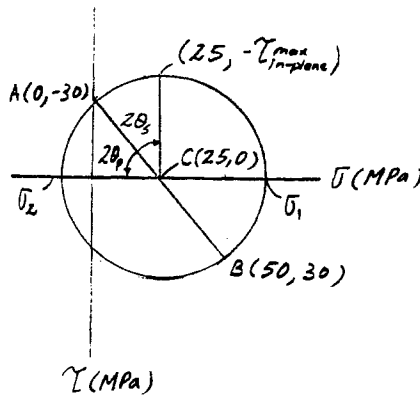

From *Mechanics of Materials*, Sixth Edition by R. C. Hibbeler, ISBN 0-13-191345-X.
 © 2005 R. C. Hibbeler. Published by Pearson Prentice Hall,
 Pearson Education, Inc., Upper Saddle River, NJ. All rights reserved.
 This material is protected under all copyright laws as they currently exist. No portion of this material may be reproduced, in any form or by any means, without permission in writing from the publisher.

***9-76.** Determine (a) the principal stresses and (b) the maximum in-plane shear stress and average normal stress. Specify the orientation of the element in each case.

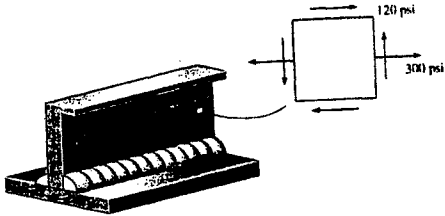

$A(300, 120) \quad B(0, -120) \quad C(150, 0)$

$R = \sqrt{(300 - 150)^2 + 120^2} = 192.094$

$\sigma_1 = 150 + 192.094 = 342 \text{ psi} \quad \text{Ans}$

$\sigma_2 = 150 - 192.094 = -42.1 \text{ psi} \quad \text{Ans}$

$\tan 2\theta_p = \frac{120}{300 - 150} = 0.8$

$\theta_p = 19.3^\circ \quad \text{Ans}$

$\sigma_{avg} = 150 \text{ psi} \quad \text{Ans}$

$\tau_{max} = 192 \text{ psi} \quad \text{Ans}$

$\tan 2\theta_s = \frac{300 - 150}{120} = 1.25$

$\theta_s = 25.7^\circ \quad \text{Ans}$

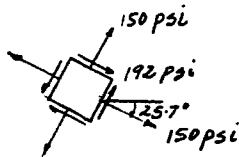
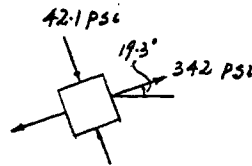
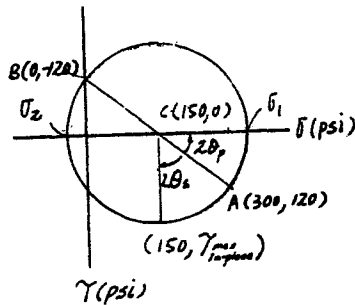

From *Mechanics of Materials*, Sixth Edition by R. C. Hibbeler, ISBN 0-13-191345-X.
 © 2005 R. C. Hibbeler. Published by Pearson Prentice Hall,
 Pearson Education, Inc., Upper Saddle River, NJ. All rights reserved.
 This material is protected under all copyright laws as they currently exist. No portion of this material may be reproduced, in any form or by any means, without permission in writing from the publisher.

9-77 Draw Mohr's circle that describes each of the following states of stress.

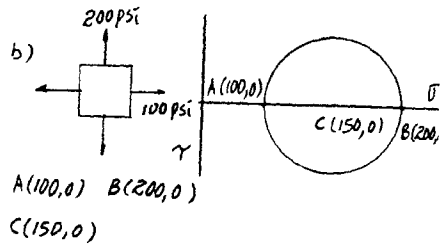
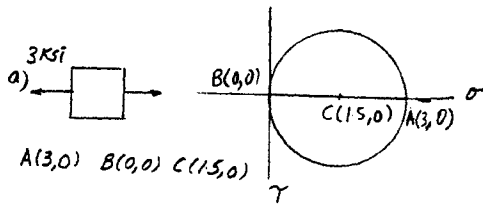
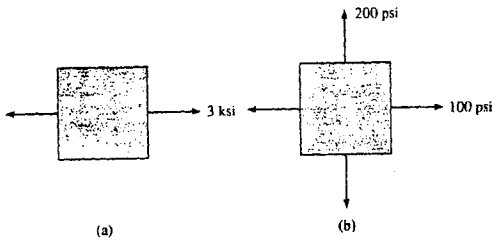

From *Mechanics of Materials*, Sixth Edition by R. C. Hibbeler, ISBN 0-13-191345-X.

© 2005 R. C. Hibbeler. Published by Pearson Prentice Hall,

Pearson Education, Inc., Upper Saddle River, NJ. All rights reserved.

This material is protected under all copyright laws as they currently exist. No portion of this material may be reproduced, in any form or by any means, without permission in writing from the publisher.

9-78 Draw Mohr's circle that describes each of the following states of stress.

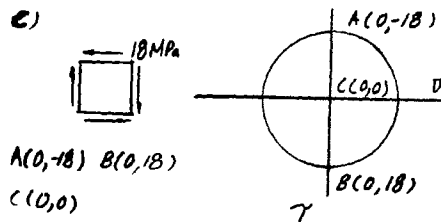
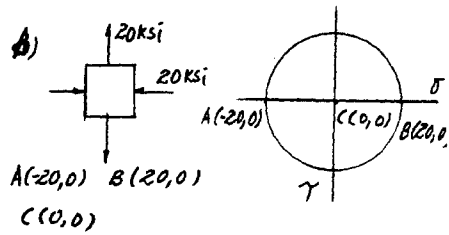
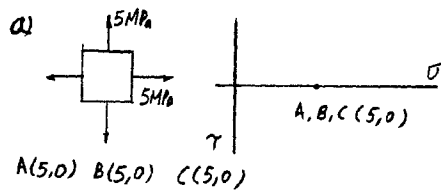
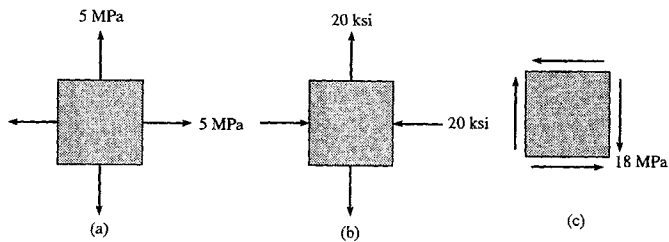

From *Mechanics of Materials*, Sixth Edition by R. C. Hibbeler, ISBN 0-13-191345-X.
 © 2005 R. C. Hibbeler. Published by Pearson Prentice Hall,
 Pearson Education, Inc., Upper Saddle River, NJ. All rights reserved.
 This material is protected under all copyright laws as they currently exist. No portion of this material may be reproduced, in any form or by any means, without permission in writing from the publisher.

9-79 A point on a thin plate is subjected to two successive states of stress as shown. Determine the resulting state of stress with reference to an element oriented as shown on the right.

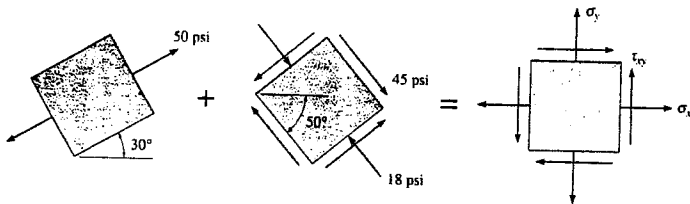

For element *a* :

$$A(50,0) \quad B(0,0) \quad C(25,0)$$

$$R = 50 - 25 = 25$$

$$(\sigma_x)_a = 25 + 25 \cos 60^\circ = 37.5 \text{ psi}$$

$$(\sigma_y)_a = 25 - 25 \cos 60^\circ = 12.5 \text{ psi}$$

$$(\tau_{xy})_a = 25 \sin 60^\circ = 21.65 \text{ psi}$$

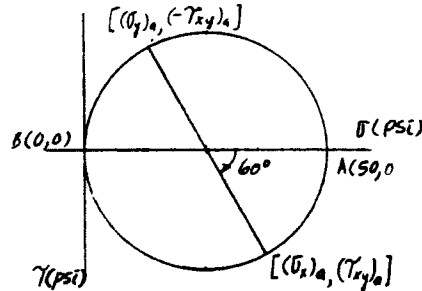

For element *b* :

$$A(0,-45) \quad B(-18,45) \quad C(-9,0)$$

$$R = \sqrt{9^2 + 45^2} = 45.89$$

$$(\sigma_x)_b = -9 + 45.89 \cos 1.31^\circ = 36.88 \text{ psi}$$

$$(\sigma_y)_b = -9 - 45.89 \cos 1.31^\circ = -54.88 \text{ psi}$$

$$(\tau_{xy})_b = 45.89 \sin 1.31^\circ = 1.049 \text{ psi}$$

$$\sigma_x = (\sigma_x)_a + (\sigma_x)_b = 37.5 + 36.88 = 74.4 \text{ psi} \quad \text{Ans}$$

$$\sigma_y = (\sigma_y)_a + (\sigma_y)_b = 12.5 - 54.88 = -42.4 \text{ psi} \quad \text{Ans}$$

$$\tau_{xy} = (\tau_{xy})_a + (\tau_{xy})_b = 21.65 + 1.049 = 22.7 \text{ psi} \quad \text{Ans}$$

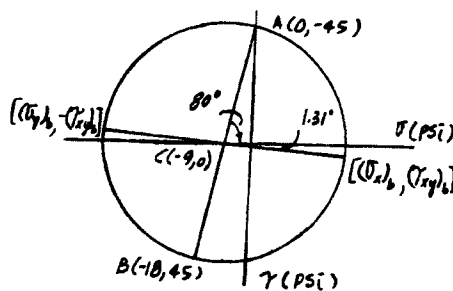

From *Mechanics of Materials*, Sixth Edition by R. C. Hibbeler, ISBN 0-13-191345-X.

© 2005 R. C. Hibbeler. Published by Pearson Prentice Hall,

Pearson Education, Inc., Upper Saddle River, NJ. All rights reserved.

This material is protected under all copyright laws as they currently exist. No portion of this material may be reproduced, in any form or by any means, without permission in writing from the publisher.

*9-80 Mohr's circle for the state of stress in Fig. 9-15a is shown in Fig. 9-15b. Show that finding the coordinates of point $P(\sigma_x, \tau_{xy})$ on the circle gives the same value as the stress-transformation Eqs. 9-1 and 9-2.

$$A(\sigma_x, \tau_{xy}) \quad B(\sigma_y, -\tau_{xy}) \quad C\left(\frac{\sigma_x + \sigma_y}{2}, 0\right)$$

$$R = \sqrt{\left[\sigma_x - \left(\frac{\sigma_x + \sigma_y}{2}\right)\right]^2 + \tau_{xy}^2} = \sqrt{\left(\frac{\sigma_x - \sigma_y}{2}\right)^2 + \tau_{xy}^2}$$

$$\sigma_x' = \frac{\sigma_x + \sigma_y}{2} + \sqrt{\left(\frac{\sigma_x - \sigma_y}{2}\right)^2 + \tau_{xy}^2} \cos \theta' \quad (1)$$

$$\theta' = 2\theta_p - 2\theta$$

$$\cos(2\theta_p - 2\theta) = \cos 2\theta_p \cos 2\theta + \sin 2\theta_p \sin 2\theta \quad (2)$$

From the circle :

$$\cos 2\theta_p = \frac{\sigma_x - \frac{\sigma_x + \sigma_y}{2}}{\sqrt{\left(\frac{\sigma_x - \sigma_y}{2}\right)^2 + \tau_{xy}^2}} \quad (3)$$

$$\sin 2\theta_p = \frac{\tau_{xy}}{\sqrt{\left(\frac{\sigma_x - \sigma_y}{2}\right)^2 + \tau_{xy}^2}} \quad (4)$$

Substitute Eq. (2), (3) and (4) into Eq. (1)

$$\sigma_x' = \frac{\sigma_x + \sigma_y}{2} + \frac{\sigma_x - \sigma_y}{2} \cos 2\theta + \tau_{xy} \sin 2\theta \quad \mathbf{QED}$$

$$\tau_{x'y'} = \sqrt{\left(\frac{\sigma_x - \sigma_y}{2}\right)^2 + \tau_{xy}^2} \sin \theta' \quad (5)$$

$$\begin{aligned} \sin \theta' &= \sin(2\theta_p - 2\theta) \\ &= \sin 2\theta_p \cos 2\theta - \sin 2\theta \cos 2\theta_p \quad (6) \end{aligned}$$

Substitute Eq. (3), (4), (6) into Eq. (5),

$$\tau_{x'y'} = -\frac{\sigma_x - \sigma_y}{2} \sin 2\theta + \tau_{xy} \cos 2\theta \quad \mathbf{QED}$$

From *Mechanics of Materials*, Sixth Edition by R. C. Hibbeler, ISBN 0-13-191345-X.

© 2005 R. C. Hibbeler. Published by Pearson Prentice Hall,

Pearson Education, Inc., Upper Saddle River, NJ. All rights reserved.

This material is protected under all copyright laws as they currently exist. No portion of this material may be reproduced, in any form or by any means, without permission in writing from the publisher.

9-81. The grains of wood in the board make an angle of 20° with the horizontal as shown. Determine the normal and shear stresses that act perpendicular and parallel to the grains if the board is subjected to an axial load of 250 N.



$$\sigma_x = \frac{P}{A} = \frac{250}{(0.06)(0.025)} = 166.67 \text{ kPa}$$

$$R = 83.33$$

Coordinates of point B :

$$\sigma_{x'} = 83.33 - 83.33 \cos 40^\circ$$

$$\sigma_{x'} = 19.5 \text{ kPa} \quad \text{Ans}$$

$$\tau_{x'y'} = -83.33 \sin 40^\circ = -53.6 \text{ kPa} \quad \text{Ans}$$

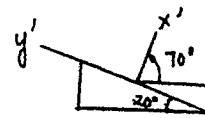
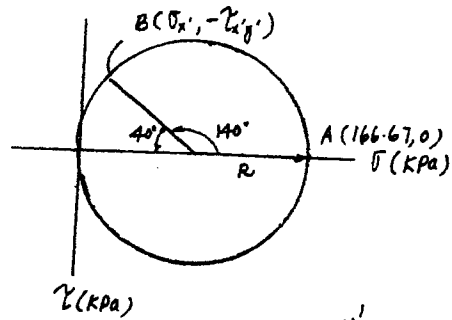

From *Mechanics of Materials*, Sixth Edition by R. C. Hibbeler, ISBN 0-13-191345-X.

© 2005 R. C. Hibbeler. Published by Pearson Prentice Hall,

Pearson Education, Inc., Upper Saddle River, NJ. All rights reserved.

This material is protected under all copyright laws as they currently exist. No portion of this material may be reproduced, in any form or by any means, without permission in writing from the publisher.

9-82 The post has a square cross-sectional area. If it is fixed-supported at its base and a horizontal force is applied at its end as shown, determine (a) the maximum in-plane shear stress developed at A and (b) the principal stresses at A.

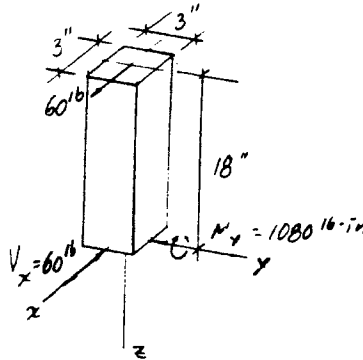
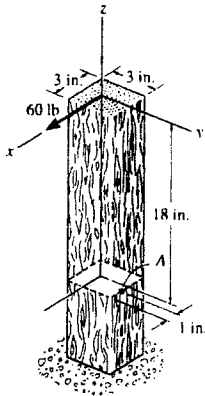

$$I = \frac{1}{12}(3)(3^3) = 6.75 \text{ in}^4 \quad Q_A = (1)(1)(3) = 3 \text{ in}^3$$

$$\sigma_A = -\frac{M_y x}{I} = -\frac{1080(0.5)}{6.75} = -80 \text{ psi}$$

$$\tau_A = \frac{V_y Q_A}{It} = \frac{60(3)}{6.75(3)} = 8.889 \text{ psi}$$

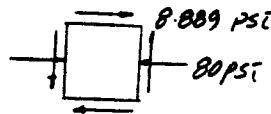

$$A(-80, 8.889) \quad B(0, -8.889) \quad C(-40, 0)$$

$$\tau_{\max \text{ in-plane}} = R = \sqrt{40^2 + 8.889^2} = 41.0 \text{ psi} \quad \text{Ans}$$

$$\sigma_1 = -40 + 40.9757 = 0.976 \text{ psi} \quad \text{Ans}$$

$$\sigma_2 = -40 - 40.9757 = -81.0 \text{ psi} \quad \text{Ans}$$

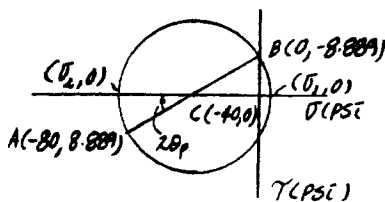

From *Mechanics of Materials*, Sixth Edition by R. C. Hibbeler, ISBN 0-13-191345-X.

© 2005 R. C. Hibbeler. Published by Pearson Prentice Hall,

Pearson Education, Inc., Upper Saddle River, NJ. All rights reserved.

This material is protected under all copyright laws as they currently exist. No portion of this material may be reproduced, in any form or by any means, without permission in writing from the publisher.

9-83 The concrete dam rests on a pervious foundation and is subjected to the hydrostatic pressures shown. If it has a width of 6 ft, determine the principal stresses acting in the concrete at point A. Show the results on a properly oriented element at the point. The specific weight of the concrete is $\gamma = 150 \text{ lb/ft}^3$.

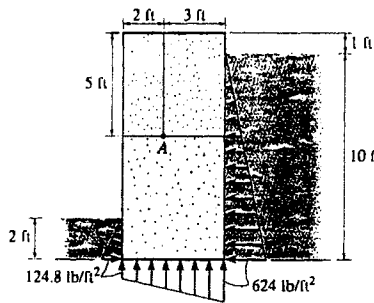

$$W = 150(6)(5)(5) = 22\,500 \text{ lb}$$

$$F = \frac{1}{2}(249.6)(4)(6) = 2995.2 \text{ lb}$$

$$\begin{aligned} \rightarrow \Sigma F_x = 0; \quad V - 2995.2 &= 0 \\ V &= 2995.2 \text{ lb} \end{aligned}$$

$$\begin{aligned} + \uparrow \Sigma F_y = 0; \quad N - 22\,500 &= 0 \\ N &= 22\,500 \text{ lb} \end{aligned}$$

$$\begin{aligned} \curvearrowright \Sigma M = 0; \quad -M + 2995.2(1.3333) &= 0 \\ M &= 3993.6 \text{ lb} \cdot \text{ft} \end{aligned}$$

$$\sigma_A = \frac{P}{A} + \frac{My}{I} = \frac{22\,500}{(5)(6)} + \frac{3993.6(0.5)}{\frac{1}{12}(6)(5)^3} = 781.95 \text{ psf} = 5.4302 \text{ psi}$$

$$\tau_A = \frac{VQ}{It} = \frac{2995.2(1.5)(2)(6)}{\frac{1}{12}(6)(5)^3(6)} = 143.77 \text{ psf} = 0.9984 \text{ psi}$$

$$\sigma_{avg} = \frac{\sigma_x + \sigma_y}{2} = \frac{0 - 5.4302}{2} = -2.715 \text{ psi}$$

$$R = \sqrt{(0.9984)^2 + (2.715)^2} = 2.8929 \text{ psi}$$

$$\sigma_1 = 2.8929 - 2.715 = 0.178 \text{ psi} \quad \text{Ans}$$

$$\sigma_2 = -(2.715 + 2.8929) = -5.61 \text{ psi} \quad \text{Ans}$$

$$2\theta = \tan^{-1} \left(\frac{0.9984}{2.715} \right) = 20.2^\circ$$

$$\theta = 10.1^\circ$$

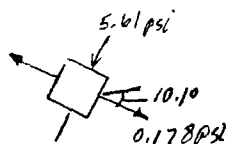
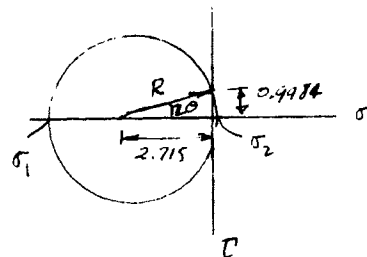
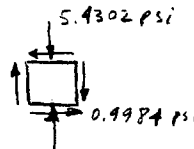
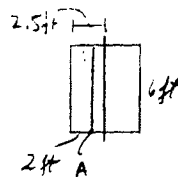
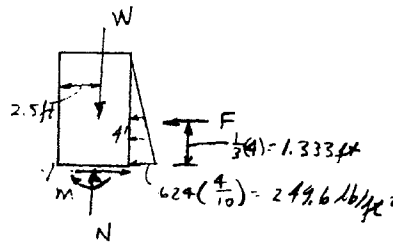

From *Mechanics of Materials*, Sixth Edition by R. C. Hibbeler, ISBN 0-13-191345-X.
 © 2005 R. C. Hibbeler. Published by Pearson Prentice Hall,
 Pearson Education, Inc., Upper Saddle River, NJ. All rights reserved.
 This material is protected under all copyright laws as they currently exist. No portion of this material may be reproduced, in any form or by any means, without permission in writing from the publisher.

*9-84 The ladder is supported on the rough surface at A and by a smooth wall at B . If a man weighing 150 lb stands upright at C , determine the principal stresses in one of the legs at point D . Each leg is made from a 1-in.-thick board having a rectangular cross section. Assume that the total weight of the man is exerted vertically on the rung at C and is shared equally by each of the ladder's two legs. Neglect the weight of the ladder and the forces developed by the man's arms.

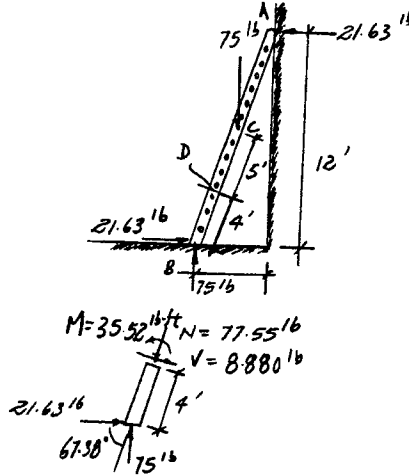
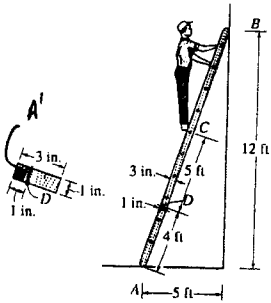

$$A = 3(1) = 3 \text{ in}^2 \quad I = \frac{1}{12}(1)(3^3) = 2.25 \text{ in}^4$$

$$Q_D = y'A' = (1)(1)(1) = 1 \text{ in}^3$$

$$\sigma_D = \frac{-P}{A} - \frac{My}{I} = \frac{-77.55}{3} - \frac{35.52(12)(0.5)}{2.25} = -120.570 \text{ psi}$$

$$\tau_D = \frac{VQ_D}{It} = \frac{8.88(1)}{2.25(1)} = 3.947 \text{ psi}$$

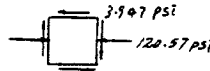

$$A(-120.57, -3.947) \quad B(0, 3.947) \quad C(-60.285, 0)$$

$$R = \sqrt{(60.285)^2 + (3.947)^2} = 60.412$$

$$\sigma_1 = -60.285 + 60.4125 = 0.129 \text{ psi} \quad \text{Ans}$$

$$\sigma_2 = -60.285 - 60.4125 = -121 \text{ psi} \quad \text{Ans}$$

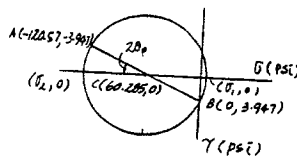

From *Mechanics of Materials*, Sixth Edition by R. C. Hibbeler, ISBN 0-13-191345-X.
 © 2005 R. C. Hibbeler. Published by Pearson Prentice Hall,
 Pearson Education, Inc., Upper Saddle River, NJ. All rights reserved.
 This material is protected under all copyright laws as they currently exist. No portion of this material may be reproduced, in any form or by any means, without permission in writing from the publisher.

9-85 A spherical pressure vessel has an inner radius of 5 ft and a wall thickness of 0.5 in. Draw Mohr's circle for the state of stress at a point on the vessel and explain the significance of the result. The vessel is subjected to an internal pressure of 80 psi.

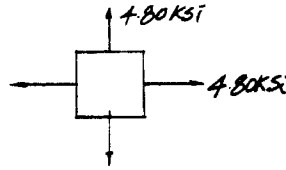

Normal stress :

$$\sigma_1 = \sigma_2 = \frac{p r}{2 t} = \frac{80(5)(12)}{2(0.5)} = 4.80 \text{ ksi}$$

Mohr's circle :

$$A(4.80, 0) \quad B(4.80, 0) \quad C(0, 0)$$

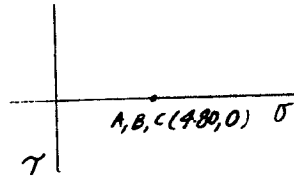

Regardless of the orientation of the element, the shear stress is zero and the state of stress is represented by the same two normal stress components.

From *Mechanics of Materials*, Sixth Edition by R. C. Hibbeler, ISBN 0-13-191345-X.

© 2005 R. C. Hibbeler. Published by Pearson Prentice Hall,

Pearson Education, Inc., Upper Saddle River, NJ. All rights reserved.

This material is protected under all copyright laws as they currently exist. No portion of this material may be reproduced, in any form or by any means, without permission in writing from the publisher.

9-86. The cylindrical pressure vessel has an inner radius of 1.25 m and a wall thickness of 15 mm. It is made from steel plates that are welded along the 45° seam. Determine the normal and shear stress components along this seam if the vessel is subjected to an internal pressure of 8 MPa.

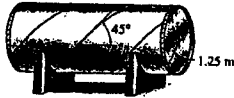

$$\sigma_x = \frac{pr}{2t} = \frac{8(1.25)}{2(0.015)} = 333.33 \text{ MPa}$$

$$\sigma_y = 2\sigma_x = 666.67 \text{ MPa}$$

$$A(333.33, 0) \quad B(666.67, 0) \quad C(500, 0)$$

$$\sigma_x = \frac{333.33 + 666.67}{2} = 500 \text{ MPa} \quad \text{Ans}$$

$$\tau_{x'y'} = R = 666.67 - 500 = 167 \text{ MPa} \quad \text{Ans}$$

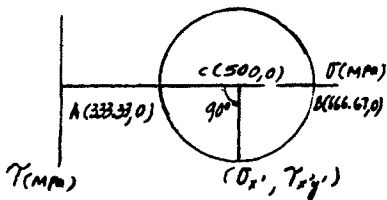
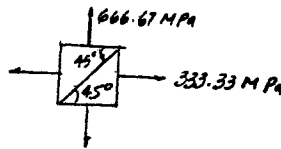

From *Mechanics of Materials*, Sixth Edition by R. C. Hibbeler, ISBN 0-13-191345-X.

© 2005 R. C. Hibbeler. Published by Pearson Prentice Hall,

Pearson Education, Inc., Upper Saddle River, NJ. All rights reserved.

This material is protected under all copyright laws as they currently exist. No portion of this material may be reproduced, in any form or by any means, without permission in writing from the publisher.

9-87 The post has a square cross-sectional area. If it is fixed-supported at its base and the loadings are applied at its end as shown, determine (a) the maximum in-plane shear stress developed at A and (b) the principal stresses at A.

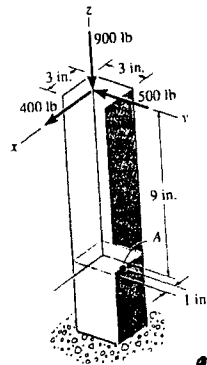

Section properties :

$$I_x = I_y = \frac{1}{12}(3)(3^3) = 6.75 \text{ in}^4$$

$$A = 3(3) = 9 \text{ in}^2$$

$$(Q_A)_x = \bar{y}'A' = (1)(1)(3) = 3 \text{ in}^3$$

$$(Q_A)_y = 0$$

Normal stress : Applying $\sigma = \frac{P}{A} + \frac{M_x y}{I_x} + \frac{M_y x}{I_y}$

$$\sigma_A = -\frac{900}{9} + \frac{4500(1.5)}{6.75} - \frac{3600(0.5)}{6.75} = 633.33 \text{ psi}$$

Shear stress : Applying $\tau = \frac{VQ}{It}$

$$\tau_{zx} = \frac{400(3)}{6.75(3)} = 59.259 \text{ psi}$$

$$\tau_{zy} = 0$$

Mohr's circle :

$$A(633.33, 59.26) \quad C(316.67, 0)$$

$$R = CA = \sqrt{(633.33 - 316.67)^2 + 59.26^2} = 322.16$$

a) $\tau_{\text{max in-plane}} = R = 322 \text{ psi}$ Ans

b) $\sigma_1 = 316.67 + 322.16 = 639 \text{ psi}$ Ans

$\sigma_2 = 316.67 - 322.16 = -5.50 \text{ psi}$ Ans

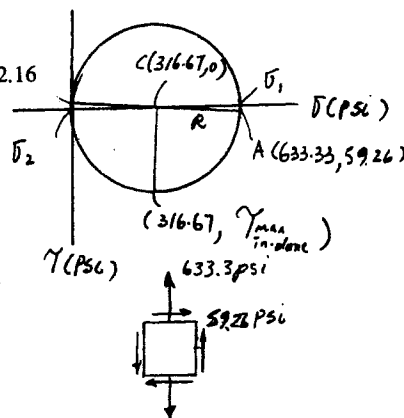
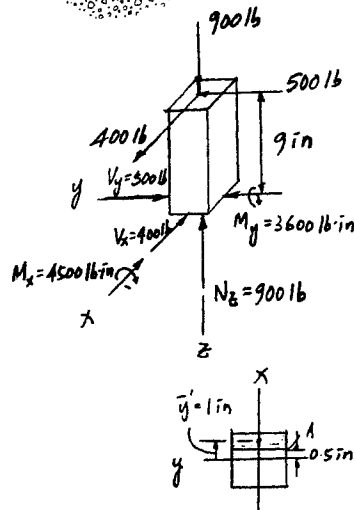

From *Mechanics of Materials*, Sixth Edition by R. C. Hibbeler, ISBN 0-13-191345-X.

© 2005 R. C. Hibbeler. Published by Pearson Prentice Hall,

Pearson Education, Inc., Upper Saddle River, NJ. All rights reserved.

This material is protected under all copyright laws as they currently exist. No portion of this material may be reproduced, in any form or by any means, without permission in writing from the publisher.

*9-88 Draw the three Mohr's circles that describe each of the following states of stress.

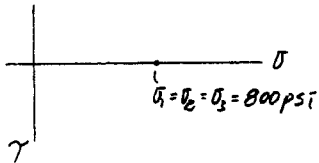
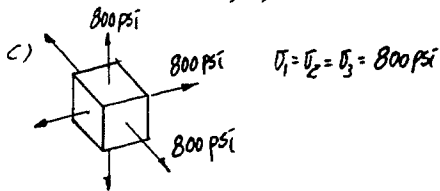
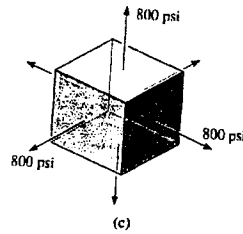
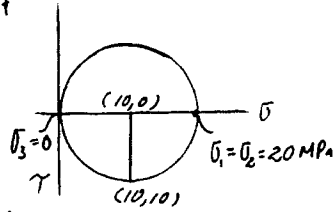
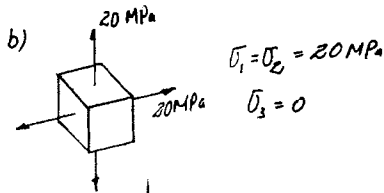
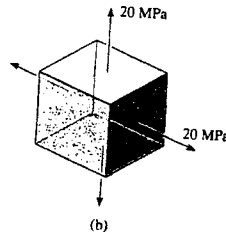
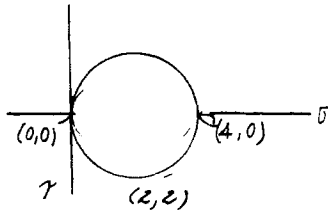
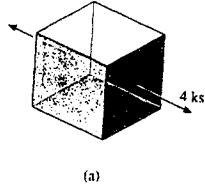
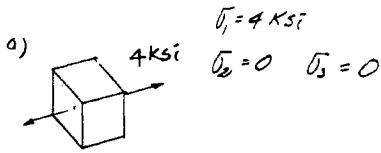

From *Mechanics of Materials*, Sixth Edition by R. C. Hibbeler, ISBN 0-13-191345-X.

© 2005 R. C. Hibbeler. Published by Pearson Prentice Hall,

Pearson Education, Inc., Upper Saddle River, NJ. All rights reserved.

This material is protected under all copyright laws as they currently exist. No portion of this material may be reproduced, in any form or by any means, without permission in writing from the publisher.

9-89 Draw the three Mohr's circles that describe each of the following states of stress.

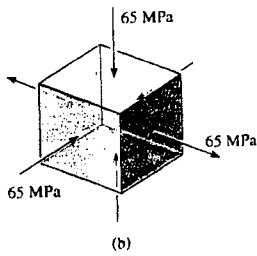
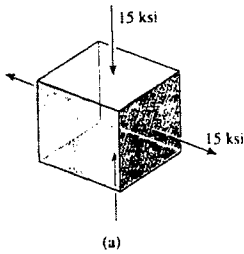

a)

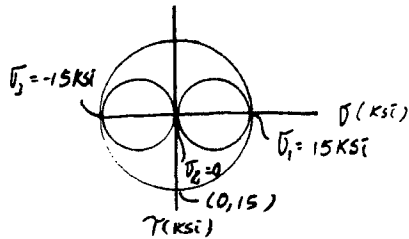

b)

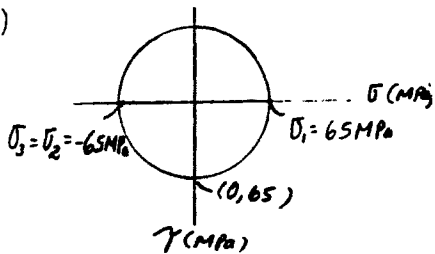

From *Mechanics of Materials*, Sixth Edition by R. C. Hibbeler, ISBN 0-13-191345-X.

© 2005 R. C. Hibbeler. Published by Pearson Prentice Hall,

Pearson Education, Inc., Upper Saddle River, NJ. All rights reserved.

This material is protected under all copyright laws as they currently exist. No portion of this material may be reproduced, in any form or by any means, without permission in writing from the publisher.

9-90. The principal stresses acting at a point in a body are shown. Draw the three Mohr's circles that describe this state of stress and find the maximum in-plane shear stresses and associated average normal stresses for the x - y , y - z , and x - z planes. For each case, show the results on the element oriented in the appropriate direction.

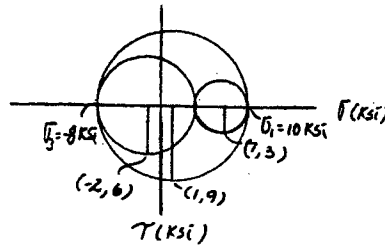
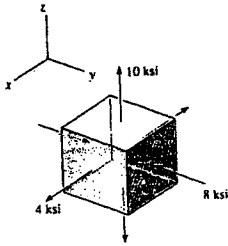

From Mohr's circle :

For x - y plane :

$\tau_{max} = 6.0 \text{ ksi}$ Ans
 $\sigma_{avg} = -2.0 \text{ ksi}$ Ans

For x - z plane :

$\tau_{max} = 3.0 \text{ ksi}$ Ans
 $\sigma_{avg} = 7.0 \text{ ksi}$ Ans

For y - z plane :

$\tau_{max} = 9.0 \text{ ksi}$ Ans
 $\sigma_{avg} = 1.0 \text{ ksi}$ Ans

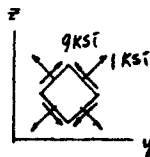
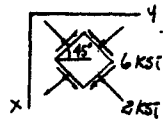

From *Mechanics of Materials*, Sixth Edition by R. C. Hibbeler, ISBN 0-13-191345-X.
 © 2005 R. C. Hibbeler. Published by Pearson Prentice Hall,
 Pearson Education, Inc., Upper Saddle River, NJ. All rights reserved.
 This material is protected under all copyright laws as they currently exist. No portion of this material may be reproduced, in any form or by any means, without permission in writing from the publisher.

9-91 The stress at a point is shown on the element. Determine the principal stresses and the absolute maximum shear stress.

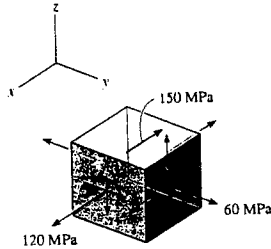

For $x-y$ plane :

$$R = CA = \sqrt{(120 - 60)^2 + 150^2} = 161.55$$

$$\sigma_1 = 60 + 161.55 = 221.55 \text{ MPa}$$

$$\sigma_2 = 60 - 161.55 = -101.55 \text{ MPa}$$

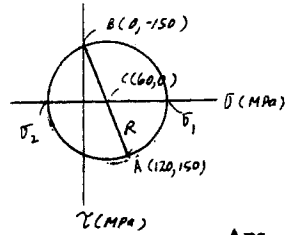

Ans

Three Mohr's circles

$$\sigma_1 = 222 \text{ MPa} \quad \sigma_2 = 60.0 \text{ MPa} \quad \sigma_3 = -102 \text{ MPa}$$

$$\tau_{\text{abs max}} = \frac{\sigma_{\text{max}} - \sigma_{\text{min}}}{2} = \frac{221.55 - (-101.55)}{2} = 162 \text{ MPa}$$

Ans

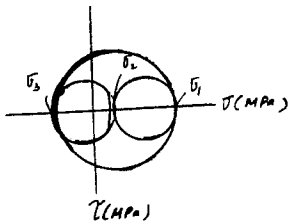

From *Mechanics of Materials*, Sixth Edition by R. C. Hibbeler, ISBN 0-13-191345-X.

© 2005 R. C. Hibbeler. Published by Pearson Prentice Hall,

Pearson Education, Inc., Upper Saddle River, NJ. All rights reserved.

This material is protected under all copyright laws as they currently exist. No portion of this material may be reproduced, in any form or by any means, without permission in writing from the publisher.

*9-92 The stress at a point is shown on the element. Determine the principal stresses and the absolute maximum shear stress.

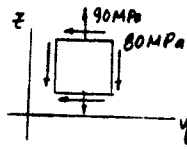
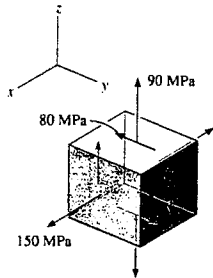

For y - z plane :

$A(0, -80) \quad B(90, 80) \quad C(45, 0)$

$R = \sqrt{45^2 + 80^2} = 91.79$

$\sigma_1 = 45 + 91.79 = 136.79 \text{ MPa}$

$\sigma_2 = 45 - 91.79 = -46.79 \text{ MPa}$

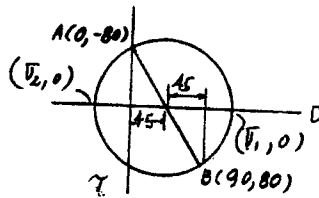

Thus,

$\sigma_1 = 150 \text{ MPa} \quad \text{Ans}$

$\sigma_2 = 137 \text{ MPa} \quad \text{Ans}$

$\sigma_3 = -46.8 \text{ MPa} \quad \text{Ans}$

$\tau_{\text{abs max}} = \frac{\sigma_{\text{max}} - \sigma_{\text{min}}}{2} = \frac{150 - (-46.8)}{2} = 98.4 \text{ MPa} \quad \text{Ans}$

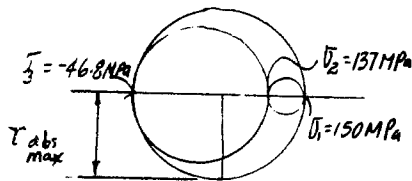

From *Mechanics of Materials*, Sixth Edition by R. C. Hibbeler, ISBN 0-13-191345-X.
 © 2005 R. C. Hibbeler. Published by Pearson Prentice Hall,
 Pearson Education, Inc., Upper Saddle River, NJ. All rights reserved.
 This material is protected under all copyright laws as they currently exist. No portion of this material may be reproduced, in any form or by any means, without permission in writing from the publisher.

9-93 The state of stress at a point is shown on the element. Determine the principal stresses and the absolute maximum shear stress.

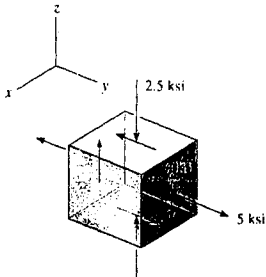

For y-z plane :

$$A(5, -4) \quad B(-2.5, 4) \quad C(1.25, 0)$$

$$R = \sqrt{3.75^2 + 4^2} = 5.483$$

$$\sigma_1 = 1.25 + 5.483 = 6.733 \text{ ksi}$$

$$\sigma_2 = 1.25 - 5.483 = -4.233 \text{ ksi}$$

Thus,

$$\sigma_1 = 6.73 \text{ ksi} \quad \text{Ans}$$

$$\sigma_2 = 0 \quad \text{Ans}$$

$$\sigma_3 = -4.23 \text{ ksi} \quad \text{Ans}$$

$$\sigma_{avg} = \frac{6.73 + (-4.23)}{2} = 1.25 \text{ ksi}$$

$$\tau_{abs \max} = \frac{\sigma_{max} - \sigma_{min}}{2} = \frac{6.73 - (-4.23)}{2} = 5.48 \text{ ksi} \quad \text{Ans}$$

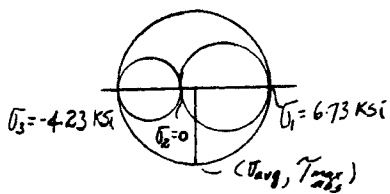
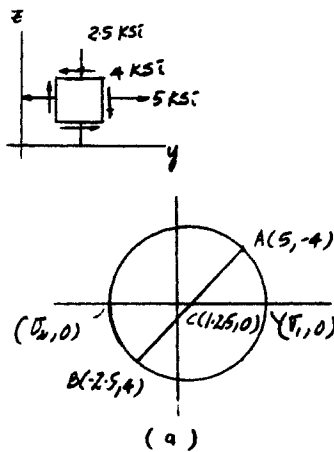

From *Mechanics of Materials*, Sixth Edition by R. C. Hibbeler, ISBN 0-13-191345-X.

© 2005 R. C. Hibbeler. Published by Pearson Prentice Hall,

Pearson Education, Inc., Upper Saddle River, NJ. All rights reserved.

This material is protected under all copyright laws as they currently exist. No portion of this material may be reproduced, in any form or by any means, without permission in writing from the publisher.

Because of the number and variety of potential correct solutions to this problem, no solution is being given.

From *Mechanics of Materials*, Sixth Edition by R. C. Hibbeler, ISBN 0-13-191345-X.

© 2005 R. C. Hibbeler. Published by Pearson Prentice Hall,

Pearson Education, Inc, Upper Saddle River, NJ. All rights reserved.

This material is protected under all copyright laws as they currently exist. No portion of this material may be reproduced, in any form or by any means, without permission in writing from the publisher.

9-95. The solid cylinder having a radius r is placed in a sealed container and subjected to a pressure p . Determine the stress components acting at point A located on the center line of the cylinder. Draw Mohr's circles for the element at this point.

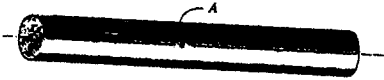

$$-\sigma(dz)(2r) = \int_0^\pi p(r d\theta) dz \sin \theta$$

$$-\sigma = p \int_0^\pi \sin \theta d\theta = p(-\cos \theta) \Big|_0^\pi$$

$$\sigma = -p$$

The stress in every direction is $\sigma_1 = \sigma_2 = \sigma_3 = -p$ **Ans**

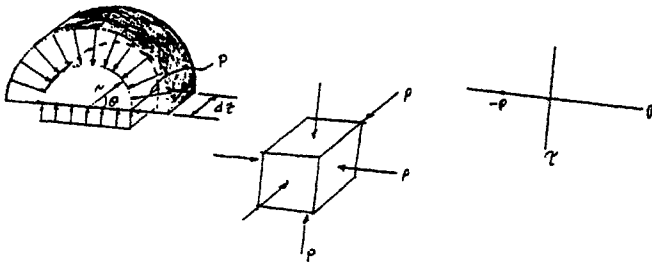

From *Mechanics of Materials*, Sixth Edition by R. C. Hibbeler, ISBN 0-13-191345-X.

© 2005 R. C. Hibbeler. Published by Pearson Prentice Hall,

Pearson Education, Inc., Upper Saddle River, NJ. All rights reserved.

This material is protected under all copyright laws as they currently exist. No portion of this material may be reproduced, in any form or by any means, without permission in writing from the publisher.

***9-96** The plate is subjected to a tensile force $P = 5$ kip. If it has the dimensions shown, determine the principal stresses and the absolute maximum shear stress. If the material is ductile it will fail in shear. Make a sketch of the plate showing how this failure would appear. If the material is brittle the plate will fail due to the principal stresses. Show how this failure occurs.

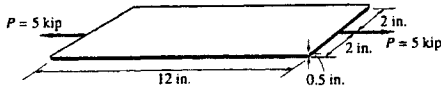

$$\sigma = \frac{P}{A} = \frac{5000}{(4)(0.5)} = 2500 \text{ psi} = 2.50 \text{ ksi}$$

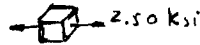

$$\sigma_1 = 2.50 \text{ ksi} \quad \text{Ans}$$

$$\sigma_2 = \sigma_3 = 0 \quad \text{Ans}$$

$$\tau_{\text{abs max}} = \frac{\sigma_1}{2} = 1.25 \text{ ksi} \quad \text{Ans}$$

Failure by shear :



Failure by principal stress :

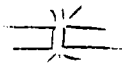

From *Mechanics of Materials*, Sixth Edition by R. C. Hibbeler, ISBN 0-13-191345-X.

© 2005 R. C. Hibbeler. Published by Pearson Prentice Hall,

Pearson Education, Inc., Upper Saddle River, NJ. All rights reserved.

This material is protected under all copyright laws as they currently exist. No portion of this material may be reproduced, in any form or by any means, without permission in writing from the publisher.

9-97 The frame is subjected to a horizontal force and couple moment at its end. Determine the principal stresses and the absolute maximum shear stress at point A. The cross-sectional area at this point is shown.

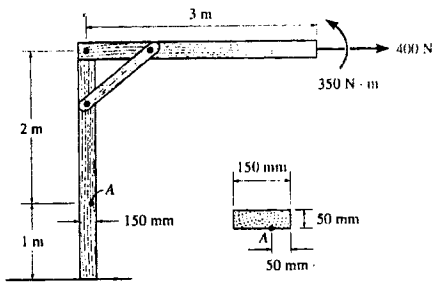

$$I = \frac{1}{12}(0.05)(0.15^3) = 14.0625(10^{-6}) \text{ m}^4$$

$$Q_A = 0.05(0.05)(0.05) = 0.125(10^{-3}) \text{ m}^3$$

$$\sigma_A = -\frac{Mx}{I} = -\frac{450(0.025)}{14.0625(10^{-6})} = -800 \text{ kPa}$$

$$\tau_A = \frac{VQ_A}{It} = \frac{400(0.125)(10^{-3})}{14.0625(10^{-6})(0.05)} = 71.11 \text{ kPa}$$

$$A(0, 71.11) \quad B(-800, -71.11) \quad C(-400, 0)$$

$$R = \sqrt{400^2 + 71.11^2} = 406.272$$

$$\sigma_1 = -400 + 406.272 = 6.27 \text{ kPa}$$

$$\sigma_2 = -400 - 406.272 = -806 \text{ kPa}$$

Thus,

$$\sigma_1 = 6.27 \text{ kPa} \quad \text{Ans}$$

$$\sigma_2 = 0 \quad \text{Ans}$$

$$\sigma_3 = -806 \text{ kPa} \quad \text{Ans}$$

$$\tau_{\text{abs max}} = \frac{\sigma_{\text{max}} - \sigma_{\text{min}}}{2} = \frac{6.27 - (-806.27)}{2} = 406 \text{ kPa} \quad \text{Ans}$$

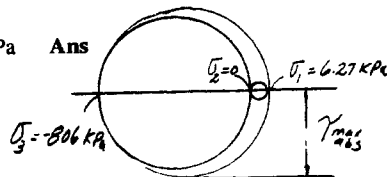
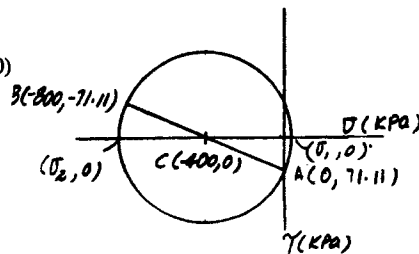
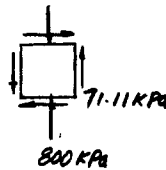

From *Mechanics of Materials*, Sixth Edition by R. C. Hibbeler, ISBN 0-13-191345-X.
 © 2005 R. C. Hibbeler. Published by Pearson Prentice Hall,
 Pearson Education, Inc., Upper Saddle River, NJ. All rights reserved.
 This material is protected under all copyright laws as they currently exist. No portion of this material may be reproduced, in any form or by any means, without permission in writing from the publisher.

9-98 The stress at a point is shown on the element. Determine the principal stresses and the absolute maximum shear stress.

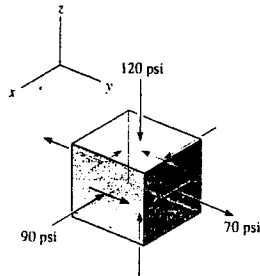

For x - y plane :

$A(70, -30)$ $B(-90, 30)$ $C(-10, 0)$

$$R = \sqrt{80^2 + 30^2} = 85.44$$

$$\sigma_1 = -10 + 85.44 = 75.44 \text{ psi}$$

$$\sigma_2 = -10 - 85.44 = -95.44 \text{ psi}$$

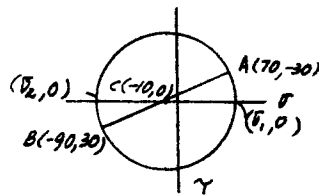

Here

$$\sigma_1 = 75.4 \text{ psi} \quad \text{Ans}$$

$$\sigma_2 = -95.4 \text{ psi} \quad \text{Ans}$$

$$\sigma_3 = -120 \text{ psi} \quad \text{Ans}$$

$$\tau_{abs \max} = \frac{\sigma_{\max} - \sigma_{\min}}{2} = \frac{75.44 - (-120)}{2} = 97.7 \text{ psi} \quad \text{Ans}$$

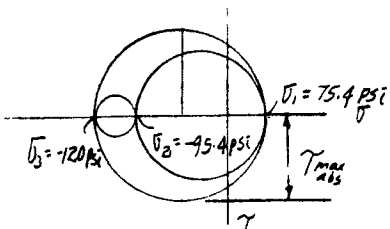

From *Mechanics of Materials*, Sixth Edition by R. C. Hibbeler, ISBN 0-13-191345-X.

© 2005 R. C. Hibbeler. Published by Pearson Prentice Hall,

Pearson Education, Inc., Upper Saddle River, NJ. All rights reserved.

This material is protected under all copyright laws as they currently exist. No portion of this material may be reproduced, in any form or by any means, without permission in writing from the publisher.

9-99 The crane is used to support the 350-lb load. Determine the principal stresses acting in the boom at points A and B. The cross section is rectangular and has a width of 6 in. and a thickness of 3 in. Use Mohr's circle.

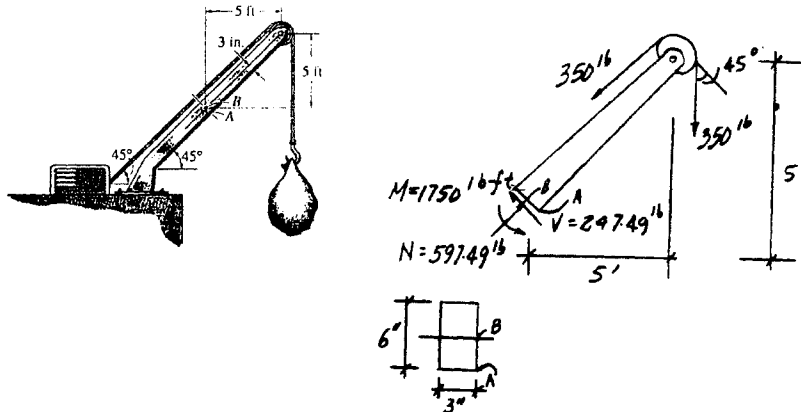

$$A = 6(3) = 18 \text{ in}^2 \quad I = \frac{1}{12}(3)(6^3) = 54 \text{ in}^4$$

$$Q_B = (1.5)(3)(3) = 13.5 \text{ in}^3$$

$$Q_A = 0$$

For point A :

$$\sigma_A = \frac{P}{A} - \frac{My}{I} = \frac{597.49}{18} - \frac{1750(12)(3)}{54} = -1200 \text{ psi}$$

$$\tau_A = 0$$

$$\sigma_1 = 0 \quad \text{Ans} \quad \sigma_2 = -1200 \text{ psi} = -1.20 \text{ ksi} \quad \text{Ans}$$



For point B :

$$\sigma_B = \frac{P}{A} - \frac{My}{I} = \frac{597.49(13.5)}{18} = -33.19 \text{ psi}$$

$$\tau_B = \frac{VQ_B}{It} = \frac{247.49}{54(3)} = 20.62 \text{ psi}$$

$$A(-33.19, -20.62) \quad B(0, 20.62) \quad C(-16.60, 0)$$

$$R = \sqrt{16.60^2 + 20.62^2} = 26.47$$

$$\sigma_1 = -16.60 + 26.47 = 9.88 \text{ psi} \quad \text{Ans}$$

$$\sigma_2 = -16.60 - 26.47 = -43.1 \text{ psi} \quad \text{Ans}$$

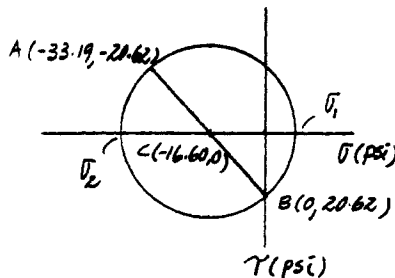
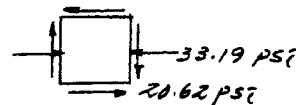

From *Mechanics of Materials*, Sixth Edition by R. C. Hibbeler, ISBN 0-13-191345-X.

© 2005 R. C. Hibbeler. Published by Pearson Prentice Hall,

Pearson Education, Inc., Upper Saddle River, NJ. All rights reserved.

This material is protected under all copyright laws as they currently exist. No portion of this material may be reproduced, in any form or by any means, without permission in writing from the publisher.

*9-100 Determine the equivalent state of stress if an element is oriented 40° clockwise from the element shown. Use Mohr's circle.

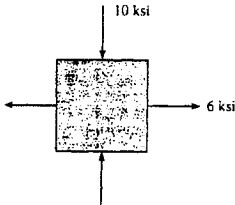

$$A(6,0) \quad B(-10,0) \quad C(-2,0)$$

$$R = CA = CB = 8$$

$$\sigma_x' = -2 + 8 \cos 80^\circ = -0.611 \text{ ksi} \quad \text{Ans}$$

$$\tau_{x'y'} = 8 \sin 80^\circ = 7.88 \text{ ksi} \quad \text{Ans}$$

$$\sigma_y' = -2 - 8 \cos 80^\circ = -3.39 \text{ ksi} \quad \text{Ans}$$

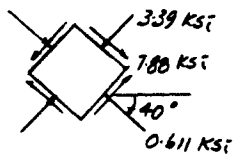
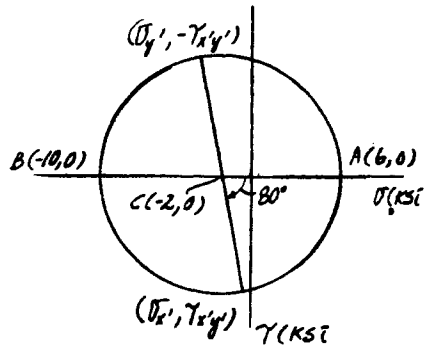

From *Mechanics of Materials*, Sixth Edition by R. C. Hibbeler, ISBN 0-13-191345-X.

© 2005 R. C. Hibbeler. Published by Pearson Prentice Hall,

Pearson Education, Inc., Upper Saddle River, NJ. All rights reserved.

This material is protected under all copyright laws as they currently exist. No portion of this material may be reproduced, in any form or by any means, without permission in writing from the publisher.

9-101. The wooden strut is subjected to the loading shown. Determine the principal stresses that act at point C and specify the orientation of the element at this point. The strut is supported by a bolt (pin) at B and smooth support at A.

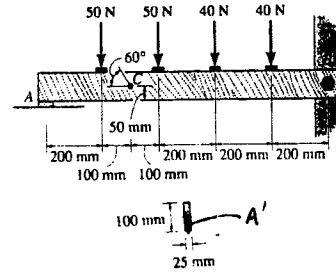

$$Q_C = \bar{y}' A' = 0.025(0.05)(0.025) = 31.25(10^{-6}) \text{ m}^3$$

$$I = \frac{1}{12}(0.025)(0.1^3) = 2.0833(10^{-6}) \text{ m}^4$$

Normal stress : $\sigma_C = 0$

Shear stress :

$$\tau = \frac{VQ_C}{I t} = \frac{44(31.25)(10^{-6})}{2.0833(10^{-6})(0.025)} = 26.4 \text{ kPa}$$

Principal stress :

$$\sigma_x = \sigma_y = 0; \quad \tau_{xy} = -26.4 \text{ kPa}$$

$$\sigma_{1,2} = \frac{\sigma_x + \sigma_y}{2} \pm \sqrt{\left(\frac{\sigma_x - \sigma_y}{2}\right)^2 + \tau_{xy}^2}$$

$$= 0 \pm \sqrt{0 + (26.4)^2}$$

$$\sigma_1 = 26.4 \text{ kPa} \quad ; \quad \sigma_2 = -26.4 \text{ kPa}$$

Orientation of principal stress :

$$\tan 2\theta_p = \frac{\tau_{xy}}{(\sigma_x - \sigma_y)} = -\infty$$

$$\theta_p = +45^\circ \text{ and } -45^\circ$$

Use Eq. 9-1 to determine the principal plane of σ_1 and σ_2

$$\sigma_{x'} = \frac{\sigma_x + \sigma_y}{2} + \frac{\sigma_x - \sigma_y}{2} \cos 2\theta + \tau_{xy} \sin 2\theta$$

$$\theta = \theta_p = -45^\circ$$

$$\sigma_{x'} = 0 + 0 + (-26.4) \sin -90^\circ = 26.4 \text{ kPa}$$

Therefore, $\theta_{p_1} = -45^\circ; \quad \theta_{p_2} = 45^\circ$

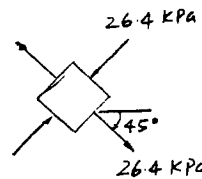
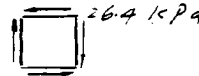
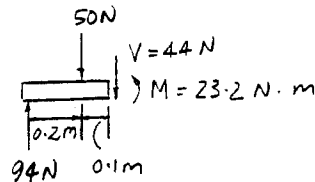
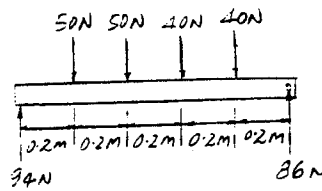

Ans

From *Mechanics of Materials*, Sixth Edition by R. C. Hibbeler, ISBN 0-13-191345-X.

© 2005 R. C. Hibbeler. Published by Pearson Prentice Hall,

Pearson Education, Inc., Upper Saddle River, NJ. All rights reserved.

This material is protected under all copyright laws as they currently exist. No portion of this material may be reproduced, in any form or by any means, without permission in writing from the publisher.

9-102. The wooden strut is subjected to the loading shown. If grains of wood in the strut at point C make an angle of 60° with the horizontal as shown, determine the normal and shear stresses that act perpendicular and parallel to the grains, respectively, due to the loading. The strut is supported by a bolt (pin) at B and smooth support at A.

$$Q_C = y' A' = 0.025(0.05)(0.025) = 31.25(10^{-6}) \text{ m}^3$$

$$I = \frac{1}{12}(0.025)(0.1^3) = 2.0833(10^{-6}) \text{ m}^4$$

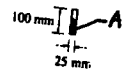
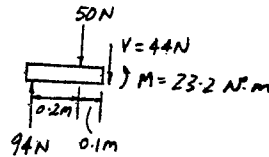
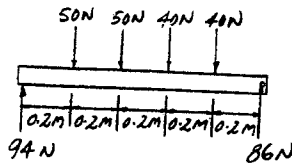
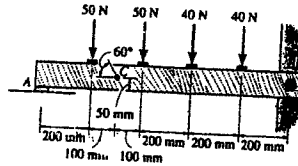

Normal stress : $\sigma_C = 0$

Shear stress :

$$\tau = \frac{VQ_C}{It} = \frac{44(31.25)(10^{-6})}{2.0833(10^{-6})(0.025)} = 26.4 \text{ kPa}$$

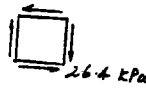

Stress transformation : $\sigma_x = \sigma_y = 0$; $\tau_{xy} = -26.4 \text{ kPa}$; $\theta = 30^\circ$

$$\begin{aligned} \sigma_{x'} &= \frac{\sigma_x + \sigma_y}{2} + \frac{\sigma_x - \sigma_y}{2} \cos 2\theta + \tau_{xy} \sin 2\theta \\ &= 0 + 0 + (-26.4) \sin 60^\circ = -22.9 \text{ kPa} \quad \text{Ans} \end{aligned}$$

$$\begin{aligned} \tau_{x'y'} &= -\frac{\sigma_x - \sigma_y}{2} \sin 2\theta + \tau_{xy} \cos 2\theta \\ &= -0 + (-26.4) \cos 60^\circ = -13.2 \text{ kPa} \quad \text{Ans} \end{aligned}$$

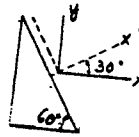

From *Mechanics of Materials*, Sixth Edition by R. C. Hibbeler, ISBN 0-13-191345-X.

© 2005 R. C. Hibbeler. Published by Pearson Prentice Hall,

Pearson Education, Inc., Upper Saddle River, NJ. All rights reserved.

This material is protected under all copyright laws as they currently exist. No portion of this material may be reproduced, in any form or by any means, without permission in writing from the publisher.

9-103. The state of stress at a point is shown on the element. Determine (a) the principal stresses and (b) the maximum in-plane shear stress and average normal stress at the point. Specify the orientation of the element in each case.

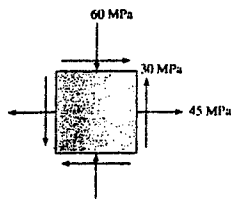

a) $\sigma_x = 45 \text{ MPa}$ $\sigma_y = -60 \text{ MPa}$ $\tau_{xy} = 30 \text{ MPa}$

$$\sigma_{1,2} = \frac{\sigma_x + \sigma_y}{2} \pm \sqrt{\left(\frac{\sigma_x - \sigma_y}{2}\right)^2 + \tau_{xy}^2}$$

$$= \frac{45 - 60}{2} \pm \sqrt{\left(\frac{45 - (-60)}{2}\right)^2 + 30^2}$$

$\sigma_1 = 53.0 \text{ MPa}$ $\sigma_2 = -68.0 \text{ MPa}$

$$\tan 2\theta_p = \frac{\tau_{xy}}{\frac{\sigma_x - \sigma_y}{2}} = \frac{30}{\frac{45 - (-60)}{2}} = 0.5714$$

$\theta_p = 14.87^\circ$ and -75.13°

Use Eq. 9-1 to determine the principal plane of σ_1 and σ_2

$$\sigma_r = \frac{\sigma_x + \sigma_y}{2} + \frac{\sigma_x - \sigma_y}{2} \cos 2\theta + \tau_{xy} \sin 2\theta$$

$\theta = \theta_p = 14.87^\circ$

$$\sigma_r = \frac{45 + (-60)}{2} + \frac{45 - (-60)}{2} \cos 29.74^\circ + 30 \sin 29.74^\circ = 53.0 \text{ MPa}$$

Therefore, $\theta_{p_1} = 14.9^\circ$; $\theta_{p_2} = -75.1^\circ$

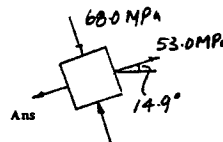

b) $\tau_{\max} = \sqrt{\left(\frac{\sigma_x - \sigma_y}{2}\right)^2 + \tau_{xy}^2} = \sqrt{\left(\frac{45 - (-60)}{2}\right)^2 + 30^2} = 60.5 \text{ MPa}$ Ans

$\sigma_{\text{ave}} = \frac{\sigma_x + \sigma_y}{2} = \frac{45 + (-60)}{2} = -7.50 \text{ MPa}$ Ans

$$\tan 2\theta_s = -\frac{(\sigma_x - \sigma_y)}{2\tau_{xy}} = -\frac{(45 - (-60))}{2 \cdot 30} = -1.75$$

$\theta_s = -30.1^\circ$ Ans and 59.9°

By observation, in order to preserve equilibrium, $\tau_{\max} = 60.5 \text{ MPa}$ has to act in the direction shown in the figure.

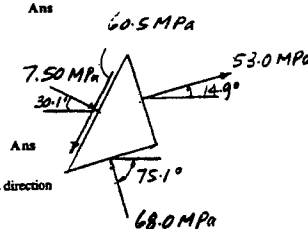
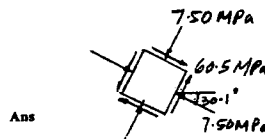

From *Mechanics of Materials*, Sixth Edition by R. C. Hibbeler, ISBN 0-13-191345-X.
 © 2005 R. C. Hibbeler. Published by Pearson Prentice Hall,
 Pearson Education, Inc., Upper Saddle River, NJ. All rights reserved.
 This material is protected under all copyright laws as they currently exist. No portion of this material may be reproduced, in any form or by any means, without permission in writing from the publisher.

***9-104** The state of stress at a point in a member is shown on the element. Determine the stress components acting on the inclined plane AB . Solve the problem using the method of equilibrium described in Sec. 9.1.

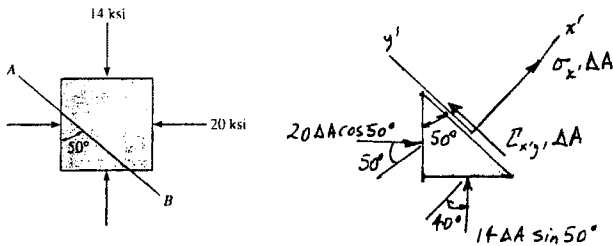

$$+\Sigma F_{x'} = 0; \quad \sigma_{x'} \Delta A + 14 \Delta A \sin 50^\circ \cos 40^\circ + 20 \Delta A \cos 50^\circ \cos 50^\circ = 0$$

$$\sigma_{x'} = -16.5 \text{ ksi} \quad \text{Ans}$$

$$+\Sigma F_{y'} = 0; \quad \tau_{x'y'} \Delta A + 14 \Delta A \sin 50^\circ \sin 40^\circ - 20 \Delta A \cos 50^\circ \sin 50^\circ = 0$$

$$\tau_{x'y'} = 2.95 \text{ ksi} \quad \text{Ans}$$

From *Mechanics of Materials*, Sixth Edition by R. C. Hibbeler, ISBN 0-13-191345-X.

© 2005 R. C. Hibbeler. Published by Pearson Prentice Hall,

Pearson Education, Inc., Upper Saddle River, NJ. All rights reserved.

This material is protected under all copyright laws as they currently exist. No portion of this material may be reproduced, in any form or by any means, without permission in writing from the publisher.

10-1 Prove that the sum of the normal strains in perpendicular directions is constant.

$$\varepsilon_{x'} = \frac{\varepsilon_x + \varepsilon_y}{2} + \frac{\varepsilon_x - \varepsilon_y}{2} \cos 2\theta + \frac{\gamma_{xy}}{2} \sin 2\theta \quad (1)$$

$$\varepsilon_{y'} = \frac{\varepsilon_x + \varepsilon_y}{2} - \frac{\varepsilon_x - \varepsilon_y}{2} \cos 2\theta - \frac{\gamma_{xy}}{2} \sin 2\theta \quad (2)$$

Adding Eq. (1) and Eq. (2) yields :

$$\varepsilon_{x'} + \varepsilon_{y'} = \varepsilon_x + \varepsilon_y = \text{constant} \quad \mathbf{QED}$$

From *Mechanics of Materials*, Sixth Edition by R. C. Hibbeler, ISBN 0-13-191345-X.

© 2005 R. C. Hibbeler. Published by Pearson Prentice Hall,

Pearson Education, Inc., Upper Saddle River, NJ. All rights reserved.

This material is protected under all copyright laws as they currently exist. No portion of this material may be reproduced, in any form or by any means, without permission in writing from the publisher.

10-2 The state of strain at the point on the bracket has components $\epsilon_x = -200(10^{-6})$, $\epsilon_y = -650(10^{-6})$, $\gamma_{xy} = -175(10^{-6})$. Use the strain-transformation equations to determine the equivalent in-plane strains on an element oriented at an angle of $\theta = 20^\circ$ counterclockwise from the original position. Sketch the deformed element due to these strains within the x - y plane.

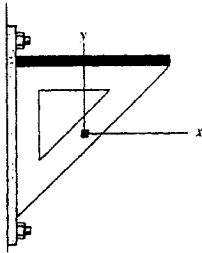

$$\epsilon_x = -200(10^{-6}) \quad \epsilon_y = -650(10^{-6}) \quad \gamma_{xy} = -175(10^{-6}) \quad \theta = 20^\circ$$

$$\begin{aligned} \epsilon_{x'} &= \frac{\epsilon_x + \epsilon_y}{2} + \frac{\epsilon_x - \epsilon_y}{2} \cos 2\theta + \frac{\gamma_{xy}}{2} \sin 2\theta \\ &= \left[\frac{-200 + (-650)}{2} + \frac{(-200) - (-650)}{2} \cos(40^\circ) + \frac{(-175)}{2} \sin(40^\circ) \right] (10^{-6}) = -309(10^{-6}) \quad \text{Ans} \end{aligned}$$

$$\begin{aligned} \epsilon_{y'} &= \frac{\epsilon_x + \epsilon_y}{2} - \frac{\epsilon_x - \epsilon_y}{2} \cos 2\theta - \frac{\gamma_{xy}}{2} \sin 2\theta \\ &= \left[\frac{-200 + (-650)}{2} - \frac{-200 - (-650)}{2} \cos(40^\circ) - \frac{(-175)}{2} \sin(40^\circ) \right] (10^{-6}) = -541(10^{-6}) \quad \text{Ans} \end{aligned}$$

$$\frac{\gamma_{x'y'}}{2} = -\frac{\epsilon_x - \epsilon_y}{2} \sin 2\theta + \frac{\gamma_{xy}}{2} \cos 2\theta$$

$$\gamma_{x'y'} = [-(-200 - (-650)) \sin(40^\circ) + (-175) \cos(40^\circ)] (10^{-6}) = -423(10^{-6}) \quad \text{Ans}$$

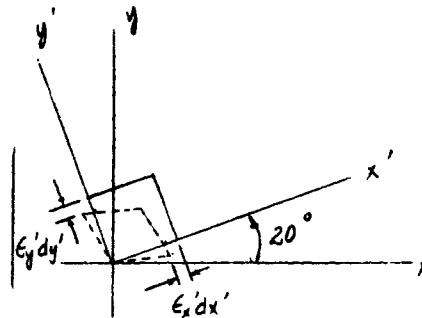

From *Mechanics of Materials*, Sixth Edition by R. C. Hibbeler, ISBN 0-13-191345-X.

© 2005 R. C. Hibbeler. Published by Pearson Prentice Hall,

Pearson Education, Inc., Upper Saddle River, NJ. All rights reserved.

This material is protected under all copyright laws as they currently exist. No portion of this material may be reproduced, in any form or by any means, without permission in writing from the publisher.

10-3 A differential element on the bracket is subjected to plane strain that has the following components: $\epsilon_x = 150(10^{-6})$, $\epsilon_y = 200(10^{-6})$, $\gamma_{xy} = -700(10^{-6})$. Use the strain-transformation equations and determine the equivalent in-plane strains on an element oriented at an angle of $\theta = 60^\circ$ counterclockwise from the original position. Sketch the deformed element within the x - y plane due to these strains.

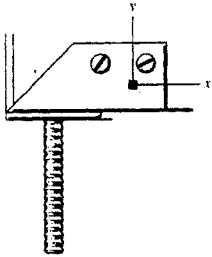

$$\epsilon_x = 150 (10^{-6}) \quad \epsilon_y = 200 (10^{-6}) \quad \gamma_{xy} = -700 (10^{-6}) \quad \theta = 60^\circ$$

$$\begin{aligned} \epsilon_{x'} &= \frac{\epsilon_x + \epsilon_y}{2} + \frac{\epsilon_x - \epsilon_y}{2} \cos 2\theta + \frac{\gamma_{xy}}{2} \sin 2\theta \\ &= \left[\frac{150 + 200}{2} + \frac{150 - 200}{2} \cos 120^\circ + \left(\frac{-700}{2} \right) \sin 120^\circ \right] 10^{-6} = -116 (10^{-6}) \quad \text{Ans} \end{aligned}$$

$$\begin{aligned} \epsilon_{y'} &= \frac{\epsilon_x + \epsilon_y}{2} - \frac{\epsilon_x - \epsilon_y}{2} \cos 2\theta - \frac{\gamma_{xy}}{2} \sin 2\theta \\ &= \left[\frac{150 + 200}{2} - \frac{150 - 200}{2} \cos 120^\circ - \left(\frac{-700}{2} \right) \sin 120^\circ \right] 10^{-6} = 466 (10^{-6}) \quad \text{Ans} \end{aligned}$$

$$\frac{\gamma_{x'y'}}{2} = -\frac{\epsilon_x - \epsilon_y}{2} \sin 2\theta + \frac{\gamma_{xy}}{2} \cos 2\theta$$

$$\gamma_{x'y'} = 2 \left[-\frac{150 - 200}{2} \sin 120^\circ + \left(\frac{-700}{2} \right) \cos 120^\circ \right] 10^{-6} = 393 (10^{-6}) \quad \text{Ans}$$

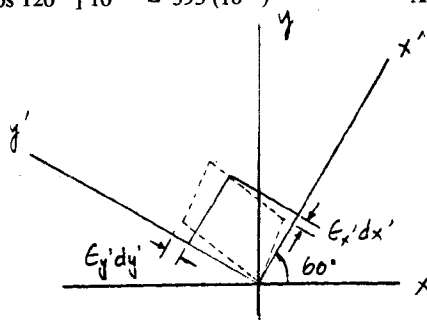

From *Mechanics of Materials*, Sixth Edition by R. C. Hibbeler, ISBN 0-13-191345-X.

© 2005 R. C. Hibbeler. Published by Pearson Prentice Hall,

Pearson Education, Inc., Upper Saddle River, NJ. All rights reserved.

This material is protected under all copyright laws as they currently exist. No portion of this material may be reproduced, in any form or by any means, without permission in writing from the publisher.

*10-4 Solve Prob. 10-3 for an element oriented $\theta = 30^\circ$ clockwise.

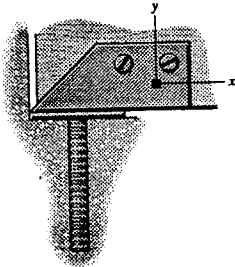

$$\epsilon_x = 150 (10^{-6}) \quad \epsilon_y = 200 (10^{-6}) \quad \gamma_{xy} = -700 (10^{-6}) \quad \theta = -30^\circ$$

$$\begin{aligned} \epsilon_{x'} &= \frac{\epsilon_x + \epsilon_y}{2} + \frac{\epsilon_x - \epsilon_y}{2} \cos 2\theta + \frac{\gamma_{xy}}{2} \sin 2\theta \\ &= \left[\frac{150 + 200}{2} + \frac{150 - 200}{2} \cos (-60^\circ) + \left(\frac{-700}{2} \right) \sin (-60^\circ) \right] 10^{-6} = 466 (10^{-6}) \quad \text{Ans} \end{aligned}$$

$$\begin{aligned} \epsilon_{y'} &= \frac{\epsilon_x + \epsilon_y}{2} - \frac{\epsilon_x - \epsilon_y}{2} \cos 2\theta - \frac{\gamma_{xy}}{2} \sin 2\theta \\ &= \left[\frac{150 + 200}{2} - \frac{150 - 200}{2} \cos (-60^\circ) - \left(\frac{-700}{2} \right) \sin (-60^\circ) \right] 10^{-6} = -116 (10^{-6}) \quad \text{Ans} \end{aligned}$$

$$\frac{\gamma_{x'y'}}{2} = -\frac{\epsilon_x - \epsilon_y}{2} \sin 2\theta + \frac{\gamma_{xy}}{2} \cos 2\theta$$

$$\gamma_{x'y'} = 2 \left[-\frac{150 - 200}{2} \sin (-60^\circ) + \frac{-700}{2} \cos (-60^\circ) \right] 10^{-6} = -393 (10^{-6}) \quad \text{Ans}$$

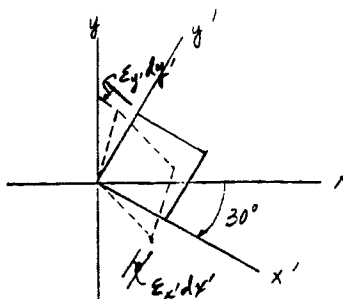

From *Mechanics of Materials*, Sixth Edition by R. C. Hibbeler, ISBN 0-13-191345-X.

© 2005 R. C. Hibbeler. Published by Pearson Prentice Hall,

Pearson Education, Inc., Upper Saddle River, NJ. All rights reserved.

This material is protected under all copyright laws as they currently exist. No portion of this material may be reproduced, in any form or by any means, without permission in writing from the publisher.

10-5 The state of strain at the point on the bracket has components $\epsilon_x = 400(10^{-6})$, $\epsilon_y = -250(10^{-6})$, $\gamma_{xy} = 310(10^{-6})$. Use the strain-transformation equations to determine the equivalent in-plane strains on an element oriented at an angle of $\theta = 30^\circ$ clockwise from the original position. Sketch the deformed element due to these strains within the x - y plane.

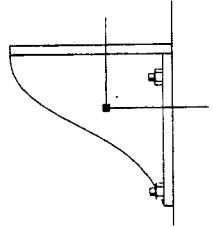

$$\epsilon_x = 400(10^{-6}) \quad \epsilon_y = -250(10^{-6}) \quad \gamma_{xy} = 310(10^{-6}) \quad \theta = -30^\circ$$

$$\begin{aligned} \epsilon_{x'} &= \frac{\epsilon_x + \epsilon_y}{2} + \frac{\epsilon_x - \epsilon_y}{2} \cos 2\theta + \frac{\gamma_{xy}}{2} \sin 2\theta \\ &= \left[\frac{400 + (-250)}{2} + \frac{400 - (-250)}{2} \cos(-60^\circ) + \left(\frac{310}{2}\right) \sin(-60^\circ) \right] (10^{-6}) = 103(10^{-6}) \quad \text{Ans} \end{aligned}$$

$$\begin{aligned} \epsilon_{y'} &= \frac{\epsilon_x + \epsilon_y}{2} - \frac{\epsilon_x - \epsilon_y}{2} \cos 2\theta - \frac{\gamma_{xy}}{2} \sin 2\theta \\ &= \left[\frac{400 + (-250)}{2} - \frac{400 - (-250)}{2} \cos(-60^\circ) - \frac{310}{2} \sin(-60^\circ) \right] (10^{-6}) = 46.7(10^{-6}) \quad \text{Ans} \end{aligned}$$

$$\frac{\gamma_{x'y'}}{2} = -\frac{\epsilon_x - \epsilon_y}{2} \sin 2\theta + \frac{\gamma_{xy}}{2} \cos 2\theta$$

$$\gamma_{x'y'} = [-(400 - (-250)) \sin(-60^\circ) + 310 \cos(-60^\circ)] (10^{-6}) = 718(10^{-6}) \quad \text{Ans}$$

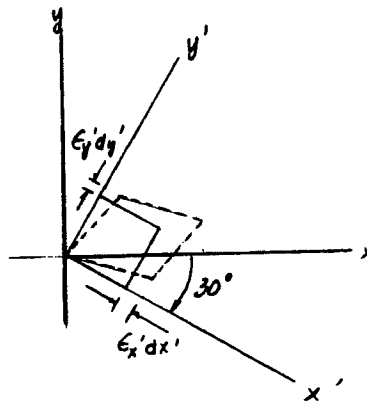

From *Mechanics of Materials*, Sixth Edition by R. C. Hibbeler, ISBN 0-13-191345-X.

© 2005 R. C. Hibbeler. Published by Pearson Prentice Hall,

Pearson Education, Inc., Upper Saddle River, NJ. All rights reserved.

This material is protected under all copyright laws as they currently exist. No portion of this material may be reproduced, in any form or by any means, without permission in writing from the publisher.

10-6 The state of strain at the point on the wrench has components $\epsilon_x = 120(10^{-6})$, $\epsilon_y = -180(10^{-6})$, $\gamma_{xy} = 150(10^{-6})$. Use the strain-transformation equations to determine (a) the in-plane principal strains and (b) the maximum in-plane shear strain and average normal strain. In each case specify the orientation of the element and show how the strains deform the element within the x - y plane.

$$\epsilon_x = 120(10^{-6}) \quad \epsilon_y = -180(10^{-6}) \quad \gamma_{xy} = 150(10^{-6})$$

$$\begin{aligned} \text{a) } \epsilon_{1,2} &= \frac{\epsilon_x + \epsilon_y}{2} \pm \sqrt{\left(\frac{\epsilon_x - \epsilon_y}{2}\right)^2 + \left(\frac{\gamma_{xy}}{2}\right)^2} \\ &= \left\{ \frac{120 + (-180)}{2} \pm \sqrt{\left(\frac{120 - (-180)}{2}\right)^2 + \left(\frac{150}{2}\right)^2} \right\} 10^{-6} \end{aligned}$$

$$\epsilon_1 = 138(10^{-6}); \quad \epsilon_2 = -198(10^{-6}) \quad \text{Ans}$$

Orientation of ϵ_1 and ϵ_2

$$\tan 2\theta_p = \frac{\gamma_{xy}}{\epsilon_x - \epsilon_y} = \frac{150}{120 - (-180)} = 0.5$$

$$\theta_p = 13.28^\circ \text{ and } -76.72^\circ$$

Use Eq. 10-5 to determine the direction of ϵ_1 and ϵ_2

$$\epsilon_{x'} = \frac{\epsilon_x + \epsilon_y}{2} + \frac{\epsilon_x - \epsilon_y}{2} \cos 2\theta + \frac{\gamma_{xy}}{2} \sin 2\theta$$

$$\theta = \theta_p = 13.28^\circ$$

$$\begin{aligned} \epsilon_{x'} &= \left\{ \frac{120 + (-180)}{2} + \frac{120 - (-180)}{2} \cos(26.56^\circ) + \frac{150}{2} \sin 26.56^\circ \right\} 10^{-6} \\ &= 138(10^{-6}) = \epsilon_1 \end{aligned}$$

$$\text{Therefore } \theta_{p_1} = 13.3^\circ; \quad \theta_{p_2} = -76.7^\circ \quad \text{Ans}$$

$$\text{b) } \frac{\gamma_{\max}}{2} = \sqrt{\left(\frac{\epsilon_x - \epsilon_y}{2}\right)^2 + \left(\frac{\gamma_{xy}}{2}\right)^2}$$

$$\frac{\gamma_{\max}}{2} = 2 \left[\sqrt{\left(\frac{120 - (-180)}{2}\right)^2 + \left(\frac{150}{2}\right)^2} \right] 10^{-6} = 335(10^{-6}) \quad \text{Ans}$$

$$\epsilon_{\text{avg}} = \frac{\epsilon_x + \epsilon_y}{2} = \left[\frac{120 + (-180)}{2} \right] 10^{-6} = -30.0(10^{-6}) \quad \text{Ans}$$

Orientation of γ_{\max}

$$\tan 2\theta_s = \frac{-(\epsilon_x - \epsilon_y)}{\gamma_{xy}} = \frac{-(120 - (-180))}{150} = -2.0$$

$$\theta_s = -31.7^\circ \text{ and } 58.3^\circ \quad \text{Ans}$$

Use Eq. 10-11 to determine the sign of γ_{\max}

$$\frac{\gamma_{x'y'}}{2} = -\frac{\epsilon_x - \epsilon_y}{2} \sin 2\theta + \frac{\gamma_{xy}}{2} \cos 2\theta$$

$$\theta = \theta_s = -31.7^\circ$$

$$\gamma_{x'y'} = 2 \left[-\frac{120 - (-180)}{2} \sin(-63.4^\circ) + \frac{150}{2} \cos(-63.4^\circ) \right] 10^{-6} = 335(10^{-6})$$

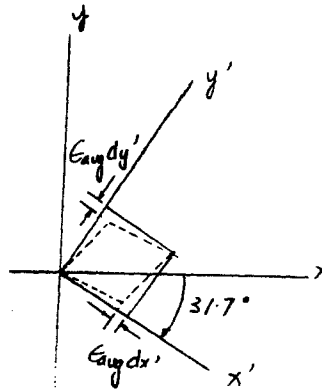
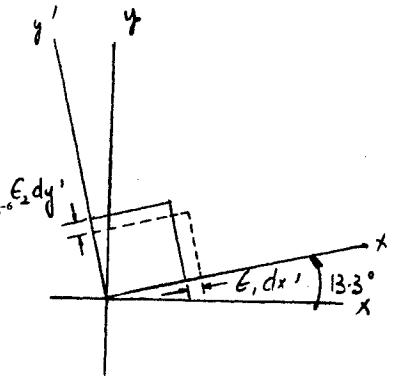

From *Mechanics of Materials*, Sixth Edition by R. C. Hibbeler, ISBN 0-13-191345-X.

© 2005 R. C. Hibbeler. Published by Pearson Prentice Hall,

Pearson Education, Inc., Upper Saddle River, NJ. All rights reserved.

This material is protected under all copyright laws as they currently exist. No portion of this material may be reproduced, in any form or by any means, without permission in writing from the publisher.

10-7 The state of strain at the point on the gear tooth has components $\epsilon_x = 850(10^{-6})$, $\epsilon_y = 480(10^{-6})$, $\gamma_{xy} = 650(10^{-6})$. Use the strain-transformation equations to determine (a) the in-plane principal strains and (b) the maximum in-plane shear strain and average normal strain. In each case specify the orientation of the element and show how the strains deform the element within the x - y plane.

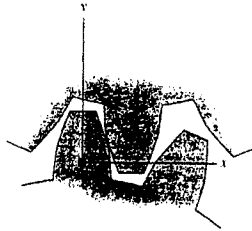

$$\epsilon_x = 850(10^{-6}) \quad \epsilon_y = 480(10^{-6}) \quad \gamma_{xy} = 650(10^{-6})$$

a)

$$\epsilon_{1,2} = \frac{\epsilon_x + \epsilon_y}{2} \pm \sqrt{\left(\frac{\epsilon_x - \epsilon_y}{2}\right)^2 + \left(\frac{\gamma_{xy}}{2}\right)^2}$$

$$= \left[\frac{850 + 480}{2} \pm \sqrt{\left(\frac{850 - 480}{2}\right)^2 + \left(\frac{650}{2}\right)^2} \right] (10^{-6})$$

$$\epsilon_1 = 1039(10^{-6}) \quad \text{Ans} \quad \epsilon_2 = 291(10^{-6}) \quad \text{Ans}$$

Orientation of ϵ_1 and ϵ_2 :

$$\tan 2\theta_p = \frac{\gamma_{xy}}{\epsilon_x - \epsilon_y} = \frac{650}{850 - 480}$$

$$\theta_p = 30.18^\circ \quad \text{and} \quad 120.18^\circ$$

Use Eq. 10-5 to determine the direction of ϵ_1 and ϵ_2 :

$$\epsilon_{x'} = \frac{\epsilon_x + \epsilon_y}{2} + \frac{\epsilon_x - \epsilon_y}{2} \cos 2\theta + \frac{\gamma_{xy}}{2} \sin 2\theta$$

$$\theta = \theta_p = 30.18^\circ$$

$$\epsilon_{x'} = \left[\frac{850 + 480}{2} + \frac{850 - 480}{2} \cos(60.35^\circ) + \frac{650}{2} \sin(60.35^\circ) \right] (10^{-6}) = 1039(10^{-6})$$

$$\text{Therefore, } \theta_{p1} = 30.2^\circ \quad \text{Ans} \quad \theta_{p2} = 120^\circ \quad \text{Ans}$$

b)

$$\frac{\gamma_{\max}}{2} = \sqrt{\left(\frac{\epsilon_x - \epsilon_y}{2}\right)^2 + \left(\frac{\gamma_{xy}}{2}\right)^2}$$

$$\gamma_{\max} = 2 \left[\sqrt{\left(\frac{850 - 480}{2}\right)^2 + \left(\frac{650}{2}\right)^2} \right] (10^{-6}) = 748(10^{-6}) \quad \text{Ans}$$

$$\epsilon_{\text{avg}} = \frac{\epsilon_x + \epsilon_y}{2} = \left(\frac{850 + 480}{2}\right)(10^{-6}) = 665(10^{-6}) \quad \text{Ans}$$

Orientation of γ_{\max} :

$$\tan 2\theta_s = \frac{-(\epsilon_x - \epsilon_y)}{\gamma_{xy}} = \frac{-(850 - 480)}{650}$$

$$\theta_s = -14.8^\circ \quad \text{and} \quad 75.2^\circ \quad \text{Ans}$$

Use Eq 10-6 to determine the sign of γ_{\max} in-plane:

$$\frac{\gamma_{x'y'}}{2} = -\frac{\epsilon_x - \epsilon_y}{2} \sin 2\theta + \frac{\gamma_{xy}}{2} \cos 2\theta; \quad \theta = \theta_s = -14.8^\circ$$

$$\gamma_{x'y'} = [-(850 - 480) \sin(-29.65^\circ) + 650 \cos(-29.65^\circ)] (10^{-6}) = 748(10^{-6})$$

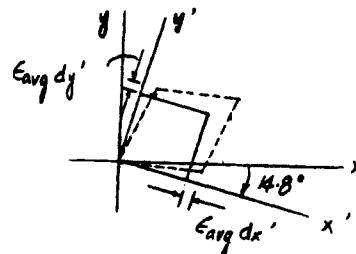
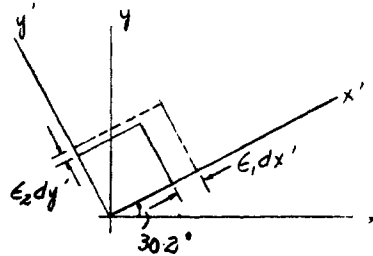

From *Mechanics of Materials*, Sixth Edition by R. C. Hibbeler, ISBN 0-13-191345-X.

© 2005 R. C. Hibbeler. Published by Pearson Prentice Hall,

Pearson Education, Inc., Upper Saddle River, NJ. All rights reserved.

This material is protected under all copyright laws as they currently exist. No portion of this material may be reproduced, in any form or by any means, without permission in writing from the publisher.

*10-8 The state of strain at the point on the gear tooth has the components $\epsilon_x = 520(10^{-6})$, $\epsilon_y = -760(10^{-6})$, $\gamma_{xy} = -750(10^{-6})$. Use the strain-transformation equations to determine (a) the in-plane principal strains and (b) the maximum in plane shear strain and average normal strain. In each case specify the orientation of the element and show how the strains deform the element within the x - y plane.

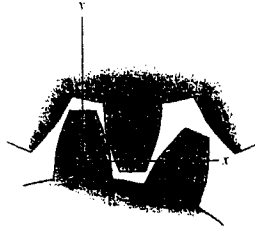

$$\epsilon_x = 520(10^{-6}) \quad \epsilon_y = -760(10^{-6}) \quad \gamma_{xy} = -750(10^{-6})$$

$$a) \epsilon_{1,2} = \frac{\epsilon_x + \epsilon_y}{2} \pm \sqrt{\left(\frac{\epsilon_x - \epsilon_y}{2}\right)^2 + \left(\frac{\gamma_{xy}}{2}\right)^2}$$

$$= \left[\frac{520 + (-760)}{2} \pm \sqrt{\left(\frac{520 - (-760)}{2}\right)^2 + \left(\frac{-750}{2}\right)^2} \right] 10^{-6}$$

$$\epsilon_1 = 622(10^{-6}); \quad \epsilon_2 = -862(10^{-6})$$

Ans

Orientation of ϵ_1 and ϵ_2

$$\tan 2\theta_p = \frac{\gamma_{xy}}{\epsilon_x - \epsilon_y} = \frac{-750}{520 - (-760)} = -0.5859; \quad \theta_p = -15.18^\circ \text{ and } \theta_p = 74.82^\circ$$

Use Eq. 10-5 to determine the direction of ϵ_1 and ϵ_2 .

$$\epsilon_{x'} = \frac{\epsilon_x + \epsilon_y}{2} + \frac{\epsilon_x - \epsilon_y}{2} \cos 2\theta + \frac{\gamma_{xy}}{2} \sin 2\theta$$

$$\theta = \theta_p = -15.18^\circ$$

$$\epsilon_{x'} = \left[\frac{520 + (-760)}{2} + \frac{520 - (-760)}{2} \cos(-30.36^\circ) + \frac{-750}{2} \sin(-30.36^\circ) \right] 10^{-6}$$

$$= 622(10^{-6}) = \epsilon_1$$

$$\text{Therefore } \theta_{p_1} = -15.2^\circ \text{ and } \theta_{p_2} = 74.8^\circ$$

Ans

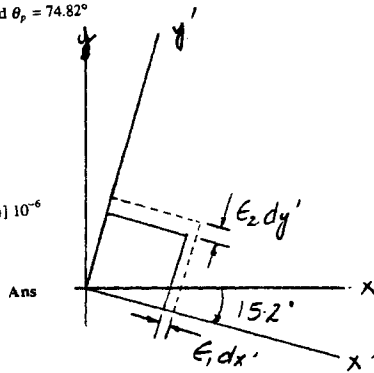

$$b) \frac{\gamma_{max}}{2} = \sqrt{\left(\frac{\epsilon_x - \epsilon_y}{2}\right)^2 + \left(\frac{\gamma_{xy}}{2}\right)^2}$$

$$\frac{\gamma_{max}}{2} = 2 \left[\sqrt{\left(\frac{520 - (-760)}{2}\right)^2 + \left(\frac{-750}{2}\right)^2} \right] 10^{-6} = -1484(10^{-6})$$

Ans

$$\epsilon_{avg} = \frac{\epsilon_x + \epsilon_y}{2} = \left[\frac{520 + (-760)}{2} \right] 10^{-6} = -120(10^{-6})$$

Ans

Orientation of γ_{max} in-plane :

$$\tan 2\theta_s = \frac{-(\epsilon_x - \epsilon_y)}{\gamma_{xy}} = \frac{-[520 - (-760)]}{-750} = 1.7067$$

$$\theta_s = 29.8^\circ \text{ and } \theta_s = -60.2^\circ$$

Use Eq. 10-6 to check the sign of γ_{max} in-plane.

$$\frac{\gamma_{x'y'}}{2} = -\frac{\epsilon_x - \epsilon_y}{2} \sin 2\theta + \frac{\gamma_{xy}}{2} \cos 2\theta; \quad \theta = \theta_s = 29.8^\circ$$

$$\gamma_{x'y'} = 2 \left[-\frac{520 - (-760)}{2} \sin(59.6^\circ) + \frac{-750}{2} \cos(59.6^\circ) \right] 10^{-6} = -1484(10^{-6})$$

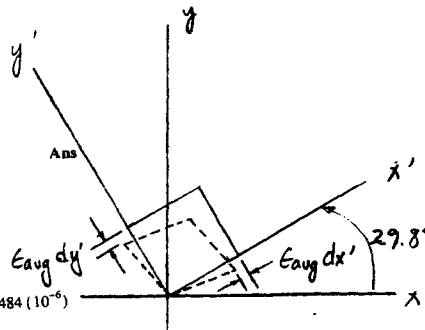

From *Mechanics of Materials*, Sixth Edition by R. C. Hibbeler, ISBN 0-13-191345-X.

© 2005 R. C. Hibbeler. Published by Pearson Prentice Hall,

Pearson Education, Inc., Upper Saddle River, NJ. All rights reserved.

This material is protected under all copyright laws as they currently exist. No portion of this material may be reproduced, in any form or by any means, without permission in writing from the publisher.

10-9 The state of strain at the point on the arm has components $\epsilon_x = 250(10^{-6})$, $\epsilon_y = -450(10^{-6})$, $\gamma_{xy} = -825(10^{-6})$. Use the strain-transformation equations to determine (a) the in-plane principal strains and (b) the maximum in-plane shear strain and average normal strain. In each case specify the orientation of the element and show how the strains deform the element within the x - y plane.

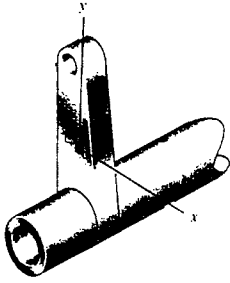

$$\epsilon_x = 250(10^{-6}) \quad \epsilon_y = -450(10^{-6}) \quad \gamma_{xy} = -825(10^{-6})$$

a)

$$\epsilon_{1,2} = \frac{\epsilon_x + \epsilon_y}{2} \pm \sqrt{\left(\frac{\epsilon_x - \epsilon_y}{2}\right)^2 + \left(\frac{\gamma_{xy}}{2}\right)^2}$$

$$= \left[\frac{250 - 450}{2} \pm \sqrt{\left(\frac{250 - (-450)}{2}\right)^2 + \left(\frac{-825}{2}\right)^2} \right] (10^{-6})$$

$$\epsilon_1 = 441(10^{-6}) \quad \text{Ans} \quad \epsilon_2 = -641(10^{-6}) \quad \text{Ans}$$

Orientation of ϵ_1 and ϵ_2 :

$$\tan 2\theta_p = \frac{\gamma_{xy}}{\epsilon_x - \epsilon_y} = \frac{-825}{250 - (-450)}$$

$$\theta_p = -24.84^\circ \quad \text{and} \quad \theta_p = 65.16^\circ$$

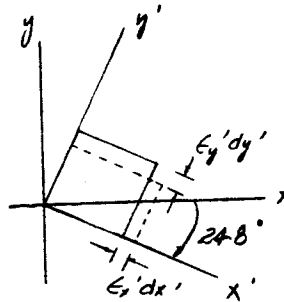

Use Eq. 10-5 to determine the direction of ϵ_1 and ϵ_2 :

$$\epsilon_{x'} = \frac{\epsilon_x + \epsilon_y}{2} + \frac{\epsilon_x - \epsilon_y}{2} \cos 2\theta + \frac{\gamma_{xy}}{2} \sin 2\theta$$

$$\theta = \theta_p = -24.84^\circ$$

$$\epsilon_{x'} = \left[\frac{250 - 450}{2} + \frac{250 - (-450)}{2} \cos(-49.69^\circ) + \frac{-825}{2} \sin(-49.69^\circ) \right] (10^{-6}) = 441(10^{-6})$$

$$\text{Therefore, } \theta_{p1} = -24.8^\circ \quad \text{Ans} \quad \theta_{p2} = 65.2^\circ \quad \text{Ans}$$

b)

$$\frac{\gamma_{\max}}{2} = \sqrt{\left(\frac{\epsilon_x - \epsilon_y}{2}\right)^2 + \left(\frac{\gamma_{xy}}{2}\right)^2}$$

$$\frac{\gamma_{\max}}{2} = 2 \left[\sqrt{\left(\frac{250 - (-450)}{2}\right)^2 + \left(\frac{-825}{2}\right)^2} \right] (10^{-6}) = 1.08(10^{-3})$$

$$\epsilon_{\text{avg}} = \frac{\epsilon_x + \epsilon_y}{2} = \left(\frac{250 - 450}{2} \right) (10^{-6}) = -100(10^{-6}) \quad \text{Ans}$$

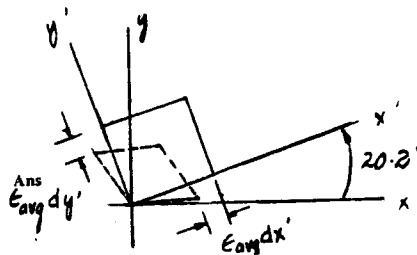

From *Mechanics of Materials*, Sixth Edition by R. C. Hibbeler, ISBN 0-13-191345-X.

© 2005 R. C. Hibbeler. Published by Pearson Prentice Hall,

Pearson Education, Inc., Upper Saddle River, NJ. All rights reserved.

This material is protected under all copyright laws as they currently exist. No portion of this material may be reproduced, in any form or by any means, without permission in writing from the publisher.

10-10 The state of strain at the point on the bracket has components $\epsilon_x = -130(10^{-6})$, $\epsilon_y = 280(10^{-6})$, $\gamma_{xy} = 75(10^{-6})$. Use the strain-transformation equations to determine (a) the in-plane principal strains and (b) the maximum in-plane shear strain and average normal strain. In each case specify the orientation of the element and show how the strains deform the element within the x - y plane.

$$\epsilon_x = -130(10^{-6}) \quad \epsilon_y = 280(10^{-6}) \quad \gamma_{xy} = 75(10^{-6})$$

a)

$$\begin{aligned} \epsilon_{1,2} &= \frac{\epsilon_x + \epsilon_y}{2} \pm \sqrt{\left(\frac{\epsilon_x - \epsilon_y}{2}\right)^2 + \left(\frac{\gamma_{xy}}{2}\right)^2} \\ &= \left[\frac{-130 + 280}{2} \pm \sqrt{\left(\frac{-130 - 280}{2}\right)^2 + \left(\frac{75}{2}\right)^2} \right] (10^{-6}) \end{aligned}$$

$$\epsilon_1 = 283(10^{-6}) \quad \text{Ans} \quad \epsilon_2 = -133(10^{-6}) \quad \text{Ans}$$

Orientation of ϵ_1 and ϵ_2 :

$$\tan 2\theta_p = \frac{\gamma_{xy}}{\epsilon_x - \epsilon_y} = \frac{75}{-130 - 280}$$

$$\theta_p = -5.18^\circ \quad \text{and} \quad 84.82^\circ$$

Use Eq. 10-5 to determine the direction of ϵ_1 and ϵ_2 :

$$\begin{aligned} \epsilon_{x'} &= \frac{\epsilon_x + \epsilon_y}{2} + \frac{\epsilon_x - \epsilon_y}{2} \cos 2\theta + \frac{\gamma_{xy}}{2} \sin 2\theta \\ \theta = \theta_p &= -5.18^\circ \end{aligned}$$

$$\epsilon_x = \left[\frac{-130 + 280}{2} + \frac{-130 - 280}{2} \cos(-10.37^\circ) + \frac{75}{2} \sin(-10.37^\circ) \right] (10^{-6}) = -133(10^{-6})$$

$$\text{Therefore } \theta_{p1} = 84.8^\circ \quad \text{Ans} \quad \theta_{p2} = -5.18^\circ \quad \text{Ans}$$

b)

$$\frac{\gamma_{\max \text{ in-plane}}}{2} = \sqrt{\left(\frac{\epsilon_x - \epsilon_y}{2}\right)^2 + \left(\frac{\gamma_{xy}}{2}\right)^2}$$

$$\frac{\gamma_{\max \text{ in-plane}}}{2} = 2 \left[\sqrt{\left(\frac{-130 - 280}{2}\right)^2 + \left(\frac{75}{2}\right)^2} \right] (10^{-6}) = 417(10^{-6}) \quad \text{Ans}$$

$$\epsilon_{\text{avg}} = \frac{\epsilon_x + \epsilon_y}{2} = \left(\frac{-130 + 280}{2} \right) (10^{-6}) = 75.0(10^{-6}) \quad \text{Ans}$$

Orientation of γ_{\max} :

$$\tan 2\theta_s = \frac{-(\epsilon_x - \epsilon_y)}{\gamma_{xy}} = \frac{-(-250 - (-450))}{-825}$$

$$\theta_s = 20.2^\circ \quad \text{and} \quad \theta_s = 110^\circ \quad \text{Ans}$$

Use Eq. 10-16 to determine the sign of $\gamma_{\max \text{ in-plane}}$:

$$\frac{\gamma_{x'y'}}{2} = -\frac{\epsilon_x - \epsilon_y}{2} \sin 2\theta + \frac{\gamma_{xy}}{2} \cos 2\theta; \quad \theta = \theta_s = 20.2^\circ$$

$$\gamma_{x'y'} = [-(250 - (-450)) \sin 40.4^\circ + (-825) \cos 40.4^\circ] (10^{-6}) = -1082(10^{-6})$$

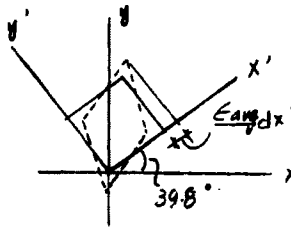
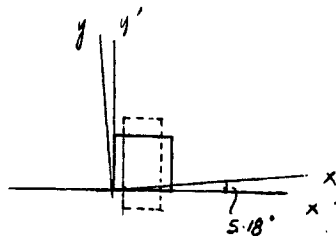
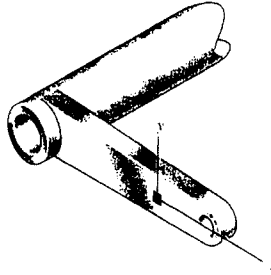

From *Mechanics of Materials*, Sixth Edition by R. C. Hibbeler, ISBN 0-13-191345-X.

© 2005 R. C. Hibbeler. Published by Pearson Prentice Hall,

Pearson Education, Inc., Upper Saddle River, NJ. All rights reserved.

This material is protected under all copyright laws as they currently exist. No portion of this material may be reproduced, in any form or by any means, without permission in writing from the publisher.

10-11. The state of strain at the point on the boom of the hydraulic engine crane has components of $\epsilon_x = 250(10^{-6})$, $\epsilon_y = 300(10^{-6})$, and $\gamma_{xy} = -180(10^{-6})$. Use the strain-transformation equations to determine (a) the in-plane principal strains and (b) the maximum in-plane shear strain and average normal strain. In each case specify the orientation of the element and show how the strains deform the element within the x - y plane.

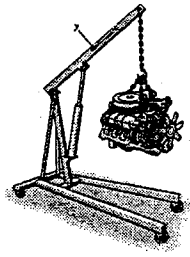

a)

In-Plane Principal Strain : Applying Eq. 10-9,

Normal Strain and Shear strain : In accordance with the sign convention,

$$\begin{aligned} \epsilon_{1,2} &= \frac{\epsilon_x + \epsilon_y}{2} \pm \sqrt{\left(\frac{\epsilon_x - \epsilon_y}{2}\right)^2 + \left(\frac{\gamma_{xy}}{2}\right)^2} \\ &= \left[\frac{250 + 300}{2} \pm \sqrt{\left(\frac{250 - 300}{2}\right)^2 + \left(\frac{-180}{2}\right)^2} \right] (10^{-6}) \\ &= 275 \pm 93.41 \end{aligned}$$

$$\epsilon_x = 250(10^{-6}) \quad \epsilon_y = 300(10^{-6}) \quad \gamma_{xy} = -180(10^{-6})$$

$$\epsilon_1 = 368(10^{-6}) \quad \epsilon_2 = 182(10^{-6}) \quad \text{Ans}$$

Orientation of Principal Strain : Applying Eq. 10-8,

$$\begin{aligned} \tan 2\theta_p &= \frac{\gamma_{xy}}{\epsilon_x - \epsilon_y} = \frac{-180(10^{-6})}{(250 - 300)(10^{-6})} = 3.600 \\ \theta_p &= 37.24^\circ \quad \text{and} \quad -52.76^\circ \end{aligned}$$

Use Eq. 10-5 to determine which principal strain deforms the element in the x' direction with $\theta = 37.24^\circ$.

$$\begin{aligned} \epsilon_{x'} &= \frac{\epsilon_x + \epsilon_y}{2} + \frac{\epsilon_x - \epsilon_y}{2} \cos 2\theta + \frac{\gamma_{xy}}{2} \sin 2\theta \\ &= \left[\frac{250 + 300}{2} + \frac{250 - 300}{2} \cos 74.48^\circ + \frac{-180}{2} \sin 74.48^\circ \right] (10^{-6}) \\ &= 182(10^{-6}) = \epsilon_2 \end{aligned}$$

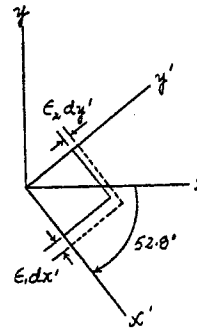

Hence, $\theta_{p_1} = -52.8^\circ$ and $\theta_{p_2} = 37.2^\circ$ Ans

b)

Maximum In-Plane Shear Strain : Applying Eq. 10-11,

$$\begin{aligned} \frac{\gamma_{\max \text{ in-plane}}}{2} &= \sqrt{\left(\frac{\epsilon_x - \epsilon_y}{2}\right)^2 + \left(\frac{\gamma_{xy}}{2}\right)^2} \\ \gamma_{\max \text{ in-plane}} &= 2 \left[\sqrt{\left(\frac{250 - 300}{2}\right)^2 + \left(\frac{-180}{2}\right)^2} \right] (10^{-6}) \\ &= 187(10^{-6}) \quad \text{Ans} \end{aligned}$$

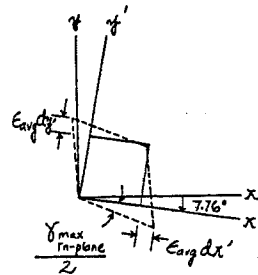

Orientation of Maximum In-Plane Shear Strain : Applying Eq. 10-10,

$$\begin{aligned} \tan 2\theta_s &= -\frac{\epsilon_x - \epsilon_y}{\gamma_{xy}} = -\frac{250 - 300}{-180} = -0.2778 \\ \theta_s &= -7.76^\circ \quad \text{and} \quad 82.2^\circ \quad \text{Ans} \end{aligned}$$

The proper sign of $\gamma_{\max \text{ in-plane}}$ can be determined by substituting $\theta = -7.76^\circ$ into Eq. 10-6.

$$\begin{aligned} \frac{\gamma_{x'y'}}{2} &= -\frac{\epsilon_x - \epsilon_y}{2} \sin 2\theta + \frac{\gamma_{xy}}{2} \cos 2\theta \\ \gamma_{x'y'} &= \{-[250 - 300] \sin(-15.52^\circ) + (-180) \cos(-15.52^\circ)\} (10^{-6}) \\ &= -187(10^{-6}) \end{aligned}$$

Average Normal Strain : Applying Eq. 10-12,

$$\epsilon_{\text{avg}} = \frac{\epsilon_x + \epsilon_y}{2} = \left[\frac{250 + 300}{2} \right] (10^{-6}) = 275(10^{-6}) \quad \text{Ans}$$

From *Mechanics of Materials*, Sixth Edition by R. C. Hibbeler, ISBN 0-13-191345-X.

© 2005 R. C. Hibbeler. Published by Pearson Prentice Hall,

Pearson Education, Inc., Upper Saddle River, NJ. All rights reserved.

This material is protected under all copyright laws as they currently exist. No portion of this material may be reproduced, in any form or by any means, without permission in writing from the publisher.

***10-12** A strain gauge is mounted on the 1-in.-diameter A-36 steel shaft in the manner shown. When the shaft is rotating with an angular velocity of $\omega = 1760$ rev/min, using a slip ring the reading on the strain gauge is $\epsilon = 800(10^{-6})$. Determine the power output of the motor. Assume the shaft is only subjected to a torque.

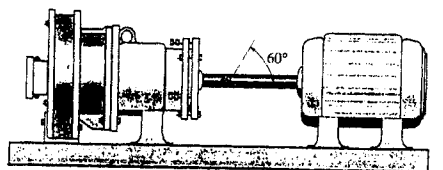

$$\omega = (1760 \text{ rev/min}) \left(\frac{1 \text{ min}}{60 \text{ sec}} \right) \left(\frac{2\pi \text{ rad}}{1 \text{ rev}} \right) = 184.307 \text{ rad/s}$$

$$\epsilon_x = \epsilon_y = 0$$

$$\epsilon_x = \frac{\epsilon_x + \epsilon_y}{2} + \frac{\epsilon_x - \epsilon_y}{2} \cos 2\theta + \frac{\gamma_{xy}}{2} \sin 2\theta$$

$$800(10^{-6}) = 0 + 0 + \frac{\gamma_{xy}}{2} \sin 120^\circ$$

$$\gamma_{xy} = 1.848(10^{-3}) \text{ rad}$$

$$\tau = G \gamma_{xy} = 11(10^3)(1.848)(10^{-3}) = 20.323 \text{ ksi}$$

$$\tau = \frac{Tc}{J}; \quad 20.323 = \frac{T(0.5)}{\frac{\pi}{2}(0.5)^4};$$

$$T = 3.99 \text{ lb} \cdot \text{in} = 332.5 \text{ lb} \cdot \text{ft}$$

$$P = T\omega = 0.332.5 (184.307) = 61.3 \text{ lb} \cdot \text{ft} / \text{s} = 111 \text{ hp} \quad \text{Ans.}$$

From *Mechanics of Materials*, Sixth Edition by R. C. Hibbeler, ISBN 0-13-191345-X.

© 2005 R. C. Hibbeler. Published by Pearson Prentice Hall,

Pearson Education, Inc., Upper Saddle River, NJ. All rights reserved.

This material is protected under all copyright laws as they currently exist. No portion of this material may be reproduced, in any form or by any means, without permission in writing from the publisher.

10-13 The state of strain at the point on the support has components of $\epsilon_x = 350(10^{-6})$, $\epsilon_y = 400(10^{-6})$, $\gamma_{xy} = -675(10^{-6})$. Use the strain-transformation equations to determine (a) the in-plane principal strains and (b) the maximum in-plane shear strain and average normal strain. In each case specify the orientation of the element and show how the strains deform the element within the x - y plane.



a)

$$\epsilon_{1,2} = \frac{\epsilon_x + \epsilon_y}{2} \pm \sqrt{\left(\frac{\epsilon_x - \epsilon_y}{2}\right)^2 + \left(\frac{\gamma_{xy}}{2}\right)^2}$$

$$= \frac{350 + 400}{2} \pm \sqrt{\left(\frac{350 - 400}{2}\right)^2 + \left(\frac{-675}{2}\right)^2}$$

$$\epsilon_1 = 713(10^{-6}) \quad \text{Ans} \quad \epsilon_2 = 36.6(10^{-6}) \quad \text{Ans}$$

$$\tan 2\theta_p = \frac{\gamma_{xy}}{\epsilon_x - \epsilon_y} = \frac{-675}{350 - 400}$$

$$\theta_p = 42.9^\circ \quad \text{Ans}$$

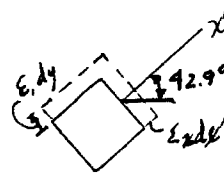

b)

$$\frac{(\gamma_{x'y'})_{\max}}{2} = \sqrt{\left(\frac{\epsilon_x - \epsilon_y}{2}\right)^2 + \left(\frac{\gamma_{xy}}{2}\right)^2}$$

$$\frac{(\gamma_{x'y'})_{\max}}{2} = \sqrt{\left(\frac{350 - 400}{2}\right)^2 + \left(\frac{-675}{2}\right)^2}$$

$$(\gamma_{x'y'})_{\max} = 677(10^{-6}) \quad \text{Ans}$$

$$\epsilon_{\text{avg}} = \frac{\epsilon_x + \epsilon_y}{2} = \frac{350 + 400}{2} = 375(10^{-6}) \quad \text{Ans}$$

$$\tan 2\theta_s = \frac{-(\epsilon_x - \epsilon_y)}{\gamma_{xy}} = \frac{350 - 400}{675}$$

$$\theta_s = -2.12^\circ \quad \text{Ans}$$

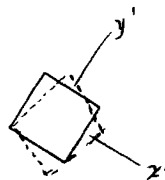

From *Mechanics of Materials*, Sixth Edition by R. C. Hibbeler, ISBN 0-13-191345-X.

© 2005 R. C. Hibbeler. Published by Pearson Prentice Hall,

Pearson Education, Inc., Upper Saddle River, NJ. All rights reserved.

This material is protected under all copyright laws as they currently exist. No portion of this material may be reproduced, in any form or by any means, without permission in writing from the publisher.

Because of the number and variety of potential correct solutions to this problem, no solution is being given.

From *Mechanics of Materials*, Sixth Edition by R. C. Hibbeler, ISBN 0-13-191345-X.

© 2005 R. C. Hibbeler. Published by Pearson Prentice Hall,

Pearson Education, Inc, Upper Saddle River, NJ. All rights reserved.

This material is protected under all copyright laws as they currently exist. No portion of this material may be reproduced, in any form or by any means, without permission in writing from the publisher.

10-15 Solve Prob. 10-2 using Mohr's circle.

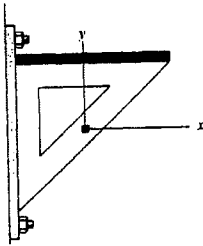

$$\epsilon_x = -200(10^{-6}) \quad \epsilon_y = -650(10^{-6}) \quad \gamma_{xy} = -175(10^{-6}) \quad \frac{\gamma_{xy}}{2} = -87.5(10^{-6})$$

$$\theta = 20^\circ, \quad 2\theta = 40^\circ$$

$$A(-200, -87.5)(10^{-6}) \quad C(-425, 0)(10^{-6})$$

$$R = [\sqrt{(-200 - (-425))^2 + 87.5^2}](10^{-6}) = 241.41(10^{-6})$$

$$\tan \alpha = \frac{87.5}{-200 - (-425)}; \quad \alpha = 21.25^\circ$$

$$\phi = 40 + 21.25 = 61.25^\circ$$

$$\epsilon_{x'} = (-425 + 241.41 \cos 61.25^\circ)(10^{-6}) = -309(10^{-6}) \quad \text{Ans}$$

$$\epsilon_{y'} = (-425 - 241.41 \cos 61.25^\circ)(10^{-6}) = -541(10^{-6}) \quad \text{Ans}$$

$$\frac{-\gamma_{x'y'}}{2} = 241.41(10^{-6}) \sin 61.25^\circ$$

$$\gamma_{x'y'} = -423(10^{-6}) \quad \text{Ans}$$

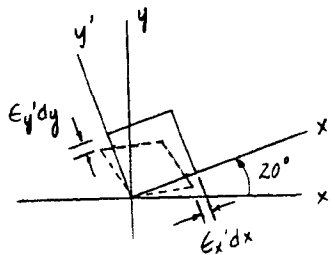
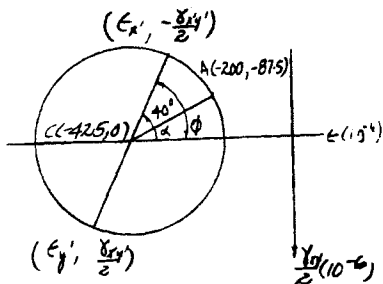

From *Mechanics of Materials*, Sixth Edition by R. C. Hibbeler, ISBN 0-13-191345-X.

© 2005 R. C. Hibbeler. Published by Pearson Prentice Hall,

Pearson Education, Inc., Upper Saddle River, NJ. All rights reserved.

This material is protected under all copyright laws as they currently exist. No portion of this material may be reproduced, in any form or by any means, without permission in writing from the publisher.

*10-16 Solve Prob. 10-4 using Mohr's circle.

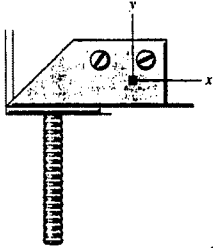

$$\epsilon_x = 150(10^{-6}) \quad \epsilon_y = 200(10^{-6}) \quad \gamma_{xy} = -700(10^{-6}) \quad \frac{\gamma_{xy}}{2} = -350(10^{-6})$$

$$\theta = -30^\circ \quad 2\theta = -60^\circ$$

$$A(150, -350); \quad C(175, 0)$$

$$R = \sqrt{(175 - 150)^2 + (-350)^2} = 350.89$$

Coordinates of point B :

$$\epsilon_{x'} = 350.89 \cos 34.09^\circ + 175$$

$$= 466(10^{-6}) \quad \text{Ans}$$

$$\frac{\gamma_{x'y'}}{2} = -350.89 \sin 34.09^\circ$$

$$\gamma_{x'y'} = -393(10^{-6}) \quad \text{Ans}$$

Coordinates of point D :

$$\epsilon_{y'} = 175 - 350.89 \cos 34.09^\circ$$

$$= -116(10^{-6}) \quad \text{Ans}$$

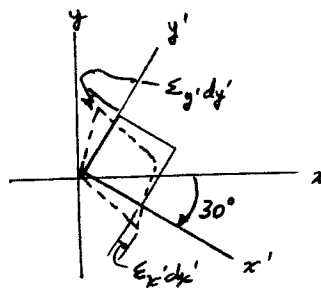
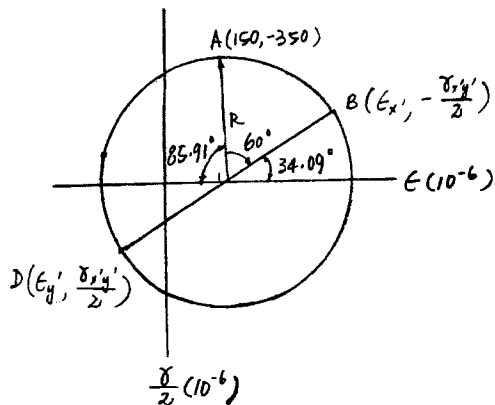

From *Mechanics of Materials*, Sixth Edition by R. C. Hibbeler, ISBN 0-13-191345-X.

© 2005 R. C. Hibbeler. Published by Pearson Prentice Hall,

Pearson Education, Inc., Upper Saddle River, NJ. All rights reserved.

This material is protected under all copyright laws as they currently exist. No portion of this material may be reproduced, in any form or by any means, without permission in writing from the publisher.

10-17 Solve Prob. 10-3 using Mohr's circle.

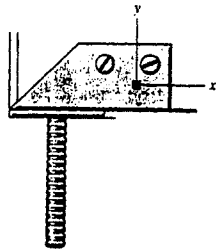

$$\epsilon_x = 150(10^{-6}) \quad \epsilon_y = 200(10^{-6}) \quad \gamma_{xy} = -700(10^{-6}) \quad \frac{\gamma_{xy}}{2} = -350(10^{-6})$$

$$\theta = 60^\circ \quad 2\theta = 120^\circ \quad (\text{Mohr's circle})$$

$$A(150, -350)10^{-6} \quad C(175, 0)10^{-6}$$

$$R = CA = [\sqrt{(175 - 150)^2 + 350^2}]10^{-6} = 350.89(10^{-6})$$

$$\tan \alpha = \frac{350}{175 - 150} \quad \alpha = 85.91^\circ$$

$$\beta = 120 - 85.91 = 34.09^\circ$$

$$\epsilon_{x'} = (175 - 350.89 \cos 34.09^\circ)10^{-6} = -116(10^{-6}) \quad \text{Ans}$$

$$\epsilon_{y'} = (175 + 350.89 \cos 34.09^\circ)10^{-6} = 466(10^{-6}) \quad \text{Ans}$$

$$\gamma_{x'y'} = 2[350.89 \sin 34.09^\circ]10^{-6} = 393(10^{-6}) \quad \text{Ans}$$

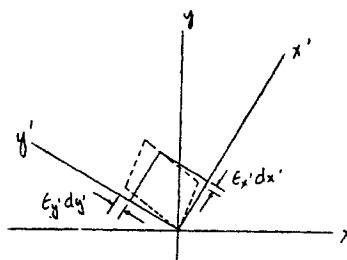
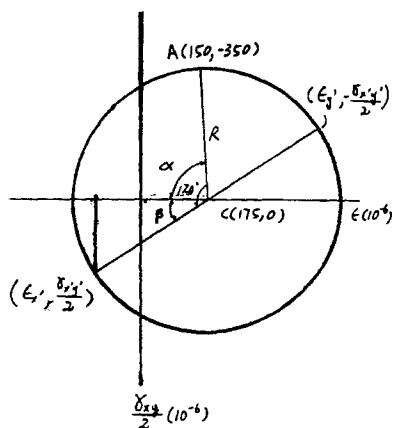

From *Mechanics of Materials*, Sixth Edition by R. C. Hibbeler, ISBN 0-13-191345-X.

© 2005 R. C. Hibbeler. Published by Pearson Prentice Hall,

Pearson Education, Inc., Upper Saddle River, NJ. All rights reserved.

This material is protected under all copyright laws as they currently exist. No portion of this material may be reproduced, in any form or by any means, without permission in writing from the publisher.

10-18 Solve Prob. 10-5 using Mohr's circle.

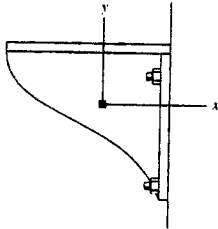

$$\epsilon_x = 400(10^{-6}) \quad \epsilon_y = -250(10^{-6}) \quad \gamma_{xy} = 310(10^{-6}) \quad \frac{\gamma_{xy}}{2} = 155(10^{-6}) \quad \theta = 30^\circ$$

$$A(400, 155)(10^{-6}) \quad C(75, 0)(10^{-6})$$

$$R = [\sqrt{(400-75)^2 + 155^2}] (10^{-6}) = 360.1(10^{-6})$$

$$\tan \alpha = \frac{155}{400-75}; \quad \alpha = 25.50^\circ$$

$$\phi = 60 + 25.50 = 85.5^\circ$$

$$\epsilon_{x'} = (75 + 360.1 \cos 85.5^\circ)(10^{-6}) = 103(10^{-6}) \quad \text{Ans}$$

$$\epsilon_{y'} = (75 - 360.1 \cos 85.5^\circ)(10^{-6}) = 46.7(10^{-6}) \quad \text{Ans}$$

$$\frac{\gamma_{x'y'}}{2} = (360.1 \sin 85.5^\circ)(10^{-6})$$

$$\gamma_{x'y'} = 718(10^{-6}) \quad \text{Ans}$$

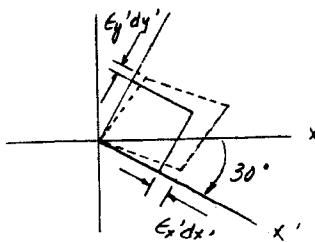
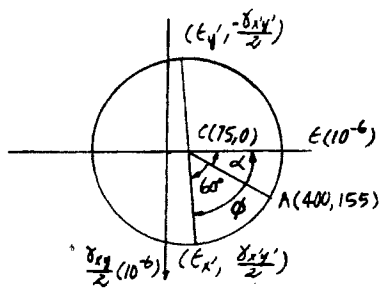

From *Mechanics of Materials*, Sixth Edition by R. C. Hibbeler, ISBN 0-13-191345-X.

© 2005 R. C. Hibbeler. Published by Pearson Prentice Hall,

Pearson Education, Inc., Upper Saddle River, NJ. All rights reserved.

This material is protected under all copyright laws as they currently exist. No portion of this material may be reproduced, in any form or by any means, without permission in writing from the publisher.

Construction of the Circle : In accordance with the sign convention, $\epsilon_x = 250(10^{-6})$, $\epsilon_y = 300(10^{-6})$, and $\frac{\gamma_{xy}}{2} = -90(10^{-6})$. Hence,

$$\epsilon_{avg} = \frac{\epsilon_x + \epsilon_y}{2} = \left(\frac{250 + 300}{2}\right)(10^{-6}) = 275(10^{-6}) \quad \text{Ans}$$

The coordinates for reference points *A* and *C* are

$$A(250, -90)(10^{-6}) \quad C(275, 0)(10^{-6})$$

The radius of the circle is

$$R = \left(\sqrt{(275 - 250)^2 + 90^2}\right)(10^{-6}) = 93.408$$

In - Plane Principal Strain : The coordinates of points *B* and *D* represent ϵ_1 and ϵ_2 , respectively.

$$\epsilon_1 = (275 + 93.408)(10^{-6}) = 368(10^{-6}) \quad \text{Ans}$$

$$\epsilon_2 = (275 - 93.408)(10^{-6}) = 182(10^{-6}) \quad \text{Ans}$$

Orientation of Principal Strain : From the circle,

$$\tan 2\theta_{p_2} = \frac{90}{275 - 250} = 3.600 \quad 2\theta_{p_2} = 74.48^\circ$$

$$2\theta_{p_1} = 180^\circ - 2\theta_{p_2}$$

$$\theta_{p_1} = \frac{180^\circ - 74.48^\circ}{2} = 52.8^\circ \quad \text{(Clockwise)} \quad \text{Ans}$$

Maximum In - Plane Shear Strain : Represented by the coordinates of point *E* on the circle.

$$\frac{\gamma_{max \text{ in-plane}}}{2} = -R = -93.408(10^{-6})$$

$$\gamma_{max \text{ in-plane}} = -187(10^{-6}) \quad \text{Ans}$$

Orientation of Maximum In - Plane Shear Strain : From the circle,

$$\tan 2\theta_s = \frac{275 - 250}{90} = 0.2778$$

$$\theta_s = 7.76^\circ \quad \text{(Clockwise)} \quad \text{Ans}$$

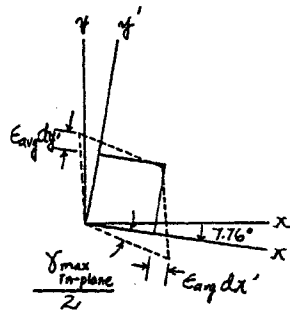
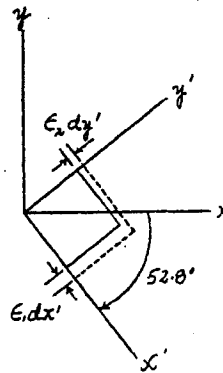
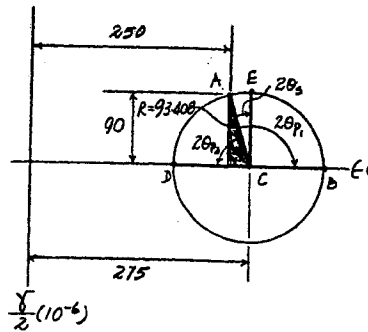

From *Mechanics of Materials*, Sixth Edition by R. C. Hibbeler, ISBN 0-13-191345-X.

© 2005 R. C. Hibbeler. Published by Pearson Prentice Hall,

Pearson Education, Inc., Upper Saddle River, NJ. All rights reserved.

This material is protected under all copyright laws as they currently exist. No portion of this material may be reproduced, in any form or by any means, without permission in writing from the publisher.

*10-20 Solve Prob. 10-8 using Mohr's circle.

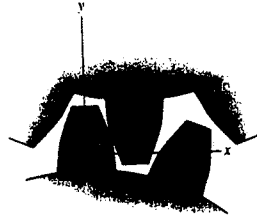

a) $\epsilon_x = 520(10^{-6})$ $\epsilon_y = -760(10^{-6})$ $\gamma_{xy} = -750(10^{-6})$ $\frac{\gamma_{xy}}{2} = -375(10^{-6})$

$A(520, -375); \quad C(-120, 0)$
 $R = \sqrt{(520 + 120)^2 + 375^2} = 741.77$

$\epsilon_1 = 741.77 - 120 = 622(10^{-6})$

$\epsilon_2 = -120 - 741.77 = -862(10^{-6})$

$\tan 2\theta_{p_1} = \frac{375}{(120 + 520)} = 0.5859$

$\theta_{p_1} = 15.2^\circ$

b) $\gamma_{\max \text{ in-plane}} = 2R = 2(741.77)$

$\gamma_{\max \text{ in-plane}} = -1484(10^{-6})$

$\epsilon_{avg} = -120(10^{-6})$

$\tan 2\theta_s = \frac{(120 + 520)}{375} = 1.7067$

$\theta_s = 29.8^\circ$

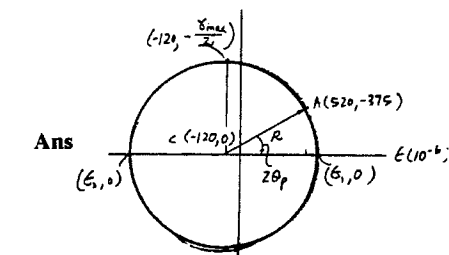
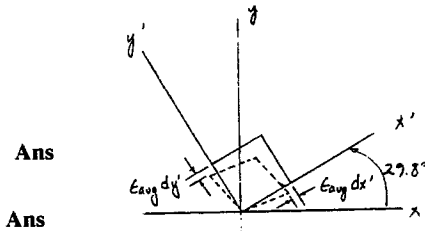

Ans $\frac{\gamma}{2}(10^{-6})$

Ans

Ans

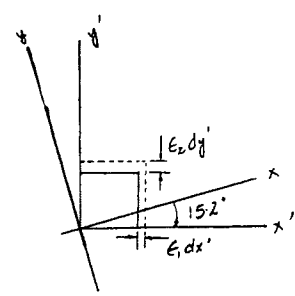

From *Mechanics of Materials*, Sixth Edition by R. C. Hibbeler, ISBN 0-13-191345-X.
 © 2005 R. C. Hibbeler. Published by Pearson Prentice Hall,
 Pearson Education, Inc., Upper Saddle River, NJ. All rights reserved.
 This material is protected under all copyright laws as they currently exist. No portion of this material may be reproduced, in any form or by any means, without permission in writing from the publisher.

10-21 Solve Prob. 10-7 using Mohr's circle.

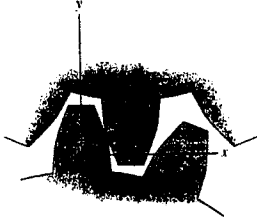

$$\epsilon_x = 850(10^{-6}) \quad \epsilon_y = 480(10^{-6}) \quad \gamma_{xy} = 650(10^{-6}) \quad \frac{\gamma_{xy}}{2} = 325(10^{-6})$$

$$A(850, 325)(10^{-6}) \quad C(665, 0)(10^{-6})$$

$$R = [\sqrt{(850 - 665)^2 + 325^2}](10^{-6}) = 373.97(10^{-6})$$

$$\epsilon_1 = (665 + 373.97)(10^{-6}) = 1039(10^{-6}) \quad \text{Ans}$$

$$\epsilon_2 = (665 - 373.97)(10^{-6}) = 291(10^{-6}) \quad \text{Ans}$$

$$\tan 2\theta_p = \frac{325}{850 - 665}$$

$$2\theta_p = 60.35^\circ \quad (\text{Mohr's circle})$$

$$\theta_p = 30.2^\circ \quad (\text{element})$$

$$\frac{\gamma_{\max \text{ in-plane}}}{2} = R$$

$$\gamma_{\max \text{ in-plane}} = 2(373.97)(10^{-6}) = 748(10^{-6}) \quad \text{Ans}$$

$$\epsilon_{\text{avg}} = 665(10^{-6}) \quad \text{Ans}$$

$$2\theta_s = 90^\circ - 2\theta_p = 29.65^\circ \quad (\text{Mohr's circle})$$

$$\theta_s = -14.8^\circ \quad (\text{element})$$

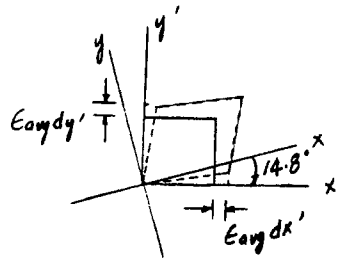
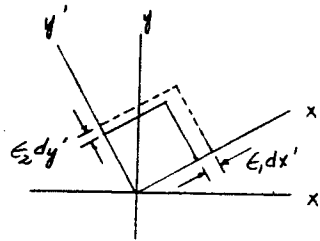
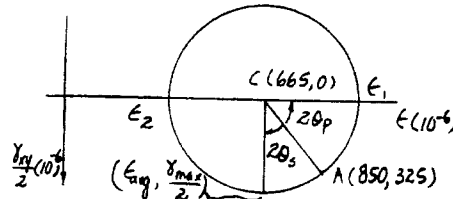

From *Mechanics of Materials*, Sixth Edition by R. C. Hibbeler, ISBN 0-13-191345-X.

© 2005 R. C. Hibbeler. Published by Pearson Prentice Hall,

Pearson Education, Inc., Upper Saddle River, NJ. All rights reserved.

This material is protected under all copyright laws as they currently exist. No portion of this material may be reproduced, in any form or by any means, without permission in writing from the publisher.

10-22 Solve Prob. 10-9 using Mohr's circle.

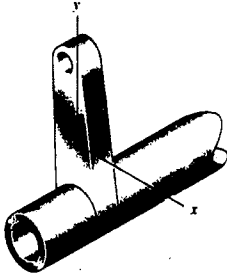

$$\epsilon_x = 250(10^{-6}) \quad \epsilon_y = -450(10^{-6}) \quad \gamma_{xy} = -825(10^{-6}) \quad \frac{\gamma_{xy}}{2} = -412.5(10^{-6})$$

$$A(250, -412.5)(10^{-6}) \quad C(-100, 0)(10^{-6})$$

$$R = \sqrt{(250 - (-100))^2 + (-412.5)^2}(10^{-6}) = 540.98(10^{-6})$$

$$\epsilon_1 = (-100 + 540.98)(10^{-6}) = 441(10^{-6}) \quad \text{Ans}$$

$$\epsilon_2 = (-100 - 540.98)(10^{-6}) = -641(10^{-6}) \quad \text{Ans}$$

$$\tan 2\theta_p = \frac{412.5}{250 - (-100)}$$

$$2\theta_p = 49.68^\circ \quad (\text{Mohr's circle})$$

$$\theta_p = -24.8^\circ \quad (\text{element})$$

$$\frac{\gamma_{\max}^{\text{in-plane}}}{2} = R$$

$$\gamma_{\max}^{\text{in-plane}} = 2(540.98)(10^{-6}) = 1.08(10^{-3}) \quad \text{Ans}$$

$$\epsilon_{\text{avg}} = -100(10^{-6}) \quad \text{Ans}$$

$$2\theta_s - 90^\circ - 2\theta_p = 40.32 \quad (\text{Mohr's circle})$$

$$\theta_s = 20.2^\circ \quad (\text{element}) \quad \text{Ans}$$

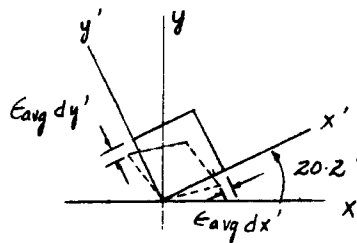
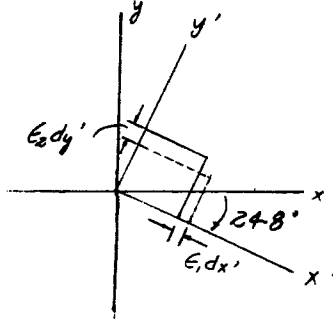
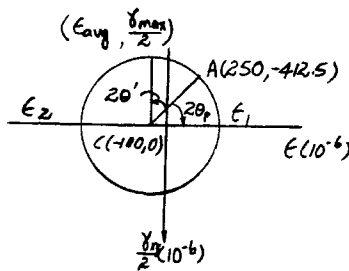

From *Mechanics of Materials*, Sixth Edition by R. C. Hibbeler, ISBN 0-13-191345-X.
 © 2005 R. C. Hibbeler. Published by Pearson Prentice Hall,
 Pearson Education, Inc., Upper Saddle River, NJ. All rights reserved.
 This material is protected under all copyright laws as they currently exist. No portion of this material may be reproduced, in any form or by any means, without permission in writing from the publisher.

10-23. The strain at point A on the bracket has components $\epsilon_x = 300(10^{-6})$, $\epsilon_y = 550(10^{-6})$, $\gamma_{xy} = -650(10^{-6})$, $\epsilon_z = 0$. Determine (a) the principal strains at A , (b) the maximum shear strain in the x - y plane, and (c) the absolute maximum shear strain.

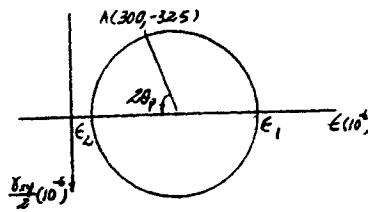
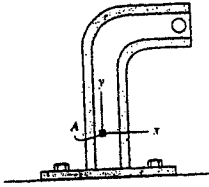

$$\epsilon_x = 300(10^{-6}) \quad \epsilon_y = 550(10^{-6}) \quad \gamma_{xy} = -650(10^{-6}) \quad \frac{\gamma_{xy}}{2} = -325(10^{-6})$$

$$A(300, -325)10^{-6} \quad C(425, 0)10^{-6}$$

$$R = \sqrt{(425 - 300)^2 + (-325)^2} 10^{-6} = 348.2(10^{-6})$$

a)

$$\epsilon_1 = (425 + 348.2)(10^{-6}) = 773(10^{-6}) \quad \text{Ans}$$

$$\epsilon_2 = (425 - 348.2)(10^{-6}) = 76.8(10^{-6}) \quad \text{Ans}$$

b)

$$\gamma_{\max}^{\text{in-plane}} = 2R = 2(348.2)(10^{-6}) = 696(10^{-6}) \quad \text{Ans}$$

c)

$$\frac{\gamma_{\max}^{\text{abs}}}{2} = \frac{773(10^{-6})}{2}; \quad \gamma_{\max}^{\text{abs}} = 773(10^{-6}) \quad \text{Ans}$$

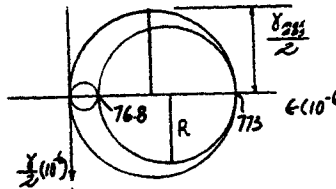

From *Mechanics of Materials*, Sixth Edition by R. C. Hibbeler, ISBN 0-13-191345-X.

© 2005 R. C. Hibbeler. Published by Pearson Prentice Hall,

Pearson Education, Inc., Upper Saddle River, NJ. All rights reserved.

This material is protected under all copyright laws as they currently exist. No portion of this material may be reproduced, in any form or by any means, without permission in writing from the publisher.

***10-24** The strain at point *A* on the beam has components $\epsilon_x = 450(10^{-6})$, $\epsilon_y = 825(10^{-6})$, $\gamma_{xy} = 275(10^{-6})$, $\epsilon_z = 0$. Determine (a) the principal strains at *A*, (b) the maximum shear strain in the *x-y* plane, and (c) the absolute maximum shear strain.

$$\epsilon_x = 450(10^{-6}) \quad \epsilon_y = 825(10^{-6}) \quad \gamma_{xy} = 275(10^{-6}) \quad \frac{\gamma_{xy}}{2} = 137.5(10^{-6})$$

$$A(450, 137.5)10^{-6} \quad C(637.5, 0)10^{-6}$$

$$R = [\sqrt{(637.5 - 450)^2 + 137.5^2}]10^{-6} = 232.51(10^{-6})$$

a)

$$\epsilon_1 = (637.5 + 232.51)(10^{-6}) = 870(10^{-6}) \quad \text{Ans}$$

$$\epsilon_2 = (637.5 - 232.51)(10^{-6}) = 405(10^{-6}) \quad \text{Ans}$$

b)

$$\frac{\gamma_{\max}}{\text{in-plane}} = 2R = 2(232.51)(10^{-6}) = 465(10^{-6}) \quad \text{Ans}$$

c)

$$\frac{\gamma_{\max}^{\text{abs}}}{2} = \frac{870(10^{-6})}{2}; \quad \gamma_{\max}^{\text{abs}} = 870(10^{-6}) \quad \text{Ans}$$

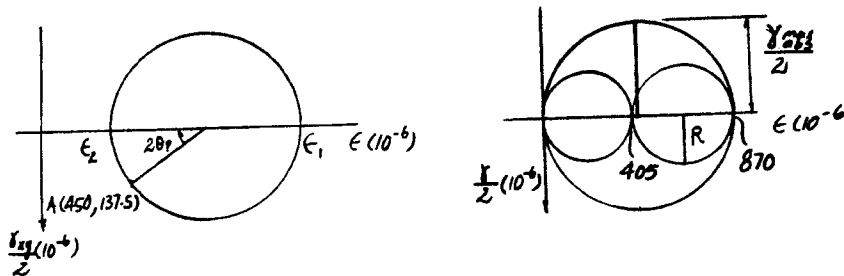

From *Mechanics of Materials*, Sixth Edition by R. C. Hibbeler, ISBN 0-13-191345-X.

© 2005 R. C. Hibbeler. Published by Pearson Prentice Hall,

Pearson Education, Inc., Upper Saddle River, NJ. All rights reserved.

This material is protected under all copyright laws as they currently exist. No portion of this material may be reproduced, in any form or by any means, without permission in writing from the publisher.

10-25 The strain at point A on the pressure-vessel wall has components $\epsilon_x = 480(10^{-6})$, $\epsilon_y = 720(10^{-6})$, $\gamma_{xy} = 650(10^{-6})$, $\epsilon_z = 0$. Determine (a) the principal strains at A, (b) the maximum shear strain in the $x-y$ plane, and (c) the absolute maximum shear strain.

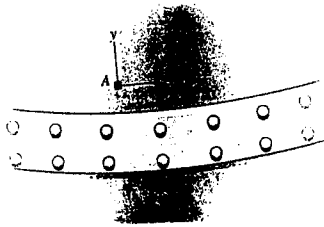

$$\epsilon_x = 480(10^{-6}) \quad \epsilon_y = 720(10^{-6}) \quad \gamma_{xy} = 650(10^{-6}) \quad \frac{\gamma_{xy}}{2} = 325(10^{-6})$$

$$A(480, 325)10^{-6} \quad C(600, 0)10^{-6}$$

$$R = (\sqrt{(600 - 480)^2 + 325^2})10^{-6} = 346.44(10^{-6})$$

a)

$$\epsilon_1 = (600 + 346.44)10^{-6} = 946(10^{-6}) \quad \text{Ans}$$

$$\epsilon_2 = (600 - 346.44)10^{-6} = 254(10^{-6}) \quad \text{Ans}$$

b)

$$\gamma_{\text{max in-plane}} = 2R = 2(346.44)10^{-6} = 693(10^{-6}) \quad \text{Ans}$$

c)

$$\frac{\gamma_{\text{max abs}}}{2} = \frac{946(10^{-6})}{2}; \quad \gamma_{\text{max abs}} = 946(10^{-6}) \quad \text{Ans}$$

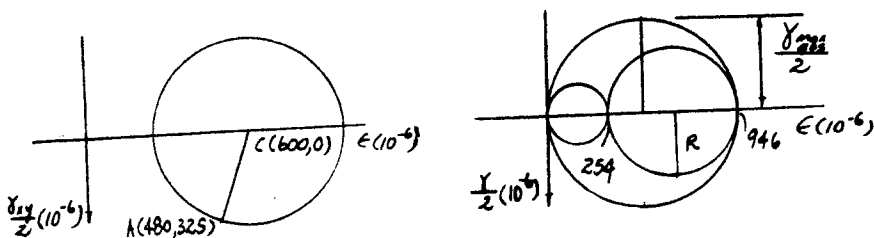

From *Mechanics of Materials*, Sixth Edition by R. C. Hibbeler, ISBN 0-13-191345-X.

© 2005 R. C. Hibbeler. Published by Pearson Prentice Hall,

Pearson Education, Inc., Upper Saddle River, NJ. All rights reserved.

This material is protected under all copyright laws as they currently exist. No portion of this material may be reproduced, in any form or by any means, without permission in writing from the publisher.

10-26. The strain at point A on the leg of the angle has components $\epsilon_x = -140(10^{-6})$, $\epsilon_y = 180(10^{-6})$, $\gamma_{xy} = -125(10^{-6})$, $\epsilon_z = 0$. Determine (a) the principal strains at A , (b) the maximum shear strain in the x - y plane, and (c) the absolute maximum shear strain.

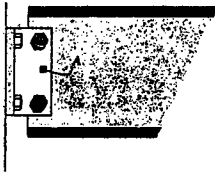

$$\epsilon_x = -140(10^{-6}) \quad \epsilon_y = 180(10^{-6}) \quad \gamma_{xy} = -125(10^{-6}) \quad \frac{\gamma_{xy}}{2} = -62.5(10^{-6})$$

$$A(-140, -62.5)10^{-6} \quad C(20, 0)10^{-6}$$

$$R = (\sqrt{(20 - (-140))^2 + (-62.5)^2})10^{-6} = 171.77(10^{-6})$$

a)

$$\epsilon_1 = (20 + 171.77)(10^{-6}) = 192(10^{-6}) \quad \text{Ans}$$

$$\epsilon_2 = (20 - 171.77)(10^{-6}) = -152(10^{-6}) \quad \text{Ans}$$

b, c)

$$\gamma_{\max} = \gamma_{\max \text{ in-plane}} = 2R = 2(171.77)(10^{-6}) = 344(10^{-6}) \quad \text{Ans}$$

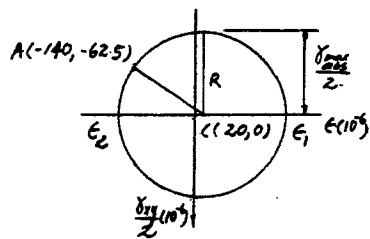

From *Mechanics of Materials*, Sixth Edition by R. C. Hibbeler, ISBN 0-13-191345-X.

© 2005 R. C. Hibbeler. Published by Pearson Prentice Hall,

Pearson Education, Inc., Upper Saddle River, NJ. All rights reserved.

This material is protected under all copyright laws as they currently exist. No portion of this material may be reproduced, in any form or by any means, without permission in writing from the publisher.

10-27 The steel bar is subjected to the tensile load of 500 lb. If it is 0.5 in. thick determine the absolute maximum shear strain. $E = 29(10^3)$ ksi, $\nu = 0.3$.

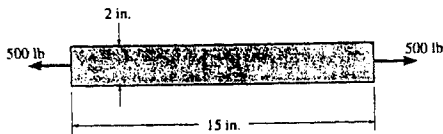

$$\sigma_x = \frac{500}{2(0.5)} = 500 \text{ psi} \quad \sigma_y = 0 \quad \sigma_z = 0$$

$$\epsilon_x = \frac{1}{E}(\sigma_x) = \frac{1}{29(10^6)}(500) = 17.2414(10^{-6})$$

$$\epsilon_y = \epsilon_z = -\nu\epsilon_x = -0.3(17.2414)(10^{-6}) = -5.1724(10^{-6})$$

$$\epsilon_1 = 17.2414(10^{-6}) \quad \epsilon_{2,3} = -5.1724(10^{-6})$$

$$\gamma_{\text{abs max}} = \epsilon_1 - \epsilon_2 = (17.2414 - (-5.1724))(10^{-6}) = 22.4(10^{-6}) \quad \text{Ans}$$

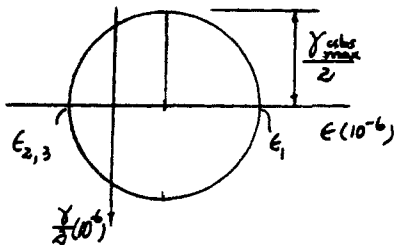

From *Mechanics of Materials*, Sixth Edition by R. C. Hibbeler, ISBN 0-13-191345-X.

© 2005 R. C. Hibbeler. Published by Pearson Prentice Hall,

Pearson Education, Inc., Upper Saddle River, NJ. All rights reserved.

This material is protected under all copyright laws as they currently exist. No portion of this material may be reproduced, in any form or by any means, without permission in writing from the publisher.

***10-28** The 45° strain rosette is mounted on a machine element. The following readings are obtained from each gauge: $\epsilon_a = 650(10^{-6})$, $\epsilon_b = -300(10^{-6})$, $\epsilon_c = 480(10^{-6})$. Determine (a) the in-plane principal strains and (b) the maximum in-plane shear strain and associated average normal strain. In each case show the deformed element due to these strains.

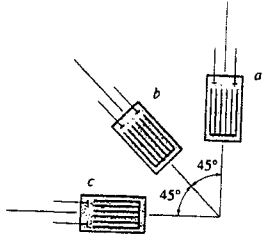

$$\begin{aligned} \epsilon_a &= 650(10^{-6}) & \epsilon_b &= -300(10^{-6}) & \epsilon_c &= 480(10^{-6}) \\ \theta_a &= 90^\circ & \theta_b &= 135^\circ & \theta_c &= 180^\circ \end{aligned}$$

$$\begin{aligned} \epsilon_a &= \epsilon_x \cos^2 \theta_a + \epsilon_y \sin^2 \theta_a + \gamma_{xy} \sin \theta_a \cos \theta_a \\ 650(10^{-6}) &= \epsilon_x \cos^2 90^\circ + \epsilon_y \sin^2 90^\circ + \gamma_{xy} \sin 90^\circ \cos 90^\circ \\ \epsilon_y &= 650(10^{-6}) \\ \epsilon_c &= \epsilon_x \cos^2 \theta_c + \epsilon_y \sin^2 \theta_c + \gamma_{xy} \sin \theta_c \cos \theta_c \\ 480(10^{-6}) &= \epsilon_x \cos^2 180^\circ + \epsilon_y \sin^2 180^\circ + \gamma_{xy} \sin 180^\circ \cos 180^\circ \\ \epsilon_x &= 480(10^{-6}) \\ \epsilon_b &= \epsilon_x \cos^2 \theta_b + \epsilon_y \sin^2 \theta_b + \gamma_{xy} \sin \theta_b \cos \theta_b \\ -300(10^{-6}) &= 480(10^{-6}) \cos^2 135^\circ + 650(10^{-6}) \sin^2 135^\circ + \gamma_{xy} \sin 135^\circ \cos 135^\circ \\ \gamma_{xy} &= 1730(10^{-6}) \end{aligned}$$

$$\frac{\gamma_{xy}}{2} = 865(10^{-6})$$

$$A(480, 865)10^{-6} \quad C(565, 0)10^{-6}$$

$$R = [\sqrt{(565 - 480)^2 + 865^2}]10^{-6} = 869.17(10^{-6})$$

a)

$$\begin{aligned} \epsilon_1 &= (565 + 869.17)10^{-6} = 1434(10^{-6}) \quad \text{Ans} \\ \epsilon_2 &= (565 - 869.17)10^{-6} = -304(10^{-6}) \quad \text{Ans} \end{aligned}$$

$$\begin{aligned} \tan 2\theta_p &= \frac{865}{565 - 480} \\ 2\theta_p &= 84.39^\circ \quad (\text{Mohr's circle}) \\ \theta_p &= 42.19^\circ \quad (\text{element}) \end{aligned}$$

b)

$$\begin{aligned} \gamma_{\max} &= 2R = 2(869.17)(10^{-6}) = 1738(10^{-6}) \quad \text{Ans} \\ \epsilon_{\text{avg}} &= 565(10^{-6}) \quad \text{Ans} \\ 2\theta_s &= 90^\circ - 2\theta_p = 5.61^\circ \quad (\text{Mohr's circle}) \\ \theta_s &= 2.81^\circ \quad (\text{element}) \end{aligned}$$

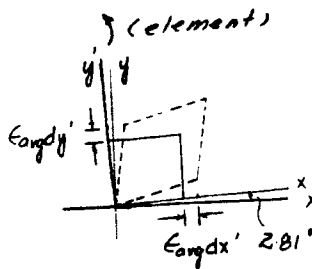
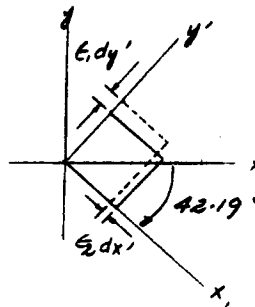
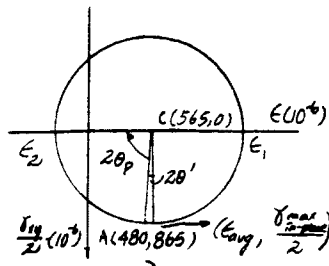

From *Mechanics of Materials*, Sixth Edition by R. C. Hibbeler, ISBN 0-13-191345-X.

© 2005 R. C. Hibbeler. Published by Pearson Prentice Hall,

Pearson Education, Inc., Upper Saddle River, NJ. All rights reserved.

This material is protected under all copyright laws as they currently exist. No portion of this material may be reproduced, in any form or by any means, without permission in writing from the publisher.

10-29. The 45° strain rosette is mounted on the link of the backhoe. The following readings are obtained from each gauge: $\epsilon_a = 650(10^{-6})$, $\epsilon_b = -300(10^{-6})$, $\epsilon_c = 480(10^{-6})$. Determine (a) the in-plane principal strains and (b) the maximum in-plane shear strain and associated average normal strain.

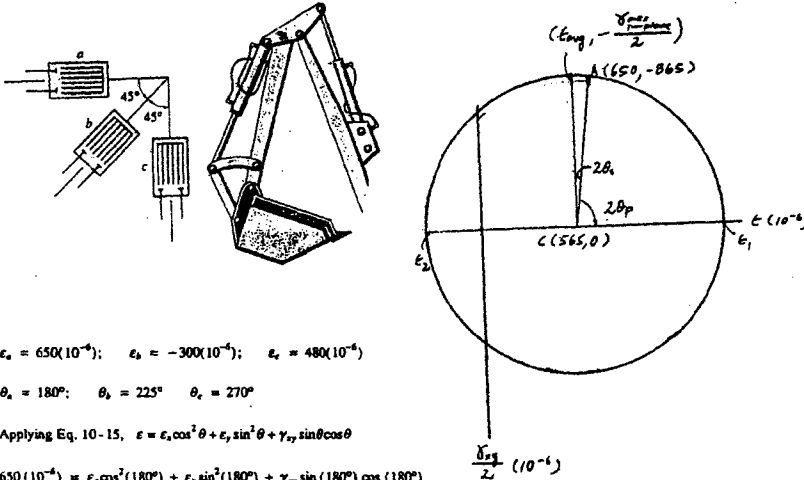

$$\epsilon_a = 650(10^{-6}); \quad \epsilon_b = -300(10^{-6}); \quad \epsilon_c = 480(10^{-6})$$

$$\theta_a = 180^\circ; \quad \theta_b = 225^\circ; \quad \theta_c = 270^\circ$$

Applying Eq. 10-15, $\epsilon = \epsilon_x \cos^2 \theta + \epsilon_y \sin^2 \theta + \gamma_{xy} \sin \theta \cos \theta$

$$650(10^{-6}) = \epsilon_x \cos^2(180^\circ) + \epsilon_y \sin^2(180^\circ) + \gamma_{xy} \sin(180^\circ) \cos(180^\circ)$$

$$\epsilon_x = 650(10^{-6})$$

$$480(10^{-6}) = \epsilon_x \cos^2(270^\circ) + \epsilon_y \sin^2(270^\circ) + \gamma_{xy} \sin(270^\circ) \cos(270^\circ)$$

$$\epsilon_y = 480(10^{-6})$$

$$-300(10^{-6}) = 650(10^{-6}) \cos^2(225^\circ) + 480(10^{-6}) \sin^2(225^\circ) + \gamma_{xy} \sin(225^\circ) \cos(225^\circ)$$

$$\gamma_{xy} = -1730(10^{-6})$$

Therefore, $\epsilon_x = 650(10^{-6})$, $\epsilon_y = 480(10^{-6})$, $\gamma_{xy} = -1730(10^{-6})$

$$\frac{\gamma_{xy}}{2} = -865(10^{-6})$$

Mohr's circle:

$$A(650, -865)10^{-6} \quad C(565, 0)10^{-6}$$

$$R = CA = \sqrt{(650 - 565)^2 + 865^2}10^{-6} = 869.17(10^{-6})$$

$$a) \quad \epsilon_1 = [565 + 869.17]10^{-6} = 1434(10^{-6}) \quad \text{Ans}$$

$$\epsilon_2 = [565 - 869.17]10^{-6} = -304(10^{-6}) \quad \text{Ans}$$

$$b) \quad \frac{\gamma_{max}}{2} = 2R = 2(869.17)(10^{-6}) = 1738(10^{-6}) \quad \text{Ans}$$

$$\epsilon_{avg} = 565(10^{-6}) \quad \text{Ans}$$

From *Mechanics of Materials*, Sixth Edition by R. C. Hibbeler, ISBN 0-13-191345-X.

© 2005 R. C. Hibbeler. Published by Pearson Prentice Hall,

Pearson Education, Inc., Upper Saddle River, NJ. All rights reserved.

This material is protected under all copyright laws as they currently exist. No portion of this material may be reproduced, in any form or by any means, without permission in writing from the publisher.

10-30 The 60° strain rosette is mounted on a beam. The following readings are obtained from each gauge: $\epsilon_a = 250(10^{-6})$, $\epsilon_b = -400(10^{-6})$, $\epsilon_c = 280(10^{-6})$. Determine (a) the in-plane principal strains and their orientation, and (b) the maximum in-plane shear strain and average normal strain. In each case show the deformed element due to these strains.

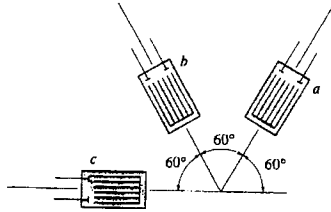

$$\begin{aligned} \epsilon_a &= 250(10^{-6}) & \epsilon_b &= -400(10^{-6}) & \epsilon_c &= 280(10^{-6}) \\ \theta_a &= 60^\circ & \theta_b &= 120^\circ & \theta_c &= 180^\circ \end{aligned}$$

$$\begin{aligned} \epsilon_a &= \epsilon_x \cos^2 \theta_a + \epsilon_y \sin^2 \theta_a + \gamma_{xy} \sin \theta_a \cos \theta_a \\ 280(10^{-6}) &= \epsilon_x \cos^2 180^\circ + \epsilon_y \sin^2 180^\circ + \gamma_{xy} \sin 180^\circ \cos 180^\circ \\ \epsilon_x &= 280(10^{-6}) \end{aligned}$$

$$\begin{aligned} \epsilon_c &= \epsilon_x \cos^2 \theta_c + \epsilon_y \sin^2 \theta_c + \gamma_{xy} \sin \theta_c \cos \theta_c \\ 250(10^{-6}) &= \epsilon_x \cos^2 60^\circ + \epsilon_y \sin^2 60^\circ + \gamma_{xy} \sin 60^\circ \cos 60^\circ \\ 250(10^{-6}) &= 0.25\epsilon_x + 0.75\epsilon_y + 0.433\gamma_{xy} \quad (1) \end{aligned}$$

$$\begin{aligned} \epsilon_b &= \epsilon_x \cos^2 \theta_b + \epsilon_y \sin^2 \theta_b + \gamma_{xy} \sin \theta_b \cos \theta_b \\ -400(10^{-6}) &= \epsilon_x \cos^2 120^\circ + \epsilon_y \sin^2 120^\circ + \gamma_{xy} \sin 120^\circ \cos 120^\circ \\ -400(10^{-6}) &= 0.25\epsilon_x + 0.75\epsilon_y - 0.433\gamma_{xy} \quad (2) \end{aligned}$$

Subtract Eq. (2) from Eq. (1)

$$650(10^{-6}) = 0.866\gamma_{xy}$$

$$\gamma_{xy} = 750.56(10^{-6})$$

$$\epsilon_y = -193.33(10^{-6})$$

$$\frac{\gamma_{xy}}{2} = 375.28(10^{-6})$$

$$A(280, 375.28)10^{-6} \quad C(43.34, 0)10^{-6}$$

$$R = [\sqrt{(280 - 43.34)^2 + 375.28^2}]10^{-6} = 443.67(10^{-6})$$

a)

$$\epsilon_1 = (43.34 + 443.67)10^{-6} = 487(10^{-6}) \quad \text{Ans}$$

$$\epsilon_2 = (43.34 - 443.67)10^{-6} = -400(10^{-6}) \quad \text{Ans}$$

$$\tan 2\theta_p = \frac{375.28}{280 - 43.34}$$

$$2\theta_p = 57.76^\circ \quad (\text{Mohr's circle})$$

$$\theta_p = 28.89^\circ \quad (\text{element})$$

b)

$$\gamma_{\max, \text{in-plane}} = 2R = 2(443.67)(10^{-6}) = 887(10^{-6}) \quad \text{Ans}$$

$$\epsilon_{\text{avg}} = 43.3(10^{-6}) \quad \text{Ans}$$

$$2\theta_s = 90^\circ - 2\theta_p = 32.24^\circ \quad (\text{Mohr's circle})$$

$$\theta_s = 16.12^\circ \quad (\text{element})$$

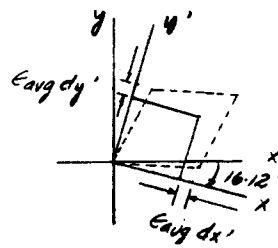
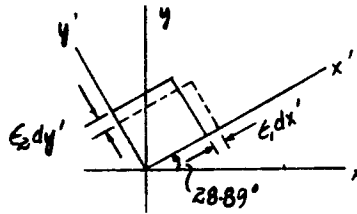
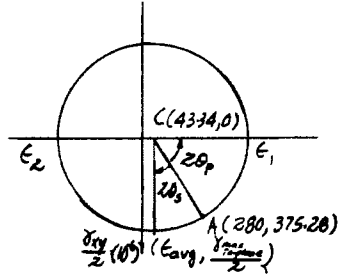

From *Mechanics of Materials*, Sixth Edition by R. C. Hibbeler, ISBN 0-13-191345-X.

© 2005 R. C. Hibbeler. Published by Pearson Prentice Hall,

Pearson Education, Inc., Upper Saddle River, NJ. All rights reserved.

This material is protected under all copyright laws as they currently exist. No portion of this material may be reproduced, in any form or by any means, without permission in writing from the publisher.

10-31. The 60° strain rosette is mounted on the surface of an aluminum plate. The following readings are obtained from each gauge: $\epsilon_a = 950(10^{-6})$, $\epsilon_b = 380(10^{-6})$, $\epsilon_c = -220(10^{-6})$. Determine the in-plane principal strains and their orientation.

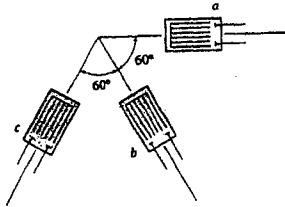

$$\begin{aligned} \epsilon_a &= 950(10^{-6}) & \epsilon_b &= 380(10^{-6}) & \epsilon_c &= -220(10^{-6}) \\ \theta_a &= 0^\circ & \theta_b &= -60^\circ & \theta_c &= -120^\circ \end{aligned}$$

$$\begin{aligned} \epsilon_a &= \epsilon_x \cos^2 \theta_a + \epsilon_y \sin^2 \theta_a + \gamma_{xy} \sin \theta_a \cos \theta_a \\ 950(10^{-6}) &= \epsilon_x \cos^2 0^\circ + \epsilon_y \sin^2 0^\circ + \gamma_{xy} \sin 0^\circ \cos 0^\circ \\ \epsilon_x &= 950(10^{-6}) \end{aligned}$$

$$\begin{aligned} \epsilon_b &= \epsilon_x \cos^2 \theta_b + \epsilon_y \sin^2 \theta_b + \gamma_{xy} \sin \theta_b \cos \theta_b \\ 380(10^{-6}) &= \epsilon_x \cos^2 (-60^\circ) + \epsilon_y \sin^2 (-60^\circ) + \gamma_{xy} \sin (-60^\circ) \cos (-60^\circ) \\ 380(10^{-6}) &= 0.25\epsilon_x + 0.75\epsilon_y - 0.433\gamma_{xy} \quad (1) \end{aligned}$$

$$\begin{aligned} \epsilon_c &= \epsilon_x \cos^2 \theta_c + \epsilon_y \sin^2 \theta_c + \gamma_{xy} \sin \theta_c \cos \theta_c \\ -220(10^{-6}) &= \epsilon_x \cos^2 (-120^\circ) + \epsilon_y \sin^2 (-120^\circ) + \gamma_{xy} \sin (-120^\circ) \cos (-120^\circ) \\ -220(10^{-6}) &= 0.25\epsilon_x + 0.75\epsilon_y + 0.433\gamma_{xy} \quad (2) \end{aligned}$$

Subtract Eq. (2) from Eq. (1)

$$600(10^{-6}) = -0.866\gamma_{xy}$$

$$\gamma_{xy} = -692.82(10^{-6})$$

$$\epsilon_y = -210(10^{-6})$$

$$\frac{\gamma_{xz}}{2} = -346.41(10^{-6})$$

$$\begin{aligned} A(950, -346.41)10^{-6} & \quad C(370, 0)10^{-6} \\ R &= \sqrt{(950 - 370)^2 + 346.41^2} 10^{-6} = 675.57(10^{-6}) \end{aligned}$$

$$\epsilon_1 = (370 + 675.57)10^{-6} = 1046(10^{-6}) \quad \text{Ans}$$

$$\epsilon_2 = (370 - 675.57)10^{-6} = -306(10^{-6}) \quad \text{Ans}$$

$$\tan 2\theta_p = \frac{346.41}{950 - 370}$$

$$2\theta_p = 30.8^\circ \quad (\text{Mohr's circle})$$

$$\theta_p = 15.4^\circ \quad (\text{element}) \quad \text{Ans}$$

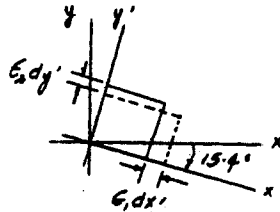
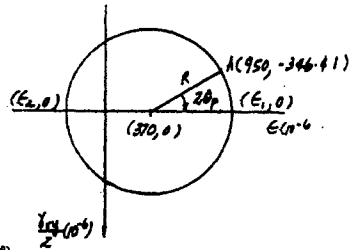

From *Mechanics of Materials*, Sixth Edition by R. C. Hibbeler, ISBN 0-13-191345-X.

© 2005 R. C. Hibbeler. Published by Pearson Prentice Hall,

Pearson Education, Inc., Upper Saddle River, NJ. All rights reserved.

This material is protected under all copyright laws as they currently exist. No portion of this material may be reproduced, in any form or by any means, without permission in writing from the publisher.

***10-32** The 45° strain rosette is mounted on a steel shaft. The following readings are obtained for each gauge: $\epsilon_a = 800(10^{-6})$, $\epsilon_b = 520(10^{-6})$, $\epsilon_c = -450(10^{-6})$. Determine the in-plane principal strains and their orientation.

$$\begin{aligned} \epsilon_a &= 800(10^{-6}) & \epsilon_b &= 520(10^{-6}) & \epsilon_c &= -450(10^{-6}) \\ \theta_a &= -45^\circ & \theta_b &= 0^\circ & \theta_c &= 45^\circ \end{aligned}$$

$$\epsilon_b = \epsilon_x \cos^2 \theta_b + \epsilon_y \sin^2 \theta_b + \gamma_{xy} \sin \theta_b \cos \theta_b$$

$$520(10^{-6}) = \epsilon_x \cos^2 0^\circ + \epsilon_y \sin^2 0^\circ + \gamma_{xy} \sin 0^\circ \cos 0^\circ$$

$$\epsilon_x = 520(10^{-6})$$

$$\epsilon_a = \epsilon_x \cos^2 \theta_a + \epsilon_y \sin^2 \theta_a + \gamma_{xy} \sin \theta_a \cos \theta_a$$

$$800(10^{-6}) = \epsilon_x \cos^2 (-45^\circ) + \epsilon_y \sin^2 (-45^\circ) + \gamma_{xy} \sin (-45^\circ) \cos (-45^\circ)$$

$$800(10^{-6}) = 0.5\epsilon_x + 0.5\epsilon_y - 0.5\gamma_{xy} \quad (1)$$

$$\epsilon_c = \epsilon_x \cos^2 \theta_c + \epsilon_y \sin^2 \theta_c + \gamma_{xy} \sin \theta_c \cos \theta_c$$

$$-450(10^{-6}) = \epsilon_x \cos^2 45^\circ + \epsilon_y \sin^2 45^\circ + \gamma_{xy} \sin 45^\circ \cos 45^\circ$$

$$-450(10^{-6}) = 0.5\epsilon_x + 0.5\epsilon_y + 0.5\gamma_{xy} \quad (2)$$

Subtract Eq. (2) from Eq. (1)

$$1250(10^{-6}) = -\gamma_{xy}$$

$$\gamma_{xy} = -1250(10^{-6})$$

$$\epsilon_y = -170(10^{-6})$$

$$\frac{\gamma_{xy}}{2} = -625(10^{-6})$$

$$A(520, -625)10^{-6} \quad C(175, 0)10^{-6}$$

$$R = [\sqrt{(520 - 175)^2 + 625^2}]10^{-6} = 713.90(10^{-6})$$

$$\epsilon_1 = (175 + 713.9)10^{-6} = 889(10^{-6}) \quad \text{Ans}$$

$$\epsilon_2 = (175 - 713.9)10^{-6} = -539(10^{-6}) \quad \text{Ans}$$

$$\tan 2\theta_p = \frac{625}{520 - 175}$$

$$2\theta_p = 61.1^\circ \quad (\text{Mohr's circle})$$

$$\theta_p = 30.6^\circ \quad (\text{element}) \quad \text{Ans}$$

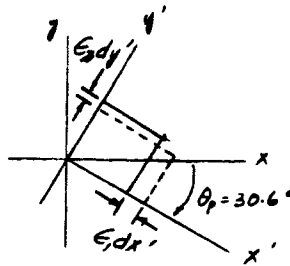
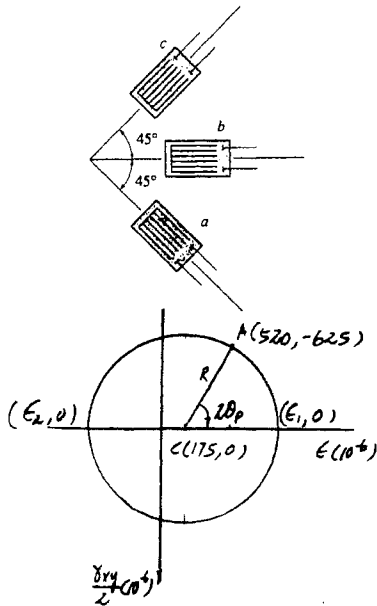

From *Mechanics of Materials*, Sixth Edition by R. C. Hibbeler, ISBN 0-13-191345-X.

© 2005 R. C. Hibbeler. Published by Pearson Prentice Hall,

Pearson Education, Inc., Upper Saddle River, NJ. All rights reserved.

This material is protected under all copyright laws as they currently exist. No portion of this material may be reproduced, in any form or by any means, without permission in writing from the publisher.

Because of the number and variety of potential correct solutions to this problem, no solution is being given.

From *Mechanics of Materials*, Sixth Edition by R. C. Hibbeler, ISBN 0-13-191345-X.

© 2005 R. C. Hibbeler. Published by Pearson Prentice Hall,

Pearson Education, Inc, Upper Saddle River, NJ. All rights reserved.

This material is protected under all copyright laws as they currently exist. No portion of this material may be reproduced, in any form or by any means, without permission in writing from the publisher.

10-34. For the case of plane stress, show that Hooke's law can be written as

$$\sigma_x = \frac{E}{(1-\nu^2)}(\epsilon_x + \nu\epsilon_y), \quad \sigma_y = \frac{E}{(1-\nu^2)}(\epsilon_y + \nu\epsilon_x)$$

Generalized Hooke's Law : For plane stress, $\sigma_z = 0$.

Applying Eq. 10-18,

$$\begin{aligned} \epsilon_x &= \frac{1}{E}(\sigma_x - \nu\sigma_y) \\ \nu E\epsilon_x &= (\sigma_x - \nu\sigma_y)\nu \\ \nu E\epsilon_x &= \nu\sigma_x - \nu^2\sigma_y \end{aligned} \quad [1]$$

$$\begin{aligned} \epsilon_y &= \frac{1}{E}(\sigma_y - \nu\sigma_x) \\ E\epsilon_y &= -\nu\sigma_x + \sigma_y \end{aligned} \quad [2]$$

Substituting σ_y into Eq. [2]

Adding Eq. [1] and Eq. [2] yields,

$$\begin{aligned} \nu E\epsilon_x + E\epsilon_y &= \sigma_y - \nu^2\sigma_y \\ \sigma_y &= \frac{E}{1-\nu^2}(\nu\epsilon_x + \epsilon_y) \quad (Q.E.D.) \end{aligned}$$

$$\begin{aligned} E\epsilon_y &= -\nu\sigma_x + \frac{E}{1-\nu^2}(\nu\epsilon_x + \epsilon_y) \\ \sigma_x &= \frac{E(\nu\epsilon_x + \epsilon_y)}{\nu(1-\nu^2)} - \frac{E\epsilon_y}{\nu} \\ &= \frac{E\nu\epsilon_x + E\epsilon_y - E\epsilon_y + E\epsilon_y\nu^2}{\nu(1-\nu^2)} \\ &= \frac{E}{1-\nu^2}(\epsilon_x + \nu\epsilon_y) \quad (Q.E.D.) \end{aligned}$$

From *Mechanics of Materials*, Sixth Edition by R. C. Hibbeler, ISBN 0-13-191345-X.

© 2005 R. C. Hibbeler. Published by Pearson Prentice Hall,

Pearson Education, Inc., Upper Saddle River, NJ. All rights reserved.

This material is protected under all copyright laws as they currently exist. No portion of this material may be reproduced, in any form or by any means, without permission in writing from the publisher.

10-35 Use Hooke's law, Eq. 10-18, to develop the strain-transformation equations, Eqs. 10-5 and 10-6, from the stress-transformation equations, Eqs. 9-1 and 9-2.

Stress transformation equations :

$$\sigma_{x'} = \frac{\sigma_x + \sigma_y}{2} + \frac{\sigma_x - \sigma_y}{2} \cos 2\theta + \tau_{xy} \sin 2\theta \quad (1)$$

$$\tau_{x'y'} = \frac{\sigma_x - \sigma_y}{2} \sin 2\theta + \tau_{xy} \cos 2\theta \quad (2)$$

$$\sigma_{y'} = \frac{\sigma_x + \sigma_y}{2} - \frac{\sigma_x - \sigma_y}{2} \cos 2\theta - \tau_{xy} \sin 2\theta \quad (3)$$

Hooke's law :

$$\epsilon_x = \frac{\sigma_x}{E} - \nu \frac{\sigma_y}{E} \quad (4)$$

$$\epsilon_y = -\nu \frac{\sigma_x}{E} + \frac{\sigma_y}{E} \quad (5)$$

$$\tau_{xy} = G \gamma_{xy} \quad (6)$$

$$G = \frac{E}{2(1+\nu)} \quad (7)$$

From Eqs. (4) and (5)

$$\epsilon_x + \epsilon_y = \frac{(1-\nu)(\sigma_x + \sigma_y)}{E} \quad (8)$$

$$\epsilon_x - \epsilon_y = \frac{(1+\nu)(\sigma_x - \sigma_y)}{E} \quad (9)$$

From Eqs. (6) and (7)

$$\tau_{xy} = \frac{E}{2(1+\nu)} \gamma_{xy} \quad (10)$$

From Eq. (4)

$$\epsilon_x = \frac{\sigma_x}{E} - \nu \frac{\sigma_y}{E} \quad (11)$$

Substitute Eqs. (1) and (3) into Eq. (11)

$$\epsilon_x = \frac{(1-\nu)(\sigma_x + \sigma_y)}{2E} + \frac{(1+\nu)(\sigma_x - \sigma_y)}{2E} \cos 2\theta + \frac{(1+\nu)\tau_{xy} \sin 2\theta}{E} \quad (12)$$

By using Eqs. (8), (9) and (10) and substitute into Eq. (12),

$$\epsilon_x = \frac{\epsilon_x + \epsilon_y}{2} + \frac{\epsilon_x - \epsilon_y}{2} \cos 2\theta + \frac{\gamma_{xy}}{2} \sin 2\theta \quad \text{QED}$$

From Eq. (6),

$$\tau_{x'y'} = G \gamma_{x'y'} = \frac{E}{2(1+\nu)} \gamma_{x'y'} \quad (13)$$

Substitute Eqs. (13), (6) and (9) into Eq.(2),

$$\frac{E}{2(1+\nu)} \gamma_{x'y'} = -\frac{E(\epsilon_x - \epsilon_y)}{2(1+\nu)} \sin 2\theta + \frac{E}{2(1+\nu)} \gamma_{xy} \cos 2\theta$$

$$\frac{\gamma_{x'y'}}{2} = -\frac{(\epsilon_x - \epsilon_y)}{2} \sin 2\theta + \frac{\gamma_{xy}}{2} \cos 2\theta \quad \text{QED}$$

From *Mechanics of Materials*, Sixth Edition by R. C. Hibbeler, ISBN 0-13-191345-X.

© 2005 R. C. Hibbeler. Published by Pearson Prentice Hall,

Pearson Education, Inc., Upper Saddle River, NJ. All rights reserved.

This material is protected under all copyright laws as they currently exist. No portion of this material may be reproduced, in any form or by any means, without permission in writing from the publisher.

***10-36** A bar of copper alloy is loaded in a tension machine and it is determined that $\epsilon_x = 940(10^{-6})$ and $\sigma_x = 14$ ksi, $\sigma_y = 0$, $\sigma_z = 0$. Determine the modulus of elasticity, E_{cu} , and the dilatation, e_{cu} , of the copper. $\nu_{cu} = 0.35$.

$$\epsilon_x = \frac{1}{E}[\sigma_x - \nu(\sigma_y + \sigma_z)]$$

$$940(10^{-6}) = \frac{1}{E_{cu}}[14(10^3) - 0.35(0 + 0)]$$

$$E_{cu} = 14.9(10^3) \text{ ksi} \quad \text{Ans}$$

$$e_{cu} = \frac{1-2\nu}{E}(\sigma_x + \sigma_y + \sigma_z) = \frac{1-2(0.35)}{14.9(10^3)}(14 + 0 + 0) = 0.282(10^{-3}) \quad \text{Ans}$$

From *Mechanics of Materials*, Sixth Edition by R. C. Hibbeler, ISBN 0-13-191345-X.

© 2005 R. C. Hibbeler. Published by Pearson Prentice Hall,

Pearson Education, Inc., Upper Saddle River, NJ. All rights reserved.

This material is protected under all copyright laws as they currently exist. No portion of this material may be reproduced, in any form or by any means, without permission in writing from the publisher.

10-37 The principal plane stresses and associated strains in a plane at a point are $\sigma_1 = 36$ ksi, $\sigma_2 = 16$ ksi, $\epsilon_1 = 1.02(10^{-3})$, $\epsilon_2 = 0.180(10^{-3})$. Determine the modulus of elasticity and Poisson's ratio.

$$\sigma_3 = 0$$

$$\epsilon_1 = \frac{1}{E}[\sigma_1 - \nu(\sigma_2 + \sigma_3)]$$

$$1.02(10^{-3}) = \frac{1}{E}[36 - \nu(16)]$$

$$1.02(10^{-3})E = 36 - 16\nu \quad (1)$$

$$\epsilon_2 = \frac{1}{E}[\sigma_2 - \nu(\sigma_1 + \sigma_3)]$$

$$0.180(10^{-3}) = \frac{1}{E}[16 - \nu(36)]$$

$$0.180(10^{-3})E = 16 - 36\nu \quad (2)$$

Solving Eqs. (1) and (2) yields :

$$E = 30.7(10^3) \text{ ksi} \quad \mathbf{Ans}$$

$$\nu = 0.291 \quad \mathbf{Ans}$$

From *Mechanics of Materials*, Sixth Edition by R. C. Hibbeler, ISBN 0-13-191345-X.

© 2005 R. C. Hibbeler. Published by Pearson Prentice Hall,

Pearson Education, Inc., Upper Saddle River, NJ. All rights reserved.

This material is protected under all copyright laws as they currently exist. No portion of this material may be reproduced, in any form or by any means, without permission in writing from the publisher.

10-38 Determine the bulk modulus for each of the following materials: (a) rubber, $E_r = 0.4$ ksi, $\nu_r = 0.48$, and (b) glass, $E_g = 8(10^3)$ ksi, $\nu_g = 0.24$.

a) For rubber :

$$K_r = \frac{E_r}{3(1 - 2\nu_r)} = \frac{0.4}{3[1 - 2(0.48)]} = 3.33 \text{ ksi} \quad \text{Ans}$$

b) For glass :

$$K_g = \frac{E_g}{3(1 - 2\nu_g)} = \frac{8(10^3)}{3[1 - 2(0.24)]} = 5.13 (10^3) \text{ ksi} \quad \text{Ans}$$

From *Mechanics of Materials*, Sixth Edition by R. C. Hibbeler, ISBN 0-13-191345-X.

© 2005 R. C. Hibbeler. Published by Pearson Prentice Hall,

Pearson Education, Inc., Upper Saddle River, NJ. All rights reserved.

This material is protected under all copyright laws as they currently exist. No portion of this material may be reproduced, in any form or by any means, without permission in writing from the publisher.

10-39 The principal strains at a point on the aluminum fuselage of a jet aircraft are $\epsilon_1 = 780(10^{-6})$ and $\epsilon_2 = 400(10^{-6})$. Determine the associated principal stresses at the point in the same plane. $E_{al} = 10(10^3)$ ksi, $\nu_{al} = 0.33$. *Hint:* See Prob. 10-34.

Plane stress, $\sigma_3 = 0$

Use the formula developed in Prob. 10-34.

$$\begin{aligned}\sigma_1 &= \frac{E}{1-\nu^2}(\epsilon_1 + \nu\epsilon_2) \\ &= \frac{10(10^3)}{1-0.33^2}(780(10^{-6}) + 0.33(400)(10^{-6})) = 10.2 \text{ ksi} \quad \mathbf{Ans} \\ \sigma_2 &= \frac{E}{1-\nu^2}(\epsilon_2 + \nu\epsilon_1) \\ &= \frac{10(10^3)}{1-0.33^2}(400(10^{-6}) + 0.33(780)(10^{-6})) = 7.38 \text{ ksi} \quad \mathbf{Ans}\end{aligned}$$

From *Mechanics of Materials*, Sixth Edition by R. C. Hibbeler, ISBN 0-13-191345-X.

© 2005 R. C. Hibbeler. Published by Pearson Prentice Hall,

Pearson Education, Inc., Upper Saddle River, NJ. All rights reserved.

This material is protected under all copyright laws as they currently exist. No portion of this material may be reproduced, in any form or by any means, without permission in writing from the publisher.

*10-40 The polyvinyl chloride bar is subjected to an axial force of 900 lb. If it has the original dimensions shown, determine the *change* in the angle θ after the load is applied. $E_{pvc} = 800(10^3)$ psi, $\nu_{pvc} = 0.20$.

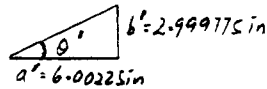
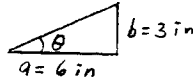
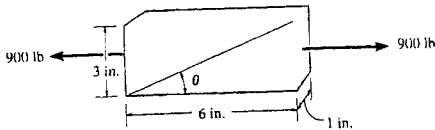

$$\sigma_x = \frac{900}{3(1)} = 300 \text{ psi}$$

$$\sigma_y = 0 \quad \sigma_z = 0$$

$$\begin{aligned} \epsilon_x &= \frac{1}{E} [\sigma_x - \nu(\sigma_y + \sigma_z)] \\ &= \frac{1}{800(10^3)} [300 - 0] = 0.375(10^{-3}) \end{aligned}$$

$$\begin{aligned} \epsilon_y &= \frac{1}{E} [\sigma_y - \nu(\sigma_x + \sigma_z)] \\ &= \frac{1}{800(10^3)} [0 - 0.2(300 + 0)] = -75(10^{-6}) \end{aligned}$$

$$a' = 6 + 6(0.375)(10^{-3}) = 6.00225 \text{ in.}$$

$$b' = 3 + 3(-75)(10^{-6}) = 2.999775 \text{ in.}$$

$$\theta = \tan^{-1}\left(\frac{3}{6}\right) = 26.56505118^\circ$$

$$\theta' = \tan^{-1}\left(\frac{2.999775}{6.00225}\right) = 26.55474088^\circ$$

$$\Delta\theta = \theta - \theta' = 26.56505118^\circ - 26.55474088^\circ = 0.0103^\circ \quad \text{Ans}$$

From *Mechanics of Materials*, Sixth Edition by R. C. Hibbeler, ISBN 0-13-191345-X.

© 2005 R. C. Hibbeler. Published by Pearson Prentice Hall,

Pearson Education, Inc., Upper Saddle River, NJ. All rights reserved.

This material is protected under all copyright laws as they currently exist. No portion of this material may be reproduced, in any form or by any means, without permission in writing from the publisher.

10-41. The polyvinyl chloride bar is subjected to an axial force of 900 lb. If it has the original dimensions shown, determine the value of Poisson's ratio if the angle θ decreases by $\Delta\theta = 0.01^\circ$ after the load is applied. $E_{pvc} = 800(10^3)$ psi.

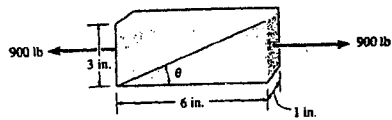

$$\sigma_x = \frac{900}{3(1)} = 300 \text{ psi} \quad \sigma_y = 0 \quad \sigma_z = 0$$

$$\begin{aligned} \epsilon_x &= \frac{1}{E} [\sigma_x - \nu_{pvc} (\sigma_y + \sigma_z)] \\ &= \frac{1}{800(10^3)} [300 - 0] = 0.375 (10^{-3}) \end{aligned}$$

$$\begin{aligned} \epsilon_y &= \frac{1}{E} [\sigma_y - \nu_{pvc} (\sigma_x + \sigma_z)] \\ &= \frac{1}{800(10^3)} [0 - \nu_{pvc} (300 + 0)] = -0.375 (10^{-3}) \nu_{pvc} \end{aligned}$$

$$a' = 6 + 6(0.375)(10^{-3}) = 6.00225 \text{ in.}$$

$$b' = 3 + 3(-0.375)(10^{-3}) \nu_{pvc} = 3 - 1.125(10^{-3}) \nu_{pvc}$$

$$\theta = \tan^{-1}\left(\frac{3}{6}\right) = 26.56505118^\circ$$

$$\theta' = 26.56505118^\circ - 0.01^\circ = 26.55505118^\circ$$

$$\tan \theta' = 0.49978185 = \frac{3 - 1.125(10^{-3}) \nu_{pvc}}{6.00225}$$

$$\nu_{pvc} = 0.464 \quad \text{Ans}$$

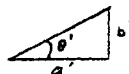
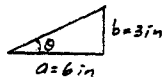

From *Mechanics of Materials*, Sixth Edition by R. C. Hibbeler, ISBN 0-13-191345-X.

© 2005 R. C. Hibbeler. Published by Pearson Prentice Hall,

Pearson Education, Inc., Upper Saddle River, NJ. All rights reserved.

This material is protected under all copyright laws as they currently exist. No portion of this material may be reproduced, in any form or by any means, without permission in writing from the publisher.

10-42 A rod has a radius of 10 mm. If it is subjected to an axial load of 15 N such that the axial strain in the rod is $\epsilon_x = 2.75(10^{-6})$, determine the modulus of elasticity E and the change in its diameter, $\nu = 0.23$.

$$\sigma_x = \frac{15}{\pi (0.01)^2} = 47.746 \text{ kPa}, \quad \sigma_y = 0, \quad \sigma_z = 0$$

$$\epsilon_x = \frac{1}{E} [\sigma_x - \nu(\sigma_y + \sigma_z)]$$

$$2.75(10^{-6}) = \frac{1}{E} [47.746(10^3) - 0.23(0 + 0)]$$

$$E = 17.4 \text{ GPa} \qquad \text{Ans}$$

$$\epsilon_y = \epsilon_z = -\nu\epsilon_x = -0.23(2.75)(10^{-6}) = -0.632(10^{-6})$$

$$\Delta d = 20(-0.632(10^{-6})) = -12.6(10^{-6}) \text{ mm} \qquad \text{Ans}$$

From *Mechanics of Materials*, Sixth Edition by R. C. Hibbeler, ISBN 0-13-191345-X.

© 2005 R. C. Hibbeler. Published by Pearson Prentice Hall,

Pearson Education, Inc., Upper Saddle River, NJ. All rights reserved.

This material is protected under all copyright laws as they currently exist. No portion of this material may be reproduced, in any form or by any means, without permission in writing from the publisher.

10-43 The principal strains at a point on the aluminum surface of a tank are $\epsilon_1 = 630(10^{-6})$ and $\epsilon_2 = 350(10^{-6})$. If this is a case of plane stress, determine the associated principal stresses at the point in the same plane. $E_{al} = 10(10^3)$ ksi, $\nu_{al} = 0.33$. *Hint:* See Prob. 10-34.

For plane stress $\sigma_3 = 0$.

Use the formula developed in Prob. 10 - 34.

$$\begin{aligned}\sigma_1 &= \frac{E}{1 - \nu^2}(\epsilon_1 + \nu\epsilon_2) \\ &= \frac{10(10^3)}{1 - 0.33^2}[630(10^{-6}) + 0.33(350)(10^{-6})] \\ &= 8.37 \text{ ksi} \quad \text{Ans}\end{aligned}$$

$$\begin{aligned}\sigma_2 &= \frac{E}{1 - \nu^2}(\epsilon_2 + \nu\epsilon_1) \\ &= \frac{10(10^3)}{1 - 0.33^2}[350(10^{-6}) + 0.33(630)(10^{-6})] \\ &= 6.26 \text{ ksi} \quad \text{Ans}\end{aligned}$$

From *Mechanics of Materials*, Sixth Edition by R. C. Hibbeler, ISBN 0-13-191345-X.

© 2005 R. C. Hibbeler. Published by Pearson Prentice Hall,

Pearson Education, Inc., Upper Saddle River, NJ. All rights reserved.

This material is protected under all copyright laws as they currently exist. No portion of this material may be reproduced, in any form or by any means, without permission in writing from the publisher.

***10-44.** The strain gauge is placed on the surface of a thin-walled steel boiler as shown. If it is 0.5 in. long, determine the pressure in the boiler when the gauge elongates $0.2(10^{-3})$ in. The boiler has a thickness of 0.5 in. and inner diameter of 60 in. Also, determine the maximum x, y in-plane shear strain in the material.
 $E_{st} = 29(10^3)$ ksi, $\nu_{st} = 0.3$.

$$\epsilon_2 = \frac{0.2(10^{-3})}{0.5} = 400(10^{-6})$$

$$\epsilon_2 = \frac{1}{E}[\sigma_2 - \nu(\sigma_1 + \sigma_3)]$$

where, $\sigma_2 = \frac{1}{2}\sigma_1$ $\sigma_3 = 0$

$$400(10^{-6}) = \frac{1}{29(10^3)} \left[\frac{1}{2}\sigma_1 - 0.3\sigma_1 \right]$$

$$\sigma_1 = 58 \text{ ksi}$$

Thus,

$$p = \frac{\sigma_1 t}{r} = \frac{58(0.5)}{30} = 0.967 \text{ ksi} \quad \text{Ans}$$

$$\epsilon_1 = \frac{1}{E}[\sigma_1 - \nu(\sigma_2 + \sigma_3)]$$

where, $\sigma_3 = 0$ and $\sigma_2 = \frac{58}{2} = 29 \text{ ksi}$

$$\epsilon_1 = \frac{1}{29(10^3)} [58 - 0.3(29 + 0)] = 1700(10^{-6})$$

$$\frac{\gamma_{\max}^{\text{in-plane}}}{2} = \frac{\epsilon_1 - \epsilon_2}{2}$$

$$\gamma_{\max}^{\text{in-plane}} = (1700 - 400)(10^{-6}) = 1.30(10^{-3}) \quad \text{Ans}$$

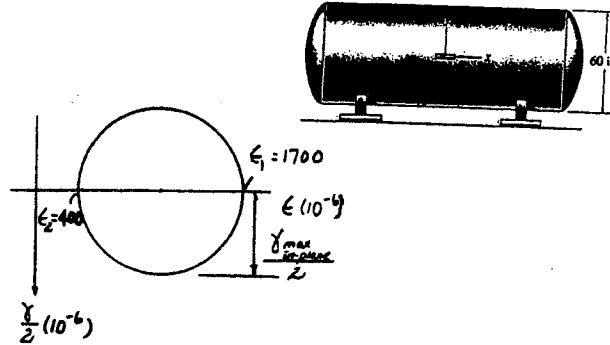

From *Mechanics of Materials*, Sixth Edition by R. C. Hibbeler, ISBN 0-13-191345-X.

© 2005 R. C. Hibbeler. Published by Pearson Prentice Hall,

Pearson Education, Inc., Upper Saddle River, NJ. All rights reserved.

This material is protected under all copyright laws as they currently exist. No portion of this material may be reproduced, in any form or by any means, without permission in writing from the publisher.

10-45 The steel shaft has a radius of 15 mm. Determine the torque T in the shaft if the two strain gauges, attached to the surface of the shaft, report strains of $\epsilon_{x'} = -80(10^{-6})$ and $\epsilon_{y'} = 80(10^{-6})$. Also, compute the strains acting in the x and y directions. $E_{st} = 200$ GPa, $\nu_{st} = 0.3$.

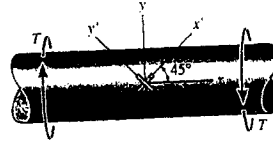

$$\epsilon_{x'} = -80(10^{-6}) \quad \epsilon_{y'} = 80(10^{-6})$$

Pure shear $\epsilon_x = \epsilon_y = 0$ **Ans**

$$\epsilon_{x'} = \epsilon_x \cos^2 \theta + \epsilon_y \sin^2 \theta + \gamma_{xy} \sin \theta \cos \theta$$

$$\theta = 45^\circ$$

$$-80(10^{-6}) = 0 + 0 + \gamma_{xy} \sin 45^\circ \cos 45^\circ$$

$$\gamma_{xy} = -160(10^{-6}) \quad \mathbf{Ans}$$

Also, $\theta = 135^\circ$

$$80(10^{-6}) = 0 + 0 + \gamma \sin 135^\circ \cos 135^\circ$$

$$\gamma_{xy} = -160(10^{-6})$$

$$G = \frac{E}{2(1 + \nu)} = \frac{200(10^9)}{2(1 + 0.3)} = 76.923(10^9)$$

$$\tau = G\gamma = 76.923(10^9)(160)(10^{-6}) = 12.308(10^6) \text{ Pa}$$

$$T = \frac{\tau J}{c} = \frac{12.308(10^6) \left(\frac{\pi}{2}\right) (0.015)^4}{0.015} = 65.2 \text{ N} \cdot \text{m} \quad \mathbf{Ans}$$

From *Mechanics of Materials*, Sixth Edition by R. C. Hibbeler, ISBN 0-13-191345-X.

© 2005 R. C. Hibbeler. Published by Pearson Prentice Hall,

Pearson Education, Inc., Upper Saddle River, NJ. All rights reserved.

This material is protected under all copyright laws as they currently exist. No portion of this material may be reproduced, in any form or by any means, without permission in writing from the publisher.

10-46. The shaft has a radius of 15 mm and is made of L2 tool steel. Determine the strains in the x' and y' directions if a torque $T = 2 \text{ kN} \cdot \text{m}$ is applied to the shaft.

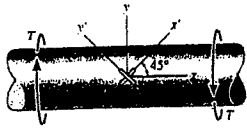

$$\tau = \frac{T c}{J} = \frac{2 (10^3) (0.015)}{\frac{\pi}{2} (0.015^4)} = 377.26 \text{ MPa}$$

Stress - strain relationship :

$$\gamma_{xy} = \frac{\tau_{xy}}{G} = \frac{377.26 (10^6)}{75.0 (10^9)} = 5.030(10^{-3}) \text{ rad}$$

This is a pure shear case, therefore,

$$\varepsilon_x = \varepsilon_y = 0$$

Applying Eq. 10-15,

$$\varepsilon_{x'} = \varepsilon_x \cos^2 \theta_a + \varepsilon_y \sin^2 \theta_a + \gamma_{xy} \sin \theta_a \cos \theta_a$$

Here $\theta_a = 45^\circ$

$$\varepsilon_{x'} = 0 + 0 + 5.030(10^{-3}) \sin 45^\circ \cos 45^\circ = 2.52(10^{-3})$$

$$\varepsilon_{x'} = \varepsilon_{y'} = 2.52(10^{-3}) \quad \text{Ans.}$$

From *Mechanics of Materials*, Sixth Edition by R. C. Hibbeler, ISBN 0-13-191345-X.

© 2005 R. C. Hibbeler. Published by Pearson Prentice Hall,

Pearson Education, Inc., Upper Saddle River, NJ. All rights reserved.

This material is protected under all copyright laws as they currently exist. No portion of this material may be reproduced, in any form or by any means, without permission in writing from the publisher.

10-47 The cross section of the rectangular beam is subjected to the bending moment M . Determine an expression for the increase in length of lines AB and CD . The material has a modulus of elasticity E and Poisson's ratio is ν .

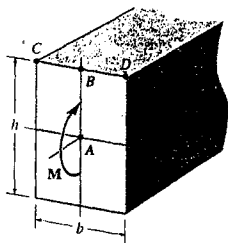

For line AB ,

$$\sigma_z = -\frac{M y}{I} = -\frac{M y}{\frac{1}{12} b h^3} = -\frac{12 M y}{b h^3}$$

$$\varepsilon_y = -\frac{\nu \sigma_z}{E} = \frac{12 \nu M y}{E b h^3}$$

$$\begin{aligned} \Delta L_{AB} &= \int_0^{\frac{h}{2}} \varepsilon_y dy = \frac{12 \nu M}{E b h^3} \int_0^{\frac{h}{2}} y dy \\ &= \frac{3 \nu M}{2 E b h} \quad \text{Ans} \end{aligned}$$

For line CD ,

$$\sigma_z = -\frac{M c}{I} = -\frac{M \frac{h}{2}}{\frac{1}{12} b h^3} = -\frac{6 M}{b h^2}$$

$$\varepsilon_x = -\frac{\nu \sigma_z}{E} = \frac{6 \nu M}{E b h^2}$$

$$\begin{aligned} \Delta L_{CD} &= \varepsilon_x L_{CD} = \frac{6 \nu M}{E b h^2} (b) \\ &= \frac{6 \nu M}{E h^2} \quad \text{Ans} \end{aligned}$$

From *Mechanics of Materials*, Sixth Edition by R. C. Hibbeler, ISBN 0-13-191345-X.

© 2005 R. C. Hibbeler. Published by Pearson Prentice Hall,

Pearson Education, Inc., Upper Saddle River, NJ. All rights reserved.

This material is protected under all copyright laws as they currently exist. No portion of this material may be reproduced, in any form or by any means, without permission in writing from the publisher.

*10-48 The strain in the x direction at point A on the steel beam is measured and found to be $\epsilon_x = -100(10^{-6})$. Determine the applied load P . What is the shear strain γ_{xy} at point A ? $E_{st} = 29(10^3)$ ksi, $\nu_{st} = 0.3$.

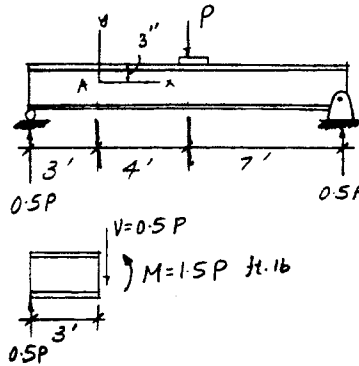
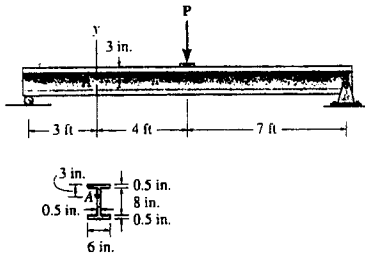

$$I_x = \frac{1}{12}(6)(9)^3 - \frac{1}{12}(5.5)(8^3) = 129.833 \text{ in}^4$$

$$Q_A = (4.25)(0.5)(6) + (2.75)(0.5)(2.5) = 16.1875 \text{ in}^3$$

$$\sigma = E\epsilon_x = 29(10^3)(100)(10^{-6}) = 2.90 \text{ ksi}$$

$$\sigma = \frac{My}{I}, \quad 2.90 = \frac{1.5P(12)(1.5)}{129.833}$$

$$P = 13.945 = 13.9 \text{ kip} \quad \text{Ans}$$

$$\tau_A = \frac{VQ}{It} = \frac{0.5(13.945)(16.1875)}{129.833(0.5)} = 1.739 \text{ ksi}$$

$$G = \frac{E}{2(1+\nu)} = \frac{29(10^3)}{2(1+0.3)} = 11.154(10^3) \text{ ksi}$$

$$\gamma_{xy} = \frac{\tau_{xy}}{G} = \frac{1.739}{11.154(10^3)} = 0.156(10^{-3}) \text{ rad} \quad \text{Ans}$$

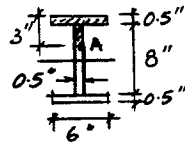

From *Mechanics of Materials*, Sixth Edition by R. C. Hibbeler, ISBN 0-13-191345-X.

© 2005 R. C. Hibbeler. Published by Pearson Prentice Hall,

Pearson Education, Inc., Upper Saddle River, NJ. All rights reserved.

This material is protected under all copyright laws as they currently exist. No portion of this material may be reproduced, in any form or by any means, without permission in writing from the publisher.

10-49 The strain in the x direction at point A on the A-36 structural-steel beam is measured and found to be $\epsilon_x = 100(10^{-6})$. Determine the applied load P . What is the shear strain γ_{xy} at point A?

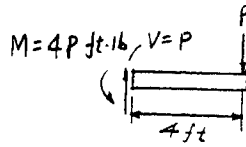
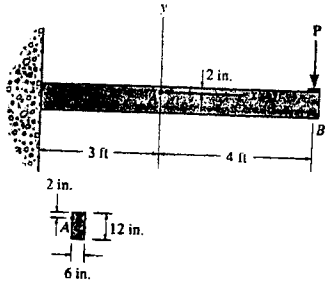

Section properties :

$$I = \frac{1}{12} (6)(12^3) = 864 \text{ in}^4$$

$$Q_A = \bar{y}' A' = 5 (6)(2) = 60 \text{ in}^3$$

Normal stress :

$$\sigma = E \epsilon_x = 29 (10^3)(100)(10^{-6}) = 2.90 \text{ ksi}$$

$$\sigma = \frac{M y}{I}; \quad 2.90(10^3) = \frac{4 P (12)(4)}{864}$$

$$P = 13050 \text{ lb} = 13.0 \text{ kip}$$

Ans

$$\tau_{xy} = \frac{V Q}{I t} = \frac{13.05 (10^3)(60)}{864 (6)} = 151.04 \text{ psi}$$

$$\gamma_{xy} = \frac{\tau_{xy}}{G} = \frac{151.04}{11.0 (10^6)} = 13.7 (10^{-6})$$

Ans

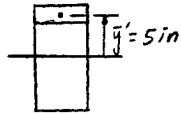

From *Mechanics of Materials*, Sixth Edition by R. C. Hibbeler, ISBN 0-13-191345-X.

© 2005 R. C. Hibbeler. Published by Pearson Prentice Hall,

Pearson Education, Inc., Upper Saddle River, NJ. All rights reserved.

This material is protected under all copyright laws as they currently exist. No portion of this material may be reproduced, in any form or by any means, without permission in writing from the publisher.

10-50 The strain in the x direction at point A on the A-36 structural-steel beam is measured and found to be $\epsilon_x = 200(10^{-6})$. Determine the applied load P . What is the shear strain γ_{xy} at point A ?

Section properties :

$$Q_A = \bar{y}' A' = 5(6)(2) = 60 \text{ in}^3$$

$$I = \frac{1}{12}(6)(12^3) = 864 \text{ in}^4$$

Normal stress :

$$\sigma = E \epsilon_x = 29(10^3)(200)(10^{-6}) = 5.80 \text{ ksi}$$

$$\sigma = \frac{My}{I}; \quad 5.80(10^3) = \frac{4P(12)(4)}{864}$$

$$P = 26.1 \text{ kip}$$

Shear stress and shear strain :

$$\tau_A = \frac{VQ}{It} = \frac{26.1(60)}{864(6)} = 0.302 \text{ ksi}$$

$$\gamma_{xy} = \frac{\tau_{xy}}{G} = \frac{0.302}{11.0(10^3)} = 27.5(10^{-6}) \text{ rad}$$

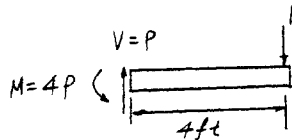
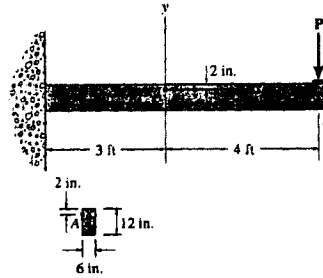

Ans

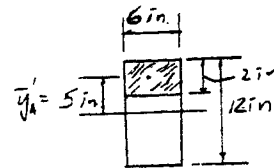

Ans

From *Mechanics of Materials*, Sixth Edition by R. C. Hibbeler, ISBN 0-13-191345-X.

© 2005 R. C. Hibbeler. Published by Pearson Prentice Hall,

Pearson Education, Inc., Upper Saddle River, NJ. All rights reserved.

This material is protected under all copyright laws as they currently exist. No portion of this material may be reproduced, in any form or by any means, without permission in writing from the publisher.

10-51 If a load of $P = 3$ kip is applied to the A-36 structural-steel beam, determine the strain ϵ_x and γ_{xy} at point A.

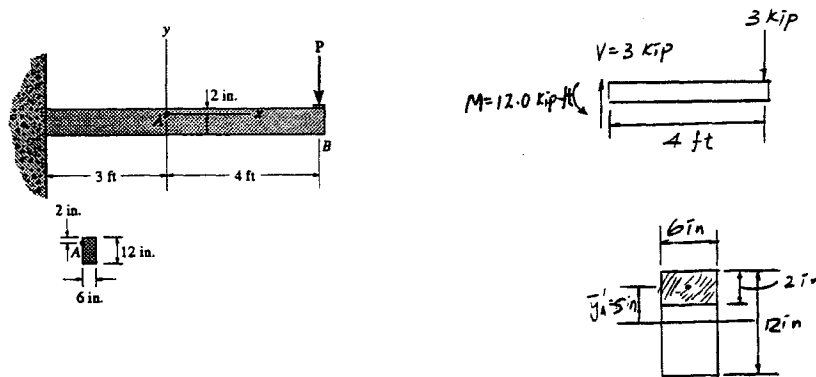

Section properties :

$$Q_A = \bar{y}' A' = 2 (6)(5) = 60 \text{ in}^3$$

$$I = \frac{1}{12} (6)(12^3) = 864 \text{ in}^4$$

Normal stress and strain :

$$\sigma_A = \frac{M y}{I} = \frac{12.0 (10^3)(12)(4)}{864} = 666.7 \text{ psi}$$

$$\epsilon_x = \frac{\sigma_x}{E} = \frac{666.7}{29 (10^6)} = 23.0 (10^{-6}) \quad \text{Ans}$$

Shear stress and shear strain :

$$\tau_A = \frac{V Q}{I t} = \frac{3(10^3) (60)}{864 (6)} = 34.72 \text{ psi}$$

$$\gamma_{xy} = \frac{\tau_{xy}}{G} = \frac{34.72}{11.0 (10^6)} = 3.16 (10^{-6}) \quad \text{Ans}$$

From *Mechanics of Materials*, Sixth Edition by R. C. Hibbeler, ISBN 0-13-191345-X.

© 2005 R. C. Hibbeler. Published by Pearson Prentice Hall,

Pearson Education, Inc., Upper Saddle River, NJ. All rights reserved.

This material is protected under all copyright laws as they currently exist. No portion of this material may be reproduced, in any form or by any means, without permission in writing from the publisher.

*10-52 A material is subjected to principal stresses σ_x and σ_y . Determine the orientation θ of a strain gauge placed at the point so that its reading of normal strain responds only to σ_y and not σ_x . The material constants are E and ν .

$$\sigma_x = \frac{\sigma_x + \sigma_y}{2} + \frac{\sigma_x - \sigma_y}{2} \cos 2\theta + \tau_{xy} \sin 2\theta$$

Since $\tau_{xy} = 0$,

$$\sigma_n = \frac{\sigma_x + \sigma_y}{2} + \frac{\sigma_x - \sigma_y}{2} \cos 2\theta$$

$$\cos 2\theta = 2 \cos^2 \theta - 1$$

$$\sigma_n = \frac{\sigma_x}{2} + \frac{\sigma_y}{2} + (\sigma_x - \sigma_y) \cos^2 \theta - \frac{\sigma_x}{2} + \frac{\sigma_y}{2}$$

$$= \sigma_y (1 - \cos^2 \theta) + \sigma_x \cos^2 \theta$$

$$= \sigma_x \cos^2 \theta + \sigma_y \sin^2 \theta$$

$$\sigma_{n+90^\circ} = \frac{\sigma_x + \sigma_y}{2} - \frac{\sigma_x - \sigma_y}{2} \cos 2\theta$$

$$= \frac{\sigma_x}{2} + \frac{\sigma_y}{2} - \left(\frac{\sigma_x - \sigma_y}{2} \right) (2 \cos^2 \theta - 1)$$

$$= \frac{\sigma_x}{2} + \frac{\sigma_y}{2} - (\sigma_x - \sigma_y) \cos^2 \theta + \frac{\sigma_x}{2} - \frac{\sigma_y}{2}$$

$$= \sigma_x (1 - \cos^2 \theta) + \sigma_y \cos^2 \theta$$

$$= \sigma_x \sin^2 \theta + \sigma_y \cos^2 \theta$$

$$\epsilon_n = \frac{1}{E} (\sigma_n - \nu \sigma_{n+90^\circ})$$

$$= \frac{1}{E} (\sigma_x \cos^2 \theta + \sigma_y \sin^2 \theta - \nu \sigma_x \sin^2 \theta - \nu \sigma_y \cos^2 \theta)$$

If ϵ_n is to be independent of σ_x , then

$$\cos^2 \theta - \nu \sin^2 \theta = 0 \quad \text{or} \quad \tan^2 \theta = 1/\nu$$

$$\theta = \tan^{-1} \left(\frac{1}{\sqrt{\nu}} \right) \quad \text{Ans}$$

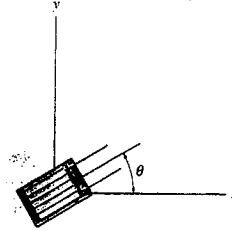

From *Mechanics of Materials*, Sixth Edition by R. C. Hibbeler, ISBN 0-13-191345-X.

© 2005 R. C. Hibbeler. Published by Pearson Prentice Hall,

Pearson Education, Inc., Upper Saddle River, NJ. All rights reserved.

This material is protected under all copyright laws as they currently exist. No portion of this material may be reproduced, in any form or by any means, without permission in writing from the publisher.

10-53 The principal stresses at a point are shown in the figure. If the material is aluminum for which $E_{al} = 10(10^3)$ ksi and $\nu_{al} = 0.33$, determine the principal strains.

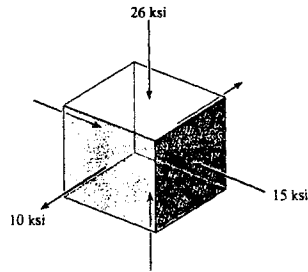

$$\varepsilon_x = \frac{1}{E}(\sigma_x - \nu(\sigma_y + \sigma_z)) = \frac{1}{10(10^3)}(10 - 0.33(-15 - 26)) = 2.35(10^{-3}) \quad \text{Ans}$$

$$\varepsilon_y = \frac{1}{E}(\sigma_y - \nu(\sigma_x + \sigma_z)) = \frac{1}{10(10^3)}(-15 - 0.33(10 - 26)) = -0.972(10^{-3}) \quad \text{Ans}$$

$$\varepsilon_z = \frac{1}{E}(\sigma_z - \nu(\sigma_x + \sigma_y)) = \frac{1}{10(10^3)}(-26 - 0.33(10 - 15)) = -2.44(10^{-3}) \quad \text{Ans}$$

From *Mechanics of Materials*, Sixth Edition by R. C. Hibbeler, ISBN 0-13-191345-X.

© 2005 R. C. Hibbeler. Published by Pearson Prentice Hall,

Pearson Education, Inc., Upper Saddle River, NJ. All rights reserved.

This material is protected under all copyright laws as they currently exist. No portion of this material may be reproduced, in any form or by any means, without permission in writing from the publisher.

10-54 A thin-walled cylindrical pressure vessel has an inner radius r , thickness t , and length L . If it is subjected to an internal pressure p , show that the increase in its inner radius is $dr = r\epsilon_1 = \frac{pr^2(1 - \frac{1}{2}\nu)}{Et}$ and the increase in its length is $\Delta L = \frac{pLr(\frac{1}{2} - \nu)}{Et}$. Using these results, show that the change in internal volume becomes $dV = \pi r^2(1 + \epsilon_1)^2(1 + \epsilon_2)L - \pi r^2L$. Since ϵ_1 and ϵ_2 are small quantities, show further that the change in volume per unit volume, called *volumetric strain*, can be written as $dV/V = Pr(2.5 - 2\nu)/Et$.

Normal stress :

$$\sigma_1 = \frac{pr}{t}; \quad \sigma_2 = \frac{pr}{2t}$$

Normal strain : Applying Hooke's law

$$\epsilon_1 = \frac{1}{E} [\sigma_1 - \nu(\sigma_2 + \sigma_3)], \quad \sigma_3 = 0$$

$$= \frac{1}{E} \left(\frac{pr}{t} - \frac{\nu pr}{2t} \right) = \frac{pr}{Et} \left(1 - \frac{1}{2}\nu \right)$$

$$dr = \epsilon_1 r = \frac{pr^2}{Et} \left(1 - \frac{1}{2}\nu \right) \quad \text{QED}$$

$$\epsilon_2 = \frac{1}{E} [\sigma_2 - \nu(\sigma_1 + \sigma_3)], \quad \sigma_3 = 0$$

$$= \frac{1}{E} \left(\frac{pr}{2t} - \frac{\nu pr}{t} \right) = \frac{pr}{Et} \left(\frac{1}{2} - \nu \right)$$

$$\Delta L = \epsilon_2 L = \frac{pLr}{Et} \left(\frac{1}{2} - \nu \right) \quad \text{QED}$$

$$V' = \pi (r + \epsilon_1 r)^2 (L + \epsilon_2 L); \quad V = \pi r^2 L$$

$$dV = V' - V = \pi r^2 (1 + \epsilon_1)^2 (1 + \epsilon_2)L - \pi r^2 L \quad \text{QED}$$

$$(1 + \epsilon_1)^2 = 1 + 2\epsilon_1 \quad \text{neglect } \epsilon_1^2 \text{ term}$$

$$(1 + \epsilon_1)^2 (1 + \epsilon_2) = (1 + 2\epsilon_1)(1 + \epsilon_2) = 1 + \epsilon_2 + 2\epsilon_1 \quad \text{neglect } \epsilon_1\epsilon_2 \text{ term}$$

$$\frac{dV}{V} = 1 + \epsilon_2 + 2\epsilon_1 - 1 = \epsilon_2 + 2\epsilon_1$$

$$= \frac{pr}{Et} \left(\frac{1}{2} - \nu \right) + \frac{2pr}{Et} \left(1 - \frac{1}{2}\nu \right)$$

$$= \frac{pr}{Et} (2.5 - 2\nu) \quad \text{QED}$$

From *Mechanics of Materials*, Sixth Edition by R. C. Hibbeler, ISBN 0-13-191345-X.

© 2005 R. C. Hibbeler. Published by Pearson Prentice Hall,

Pearson Education, Inc., Upper Saddle River, NJ. All rights reserved.

This material is protected under all copyright laws as they currently exist. No portion of this material may be reproduced, in any form or by any means, without permission in writing from the publisher.

10-55 The cylindrical pressure vessel is fabricated using hemispherical end caps in order to reduce the bending stress that would occur if flat ends were used. The bending stresses at the seam where the caps are attached can be eliminated by proper choice of the thickness t_h and t_c of the caps and cylinder, respectively. This requires the radial expansion to be the same for both the hemispheres and cylinder. Show that this ratio is $t_c/t_h = (2 - \nu)/(1 - \nu)$. Assume that the vessel is made of the same material and both the cylinder and hemispheres have the same inner radius. If the cylinder is to have a thickness of 0.5 in., what is the required thickness of the hemispheres? Take $\nu = 0.3$.

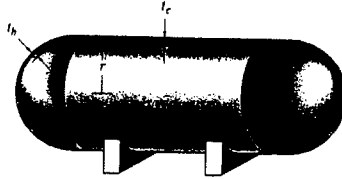

For cylindrical vessel :

$$\sigma_1 = \frac{p r}{t_c}; \quad \sigma_2 = \frac{p r}{2 t_c}$$

$$\varepsilon_1 = \frac{1}{E} [\sigma_1 - \nu (\sigma_2 + \sigma_3)] \quad \sigma_3 = 0$$

$$= \frac{1}{E} \left(\frac{p r}{t_c} - \frac{\nu p r}{2 t_c} \right) = \frac{p r}{E t_c} \left(1 - \frac{1}{2} \nu \right)$$

$$d r = \varepsilon_1 r = \frac{p r^2}{E t_c} \left(1 - \frac{1}{2} \nu \right) \quad (1)$$

For hemispherical end caps :

$$\sigma_1 = \sigma_2 = \frac{p r}{2 t_h}$$

$$\varepsilon_1 = \frac{1}{E} [\sigma_1 - \nu (\sigma_2 + \sigma_3)]; \quad \sigma_3 = 0$$

$$= \frac{1}{E} \left(\frac{p r}{2 t_h} - \frac{\nu p r}{2 t_h} \right) = \frac{p r}{2 E t_h} (1 - \nu)$$

$$d r = \varepsilon_1 r = \frac{p r^2}{2 E t_h} (1 - \nu) \quad (2)$$

Equate Eqs. (1) and (2) :

$$\frac{p r^2}{E t_c} \left(1 - \frac{1}{2} \nu \right) = \frac{p r^2}{2 E t_h} (1 - \nu)$$

$$\frac{t_c}{t_h} = \frac{2 \left(1 - \frac{1}{2} \nu \right)}{1 - \nu} = \frac{2 - \nu}{1 - \nu} \quad \text{QED}$$

$$t_h = \frac{(1 - \nu) t_c}{2 - \nu} = \frac{(1 - 0.3)(0.5)}{2 - 0.3} = 0.206 \text{ in.} \quad \text{Ans}$$

From *Mechanics of Materials*, Sixth Edition by R. C. Hibbeler, ISBN 0-13-191345-X.

© 2005 R. C. Hibbeler. Published by Pearson Prentice Hall,

Pearson Education, Inc., Upper Saddle River, NJ. All rights reserved.

This material is protected under all copyright laws as they currently exist. No portion of this material may be reproduced, in any form or by any means, without permission in writing from the publisher.

***10-56** A thin-walled spherical pressure vessel has an inner radius r , thickness t , and is subjected to an internal pressure p . If the material constants are E and ν , determine the strain in the circumferential direction in terms of the stated parameters.

Principal stresses :

$$\sigma_1 = \sigma_2 = \sigma = \frac{pr}{2t}; \quad \sigma_3 = 0$$

Applying Hooke's law :

$$\epsilon_1 = \epsilon_2 = \epsilon = \frac{1}{E} [\sigma_1 - \nu(\sigma_2 + \sigma_3)]$$

$$\begin{aligned} \epsilon &= \frac{1}{E} [\sigma - \nu\sigma] = \frac{1-\nu}{E} \sigma \\ &= \frac{1-\nu}{E} \left(\frac{pr}{2t} \right) = \frac{pr}{2tE} (1-\nu) \quad \text{Ans} \end{aligned}$$

From *Mechanics of Materials*, Sixth Edition by R. C. Hibbeler, ISBN 0-13-191345-X.

© 2005 R. C. Hibbeler. Published by Pearson Prentice Hall,

Pearson Education, Inc., Upper Saddle River, NJ. All rights reserved.

This material is protected under all copyright laws as they currently exist. No portion of this material may be reproduced, in any form or by any means, without permission in writing from the publisher.

10-57 Air is pumped into the steel thin-walled pressure vessel at C . If the ends of the vessel are closed using two pistons connected by a rod AB , determine the increase in the diameter of the pressure vessel when the internal gauge pressure is 5 MPa. Also, what is the tensile stress in rod AB if it has a diameter of 100 mm? The inner radius of the vessel is 400 mm, and its thickness is 10 mm. $E_{st} = 200$ GPa and $\nu_{st} = 0.3$.

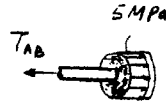

Circumferential stress :

$$\sigma = \frac{p r}{t} = \frac{5 (400)}{10} = 200 \text{ MPa}$$

Note : longitudinal and radial stresses are zero.

Circumferential strain :

$$\epsilon = \frac{\sigma}{E} = \frac{200 (10^6)}{200 (10^9)} = 1.0 (10^{-3})$$

$$\Delta d = \epsilon d = 1.0 (10^{-3}) (800) = 0.800 \text{ mm} \quad \text{Ans}$$

For rod AB :

$$\leftarrow \Sigma F_x = 0; \quad T_{AB} - 5(10^6) \left(\frac{\pi}{4} (0.8^2 - 0.1^2) \right) = 0$$

$$T_{AB} = 2474 \text{ kN}$$

$$\sigma_{AB} = \frac{T_{AB}}{A_{AB}} = \frac{2474 (10^3)}{\frac{\pi}{4} (0.1^2)} = 315 \text{ MPa} \quad \text{Ans}$$

From *Mechanics of Materials*, Sixth Edition by R. C. Hibbeler, ISBN 0-13-191345-X.

© 2005 R. C. Hibbeler. Published by Pearson Prentice Hall,

Pearson Education, Inc., Upper Saddle River, NJ. All rights reserved.

This material is protected under all copyright laws as they currently exist. No portion of this material may be reproduced, in any form or by any means, without permission in writing from the publisher.

10-58 Determine the increase in the diameter of the pressure vessel in Prob. 10-57 if the pistons are replaced by walls connected to the ends of the vessel.

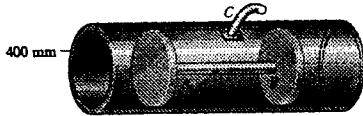

Principal stress :

$$\sigma_1 = \frac{p r}{t} = \frac{5 (400)}{10} = 200 \text{ MPa}; \quad \sigma_3 = 0$$

$$\sigma_2 = \frac{1}{2} \sigma_1 = 100 \text{ MPa}$$

Circumferential strain :

$$\begin{aligned} \epsilon_1 &= \frac{1}{E} [\sigma_1 - \nu(\sigma_2 + \sigma_3)] = \frac{1}{200 (10^9)} [200 (10^6) - 0.3 \{ 100 (10^6) + 0 \}] \\ &= 0.85 (10^{-3}) \end{aligned}$$

$$\Delta d = \epsilon_1 d = 0.85 (10^{-3}) (800) = 0.680 \text{ mm} \quad \text{Ans}$$

From *Mechanics of Materials*, Sixth Edition by R. C. Hibbeler, ISBN 0-13-191345-X.

© 2005 R. C. Hibbeler. Published by Pearson Prentice Hall,

Pearson Education, Inc., Upper Saddle River, NJ. All rights reserved.

This material is protected under all copyright laws as they currently exist. No portion of this material may be reproduced, in any form or by any means, without permission in writing from the publisher.

10-59 The thin-walled cylindrical pressure vessel of inner radius r and thickness t is subjected to an internal pressure p . If the material constants are E and ν , determine the strains in the circumferential and longitudinal directions. Using these results, compute the increase in both the diameter and the length of a steel pressure vessel filled with air and having an internal gauge pressure of 15 MPa. The vessel is 3 m long, and has an inner radius of 0.5 m and a thickness of 10 mm. $E_{st} = 200 \text{ GPa}$, $\nu_{st} = 0.3$.

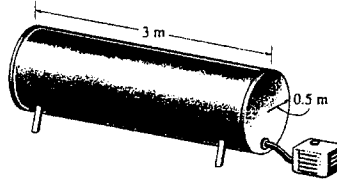

Normal stress :

$$\sigma_1 = \frac{pr}{t} \quad \sigma_2 = \frac{pr}{2t} \quad \sigma_3 = 0$$

Normal strain :

$$\begin{aligned} \epsilon_{\text{cir}} &= \frac{1}{E} [\sigma_1 - \nu(\sigma_2 + \sigma_3)] \\ &= \frac{1}{E} \left(\frac{pr}{t} - \frac{\nu pr}{2t} \right) = \frac{pr}{2Et} (2 - \nu) \end{aligned} \quad \text{Ans}$$

$$\begin{aligned} \epsilon_{\text{long}} &= \frac{1}{E} [\sigma_2 - \nu(\sigma_1 + \sigma_3)] \\ &= \frac{1}{E} \left(\frac{pr}{2t} - \frac{\nu pr}{t} \right) = \frac{pr}{2Et} (1 - 2\nu) \end{aligned} \quad \text{Ans}$$

Numerical substitution :

$$\epsilon_{\text{cir}} = \frac{15(10^6)(0.5)}{2(200)(10^9)(0.01)} (2 - 0.3) = 3.1875 (10^{-3})$$

$$\Delta d = \epsilon_{\text{cir}} d = 3.1875 (10^{-3}) (1000) = 3.19 \text{ mm} \quad \text{Ans}$$

$$\epsilon_{\text{long}} = \frac{15(10^6)(0.5)}{2(200)(10^9)(0.01)} (1 - 2(0.3)) = 0.75 (10^{-3})$$

$$\Delta L = \epsilon_{\text{long}} L = 0.75 (10^{-3}) (3000) = 2.25 \text{ mm} \quad \text{Ans}$$

From *Mechanics of Materials*, Sixth Edition by R. C. Hibbeler, ISBN 0-13-191345-X.

© 2005 R. C. Hibbeler. Published by Pearson Prentice Hall,

Pearson Education, Inc., Upper Saddle River, NJ. All rights reserved.

This material is protected under all copyright laws as they currently exist. No portion of this material may be reproduced, in any form or by any means, without permission in writing from the publisher.

*10-60 Estimate the increase in volume of the tank in Prob. 10-59. *Suggestion:* Use the results of Prob. 10-54 as a check.

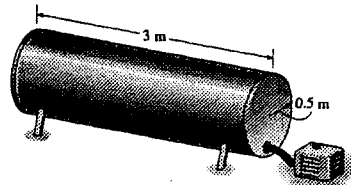

By basic principles,

$$\begin{aligned} \Delta V &= \pi (r + \Delta r)^2 (L + \Delta L) - \pi r^2 L = \pi (r^2 + \Delta r^2 + 2r\Delta r)(L + \Delta L) - \pi r^2 L \\ &= \pi (r^2 L + r^2 \Delta L + \Delta r^2 L + \Delta r^2 \Delta L + 2r\Delta r L + 2r\Delta r \Delta L - r^2 L) \\ &= \pi (r^2 \Delta L + \Delta r^2 L + \Delta r^2 \Delta L + 2r\Delta r L + 2r\Delta r \Delta L) \end{aligned}$$

Neglecting the second order terms,

$$\Delta V = \pi (r^2 \Delta L + 2r\Delta r L)$$

From Prob. 10-59,

$$\Delta L = 0.00225 \text{ m} \quad \Delta r = \frac{\Delta d}{2} = 0.00159375 \text{ m}$$

$$\Delta V = \pi [(0.5^2)(0.00225) + 2(0.5)(0.00159375)(3)] = 0.0168 \text{ m}^3 \quad \text{Ans}$$

Or use the result of Prob. 10-54

$$\frac{dV}{V} = \frac{p r}{E t} (2.5 - 2\nu)$$

$$\begin{aligned} \Delta V &= \frac{p r}{E t} (2.5 - 2\nu) V = \frac{15 (10^6)(0.5)}{200 (10^9)(0.01)} [2.5 - 2(0.3)] \pi (0.5^2)(3) \\ &= 0.0168 \text{ m}^3 \quad \text{Ans} \end{aligned}$$

From *Mechanics of Materials*, Sixth Edition by R. C. Hibbeler, ISBN 0-13-191345-X.

© 2005 R. C. Hibbeler. Published by Pearson Prentice Hall,

Pearson Education, Inc., Upper Saddle River, NJ. All rights reserved.

This material is protected under all copyright laws as they currently exist. No portion of this material may be reproduced, in any form or by any means, without permission in writing from the publisher.

10-61. A soft material is placed within the confines of a rigid cylinder which rests on a rigid support. Assuming that $\epsilon_x = 0$ and $\epsilon_y = 0$, determine the factor by which the modulus of elasticity will be increased when a load is applied if $\nu = 0.3$ for the material.

Normal Strain : Since the material is confined in a rigid cylinder, $\epsilon_x = \epsilon_y = 0$. Applying the generalized Hooke's Law,

$$\begin{aligned} \epsilon_x &= \frac{1}{E} [\sigma_x - \nu(\sigma_y + \sigma_z)] \\ 0 &= \sigma_x - \nu(\sigma_y + \sigma_z) \end{aligned} \quad [1]$$

$$\begin{aligned} \epsilon_y &= \frac{1}{E} [\sigma_y - \nu(\sigma_x + \sigma_z)] \\ 0 &= \sigma_y - \nu(\sigma_x + \sigma_z) \end{aligned} \quad [2]$$

Solving Eqs. [1] and [2] yields :

$$\sigma_x = \sigma_y = \frac{\nu}{1-\nu} \sigma_z$$

Thus,

$$\begin{aligned} \epsilon_z &= \frac{1}{E} [\sigma_z - \nu(\sigma_x + \sigma_y)] \\ &= \frac{1}{E} [\sigma_z - \nu(\frac{\nu}{1-\nu} \sigma_z + \frac{\nu}{1-\nu} \sigma_z)] \\ &= \frac{\sigma_z}{E} \left[1 - \frac{2\nu^2}{1-\nu} \right] \\ &= \frac{\sigma_z}{E} \left[\frac{1-\nu-2\nu^2}{1-\nu} \right] \\ &= \frac{\sigma_z}{E} \left[\frac{(1+\nu)(1-2\nu)}{1-\nu} \right] \end{aligned}$$

Thus, when the material is not being confined and undergoes the same normal strain of ϵ_z , then the required modulus of elasticity is

$$E' = \frac{\sigma_z}{\epsilon_z} = \frac{1-\nu}{(1-2\nu)(1+\nu)} E$$

The increased factor is $k = \frac{E'}{E} = \frac{1-\nu}{(1-2\nu)(1+\nu)}$

$$= \frac{1-0.3}{[1-2(0.3)](1+0.3)}$$

$$= 1.35$$

Ans

From *Mechanics of Materials*, Sixth Edition by R. C. Hibbeler, ISBN 0-13-191345-X.

© 2005 R. C. Hibbeler. Published by Pearson Prentice Hall,

Pearson Education, Inc., Upper Saddle River, NJ. All rights reserved.

This material is protected under all copyright laws as they currently exist. No portion of this material may be reproduced, in any form or by any means, without permission in writing from the publisher.

10-62 A thin-walled spherical pressure vessel having an inner radius r and thickness t is subjected to an internal pressure p . Show that the increase in the volume within the vessel is $\Delta V = (2p\pi^2 r^4/Et)(1 - \nu)$. Use a small-strain analysis.

$$\sigma_1 = \sigma_2 = \frac{pr}{2t}$$

$$\sigma_3 = 0$$

$$\epsilon_1 = \epsilon_2 = \frac{1}{E}(\sigma_1 - \nu\sigma_2)$$

$$\epsilon_1 = \epsilon_2 = \frac{pr}{2tE}(1 - \nu)$$

$$\epsilon_3 = \frac{1}{E}(-\nu(\sigma_1 + \sigma_2))$$

$$\epsilon_3 = \frac{\nu pr}{tE}$$

$$V = \frac{4\pi r^3}{3}$$

$$V + \Delta V = \frac{4\pi}{3}(r + \Delta r)^3 = \frac{4\pi r^3}{3}\left(1 + \frac{\Delta r}{r}\right)^3$$

where $\Delta V \ll V$, $\Delta r \ll r$

Using Eq. 2-5,

$$V + \Delta V \approx \frac{4\pi r^3}{3}\left(1 + 3\frac{\Delta r}{r}\right)$$

$$e_{vol} = \frac{\Delta V}{V} = 3\left(\frac{\Delta r}{r}\right)$$

$$\text{Since } \epsilon_1 = \epsilon_2 = \frac{2\pi(r + \Delta r) - 2\pi r}{2\pi r} = \frac{\Delta r}{r}$$

$$e_{vol} = 3\epsilon_1 = \frac{3pr}{2tE}(1 - \nu)$$

$$\Delta V = Ve_{vol} = \frac{2p\pi r^4}{Et}(1 - \nu) \quad \mathbf{QED}$$

From *Mechanics of Materials*, Sixth Edition by R. C. Hibbeler, ISBN 0-13-191345-X.

© 2005 R. C. Hibbeler. Published by Pearson Prentice Hall,

Pearson Education, Inc., Upper Saddle River, NJ. All rights reserved.

This material is protected under all copyright laws as they currently exist. No portion of this material may be reproduced, in any form or by any means, without permission in writing from the publisher.

10-63 A material is subjected to plane stress. Express the distortion-energy theory of failure in terms of σ_x , σ_y , and τ_{xy} .

Maximum distortion energy theory :

$$(\sigma_1^2 - \sigma_1 \sigma_2 + \sigma_2^2) = \sigma_Y^2 \quad (1)$$

$$\sigma_{1,2} = \frac{\sigma_x + \sigma_y}{2} \pm \sqrt{\left(\frac{\sigma_x - \sigma_y}{2}\right)^2 + \tau_{xy}^2}$$

$$\text{Let } a = \frac{\sigma_x + \sigma_y}{2} \text{ and } b = \sqrt{\left(\frac{\sigma_x - \sigma_y}{2}\right)^2 + \tau_{xy}^2}$$

$$\sigma_1 = a + b; \quad \sigma_2 = a - b$$

$$\sigma_1^2 = a^2 + b^2 + 2ab; \quad \sigma_2^2 = a^2 + b^2 - 2ab$$

$$\sigma_1 \sigma_2 = a^2 - b^2$$

From Eq. (1)

$$(a^2 + b^2 + 2ab - a^2 + b^2 + a^2 + b^2 - 2ab) = \sigma_Y^2$$

$$(a^2 + 3b^2) = \sigma_Y^2$$

$$\frac{(\sigma_x + \sigma_y)^2}{4} + 3 \frac{(\sigma_x - \sigma_y)^2}{4} + 3 \tau_{xy}^2 = \sigma_Y^2$$

$$\sigma_x^2 + \sigma_y^2 - \sigma_x \sigma_y + 3 \tau_{xy}^2 = \sigma_Y^2 \quad \text{Ans}$$

From *Mechanics of Materials*, Sixth Edition by R. C. Hibbeler, ISBN 0-13-191345-X.

© 2005 R. C. Hibbeler. Published by Pearson Prentice Hall,

Pearson Education, Inc., Upper Saddle River, NJ. All rights reserved.

This material is protected under all copyright laws as they currently exist. No portion of this material may be reproduced, in any form or by any means, without permission in writing from the publisher.

*10-64 A material is subjected to plane stress. Express the maximum-shear-stress theory of failure in terms of σ_x , σ_y , and τ_{xy} . Assume that the principal stresses are of different algebraic signs.

Maximum shear stress theory :

$$|\sigma_1 - \sigma_2| = \sigma_Y \quad (1)$$

$$\sigma_{1,2} = \frac{\sigma_x + \sigma_y}{2} \pm \sqrt{\left(\frac{\sigma_x - \sigma_y}{2}\right)^2 + \tau_{xy}^2}$$

$$|\sigma_1 - \sigma_2| = 2 \sqrt{\left(\frac{\sigma_x - \sigma_y}{2}\right)^2 + \tau_{xy}^2}$$

From Eq. (1)

$$4 \left[\left(\frac{\sigma_x - \sigma_y}{2}\right)^2 + \tau_{xy}^2 \right] = \sigma_Y^2$$

$$(\sigma_x - \sigma_y)^2 + 4 \tau_{xy}^2 = \sigma_Y^2 \quad \text{Ans}$$

From *Mechanics of Materials*, Sixth Edition by R. C. Hibbeler, ISBN 0-13-191345-X.

© 2005 R. C. Hibbeler. Published by Pearson Prentice Hall,

Pearson Education, Inc., Upper Saddle River, NJ. All rights reserved.

This material is protected under all copyright laws as they currently exist. No portion of this material may be reproduced, in any form or by any means, without permission in writing from the publisher.

10-65 The plate is made of hard copper, which yields at $\sigma_Y = 105$ ksi. Using the maximum-shear-stress theory, determine the tensile stress σ_x that can be applied to the plate if a tensile stress $\sigma_y = 0.5\sigma_x$ is also applied.

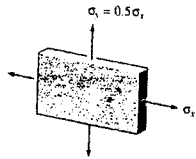

$$\sigma_1 = \sigma_x \quad \sigma_2 = \frac{1}{2}\sigma_x$$

$$|\sigma_1| = \sigma_Y$$

$$\sigma_x = 105 \text{ ksi} \quad \mathbf{Ans}$$

From *Mechanics of Materials*, Sixth Edition by R. C. Hibbeler, ISBN 0-13-191345-X.

© 2005 R. C. Hibbeler. Published by Pearson Prentice Hall,

Pearson Education, Inc., Upper Saddle River, NJ. All rights reserved.

This material is protected under all copyright laws as they currently exist. No portion of this material may be reproduced, in any form or by any means, without permission in writing from the publisher.

10-66 Solve Prob. 10-65 using the maximum-distortion-energy theory.

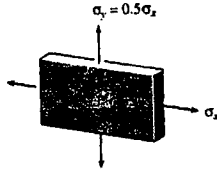

$$\sigma_1 = \sigma_x$$

$$\sigma_2 = \frac{\sigma_x}{2}$$

$$\sigma_1^2 - \sigma_1 \sigma_2 + \sigma_2^2 = \sigma_Y^2$$

$$\sigma_x^2 - \frac{\sigma_x^2}{2} + \frac{\sigma_x^2}{4} = (105)^2$$

$$\sigma_x = 121 \text{ ksi} \quad \text{Ans}$$

From *Mechanics of Materials*, Sixth Edition by R. C. Hibbeler, ISBN 0-13-191345-X.

© 2005 R. C. Hibbeler. Published by Pearson Prentice Hall,

Pearson Education, Inc., Upper Saddle River, NJ. All rights reserved.

This material is protected under all copyright laws as they currently exist. No portion of this material may be reproduced, in any form or by any means, without permission in writing from the publisher.

10-67 The yield stress for a zirconium-magnesium alloy is $\sigma_y = 15.3$ ksi. If a machine part is made of this material and a critical point in the material is subjected to in-plane principal stresses σ_1 and $\sigma_2 = -0.5\sigma_1$, determine the magnitude of σ_1 that will cause yielding according to the maximum-shear-stress theory.

$$\sigma_y = 15.3 \text{ ksi}$$

$$\sigma_1 - \sigma_2 = 15.3$$

$$\sigma_1 - (-0.5 \sigma_1) = 15.3$$

$$\sigma_1 = 10.2 \text{ ksi} \quad \mathbf{Ans}$$

From *Mechanics of Materials*, Sixth Edition by R. C. Hibbeler, ISBN 0-13-191345-X.

© 2005 R. C. Hibbeler. Published by Pearson Prentice Hall,

Pearson Education, Inc., Upper Saddle River, NJ. All rights reserved.

This material is protected under all copyright laws as they currently exist. No portion of this material may be reproduced, in any form or by any means, without permission in writing from the publisher.

*10-68 Solve Prob. 10-67 using the maximum-distortion-energy theory.

$$\sigma_1^2 - \sigma_1 \sigma_2 + \sigma_2^2 = \sigma_Y^2$$

$$\sigma_1^2 + \sigma_1(-0.5\sigma_1) + (-0.5\sigma_1)^2 = \sigma_Y^2$$

$$1.75 \sigma_1^2 = (15.3)^2$$

$$\sigma_1 = 11.6 \text{ ksi} \quad \mathbf{Ans}$$

From *Mechanics of Materials*, Sixth Edition by R. C. Hibbeler, ISBN 0-13-191345-X.

© 2005 R. C. Hibbeler. Published by Pearson Prentice Hall,

Pearson Education, Inc., Upper Saddle River, NJ. All rights reserved.

This material is protected under all copyright laws as they currently exist. No portion of this material may be reproduced, in any form or by any means, without permission in writing from the publisher.

10-69 If a shaft is made of a material for which $\sigma_Y = 50$ ksi, determine the maximum torsional shear stress required to cause yielding using the maximum-distortion-energy theory.

$$\begin{aligned}\sigma_1 &= \tau, & \sigma_2 &= -\tau \\ \sigma_1^2 - \sigma_1 \sigma_2 + \sigma_2^2 &= \sigma_Y^2 \\ 3\tau^2 &= 50^2 \\ \tau &= 28.9 \text{ ksi} & \text{Ans}\end{aligned}$$

From *Mechanics of Materials*, Sixth Edition by R. C. Hibbeler, ISBN 0-13-191345-X.

© 2005 R. C. Hibbeler. Published by Pearson Prentice Hall,

Pearson Education, Inc., Upper Saddle River, NJ. All rights reserved.

This material is protected under all copyright laws as they currently exist. No portion of this material may be reproduced, in any form or by any means, without permission in writing from the publisher.

10-70 Solve Prob. 10-69 using the maximum-shear-stress theory.

$$\sigma_1 = \tau \quad \sigma_2 = -\tau$$

$$|\sigma_1 - \sigma_2| = \sigma_Y$$

$$\tau - (-\tau) = 50$$

$$\tau = 25 \text{ ksi} \quad \mathbf{Ans}$$

From *Mechanics of Materials*, Sixth Edition by R. C. Hibbeler, ISBN 0-13-191345-X.

© 2005 R. C. Hibbeler. Published by Pearson Prentice Hall,

Pearson Education, Inc., Upper Saddle River, NJ. All rights reserved.

This material is protected under all copyright laws as they currently exist. No portion of this material may be reproduced, in any form or by any means, without permission in writing from the publisher.

10-71 The yield stress for a plastic material is $\sigma_Y = 110$ MPa. If this material is subjected to plane stress and elastic failure occurs when one principal stress is 120 MPa, what is the smallest magnitude of the other principal stress? Use the maximum distortion-energy theory.

Using the distortion - energy theory :

$$\sigma_1^2 - \sigma_1 \sigma_2 + \sigma_2^2 = \sigma_Y^2$$

$$120^2 - 120 \sigma_2 + \sigma_2^2 = 110^2$$

$$\sigma_2^2 - 120 \sigma_2 + 2300 = 0$$

Solving for the positive root :

$$\sigma_2 = 23.9 \text{ MPa} \quad \text{Ans}$$

From *Mechanics of Materials*, Sixth Edition by R. C. Hibbeler, ISBN 0-13-191345-X.

© 2005 R. C. Hibbeler. Published by Pearson Prentice Hall,

Pearson Education, Inc., Upper Saddle River, NJ. All rights reserved.

This material is protected under all copyright laws as they currently exist. No portion of this material may be reproduced, in any form or by any means, without permission in writing from the publisher.

***10-72** Solve Prob. 10-71 using the maximum-shear-stress theory. Both principal stresses have the same sign.

The material will fail for any σ_2 since
120 MPa > 110 MPa **Ans.**

From *Mechanics of Materials*, Sixth Edition by R. C. Hibbeler, ISBN 0-13-191345-X.

© 2005 R. C. Hibbeler. Published by Pearson Prentice Hall,

Pearson Education, Inc., Upper Saddle River, NJ. All rights reserved.

This material is protected under all copyright laws as they currently exist. No portion of this material may be reproduced, in any form or by any means, without permission in writing from the publisher.

10-73 The state of plane stress at a critical point in a steel machine bracket is shown. If the yield stress for steel is $\sigma_Y = 36$ ksi, determine if yielding occurs using the maximum-distortion-energy theory.

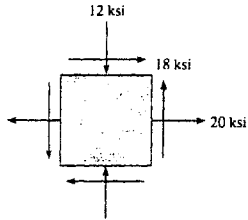

$$\sigma_x = 20 \text{ ksi} \quad \sigma_y = -12 \text{ ksi} \quad \tau_{xy} = 18 \text{ ksi}$$

$$\sigma_{1,2} = \frac{\sigma_x + \sigma_y}{2} \pm \sqrt{\left(\frac{\sigma_x - \sigma_y}{2}\right)^2 + \tau_{xy}^2}$$

$$\sigma_{1,2} = \frac{20 - 12}{2} \pm \sqrt{\left(\frac{20 - (-12)}{2}\right)^2 + 18^2}$$

$$\sigma_1 = 28.08 \text{ ksi} \quad \sigma_2 = -20.08 \text{ ksi}$$

$$(\sigma_1^2 - \sigma_1 \sigma_2 + \sigma_2^2) = (28.08^2 - 28.08(-20.08) + (-20.08)^2)$$

$$1756 > \sigma_Y^2 = 1296$$

Yes. **Ans**

From *Mechanics of Materials*, Sixth Edition by R. C. Hibbeler, ISBN 0-13-191345-X.

© 2005 R. C. Hibbeler. Published by Pearson Prentice Hall,

Pearson Education, Inc., Upper Saddle River, NJ. All rights reserved.

This material is protected under all copyright laws as they currently exist. No portion of this material may be reproduced, in any form or by any means, without permission in writing from the publisher.

10-74 Solve Prob. 10-73 using the maximum-shear-stress theory.

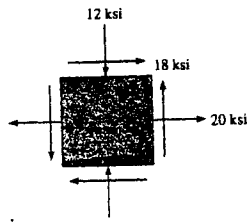

$$\sigma_x = 20 \text{ ksi} \quad \sigma_y = -12 \text{ ksi} \quad \tau_{xy} = 18 \text{ ksi}$$

$$\sigma_{1,2} = \frac{\sigma_x + \sigma_y}{2} \pm \sqrt{\left(\frac{\sigma_x - \sigma_y}{2}\right)^2 + \tau_{xy}^2}$$

$$\sigma_{1,2} = \frac{20 - 12}{2} \pm \sqrt{\left(\frac{20 - (-12)}{2}\right)^2 + 18^2}$$

$$\sigma_1 = 28.08 \text{ ksi} \quad \sigma_2 = -20.08 \text{ ksi}$$

$$|\sigma_1 - \sigma_2| = 28.08 - (-20.08) = 48.16 \text{ ksi} > \sigma_Y = 36 \text{ ksi}$$

Yes. **Ans**

From *Mechanics of Materials*, Sixth Edition by R. C. Hibbeler, ISBN 0-13-191345-X.

© 2005 R. C. Hibbeler. Published by Pearson Prentice Hall,

Pearson Education, Inc., Upper Saddle River, NJ. All rights reserved.

This material is protected under all copyright laws as they currently exist. No portion of this material may be reproduced, in any form or by any means, without permission in writing from the publisher.

10-75 An aluminum alloy 6061-T6 is to be used for a solid drive shaft such that it transmits 40 hp at 2400 rev/min. Using a factor of safety of 2 with respect to yielding, determine the smallest-diameter shaft that can be selected based on the maximum-shear-stress theory.

$$\omega = (2400 \frac{\text{rev}}{\text{min}}) (\frac{2\pi \text{ rad}}{\text{rev}}) (\frac{1 \text{ min}}{60 \text{ s}}) = 80 \pi \text{ rad/s}$$

$$T = \frac{P}{\omega} = \frac{40 (550) (12)}{80 \pi} = \frac{3300}{\pi} \text{ lb} \cdot \text{in.}$$

Applying $\tau = \frac{Tc}{J}$

$$\tau = \frac{(\frac{3300}{\pi})c}{\frac{\pi}{2}c^4} = \frac{6600}{\pi^2 c^3}$$

The principal stresses :

$$\sigma_1 = \tau = \frac{6600}{\pi^2 c^3}; \quad \sigma_2 = -\tau = -\frac{6600}{\pi^2 c^3}$$

Maximum shear stress theory : Both principal stresses have opposite sign, hence,

$$\left| \sigma_1 - \sigma_2 \right| = \frac{\sigma_Y}{\text{F.S.}}; \quad 2 \left(\frac{6600}{\pi^2 c^3} \right) = \left[\frac{37 (10^3)}{2} \right]$$

$$c = 0.4166 \text{ in.}$$

$$d = 0.833 \text{ in.} \quad \text{Ans}$$

From *Mechanics of Materials*, Sixth Edition by R. C. Hibbeler, ISBN 0-13-191345-X.

© 2005 R. C. Hibbeler. Published by Pearson Prentice Hall,

Pearson Education, Inc., Upper Saddle River, NJ. All rights reserved.

This material is protected under all copyright laws as they currently exist. No portion of this material may be reproduced, in any form or by any means, without permission in writing from the publisher.

*10-76 Solve Prob. 10-75 using the maximum-distortion-energy theory.

$$\omega = (2400 \frac{\text{rev}}{\text{min}}) (\frac{2\pi \text{ rad}}{\text{rev}}) (\frac{1 \text{ min}}{60 \text{ s}}) = 80 \pi \text{ rad/s}$$

$$T = \frac{P}{\omega} = \frac{40 (550) (12)}{80 \pi} = \frac{3300}{\pi} \text{ lb} \cdot \text{in.}$$

$$\text{Applying } \tau = \frac{Tc}{J}$$

$$\tau = \frac{(\frac{3300}{\pi})c}{\frac{\pi}{2}c^4} = \frac{6600}{\pi^2 c^3}$$

The principal stresses :

$$\sigma_1 = \tau = \frac{6600}{\pi^2 c^3}, \quad \sigma_2 = -\tau = -\frac{6600}{\pi^2 c^3}$$

The maximum distortion - energy theory :

$$\sigma_1^2 - \sigma_1 \sigma_2 + \sigma_2^2 = \left(\frac{\sigma_Y}{\text{F.S.}} \right)^2$$

$$3 \left[\frac{6600}{\pi^2 c^3} \right]^2 = \left(\frac{37(10^3)}{2} \right)^2$$

$$c = 0.3971 \text{ in.}$$

$$d = 0.794 \text{ in.} \quad \text{Ans.}$$

From *Mechanics of Materials*, Sixth Edition by R. C. Hibbeler, ISBN 0-13-191345-X.

© 2005 R. C. Hibbeler. Published by Pearson Prentice Hall,

Pearson Education, Inc., Upper Saddle River, NJ. All rights reserved.

This material is protected under all copyright laws as they currently exist. No portion of this material may be reproduced, in any form or by any means, without permission in writing from the publisher.

10-77 An aluminum alloy is to be used for a drive shaft such that it transmits 25 hp at 1500 rev/min. Using a factor of safety of 2.5 with respect to yielding, determine the smallest-diameter shaft that can be selected based on the maximum-distortion-energy theory. $\sigma_Y = 3.5$ ksi.

$$T = \frac{P}{\omega} \quad \omega = \frac{1500(2\pi)}{60} = 50\pi$$

$$T = \frac{25(550)(12)}{50\pi} = \frac{3300}{\pi}$$

$$\tau = \frac{Tc}{J}, \quad J = \frac{\pi}{2}c^4$$

$$\tau = \frac{\frac{3300}{\pi}c}{\frac{\pi}{2}c^4} = \frac{6600}{\pi^2c^3}$$

$$\sigma_1 = \frac{6600}{\pi^2c^3} \quad \sigma_2 = \frac{-6600}{\pi^2c^3}$$

$$\sigma_1^2 - \sigma_1\sigma_2 + \sigma_2^2 = \left(\frac{\sigma_Y}{\text{F.S.}}\right)^2$$

$$3\left(\frac{6600}{\pi^2c^3}\right)^2 = \left(\frac{3.5(10^3)}{2.5}\right)^2$$

$$c = 0.9388 \text{ in.}$$

$$d = 1.88 \text{ in.} \quad \mathbf{Ans}$$

From *Mechanics of Materials*, Sixth Edition by R. C. Hibbeler, ISBN 0-13-191345-X.

© 2005 R. C. Hibbeler. Published by Pearson Prentice Hall,

Pearson Education, Inc., Upper Saddle River, NJ. All rights reserved.

This material is protected under all copyright laws as they currently exist. No portion of this material may be reproduced, in any form or by any means, without permission in writing from the publisher.

10-78 A bar with a circular cross-sectional area is made of A-36 steel. If the bar is subjected to a torque of 16 kip · in. and a bending moment of 20 kip · in., determine the required diameter of the bar according to the maximum-distortion-energy theory. Use a factor of safety of 2 with respect to yielding.

$$I = \frac{\pi}{4} c^4 \quad J = \frac{\pi}{2} c^4$$

$$\sigma = \frac{Mc}{I} = \frac{20c}{\frac{\pi}{4}c^4} = \frac{80}{\pi c^3}$$

$$\tau = \frac{Tc}{J} = \frac{16c}{\frac{\pi}{2}c^4} = \frac{32}{\pi c^3}$$

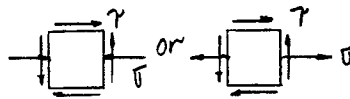

Critical state of stress :

$$A\left(\frac{80}{\pi c^3}, \frac{32}{\pi c^3}\right) \quad B\left(0, -\frac{32}{\pi c^3}\right) \quad C\left(\frac{40}{\pi c^3}, 0\right)$$

$$R = \sqrt{\left(\frac{40}{\pi c^3}\right)^2 + \left(\frac{32}{\pi c^3}\right)^2} = \frac{51.225}{\pi c^3}$$

$$\sigma_1 = \frac{40}{\pi c^3} + \frac{51.225}{\pi c^3} = \frac{91.225}{\pi c^3}$$

$$\sigma_2 = \frac{40}{\pi c^3} - \frac{51.225}{\pi c^3} = \frac{-11.225}{\pi c^3}$$

$$\sigma_{\text{allow}} = \frac{36}{\text{F.S.}} = \frac{36}{2} = 18 \text{ ksi}$$

$$(\sigma_1^2 - \sigma_1 \sigma_2 + \sigma_2^2) = \sigma_{\text{allow}}^2$$

$$\left(\frac{91.225}{\pi c^3}\right)^2 - \left(\frac{91.225}{\pi c^3}\right)\left(\frac{-11.225}{\pi c^3}\right) + \left(\frac{-11.225}{\pi c^3}\right)^2 = (18)^2$$

$$c = 1.20 \text{ in.}$$

$$d = 2c = 2.40 \text{ in.} \quad \text{Ans}$$

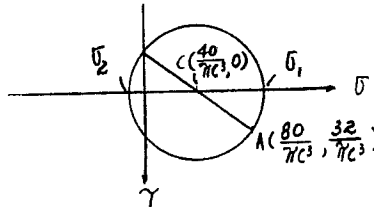

From *Mechanics of Materials*, Sixth Edition by R. C. Hibbeler, ISBN 0-13-191345-X.

© 2005 R. C. Hibbeler. Published by Pearson Prentice Hall,

Pearson Education, Inc., Upper Saddle River, NJ. All rights reserved.

This material is protected under all copyright laws as they currently exist. No portion of this material may be reproduced, in any form or by any means, without permission in writing from the publisher.

10-79 Solve Prob. 10-78 using the maximum-shear-stress theory.

$$I = \frac{\pi}{4} c^4 \quad J = \frac{\pi}{2} c^4$$

$$\sigma = \frac{Mc}{I} = \frac{20c}{\frac{\pi}{4} c^4} = \frac{80}{\pi c^3}$$

$$\tau = \frac{Tc}{J} = \frac{16c}{\frac{\pi}{2} c^4} = \frac{32}{\pi c^3}$$

Critical state of stress :

$$A\left(\frac{80}{\pi c^3}, \frac{32}{\pi c^3}\right) \quad B\left(0, -\frac{32}{\pi c^3}\right) \quad C\left(\frac{40}{\pi c^3}, 0\right)$$

$$R = \sqrt{\left(\frac{40}{\pi c^3}\right)^2 + \left(\frac{32}{\pi c^3}\right)^2} = \frac{51.225}{\pi c^3}$$

$$\sigma_1 = \frac{40}{\pi c^3} + \frac{51.225}{\pi c^3} = \frac{91.225}{\pi c^3}$$

$$\sigma_2 = \frac{40}{\pi c^3} - \frac{51.225}{\pi c^3} = \frac{-11.225}{\pi c^3}$$

$$\sigma_{\text{allow}} = \frac{36}{\text{F.S.}} = \frac{36}{2} = 18 \text{ ksi}$$

$$|\sigma_1 - \sigma_2| = \sigma_{\text{allow}}$$

$$\left| \frac{91.225}{\pi c^3} - \left(\frac{-11.225}{\pi c^3}\right) \right| = 18$$

$$c = 1.219 \text{ in.}$$

$$d = 2c = 2.44 \text{ in.} \quad \mathbf{Ans}$$

From *Mechanics of Materials*, Sixth Edition by R. C. Hibbeler, ISBN 0-13-191345-X.

© 2005 R. C. Hibbeler. Published by Pearson Prentice Hall,

Pearson Education, Inc., Upper Saddle River, NJ. All rights reserved.

This material is protected under all copyright laws as they currently exist. No portion of this material may be reproduced, in any form or by any means, without permission in writing from the publisher.

***10-80** Cast iron when tested in tension and compression has an ultimate strength of $(\sigma_{ult})_t = 280$ MPa and $(\sigma_{ult})_c = 420$ MPa, respectively. Also, when subjected to pure torsion it can sustain an ultimate shear stress of $\tau_{ult} = 168$ MPa. Plot the Mohr's circles for each case and establish the failure envelope. If a part made of this material is subjected to the state of plane stress shown, determine if it fails according to Mohr's failure criterion.

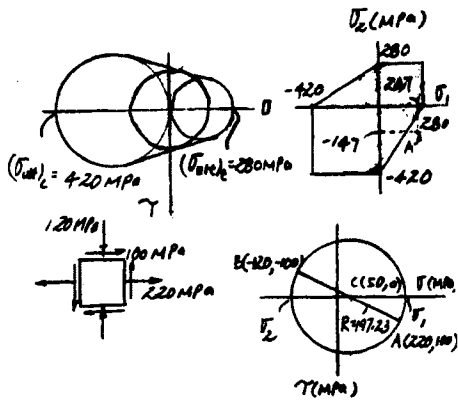
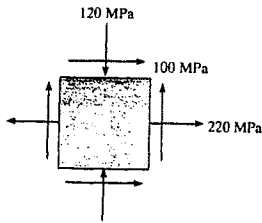

$$\sigma_1 = 50 + 197.23 = 247 \text{ MPa}$$

$$\sigma_2 = 50 - 197.23 = -147 \text{ MPa}$$

The principal stress coordinate is located at point A which is outside the shaded region. Therefore the material fails according to Mohr's failure criterion.

Yes. **Ans**

From *Mechanics of Materials*, Sixth Edition by R. C. Hibbeler, ISBN 0-13-191345-X.
 © 2005 R. C. Hibbeler. Published by Pearson Prentice Hall,
 Pearson Education, Inc., Upper Saddle River, NJ. All rights reserved.
 This material is protected under all copyright laws as they currently exist. No portion of this material may be reproduced, in any form or by any means, without permission in writing from the publisher.

10-81. The principal plane stresses acting on a differential element are shown. If the material is machine steel having a yield stress of $\sigma_Y = 700$ MPa, determine the factor of safety with respect to yielding if the maximum-shear-stress theory is considered.

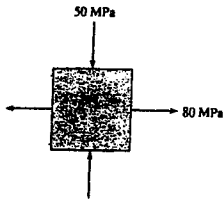

$$\sigma_{\max} = 80 \text{ MPa} \quad \sigma_{\min} = -50 \text{ MPa}$$

$$\tau_{\max} = \frac{\sigma_{\max} - \sigma_{\min}}{2} = \frac{80 - (-50)}{2} = 65 \text{ MPa}$$

$$\tau_{\max} = \frac{\sigma_Y}{2} = \frac{700}{2} = 350 \text{ MPa}$$

$$\text{F.S.} = \frac{\tau_{\max}}{\tau_{\max}} = \frac{350}{65} = 5.38 \quad \text{Ans}$$

From *Mechanics of Materials*, Sixth Edition by R. C. Hibbeler, ISBN 0-13-191345-X.

© 2005 R. C. Hibbeler. Published by Pearson Prentice Hall,

Pearson Education, Inc., Upper Saddle River, NJ. All rights reserved.

This material is protected under all copyright laws as they currently exist. No portion of this material may be reproduced, in any form or by any means, without permission in writing from the publisher.

10-82. The state of stress acting at a critical point on a machine element is shown in the figure. Determine the smallest yield stress for a steel that might be selected for the part, based on the maximum-shear-stress theory.

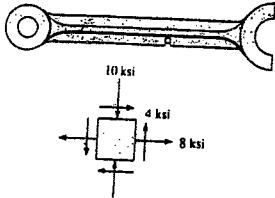

The principal stresses :

$$\begin{aligned}\sigma_{1,2} &= \frac{\sigma_x + \sigma_y}{2} \pm \sqrt{\left(\frac{\sigma_x - \sigma_y}{2}\right)^2 + \tau_{xy}^2} \\ &= \frac{8 - 10}{2} \pm \sqrt{\left(\frac{8 - (-10)}{2}\right)^2 + 4^2}\end{aligned}$$

$$\sigma_1 = 8.8489 \text{ ksi} \quad \sigma_2 = -10.8489 \text{ ksi}$$

Maximum shear stress theory : Both principal stresses have opposite sign, hence,
 $|\sigma_1 - \sigma_2| = \sigma_y \quad 8.8489 - (-10.8489) = \sigma_y$

$$\sigma_y = 19.7 \text{ ksi} \quad \text{Ans}$$

From *Mechanics of Materials*, Sixth Edition by R. C. Hibbeler, ISBN 0-13-191345-X.

© 2005 R. C. Hibbeler. Published by Pearson Prentice Hall,

Pearson Education, Inc., Upper Saddle River, NJ. All rights reserved.

This material is protected under all copyright laws as they currently exist. No portion of this material may be reproduced, in any form or by any means, without permission in writing from the publisher.

10-83 The yield stress for a uranium alloy is $\sigma_Y = 160$ MPa. If a machine part is made of this material and a critical point in the material is subjected to plane stress, such that the principal stresses are σ_1 and $\sigma_2 = 0.25\sigma_1$, determine the magnitude of σ_1 that will cause yielding according to the maximum-distortion-energy theory.

$$\sigma_1^2 - \sigma_1 \sigma_2 + \sigma_2^2 = \sigma_Y^2$$

$$\sigma_1^2 - (\sigma_1)(0.25\sigma_1) + (0.25\sigma_1)^2 = \sigma_Y^2$$

$$0.8125\sigma_1^2 = \sigma_Y^2$$

$$0.8125\sigma_1^2 = (160)^2$$

$$\sigma_1 = 178 \text{ MPa} \quad \text{Ans}$$

From *Mechanics of Materials*, Sixth Edition by R. C. Hibbeler, ISBN 0-13-191345-X.

© 2005 R. C. Hibbeler. Published by Pearson Prentice Hall,

Pearson Education, Inc., Upper Saddle River, NJ. All rights reserved.

This material is protected under all copyright laws as they currently exist. No portion of this material may be reproduced, in any form or by any means, without permission in writing from the publisher.

*10-84 Solve Prob. 10-83 using the maximum-shear-stress theory.

$$\tau_{\max} = \frac{\sigma_1}{2} \quad \tau_{\text{allow}} = \frac{\sigma_Y}{2} = \frac{160}{2} = 80 \text{ MPa}$$

$$\tau_{\max} = \tau_{\text{allow}}$$

$$\left| \frac{\sigma_1}{2} \right| = 80; \quad \sigma_1 = 160 \text{ MPa} \quad \text{Ans}$$

From *Mechanics of Materials*, Sixth Edition by R. C. Hibbeler, ISBN 0-13-191345-X.

© 2005 R. C. Hibbeler. Published by Pearson Prentice Hall,

Pearson Education, Inc., Upper Saddle River, NJ. All rights reserved.

This material is protected under all copyright laws as they currently exist. No portion of this material may be reproduced, in any form or by any means, without permission in writing from the publisher.

10-85 An aluminum alloy is to be used for a solid drive shaft, such that it transmits 30 hp at 1200 rev/min. Using a factor of safety of 2.5 with respect to yielding, determine the smallest-diameter shaft that can be selected based on the maximum-shear-stress theory. $\sigma_y = 10$ ksi.

$$T = \frac{P}{\omega} \quad \omega = \frac{2\pi(1200)}{60} = 40\pi$$

$$T = \frac{30(550)(12)}{40\pi} = \frac{4950}{\pi}$$

$$\tau = \frac{Tc}{J} = \frac{\frac{4950}{\pi}c}{\frac{\pi}{2}c^4} = \frac{9900}{\pi^2 c^3}$$

$$\sigma_1 = \frac{9900}{\pi^2 c^3} \quad \sigma_2 = \frac{-9900}{\pi^2 c^3}$$

$$|\sigma_1 - \sigma_2| = \frac{\sigma_y}{\text{F.S.}}$$

$$2\left(\frac{9900}{\pi^2 c^3}\right) = \frac{10(10^3)}{2.5}$$

$$c = 0.7945 \text{ in.}$$

$$d = 2c = 1.59 \text{ in.} \quad \mathbf{Ans}$$

From *Mechanics of Materials*, Sixth Edition by R. C. Hibbeler, ISBN 0-13-191345-X.

© 2005 R. C. Hibbeler. Published by Pearson Prentice Hall,

Pearson Education, Inc., Upper Saddle River, NJ. All rights reserved.

This material is protected under all copyright laws as they currently exist. No portion of this material may be reproduced, in any form or by any means, without permission in writing from the publisher.

10-86 The element is subjected to the stresses shown. If $\sigma_y = 36$ ksi, determine the factor of safety for the loading based on the maximum-shear-stress theory.

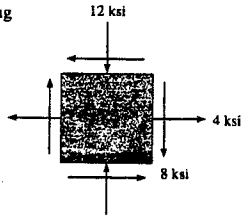

$$\sigma_x = 4 \text{ ksi} \quad \sigma_y = -12 \text{ ksi} \quad \tau_{xy} = -8 \text{ ksi}$$

$$\sigma_{1,2} = \frac{\sigma_x + \sigma_y}{2} \pm \sqrt{\left(\frac{\sigma_x - \sigma_y}{2}\right)^2 + \tau_{xy}^2}$$

$$= \frac{4 - 12}{2} \pm \sqrt{\left(\frac{4 - (-12)}{2}\right)^2 + (-8)^2}$$

$$\sigma_1 = 7.314 \text{ ksi} \quad \sigma_2 = -15.314 \text{ ksi}$$

$$\tau_{abs_{max}} = \frac{\sigma_1 - \sigma_2}{2} = \frac{7.314 - (-15.314)}{2} = 11.314 \text{ ksi}$$

$$\tau_{allow} = \frac{\sigma_y}{2} = \frac{36}{2} = 18 \text{ ksi}$$

$$F.S. = \frac{\tau_{allow}}{\tau_{abs_{max}}} = \frac{18}{11.314} = 1.59 \quad \text{Ans}$$

From *Mechanics of Materials*, Sixth Edition by R. C. Hibbeler, ISBN 0-13-191345-X.

© 2005 R. C. Hibbeler. Published by Pearson Prentice Hall,

Pearson Education, Inc., Upper Saddle River, NJ. All rights reserved.

This material is protected under all copyright laws as they currently exist. No portion of this material may be reproduced, in any form or by any means, without permission in writing from the publisher.

10-87 Solve Prob. 10-86 using the maximum-distortion-energy theory.

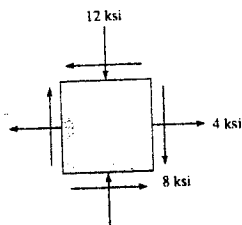

$$\sigma_x = 4 \text{ ksi} \quad \sigma_y = -12 \text{ ksi} \quad \tau_{xy} = -8 \text{ ksi}$$

$$\sigma_{1,2} = \frac{\sigma_x + \sigma_y}{2} \pm \sqrt{\left(\frac{\sigma_x - \sigma_y}{2}\right)^2 + \tau_{xy}^2}$$

$$= \frac{4 - 12}{2} \pm \sqrt{\left(\frac{4 - (-12)}{2}\right)^2 + (-8)^2}$$

$$\sigma_1 = 7.314 \text{ ksi} \quad \sigma_2 = -15.314 \text{ ksi}$$

$$\sigma_1^2 - \sigma_1 \sigma_2 + \sigma_2^2 = \left(\frac{\sigma_y}{\text{F.S.}}\right)^2$$

$$\text{F.S.} = \sqrt{\frac{36^2}{(7.134)^2 - (7.314)(-15.314) + (-15.314)^2}} = 1.80 \quad \text{Ans}$$

From *Mechanics of Materials*, Sixth Edition by R. C. Hibbeler, ISBN 0-13-191345-X.

© 2005 R. C. Hibbeler. Published by Pearson Prentice Hall,

Pearson Education, Inc., Upper Saddle River, NJ. All rights reserved.

This material is protected under all copyright laws as they currently exist. No portion of this material may be reproduced, in any form or by any means, without permission in writing from the publisher.

***10-98** If a solid shaft having a diameter d is subjected to a torque T and moment M , show that by the maximum-shear-stress theory the maximum allowable shear stress is $\tau_{\text{allow}} = (16/\pi d^3)\sqrt{M^2 + T^2}$. Assume the principal stresses to be of opposite algebraic signs.

Section properties :

$$I = \frac{\pi}{4} \left(\frac{d}{2}\right)^4 = \frac{\pi d^4}{64}; \quad J = \frac{\pi}{2} \left(\frac{d}{2}\right)^4 = \frac{\pi d^4}{32}$$

Thus,

$$\sigma = \frac{M c}{I} = \frac{M(\frac{d}{2})}{\frac{\pi d^4}{64}} = \frac{32 M}{\pi d^3}$$

$$\tau = \frac{T c}{J} = \frac{T(\frac{d}{2})}{\frac{\pi d^4}{32}} = \frac{16 T}{\pi d^3}$$

The principal stresses :

$$\begin{aligned} \sigma_{1,2} &= \frac{\sigma_x + \sigma_y}{2} \pm \sqrt{\left(\frac{\sigma_x - \sigma_y}{2}\right)^2 + \tau_{xy}^2} \\ &= \frac{16 M}{\pi d^3} \pm \sqrt{\left(\frac{16 M}{\pi d^3}\right)^2 + \left(\frac{16 T}{\pi d^3}\right)^2} = \frac{16 M}{\pi d^3} \pm \frac{16}{\pi d^3} \sqrt{M^2 + T^2} \end{aligned}$$

Assume σ_1 and σ_2 have opposite sign, hence,

$$\tau_{\text{allow}} = \frac{\sigma_1 - \sigma_2}{2} = \frac{2\left[\frac{16}{\pi d^3} \sqrt{M^2 + T^2}\right]}{2} = \frac{16}{\pi d^3} \sqrt{M^2 + T^2} \quad \mathbf{QED}$$

From *Mechanics of Materials*, Sixth Edition by R. C. Hibbeler, ISBN 0-13-191345-X.

© 2005 R. C. Hibbeler. Published by Pearson Prentice Hall,

Pearson Education, Inc., Upper Saddle River, NJ. All rights reserved.

This material is protected under all copyright laws as they currently exist. No portion of this material may be reproduced, in any form or by any means, without permission in writing from the publisher.

10-89 Derive an expression for an equivalent torque T_e that, if applied alone to a solid bar with a circular cross section, would cause the same energy of distortion as the combination of an applied bending moment M and torque T .

$$\tau = \frac{T_e c}{J}$$

Principal stress :

$$\sigma_1 = \tau, \quad \sigma_2 = -\tau$$

$$u_d = \frac{1+\nu}{3E}(\sigma_1^2 - \sigma_1\sigma_2 + \sigma_2^2)$$

$$(u_d)_1 = \frac{1+\nu}{3E}(3\tau^2) = \frac{1+\nu}{3E}\left(\frac{3T_e^2 c^2}{J^2}\right)$$

Bending moment and torsion :

$$\sigma = \frac{M c}{I}; \quad \tau = \frac{T c}{J}$$

Principal stress :

$$\sigma_{1,2} = \frac{\sigma + 0}{2} \pm \sqrt{\left(\frac{\sigma - 0}{2}\right)^2 + \tau^2}$$

$$\sigma_1 = \frac{\sigma}{2} + \sqrt{\frac{\sigma^2}{4} + \tau^2}; \quad \sigma_2 = \frac{\sigma}{2} - \sqrt{\frac{\sigma^2}{4} + \tau^2}$$

$$\text{Let } a = \frac{\sigma}{2} \quad b = \sqrt{\frac{\sigma^2}{4} + \tau^2}$$

$$\sigma_1^2 = a^2 + b^2 + 2ab$$

$$\sigma_1\sigma_2 = a^2 - b^2$$

$$\sigma_2^2 = a^2 + b^2 - 2ab$$

$$\sigma_1^2 - \sigma_1\sigma_2 + \sigma_2^2 = 3b^2 + a^2$$

$$u_d = \frac{1+\nu}{3E}(\sigma_1^2 - \sigma_1\sigma_2 + \sigma_2^2)$$

$$(u_d)_2 = \frac{1+\nu}{3E}(3b^2 + a^2) = \frac{1+\nu}{3E}\left(\frac{3\sigma^2}{4} + 3\tau^2 + \frac{\sigma^2}{4}\right)$$

$$= \frac{1+\nu}{3E}(\sigma^2 + 3\tau^2) = \frac{c^2(1+\nu)}{3E}\left(\frac{M^2}{I^2} + \frac{3T^2}{J^2}\right)$$

$$(u_d)_1 = (u_d)_2$$

$$\frac{c^2(1+\nu)}{3E} \frac{3T_e^2}{J^2} = \frac{c^2(1+\nu)}{3E} \left(\frac{M^2}{I^2} + \frac{3T^2}{J^2}\right)$$

$$T_e = \sqrt{\frac{J^2 M^2}{I^2} + T^2}$$

For circular shaft

$$\frac{J}{I} = \frac{\frac{\pi}{2} c^4}{\frac{\pi}{4} c^4} = 2$$

From *Mechanics of Materials*, Sixth Edition by R. C. Hibbeler, ISBN 0-13-191345-X.

© 2005 R. C. Hibbeler. Published by Pearson Prentice Hall,

Pearson Education, Inc., Upper Saddle River, NJ. All rights reserved.

This material is protected under all copyright laws as they currently exist. No portion of this material may be reproduced, in any form or by any means, without permission in writing from the publisher.

10-90 Derive an expression for an equivalent bending moment M_e that, if applied alone to a solid bar with a circular cross section, would cause the same maximum shear stress as the combination of an applied moment M and torque T . Assume that the principal stresses are of opposite algebraic signs.

Bending and Torsion :

$$\sigma = \frac{M c}{I} = \frac{M c}{\frac{\pi}{4} c^4} = \frac{4 M}{\pi c^3}; \quad \tau = \frac{T c}{J} = \frac{T c}{\frac{\pi}{2} c^4} = \frac{2 T}{\pi c^3}$$

The principal stresses :

$$\begin{aligned} \sigma_{1,2} &= \frac{\sigma_x + \sigma_y}{2} \pm \sqrt{\left(\frac{\sigma_x - \sigma_y}{2}\right)^2 + \tau_{xy}^2} = \frac{\frac{4 M}{\pi c^3} + 0}{2} \pm \sqrt{\left(\frac{\frac{4 M}{\pi c^3} - 0}{2}\right)^2 + \left(\frac{2 T}{\pi c^3}\right)^2} \\ &= \frac{2 M}{\pi c^3} \pm \frac{2}{\pi c^3} \sqrt{M^2 + T^2} \end{aligned}$$

$$\tau_{\max} = \sigma_1 - \sigma_2 = 2\left[\frac{2}{\pi c^3} \sqrt{M^2 + T^2}\right] \quad (1)$$

Pure bending :

$$\sigma_1 = \frac{M_e c}{I} = \frac{M_e c}{\frac{\pi}{4} c^4} = \frac{4 M_e}{\pi c^3}; \quad \sigma_2 = 0$$

$$\tau_{\max} = \sigma_1 - \sigma_2 = \frac{4 M_e}{\pi c^3} \quad (2)$$

Equating Eq. (1) and (2) yields :

$$\frac{4}{\pi c^3} \sqrt{M^2 + T^2} = \frac{4 M_e}{\pi c^3}$$

$$M_e = \sqrt{M^2 + T^2} \quad \text{Ans}$$

From *Mechanics of Materials*, Sixth Edition by R. C. Hibbeler, ISBN 0-13-191345-X.

© 2005 R. C. Hibbeler. Published by Pearson Prentice Hall,

Pearson Education, Inc., Upper Saddle River, NJ. All rights reserved.

This material is protected under all copyright laws as they currently exist. No portion of this material may be reproduced, in any form or by any means, without permission in writing from the publisher.

10-91 Derive an expression for an equivalent bending moment M_e that, if applied alone to a solid bar with a circular cross section, would cause the same energy of distortion as the combination of an applied bending moment M and torque T .

Principal stresses :

$$\sigma_1 = \frac{M_e c}{I}; \quad \sigma_2 = 0$$

$$u_d = \frac{1 + \nu}{3E} (\sigma_1^2 - \sigma_1 \sigma_2 + \sigma_2^2)$$

$$(u_d)_1 = \frac{1 + \nu}{3E} \left(\frac{M_e^2 c^2}{I^2} \right) \quad (1)$$

Principal stress :

$$\sigma_{1,2} = \frac{\sigma + 0}{2} \pm \sqrt{\left(\frac{\sigma - 0}{2}\right)^2 + \tau^2}$$

$$\sigma_1 = \frac{\sigma}{2} + \sqrt{\frac{\sigma^2}{4} + \tau^2}; \quad \sigma_2 = \frac{\sigma}{2} - \sqrt{\frac{\sigma^2}{4} + \tau^2}$$

Distortion Energy :

$$\text{Let } a = \frac{\sigma}{2}, \quad b = \sqrt{\frac{\sigma^2}{4} + \tau^2}$$

$$\sigma_1^2 = a^2 + b^2 + 2ab$$

$$\sigma_1 \sigma_2 = a^2 - b^2$$

$$\sigma_2^2 = a^2 + b^2 - 2ab$$

$$\sigma_1^2 - \sigma_1 \sigma_2 + \sigma_2^2 = 3b^2 + a^2$$

$$\text{Apply } \sigma = \frac{M_e c}{I}; \quad \tau = \frac{T c}{J}$$

$$\begin{aligned} (u_d)_2 &= \frac{1 + \nu}{3E} (3b^2 + a^2) = \frac{1 + \nu}{3E} \left(\frac{\sigma^2}{4} + \frac{3\sigma^2}{4} + 3\tau^2 \right) \\ &= \frac{1 + \nu}{3E} (\sigma^2 + 3\tau^2) = \frac{1 + \nu}{3E} \left(\frac{M_e^2 c^2}{I^2} + \frac{3T^2 c^2}{J^2} \right) \end{aligned} \quad (2)$$

Equating Eq. (1) and (2) yields :

$$\frac{(1 + \nu)}{3E} \left(\frac{M_e c^2}{I^2} \right) = \frac{1 + \nu}{3E} \left(\frac{M^2 c^2}{I^2} + \frac{3T^2 c^2}{J^2} \right)$$

$$\frac{M_e^2}{I^2} = \frac{M^2}{I^2} + \frac{3T^2}{J^2}$$

$$M_e^2 = M^2 + 3T^2 \left(\frac{I}{J} \right)^2$$

For circular shaft

$$\frac{I}{J} = \frac{\frac{\pi}{2} c^4}{\frac{\pi}{2} c^4} = \frac{1}{2}$$

$$\text{Hence, } M_e^2 = M^2 + 3T^2 \left(\frac{1}{2} \right)^2$$

$$M_e = \sqrt{M^2 + \frac{3}{4} T^2} \quad \text{Ans}$$

From *Mechanics of Materials*, Sixth Edition by R. C. Hibbeler, ISBN 0-13-191345-X.

© 2005 R. C. Hibbeler. Published by Pearson Prentice Hall,

Pearson Education, Inc., Upper Saddle River, NJ. All rights reserved.

This material is protected under all copyright laws as they currently exist. No portion of this material may be reproduced, in any form or by any means, without permission in writing from the publisher.

***10-92** The internal loadings at a critical section along the steel drive shaft of a ship are calculated to be a torque of 2300 lb · ft, a bending moment of 1500 lb · ft, and an axial thrust of 2500 lb. If the yield points for tension and shear are $\sigma_Y = 100$ ksi and $\tau_Y = 50$ ksi, respectively, determine the required diameter of the shaft using the maximum-shear-stress theory.

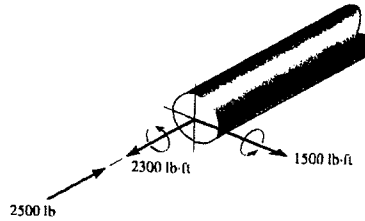

$$A = \pi c^2 \quad I = \frac{\pi c^4}{4} \quad J = \frac{\pi c^4}{2}$$

$$\sigma_A = \frac{P}{A} + \frac{Mc}{I} = -\left(\frac{2500}{\pi c^2} + \frac{1500(12)(c)}{\frac{\pi c^4}{4}}\right) = -\left(\frac{2500}{\pi c^2} + \frac{72\,000}{\pi c^3}\right)$$

$$\tau_A = \frac{Tc}{J} = \frac{2300(12)(c)}{\frac{\pi c^4}{2}} = \frac{55\,200}{\pi c^3}$$

$$\begin{aligned} \sigma_{1,2} &= \frac{\sigma_x + \sigma_y}{2} \pm \sqrt{\left(\frac{\sigma_x - \sigma_y}{2}\right)^2 + \tau_{xy}^2} \\ &= -\left(\frac{2500c + 72\,000}{2\pi c^3}\right) \pm \sqrt{\left(\frac{2500c + 72\,000}{2\pi c^3}\right)^2 + \left(\frac{55\,200}{\pi c^3}\right)^2} \quad (1) \end{aligned}$$

Assume σ_1 and σ_2 have opposite signs :

$$|\sigma_1 - \sigma_2| = \sigma_Y$$

$$2\sqrt{\left(\frac{2500c + 72\,000}{2\pi c^3}\right)^2 + \left(\frac{55\,200}{\pi c^3}\right)^2} = 100(10^3)$$

$$\begin{aligned} (2500c + 72000)^2 + 110400^2 &= 10\,000(10^6)\pi^2 c^6 \\ 6.25c^2 + 360c + 17372.16 - 10\,000\pi^2 c^6 &= 0 \end{aligned}$$

By trial and error :

$$c = 0.750\,55 \text{ in.}$$

Substitute c into Eq. (1) :

$$\sigma_1 = 22\,191 \text{ psi} \quad \sigma_2 = -77\,809 \text{ psi}$$

σ_1 and σ_2 are of opposite signs OK

Therefore,

$$d = 1.50 \text{ in.} \quad \text{Ans}$$

From *Mechanics of Materials*, Sixth Edition by R. C. Hibbeler, ISBN 0-13-191345-X.

© 2005 R. C. Hibbeler. Published by Pearson Prentice Hall,

Pearson Education, Inc., Upper Saddle River, NJ. All rights reserved.

This material is protected under all copyright laws as they currently exist. No portion of this material may be reproduced, in any form or by any means, without permission in writing from the publisher.

10-93 The internal loadings at a critical section along the steel drive shaft of a ship are calculated to be a torque of 2300 lb·ft, a bending moment of 1500 lb·ft, and an axial thrust of 2500 lb. If the yield points for tension and shear are $\sigma_Y = 100$ ksi and $\tau_Y = 50$ ksi, respectively, determine the required diameter of the shaft using the maximum-distortion-energy theory.

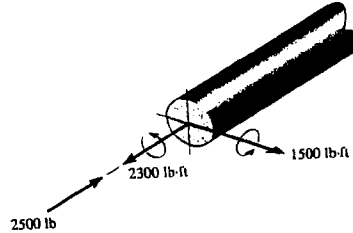

$$A = \pi c^2 \quad I = \frac{\pi c^4}{4} \quad J = \frac{\pi c^4}{2}$$

$$\sigma_A = \frac{P}{A} + \frac{Mc}{I} = -\left(\frac{2500}{\pi c^2} + \frac{1500(12)(c)}{\frac{\pi c^4}{4}}\right) = -\left(\frac{2500}{\pi c^2} + \frac{72\,000}{\pi c^3}\right)$$

$$\tau_A = \frac{Tc}{J} = \frac{2300(12)(c)}{\frac{\pi c^4}{2}} = \frac{55\,200}{\pi c^3}$$

$$\sigma_{1,2} = \frac{\sigma_x + \sigma_y}{2} \pm \sqrt{\left(\frac{\sigma_x - \sigma_y}{2}\right)^2 + \tau_{xy}^2}$$

$$= -\left(\frac{2500c + 72\,000}{2\pi c^3}\right) \pm \sqrt{\left(\frac{2500c + 72\,000}{2\pi c^3}\right)^2 + \left(\frac{55\,200}{\pi c^3}\right)^2}$$

$$\text{Let } a = \frac{2500c + 72\,000}{2\pi c^3}, \quad b = \sqrt{\left(\frac{2500c + 72\,000}{2\pi c^3}\right)^2 + \left(\frac{55\,200}{\pi c^3}\right)^2}$$

$$\sigma_1^2 = (-a + b)^2 = a^2 + b^2 - 2ab$$

$$\sigma_1 \sigma_2 = (-a + b)(-a - b) = a^2 - b^2$$

$$\sigma_2^2 = (-a - b)^2 = a^2 + b^2 + 2ab$$

$$\sigma_1^2 - \sigma_1 \sigma_2 + \sigma_2^2 = a^2 + 3b^2$$

$$\sigma_1^2 - \sigma_1 \sigma_2 + \sigma_2^2 = \sigma_Y^2$$

$$a^2 + 3b^2 = \sigma_Y^2$$

$$\left(\frac{2500c + 72\,000}{2\pi c^3}\right)^2 + 3\left[\left(\frac{2500c + 72\,000}{2\pi c^3}\right)^2 + \left(\frac{55\,200}{\pi c^3}\right)^2\right] = (100(10^3))^2$$

$$25c^2 + 1440c + 57300 - 394784c^6 = 0$$

By trial and error :

$$c = 0.72715 \text{ in.} \quad d = 2c = 1.45 \text{ in.} \quad \text{Ans}$$

From *Mechanics of Materials*, Sixth Edition by R. C. Hibbeler, ISBN 0-13-191345-X.

© 2005 R. C. Hibbeler. Published by Pearson Prentice Hall,

Pearson Education, Inc., Upper Saddle River, NJ. All rights reserved.

This material is protected under all copyright laws as they currently exist. No portion of this material may be reproduced, in any form or by any means, without permission in writing from the publisher.

10-94 The 304-stainless-steel cylinder has an inner diameter of 4 in. and a wall thickness of 0.1 in. If it is subjected to an internal pressure of $p = 80$ psi, axial load of 500 lb and a torque of 70 lb · ft, determine if yielding occurs according to the maximum-distortion energy theory.

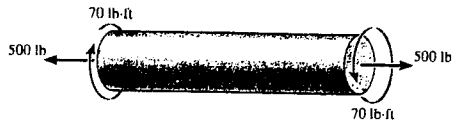

$$\sigma_x = \frac{P}{A} + \frac{pr}{2t} = \frac{500}{\pi(2.1)^2 - \pi(2)^2} + \frac{80(2)}{2(0.1)} = 1188.18 \text{ psi}$$

$$\sigma_y = \frac{pr}{t} = \frac{80(2)}{0.1} = 1600 \text{ psi}$$

$$\tau = \frac{Tc}{J} = \frac{70(12)(2.1)}{\frac{\pi}{2}(2.1)^4 - \frac{\pi}{2}(2)^4} = 325.686 \text{ psi}$$

$$\begin{aligned} \sigma_{1,2} &= \frac{\sigma_x + \sigma_y}{2} \pm \sqrt{\left(\frac{\sigma_x - \sigma_y}{2}\right)^2 + \tau_{xy}^2} \\ &= \frac{1188.18 + 1600}{2} \pm \sqrt{\left(\frac{1188.18 - 1600}{2}\right)^2 + (325.686)^2} \end{aligned}$$

$$\sigma_1 = 1779.408 \text{ psi}$$

$$\sigma_2 = 1008.77 \text{ psi}$$

$$\begin{aligned} \sigma_1^2 - \sigma_1 \sigma_2 + \sigma_2^2 &= (1779.408)^2 - (1779.408)(1008.77) + (1008.77)^2 \leq [(30)(10^3)]^2 \\ &= 2.389(10^6) \leq 900(10^6) \end{aligned}$$

Yielding will not occur. **Ans**

From *Mechanics of Materials*, Sixth Edition by R. C. Hibbeler, ISBN 0-13-191345-X.

© 2005 R. C. Hibbeler. Published by Pearson Prentice Hall,

Pearson Education, Inc., Upper Saddle River, NJ. All rights reserved.

This material is protected under all copyright laws as they currently exist. No portion of this material may be reproduced, in any form or by any means, without permission in writing from the publisher.

10-95 The 304-stainless-steel cylinder has an inner diameter of 4 in. and a wall thickness of 0.1 in. If it is subjected to an internal pressure of $p = 80$ psi, axial load of 500 lb and a torque of 70 lb · ft, determine if yielding occurs according to the maximum-shear-stress theory.

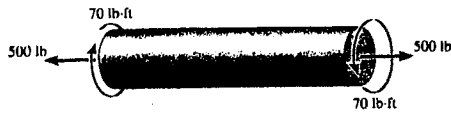

$$\sigma_x = \frac{P}{A} + \frac{pr}{2t} = \frac{500}{\pi(2.1)^2 - \pi(2)^2} + \frac{80(2)}{2(0.1)} = 1188.18 \text{ psi}$$

$$\sigma_y = \frac{pr}{t} = \frac{80(2)}{0.1} = 1600 \text{ psi}$$

$$\tau = \frac{Tc}{J} = \frac{70(12)(2.1)}{\frac{\pi}{2}(2.1)^2 - \frac{\pi}{2}(2)^2} = 325.686 \text{ psi}$$

$$\begin{aligned} \sigma_{1,2} &= \frac{\sigma_x + \sigma_y}{2} \pm \sqrt{\left(\frac{\sigma_x - \sigma_y}{2}\right)^2 + \tau_{xy}^2} \\ &= \frac{1188.18 + 1600}{2} \pm \sqrt{\left(\frac{1188.18 - 1600}{2}\right)^2 + (325.686)^2} \end{aligned}$$

$$\sigma_1 = 1779.408 \text{ psi}$$

$$\sigma_2 = 1008.77 \text{ psi}$$

Since

$$\sigma_1 = 1.78 \text{ ksi} < 30 \text{ ksi} \quad \text{yielding will not occur.} \quad \text{Ans}$$

From *Mechanics of Materials*, Sixth Edition by R. C. Hibbeler, ISBN 0-13-191345-X.

© 2005 R. C. Hibbeler. Published by Pearson Prentice Hall,

Pearson Education, Inc., Upper Saddle River, NJ. All rights reserved.

This material is protected under all copyright laws as they currently exist. No portion of this material may be reproduced, in any form or by any means, without permission in writing from the publisher.

***10-96** The short concrete cylinder having a diameter of 50 mm is subjected to a torque of 500 N·m and an axial compressive force of 2 kN. Determine if it fails according to the maximum-normal-stress theory. The ultimate stress of the concrete is $\sigma_{ult} = 28$ MPa.

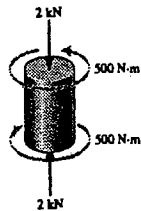

$$A = \frac{\pi}{4}(0.05)^2 = 1.9635(10^{-3}) \text{ m}^2$$

$$J = \frac{\pi}{2}(0.025)^4 = 0.61359(10^{-6}) \text{ m}^4$$

$$\sigma = \frac{P}{A} = \frac{2(10^3)}{1.9635(10^{-3})} = 1.019 \text{ MPa}$$

$$\tau = \frac{Tc}{J} = \frac{500(0.025)}{0.61359(10^{-6})} = 20.372 \text{ MPa}$$

$$\sigma_x = 0 \quad \sigma_y = -1.019 \text{ MPa} \quad \tau_{xy} = 20.372 \text{ MPa}$$

$$\sigma_{1,2} = \frac{\sigma_x + \sigma_y}{2} \pm \sqrt{\left(\frac{\sigma_x - \sigma_y}{2}\right)^2 + \tau_{xy}^2}$$

$$\sigma_{1,2} = \frac{0 - 1.018}{2} \pm \sqrt{\left(\frac{0 - (-1.019)}{2}\right)^2 + 20.372^2}$$

$$\sigma_1 = 19.87 \text{ MPa} \quad \sigma_2 = -20.89 \text{ MPa}$$

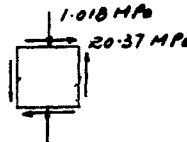

Failure criteria:

$$|\sigma_1| < \sigma_{ult} = 28 \text{ MPa} \quad \text{OK}$$

$$|\sigma_2| < \sigma_{ult} = 28 \text{ MPa} \quad \text{OK}$$

No. Ans

From *Mechanics of Materials*, Sixth Edition by R. C. Hibbeler, ISBN 0-13-191345-X.

© 2005 R. C. Hibbeler. Published by Pearson Prentice Hall,

Pearson Education, Inc., Upper Saddle River, NJ. All rights reserved.

This material is protected under all copyright laws as they currently exist. No portion of this material may be reproduced, in any form or by any means, without permission in writing from the publisher.

*10-97 If a solid shaft having a diameter d is subjected to a torque T and moment M , show that by the maximum-normal-stress theory the maximum allowable principal stress is $\sigma_{\text{allow}} = (16/\pi d^3)(M + \sqrt{M^2 + T^2})$.



Section properties :

$$I = \frac{\pi d^4}{64}; \quad J = \frac{\pi d^4}{32}$$

Stress components :

$$\sigma = \frac{M c}{I} = \frac{M (\frac{d}{2})}{\frac{\pi}{64} d^4} = \frac{32 M}{\pi d^3}; \quad \tau = \frac{T c}{J} = \frac{T (\frac{d}{2})}{\frac{\pi}{32} d^4} = \frac{16 T}{\pi d^3}$$

The principal stresses :

$$\begin{aligned} \sigma_{1,2} &= \frac{\sigma_x + \sigma_y}{2} \pm \sqrt{\left(\frac{\sigma_x - \sigma_y}{2}\right)^2 + \tau_{xy}^2} = \frac{\frac{32 M}{\pi d^3} + 0}{2} \pm \sqrt{\left(\frac{\frac{32 M}{\pi d^3} - 0}{2}\right)^2 + \left(\frac{16 T}{\pi d^3}\right)^2} \\ &= \frac{16 M}{\pi d^3} \pm \frac{16}{\pi d^3} \sqrt{M^2 + T^2} \end{aligned}$$

Maximum normal stress theory. Assume $\sigma_1 > \sigma_2$

$$\begin{aligned} \sigma_{\text{allow}} = \sigma_1 &= \frac{16 M}{\pi d^3} + \frac{16}{\pi d^3} \sqrt{M^2 + T^2} \\ &= \frac{16}{\pi d^3} [M + \sqrt{M^2 + T^2}] \quad \text{QED} \end{aligned}$$

From *Mechanics of Materials*, Sixth Edition by R. C. Hibbeler, ISBN 0-13-191345-X.

© 2005 R. C. Hibbeler. Published by Pearson Prentice Hall,

Pearson Education, Inc., Upper Saddle River, NJ. All rights reserved.

This material is protected under all copyright laws as they currently exist. No portion of this material may be reproduced, in any form or by any means, without permission in writing from the publisher.

10-98 Determine the bulk modulus for hard rubber if $E_r = 0.68(10^3)$ ksi, $\nu_r = 0.43$.

$$K_r = \frac{E_r}{3(1 - 2\nu_r)} = \frac{0.68(10^3)}{3[1 - 2(0.43)]} = 1.62(10^3) \text{ ksi} \quad \mathbf{Ans}$$

From *Mechanics of Materials*, Sixth Edition by R. C. Hibbeler, ISBN 0-13-191345-X.

© 2005 R. C. Hibbeler. Published by Pearson Prentice Hall,

Pearson Education, Inc., Upper Saddle River, NJ. All rights reserved.

This material is protected under all copyright laws as they currently exist. No portion of this material may be reproduced, in any form or by any means, without permission in writing from the publisher.

10-99 A thin-walled spherical pressure vessel has an inner radius r , thickness t , and is subjected to an internal pressure p . If the material constants are E and ν , determine the strain in the circumferential direction in terms of the stated parameters.

$$\sigma_1 = \sigma_2 = \frac{pr}{2t}$$

$$\varepsilon_1 = \varepsilon_2 = \varepsilon = \frac{1}{E}(\sigma - \nu\sigma)$$

$$\varepsilon = \frac{1-\nu}{E}\sigma = \frac{1-\nu}{E}\left(\frac{pr}{2t}\right) = \frac{pr}{2Et}(1-\nu) \quad \mathbf{Ans}$$

From *Mechanics of Materials*, Sixth Edition by R. C. Hibbeler, ISBN 0-13-191345-X.

© 2005 R. C. Hibbeler. Published by Pearson Prentice Hall,

Pearson Education, Inc., Upper Saddle River, NJ. All rights reserved.

This material is protected under all copyright laws as they currently exist. No portion of this material may be reproduced, in any form or by any means, without permission in writing from the publisher.

***10-100** The strain at point *A* on the shell has components $\epsilon_x = 250(10^{-6})$, $\epsilon_y = 400(10^{-6})$, $\gamma_{xy} = 275(10^{-6})$, $\epsilon_z = 0$. Determine (a) the principal strains at *A*, (b) the maximum shear strain in the *x-y* plane, and (c) the absolute maximum shear strain.

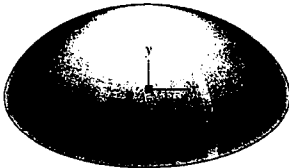

$$\epsilon_x = 250(10^{-6}) \quad \epsilon_y = 400(10^{-6}) \quad \gamma_{xy} = 275(10^{-6}) \quad \frac{\gamma_{xy}}{2} = 137.5(10^{-6})$$

$$A(250, 137.5)10^{-6} \quad C(325, 0)10^{-6}$$

$$R = \left(\sqrt{(325 - 250)^2 + (137.5)^2} \right) 10^{-6} = 156.62(10^{-6})$$

a)

$$\epsilon_1 = (325 + 156.62)10^{-6} = 482(10^{-6}) \quad \text{Ans}$$

$$\epsilon_2 = (325 - 156.62)10^{-6} = 168(10^{-6}) \quad \text{Ans}$$

b)

$$\gamma_{\text{max in-plane}} = 2R = 2(156.62)(10^{-6}) = 313(10^{-6}) \quad \text{Ans}$$

c)

$$\frac{\gamma_{\text{abs max}}}{2} = \frac{482(10^{-6})}{2}$$

$$\gamma_{\text{abs max}} = 482(10^{-6}) \quad \text{Ans}$$

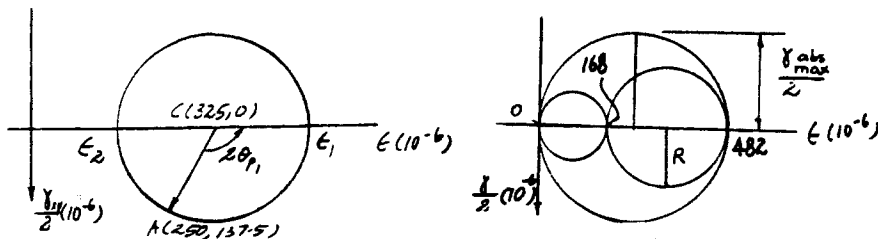

From *Mechanics of Materials*, Sixth Edition by R. C. Hibbeler, ISBN 0-13-191345-X.

© 2005 R. C. Hibbeler. Published by Pearson Prentice Hall,

Pearson Education, Inc., Upper Saddle River, NJ. All rights reserved.

This material is protected under all copyright laws as they currently exist. No portion of this material may be reproduced, in any form or by any means, without permission in writing from the publisher.

10-101 A differential element is subjected to plane strain that has the following components: $\epsilon_x = 950(10^{-6})$, $\epsilon_y = 420(10^{-6})$, $\gamma_{xy} = -325(10^{-6})$. Use the strain-transformation equations and determine (a) the principal strains and (b) the maximum in-plane shear strain and the associated average strain. In each case specify the orientation of the element and show how the strains deform the element.

$$\epsilon_{1,2} = \frac{\epsilon_x + \epsilon_y}{2} \pm \sqrt{\left(\frac{\epsilon_x - \epsilon_y}{2}\right)^2 + \gamma_{xy}^2}$$

$$= \left\{ \frac{950 + 420}{2} \pm \sqrt{\left(\frac{950 - 420}{2}\right)^2 + (-325)^2} \right\} (10^{-6})$$

$$\epsilon_1 = 996(10^{-6}) \quad \text{Ans} \quad \epsilon_2 = 374(10^{-6}) \quad \text{Ans}$$

Orientation of ϵ_1 and ϵ_2 :

$$\tan 2\theta_p = \frac{\gamma_{xy}}{\epsilon_x - \epsilon_y} = \frac{-325}{950 - 420}$$

$$\theta_p = -15.76^\circ, 74.24^\circ$$

Use Eq. 10-5 to determine the direction of ϵ_1 and ϵ_2 .

$$\epsilon_x' = \frac{\epsilon_x + \epsilon_y}{2} + \frac{\epsilon_x - \epsilon_y}{2} \cos 2\theta + \frac{\gamma_{xy}}{2} \sin 2\theta$$

$$\theta = \theta_p = -15.76^\circ$$

$$\epsilon_x' = \left\{ \frac{950 + 420}{2} + \frac{950 - 420}{2} \cos(-31.52^\circ) + \frac{(-325)}{2} \sin(-31.52^\circ) \right\} (10^{-6}) = 996(10^{-6})$$

$$\theta_{p_1} = -15.8^\circ \quad \text{Ans} \quad \theta_{p_2} = 74.2^\circ \quad \text{Ans}$$

b)

$$\frac{\gamma_{\text{max}}}{2} = \sqrt{\left(\frac{\epsilon_x - \epsilon_y}{2}\right)^2 + \left(\frac{\gamma_{xy}}{2}\right)^2}$$

$$\gamma_{\text{max}} = 2 \left[\sqrt{\left(\frac{950 - 420}{2}\right)^2 + \left(\frac{-325}{2}\right)^2} \right] (10^{-6}) = 622(10^{-6}) \quad \text{Ans}$$

$$\epsilon_{\text{avg}} = \frac{\epsilon_x + \epsilon_y}{2} = \left(\frac{950 + 420}{2}\right) (10^{-6}) = 685(10^{-6}) \quad \text{Ans}$$

Orientation of γ_{max} :

$$\tan 2\theta_s = \frac{-(\epsilon_x - \epsilon_y)}{\gamma_{xy}} = \frac{-(950 - 420)}{-325}$$

$$\theta_s = 29.2^\circ \text{ and } \theta_s = 119^\circ \quad \text{Ans}$$

Use Eq. 10-6 to determine the sign of γ_{max} :

$$\frac{\gamma_{x'y'}}{2} = -\frac{\epsilon_x - \epsilon_y}{2} \sin 2\theta + \frac{\gamma_{xy}}{2} \cos 2\theta$$

$$\theta = \theta_s = 29.2^\circ$$

$$\gamma_{x'y'} = 2 \left[\frac{-(950 - 420)}{2} \sin(58.4^\circ) + \frac{-325}{2} \cos(58.4^\circ) \right] (10^{-6})$$

$$\gamma_{x'y'} = -622(10^{-6})$$

From *Mechanics of Materials*, Sixth Edition by R. C. Hibbeler, ISBN 0-13-191345-X.

© 2005 R. C. Hibbeler. Published by Pearson Prentice Hall,

Pearson Education, Inc., Upper Saddle River, NJ. All rights reserved.

This material is protected under all copyright laws as they currently exist. No portion of this material may be reproduced, in any form or by any means, without permission in writing from the publisher.

10-102 The components of plane stress at a critical point on a thin steel shell are shown. Determine if failure (yielding) has occurred on the basis of the maximum-distortion-energy theory. The yield stress for the steel is $\sigma_Y = 650 \text{ MPa}$.

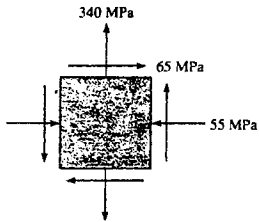

$$\sigma_x = -55 \text{ MPa} \quad \sigma_y = 340 \text{ MPa} \quad \tau_{xy} = 65 \text{ MPa}$$

$$\begin{aligned} \sigma_{1,2} &= \frac{\sigma_x + \sigma_y}{2} \pm \sqrt{\left(\frac{\sigma_x - \sigma_y}{2}\right)^2 + \tau_{xy}^2} \\ &= \frac{-55 + 340}{2} \pm \sqrt{\left(\frac{-55 - 340}{2}\right)^2 + 65^2} \end{aligned}$$

$$\sigma_1 = 350.42 \text{ MPa} \quad \sigma_2 = -65.42 \text{ MPa}$$

$$\begin{aligned} (\sigma_1^2 - \sigma_1 \sigma_2 + \sigma_2^2) &= [350.42^2 - 350.42(-65.42) + (-65.42)^2] \\ &= 150\,000 < \sigma_Y^2 = 422\,500 \quad \text{OK} \end{aligned}$$

No. **Ans**

From *Mechanics of Materials*, Sixth Edition by R. C. Hibbeler, ISBN 0-13-191345-X.

© 2005 R. C. Hibbeler. Published by Pearson Prentice Hall,

Pearson Education, Inc., Upper Saddle River, NJ. All rights reserved.

This material is protected under all copyright laws as they currently exist. No portion of this material may be reproduced, in any form or by any means, without permission in writing from the publisher.

10-103 Solve Prob. 10-102 using the maximum-shear-stress theory.

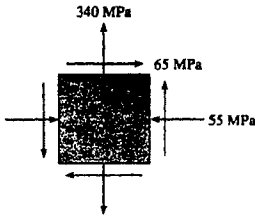

$$\sigma_x = -55 \text{ MPa} \quad \sigma_y = 340 \text{ MPa} \quad \tau_{xy} = 65 \text{ MPa}$$

$$\begin{aligned} \sigma_{1,2} &= \frac{\sigma_x + \sigma_y}{2} \pm \sqrt{\left(\frac{\sigma_x - \sigma_y}{2}\right)^2 + \tau_{xy}^2} \\ &= \frac{-55 + 340}{2} \pm \sqrt{\left(\frac{-55 - 340}{2}\right)^2 + 65^2} \end{aligned}$$

$$\sigma_1 = 350.42 \text{ MPa} \quad \sigma_2 = -65.42 \text{ MPa}$$

$$|\sigma_1 - \sigma_2| = 350.42 - (-65.42) = 415.84 \text{ MPa} < \sigma_y = 650 \text{ MPa} \quad \text{OK}$$

No. **Ans**

From *Mechanics of Materials*, Sixth Edition by R. C. Hibbeler, ISBN 0-13-191345-X.

© 2005 R. C. Hibbeler. Published by Pearson Prentice Hall,

Pearson Education, Inc., Upper Saddle River, NJ. All rights reserved.

This material is protected under all copyright laws as they currently exist. No portion of this material may be reproduced, in any form or by any means, without permission in writing from the publisher.

10-104 The state of strain at the point on the bracket has components $\epsilon_x = 350(10^{-6})$, $\epsilon_y = -860(10^{-6})$, $\gamma_{xy} = 250(10^{-6})$. Use the strain-transformation equations to determine the equivalent in-plane strains on an element oriented at an angle of $\theta = 45^\circ$ clockwise from the original position. Sketch the deformed element within the $x-y$ plane due to these strains.

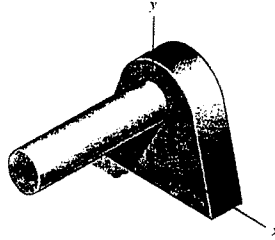

$$\epsilon_x = 350(10^{-6}) \quad \epsilon_y = -860(10^{-6}) \quad \gamma_{xy} = 250(10^{-6}) \quad \theta = -45^\circ$$

$$\begin{aligned} \epsilon_{x'} &= \frac{\epsilon_x + \epsilon_y}{2} + \frac{\epsilon_x - \epsilon_y}{2} \cos 2\theta + \frac{\gamma_{xy}}{2} \sin 2\theta \\ &= \left[\frac{350 - 860}{2} + \frac{350 - (-860)}{2} \cos(-90^\circ) + \frac{250}{2} \sin(-90^\circ) \right] (10^{-6}) = -380(10^{-6}) \quad \text{Ans} \end{aligned}$$

$$\begin{aligned} \epsilon_{y'} &= \frac{\epsilon_x + \epsilon_y}{2} - \frac{\epsilon_x - \epsilon_y}{2} \cos 2\theta - \frac{\gamma_{xy}}{2} \sin 2\theta \\ &= \left[\frac{350 - 860}{2} - \frac{350 - (-860)}{2} \cos(-90^\circ) - \frac{250}{2} \sin(-90^\circ) \right] (10^{-6}) = -130(10^{-6}) \quad \text{Ans} \end{aligned}$$

$$\frac{\gamma_{x'y'}}{2} = -\frac{\epsilon_x - \epsilon_y}{2} \sin 2\theta + \frac{\gamma_{xy}}{2} \cos 2\theta$$

$$\gamma_{x'y'} = 2 \left[-\left(\frac{350 - (-860)}{2} \right) \sin(-90^\circ) + \frac{250}{2} \cos(-90^\circ) \right] (10^{-6}) = 1.21(10^{-3}) \quad \text{Ans}$$

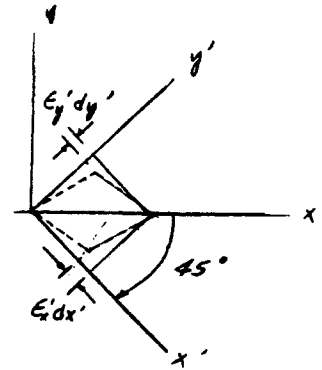

From *Mechanics of Materials*, Sixth Edition by R. C. Hibbeler, ISBN 0-13-191345-X.

© 2005 R. C. Hibbeler. Published by Pearson Prentice Hall,

Pearson Education, Inc., Upper Saddle River, NJ. All rights reserved.

This material is protected under all copyright laws as they currently exist. No portion of this material may be reproduced, in any form or by any means, without permission in writing from the publisher.

10-105 The aluminum beam has the rectangular cross section shown. If it is subjected to a bending moment of $M = 60 \text{ kip} \cdot \text{in.}$, determine the increase in the 2-in. dimension at the top of the beam and the decrease in this dimension at the bottom. $E_{al} = 10(10^3) \text{ ksi}$, $\nu_{al} = 0.3$.

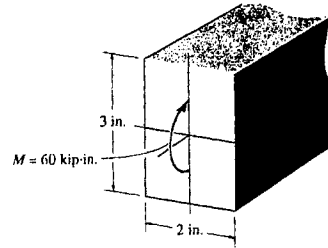

In general for the top or bottom of the beam :

$$\sigma_z = -\frac{M c}{I} = -\frac{M \frac{h}{2}}{\frac{1}{12} b h^3} = -\frac{6 M}{b h^2}$$

$$\epsilon_x = -\frac{\nu \sigma_z}{E} = \frac{6 \nu M}{E b h^2}$$

$$\begin{aligned} \Delta b &= \epsilon_x b = \frac{6 \nu M}{E b h^2} (b) \\ &= \frac{6 \nu M}{E h^2} \end{aligned}$$

At the top :

$$\Delta b = \frac{6(0.3)(60)}{10(10^3)(3^2)} = 1.2(10^{-3}) \text{ in.} \quad \text{Ans}$$

At the bottom :

$$\Delta b = -1.2(10^{-3}) \text{ in.} \quad \text{Ans}$$

The negative sign indicates shortening.

From *Mechanics of Materials*, Sixth Edition by R. C. Hibbeler, ISBN 0-13-191345-X.

© 2005 R. C. Hibbeler. Published by Pearson Prentice Hall,

Pearson Education, Inc., Upper Saddle River, NJ. All rights reserved.

This material is protected under all copyright laws as they currently exist. No portion of this material may be reproduced, in any form or by any means, without permission in writing from the publisher.

11-1 The simply supported beam is made of timber that has an allowable bending stress of $\sigma_{\text{allow}} = 6.5 \text{ MPa}$ and an allowable shear stress of $\tau_{\text{allow}} = 500 \text{ kPa}$. Determine its dimensions if it is to be rectangular and have a height-to-width ratio of 1.25.

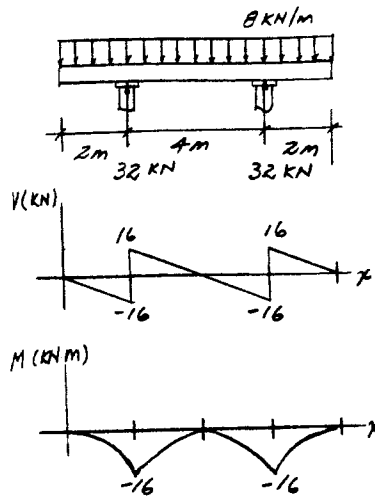
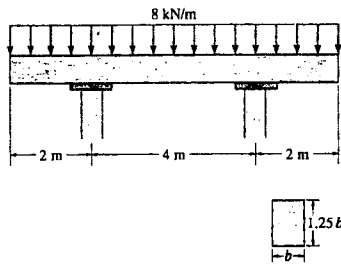

$$I_x = \frac{1}{12}(b)(1.25b)^3 = 0.16276b^4$$

$$Q_{\text{max}} = \bar{y}A' = (0.3125b)(0.625b)(b) = 0.1953125b^3$$

Assume bending moment controls :

$$M_{\text{max}} = 16 \text{ kN} \cdot \text{m}$$

$$\sigma_{\text{allow}} = \frac{M_{\text{max}} c}{I}$$

$$6.5(10^6) = \frac{16(10^3)(0.625b)}{0.16276b^4}$$

$$b = 0.21143 \text{ m} = 211 \text{ mm} \quad \text{Ans}$$

$$h = 1.25b = 264 \text{ mm} \quad \text{Ans}$$

Check shear :

$$Q_{\text{max}} = 1.846159(10^{-3}) \text{ m}^3$$

$$I = 0.325248(10^{-3}) \text{ m}^4$$

$$\tau_{\text{max}} = \frac{VQ_{\text{max}}}{It} = \frac{16(10^3)(1.846159)(10^{-3})}{0.325248(10^{-3})(0.21143)} = 429 \text{ kPa} < 500 \text{ kPa} \quad \text{OK}$$

From *Mechanics of Materials*, Sixth Edition by R. C. Hibbeler, ISBN 0-13-191345-X.

© 2005 R. C. Hibbeler. Published by Pearson Prentice Hall,

Pearson Education, Inc., Upper Saddle River, NJ. All rights reserved.

This material is protected under all copyright laws as they currently exist. No portion of this material may be reproduced, in any form or by any means, without permission in writing from the publisher.

11-2. The beam is made of Douglas fir having an allowable bending stress of $\sigma_{\text{allow}} = 1.1$ ksi and an allowable shear stress of $\tau_{\text{allow}} = 0.70$ ksi. Determine the width b of the beam if the height $h = 2b$.

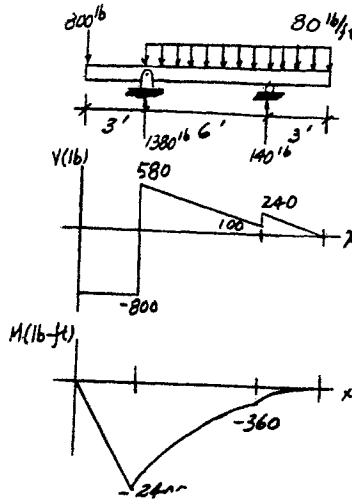
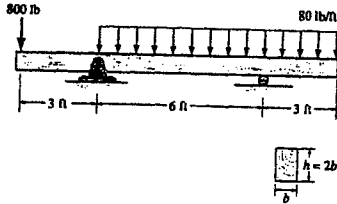

$$I_x = \frac{1}{12}(b)(2b)^3 = 0.6667 b^4$$

$$Q_{\text{max}} = \bar{y}A' = (0.5b)(b)(b) = 0.5b^3$$

Assume bending moment controls :

$$M_{\text{max}} = 2400 \text{ lb} \cdot \text{ft}$$

$$\sigma_{\text{allow}} = \frac{M_{\text{max}} c}{I}$$

$$1100 = \frac{2400(12)(b)}{0.6667b^4}$$

$$b = 3.40 \text{ in.} \quad \text{Ans}$$

Check shear :

$$Q_{\text{max}} = 19.65 \text{ in}^3$$

$$I = 89.09 \text{ in}^4$$

$$\tau_{\text{max}} = \frac{VQ_{\text{max}}}{It} = \frac{800(19.65)}{89.09(3.40)} = 51.9 \text{ psi} < 700 \text{ psi} \quad \text{OK}$$

From *Mechanics of Materials*, Sixth Edition by R. C. Hibbeler, ISBN 0-13-191345-X.

© 2005 R. C. Hibbeler. Published by Pearson Prentice Hall,

Pearson Education, Inc., Upper Saddle River, NJ. All rights reserved.

This material is protected under all copyright laws as they currently exist. No portion of this material may be reproduced, in any form or by any means, without permission in writing from the publisher.

11-3 The timber beam is to be loaded as shown. If the ends support only vertical forces, determine the greatest magnitude of P that can be applied. $\sigma_{\text{allow}} = 25 \text{ MPa}$, $\tau_{\text{allow}} = 700 \text{ kPa}$.

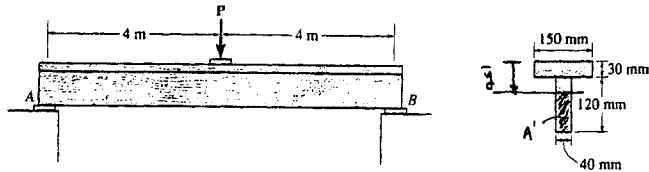

$$\bar{y} = \frac{(0.015)(0.150)(0.03) + (0.09)(0.04)(0.120)}{(0.150)(0.03) + (0.04)(0.120)} = 0.05371 \text{ m}$$

$$I = \frac{1}{12}(0.150)(0.03)^3 + (0.15)(0.03)(0.05371 - 0.015)^2 + \frac{1}{12}(0.04)(0.120)^3 + (0.04)(0.120)(0.09 - 0.05371)^2 = 19.162(10^{-6}) \text{ m}^4$$

Maximum moment at center of beam :

$$M_{\text{max}} = \frac{P}{2}(4) = 2P$$

$$\sigma = \frac{Mc}{I}; \quad 25(10^6) = \frac{(2P)(0.15 - 0.05371)}{19.162(10^{-6})}$$

$$P = 2.49 \text{ kN}$$

Maximum shear at end of beam :

$$V_{\text{max}} = \frac{P}{2}$$

$$\tau = \frac{VQ}{It}; \quad 700(10^3) = \frac{\left[\frac{1}{2}(0.15 - 0.05371)(0.04)(0.15 - 0.05371)\right]}{19.162(10^{-6})}$$

$$P = 145 \text{ kN}$$

Thus,

$$P = 2.49 \text{ kN} \quad \text{Ans}$$

From *Mechanics of Materials*, Sixth Edition by R. C. Hibbeler, ISBN 0-13-191345-X.

© 2005 R. C. Hibbeler. Published by Pearson Prentice Hall,

Pearson Education, Inc., Upper Saddle River, NJ. All rights reserved.

This material is protected under all copyright laws as they currently exist. No portion of this material may be reproduced, in any form or by any means, without permission in writing from the publisher.

*11-4 Draw the shear and moment diagrams for the shaft, and determine its required diameter to the nearest $\frac{1}{4}$ in. if $\sigma_{\text{allow}} = 7$ ksi and $\tau_{\text{allow}} = 3$ ksi. The bearings at A and D exert only vertical reactions on the shaft. The loading is applied to the pulleys at B , C , and E .

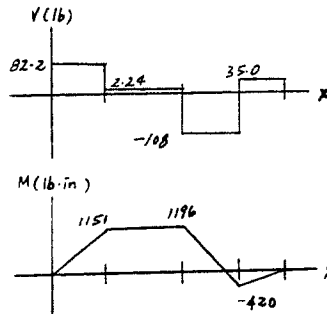
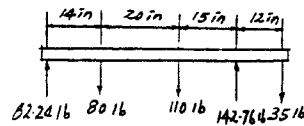
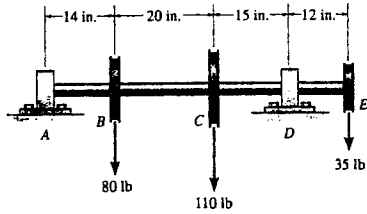

$$\sigma_{\text{allow}} = \frac{M_{\text{max}} c}{I}$$

$$7(10^3) = \frac{1196 c}{\frac{\pi}{4} c^4}; \quad c = 0.601 \text{ in.}$$

$$d = 2c = 1.20 \text{ in.}$$

Use $d = 1.25$ in. **Ans**

Check shear :

$$\tau_{\text{max}} = \frac{V_{\text{max}} Q}{I t} = \frac{108 \left(\frac{4(0.625)}{3\pi} \right) (\pi) \left(\frac{0.625^2}{2} \right)}{\frac{\pi}{4} (0.625)^4 (1.25)} = 117 \text{ psi} < 3 \text{ ksi} \quad \text{OK}$$

From *Mechanics of Materials*, Sixth Edition by R. C. Hibbeler, ISBN 0-13-191345-X.

© 2005 R. C. Hibbeler. Published by Pearson Prentice Hall,

Pearson Education, Inc., Upper Saddle River, NJ. All rights reserved.

This material is protected under all copyright laws as they currently exist. No portion of this material may be reproduced, in any form or by any means, without permission in writing from the publisher.

11-5 The simply supported beam is made of timber that has an allowable bending stress of $\sigma_{\text{allow}} = 960$ psi and an allowable shear stress of $\tau_{\text{allow}} = 75$ psi. Determine its dimensions if it is to be rectangular and have a height-to-width ratio of 1.25.

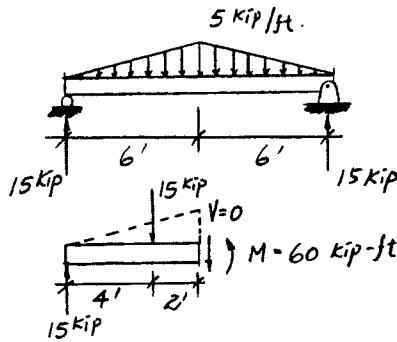
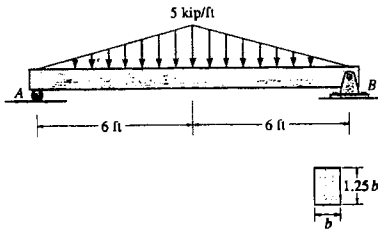

$$I = \frac{1}{12}(b)(1.25b)^3 = 0.16276b^4$$

$$S_{\text{req'd}} = \frac{I}{c} = \frac{0.16276b^4}{0.625b} = 0.26042b^3$$

Assume bending moment controls :

$$M_{\text{max}} = 60 \text{ kip} \cdot \text{ft}$$

$$\sigma_{\text{allow}} = \frac{M_{\text{max}}}{S_{\text{req'd}}}$$

$$960 = \frac{60(10^3)(12)}{0.26042 b^3}$$

$$b = 14.2 \text{ in.}$$

Check shear :

$$\tau_{\text{max}} = \frac{1.5V}{A} = \frac{1.5(15)(10^3)}{(14.2)(1.25)(14.2)} = 88.9 \text{ psi} > 75 \text{ psi} \quad \text{NG}$$

Shear controls :

$$\tau_{\text{allow}} = \frac{1.5V}{A} = \frac{1.5(15)(10^3)}{(b)(1.25b)}$$

$$b = 15.5 \text{ in.} \quad \text{Ans}$$

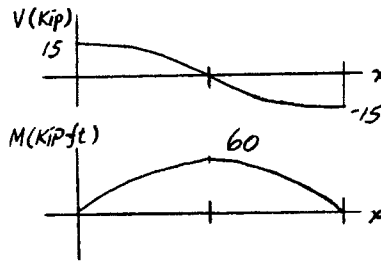

From *Mechanics of Materials*, Sixth Edition by R. C. Hibbeler, ISBN 0-13-191345-X.

© 2005 R. C. Hibbeler. Published by Pearson Prentice Hall,

Pearson Education, Inc., Upper Saddle River, NJ. All rights reserved.

This material is protected under all copyright laws as they currently exist. No portion of this material may be reproduced, in any form or by any means, without permission in writing from the publisher.

11-6. The spreader beam AB is used to lift slowly the 3000-lb pipe that is centrally located on the straps at C and D . If the beam is a $W 12 \times 45$, determine if it can safely support the load. The allowable bending stress is $\sigma_{\text{allow}} = 22 \text{ ksi}$ and the allowable shear stress is $\tau_{\text{allow}} = 12 \text{ ksi}$.

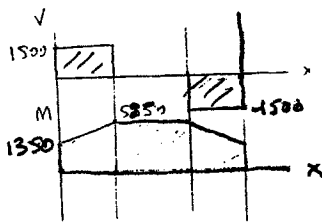
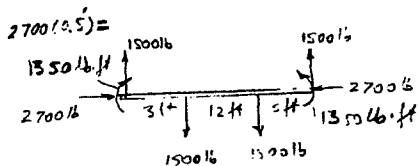
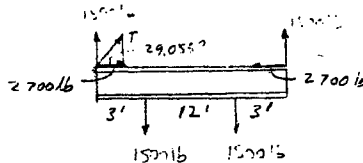
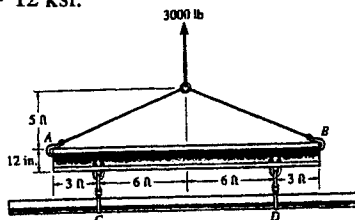

$$h = \frac{1500}{\tan 29.055^\circ} = 2700 \text{ lb}$$

$$\sigma = \frac{M}{S}; \quad \sigma = \frac{5850(12)}{58.1} = 1.21 \text{ ksi} < 22 \text{ ksi} \quad \text{OK}$$

$$\tau = \frac{V}{A_{web}}; \quad \tau = \frac{1500}{(12.06)(0.335)} = 371 \text{ psi} < 12 \text{ ksi} \quad \text{OK}$$

Yes. **Ans**

From *Mechanics of Materials*, Sixth Edition by R. C. Hibbeler, ISBN 0-13-191345-X.

© 2005 R. C. Hibbeler. Published by Pearson Prentice Hall,

Pearson Education, Inc., Upper Saddle River, NJ. All rights reserved.

This material is protected under all copyright laws as they currently exist. No portion of this material may be reproduced, in any form or by any means, without permission in writing from the publisher.

11-7 Select the lightest-weight steel wide-flange beam from Appendix B that will safely support the loading shown. The allowable bending stress is $\sigma_{\text{allow}} = 24$ ksi and the allowable shear stress is $\tau_{\text{allow}} = 14$ ksi.

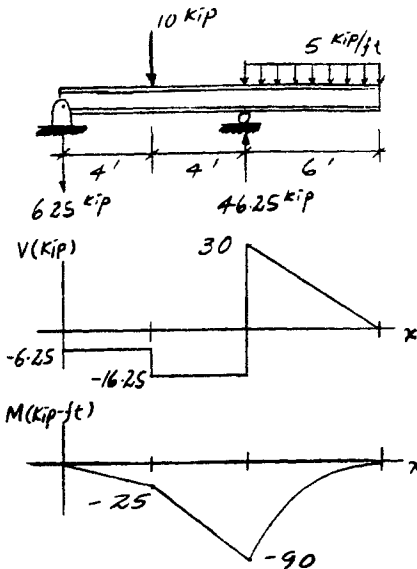
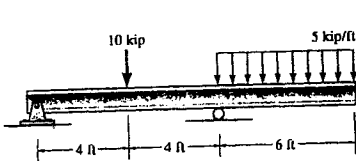

Assume bending moment controls.

$$M_{\text{max}} = 90 \text{ kip} \cdot \text{ft}$$

$$S_{\text{req'd}} = \frac{M_{\text{max}}}{\sigma_{\text{allow}}} = \frac{90(12)}{24} = 45 \text{ in}^3$$

Select a W 16 x 31

$$S_x = 47.5 \text{ in}^3 \quad d = 15.88 \text{ in.} \quad t_w = 0.275 \text{ in.}$$

Check shear :

$$\tau_{\text{max}} = \frac{V_{\text{max}}}{A_w} = \frac{30}{(15.88)(0.275)} = 6.87 \text{ ksi} < 14 \text{ ksi} \quad \text{OK}$$

Use W 16 x 31 **Ans**

From *Mechanics of Materials*, Sixth Edition by R. C. Hibbeler, ISBN 0-13-191345-X.

© 2005 R. C. Hibbeler. Published by Pearson Prentice Hall,

Pearson Education, Inc., Upper Saddle River, NJ. All rights reserved.

This material is protected under all copyright laws as they currently exist. No portion of this material may be reproduced, in any form or by any means, without permission in writing from the publisher.

***11-8.** The simply supported beam is composed of two W 12 × 22 sections built up as shown. Determine the maximum uniform loading w the beam will support if the allowable bending stress is $\sigma_{\text{allow}} = 22$ ksi and the allowable shear stress is $\tau_{\text{allow}} = 14$ ksi.

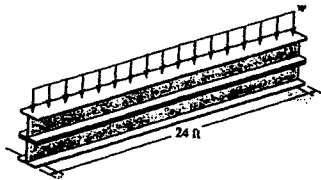

Section properties : For W 12 x 22 ($d = 12.31$ in. $I_x = 156$ in⁴ $t_w = 0.260$ in. $A = 6.48$ in²)

$$I = 2[156 + 6.48(\frac{12.31}{2})^2] = 802.98 \text{ in}^4$$

$$S = \frac{I}{c} = \frac{802.98}{12.31} = 65.23 \text{ in}^3$$

Maximum Loading : Assume moment controls.

$$M = \sigma_{\text{allow}} S$$

$$(72w)(12) = 22(65.23)$$

$$w = 1.66 \text{ kip / ft} \quad \text{Ans}$$

Check Shear : (Neglect area of flanges.)

$$\tau_{\text{max}} = \frac{V_{\text{max}}}{A_w} = \frac{12(1.66)}{2(12.31)(0.26)} = 3.11 \text{ ksi} < \tau_{\text{allow}} = 14 \text{ ksi} \quad \text{OK}$$

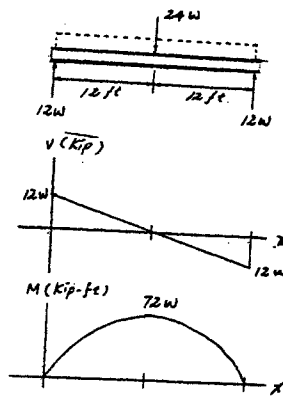

From *Mechanics of Materials*, Sixth Edition by R. C. Hibbeler, ISBN 0-13-191345-X.

© 2005 R. C. Hibbeler. Published by Pearson Prentice Hall,

Pearson Education, Inc., Upper Saddle River, NJ. All rights reserved.

This material is protected under all copyright laws as they currently exist. No portion of this material may be reproduced, in any form or by any means, without permission in writing from the publisher.

11-9. The simply supported beam is composed of two $W 12 \times 22$ sections built up as shown. Determine if the beam will safely support a loading of $w = 2$ kip/ft. The allowable bending stress is $\sigma_{\text{allow}} = 22$ ksi and the allowable shear stress is $\tau_{\text{allow}} = 14$ ksi.

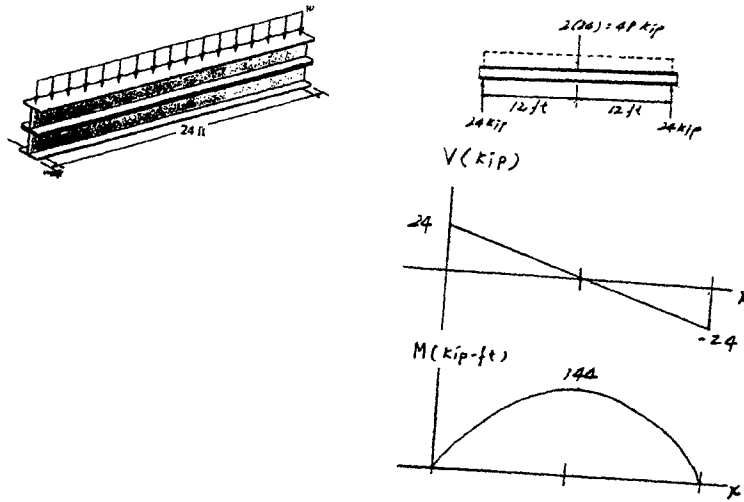

Section properties :

For $W 12 \times 22$ ($d = 12.31$ in. $I_x = 156$ in⁴ $t_w = 0.260$ in. $A = 6.48$ in²)

$$I = 2[156 + 6.48(6.155^2)] = 802.98 \text{ in}^4$$

$$S = \frac{I}{c} = \frac{802.98}{12.31} = 65.23 \text{ in}^3$$

Bending stress :

$$\sigma_{\text{max}} = \frac{M_{\text{allow}}}{S} = \frac{144(12)}{65.23} = 26.5 \text{ ksi} > \sigma_{\text{allow}} = 22 \text{ ksi}$$

No, the beam fails due to bending stress criteria

Ans

Check shear : (Neglect area of flanges.)

$$\tau_{\text{max}} = \frac{V_{\text{max}}}{A_w} = \frac{24}{2(12.31)(0.26)} = 3.75 \text{ ksi} < \tau_{\text{allow}} = 14 \text{ ksi} \text{ OK}$$

From *Mechanics of Materials*, Sixth Edition by R. C. Hibbeler, ISBN 0-13-191345-X.

© 2005 R. C. Hibbeler. Published by Pearson Prentice Hall,

Pearson Education, Inc., Upper Saddle River, NJ. All rights reserved.

This material is protected under all copyright laws as they currently exist. No portion of this material may be reproduced, in any form or by any means, without permission in writing from the publisher.

11-10 Determine the minimum width of the beam to the nearest $\frac{1}{4}$ in. that will safely support the loading of $P = 8$ kip. The allowable bending stress is $\sigma_{allow} = 24$ ksi and the allowable shear stress is $\tau_{allow} = 15$ ksi.

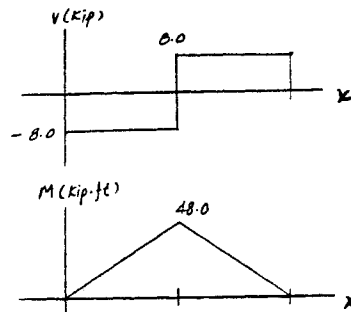
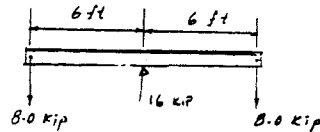
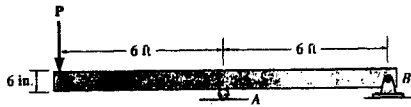

Beam design : Assume moment controls.

$$\sigma_{allow} = \frac{M c}{I}; \quad 24 = \frac{48.0(12)(3)}{\frac{1}{12}(b)(6^3)}$$

$$b = 4 \text{ in.} \quad \text{Ans}$$

Check shear :

$$\tau_{max} = \frac{VQ}{It} = \frac{8(1.5)(3)(4)}{\frac{1}{12}(4)(6)^3(4)} = 0.5 \text{ ksi} < 15 \text{ ksi} \quad \text{OK}$$

From *Mechanics of Materials*, Sixth Edition by R. C. Hibbeler, ISBN 0-13-191345-X.

© 2005 R. C. Hibbeler. Published by Pearson Prentice Hall,

Pearson Education, Inc., Upper Saddle River, NJ. All rights reserved.

This material is protected under all copyright laws as they currently exist. No portion of this material may be reproduced, in any form or by any means, without permission in writing from the publisher.

11-11 Solve Prob. 11-10 if $P = 10$ kip.

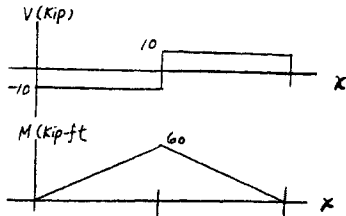
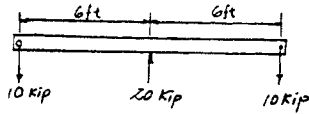
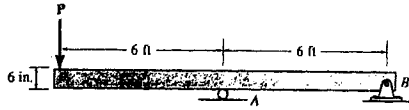

Beam design : Assume moment controls.

$$\sigma_{\text{allow}} = \frac{M c}{I}; \quad 24 = \frac{60(12)(3)}{\frac{1}{12}(b)(6^3)}$$

$$b = 5 \text{ in.} \quad \text{Ans}$$

Check shear :

$$\tau_{\text{max}} = \frac{VQ}{I t} = \frac{10(1.5)(3)(5)}{\frac{1}{12}(5)(6)^3(5)} = 0.5 \text{ ksi} < 15 \text{ ksi} \quad \text{OK}$$

From *Mechanics of Materials*, Sixth Edition by R. C. Hibbeler, ISBN 0-13-191345-X.

© 2005 R. C. Hibbeler. Published by Pearson Prentice Hall,

Pearson Education, Inc., Upper Saddle River, NJ. All rights reserved.

This material is protected under all copyright laws as they currently exist. No portion of this material may be reproduced, in any form or by any means, without permission in writing from the publisher.

***11-12.** Draw the shear and moment diagrams for the $W 12 \times 14$ beam and check if the beam will safely support the loading. Take $\sigma_{\text{allow}} = 22 \text{ ksi}$ and $\tau_{\text{allow}} = 12 \text{ ksi}$.

Bending Stress : From the moment diagram, $M_{\text{max}} = 50.0 \text{ kip} \cdot \text{ft}$.

Applying the flexure formula with $S = 14.9 \text{ in}^3$ for a wide-flange section $W12 \times 14$,

$$\begin{aligned}\sigma_{\text{max}} &= \frac{M_{\text{max}}}{S} \\ &= \frac{50.0(12)}{14.9} = 40.27 \text{ ksi} > \sigma_{\text{allow}} = 22 \text{ ksi} \text{ (No Good!)}\end{aligned}$$

Shear Stress : From the shear diagram, $V_{\text{max}} = 13.17 \text{ kip}$. Using

$\tau = \frac{V}{t_w d}$ where $d = 11.91 \text{ in.}$ and $t_w = 0.20 \text{ in.}$ for $W12 \times 14$ wide flange section.

$$\begin{aligned}\tau_{\text{max}} &= \frac{V_{\text{max}}}{t_w d} \\ &= \frac{13.17}{0.20(11.91)} \\ &= 5.53 \text{ ksi} < \tau_{\text{allow}} = 12 \text{ ksi} \text{ (O.K.)}\end{aligned}$$

Hence, the wide flange section $W12 \times 14$ fails due to the bending stress and will not safely support the loading. **Ans**

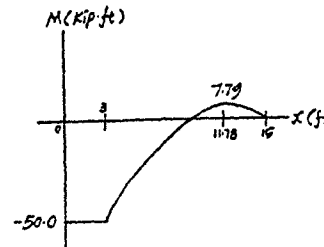
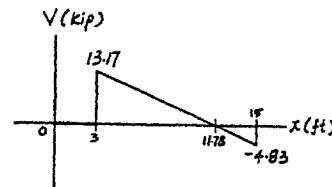
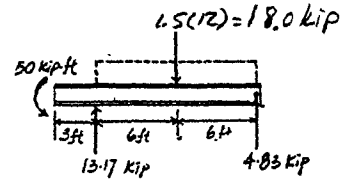

From *Mechanics of Materials*, Sixth Edition by R. C. Hibbeler, ISBN 0-13-191345-X.

© 2005 R. C. Hibbeler. Published by Pearson Prentice Hall,

Pearson Education, Inc., Upper Saddle River, NJ. All rights reserved.

This material is protected under all copyright laws as they currently exist. No portion of this material may be reproduced, in any form or by any means, without permission in writing from the publisher.

11-13. Select the lightest-weight steel wide-flange beam from Appendix B that will safely support the loading shown. The allowable bending stress is $\sigma_{\text{allow}} = 24$ ksi and the allowable shear stress is $\tau_{\text{allow}} = 14$ ksi.

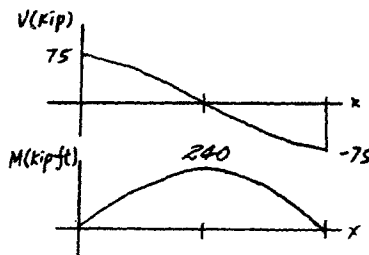
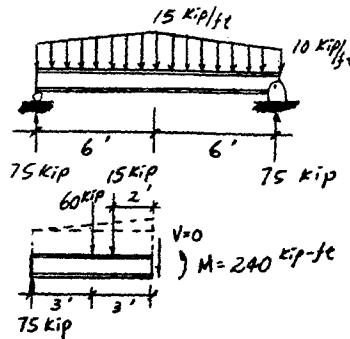
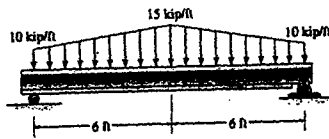

Assume bending controls.

$$M_{\text{max}} = 240 \text{ kip} \cdot \text{ft}$$

$$S_{\text{req'd}} = \frac{M_{\text{max}}}{\sigma_{\text{allow}}} = \frac{240(12)}{24} = 120 \text{ in}^3$$

Select a W 24 x 62,

$$S_x = 131 \text{ in}^3 \quad d = 23.74 \text{ in.} \quad t_w = 0.430 \text{ in.}$$

Check shear:

$$\tau_{\text{max}} = \frac{V_{\text{max}}}{A_w} = \frac{75}{(23.74)(0.430)} = 7.35 \text{ ksi} < 14 \text{ ksi}$$

Use W 24 x 62 **Ans**

From *Mechanics of Materials*, Sixth Edition by R. C. Hibbeler, ISBN 0-13-191345-X.

© 2005 R. C. Hibbeler. Published by Pearson Prentice Hall,

Pearson Education, Inc., Upper Saddle River, NJ. All rights reserved.

This material is protected under all copyright laws as they currently exist. No portion of this material may be reproduced, in any form or by any means, without permission in writing from the publisher.

11-14 The beam is used in a railroad yard for loading and unloading cars. If the maximum anticipated hoist load is 12 kip, select the lightest-weight steel wide-flange section from Appendix B that will safely support the loading. The hoist travels along the bottom flange of the beam, $1 \text{ ft} \leq x \leq 25 \text{ ft}$, and has negligible size. Assume the beam is pinned to the column at B and roller supported at A. The allowable bending stress is $\sigma_{\text{allow}} = 24 \text{ ksi}$ and the allowable shear stress is $\tau_{\text{allow}} = 12 \text{ ksi}$.

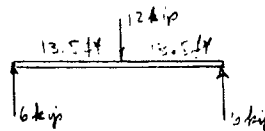
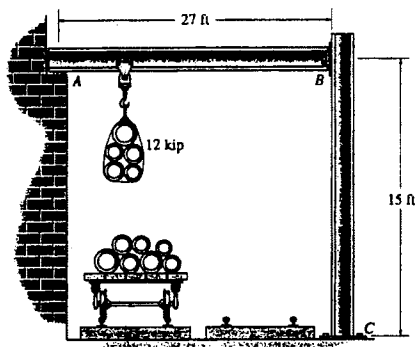

Maximum moment occurs when load is in the center of beam.

$$M_{\text{max}} = (6 \text{ kip})(13.5 \text{ ft}) = 81 \text{ lb} \cdot \text{ft}$$

$$\sigma_{\text{allow}} = \frac{M}{S}; \quad 24 = \frac{81(12)}{S_{\text{req'd}}}$$

$$S_{\text{req'd}} = 40.5 \text{ in}^3$$

Select a W 14 x 30, $S_x = 42.0 \text{ in}^3$, $d = 13.84 \text{ in}$, $t_w = 0.270 \text{ in}$.

$$\text{At } x = 1 \text{ ft, } V = 11.56 \text{ kip}$$

$$\tau = \frac{V}{A_{\text{web}}} = \frac{11.36}{(13.84)(0.270)} = 3.09 \text{ ksi} < 12 \text{ ksi}$$

Use W14 x 30 **Ans.**

From *Mechanics of Materials*, Sixth Edition by R. C. Hibbeler, ISBN 0-13-191345-X.

© 2005 R. C. Hibbeler. Published by Pearson Prentice Hall,

Pearson Education, Inc., Upper Saddle River, NJ. All rights reserved.

This material is protected under all copyright laws as they currently exist. No portion of this material may be reproduced, in any form or by any means, without permission in writing from the publisher.

11-15 Select the shortest and lightest-weight steel wide-flange beam from Appendix B that will safely support the loading shown. The allowable bending stress is $\sigma_{\text{allow}} = 22$ ksi and the allowable shear stress is $\tau_{\text{allow}} = 12$ ksi.

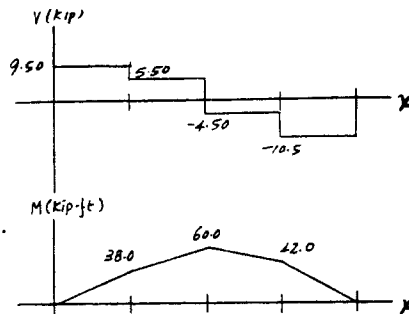
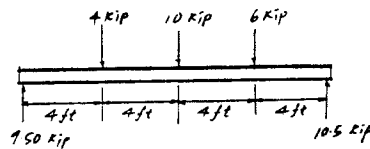
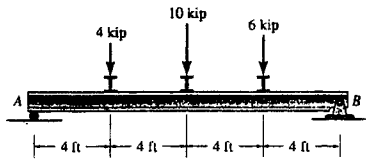

Beam design : Assume bending moment controls.

$$S_{\text{req'd}} = \frac{M_{\text{max}}}{\sigma_{\text{allow}}} = \frac{60.0(12)}{22} = 32.73 \text{ in}^3$$

Select a W 12 x 26

$$S_x = 33.4 \text{ in}^3, \quad d = 12.22 \text{ in.}, \quad t_w = 0.230 \text{ in.}$$

Check shear :

$$\tau_{\text{avg}} = \frac{V}{A_{\text{web}}} = \frac{10.5}{(12.22)(0.230)} = 3.74 \text{ ksi} < 12 \text{ ksi}$$

Use W 12 x 26 **Ans**

From *Mechanics of Materials*, Sixth Edition by R. C. Hibbeler, ISBN 0-13-191345-X.

© 2005 R. C. Hibbeler. Published by Pearson Prentice Hall,

Pearson Education, Inc., Upper Saddle River, NJ. All rights reserved.

This material is protected under all copyright laws as they currently exist. No portion of this material may be reproduced, in any form or by any means, without permission in writing from the publisher.

*11-16 Two acetyl plastic members are to be glued together and used to support the loading shown. If the allowable bending stress for the plastic is $\sigma_{\text{allow}} = 13$ ksi and the allowable shear stress is $\tau_{\text{allow}} = 4$ ksi, determine the greatest load P that can be supported and specify the required shear stress capacity of the glue.

$$M_{\text{max}} = P(5)(12) = 60P$$

$$V_{\text{max}} = P'$$

$$\bar{y} = \frac{\sum \bar{y}A}{\sum A} = \frac{3(6)(8) + 7.5(3)(3)}{(6)(8) + (3)(3)} = 3.7105 \text{ in.}$$

$$I = \frac{1}{12}(8)(6)^3 + 8(6)(3.7105 - 3)^2 + \frac{1}{12}(3)(3)^3 + 3(3)(7.5 - 3.7105)^2 = 304.22 \text{ in}^4$$

Bending :

$$\sigma = \frac{Mc}{I}; \quad 13 = \frac{60P(9 - 3.7105)}{304.22}$$

$$P = 12.462 = 12.5 \text{ kip}$$

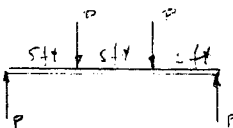

Shear :

$$\tau = \frac{VQ}{It}$$

At neutral axis :

$$4 = \frac{P(3.7105/2)(8)(3.7105)}{304.22(8)}, \quad P = 177 \text{ kip}$$

Also check just above glue seam.

$$4 = \frac{P(7.5 - 3.7105)(3)(3)}{304.22(3)}, \quad P = 107 \text{ kip}$$

Bending governs, thus

$$P = 12.5 \text{ kip} \quad \text{Ans}$$

Glue strength :

$$\tau = \frac{VQ}{It}; \quad \tau_{\text{req'd}} = \frac{12.462(7.5 - 3.7105)(3)(3)}{304.22(3)}$$

$$\tau_{\text{req'd}} = 466 \text{ psi} \quad \text{Ans}$$

From *Mechanics of Materials*, Sixth Edition by R. C. Hibbeler, ISBN 0-13-191345-X.

© 2005 R. C. Hibbeler. Published by Pearson Prentice Hall,

Pearson Education, Inc., Upper Saddle River, NJ. All rights reserved.

This material is protected under all copyright laws as they currently exist. No portion of this material may be reproduced, in any form or by any means, without permission in writing from the publisher.

11-17 The steel cantilevered T-beam is made from two plates welded together as shown. Determine the maximum loads P that can be safely supported on the beam if the allowable bending stress is $\sigma_{\text{allow}} = 170 \text{ MPa}$ and the allowable shear stress is $\tau_{\text{allow}} = 95 \text{ MPa}$.

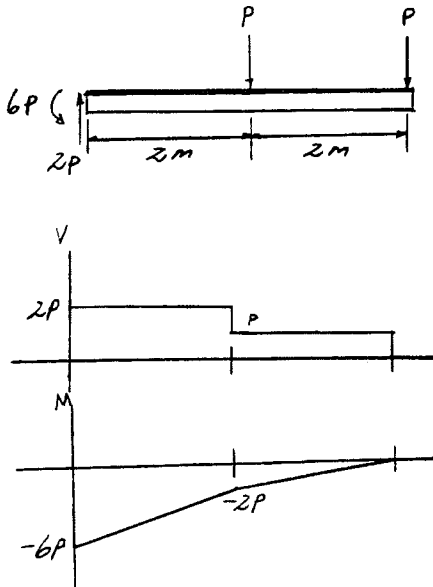
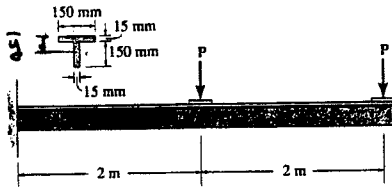

Section properties :

$$\bar{y} = \frac{\sum \bar{y}A}{\Sigma A} = \frac{0.0075(0.15)(0.015) + 0.09(0.15)(0.015)}{0.15(0.015) + 0.15(0.015)} = 0.04875 \text{ m}$$

$$I = \frac{1}{12}(0.15)(0.015)^3 + 0.15(0.015)(0.04875 - 0.0075)^2 + \frac{1}{12}(0.015)(0.15)^3 + 0.015(0.15)(0.09 - 0.04875)^2 = 11.9180(10^{-6}) \text{ m}^4$$

$$S = \frac{I}{c} = \frac{11.9180(10^{-6})}{(0.165 - 0.04875)} = 0.10252(10^{-3}) \text{ m}^3$$

$$Q_{\text{max}} = \bar{y}'A' = \left(\frac{0.165 - 0.04875}{2}\right)(0.165 - 0.04875)(0.015) = 0.101355(10^{-3}) \text{ m}^3$$

Maximum load : Assume failure due to bending moment.

$$M_{\text{max}} = \sigma_{\text{allow}} S; \quad 6P = 170(10^6)(0.10252)(10^{-3})$$

$$P = 2904.7 \text{ N} = 2.90 \text{ kN} \quad \text{Ans}$$

Check shear :

$$\tau_{\text{max}} = \frac{V_{\text{max}} Q_{\text{max}}}{I t} = \frac{2(2904.7)(0.101353)(10^{-3})}{11.9180(10^{-6})(0.015)} = 3.29 \text{ MPa} < \tau_{\text{allow}} = 95 \text{ MPa}$$

From *Mechanics of Materials*, Sixth Edition by R. C. Hibbeler, ISBN 0-13-191345-X.

© 2005 R. C. Hibbeler. Published by Pearson Prentice Hall,

Pearson Education, Inc., Upper Saddle River, NJ. All rights reserved.

This material is protected under all copyright laws as they currently exist. No portion of this material may be reproduced, in any form or by any means, without permission in writing from the publisher.

11-18 Determine if the steel cantilevered T-beam can safely support the two loads of $P = 3 \text{ kN}$ if the allowable bending stress is $\sigma_{\text{allow}} = 170 \text{ MPa}$ and the allowable shear stress is $\tau_{\text{allow}} = 95 \text{ MPa}$.

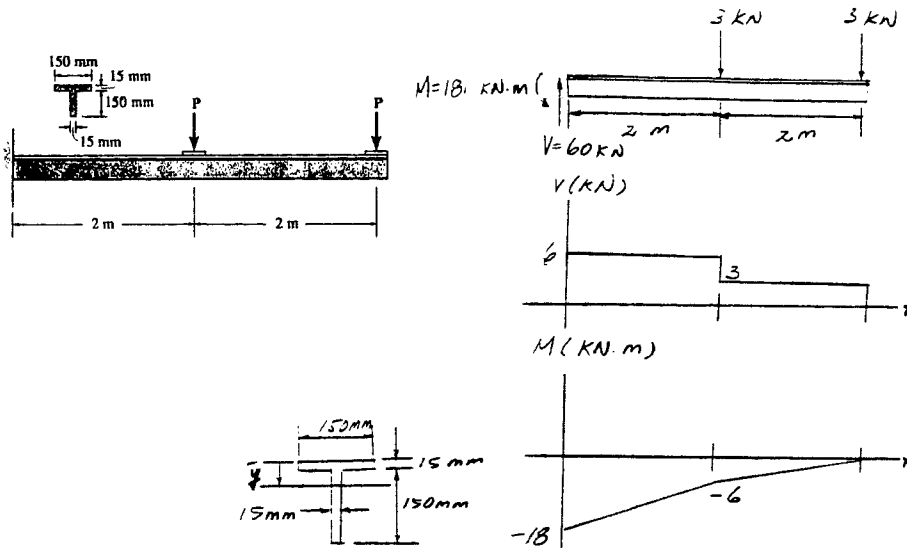

Maximum shear and moment are at support.

$$V_{\text{max}} = 3 + 3 = 6 \text{ kN} \quad M_{\text{max}} = 2(3) + 4(3) = 18 \text{ kN} \cdot \text{m}$$

Section properties :

$$\bar{y} = \frac{\sum \bar{y}A}{\sum A} = \frac{0.0075(0.15)(0.015) + 0.09(0.15)(0.015)}{0.15(0.015) + 0.15(0.015)} = 0.04875 \text{ m}$$

$$I = \frac{1}{12}(0.15)(0.015)^3 + 0.15(0.015)(0.04875 - 0.0075)^2 + \frac{1}{12}(0.015)(0.15)^3 + 0.015(0.15)(0.09 - 0.04875)^2 = 11.9180(10^{-6}) \text{ m}^4$$

$$S = \frac{I}{c} = \frac{11.9180(10^{-6})}{(0.165 - 0.04875)} = 0.10252(10^{-3}) \text{ m}^3$$

$$\sigma_{\text{max}} = \frac{M_{\text{max}}}{S} = \frac{18(10^3)}{0.10252(10^{-3})} = 176 \text{ MPa} > 170 \text{ MPa}$$

No. Ans

From *Mechanics of Materials*, Sixth Edition by R. C. Hibbeler, ISBN 0-13-191345-X.

© 2005 R. C. Hibbeler. Published by Pearson Prentice Hall,

Pearson Education, Inc., Upper Saddle River, NJ. All rights reserved.

This material is protected under all copyright laws as they currently exist. No portion of this material may be reproduced, in any form or by any means, without permission in writing from the publisher.

11-19. The simply supported beam supports a load of $P = 16 \text{ kN}$. Determine the smallest dimension a of each timber if the allowable bending stress for the wood is $\sigma_{\text{allow}} = 30 \text{ MPa}$ and the allowable shear stress is $\tau_{\text{allow}} = 800 \text{ kPa}$. Also, if each bolt can sustain a shear of 2.5

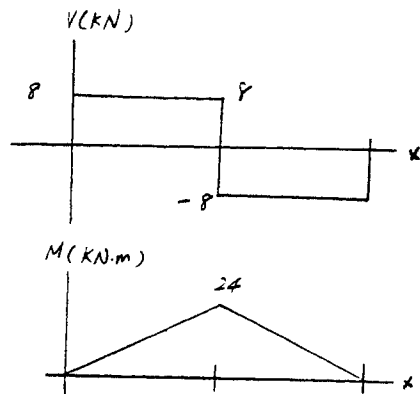
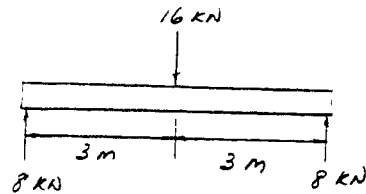
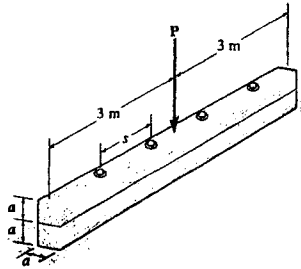

Section properties :

$$I = \frac{1}{12} (a)(2a)^3 = 0.66667 a^4$$

$$Q_{\text{max}} = \bar{y}' A' = \frac{a}{2} (a)(a) = 0.5 a^3$$

Assume bending controls.

$$\sigma_{\text{allow}} = \frac{M_{\text{max}} c}{I}; \quad 30(10^6) = \frac{24(10^3) a}{0.66667 a^4}$$

$$a = 0.106266 \text{ m} = 106 \text{ mm}$$

Ans

Check shear :

$$\tau_{\text{max}} = \frac{VQ}{It} = \frac{8(10^3)(0.106266/2)(0.106266)^2}{0.66667(0.106266^4)(0.106266)} = 531 \text{ kPa} < \tau_{\text{allow}} = 800 \text{ kPa} \quad \text{OK}$$

Bolt spacing :

$$q = \frac{VQ}{I} = \frac{8(10^3)(0.106266/2)(0.106266^2)}{0.66667 (0.106266^4)} = 56462.16 \text{ N/m}$$

$$s = \frac{2.5(10^3)}{56462.16} = 0.04427 \text{ m} = 44.3 \text{ mm} \quad \text{Ans}$$

From *Mechanics of Materials*, Sixth Edition by R. C. Hibbeler, ISBN 0-13-191345-X.

© 2005 R. C. Hibbeler. Published by Pearson Prentice Hall,

Pearson Education, Inc., Upper Saddle River, NJ. All rights reserved.

This material is protected under all copyright laws as they currently exist. No portion of this material may be reproduced, in any form or by any means, without permission in writing from the publisher.

*11-20 The beam is to be used to support the machine, which exerts the forces of 6 kip and 8 kip as shown. If the maximum bending stress is not to exceed $\sigma_{allow} = 22$ ksi, determine the required width b of the flanges.

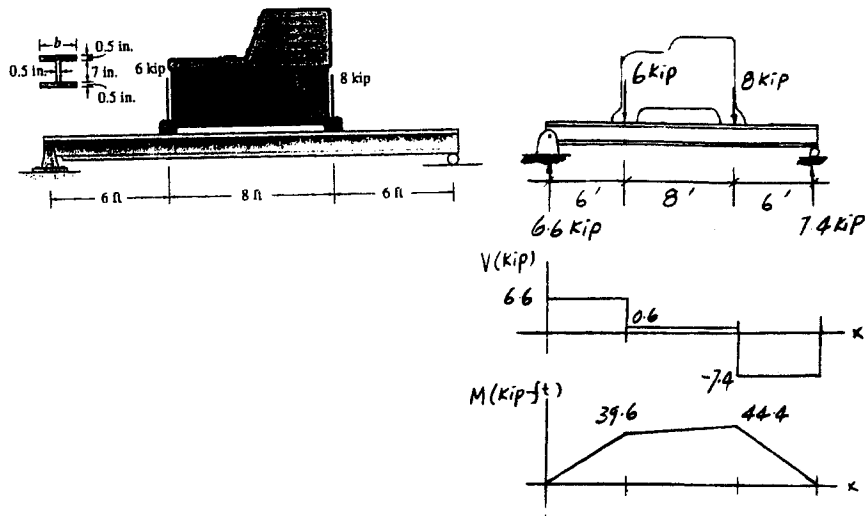

Section Properties :

$$I = \frac{1}{12}(b)(8^3) - \frac{1}{12}(b-0.5)(7^3) = 14.083b + 14.292$$

$$S = \frac{I}{c} = \frac{14.083b + 14.292}{4} = 3.5208b + 3.5729$$

$$S_{req'd} = \frac{M_{max}}{\sigma_{allow}}$$

$$3.5208b + 3.5729 = \frac{44.4(12)}{22}$$

$$b = 5.86 \text{ in.} \quad \text{Ans}$$

From *Mechanics of Materials*, Sixth Edition by R. C. Hibbeler, ISBN 0-13-191345-X.

© 2005 R. C. Hibbeler. Published by Pearson Prentice Hall,

Pearson Education, Inc., Upper Saddle River, NJ. All rights reserved.

This material is protected under all copyright laws as they currently exist. No portion of this material may be reproduced, in any form or by any means, without permission in writing from the publisher.

11-21 The steel beam has an allowable bending stress $\sigma_{\text{allow}} = 140 \text{ MPa}$ and an allowable shear stress of $\tau_{\text{allow}} = 90 \text{ MPa}$. Determine the maximum load that can safely be supported.

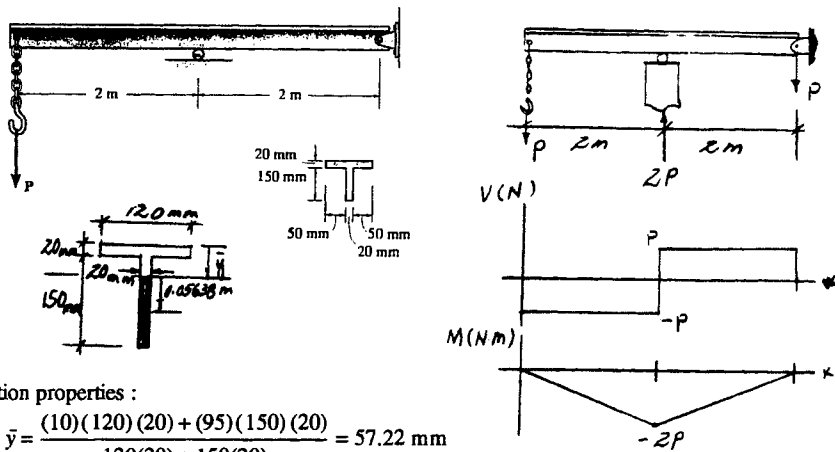

Section properties :

$$\bar{y} = \frac{(10)(120)(20) + (95)(150)(20)}{120(20) + 150(20)} = 57.22 \text{ mm}$$

$$Q_{\text{max}} = \bar{y}'A' = (0.05638)(0.02)(0.170 - 0.05722) = 0.127168(10^{-3})\text{m}^3$$

$$I = \frac{1}{12}(0.12)(0.02^3) + 0.12(0.02)(0.05722 - 0.01)^2 + \frac{1}{12}(0.02)(0.15^3) + 0.15(0.02)(0.095 - 0.05722)^2 = 15.3383(10^{-6}) \text{ m}^4$$

$$S = \frac{I}{c} = \frac{15.3383(10^{-6})}{(0.170 - 0.05722)} = 0.136005(10^{-3}) \text{ m}^3$$

For moment :

$$M = \sigma_{\text{allow}}S$$

$$2P = 140(10^6)(0.136005)(10^{-3})$$

$$P = 9520 \text{ N} = 9.52 \text{ kN} \quad (\text{Controls}) \quad \mathbf{Ans}$$

For shear :

$$V \leq \tau_{\text{allow}} \left(\frac{It}{Q_{\text{max}}} \right)$$

$$P = 90(10^6) \left(\frac{15.3383(10^{-6})(0.02)}{0.127168(10^{-3})} \right) = 217106 = 217 \text{ kN}$$

From *Mechanics of Materials*, Sixth Edition by R. C. Hibbeler, ISBN 0-13-191345-X.

© 2005 R. C. Hibbeler. Published by Pearson Prentice Hall,

Pearson Education, Inc., Upper Saddle River, NJ. All rights reserved.

This material is protected under all copyright laws as they currently exist. No portion of this material may be reproduced, in any form or by any means, without permission in writing from the publisher.

11-22 The timber beam has a rectangular cross section. If the width of the beam is 6 in., determine its height h so that it simultaneously reaches its allowable bending stress of $\sigma_{\text{allow}} = 1.50$ ksi and an allowable shear stress of $\tau_{\text{allow}} = 50$ psi. Also, what is the maximum load P that the beam can then support?

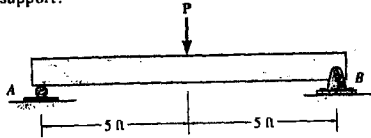

Section properties :

$$I = \frac{1}{12}(6)(h^3) = 0.5 h^3$$

$$S = \frac{I}{c} = \frac{0.5h^3}{0.5h} = h^2$$

$$Q_{\text{max}} = 0.25h(0.5h)(6) = 0.75 h^2$$

If shear controls :

$$\tau_{\text{allow}} = \frac{V_{\text{max}} Q_{\text{max}}}{I t} ; \quad 50 = \frac{(\frac{P}{2})(0.75h^2)}{0.5h^3(6)}$$

$$150h = 0.375 P \quad (1)$$

If bending controls :

$$\sigma_{\text{allow}} = \frac{M_{\text{max}}}{S}$$

$$S = \frac{I}{c} = \frac{0.5(h^3)}{\frac{h}{2}} = h^2$$

$$1.50(10^3) = \frac{2.5P(12)}{h^2}$$

$$1.50(10^3)h^2 = 30P \quad (2)$$

Solving Eqs. (1) and (2) yields :

$$h = 8.0 \text{ in.} \quad \text{Ans}$$

$$P = 3200 \text{ lb} \quad \text{Ans}$$

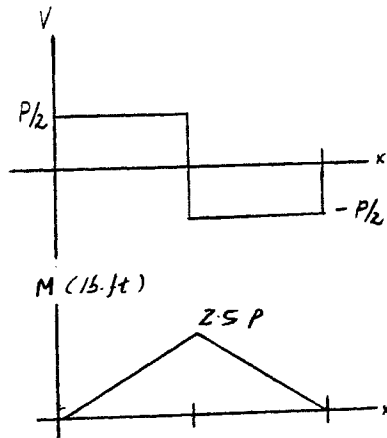
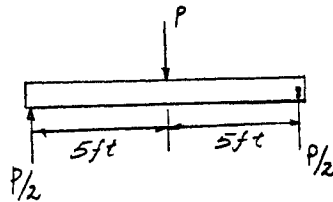

From *Mechanics of Materials*, Sixth Edition by R. C. Hibbeler, ISBN 0-13-191345-X.

© 2005 R. C. Hibbeler. Published by Pearson Prentice Hall,

Pearson Education, Inc., Upper Saddle River, NJ. All rights reserved.

This material is protected under all copyright laws as they currently exist. No portion of this material may be reproduced, in any form or by any means, without permission in writing from the publisher.

11-23 The beam is constructed from three plastic strips. If the glue can support a shear stress of $\tau_{\text{allow}} = 8 \text{ kPa}$, determine the largest magnitude of the loads P that can be applied to the beam.

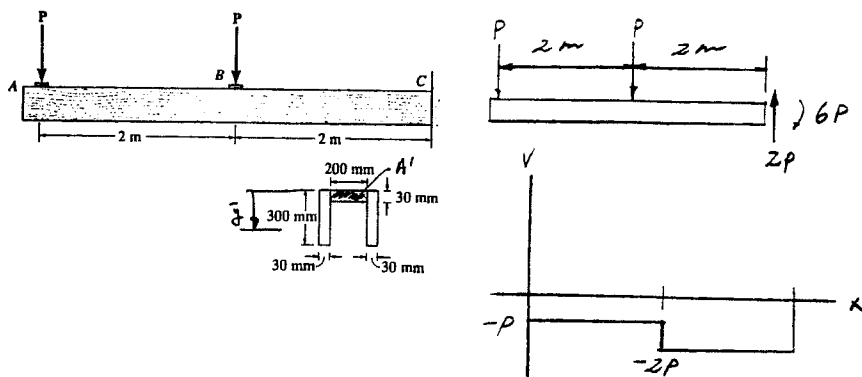

Section properties :

$$\bar{y} = \frac{\sum \bar{y}A}{\sum A} = \frac{0.015(0.2)(0.03) + 2[0.15(0.3)(0.03)]}{0.2(0.03) + 2(0.3)(0.03)} = 0.11625 \text{ m}$$

$$I = \frac{1}{12}(0.2)(0.03)^3 + 0.2(0.03)(0.11625 - 0.015)^2 + 2\left[\frac{1}{12}(0.03)(0.3)^3 + 0.03(0.3)(0.15 - 0.11625)^2\right]$$

$$= 0.2174625(10^{-3}) \text{ m}^4$$

$$Q_A = \bar{y}'A' = (0.11625 - 0.015)(0.2)(0.03) = 0.6075(10^{-3}) \text{ m}^3$$

Maximum load :

$$\tau_{\text{allow}} = \frac{V_{\text{max}} Q_A}{I t}; \quad 8000 = \frac{2P(0.6075)(10^{-3})}{0.2174625(10^{-3})(2)(0.03)}$$

$$P = 85.9 \text{ N} \quad \text{Ans}$$

From *Mechanics of Materials*, Sixth Edition by R. C. Hibbeler, ISBN 0-13-191345-X.

© 2005 R. C. Hibbeler. Published by Pearson Prentice Hall,

Pearson Education, Inc., Upper Saddle River, NJ. All rights reserved.

This material is protected under all copyright laws as they currently exist. No portion of this material may be reproduced, in any form or by any means, without permission in writing from the publisher.

*11-24 The beam is constructed from three wood boards. If the allowable bending stress is $\sigma_{\text{allow}} = 6 \text{ MPa}$, and the glue can support a shear stress of $\tau_{\text{allow}} = 8 \text{ kPa}$, determine the largest magnitude of the loads P that can be applied to the beam.

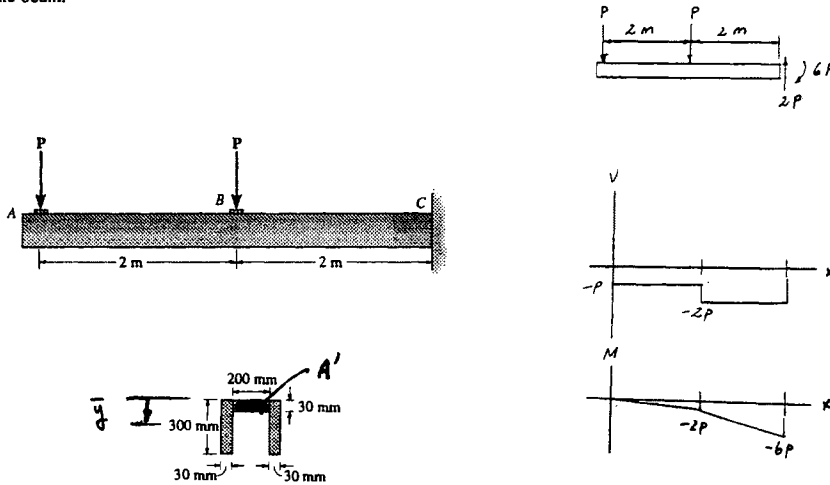

Section properties :

$$\bar{y} = \frac{\sum yA}{\sum A} = \frac{0.015(0.2)(0.03) + 2[0.15(0.3)(0.03)]}{0.2(0.03) + 2(0.3)(0.03)} = 0.1162 \text{ m}$$

$$I = \frac{1}{12}(0.2)(0.03)^3 + 0.2(0.03)(0.11625 - 0.015)^2 + 2\left[\frac{1}{12}(0.03)(0.3)^3 + 0.03(0.3)(0.15 - 0.11625)^2\right] = 0.2174625(10^{-3}) \text{ m}^4$$

Maximum load :

$$\sigma_{\text{allow}} = \frac{M_{\text{max}} c}{I}; \quad 6(10^6) = \frac{6P(0.3 - 0.11625)}{0.2174625(10^{-3})}$$

$$P = 1183 \text{ N} = 1.18 \text{ kN}$$

$$\text{Check glue: } Q_A = \bar{y}'A' = (0.11625 - 0.015)(0.2)(0.03) = 0.6075(10^{-3}) \text{ m}^3$$

$$\tau_{\text{allow}} = \frac{V_{\text{max}} Q_A}{I t}; \quad 8000 = \frac{2P(0.6075)(10^{-3})}{0.2174625(10^{-3})(2)(0.03)}$$

$$P = 85.9 \text{ N} \quad \text{Ans}$$

From *Mechanics of Materials*, Sixth Edition by R. C. Hibbeler, ISBN 0-13-191345-X.

© 2005 R. C. Hibbeler. Published by Pearson Prentice Hall,

Pearson Education, Inc., Upper Saddle River, NJ. All rights reserved.

This material is protected under all copyright laws as they currently exist. No portion of this material may be reproduced, in any form or by any means, without permission in writing from the publisher.

11-25 The beam is constructed from three boards as shown. If each nail can support a shear force of 300 N, determine the maximum spacing of the nails, s and s' , within regions AB and BC .

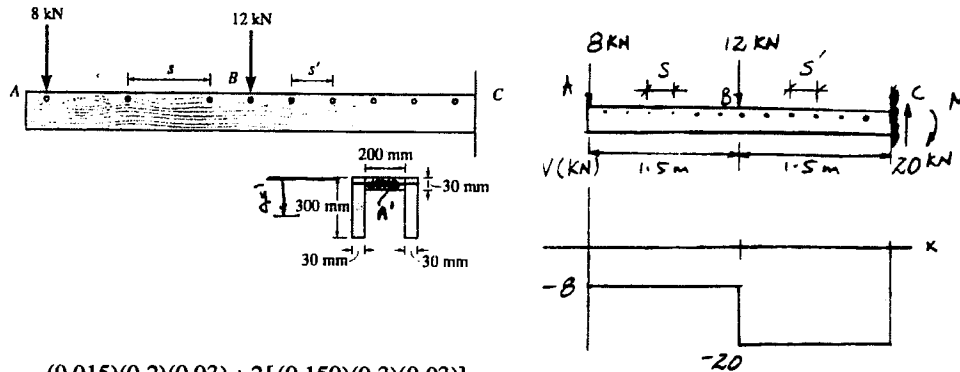

$$\bar{y} = \frac{(0.015)(0.2)(0.03) + 2[(0.150)(0.3)(0.03)]}{0.2(0.03) + 2(0.3)(0.03)} = 0.11625 \text{ m}$$

$$I = \frac{1}{12}(0.2)(0.03^3) + (0.2)(0.03)(0.11625 - 0.015)^2 + 2\left[\frac{1}{12}(0.03)(0.3^3) + (0.03)(0.3)(0.150 - 0.11625)^2\right] = 0.2174625(10^{-3})\text{m}^4$$

$$Q = \bar{y}'A' = (0.11625 - 0.015)(0.2)(0.03) = 0.6075(10^{-3}) \text{ m}^3$$

Region AB :

$$V = 8 \text{ kN}$$

$$q = \frac{VQ}{I} = \frac{8(10^3)(0.6075)(10^{-3})}{0.2174625(10^{-3})} = 22348.68 \text{ N/m}$$

$$s = \frac{300}{22348.68/2} = 0.0268 \text{ m} = 26.8 \text{ mm} \quad \text{Ans}$$

Region BC :

$$V = 20 \text{ kN}$$

$$q = \frac{VQ}{I} = \frac{20(10^3)(0.6075)(10^{-3})}{0.2174625(10^{-3})} = 55871.70 \text{ N}$$

$$s' = \frac{300}{55871.70/2} = 0.0107 \text{ m} = 10.7 \text{ mm} \quad \text{Ans}$$

From *Mechanics of Materials*, Sixth Edition by R. C. Hibbeler, ISBN 0-13-191345-X.

© 2005 R. C. Hibbeler. Published by Pearson Prentice Hall,

Pearson Education, Inc., Upper Saddle River, NJ. All rights reserved.

This material is protected under all copyright laws as they currently exist. No portion of this material may be reproduced, in any form or by any means, without permission in writing from the publisher.

11-26 The beam is constructed from three boards as shown. If each nail can support a shear force of 50 lb, determine the maximum spacing of the nails, s , s' , and s'' , for regions AB , BC , and CD , respectively.

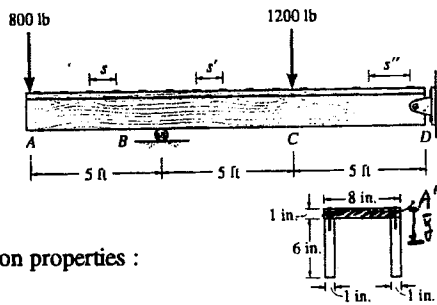

Section properties :

$$\bar{y} = \frac{(0.5)(8)(1) + 2[(4)(6)(1)]}{8(1) + 2[(6)(1)]} = 2.6 \text{ in.}$$

$$I = \frac{1}{12}(8)(1)^3 + 8(1)(2.6 - 0.5)^2 + 2\left(\frac{1}{12}\right)(1)(6)^3 + 2(1)(6)(4 - 2.6)^2 = 95.47 \text{ in}^4$$

$$Q = (2.6 - 0.5)(8)(1) = 16.8 \text{ in}^3$$

Region AB :

$$V = 800 \text{ lb} \quad q = \frac{VQ}{I} = \frac{800(16.8)}{95.47} = 140.8 \text{ lb/in.}$$

$$s = \frac{50}{140.8/2} = 0.710 \text{ in.} \quad \text{Ans}$$

Region BC :

$$V = 1000 \text{ lb}, \quad q = \frac{VQ}{I} = \frac{1000(16.8)}{95.47} = 176.0 \text{ lb/in.}$$

$$s' = \frac{50}{176.0/2} = 0.568 \text{ in.} \quad \text{Ans}$$

Region CD :

$$V = 200 \text{ lb} \quad q = \frac{VQ}{I} = \frac{200(16.8)}{95.47} = 35.2 \text{ lb/in.}$$

$$s'' = \frac{50}{35.2/2} = 2.84 \text{ in.} \quad \text{Ans}$$

From *Mechanics of Materials*, Sixth Edition by R. C. Hibbeler, ISBN 0-13-191345-X.

© 2005 R. C. Hibbeler. Published by Pearson Prentice Hall,

Pearson Education, Inc., Upper Saddle River, NJ. All rights reserved.

This material is protected under all copyright laws as they currently exist. No portion of this material may be reproduced, in any form or by any means, without permission in writing from the publisher.

11-27 The joist AB used in housing construction is to be made from 8-in. by 1.5-in. Southern-pine boards. If the design loading on each board is placed as shown, determine the largest room width L that the boards can span. The allowable bending stress for the wood is $\sigma_{\text{allow}} = 2$ ksi and the allowable shear stress is $\tau_{\text{allow}} = 180$ psi. Assume that the beam is simply supported from the walls at A and B .

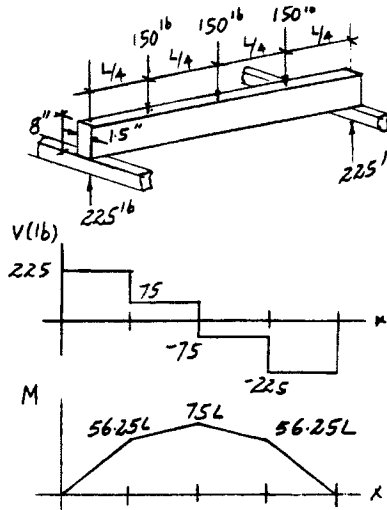
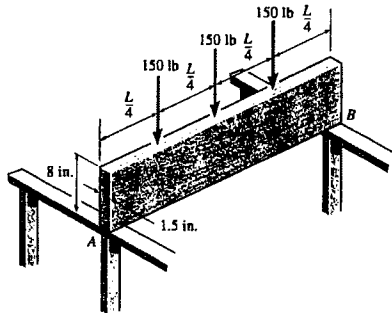

Check shear :

$$\tau_{\text{max}} = \frac{1.5V}{A} = \frac{1.5(225)}{(1.5)(8)} = 28.1 \text{ psi}$$

28.1 psi < 180 psi OK

For bending moment :

$$M_{\text{max}} = 75L$$

$$I = \frac{1}{12}(1.5)(8^3) = 64 \text{ in}^4$$

$$S = \frac{I}{c} = \frac{64}{4} = 16 \text{ in}^3$$

$$M_{\text{max}} = \sigma_{\text{allow}}S$$

$$75L(12) = 2000(16)$$

$$L = 35.6 \text{ ft} \quad \text{Ans}$$

From *Mechanics of Materials*, Sixth Edition by R. C. Hibbeler, ISBN 0-13-191345-X.

© 2005 R. C. Hibbeler. Published by Pearson Prentice Hall,

Pearson Education, Inc., Upper Saddle River, NJ. All rights reserved.

This material is protected under all copyright laws as they currently exist. No portion of this material may be reproduced, in any form or by any means, without permission in writing from the publisher.

***11-28.** The simply supported joist is used in the construction of a floor for a building. In order to keep the floor low with respect to the sill beams *C* and *D*, the ends of the joists are notched as shown. If the allowable shear stress for the wood is $\tau_{\text{allow}} = 350$ psi and the allowable bending stress is $\sigma_{\text{allow}} = 1500$ psi, determine the height *h* that will cause the beam to reach both allowable stresses at the same time. Also, what load *P* causes this to happen? Neglect the stress concentration at the notch.

Bending Stress : From the moment diagram, $M_{\text{max}} = 7.50P$.
Applying the flexure formula,

$$\sigma_{\text{allow}} = \frac{M_{\text{max}} c}{I}$$

$$1500 = \frac{7.50P(12)(5)}{\frac{1}{12}(2)(10^3)}$$

$$P = 555.56 \text{ lb} = 556 \text{ lb} \quad \text{Ans}$$

Shear Stress : From the shear diagram, $V_{\text{max}} = 0.500P = 277.78$ lb.
The notch is the critical section. Using the shear formula for a rectangular section,

$$\tau_{\text{allow}} = \frac{3V_{\text{max}}}{2A}$$

$$350 = \frac{3(277.78)}{2(2)h}$$

$$h = 0.595 \text{ in.} \quad \text{Ans}$$

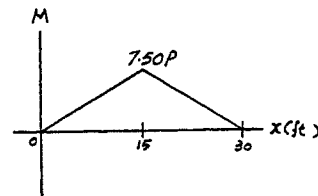
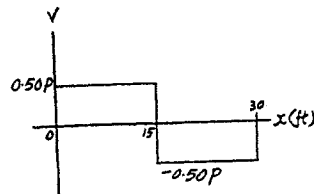
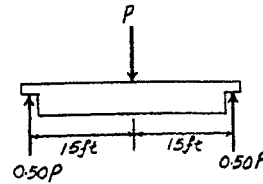

From *Mechanics of Materials*, Sixth Edition by R. C. Hibbeler, ISBN 0-13-191345-X.
© 2005 R. C. Hibbeler. Published by Pearson Prentice Hall,
Pearson Education, Inc., Upper Saddle River, NJ. All rights reserved.
This material is protected under all copyright laws as they currently exist. No portion of this material may be reproduced, in any form or by any means, without permission in writing from the publisher.

11-29 The simply supported joist is used in the construction of a floor for a building. In order to keep the floor low with respect to the sill beams *C* and *D*, the ends of the joists are notched as shown. If the allowable shear stress for the wood is $\tau_{\text{allow}} = 350$ psi and the allowable bending stress is $\sigma_{\text{allow}} = 1700$ psi, determine the smallest height h so that the beam will support a load of $P = 600$ lb. Also, will the entire joist safely support the load? Neglect the stress concentration at the notch.

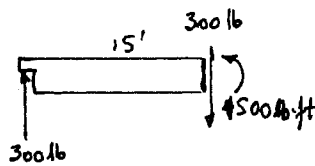
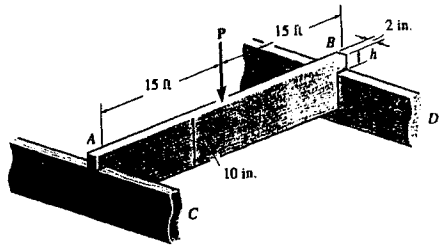

The reaction at the support is $\frac{600}{2} = 300$ lb

$$\tau_{\text{allow}} = \frac{1.5V}{A}; \quad 350 = \frac{1.5(300)}{(2)(h)}$$

$$h = 0.643 \text{ in.}$$

Ans

$$\sigma_{\text{max}} = \frac{M_{\text{max}} c}{I} = \frac{4500(12)(5)}{\frac{1}{12}(2)(10)^3} = 1620 \text{ psi} < 1700 \text{ psi} \quad \text{OK}$$

Yes, the joist will safely support the load. Ans

From *Mechanics of Materials*, Sixth Edition by R. C. Hibbeler, ISBN 0-13-191345-X.

© 2005 R. C. Hibbeler. Published by Pearson Prentice Hall,

Pearson Education, Inc., Upper Saddle River, NJ. All rights reserved.

This material is protected under all copyright laws as they currently exist. No portion of this material may be reproduced, in any form or by any means, without permission in writing from the publisher.

11-30 The overhang beam is constructed using two 2-in. by 4-in. pieces of wood braced as shown. If the allowable bending stress is $\sigma_{\text{allow}} = 600$ psi, determine the largest load P that can be applied. Also, determine the associated maximum spacing of nails, s , along the beam section AC if each nail can resist a shear force of 800 lb. Assume the beam is pin-connected at A , B , and D . Neglect the axial force developed in the beam along DA .

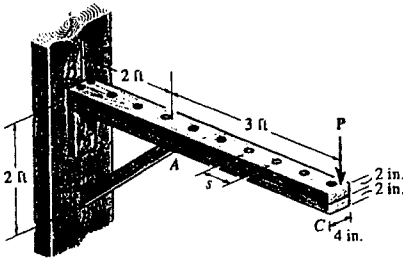

$$M_A = M_{\text{max}} = 3P$$

Section properties :

$$I = \frac{1}{12}(4)(4)^3 = 21.33 \text{ in}^4$$

$$S = \frac{I}{c} = \frac{21.33}{2} = 10.67 \text{ in}^3$$

$$M_{\text{max}} = \sigma_{\text{allow}} S$$

$$3P(12) = 600(10.67)$$

$$P = 177.78 = 178 \text{ lb} \quad \text{Ans}$$

Nail Spacing :

$$V = P = 177.78 \text{ lb}$$

$$Q = (4)(2)(1) = 8 \text{ in}^3$$

$$q = \frac{VQ}{I} = \frac{177.78(8)}{21.33} = 66.67 \text{ lb/in.}$$

$$S = \frac{800 \text{ lb}}{66.67 \text{ lb/in.}} = 12.0 \text{ in.} \quad \text{Ans}$$

From *Mechanics of Materials*, Sixth Edition by R. C. Hibbeler, ISBN 0-13-191345-X.

© 2005 R. C. Hibbeler. Published by Pearson Prentice Hall,

Pearson Education, Inc., Upper Saddle River, NJ. All rights reserved.

This material is protected under all copyright laws as they currently exist. No portion of this material may be reproduced, in any form or by any means, without permission in writing from the publisher.

11-31. Determine the variation in the width w as a function of x for the cantilevered beam that supports a concentrated force \mathbf{P} at its end so that it has a maximum bending stress σ_{allow} throughout its length. The beam has a constant thickness t .

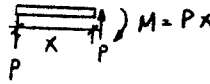
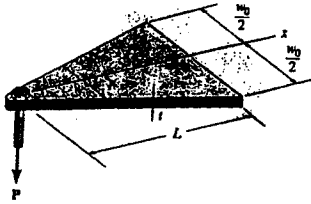

Section properties :

$$I = \frac{1}{12}(w)(t^3) \quad S = \frac{I}{c} = \frac{\frac{1}{12}(w)(t^3)}{t/2} = \frac{wt^2}{6}$$

$$\sigma_{\text{allow}} = \frac{M}{S} = \frac{Px}{wt^2/6} \quad (1)$$

At $x = L$,

$$\sigma_{\text{allow}} = \frac{PL}{w_0 t^2/6} \quad (2)$$

Equate Eqs (1) and (2),

$$\frac{Px}{wt^2/6} = \frac{PL}{w_0 t^2/6}$$

$$w = \frac{w_0}{L}x \quad \text{Ans}$$

From *Mechanics of Materials*, Sixth Edition by R. C. Hibbeler, ISBN 0-13-191345-X.

© 2005 R. C. Hibbeler. Published by Pearson Prentice Hall,

Pearson Education, Inc., Upper Saddle River, NJ. All rights reserved.

This material is protected under all copyright laws as they currently exist. No portion of this material may be reproduced, in any form or by any means, without permission in writing from the publisher.

***11-32.** Determine the variation in the depth of a cantilevered beam that supports a concentrated force \mathbf{P} at its end so that it has a constant maximum bending stress σ_{allow} throughout its length. The beam has a constant width b_0 .

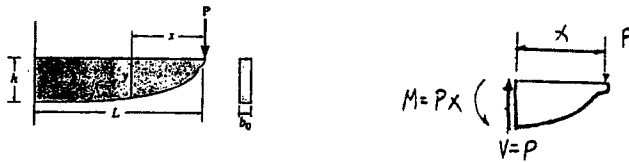

Section properties :

$$I = \frac{1}{12} b_0 d^3; \quad S = \frac{I}{c} = \frac{\frac{1}{12} b_0 d^3}{\frac{d}{2}} = \frac{b_0 d^2}{6}$$

Maximum bending stress :

$$\sigma_{\text{allow}} = \frac{M}{S} = \frac{Px}{\frac{b_0 d^2}{6}} = \frac{6Px}{b_0 d^2} \quad (1)$$

At $x = L$, $d = h$

$$\sigma_{\text{allow}} = \frac{6PL}{b_0 h^2} \quad (2)$$

Equating Eqs. (1) and (2),

$$\frac{6Px}{b_0 d^2} = \frac{6PL}{b_0 h^2}$$

$$d = h \sqrt{\frac{x}{L}} \quad \text{Ans}$$

From *Mechanics of Materials*, Sixth Edition by R. C. Hibbeler, ISBN 0-13-191345-X.

© 2005 R. C. Hibbeler. Published by Pearson Prentice Hall,

Pearson Education, Inc., Upper Saddle River, NJ. All rights reserved.

This material is protected under all copyright laws as they currently exist. No portion of this material may be reproduced, in any form or by any means, without permission in writing from the publisher.

11-33 Determine the variation in the depth d of a cantilevered beam that supports a concentrated force P at its end so that it has a constant maximum bending stress σ_{allow} throughout its length. The beam has a constant width b_0 .

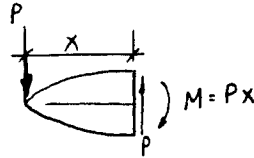
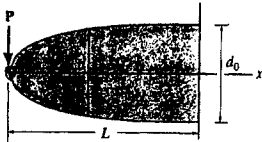

Section properties :

$$I = \frac{1}{12}(b_0)(d^3) \quad S = \frac{I}{c} = \frac{\frac{1}{12}(b_0)(d^3)}{d/2} = \frac{b_0 d^2}{6}$$

$$\sigma_{\text{allow}} = \frac{M}{S} = \frac{Px}{b_0 d^2/6} \quad (1)$$

At $x = L$

$$\sigma_{\text{allow}} = \frac{PL}{b_0 d_0^2/6} \quad (2)$$

Equate Eqs. (1) and (2) :

$$\frac{Px}{d_0^2/6} = \frac{PL}{b_0 d_0^2/6}$$

$$d^2 = \left(\frac{d_0^2}{L}\right)x; \quad d = d_0 \sqrt{\frac{x}{L}} \quad \text{Ans}$$

From *Mechanics of Materials*, Sixth Edition by R. C. Hibbeler, ISBN 0-13-191345-X.

© 2005 R. C. Hibbeler. Published by Pearson Prentice Hall,

Pearson Education, Inc., Upper Saddle River, NJ. All rights reserved.

This material is protected under all copyright laws as they currently exist. No portion of this material may be reproduced, in any form or by any means, without permission in writing from the publisher.

11-34. The beam is made from a plate having a constant thickness t and a width that varies as shown. If it supports a concentrated force P at its center, determine the absolute maximum bending stress in the beam and specify its location x , $0 < x < L/2$.

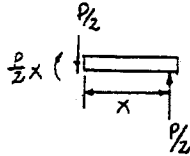
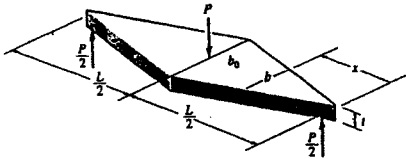

Section properties :

$$\frac{b}{b_0} = \frac{x}{L/2}; \quad b = \frac{2b_0}{L}x$$

$$I = \frac{1}{12} \left(\frac{2b_0}{L}x \right) t^3 = \frac{b_0 t^3}{6L}x$$

$$S = \frac{I}{c} = \frac{\frac{b_0 t^3}{6L}x}{\frac{t}{2}} = \frac{b_0 t^2}{3L}x$$

Bending stress :

$$\sigma = \frac{M}{S} = \frac{\frac{P}{2}x}{\frac{b_0 t^2}{3L}x} = \frac{3PL}{2b_0 t^2} \quad \text{Ans}$$

The bending stress is independent of x . Therefore, the stress is constant throughout the span. Ans

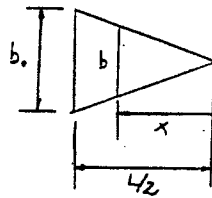

From *Mechanics of Materials*, Sixth Edition by R. C. Hibbeler, ISBN 0-13-191345-X.

© 2005 R. C. Hibbeler. Published by Pearson Prentice Hall,

Pearson Education, Inc., Upper Saddle River, NJ. All rights reserved.

This material is protected under all copyright laws as they currently exist. No portion of this material may be reproduced, in any form or by any means, without permission in writing from the publisher.

11-35 The tapered beam supports a uniform distributed load w . If it is made from a plate that has a constant width b_0 , determine the absolute maximum bending stress in the beam.

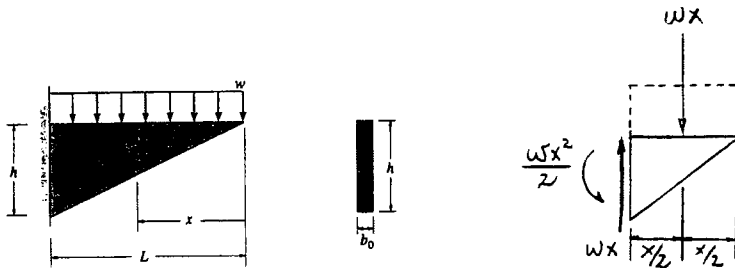

Section properties :

$$\frac{y}{h} = \frac{x}{L}; \quad y = \frac{h}{L}x$$

$$I = \frac{1}{12}(b_0)\left(\frac{h}{L}x\right)^3 = \frac{b_0 h^3}{12L^3}x^3$$

$$S = \frac{I}{c} = \frac{\frac{b_0 h^3}{12L^3}x^3}{\frac{h}{2L}x} = \frac{b_0 h^2}{6L^2}x^2$$

Bending stress :

$$\sigma_{\max} = \frac{M}{S} = \frac{\frac{w}{2}x^2}{\frac{b_0 h^2}{6L^2}x^2} = \frac{3wL^2}{b_0 h^2}$$

Ans

The bending stress is independent of x . Therefore, the stress is constant throughout the span. Ans

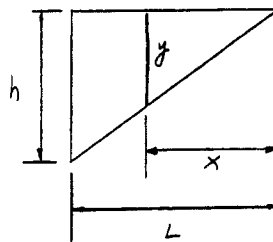

From *Mechanics of Materials*, Sixth Edition by R. C. Hibbeler, ISBN 0-13-191345-X.
 © 2005 R. C. Hibbeler. Published by Pearson Prentice Hall,
 Pearson Education, Inc., Upper Saddle River, NJ. All rights reserved.
 This material is protected under all copyright laws as they currently exist. No portion of this material may be reproduced, in any form or by any means, without permission in writing from the publisher.

*11-36 The tapered beam supports a uniform distributed load w . If it is made from a plate and has a constant width b , determine the absolute maximum bending stress in the beam.

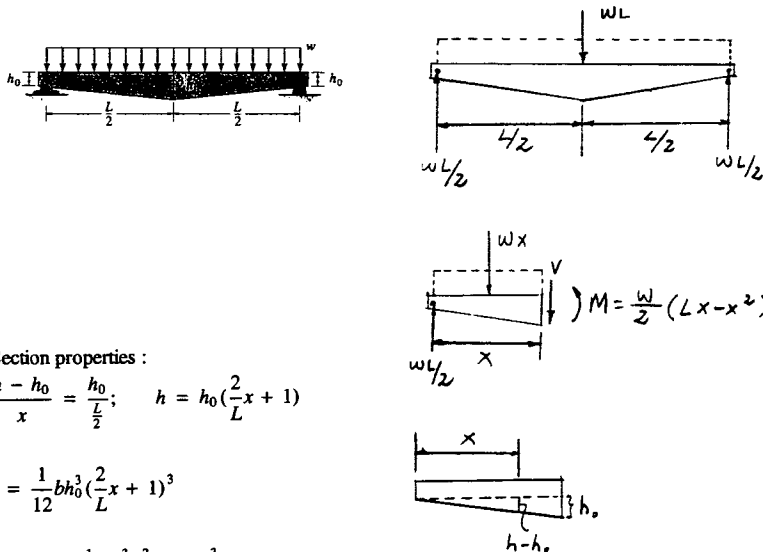

Section properties :

$$\frac{h - h_0}{x} = \frac{h_0}{\frac{L}{2}}; \quad h = h_0 \left(\frac{2}{L}x + 1 \right)$$

$$I = \frac{1}{12} b h_0^3 \left(\frac{2}{L}x + 1 \right)^3$$

$$S = \frac{I}{c} = \frac{\frac{1}{12} b h_0^3 \left(\frac{2}{L}x + 1 \right)^3}{\frac{h_0}{2} \left(\frac{2}{L}x + 1 \right)} = \frac{1}{6} b h_0^2 \left(\frac{2}{L}x + 1 \right)^2$$

Bending stress :

$$\sigma = \frac{M}{S} = \frac{\frac{w}{2} (Lx - x^2)}{\frac{1}{6} b h_0^2 \left(\frac{2}{L}x + 1 \right)^2} = \frac{3w}{b h_0^2} \left[\frac{Lx - x^2}{\left(\frac{2}{L}x + 1 \right)^2} \right] \quad (1)$$

$$\frac{d\sigma}{dx} = \frac{3w}{b h_0^2} \left[\frac{\left(\frac{2}{L}x + 1 \right)^2 (L - 2x) - (Lx - x^2) (2) \left(\frac{2}{L}x + 1 \right) \left(\frac{2}{L} \right)}{\left(\frac{2}{L}x + 1 \right)^4} \right] = 0$$

$$\left(\frac{2}{L}x + 1 \right) (L - 2x) - \frac{4}{L} (Lx - x^2) = 0; \quad x = \frac{L}{4}$$

Hence, from Eq. (1),

$$\sigma_{\max} = \frac{3w}{b h_0^2} \left[\frac{L \left(\frac{L}{4} \right) - \left(\frac{L}{4} \right)^2}{\left(\frac{2}{L} \left(\frac{L}{4} \right) + 1 \right)^2} \right] = \frac{w L^2}{4 b h_0^2} \quad \text{Ans}$$

From *Mechanics of Materials*, Sixth Edition by R. C. Hibbeler, ISBN 0-13-191345-X.

© 2005 R. C. Hibbeler. Published by Pearson Prentice Hall,

Pearson Education, Inc., Upper Saddle River, NJ. All rights reserved.

This material is protected under all copyright laws as they currently exist. No portion of this material may be reproduced, in any form or by any means, without permission in writing from the publisher.

11-37 Determine the variation in the width b as a function of x for the cantilevered beam that supports a uniform distributed load along its centerline so that it has the same maximum bending stress σ_{allow} throughout its length. The beam has a constant depth t .

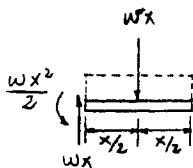
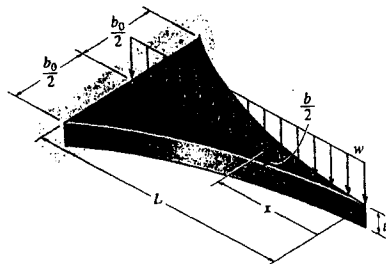

Section properties :

$$I = \frac{1}{12} b t^3 \quad S = \frac{I}{c} = \frac{\frac{1}{12} b t^3}{\frac{t}{2}} = \frac{t^2}{6} b$$

Bending stress :

$$\sigma_{\text{allow}} = \frac{M}{S} = \frac{\frac{w x^2}{2}}{\frac{t^2}{6} b} = \frac{3w x^2}{t^2 b} \quad (1)$$

At $x = L$, $b = b_0$

$$\sigma_{\text{allow}} = \frac{3w L^2}{t^2 b_0} \quad (2)$$

Equating Eqs. (1) and (2) yields :

$$\frac{3w x^2}{t^2 b} = \frac{3w L^2}{t^2 b_0}$$

$$b = \frac{b_0}{L^2} x^2 \quad \text{Ans}$$

From *Mechanics of Materials*, Sixth Edition by R. C. Hibbeler, ISBN 0-13-191345-X.

© 2005 R. C. Hibbeler. Published by Pearson Prentice Hall,

Pearson Education, Inc., Upper Saddle River, NJ. All rights reserved.

This material is protected under all copyright laws as they currently exist. No portion of this material may be reproduced, in any form or by any means, without permission in writing from the publisher.

11-38 The two pulleys attached to the shaft are loaded as shown. If the bearings at *A* and *B* exert only vertical forces on the shaft, determine the required diameter of the shaft to the nearest $\frac{1}{8}$ in. using the maximum-shear-stress theory. $\tau_{\text{allow}} = 12$ ksi.

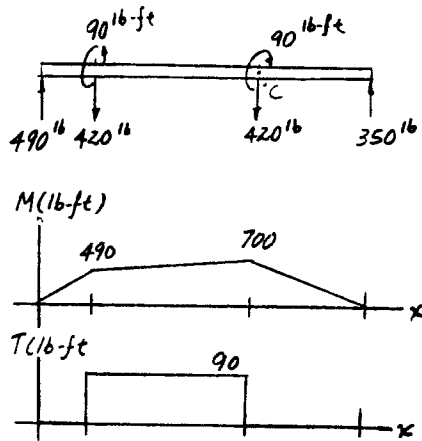
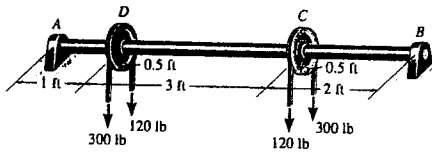

Section just to the left of point *C* is the most critical.

$$c = \left(\frac{2}{\pi \tau_{\text{allow}}} \sqrt{M^2 + T^2} \right)^{1/3} = \left(\frac{2}{\pi (12)(10^3)} \sqrt{[700(12)]^2 + [90(12)]^2} \right)^{1/3}$$

$$c = 0.766 \text{ in.}$$

$$d = 2c = 1.53 \text{ in.}$$

$$\text{Use } d = 1\frac{5}{8} \text{ in.} \quad \text{Ans}$$

From *Mechanics of Materials*, Sixth Edition by R. C. Hibbeler, ISBN 0-13-191345-X.

© 2005 R. C. Hibbeler. Published by Pearson Prentice Hall,

Pearson Education, Inc., Upper Saddle River, NJ. All rights reserved.

This material is protected under all copyright laws as they currently exist. No portion of this material may be reproduced, in any form or by any means, without permission in writing from the publisher.

11-39 Solve Prob. 11-38 using the maximum-distortion-energy theory. $\sigma_{\text{allow}} = 67$ ksi.

Section just to the left of point C is the most critical.

Both states of stress will yield the same result.

$$\sigma_{a,b} = \frac{\sigma}{2} \pm \sqrt{\left(\frac{\sigma}{2}\right)^2 + \tau^2}$$

Let $\frac{\sigma}{2} = A$ and $\sqrt{\left(\frac{\sigma}{2}\right)^2 + \tau^2} = B$

$$\sigma_a^2 = (A+B)^2 \quad \sigma_b^2 = (A-B)^2$$

$$\sigma_a \sigma_b = (A+B)(A-B)$$

$$\begin{aligned} \sigma_a^2 - \sigma_a \sigma_b + \sigma_b^2 &= A^2 + B^2 + 2AB - A^2 + B^2 + A^2 + B^2 - 2AB \\ &= A^2 + 3B^2 \\ &= \frac{\sigma^2}{4} + 3\left(\frac{\sigma^2}{4} + \tau^2\right) \\ &= \sigma^2 + 3\tau^2 \end{aligned}$$

$$\sigma_a^2 - \sigma_a \sigma_b + \sigma_b^2 = \sigma_{\text{allow}}^2$$

$$\sigma^2 + 3\tau^2 = \sigma_{\text{allow}}^2 \quad (1)$$

$$\sigma = \frac{Mc}{I} = \frac{Mc}{\frac{\pi}{4}c^4} = \frac{4M}{\pi c^3}$$

$$\tau = \frac{Tc}{J} = \frac{Tc}{\frac{\pi}{2}c^4} = \frac{2T}{\pi c^3}$$

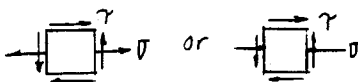
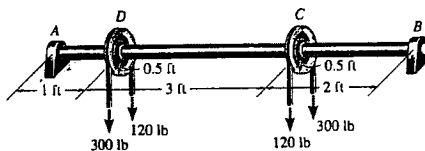

From Eq (1)

$$\frac{16M^2}{\pi^2 c^6} + \frac{12T^2}{\pi^2 c^6} = \sigma_{\text{allow}}^2$$

$$c = \left(\frac{16M^2 + 12T^2}{\pi^2 \sigma_{\text{allow}}^2}\right)^{1/6} = \left(\frac{16((700)(12))^2 + 12((90)(12))^2}{\pi^2 ((67)(10^3))^2}\right)^{1/6}$$

$$c = 0.544 \text{ in.}$$

$$d = 2c = 1.087 \text{ in.}$$

$$\text{Use } d = 1\frac{1}{8} \text{ in.} \quad \text{Ans}$$

From *Mechanics of Materials*, Sixth Edition by R. C. Hibbeler, ISBN 0-13-191345-X.

© 2005 R. C. Hibbeler. Published by Pearson Prentice Hall,

Pearson Education, Inc., Upper Saddle River, NJ. All rights reserved.

This material is protected under all copyright laws as they currently exist. No portion of this material may be reproduced, in any form or by any means, without permission in writing from the publisher.

***11-40.** The bearings at *A* and *D* exert only *y* and *z* components of force on the shaft. If $\tau_{\text{allow}} = 60 \text{ MPa}$, determine to the nearest millimeter the smallest-diameter shaft that will support the loading. Use the maximum-shear-stress theory of failure.

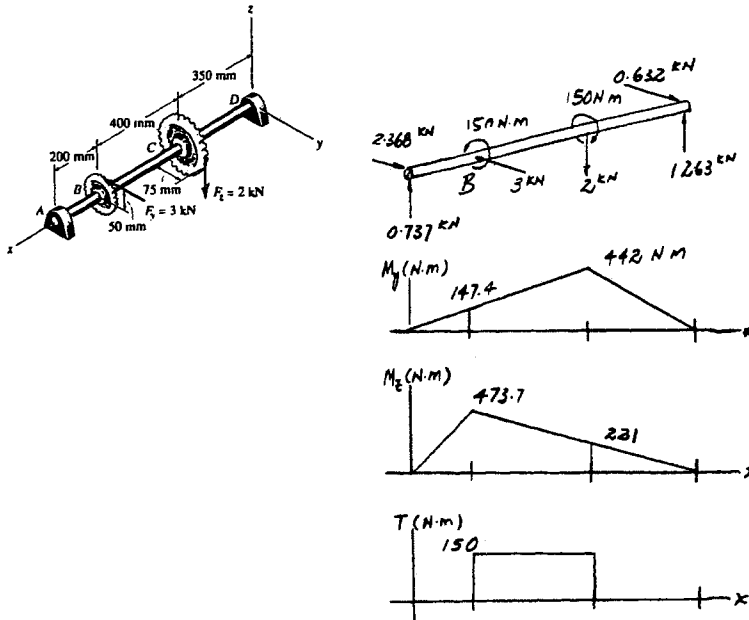

Critical moment is at point *B* :

$$M = \sqrt{(473.7)^2 + (147.4)^2} = 496.1 \text{ N} \cdot \text{m}$$

$$T = 150 \text{ N} \cdot \text{m}$$

$$c = \left(\frac{2}{\pi \tau_{\text{allow}}} \sqrt{M^2 + T^2} \right)^{1/3} = \left(\frac{2}{\pi(60)(10^6)} \sqrt{496.1^2 + 150^2} \right)^{1/3} = 0.0176 \text{ m}$$

$$c = 0.0176 \text{ m} = 17.6 \text{ mm}$$

$$d = 2c = 35.3 \text{ mm}$$

$$\text{Use } d = 36 \text{ mm} \quad \text{Ans}$$

From *Mechanics of Materials*, Sixth Edition by R. C. Hibbeler, ISBN 0-13-191345-X.

© 2005 R. C. Hibbeler. Published by Pearson Prentice Hall,

Pearson Education, Inc., Upper Saddle River, NJ. All rights reserved.

This material is protected under all copyright laws as they currently exist. No portion of this material may be reproduced, in any form or by any means, without permission in writing from the publisher.

11-41. Solve Prob. 11-40 using the maximum-distortion energy theory of failure. $\sigma_{\text{allow}} = 130 \text{ MPa}$.

The critical moment is at B.

$$M = \sqrt{(473.7)^2 + (147.4)^2} = 496.1 \text{ N}\cdot\text{m}$$

$$T = 150 \text{ N}\cdot\text{m}$$

Since,

$$\sigma_{x,y} = \frac{\sigma}{2} \pm \sqrt{\left(\frac{\sigma}{2}\right)^2 + \tau^2}$$

$$\text{Let } \frac{\sigma}{2} = A \quad \text{and} \quad \sqrt{\left(\frac{\sigma}{2}\right)^2 + \tau^2} = B$$

$$\sigma_x^2 = (A+B)^2 \quad \sigma_y^2 = (A-B)^2$$

$$\sigma_x \sigma_y = (A+B)(A-B)$$

$$\begin{aligned} \sigma_x^2 - \sigma_x \sigma_y + \sigma_y^2 &= A^2 + B^2 + 2AB - A^2 + B^2 + A^2 + B^2 - 2AB \\ &= A^2 + 3B^2 \\ &= \frac{\sigma^2}{4} + 3\left(\frac{\sigma^2}{4} + \tau^2\right) \\ &= \sigma^2 + 3\tau^2 \end{aligned}$$

$$\sigma_x^2 - \sigma_x \sigma_y + \sigma_y^2 = \sigma_{\text{allow}}^2$$

$$\sigma^2 + 3\tau^2 = \sigma_{\text{allow}}^2 \quad (1)$$

$$\sigma = \frac{Mc}{I} = \frac{Mc}{\frac{\pi}{2}c^4} = \frac{4M}{\pi c^3}$$

$$\tau = \frac{Tc}{J} = \frac{Tc}{\frac{\pi}{2}c^4} = \frac{2T}{\pi c^3}$$

From Eq (1)

$$\begin{aligned} \frac{16M^2}{\pi^2 c^6} + \frac{12T^2}{\pi^2 c^6} &= \sigma_{\text{allow}}^2 \\ c &= \left(\frac{16M^2 + 12T^2}{\pi^2 \sigma_{\text{allow}}^2}\right)^{1/6} \end{aligned}$$

$$= \left(\frac{16(496.1)^2 + 12(150)^2}{\pi^2 (130)(10^6)^2}\right)^{1/6} = 0.01712 \text{ m}$$

$$d = 2c = 34.3 \text{ mm} \quad \text{Ans}$$

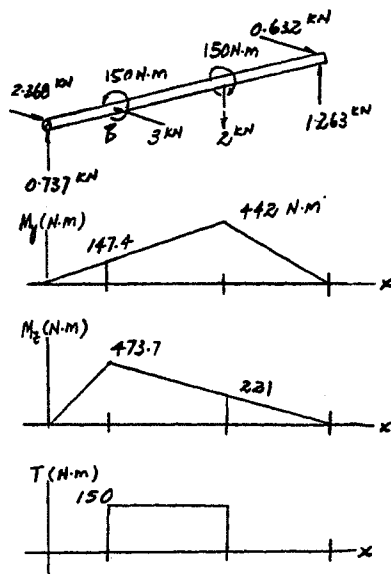
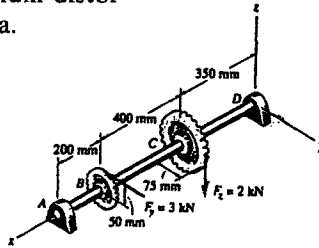

From *Mechanics of Materials*, Sixth Edition by R. C. Hibbeler, ISBN 0-13-191345-X.

© 2005 R. C. Hibbeler. Published by Pearson Prentice Hall,

Pearson Education, Inc., Upper Saddle River, NJ. All rights reserved.

This material is protected under all copyright laws as they currently exist. No portion of this material may be reproduced, in any form or by any means, without permission in writing from the publisher.

11-42 The pulleys attached to the shaft are loaded as shown. If the bearings at *A* and *B* exert only horizontal and vertical forces on the shaft, determine the required diameter of the shaft to the nearest $\frac{1}{8}$ in. using the maximum-shear-stress theory of failure. $\tau_{allow} = 12$ ksi.

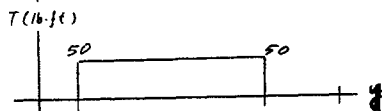
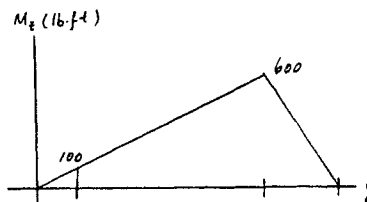
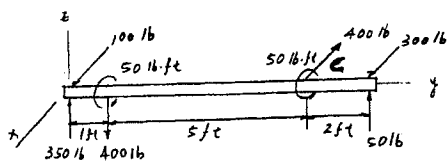
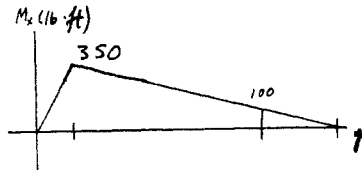
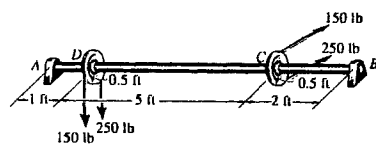

Section just to the left of point *C* is the most critical.

$$M = \sqrt{600^2 + 100^2} = 608.28 \text{ lb} \cdot \text{ft}$$

$$T = 50 \text{ lb} \cdot \text{ft}$$

$$c = \left[\frac{2}{\pi \tau_{allow}} \sqrt{M^2 + T^2} \right]^{\frac{1}{3}} = \left[\frac{2}{\pi(12)(10^3)} \sqrt{[(608.28)(12)]^2 + [50(12)]^2} \right]^{\frac{1}{3}}$$

$$c = 0.7297 \text{ in.}$$

$$d = 2c = 1.46 \text{ in.}$$

$$\text{Use } d = 1\frac{1}{2} \text{ in.} \quad \text{Ans}$$

From *Mechanics of Materials*, Sixth Edition by R. C. Hibbeler, ISBN 0-13-191345-X.

© 2005 R. C. Hibbeler. Published by Pearson Prentice Hall,

Pearson Education, Inc., Upper Saddle River, NJ. All rights reserved.

This material is protected under all copyright laws as they currently exist. No portion of this material may be reproduced, in any form or by any means, without permission in writing from the publisher.

11-43 Solve Prob. 11-42 using the maximum-distortion-energy theory of failure, $\sigma_{allow} = 20$ ksi.

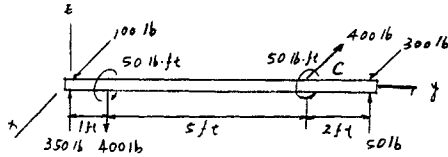
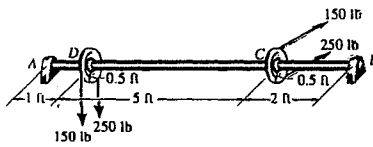

Section just to the left of point C is the most critical.

$$M = \sqrt{600^2 + 100^2} = 608.28 \text{ lb} \cdot \text{ft}$$

$$T = 50 \text{ lb} \cdot \text{ft}$$

Both states of stress will yield the same result.

$$\sigma_{\alpha\beta} = \frac{\sigma}{2} \pm \sqrt{\left(\frac{\sigma}{2}\right)^2 + \tau^2}$$

$$\text{Let } \frac{\sigma}{2} = A \text{ and } \sqrt{\frac{\sigma^2}{4} + \tau^2} = B$$

$$\sigma_a = (A + B)^2, \quad \sigma_b = (A - B)^2$$

$$\sigma_a \sigma_b = (A + B)(A - B) = A^2 - B^2$$

$$\begin{aligned} \sigma_a^2 - \sigma_a \sigma_b + \sigma_b^2 &= A^2 + B^2 + 2AB - A^2 + B^2 + A^2 + B^2 - 2AB \\ &= A^2 + 3B^2 = \frac{\sigma^2}{4} + 3\left(\frac{\sigma^2}{4} + \tau^2\right) = \sigma^2 + 3\tau^2 \end{aligned}$$

$$\sigma_a^2 - \sigma_a \sigma_b + \sigma_b^2 = \sigma_{allow}^2$$

$$\sigma^2 + 3\tau^2 = \sigma_{allow}^2 \quad (1)$$

$$\sigma = \frac{Mc}{I} = \frac{Mc}{\frac{\pi}{4}c^4} = \frac{4M}{\pi c^3}$$

$$\tau = \frac{Tc}{J} = \frac{Tc}{\frac{\pi}{2}c^4} = \frac{2T}{\pi c^3}$$

From Eq. (1)

$$\frac{16M^2}{\pi^2 c^6} + \frac{12T^2}{\pi^2 c^6} = \sigma_{allow}^2$$

$$c = \left[\frac{16M^2 + 12T^2}{\pi^2 \sigma_{allow}^2} \right]^{\frac{1}{2}}$$

$$c = \left(\frac{16[(608.28)(12)]^2 + 12[50(12)]^2}{\pi^2 [20(10^3)]^2} \right)^{\frac{1}{2}}$$

$$c = 0.7752 \text{ in.}; \quad d = 2c = 1.55 \text{ in.}$$

$$\text{Use } d = 1\frac{5}{8} \text{ in.} \quad \text{Ans}$$

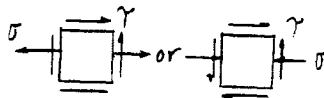
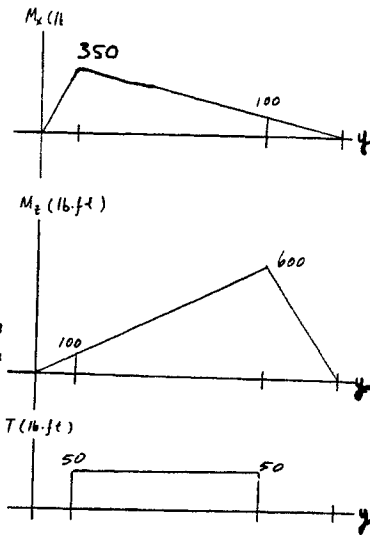

From *Mechanics of Materials*, Sixth Edition by R. C. Hibbeler, ISBN 0-13-191345-X.

© 2005 R. C. Hibbeler. Published by Pearson Prentice Hall,

Pearson Education, Inc., Upper Saddle River, NJ. All rights reserved.

This material is protected under all copyright laws as they currently exist. No portion of this material may be reproduced, in any form or by any means, without permission in writing from the publisher.

*11-44 The shaft is supported by bearings at *A* and *B* that exert force components only in the *x* and *z* directions on the shaft. If the allowable normal stress for the shaft is $\sigma_{allow} = 15$ ksi, determine to the nearest $\frac{1}{4}$ in. the smallest diameter of the shaft that will support the loading. Use the maximum distortion-energy theory of failure.

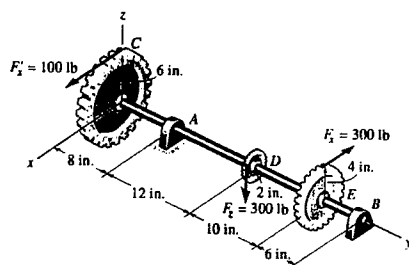

Critical moment is just to the right of *D*.

$$M = \sqrt{2057^2 + 1229^2} = 2396 \text{ lb} \cdot \text{in.}$$

$$T = 1200 \text{ lb} \cdot \text{in.}$$

Both states of stress will yield the same result.

$$\sigma_{a,b} = \frac{\sigma}{2} \pm \sqrt{\left(\frac{\sigma}{2}\right)^2 + \tau^2}$$

$$\text{Let } \frac{\sigma}{2} = A \text{ and } \sqrt{\frac{\sigma^2}{4} + \tau^2} = B$$

$$\sigma_a^2 = (A + B)^2, \quad \sigma_b^2 = (A - B)^2$$

$$\sigma_a \sigma_b = (A + B)(A - B) = A^2 - B^2$$

$$\begin{aligned} \sigma_a^2 - \sigma_a \sigma_b + \sigma_b^2 &= A^2 + B^2 + 2AB - A^2 + B^2 + A^2 + B^2 - 2AB \\ &= A^2 + 3B^2 = \frac{\sigma^2}{4} + 3\left(\frac{\sigma^2}{4} + \tau^2\right) = \sigma^2 + 3\tau^2 \end{aligned}$$

$$\sigma_a^2 - \sigma_a \sigma_b + \sigma_b^2 = \sigma_{allow}^2$$

$$\sigma^2 + 3\tau^2 = \sigma_{allow}^2 \quad (1)$$

$$\sigma = \frac{Mc}{I} = \frac{Mc}{\frac{\pi}{4}c^4} = \frac{4M}{\pi c^3}$$

$$\tau = \frac{Tc}{J} = \frac{Tc}{\frac{\pi}{2}c^4} = \frac{2T}{\pi c^3}$$

From Eq. (1)

$$\frac{16M^2}{\pi^2 c^6} + \frac{12T^2}{\pi^2 c^6} = \sigma_{allow}^2$$

$$c = \left[\frac{16M^2 + 12T^2}{\pi^2 \sigma_{allow}^2} \right]^{\frac{1}{6}}$$

$$c = \left(\frac{16M^2 + 12T^2}{\pi^2 \sigma_{allow}^2} \right)^{\frac{1}{6}} = \left[\frac{16(2396)^2 + 12(1200)^2}{\pi^2 ((15)(10^3))^2} \right]^{\frac{1}{6}} = 0.605 \text{ in.}$$

$$d = 2c = 1.210 \text{ in.}$$

$$\text{Use } d = 1\frac{1}{4} \text{ in.} \quad \text{Ans}$$

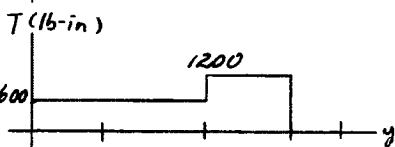
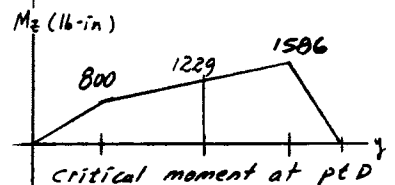
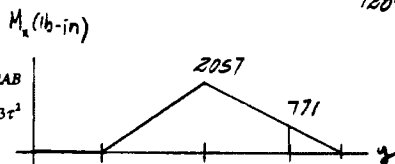
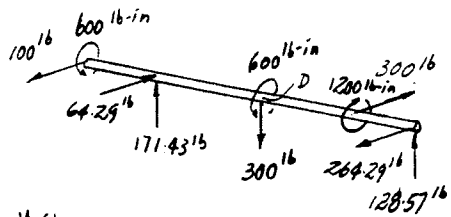

From *Mechanics of Materials*, Sixth Edition by R. C. Hibbeler, ISBN 0-13-191345-X.

© 2005 R. C. Hibbeler. Published by Pearson Prentice Hall,

Pearson Education, Inc., Upper Saddle River, NJ. All rights reserved.

This material is protected under all copyright laws as they currently exist. No portion of this material may be reproduced, in any form or by any means, without permission in writing from the publisher.

11-45 Solve Prob. 11-44 using the maximum-shear-stress theory of failure. Take $\tau_{allow} = 6$ ksi.

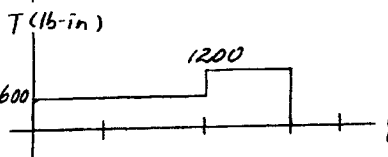
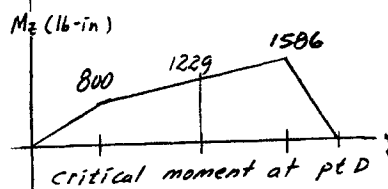
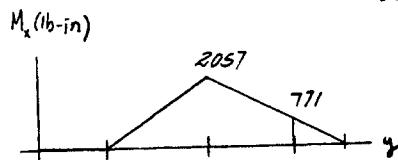
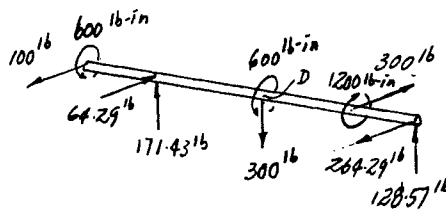
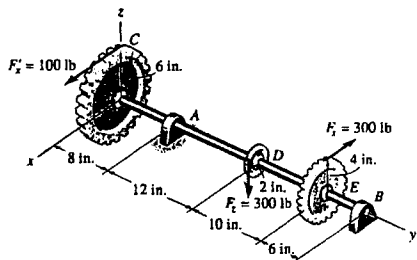

Critical moment is just to the right of D.

$$M = \sqrt{(2057)^2 + (1229)^2} = 2396 \text{ lb} \cdot \text{in.}$$

$$T = 1200 \text{ lb} \cdot \text{in.}$$

Use Eq. 11-2,

$$c = \left(\frac{2}{\pi \tau_{allow}} \sqrt{M^2 + T^2} \right)^{1/3}$$

$$c = \left(\frac{2}{\pi (6)(10^3)} \sqrt{(2396)^2 + (1200)^2} \right)^{1/3} = 0.6576 \text{ in.}$$

$$d_{req'd} = 2c = 1.315 \text{ in.}$$

$$\text{Use } d = 1\frac{3}{8} \text{ in.} \quad \text{Ans}$$

From *Mechanics of Materials*, Sixth Edition by R. C. Hibbeler, ISBN 0-13-191345-X.

© 2005 R. C. Hibbeler. Published by Pearson Prentice Hall,

Pearson Education, Inc., Upper Saddle River, NJ. All rights reserved.

This material is protected under all copyright laws as they currently exist. No portion of this material may be reproduced, in any form or by any means, without permission in writing from the publisher.

•11-46 The tubular shaft has an inner diameter of 15 mm. Determine to the nearest millimeter its outer diameter if it is subjected to the gear loading. The bearings at A and B exert force components only in the y and z directions on the shaft. Use an allowable shear stress of $\tau_{\text{allow}} = 70 \text{ MPa}$, and base the design on the maximum-shear-stress theory of failure.

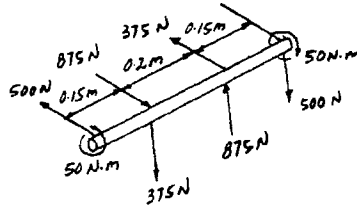
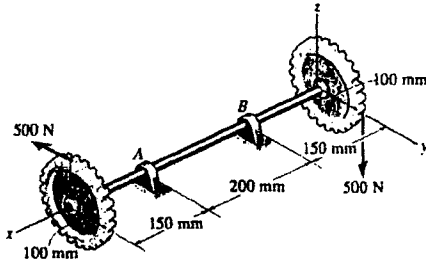

$$I = \frac{\pi}{4}(c^4 - 0.0075^4) \text{ and } J = \frac{\pi}{2}(c^4 - 0.0075^4)$$

$$\tau_{\text{allow}} = \sqrt{\left(\frac{\sigma_x - \sigma_y}{2}\right)^2 + \tau_{xy}^2}$$

$$\tau_{\text{allow}} = \sqrt{\left(\frac{Mc}{2I}\right)^2 + \left(\frac{Tc}{J}\right)^2}$$

$$\tau_{\text{allow}}^2 = \frac{M^2 c^2}{4I^2} + \frac{T^2 c^2}{J^2}$$

$$\left(\frac{c^4 - 0.0075^4}{c}\right)^2 = \frac{4M^2}{\pi^2} + \frac{4T^2}{\pi^2}$$

$$\frac{c^4 - 0.0075^4}{c} = \frac{2}{\pi \tau_{\text{allow}}} \sqrt{M^2 + T^2}$$

$$\frac{c^4 - 0.0075^4}{c} = \frac{2}{\pi(70)(10^6)} \sqrt{75^2 + 50^2}$$

$$c^4 - 0.0075^4 = 0.8198(10^{-6})c$$

Solving, $c = 0.0103976 \text{ m}$

$$d = 2c = 0.0207952 \text{ m} = 20.8 \text{ mm}$$

Use $d = 21 \text{ mm}$ **Ans**

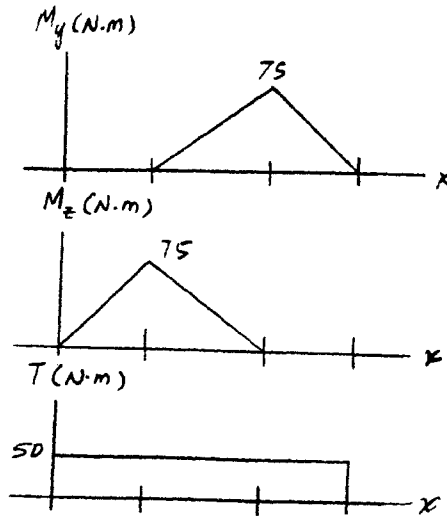

From *Mechanics of Materials*, Sixth Edition by R. C. Hibbeler, ISBN 0-13-191345-X.
 © 2005 R. C. Hibbeler. Published by Pearson Prentice Hall,
 Pearson Education, Inc., Upper Saddle River, NJ. All rights reserved.
 This material is protected under all copyright laws as they currently exist. No portion of this material may be reproduced, in any form or by any means, without permission in writing from the publisher.

11-47 Determine to the nearest millimeter the diameter of the solid shaft if it is subjected to the gear loading. The bearings at *A* and *B* exert force components only in the *y* and *z* directions on the shaft. Base the design on the maximum-distortion-energy theory of failure with $\sigma_{allow} = 150$ MPa.

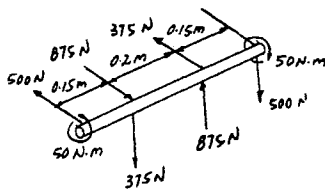
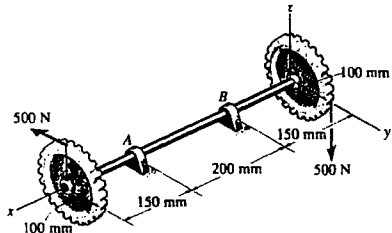

$$\sigma_{1,2} = \frac{\sigma_x}{2} \pm \sqrt{\frac{\sigma_x^2}{4} + \tau_{xy}^2}$$

$$\text{Let } a = \frac{\sigma_x}{2}, b = \sqrt{\frac{\sigma_x^2}{4} + \tau_{xy}^2}$$

$$\sigma_1 = a + b, \sigma_2 = a - b$$

Require,

$$\sigma_1^2 - \sigma_1 \sigma_2 + \sigma_2^2 = \sigma_{allow}^2$$

$$a^2 + 2ab + b^2 - [a^2 - b^2] + a^2 - 2ab + b^2 = \sigma_{allow}^2$$

$$a^2 + 3b^2 = \sigma_{allow}^2$$

$$\frac{\sigma_x^2}{4} + 3\left(\frac{\sigma_x^2}{4} + \tau_{xy}^2\right) = \sigma_{allow}^2$$

$$\sigma_x^2 + 3\tau_{xy}^2 = \sigma_{allow}^2$$

$$\left(\frac{Mc}{I}\right)^2 + 3\left(\frac{Tc}{J}\right)^2 = \sigma_{allow}^2$$

$$\frac{1}{c^6} \left[\left(\frac{4M}{\pi}\right)^2 + 3\left(\frac{2T}{\pi}\right)^2 \right] = \sigma_{allow}^2$$

$$c^6 = \frac{16}{\sigma_{allow}^2 \pi^2} M^2 + \frac{12T^2}{\sigma_{allow}^2 \pi^2}$$

$$c = \left(\frac{4}{\sigma_{allow}^2 \pi^2} (4M^2 + 3T^2) \right)^{\frac{1}{6}}$$

$$= \left[\frac{4}{(150(10^6))^2 (\pi)^2} (4(75)^2 + 3(50)^2) \right]^{\frac{1}{6}} = 0.009025 \text{ m}$$

$$d = 2c = 0.0181 \text{ m}$$

Use $d = 19 \text{ mm}$ Ans

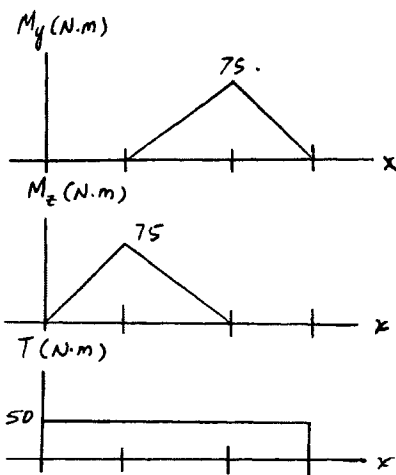

From *Mechanics of Materials*, Sixth Edition by R. C. Hibbeler, ISBN 0-13-191345-X.

© 2005 R. C. Hibbeler. Published by Pearson Prentice Hall,

Pearson Education, Inc., Upper Saddle River, NJ. All rights reserved.

This material is protected under all copyright laws as they currently exist. No portion of this material may be reproduced, in any form or by any means, without permission in writing from the publisher.

*11-48 The end gear connected to the shaft is subjected to the loading shown. If the bearings at *A* and *B* exert only *y* and *z* components of force on the shaft, determine the equilibrium torque *T* at gear *C* and then determine the smallest diameter of the shaft to the nearest millimeter that will support the loading. Use the maximum-shear-stress theory of failure with $\tau_{\text{allow}} = 60 \text{ MPa}$.

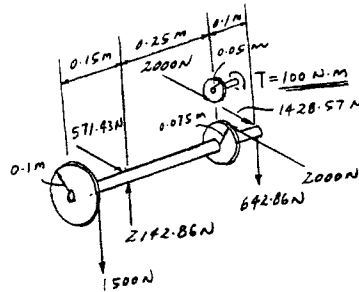
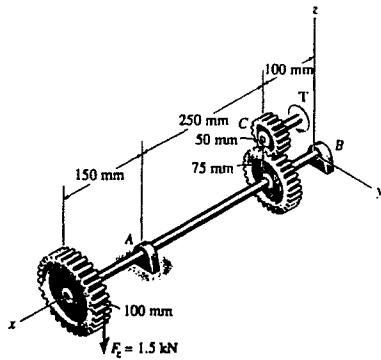

From the free-body diagrams :

$$T = 100 \text{ N} \cdot \text{m}$$

Critical section is at support *A*.

$$c = \left[\frac{2}{\pi \tau_{\text{allow}}} \sqrt{M^2 + T^2} \right]^{\frac{1}{3}} = \left[\frac{2}{\pi (60)(10^6)} \sqrt{225^2 + 150^2} \right]^{\frac{1}{3}} = 0.01421 \text{ m}$$

$$d = 2c = 0.0284 \text{ m} = 28.4 \text{ mm}$$

Use $d = 29 \text{ mm}$

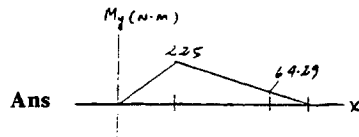

Ans

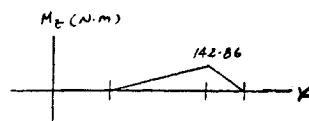

Ans

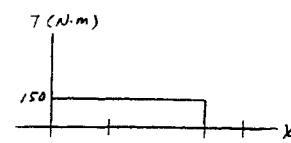

From *Mechanics of Materials*, Sixth Edition by R. C. Hibbeler, ISBN 0-13-191345-X.
 © 2005 R. C. Hibbeler. Published by Pearson Prentice Hall,
 Pearson Education, Inc., Upper Saddle River, NJ. All rights reserved.
 This material is protected under all copyright laws as they currently exist. No portion of this material may be reproduced, in any form or by any means, without permission in writing from the publisher.

11-49. Solve Prob. 11-48 using the maximum-distortion energy theory of failure with $\sigma_{allow} = 80 \text{ MPa}$.

From the free-body diagrams .
 $T = 100 \text{ N}\cdot\text{m}$ Ans

Critical section is at support A.

$$\sigma_{1,2} = \frac{\sigma_x}{2} \pm \sqrt{\frac{\sigma_x^2}{4} + \tau_{xy}^2}$$

$$\text{Let } a = \frac{\sigma_x}{2}, b = \sqrt{\frac{\sigma_x^2}{4} + \tau_{xy}^2}$$

$$\sigma_1 = a + b, \sigma_2 = a - b$$

Require.

$$\sigma_1^2 - \sigma_1\sigma_2 + \sigma_2^2 = \sigma_{allow}^2$$

$$a^2 + 2ab + b^2 - [a^2 - b^2] + a^2 - 2ab + b^2 = \sigma_{allow}^2$$

$$a^2 + 3b^2 = \sigma_{allow}^2$$

$$\frac{\sigma_x^2}{4} + 3\left(\frac{\sigma_x^2}{4} + \tau_{xy}^2\right) = \sigma_{allow}^2$$

$$\sigma_x^2 + 3\tau_{xy}^2 = \sigma_{allow}^2$$

$$\left(\frac{Mc}{Ic}\right)^2 + 3\left(\frac{Tc}{Jc}\right)^2 = \sigma_{allow}^2$$

$$\frac{1}{c^4} \left[\left(\frac{AM}{I}\right)^2 + 3\left(\frac{2T}{I}\right)^2 \right] = \sigma_{allow}^2$$

$$c^4 = \frac{16}{\sigma_{allow}^2} M^2 + \frac{12T^2}{\sigma_{allow}^2}$$

$$c = \left(\frac{4}{\sigma_{allow}^2} (AM^2 + 3T^2) \right)^{\frac{1}{4}}$$

$$= \left[\frac{4}{(80(10^6))^2 (m)^2} (4(225)^2 + 3(150)^2) \right]^{\frac{1}{4}}$$

$$= 0.01605 \text{ m}$$

$$d = 2c = 0.0321 \text{ m} = 32.1 \text{ mm}$$

Use $d = 33 \text{ mm}$ Ans

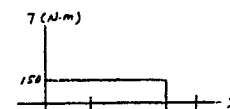
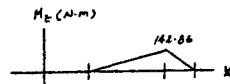
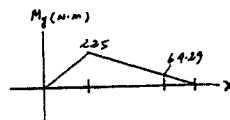
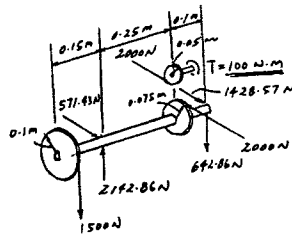
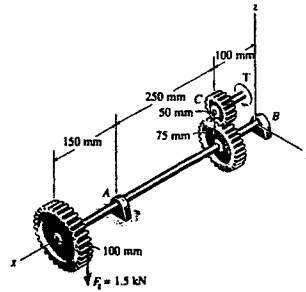

From *Mechanics of Materials*, Sixth Edition by R. C. Hibbeler, ISBN 0-13-191345-X.

© 2005 R. C. Hibbeler. Published by Pearson Prentice Hall,

Pearson Education, Inc., Upper Saddle River, NJ. All rights reserved.

This material is protected under all copyright laws as they currently exist. No portion of this material may be reproduced, in any form or by any means, without permission in writing from the publisher.

11-50 The beam is made of cypress having an allowable bending stress of $\sigma_{\text{allow}} = 850$ psi and an allowable shear stress of $\tau_{\text{allow}} = 80$ psi. Determine the width b of the beam if the height $h = 1.5b$.

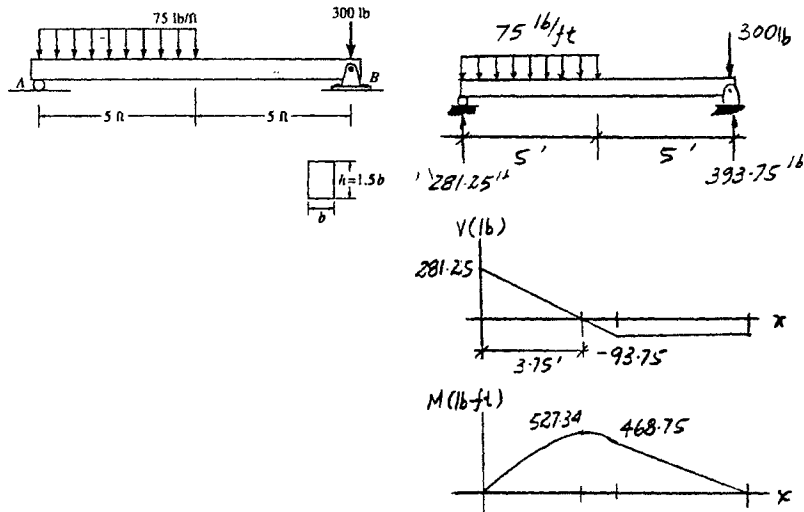

$$I_x = \frac{1}{12}(b)(1.5b)^3 = 0.28125 b^4$$

$$Q_{\text{max}} = \bar{y}A' = (0.375b)(0.75b)(b) = 0.28125 b^3$$

Assume bending controls.

$$M_{\text{max}} = 527.34 \text{ lb} \cdot \text{ft}$$

$$\sigma_{\text{allow}} = \frac{M_{\text{max}}c}{I}; \quad 850 = \frac{527.34(12)(0.75b)}{0.28125 b^4}$$

$$b = 2.71 \text{ in.} \quad \text{Ans}$$

Check shear :

$$I = 15.12 \text{ in}^4 \quad Q_{\text{max}} = 5.584 \text{ in}^3$$

$$\begin{aligned} \tau_{\text{max}} &= \frac{VQ_{\text{max}}}{It} = \frac{281.25(5.584)}{15.12(2.71)} \\ &= 38.36 \text{ psi} < 80 \text{ psi} \quad \text{OK} \end{aligned}$$

From *Mechanics of Materials*, Sixth Edition by R. C. Hibbeler, ISBN 0-13-191345-X.

© 2005 R. C. Hibbeler. Published by Pearson Prentice Hall,

Pearson Education, Inc., Upper Saddle River, NJ. All rights reserved.

This material is protected under all copyright laws as they currently exist. No portion of this material may be reproduced, in any form or by any means, without permission in writing from the publisher.

11-51 The cantilevered beam has a circular cross section. If it supports a force P at its end, determine its radius y as a function of x so that it is subjected to a constant maximum bending stress σ_{allow} throughout its length.

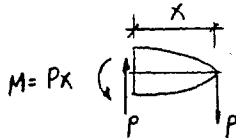
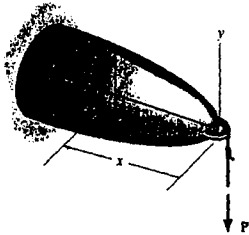

Section properties :

$$I = \frac{\pi}{4} y^4$$

$$S = \frac{I}{c} = \frac{\frac{\pi}{4} y^4}{y} = \frac{\pi}{4} y^3$$

$$\sigma_{\text{allow}} = \frac{M}{S} = \frac{Px}{\frac{\pi}{4} y^3}$$

$$y = \left[\frac{4Px}{\pi \sigma_{\text{allow}}} \right]^{\frac{1}{3}}$$

Ans

From *Mechanics of Materials*, Sixth Edition by R. C. Hibbeler, ISBN 0-13-191345-X.

© 2005 R. C. Hibbeler. Published by Pearson Prentice Hall,

Pearson Education, Inc., Upper Saddle River, NJ. All rights reserved.

This material is protected under all copyright laws as they currently exist. No portion of this material may be reproduced, in any form or by any means, without permission in writing from the publisher.

*11-52 The simply supported beam is made of timber that has an allowable bending stress of $\sigma_{allow} = 8 \text{ MPa}$ and an allowable shear stress of $\tau_{allow} = 750 \text{ kPa}$. Determine its dimensions if it is to be rectangular and have a height-to-width ratio of $h/b = 1.25$.

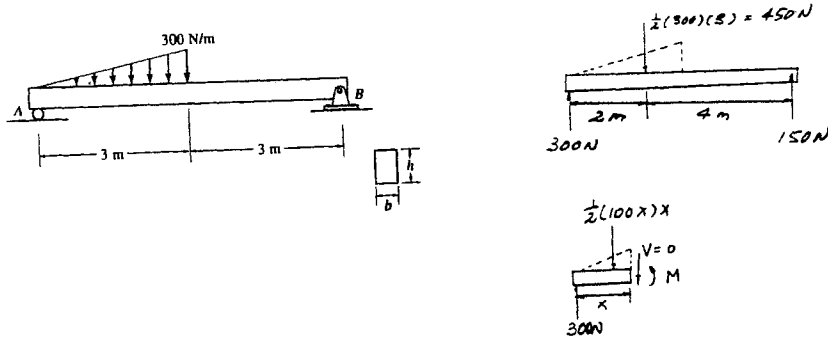

From the free-body diagram of the segment :

$$+\uparrow \Sigma F_y = 0; \quad 300 - \frac{1}{2}(100x)x = 0; \quad x = 2.449 \text{ m}$$

$$\curvearrowright \Sigma M = 0; \quad M + \frac{1}{2}[100(2.449)](2.449)\left(\frac{2.449}{3}\right) - 300(2.449) = 0; \quad M = 489.9 \text{ N} \cdot \text{m}$$

$$I = \frac{1}{12}(b)(1.25b)^3 = 0.16276 b^4$$

$$S_{req'd} = \frac{I}{c} = \frac{0.16276 b^4}{0.625 b} = 0.26042 b^3$$

Assume bending controls.

$$\sigma_{allow} = \frac{M_{max}}{S_{req'd}}; \quad 8(10^6) = \frac{489.9}{0.26042 b^3}$$

$$b = 0.06172 \text{ m} = 61.7 \text{ mm} \quad \text{Ans}$$

$$h = 1.25(0.06172) = 77.2 \text{ mm} \quad \text{Ans}$$

Check shear :

$$\tau_{max} = \frac{1.5V_{max}}{A} = \frac{1.5(300)}{(0.06172)(1.25)(0.0617)} = 94.5 \text{ kPa} < \tau_{allow} = 750 \text{ kPa} \quad \text{OK}$$

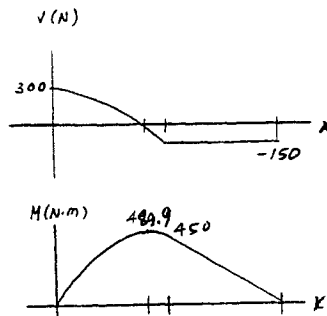

From *Mechanics of Materials*, Sixth Edition by R. C. Hibbeler, ISBN 0-13-191345-X.

© 2005 R. C. Hibbeler. Published by Pearson Prentice Hall,

Pearson Education, Inc., Upper Saddle River, NJ. All rights reserved.

This material is protected under all copyright laws as they currently exist. No portion of this material may be reproduced, in any form or by any means, without permission in writing from the publisher.

11-53 Solve Prob. 11-52 if the height-to-width ratio of the beam is to be $h/b = 1.5$.

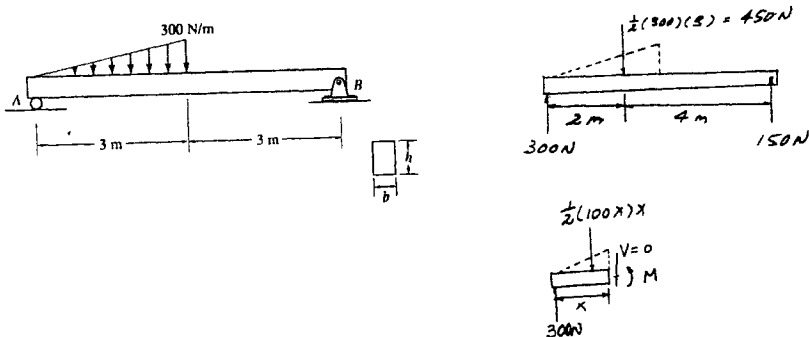

From the free-body diagram of the segment :

$$+\uparrow \Sigma F_y = 0; \quad 300 - \frac{1}{2}(100x)x = 0; \quad x = 2.449 \text{ m}$$

$$\curvearrowleft + \Sigma M = 0; \quad M + \frac{1}{2}[100(2.449)](2.449)\left(\frac{2.449}{3}\right) - 300(2.449) = 0; \quad M = 489.9 \text{ N} \cdot \text{m}$$

Section properties :

$$I = \frac{1}{12}(b)(1.5b)^3 = 0.28125 b^4$$

$$S_{req'd} = \frac{I}{c} = \frac{0.28125 b^4}{0.75 b} = 0.375 b^3$$

Beam design : Assume bending moment controls.

$$\sigma_{allow} = \frac{M_{max}}{S_{req'd}}; \quad 8(10^6) = \frac{489.9}{0.375 b^3}$$

$$b = 0.0547 \text{ m} = 54.7 \text{ mm} \quad \text{Ans}$$

$$h = 1.5(0.0547) = 82.0 \text{ mm} \quad \text{Ans}$$

Check shear :

$$\tau_{max} = \frac{1.5V_{max}}{A} = \frac{1.5(300)}{(0.0547)(1.5)(0.0547)} = 100 \text{ kPa} < \tau_{allow} = 750 \text{ kPa} \quad \text{OK}$$

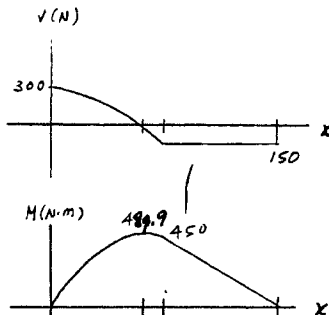

From *Mechanics of Materials*, Sixth Edition by R. C. Hibbeler, ISBN 0-13-191345-X.
 © 2005 R. C. Hibbeler. Published by Pearson Prentice Hall,
 Pearson Education, Inc., Upper Saddle River, NJ. All rights reserved.
 This material is protected under all copyright laws as they currently exist. No portion of this material may be reproduced, in any form or by any means, without permission in writing from the publisher.

11-54. Select the lightest-weight steel wide-flange overhanging beam from Appendix B that will safely support the loading. Assume the support at A is a pin and the support at B is a roller. The allowable bending stress is $\sigma_{\text{allow}} = 24$ ksi and the allowable shear stress is $\sigma_{\text{allow}} = 14$ ksi.

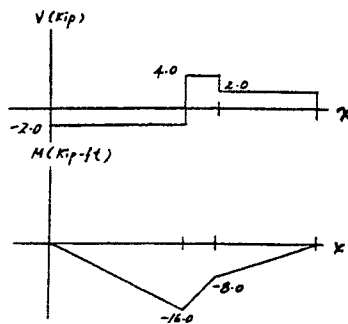
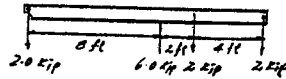
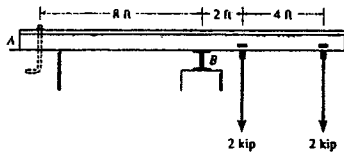

Assume bending controls.

$$S_{\text{req'd}} = \frac{M_{\text{max}}}{\sigma_{\text{allow}}} = \frac{16.0(12)}{24} = 8.0 \text{ in}^3$$

Select a W 10 × 12

$$S_x = 10.9 \text{ in}^3, \quad d = 9.87 \text{ in.}, \quad t_w = 0.190 \text{ in.}$$

Check shear :

$$\tau_{\text{avg}} = \frac{V_{\text{max}}}{A_{\text{web}}} = \frac{4}{9.87(0.190)} = 2.13 \text{ ksi} < 14 \text{ ksi} \quad \text{OK}$$

Use W 10 × 12 **Ans**

From *Mechanics of Materials*, Sixth Edition by R. C. Hibbeler, ISBN 0-13-191345-X.

© 2005 R. C. Hibbeler. Published by Pearson Prentice Hall,

Pearson Education, Inc., Upper Saddle River, NJ. All rights reserved.

This material is protected under all copyright laws as they currently exist. No portion of this material may be reproduced, in any form or by any means, without permission in writing from the publisher.

11-55 The bearings at *A* and *B* exert only *x* and *z* components of force on the steel shaft. Determine the shaft's diameter to the nearest millimeter so that it can resist the loadings of the gears without exceeding an allowable shear stress of $\tau_{\text{allow}} = 80$ MPa. Use the maximum-shear-stress theory of failure.

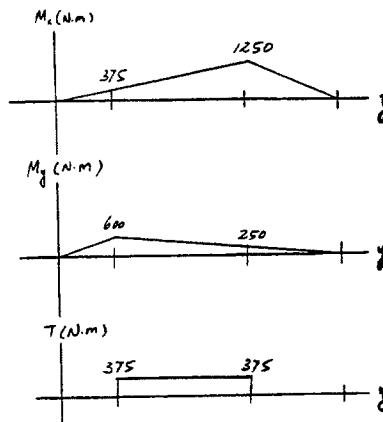
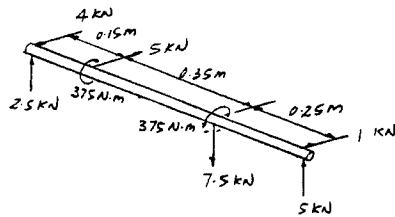
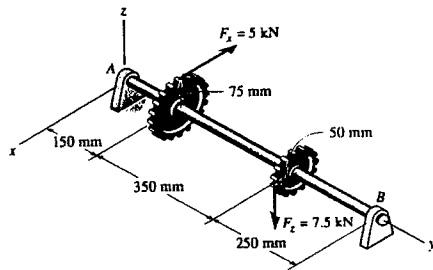

Maximum resultant moment $M = \sqrt{1250^2 + 250^2} = 1274.75 \text{ N} \cdot \text{m}$

$$c = \left[\frac{2}{\pi \tau_{\text{allow}}} \sqrt{M^2 + T^2} \right]^{\frac{1}{3}} = \left[\frac{2}{\pi(80)(10^6)} \sqrt{1274.75^2 + 375^2} \right]^{\frac{1}{3}} = 0.0219 \text{ m}$$

$d = 2c = 0.0439 \text{ m} = 43.9 \text{ mm}$

Use $d = 44 \text{ mm}$ **Ans**

From *Mechanics of Materials*, Sixth Edition by R. C. Hibbeler, ISBN 0-13-191345-X.
 © 2005 R. C. Hibbeler. Published by Pearson Prentice Hall,
 Pearson Education, Inc., Upper Saddle River, NJ. All rights reserved.
 This material is protected under all copyright laws as they currently exist. No portion of this material may be reproduced, in any form or by any means, without permission in writing from the publisher.

*11-56 Solve Prob. 11-55 using the maximum-distortion-energy theory of failure with $\sigma_{allow} = 200$ MPa.

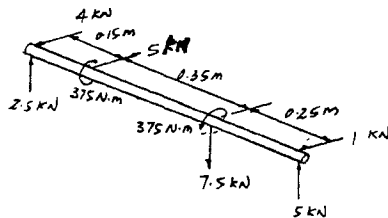
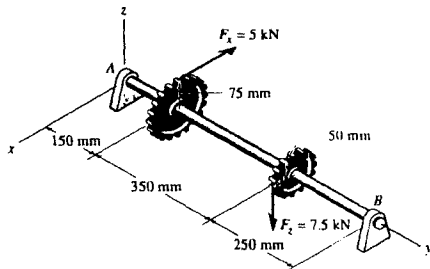

Maximum resultant moment $M = \sqrt{1250^2 + 250^2} = 1274.75 \text{ N} \cdot \text{m}$

$$\sigma_{1,2} = \frac{\sigma_x}{2} \pm \sqrt{\frac{\sigma_x^2}{4} + \tau_{xy}^2}$$

Let $a = \frac{\sigma_x}{2}$, $b = \sqrt{\frac{\sigma_x^2}{4} + \tau_{xy}^2}$

$$\sigma_1 = a + b, \quad \sigma_2 = a - b$$

Require,

$$\sigma_1^2 - \sigma_1 \sigma_2 + \sigma_2^2 = \sigma_{allow}^2$$

$$a^2 + 2ab + b^2 - [a^2 - b^2] + a^2 - 2ab + b^2 = \sigma_{allow}^2$$

$$a^2 + 3b^2 = \sigma_{allow}^2$$

$$\frac{\sigma_x^2}{4} + 3\left(\frac{\sigma_x^2}{4} + \tau_{xy}^2\right) = \sigma_{allow}^2$$

$$\sigma_x^2 + 3\tau_{xy}^2 = \sigma_{allow}^2$$

$$\left(\frac{Mc}{\pi c^3}\right)^2 + 3\left(\frac{Tc}{\pi c^3}\right)^2 = \sigma_{allow}^2$$

$$\frac{1}{c^6} \left[\left(\frac{4M}{\pi}\right)^2 + 3\left(\frac{2T}{\pi}\right)^2 \right] = \sigma_{allow}^2$$

$$c^6 = \frac{16}{\sigma_{allow}^2 \pi^2} M^2 + \frac{12T^2}{\sigma_{allow}^2 \pi^2}$$

$$c = \left(\frac{4}{\sigma_{allow}^2 \pi^2} (4M^2 + 3T^2) \right)^{\frac{1}{6}}$$

$$= \left[\frac{4}{(200(10^6))^2 (\pi)^2} (4(1274.75)^2 + 3(375)^2) \right]^{\frac{1}{6}}$$

$$= 0.0203 \text{ m} = 20.3 \text{ mm}$$

$d = 40.6 \text{ mm}$ **Ans**

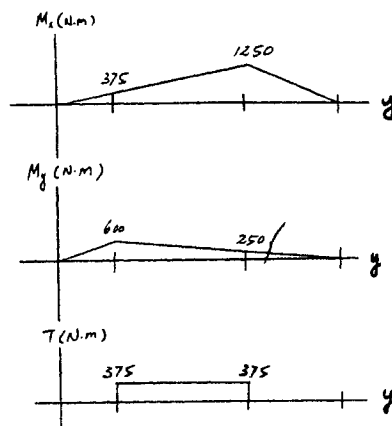

From *Mechanics of Materials*, Sixth Edition by R. C. Hibbeler, ISBN 0-13-191345-X.

© 2005 R. C. Hibbeler. Published by Pearson Prentice Hall,

Pearson Education, Inc., Upper Saddle River, NJ. All rights reserved.

This material is protected under all copyright laws as they currently exist. No portion of this material may be reproduced, in any form or by any means, without permission in writing from the publisher.

11-57. Select the lightest-weight steel wide-flange beam from Appendix B that will safely support the loading shown. The allowable bending stress is $\sigma_{\text{allow}} = 22 \text{ ksi}$ and the allowable shear stress is $\tau_{\text{allow}} = 12 \text{ ksi}$.

Bending Stress : From the moment diagram, $M_{\text{max}} = 155 \text{ kip} \cdot \text{ft}$. Assume bending controls the design. Applying the flexure formula,

$$S_{\text{req'd}} = \frac{M_{\text{max}}}{\sigma_{\text{allow}}} = \frac{155(12)}{22} = 84.55 \text{ in}^3$$

Select W18x50 ($S_x = 88.9 \text{ in}^3$, $d = 17.99 \text{ in.}$, $t_w = 0.355 \text{ in.}$)

Shear Stress : Provide a shear stress check using $\tau = \frac{V}{t_w d}$ for a W18x50 wide-flange section. From the shear diagram, $V_{\text{max}} = 13.0 \text{ kip}$.

$$\begin{aligned} \tau_{\text{max}} &= \frac{V_{\text{max}}}{t_w d} \\ &= \frac{13.0}{0.355(17.99)} \\ &= 2.04 \text{ ksi} < \tau_{\text{allow}} = 12 \text{ ksi (O.K!)} \end{aligned}$$

Hence, Use W18x50 Ans

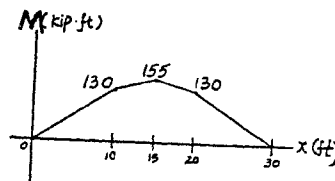
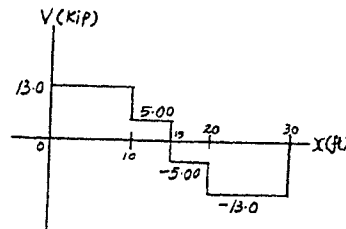
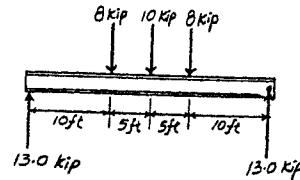

From *Mechanics of Materials*, Sixth Edition by R. C. Hibbeler, ISBN 0-13-191345-X.
 © 2005 R. C. Hibbeler. Published by Pearson Prentice Hall,
 Pearson Education, Inc., Upper Saddle River, NJ. All rights reserved.
 This material is protected under all copyright laws as they currently exist. No portion of this material may be reproduced, in any form or by any means, without permission in writing from the publisher.

12-1 An L2 steel strap having a thickness of 0.125 in. and a width of 2 in. is bent into a circular arc of radius 600 in. Determine the maximum bending stress in the strap.

$$\frac{1}{\rho} = \frac{M}{EI} \quad M = \frac{EI}{\rho}$$

However,

$$\sigma = \frac{Mc}{I} = \frac{(EI/\rho)c}{I} = \left(\frac{c}{\rho}\right)E$$

$$\sigma = \frac{0.0625}{600}(29)(10^3) = 3.02 \text{ ksi} \quad \text{Ans}$$

From *Mechanics of Materials*, Sixth Edition by R. C. Hibbeler, ISBN 0-13-191345-X.

© 2005 R. C. Hibbeler. Published by Pearson Prentice Hall,

Pearson Education, Inc., Upper Saddle River, NJ. All rights reserved.

This material is protected under all copyright laws as they currently exist. No portion of this material may be reproduced, in any form or by any means, without permission in writing from the publisher.

12-2 The L2 steel blade of the band saw wraps around the pulley having a radius of 12 in. Determine the maximum normal stress in the blade. The blade is made of steel having a width of 0.75 in and a thickness of 0.0625 in.

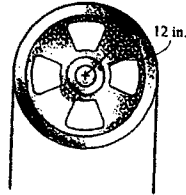

$$\frac{1}{\rho} = \frac{M}{EI}; \quad M = \frac{EI}{\rho}$$

However,

$$\sigma = \frac{Mc}{I} = \frac{(EI/\rho)c}{I} = \left(\frac{c}{\rho}\right)E$$

$$\sigma = \left(\frac{0.03125}{12}\right)(29)(10^3) = 75.5 \text{ ksi} \quad \text{Ans}$$

From *Mechanics of Materials*, Sixth Edition by R. C. Hibbeler, ISBN 0-13-191345-X.

© 2005 R. C. Hibbeler. Published by Pearson Prentice Hall,

Pearson Education, Inc., Upper Saddle River, NJ. All rights reserved.

This material is protected under all copyright laws as they currently exist. No portion of this material may be reproduced, in any form or by any means, without permission in writing from the publisher.

12-3. Determine the equation of the elastic curve for the beam using the x coordinate that is valid for $0 \leq x < L/2$. Specify the slope at A and the beam's maximum deflection. EI is constant.

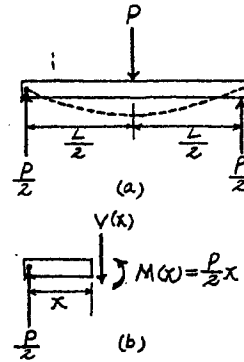

Support Reactions and Elastic Curve : As shown on FBD(a).

Moment Function : As shown on FBD(b).

Slope and Elastic Curve :

$$EI \frac{d^2v}{dx^2} = M(x)$$

$$EI \frac{d^2v}{dx^2} = \frac{P}{2}x$$

$$EI \frac{dv}{dx} = \frac{P}{4}x^2 + C_1$$

$$EI v = \frac{P}{12}x^3 + C_1x + C_2$$

Boundary Conditions : Due to symmetry, $\frac{dv}{dx} = 0$ at $x = \frac{L}{2}$.

Also, $v = 0$ at $x = 0$.

From Eq. [1] $0 = \frac{P}{4}\left(\frac{L}{2}\right)^2 + C_1$ $C_1 = -\frac{PL^2}{16}$

From Eq. [2] $0 = 0 + 0 + C_2$ $C_2 = 0$

The Slope : Substitute the value of C_1 into Eq. [1],

$$\frac{dv}{dx} = \frac{P}{16EI} (4x^2 - L^2)$$

$$\theta_A = \left. \frac{dv}{dx} \right|_{x=0} = -\frac{PL^2}{16EI}$$

Ans

The negative sign indicates clockwise rotation.

The Elastic Curve : Substitute the values of C_1 and C_2 into Eq. [2],

$$v = \frac{Px}{48EI} (4x^2 - 3L^2)$$

Ans

v_{\max} occurs at $x = \frac{L}{2}$,

$$v_{\max} = -\frac{PL^3}{48EI}$$

Ans

The negative sign indicates downward displacement.

From *Mechanics of Materials*, Sixth Edition by R. C. Hibbeler, ISBN 0-13-191345-X.

© 2005 R. C. Hibbeler. Published by Pearson Prentice Hall,

Pearson Education, Inc., Upper Saddle River, NJ. All rights reserved.

This material is protected under all copyright laws as they currently exist. No portion of this material may be reproduced, in any form or by any means, without permission in writing from the publisher.

*12-4 Determine the equations of the elastic curve using the x_1 and x_2 coordinates. EI is constant.

$$EI \frac{d^2 v}{dx^2} = M(x)$$

$$M_1 = \frac{Pb}{L} x_1$$

$$EI \frac{d^2 v_1}{dx_1^2} = \frac{Pb}{L} x_1$$

$$EI \frac{dv_1}{dx_1} = \frac{Pb}{2L} x_1^2 + C_1 \quad (1)$$

$$EI v_1 = \frac{Pb}{6L} x_1^3 + C_1 x_1 + C_2 \quad (2)$$

$$M_2 = \frac{Pb}{L} x_2 - P(x_2 - a)$$

But $b = L - a$. Thus

$$M_2 = Pa \left(1 - \frac{x_2}{L}\right)$$

$$EI \frac{d^2 v_2}{dx_2^2} = Pa \left(1 - \frac{x_2}{L}\right)$$

$$EI \frac{dv_2}{dx_2} = Pa \left(x_2 - \frac{x_2^2}{2L}\right) + C_3 \quad (3)$$

$$EI v_2 = Pa \left(\frac{x_2^2}{2} - \frac{x_2^3}{6L}\right) + C_3 x_2 + C_4 \quad (4)$$

Applying the boundary conditions :

$$v_1 = 0 \text{ at } x_1 = 0$$

$$\text{Therefore, } C_2 = 0,$$

$$v_2 = 0 \text{ at } x_2 = L$$

$$0 = \frac{PaL^2}{3} + C_3 L + C_4 \quad (5)$$

Applying the continuity conditions :

$$v_1|_{x_1=a} = v_2|_{x_2=a}$$

$$\frac{Pb}{6L} a^3 + C_1 a = Pa \left(\frac{a^2}{2} - \frac{a^3}{6L}\right) + C_3 a + C_4 \quad (6)$$

$$\left. \frac{dv_1}{dx_1} \right|_{x_1=a} = \left. \frac{dv_2}{dx_2} \right|_{x_2=a}$$

$$\frac{Pb}{2L} a^2 + C_1 = Pa \left(a - \frac{a^2}{2L}\right) + C_3 \quad (7)$$

Solving Eqs. (5), (6) and (7) simultaneously yields,

$$C_1 = -\frac{Pb}{6L}(L^2 - b^2); \quad C_3 = -\frac{Pa}{6L}(2L^2 + a^2)$$

$$C_4 = \frac{Pa^3}{6}$$

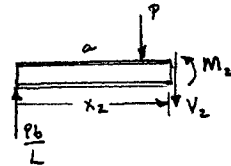
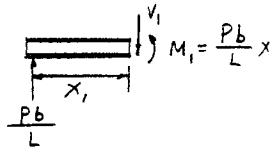
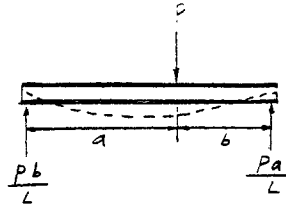
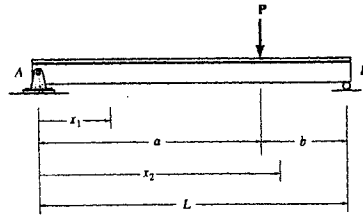

Thus,

$$EI v_1 = \frac{Pb}{6L} x_1^3 - \frac{Pb}{6L} (L^2 - b^2) x_1$$

or

$$v_1 = \frac{Pb}{6EL} (x_1^3 - (L^2 - b^2) x_1) \quad \text{Ans}$$

and

$$EI v_2 = Pa \left(\frac{x_2^2}{2} - \frac{x_2^3}{6L}\right) - \frac{Pa}{6L} (2L^2 + a^2) x_2 + \frac{Pa^3}{6}$$

$$v_2 = \frac{Pa}{6EL} [3x_2^2 L - x_2^3 - (2L^2 + a^2) x_2 + a^2 L] \quad \text{Ans}$$

From *Mechanics of Materials*, Sixth Edition by R. C. Hibbeler, ISBN 0-13-191345-X.

© 2005 R. C. Hibbeler. Published by Pearson Prentice Hall,

Pearson Education, Inc., Upper Saddle River, NJ. All rights reserved.

This material is protected under all copyright laws as they currently exist. No portion of this material may be reproduced, in any form or by any means, without permission in writing from the publisher.

12-5 Determine the equations of the elastic curve using the x_1 and x_2 coordinates. EI is constant.

$$EI \frac{d^2 v_1}{dx_1^2} = M_1(x)$$

$$M_1(x) = 0; \quad EI \frac{d^2 v_1}{dx_1^2} = 0$$

$$EI \frac{dv_1}{dx_1} = C_1 \quad (1)$$

$$EI v_1 = C_1 x_1 + C_2 \quad (2)$$

$$M_2(x) = Px_2 - P(L-a)$$

$$EI \frac{d^2 v_2}{dx_2^2} = Px_2 - P(L-a)$$

$$EI \frac{dv_2}{dx_2} = \frac{P}{2} x_2^2 - P(L-a)x_2 + C_3 \quad (3)$$

$$EI v_2 = \frac{P}{6} x_2^3 - \frac{P(L-a)x_2^2}{2} + C_3 x_2 + C_4 \quad (4)$$

Boundary conditions :

$$\text{At } x_2 = 0, \quad \frac{dv_2}{dx_2} = 0$$

$$\text{From Eq.(3), } 0 = C_3$$

$$\text{At } x_2 = 0, \quad v_2 = 0$$

$$0 = C_4$$

Continuity condition :

$$\text{At } x_1 = a, \quad x_2 = L - a; \quad \frac{dv_1}{dx_1} = -\frac{dv_2}{dx_2}$$

From Eqs. (1) and (3),

$$C_1 = -\left[\frac{P(L-a)^2}{2} - P(L-a)^2\right]; \quad C_1 = \frac{P(L-a)^2}{2}$$

$$\text{At } x_1 = a, \quad x_2 = L - a, \quad v_1 = v_2$$

From Eqs. (2) and (4),

$$\left(\frac{P(L-a)^2}{2}\right)a + C_2 = \frac{P(L-a)^3}{6} - \frac{P(L-a)^3}{2}$$

$$C_2 = -\frac{Pa(L-a)^2}{2} - \frac{P(L-a)^3}{3}$$

From Eq. (2),

$$v_1 = \frac{P}{6EI} [a^3(L-a)^2 x_1 - 3a(L-a)^2 - 2(L-a)^3] \quad \text{Ans}$$

$$v_2 = \frac{P}{6EI} [x_2^3 - 3(L-a)x_2^2] \quad \text{Ans}$$

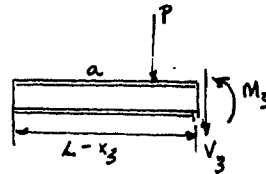
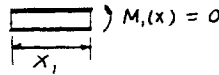
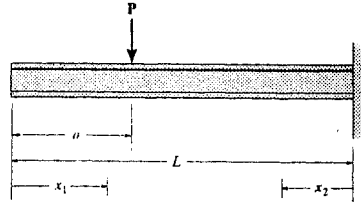

From *Mechanics of Materials*, Sixth Edition by R. C. Hibbeler, ISBN 0-13-191345-X.

© 2005 R. C. Hibbeler. Published by Pearson Prentice Hall,

Pearson Education, Inc., Upper Saddle River, NJ. All rights reserved.

This material is protected under all copyright laws as they currently exist. No portion of this material may be reproduced, in any form or by any means, without permission in writing from the publisher.

12-6 The simply-supported shaft has a moment of inertia of $2I$ for region BC and a moment of inertia I for regions AB and CD . Determine the maximum deflection of the beam due to the load P .

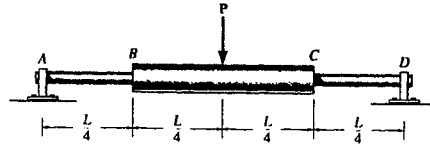

$$M_1(x) = \frac{P}{2}x_1$$

$$M_2(x) = \frac{P}{2}x_2$$

Elastic curve and slope :

$$EI \frac{d^2v}{dx^2} = \dot{M}(x)$$

$$EI \frac{d^2v_1}{dx_1^2} = \frac{P}{2}x_1$$

$$EI \frac{dv_1}{dx_1} = \frac{Px_1^2}{4} + C_1 \quad (1)$$

$$EIv_1 = \frac{Px_1^3}{12} + C_1x_1 + C_2 \quad (2)$$

$$2EI \frac{d^2v_2}{dx_2^2} = \frac{P}{2}x_2$$

$$2EI \frac{dv_2}{dx_2} = \frac{Px_2^2}{4} + C_3 \quad (3)$$

$$2EIv_2 = \frac{Px_2^3}{12} + C_3x_2 + C_4 \quad (4)$$

Boundary Conditions :

$$v_1 = 0 \quad \text{at} \quad x_1 = 0$$

From Eq. (2), $C_2 = 0$

$$\frac{dv_2}{dx_2} = 0 \quad \text{at} \quad x_2 = \frac{L}{2}$$

From Eq. (3),

$$0 = \frac{PL^2}{16} + C_3$$

$$C_3 = -\frac{PL^2}{16}$$

Continuity conditions :

$$\frac{dv_1}{dx_1} = \frac{dv_2}{dx_2} \quad \text{at} \quad x_1 = x_2 = \frac{L}{4}$$

From Eqs. (1) and (3),

$$\frac{PL^2}{64} + C_1 = \frac{PL^2}{128} - \frac{1}{2} \left(\frac{PL^2}{16} \right)$$

$$C_1 = \frac{-PL^2}{128}$$

$$v_1 = v_2 \quad \text{at} \quad x_1 = x_2 = \frac{L}{4}$$

From Eqs. (2) and (4)

$$\frac{PL^3}{768} - \frac{5PL^2}{128} \left(\frac{L}{4} \right) = \frac{PL^3}{1536} - \frac{1}{2} \left(\frac{PL^2}{16} \right) \left(\frac{L}{4} \right) + \frac{1}{2} C_4$$

$$C_4 = \frac{-PL^3}{384}$$

$$v_2 = \frac{P}{768EI} (32x_2^3 - 24L^2x_2 - L^3)$$

$$v_{\max} = v_2 \Big|_{x_2 = \frac{L}{2}} = \frac{-3PL^3}{768EI} = \frac{3PL^3}{256EI} \quad \text{Ans}$$

$$M_1(x) = \frac{P}{2}x_1$$

$$M_2(x) = \frac{P}{2}x_2$$

From *Mechanics of Materials*, Sixth Edition by R. C. Hibbeler, ISBN 0-13-191345-X.

© 2005 R. C. Hibbeler. Published by Pearson Prentice Hall,

Pearson Education, Inc., Upper Saddle River, NJ. All rights reserved.

This material is protected under all copyright laws as they currently exist. No portion of this material may be reproduced, in any form or by any means, without permission in writing from the publisher.

12-7 Determine the equations of the elastic curve for the beam using the x_1 and x_2 coordinates. Specify the slope at A and the maximum deflection. EI is constant.

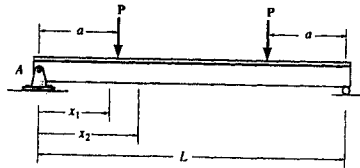

Elastic curve and slope:

$$EI \frac{d^2 v}{dx^2} = M(x)$$

For $M_1(x) = Px_1$

$$EI \frac{d^2 v_1}{dx_1^2} = Px_1$$

$$EI \frac{dv_1}{dx_1} = \frac{Px_1^2}{2} + C_1 \quad (1)$$

$$EI v_1 = \frac{Px_1^3}{6} + C_1 x_1 + C_2 \quad (2)$$

For $M_2(x) = Pa$

$$EI \frac{d^2 v_2}{dx_2^2} = Pa$$

$$EI \frac{dv_2}{dx_2} = Pa x_2 + C_3 \quad (3)$$

$$EI v_2 = \frac{Pa x_2^2}{2} + C_3 x_2 + C_4 \quad (4)$$

Boundary Conditions:

$$v_1 = 0 \quad \text{at} \quad x = 0$$

From Eq. (2)

$$C_2 = 0$$

Due to symmetry:

$$\frac{dv_2}{dx_2} = 0 \quad \text{at} \quad x_2 = \frac{L}{2}$$

From Eq. (3)

$$0 = Pa \frac{L}{2} + C_3$$

$$C_3 = -\frac{PaL}{2}$$

Continuity conditions:

$$v_1 = v_2 \quad \text{at} \quad x_1 = x_2 = a$$

$$\frac{Pa^3}{6} + C_1 a = \frac{Pa^3}{2} - \frac{Pa^2 L}{2} + C_4$$

$$C_1 a - C_4 = \frac{Pa^3}{3} - \frac{Pa^2 L}{2} \quad (5)$$

$$\frac{dv_1}{dx_1} = \frac{dv_2}{dx_2} \quad \text{at} \quad x_1 = x_2 = a$$

$$\frac{Pa^2}{2} + C_1 = Pa^2 - \frac{PaL}{2}$$

$$C_1 = \frac{Pa^2}{2} - \frac{PaL}{2}$$

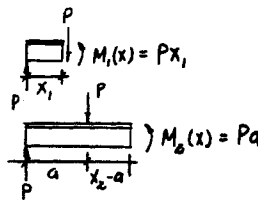

Substitute C_1 into Eq. (5)

$$C_4 = \frac{Pa^3}{6}$$

$$\frac{dv_1}{dx_1} = \frac{P}{2EI} (x_1^2 + a^2 - aL)$$

$$\theta_A = \left. \frac{dv_1}{dx_1} \right|_{x_1=0} = \frac{Pa(a-L)}{2EI} \quad \text{Ans}$$

$$v_1 = \frac{Px_1}{6EI} [x_1^2 + 3a(a-L)] \quad \text{Ans}$$

$$v_2 = \frac{Pa}{6EI} [3x(x-L) + a^2] \quad \text{Ans}$$

$$v_{\max} = v_2 \Big|_{x=\frac{L}{2}} = \frac{Pa}{24EI} (4a^2 - 3L^2) \quad \text{Ans}$$

From *Mechanics of Materials*, Sixth Edition by R. C. Hibbeler, ISBN 0-13-191345-X.

© 2005 R. C. Hibbeler. Published by Pearson Prentice Hall,

Pearson Education, Inc., Upper Saddle River, NJ. All rights reserved.

This material is protected under all copyright laws as they currently exist. No portion of this material may be reproduced, in any form or by any means, without permission in writing from the publisher.

***12-8.** The shaft is supported at A by a journal bearing that exerts only vertical reactions on the shaft, and at C by a thrust bearing that exerts horizontal and vertical reactions on the shaft. Determine the equations of the elastic curve using the coordinates x_1 and x_2 . EI is constant.

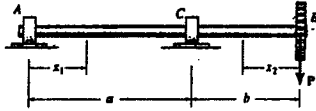

Elastic curve and slope :

$$EI \frac{d^2 v}{dx^2} = M(x)$$

$$\text{For } M_1(x) = -\frac{Pb}{a}x_1$$

$$EI \frac{d^2 v_1}{dx_1^2} = -\frac{Pb}{a}x_1$$

$$EI \frac{dv_1}{dx_1} = -\frac{Pb}{2a}x_1^2 + C_1 \quad (1)$$

$$EI v_1 = -\frac{Pb}{6a}x_1^3 + C_1 x_1 + C_2 \quad (2)$$

$$\text{For } M_2(x) = -Px_2$$

$$EI \frac{d^2 v_2}{dx_2^2} = -Px_2$$

$$EI \frac{dv_2}{dx_2} = -\frac{Px_2^2}{2} + C_3 \quad (3)$$

$$EI v_2 = -\frac{Px_2^3}{6} + C_3 x_2 + C_4 \quad (4)$$

Boundary Conditions :

$$v_1 = 0 \quad \text{at } x = 0$$

$$\text{From Eq. (2), } C_2 = 0$$

$$v_1 = 0 \quad \text{at } x_1 = a$$

From Eq. (2),

$$0 = -\frac{Pb}{6a}a^3 + C_1 a$$

$$C_1 = \frac{Pab}{6}$$

$$v_2 = 0 \quad \text{at } x_2 = b$$

From Eq. (4),

$$0 = -\frac{Pb^3}{6} + C_3 b + C_4$$

$$C_3 b + C_4 = \frac{Pb^3}{6} \quad (5)$$

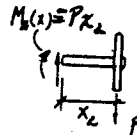
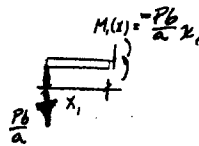

Continuity conditions :

$$\frac{dv_1}{dx_1} = \frac{dv_2}{dx_2} \quad \text{at } x_1 = a \quad x_2 = b$$

From Eqs. (1) and (3)

$$-\frac{Pb}{2a}(a^2) + \frac{Pab}{6} = -\frac{Pb^2}{2} = C_3$$

$$C_3 = \frac{Pab}{3} - \frac{Pb^2}{2}$$

Substitute C_3 into Eq. (5)

$$C_4 = \frac{Pb^3}{3} - \frac{Pab^2}{3}$$

$$v_1 = \frac{-Pb}{6aEI} [x_1^3 - a^2 x_1] \quad \text{Ans}$$

$$v_2 = \frac{P}{6EI} (-x_2^3 + b(2a + 3b)x_2 - 2b^2(a + b)) \quad \text{Ans}$$

From *Mechanics of Materials*, Sixth Edition by R. C. Hibbeler, ISBN 0-13-191345-X.

© 2005 R. C. Hibbeler. Published by Pearson Prentice Hall,

Pearson Education, Inc., Upper Saddle River, NJ. All rights reserved.

This material is protected under all copyright laws as they currently exist. No portion of this material may be reproduced, in any form or by any means, without permission in writing from the publisher.

12-9 The beam is made of two rods and is subjected to the concentrated load P . Determine the maximum deflection of the beam if the moments of inertia of the rods are I_{AB} and I_{BC} , and the modulus of elasticity is E .

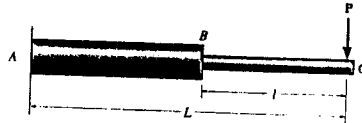

$$EI \frac{d^2 v}{dx^2} = M(x)$$

$$M_1(x) = -Px_1$$

$$EI_{BC} \frac{d^2 v_1}{dx_1^2} = -Px_1$$

$$EI_{BC} \frac{dv_1}{dx_1} = -\frac{Px_1^2}{2} + C_1 \quad (1)$$

$$EI_{BC} v_1 = -\frac{Px_1^3}{6} + C_1 x_1 + C_2 \quad (2)$$

$$M_2(x) = -Px_2$$

$$EI_{AB} \frac{d^2 v_2}{dx_2^2} = -Px_2$$

$$EI_{AB} \frac{dv_2}{dx_2} = -\frac{Px_2^2}{2} + C_3 \quad (3)$$

$$EI_{AB} v_2 = -\frac{Px_2^3}{6} + C_3 x_2 + C_4 \quad (4)$$

Boundary conditions :

$$\text{At } x_2 = L, \frac{dv_2}{dx_2} = 0$$

$$0 = -\frac{PL^2}{2} + C_3; \quad C_3 = \frac{PL^2}{2}$$

$$\text{At } x_2 = L, v = 0$$

$$0 = -\frac{PL^3}{6} + \frac{PL^3}{2} + C_4; \quad C_4 = -\frac{PL^3}{3}$$

Continuity conditions :

$$\text{At } x_1 = x_2 = l, \frac{dv_1}{dx_1} = \frac{dv_2}{dx_2}$$

From Eqs. (1) and (3),

$$\frac{1}{EI_{BC}} \left[-\frac{Pl^2}{2} + C_1 \right] = \frac{1}{EI_{AB}} \left[-\frac{Pl^2}{2} + \frac{Pl^2}{2} \right]$$

$$C_1 = \frac{I_{BC}}{I_{AB}} \left[-\frac{Pl^2}{2} + \frac{Pl^2}{2} \right] + \frac{Pl^2}{2}$$

$$\text{At } x_1 = x_2 = l, v_1 = v_2$$

From Eqs. (2) and (4),

$$\frac{1}{EI_{BC}} \left[-\frac{Pl^3}{6} + \frac{I_{BC}}{I_{AB}} \left(-\frac{Pl^2}{2} + \frac{Pl^2}{2} \right) + \frac{Pl^2}{2} \right] l + C_2 = \frac{1}{EI_{AB}} \left[-\frac{Pl^3}{6} + \frac{PL^2 l}{2} - \frac{PL^3}{3} \right]$$

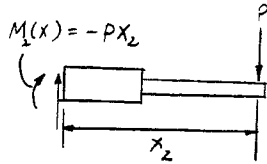
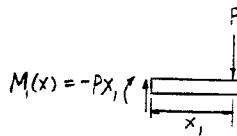

$$C_2 = \frac{I_{BC}}{I_{AB}} \frac{Pl^3}{3} - \frac{I_{BC}}{I_{AB}} \frac{PL^3}{3} - \frac{Pl^3}{3}$$

Therefore,

$$v_1 = \frac{1}{EI_{BC}} \left[-\frac{Px_1^3}{6} + \left[\frac{I_{BC}}{I_{AB}} \left(-\frac{Pl^2}{2} + \frac{Pl^2}{2} \right) + \frac{Pl^2}{2} \right] x_1 + \frac{I_{BC}}{I_{AB}} \frac{Pl^3}{3} - \frac{I_{BC}}{I_{AB}} \frac{PL^3}{3} - \frac{Pl^3}{3} \right]$$

$$\text{At } x_1 = 0, v_1|_{x=0} = v_{\max}$$

$$v_{\max} = \frac{1}{EI_{BC}} \left[\frac{I_{BC}}{I_{AB}} \frac{Pl^3}{3} - \frac{I_{BC}}{I_{AB}} \frac{PL^3}{3} - \frac{Pl^3}{3} \right] = \frac{P}{3EI_{AB}} \left[l^3 - L^3 - \left(\frac{I_{AB}}{I_{BC}} \right) l^3 \right]$$

$$= \frac{P}{3EI_{AB}} \left[\left(1 - \frac{I_{AB}}{I_{BC}} \right) l^3 - L^3 \right] \quad \text{Ans}$$

From *Mechanics of Materials*, Sixth Edition by R. C. Hibbeler, ISBN 0-13-191345-X.

© 2005 R. C. Hibbeler. Published by Pearson Prentice Hall,

Pearson Education, Inc., Upper Saddle River, NJ. All rights reserved.

This material is protected under all copyright laws as they currently exist. No portion of this material may be reproduced, in any form or by any means, without permission in writing from the publisher.

12-10 The beam is made of two rods and is subjected to the concentrated load P . Determine the slope at C . The moments of inertia of the rods are I_{AB} and I_{BC} , and the modulus of elasticity is E .



$$EI \frac{d^2 v}{dx^2} = M(x)$$

$$M_1(x) = -Px_1$$

$$EI_{BC} \frac{d^2 v_1}{dx_1^2} = -Px_1$$

$$EI_{BC} \frac{dv_1}{dx_1} = -\frac{Px_1^2}{2} + C_1 \quad (1)$$

$$M_2(x) = -Px_2$$

$$EI_{AB} \frac{d^2 v_2}{dx_2^2} = -Px_2$$

$$EI_{AB} \frac{dv_2}{dx_2} = -\frac{P}{2}x_2^2 + C_3 \quad (2)$$

Boundary conditions :

$$\text{At } x_2 = L, \quad \frac{dv_2}{dx_2} = 0$$

$$0 = -\frac{PL^2}{2} + C_3 ; \quad C_3 = \frac{PL^2}{2}$$

Continuity conditions :

$$\text{At } x_1 = x_2 = l, \quad \frac{dv_1}{dx_1} = \frac{dv_2}{dx_2}$$

From Eqs. (1) and (2).

$$\frac{1}{EI_{BC}} \left[-\frac{Pl^2}{2} + C_1 \right] = \frac{1}{EI_{AB}} \left[-\frac{Pl^2}{2} + \frac{PL^2}{2} \right]$$

$$C_1 = \frac{I_{BC}}{I_{AB}} \left[-\frac{Pl^2}{2} + \frac{PL^2}{2} \right] + \frac{Pl^2}{2}$$

$$\text{At } x_1 = 0, \quad EI_{BC} \frac{dv_1}{dx_1} = C_1$$

Thus,

$$\frac{dv_1}{dx_1} = \theta_C = \frac{1}{EI_{AB}} \left[-\frac{Pl^2}{2} + \frac{PL^2}{2} \right] + \frac{Pl^2}{2I_{BC}}$$

$$\theta_C = \frac{P}{2E} \left[\frac{1}{I_{AB}} (L^2 - l^2) + \frac{l^2}{I_{BC}} \right] \quad \text{Ans}$$

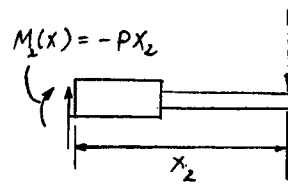
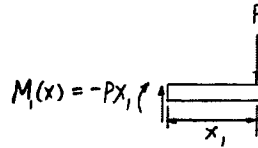

From *Mechanics of Materials*, Sixth Edition by R. C. Hibbeler, ISBN 0-13-191345-X.

© 2005 R. C. Hibbeler. Published by Pearson Prentice Hall,

Pearson Education, Inc., Upper Saddle River, NJ. All rights reserved.

This material is protected under all copyright laws as they currently exist. No portion of this material may be reproduced, in any form or by any means, without permission in writing from the publisher.

12-11. The bar is supported by a roller constraint at B , which allows vertical displacement but resists axial load and moment. If the bar is subjected to the loading shown, determine the slope at A and the deflection at C . EI is constant.

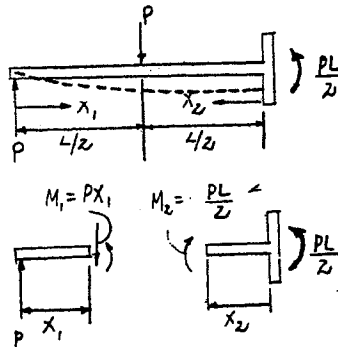
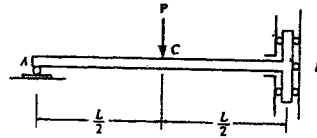

$$EI \frac{d^2 v_1}{dx_1^2} = M_1 = Px_1$$

$$EI \frac{dv_1}{dx_1} = \frac{Px_1^2}{2} + C_1$$

$$EI v_1 = \frac{Px_1^3}{6} + C_1 x_1 + C_2$$

$$EI \frac{d^2 v_2}{dx_2^2} = M_2 = \frac{PL}{2}$$

$$EI \frac{dv_2}{dx_2} = \frac{PL}{2} x_2 + C_3$$

$$EI v_2 = \frac{PL}{4} x_2^2 + C_3 x_2 + C_4$$

Boundary conditions :

$$\text{At } x_1 = 0, v_1 = 0$$

$$0 = 0 + 0 + C_2; \quad C_2 = 0$$

$$\text{At } x_2 = 0, \quad \frac{dv_2}{dx_2} = 0$$

$$0 + C_3 = 0; \quad C_3 = 0$$

$$\text{At } x_1 = \frac{L}{2}, \quad x_2 = \frac{L}{2}, \quad v_1 = v_2, \quad \frac{dv_1}{dx_1} = -\frac{dv_2}{dx_2}$$

$$\frac{P(\frac{L}{2})^3}{6} + C_1(\frac{L}{2}) = \frac{PL(\frac{L}{2})^2}{4} + C_4$$

$$\frac{P(\frac{L}{2})^2}{2} + C_1 = -\frac{PL(\frac{L}{2})}{2}; \quad C_1 = -\frac{3PL^2}{8}$$

$$C_4 = -\frac{11PL^3}{48}$$

$$\text{At } x_1 = 0$$

$$\frac{dv_1}{dx_1} = \theta_A = -\frac{3PL^2}{8EI} \quad \text{Ans}$$

$$\text{At } x_1 = \frac{L}{2}$$

$$v_C = \frac{P(\frac{L}{2})^3}{6EI} - (\frac{3PL^2}{8})(\frac{L}{2}) + 0$$

$$v_C = -\frac{PL^3}{6EI} \quad \text{Ans}$$

From *Mechanics of Materials*, Sixth Edition by R. C. Hibbeler, ISBN 0-13-191345-X.

© 2005 R. C. Hibbeler. Published by Pearson Prentice Hall,

Pearson Education, Inc., Upper Saddle River, NJ. All rights reserved.

This material is protected under all copyright laws as they currently exist. No portion of this material may be reproduced, in any form or by any means, without permission in writing from the publisher.

***12-12.** Determine the deflection at B of the bar in Prob.

$$EI \frac{d^2 v_1}{dx_1^2} = M_1 = Px_1$$

$$EI \frac{dv_1}{dx_1} = \frac{Px_1^2}{2} + C_1$$

$$EI v_1 = \frac{Px_1^3}{6} + C_1 x_1 + C_2$$

$$EI \frac{d^2 v_2}{dx_2^2} = M_2 = \frac{PL}{2}$$

$$EI \frac{dv_2}{dx_2} = \frac{PL}{2} x_2 + C_3$$

$$EI v_2 = \frac{PL}{4} x_2^2 + C_3 x_2 + C_4$$

Boundary conditions :

$$\text{At } x_1 = 0, v_1 = 0$$

$$0 = 0 + 0 + C_2; \quad C_2 = 0$$

$$\text{At } x_2 = 0, \quad \frac{dv_2}{dx_2} = 0$$

$$0 + C_3 = 0; \quad C_3 = 0$$

$$\text{At } x_1 = \frac{L}{2}, \quad x_2 = \frac{L}{2}, v_1 = v_2, \quad \frac{dv_1}{dx_1} = -\frac{dv_2}{dx_2}$$

$$\frac{P(\frac{L}{2})^3}{6} + C_1(\frac{L}{2}) = \frac{PL(\frac{L}{2})^2}{4} + C_4$$

$$\frac{P(\frac{L}{2})^2}{2} + C_1 = -\frac{PL(\frac{L}{2})}{2}; \quad C_1 = -\frac{3}{8}PL$$

$$C_4 = -\frac{11}{48}PL^3$$

$$\text{At } x_2 = 0,$$

$$v_2 = -\frac{11PL^3}{48EI} \quad \text{Ans}$$

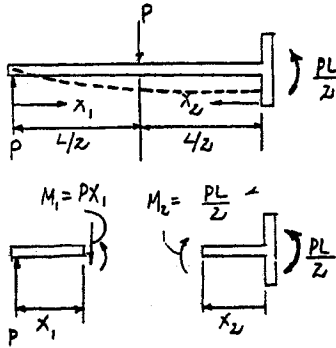

From *Mechanics of Materials*, Sixth Edition by R. C. Hibbeler, ISBN 0-13-191345-X.

© 2005 R. C. Hibbeler. Published by Pearson Prentice Hall,

Pearson Education, Inc., Upper Saddle River, NJ. All rights reserved.

This material is protected under all copyright laws as they currently exist. No portion of this material may be reproduced, in any form or by any means, without permission in writing from the publisher.

12-13 Determine the elastic curve for the cantilevered beam, which is subjected to the couple moment M_0 . Also compute the maximum slope and maximum deflection of the beam. EI is constant.

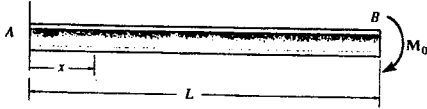

Elastic curve and slope :

$$EI \frac{d^2 v}{dx^2} = M(x)$$

$$EI \frac{d^2 v}{dx^2} = -M_0$$

$$EI \frac{dv}{dx} = -M_0 x + C_1 \quad (1)$$

$$EI v = \frac{-M_0 x^2}{2} + C_1 x + C_2 \quad (2)$$

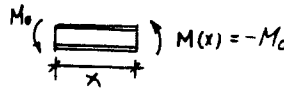

Boundary Conditions :

$$\frac{dv}{dx} = 0 \quad \text{at} \quad x = 0$$

From Eq. (1), $C_1 = 0$

$$v = 0 \quad \text{at} \quad x = 0$$

From Eq. (2), $C_2 = 0$

$$\frac{dv}{dx} = \frac{-M_0 x}{EI}$$

$$\theta_{\max} = \left. \frac{dv}{dx} \right|_{x=L} = \frac{-M_0 L}{EI} \quad \text{Ans}$$

The negative sign indicates clockwise rotation.

$$v = \frac{-M_0 x^2}{2EI} \quad \text{Ans}$$

$$v_{\max} = \left. v \right|_{x=L} = \frac{-M_0 L^2}{2EI} \quad \text{Ans}$$

Negative sign indicates downward displacement.

From *Mechanics of Materials*, Sixth Edition by R. C. Hibbeler, ISBN 0-13-191345-X.

© 2005 R. C. Hibbeler. Published by Pearson Prentice Hall,

Pearson Education, Inc., Upper Saddle River, NJ. All rights reserved.

This material is protected under all copyright laws as they currently exist. No portion of this material may be reproduced, in any form or by any means, without permission in writing from the publisher.

12-14 Determine the equation of the elastic curve for the beam using the x coordinate. Specify the slope at A and the maximum deflection. EI is constant.

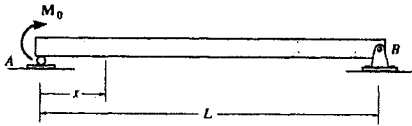

$$EI \frac{d^2 v}{dx^2} = M(x)$$

$$EI \frac{d^2 v}{dx^2} = M_0 \left(1 - \frac{x}{L}\right)$$

$$EI \frac{dv}{dx} = M_0 \left(x - \frac{x^2}{2L}\right) + C_1 \quad (1)$$

$$EI v = M_0 \left(\frac{x^2}{2} - \frac{x^3}{6L}\right) + C_1 x + C_2 \quad (2)$$

Boundary conditions :

$$v = 0 \text{ at } x = 0$$

From Eq. (2), $C_2 = 0$

$$v = 0 \text{ at } x = L$$

From Eq. (2),

$$0 = M_0 \left(\frac{L^2}{2} - \frac{L^3}{6}\right) + C_1 L; \quad C_1 = -\frac{M_0 L}{3}$$

$$\frac{dv}{dx} = \frac{M_0}{EI} \left(x - \frac{x^2}{2L} - \frac{L}{3}\right) \quad (3)$$

$$\theta_A = \left. \frac{dv}{dx} \right|_{x=0} = -\frac{M_0 L}{3EI} \quad \text{Ans}$$

$$\frac{dv}{dx} = 0 = \frac{M_0}{EI} \left(x - \frac{x^2}{2L} - \frac{L}{3}\right)$$

$$3x^2 - 6Lx + 2L^2 = 0; \quad x = 0.42265 L$$

$$v = \frac{M_0}{6EI} (3Lx^2 - x^3 - 2L^2 x) \quad (4) \quad \text{Ans}$$

Substitute x into v ,

$$v_{\max} = \frac{-0.0642 M_0 L^2}{EI} \quad \text{Ans}$$

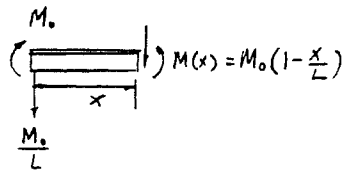

From *Mechanics of Materials*, Sixth Edition by R. C. Hibbeler, ISBN 0-13-191345-X.
 © 2005 R. C. Hibbeler. Published by Pearson Prentice Hall,
 Pearson Education, Inc., Upper Saddle River, NJ. All rights reserved.
 This material is protected under all copyright laws as they currently exist. No portion of this material may be reproduced, in any form or by any means, without permission in writing from the publisher.

12-15 Determine the deflection at the center of the beam and the slope at B. EI is constant.

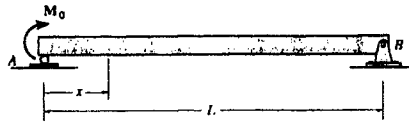

$$EI \frac{d^2v}{dx^2} = M(x)$$

$$EI \frac{d^2v}{dx^2} = M_0 \left(1 - \frac{x}{L}\right)$$

$$EI \frac{dv}{dx} = M_0 \left(x - \frac{x^2}{2L}\right) + C_1 \quad (1)$$

$$EI v = M_0 \left(\frac{x^2}{2} - \frac{x^3}{6L}\right) + C_1 x + C_2 \quad (2)$$

Boundary conditions :
 $v = 0$ at $x = 0$

From Eq. (2), $C_2 = 0$

$v = 0$ at $x = L$

From Eq. (2),

$$0 = M_0 \left(\frac{L^2}{2} - \frac{L^3}{6}\right) + C_1 L; \quad C_1 = -\frac{M_0 L}{3}$$

$$\frac{dv}{dx} = \frac{M_0}{EI} \left(x - \frac{x^2}{2L} - \frac{L}{3}\right) \quad (3)$$

$$\theta_A = \left. \frac{dv}{dx} \right|_{x=0} = -\frac{M_0 L}{3EI} \quad \text{Ans}$$

$$\frac{dv}{dx} = 0 = \frac{M_0}{EI} \left(x - \frac{x^2}{2L} - \frac{L}{3}\right)$$

$$3x^2 - 6Lx + 2L^2 = 0; \quad x = 0.42265 L$$

$$v = \frac{M_0}{6EI} (3Lx^2 - x^3 - 2L^2x) \quad (4) \quad \text{Ans}$$

From Eq. (1) at $x = L$,

$$\theta_B = \left. \frac{dv}{dx} \right|_{x=L} = \frac{M_0 L}{6EI} \quad \text{Ans}$$

From Eq. (2),

$$v \Big|_{x=\frac{L}{2}} = \frac{-M_0 L^2}{16EI} \quad \text{Ans}$$

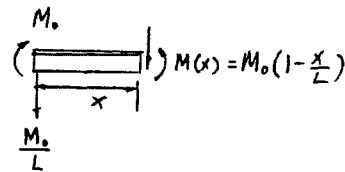
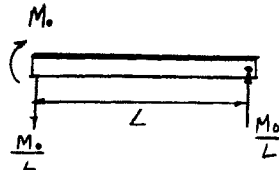

From *Mechanics of Materials*, Sixth Edition by R. C. Hibbeler, ISBN 0-13-191345-X.

© 2005 R. C. Hibbeler. Published by Pearson Prentice Hall,

Pearson Education, Inc., Upper Saddle River, NJ. All rights reserved.

This material is protected under all copyright laws as they currently exist. No portion of this material may be reproduced, in any form or by any means, without permission in writing from the publisher.

***12-16.** Determine the elastic curve for the simply supported beam, which is subjected to the couple moments M_0 . Also, compute the maximum slope and the maximum deflection of the beam. EI is constant.

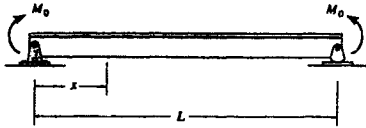

Elastic curve and slope :

$$EI \frac{d^2 v}{dx^2} = M(x)$$

$$EI \frac{d^2 v}{dx^2} = M_0$$

$$EI \frac{dv}{dx} = M_0 x + C_1 \quad (1)$$

$$EI v = \frac{M_0 x^2}{2} + C_1 x + C_2 \quad (2)$$

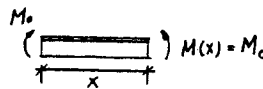

Boundary Conditions :

$$v = 0 \quad \text{at} \quad x = 0$$

From Eq. (2), $C_2 = 0$

$$v = 0 \quad \text{at} \quad x = L$$

From Eq. (2),

$$0 = \frac{M_0 L^2}{2} + C_1 L$$

$$C_1 = \frac{-M_0 L}{2}$$

$$\frac{dv}{dx} = \frac{M_0}{2EI} (2x - L)$$

$$|\theta_{\max}| = |\theta_A| = |\theta_B| = \frac{M_0 L}{2EI} \quad \text{Ans}$$

$$v = \frac{M_0 x}{2EI} (x - L) \quad \text{Ans}$$

Due to symmetry, v_{\max} occurs at $x = \frac{L}{2}$

$$v_{\max} = -\frac{M_0 L^2}{8EI} \quad \text{Ans}$$

The negative sign indicates downward displacement.

From *Mechanics of Materials*, Sixth Edition by R. C. Hibbeler, ISBN 0-13-191345-X.

© 2005 R. C. Hibbeler. Published by Pearson Prentice Hall,

Pearson Education, Inc., Upper Saddle River, NJ. All rights reserved.

This material is protected under all copyright laws as they currently exist. No portion of this material may be reproduced, in any form or by any means, without permission in writing from the publisher.

12-17. Determine the maximum deflection of the beam and the slope at A. EI is constant.

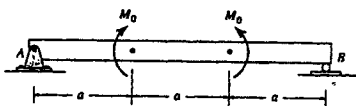

$$M_1 = 0$$

$$EI \frac{d^2 v_1}{dx_1^2} = 0; \quad EI \frac{dv_1}{dx_1} = C_1$$

$$EI v_1 = C_1 x_1 + C_2$$

$$\text{At } x_1 = 0, v_1 = 0; \quad C_2 = 0$$

$$M_2 = M_0; \quad EI \frac{d^2 v_2}{dx_2^2} = M_0$$

$$EI \frac{dv_2}{dx_2} = M_0 x_2 + C_3$$

$$EI v_2 = \frac{1}{2} M_0 x_2^2 + C_3 x_2 + C_4$$

$$\text{At } x_2 = \frac{a}{2}, \frac{dv_2}{dx_2} = 0; \quad C_3 = \frac{-M_0 a}{2}$$

$$\text{At } x_1 = a, x_2 = 0, \quad v_1 = v_2, \quad \frac{dv_1}{dx_1} = \frac{dv_2}{dx_2}$$

$$C_1 a = C_4$$

$$C_1 = \frac{-M_0 a}{2}, \quad C_4 = \frac{-M_0 a^2}{2}$$

$$\text{At } x_1 = 0,$$

$$EI \frac{dv_1}{dx_1} = \frac{-M_0 a}{2}$$

$$\theta_A = \frac{M_0 a}{2EI} \quad \text{Ans}$$

$$\text{At } x_2 = \frac{a}{2},$$

$$EI v_{max} = \frac{1}{2} M_0 \left(\frac{a^2}{4}\right) - \frac{M_0 a}{2} \left(\frac{a}{2}\right) - \frac{M_0 a^2}{2}$$

$$v_{max} = -\frac{5M_0 a^2}{8EI} \quad \text{Ans}$$

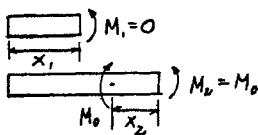

From *Mechanics of Materials*, Sixth Edition by R. C. Hibbeler, ISBN 0-13-191345-X.
 © 2005 R. C. Hibbeler. Published by Pearson Prentice Hall,
 Pearson Education, Inc., Upper Saddle River, NJ. All rights reserved.
 This material is protected under all copyright laws as they currently exist. No portion of this material may be reproduced, in any form or by any means, without permission in writing from the publisher.

12-18 Determine the equations of the elastic curve using the coordinates x_1 and x_2 , and specify the deflection and slope at C. EI is constant.

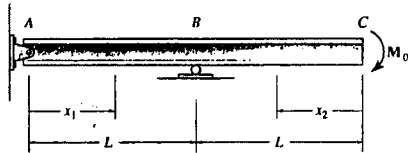

$$EI \frac{d^2 v}{dx^2} = M(x)$$

$$\text{For } M_1(x_1) = -\frac{M_0}{L} x_1$$

$$EI \frac{d^2 v_1}{dx_1^2} = -\frac{M_0}{L} x_1$$

$$EI \frac{dv_1}{dx_1} = -\frac{M_0}{2L} x_1^2 + C_1 \quad (1)$$

$$EI v_1 = -\frac{M_0}{6L} x_1^3 + C_1 x_1 + C_2 \quad (2)$$

$$\text{For } M_2(x) = -M_0; \quad EI \frac{d^2 v_2}{dx_2^2} = -M_0$$

$$EI \frac{dv_2}{dx_2} = -M_0 x_2 + C_3 \quad (3)$$

$$EI v_2 = -\frac{M_0}{2} x_2^2 + C_3 x_2 + C_4 \quad (4)$$

Boundary conditions :

$$\text{At } x_1 = 0, v_1 = 0$$

From Eq. (2),

$$0 = 0 + 0 + C_2; \quad C_2 = 0$$

$$\text{At } x_1 = x_2 = L, v_1 = v_2 = 0$$

From Eq. (2),

$$0 = -\frac{M_0 L^2}{6} + C_1 L; \quad C_1 = \frac{M_0 L}{6}$$

From Eq. (4),

$$0 = -\frac{M_0 L^2}{2} + C_3 L + C_4 \quad (5)$$

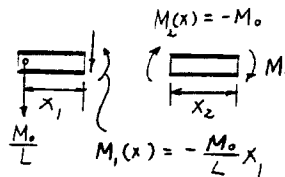

Continuity condition :

$$\text{At } x_1 = x_2 = L, \frac{dv_1}{dx_1} = -\frac{dv_2}{dx_2}$$

From Eqs. (1) and (3),

$$-\frac{M_0 L}{2} + \frac{M_0 L}{6} = -(-M_0 L + C_3); \quad C_3 = \frac{4M_0 L}{3}$$

Substituting C_3 into Eq. (5) yields,

$$C_4 = -\frac{5M_0 L^2}{6}$$

The slope :

$$\frac{dv_2}{dx_2} = \frac{1}{EI} [-M_0 x_2 + \frac{4M_0 L}{3}]$$

$$\theta_C = \left. \frac{dv_2}{dx_2} \right|_{x_2=0} = \frac{4M_0 L}{3EI} \quad \text{Ans}$$

The elastic curve :

$$v_1 = \frac{M_0}{6EI} [-x_1^3 + L^2 x_1] \quad \text{Ans}$$

$$v_2 = \frac{M_0}{6EI} [-3Lx_2^2 + 8L^2 x_2 - 5L^3] \quad \text{Ans}$$

$$v_C = v_2 \Big|_{x_2=0} = -\frac{5M_0 L^2}{6EI} \quad \text{Ans}$$

The negative sign indicates downward deflection.

From *Mechanics of Materials*, Sixth Edition by R. C. Hibbeler, ISBN 0-13-191345-X.

© 2005 R. C. Hibbeler. Published by Pearson Prentice Hall,

Pearson Education, Inc., Upper Saddle River, NJ. All rights reserved.

This material is protected under all copyright laws as they currently exist. No portion of this material may be reproduced, in any form or by any means, without permission in writing from the publisher.

12-19 Determine the equations of the elastic curve using the coordinates x_1 and x_2 , and specify the slope at A . EI is constant.

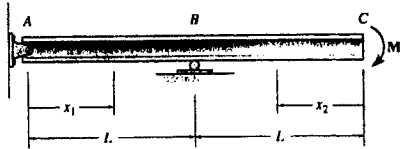

$$EI \frac{d^2 v}{dx^2} = M(x)$$

$$\text{For } M_1(x_1) = -\frac{M_0}{L}x_1$$

$$EI \frac{d^2 v_1}{dx_1^2} = -\frac{M_0}{L}x_1$$

$$EI \frac{dv_1}{dx_1} = -\frac{M_0}{2L}x_1^2 + C_1 \quad (1)$$

$$EI v_1 = -\frac{M_0}{6L}x_1^3 + C_1x_1 + C_2 \quad (2)$$

$$\text{For } M_2(x_2) = -M_0; \quad EI \frac{d^2 v_2}{dx_2^2} = -M_0$$

$$EI \frac{dv_2}{dx_2} = -M_0x_2 + C_3 \quad (3)$$

$$EI v_2 = -\frac{M_0}{2}x_2^2 + C_3x_2 + C_4 \quad (4)$$

Boundary conditions :

$$\text{At } x_1 = 0, \quad v_1 = 0$$

From Eq. (2),

$$0 = 0 + 0 + C_2; \quad C_2 = 0$$

$$\text{At } x_1 = x_2 = L, \quad v_1 = v_2 = 0$$

From Eq. (2),

$$0 = -\frac{M_0L^2}{6} + C_1L; \quad C_1 = \frac{M_0L}{6}$$

From Eq. (4),

$$0 = -\frac{M_0L^2}{2} + C_3L + C_4 \quad (5)$$

Continuity condition :

$$\text{At } x_1 = x_2 = L, \quad \frac{dv_1}{dx_1} = -\frac{dv_2}{dx_2}$$

From Eqs. (1) and (3),

$$-\frac{M_0L}{2} + \frac{M_0L}{6} = -(-M_0L + C_3); \quad C_3 = \frac{4M_0L}{3}$$

Substituting C_3 into Eq. (5) yields,

$$C_4 = -\frac{5M_0L^2}{6}$$

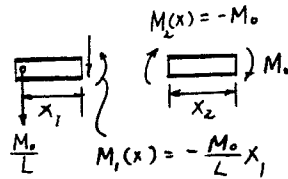
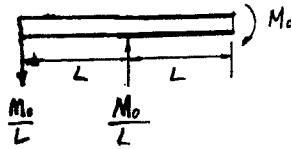

The elastic curve :

$$v_1 = \frac{M_0}{6EI}[-x_1^3 + L^2x_1] \quad \text{Ans}$$

$$v_2 = \frac{M_0}{6EI}[-3Lx_2^2 + 8L^2x_2 - 5L^3] \quad \text{Ans}$$

From Eq. (1),

$$EI \frac{dv_1}{dx_1} = 0 + C_1 = \frac{M_0L}{6}$$

$$\theta_A = \frac{dv_1}{dx_1} = \frac{M_0L}{6EI} \quad \text{Ans}$$

From *Mechanics of Materials*, Sixth Edition by R. C. Hibbeler, ISBN 0-13-191345-X.

© 2005 R. C. Hibbeler. Published by Pearson Prentice Hall,

Pearson Education, Inc., Upper Saddle River, NJ. All rights reserved.

This material is protected under all copyright laws as they currently exist. No portion of this material may be reproduced, in any form or by any means, without permission in writing from the publisher.

*12-20 Determine the equations of the elastic curve using the coordinates x_1 and x_2 , and specify the slope and deflection at B . EI is constant.

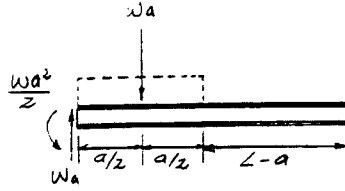
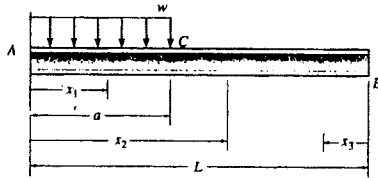

$$EI \frac{d^2 v}{dx^2} = M(x)$$

$$\text{For } M_1(x) = -\frac{w}{2}x_1^2 + wax_1 - \frac{wa^2}{2}$$

$$EI \frac{d^2 v_1}{dx_1^2} = -\frac{w}{2}x_1^2 + wax_1 - \frac{wa^2}{2}$$

$$EI \frac{dv_1}{dx_1} = -\frac{w}{6}x_1^3 + \frac{wa}{2}x_1^2 - \frac{wa^2}{2}x_1 + C_1$$

$$EI v_1 = -\frac{w}{24}x_1^4 + \frac{wa}{6}x_1^3 - \frac{wa^2}{4}x_1^2 + C_1x_1 + C_2$$

$$\text{For } M_2(x) = 0; \quad EI \frac{d^2 v_2}{dx_2^2} = 0$$

$$EI \frac{dv_2}{dx_2} = C_3$$

$$EI v_2 = C_3x_2 + C_4$$

Boundary conditions :

$$\text{At } x_1 = 0, \quad \frac{dv_1}{dx_1} = 0$$

$$\text{From Eq. (1), } C_1 = 0$$

$$\text{At } x_1 = 0, \quad v_1 = 0$$

$$\text{From Eq. (2); } C_2 = 0$$

Continuity conditions :

$$\text{At } x_1 = a, \quad x_2 = a; \quad \frac{dv_1}{dx_1} = \frac{dv_2}{dx_2}$$

From Eqs. (1) and (3),

$$-\frac{wa^3}{6} + \frac{wa^3}{2} - \frac{wa^3}{2} = C_3; \quad C_3 = -\frac{wa^3}{6}$$

$$M_1(x) = -\frac{w}{2}x_1^2 + wax_1 - \frac{wa^2}{2}$$

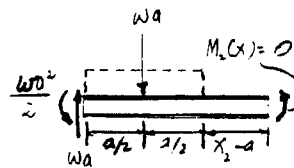

(3)

From Eqs. (2) and (4),

$$\text{At } x_1 = a, \quad x_2 = a \quad v_1 = v_2$$

$$-\frac{wa^4}{24} + \frac{wa^4}{6} - \frac{wa^4}{4} = -\frac{wa^4}{6} + C_4; \quad C_4 = \frac{wa^4}{24}$$

The slope, from Eq. (3),

$$\theta_B = \frac{dv_2}{dx_2} = -\frac{wa^3}{6EI} \quad \text{Ans}$$

The elastic curve :

$$v_1 = \frac{w}{24EI}[-x_1^4 + 4ax_1^3 - 6a^2x_1^2] \quad \text{Ans}$$

$$v_2 = \frac{wa^3}{24EI}[-4x_2 + a] \quad \text{Ans}$$

$$v_B = v_2|_{x_2=L} = \frac{wa^3}{24EI}(-4L + a) \quad \text{Ans}$$

From *Mechanics of Materials*, Sixth Edition by R. C. Hibbeler, ISBN 0-13-191345-X.

© 2005 R. C. Hibbeler. Published by Pearson Prentice Hall,

Pearson Education, Inc., Upper Saddle River, NJ. All rights reserved.

This material is protected under all copyright laws as they currently exist. No portion of this material may be reproduced, in any form or by any means, without permission in writing from the publisher.

12-21 Determine the equations of the elastic curve using the coordinates x_1 and x_3 , and specify the slope and deflection at point B . EI is constant.

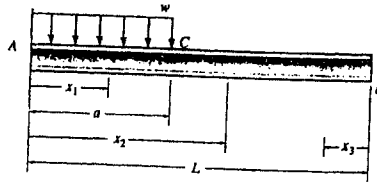

$$EI \frac{d^2 v}{dx^2} = M(x)$$

$$\text{For } M_1(x) = -\frac{w}{2}x_1^2 + wax_1 - \frac{wa^2}{2}$$

$$EI \frac{d^2 v_1}{dx_1^2} = -\frac{w}{2}x_1^2 + wax_1 - \frac{wa^2}{2}$$

$$EI \frac{dv_1}{dx_1} = -\frac{w}{6}x_1^3 + \frac{wa}{2}x_1^2 - \frac{wa^2}{2}x_1 + C_1$$

$$EI v_1 = -\frac{w}{24}x_1^4 + \frac{wa}{6}x_1^3 - \frac{wa^2}{4}x_1^2 + C_1x_1 + C_2 \quad (2)$$

$$\text{For } M_3(x) = 0; \quad EI \frac{d^2 v_3}{dx_3^2} = 0$$

$$EI \frac{dv_3}{dx_3} = C_3 \quad (3)$$

$$EI v_3 = C_3x_3 + C_4 \quad (4)$$

Boundary conditions :

$$\text{At } x_1 = 0, \quad \frac{dv_1}{dx_1} = 0$$

From Eq. (1),

$$0 = -0 + 0 - 0 + C_1; \quad C_1 = 0$$

$$\text{At } x_1 = 0, \quad v_1 = 0$$

From Eq. (2),

$$0 = -0 - 0 - 0 + 0 + C_2; \quad C_2 = 0$$

Continuity conditions :

$$\text{At } x_1 = a, \quad x_3 = L - a; \quad \frac{dv_1}{dx_1} = -\frac{dv_3}{dx_3}$$

$$-\frac{wa^3}{6} + \frac{wa^3}{2} - \frac{wa^3}{2} = -C_3; \quad C_3 = +\frac{wa^3}{6}$$

$$\text{At } x_1 = a, \quad x_3 = L - a \quad v_1 = v_3$$

$$-\frac{wa^4}{24} + \frac{wa^4}{6} - \frac{wa^4}{4} = \frac{wa^3}{6}(L - a) + C_4; \quad C_4 = \frac{wa^4}{24} - \frac{wa^3L}{6}$$

The slope θ

$$\frac{dv_3}{dx_3} = \frac{wa^3}{6EI}$$

$$\theta_B = \left. \frac{dv_3}{dx_3} \right|_{x_3=0} = \frac{wa^3}{6EI} \quad \text{Ans}$$

$$(1) \quad M_1(x) = -\frac{w}{2}x_1^2 + wax_1 - \frac{wa^2}{2}$$

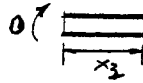

The elastic curve

$$v_1 = \frac{wx_1^3}{24EI}[-x_1^2 + 4ax_1 - 6a^2] \quad \text{Ans}$$

$$v_3 = \frac{wa^3}{24EI}[4x_3 + a - 4L] \quad \text{Ans}$$

$$v_B = v_3|_{x_3=0} = \frac{wa^3}{24EI}(a - 4L) \quad \text{Ans}$$

From *Mechanics of Materials*, Sixth Edition by R. C. Hibbeler, ISBN 0-13-191345-X.

© 2005 R. C. Hibbeler. Published by Pearson Prentice Hall,

Pearson Education, Inc., Upper Saddle River, NJ. All rights reserved.

This material is protected under all copyright laws as they currently exist. No portion of this material may be reproduced, in any form or by any means, without permission in writing from the publisher.

12-22 The floor beam of the airplane is subjected to the loading shown. Assuming that the fuselage exerts only vertical reactions on the ends of the beam, determine the maximum deflection of the beam. EI is constant.

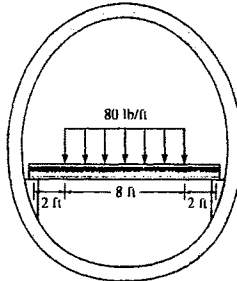

Elastic curve and slope :

$$EI \frac{d^2 v}{dx^2} = M(x)$$

For $M_1(x) = 320x_1$

$$EI \frac{d^2 v_1}{dx_1^2} = 320x_1$$

$$EI \frac{dv_1}{dx_1} = 160x_1^2 + C_1 \quad (1)$$

$$EI v_1 = 53.33x_1^3 + C_1 x_1 + C_2 \quad (2)$$

For $M_2(x) = -40x_2^2 + 480x_2 - 160$

$$EI \frac{d^2 v_2}{dx_2^2} = -40x_2^2 + 480x_2 - 160$$

$$EI \frac{dv_2}{dx_2} = -13.33x_2^3 + 240x_2^2 - 160x_2 + C_3 \quad (3)$$

$$EI v_2 = -3.33x_2^4 + 80x_2^3 - 80x_2^2 + C_3 x_2 + C_4 \quad (4)$$

Boundary Conditions :

$$v_1 = 0 \quad \text{at} \quad x_1 = 0$$

From Eq. (2), $C_2 = 0$

Due to symmetry,

$$\frac{dv_2}{dx_2} = 0 \quad \text{at} \quad x_2 = 6 \text{ ft}$$

From Eq. (3),

$$-2880 + 8640 - 960 + C_3 = 0$$

$$C_3 = -4800$$

Continuity conditions :

$$\frac{dv_1}{dx_1} = \frac{dv_2}{dx_2} \quad \text{at} \quad x_1 = x_2 = 2 \text{ ft}$$

From Eqs. (1) and (3),

$$640 + C_1 = -106.67 + 960 - 320 - 4800$$

$$C_1 = -4906.67$$

$$v_1 = v_2 \quad \text{at} \quad x_1 = x_2 = 2 \text{ ft}$$

From Eqs. (2) and (4),

$$426.67 - 9813.33 = -53.33 + 640 - 320 - 9600 + C_4$$

$$C_4 = -53.33$$

$$v_2 = \frac{1}{EI} (-3.33x_2^4 + 80x_2^3 - 80x_2^2 - 4800x_2 - 53.33)$$

v_{max} occurs at $x_2 = 6 \text{ ft}$

$$v_{max} = v_2 \Big|_{x_2=6} = \frac{-18.8 \text{ kip} \cdot \text{ft}^3}{EI} \quad \text{Ans}$$

The negative sign indicates downward displacement.

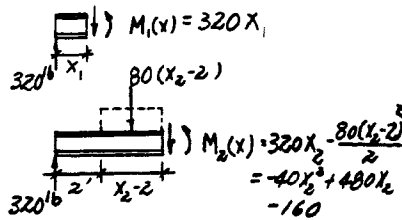

From *Mechanics of Materials*, Sixth Edition by R. C. Hibbeler, ISBN 0-13-191345-X.

© 2005 R. C. Hibbeler. Published by Pearson Prentice Hall,

Pearson Education, Inc., Upper Saddle River, NJ. All rights reserved.

This material is protected under all copyright laws as they currently exist. No portion of this material may be reproduced, in any form or by any means, without permission in writing from the publisher.

12-23 The two wooden meter sticks are separated at their centers by a smooth rigid cylinder having a diameter of 50 mm. Determine the force F that must be applied at each end in order to just make their ends touch. Each stick has a width of 20 mm and a thickness of 5 mm. $E_w = 11$ GPa.

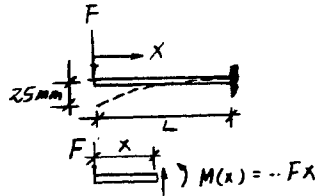
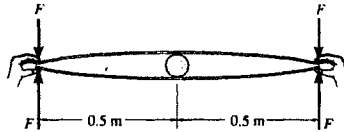

Slope at mid-span is zero, therefore we can model the problem as follows :

$$EI \frac{d^2 v}{dx^2} = M(x)$$

$$EI \frac{d^2 v}{dx^2} = -Fx$$

$$EI \frac{dv}{dx} = \frac{-Fx^2}{2} + C_1 \quad (1)$$

$$EI v = \frac{-Fx^3}{6} + C_1 x + C_2 \quad (2)$$

Boundary conditions :

$$\frac{dv}{dx} = 0 \quad \text{at} \quad x = L$$

From Eq. (1),

$$0 = \frac{-FL^2}{2} + C_1$$

$$C_1 = \frac{FL^2}{2}$$

$$v = 0 \quad \text{at} \quad x = L$$

From Eq. (2),

$$0 = \frac{-FL^3}{6} + \frac{FL^3}{2} + C_2$$

$$C_2 = \frac{-FL^3}{3}$$

$$v = \frac{F}{6EI} (-x^3 + 3L^2x - 2L^3)$$

Require :

$$v = -0.025 \text{ m} \quad \text{at} \quad x = 0$$

$$-0.025 = \frac{F}{6EI} (0 + 0 - 2L^3)$$

$$F = \frac{0.075EI}{L^3}$$

where

$$I = \frac{1}{12} (0.02)(0.005^3) = 0.20833(10^{-9}) \text{ m}^4$$

$$F = \frac{0.075(11)(10^9)(0.20833)(10^{-9})}{(0.5^3)} = 1.375 \text{ N} \quad \text{Ans}$$

From *Mechanics of Materials*, Sixth Edition by R. C. Hibbeler, ISBN 0-13-191345-X.

© 2005 R. C. Hibbeler. Published by Pearson Prentice Hall,

Pearson Education, Inc., Upper Saddle River, NJ. All rights reserved.

This material is protected under all copyright laws as they currently exist. No portion of this material may be reproduced, in any form or by any means, without permission in writing from the publisher.

*12-24 The pipe can be assumed roller supported at its ends and by a rigid saddle C at its center. The saddle rests on a cable that is connected to the supports. Determine the force that should be developed in the cable if the saddle keeps the pipe from sagging or deflecting at its center. The pipe and fluid within it have a combined weight of 125 lb/ft. EI is constant.

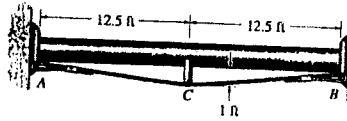

$$2P + F - 125(25) = 0$$

$$2P + F = 3125$$

$$M = Px - \frac{125}{2}x^2$$

$$EI \frac{d^2 v}{dx^2} = Px - \frac{125}{2}x^2$$

$$EI \frac{dv}{dx} = \frac{Px^2}{2} - 20.833x^3 + C_1$$

$$EIv = \frac{Px^3}{6} - 5.2083x^4 + C_1x + C_2$$

At $x = 0$, $v = 0$. Therefore $C_2 = 0$

At $x = 12.5$ ft, $v = 0$.

$$0 = \frac{P(12.5)^3}{6} - 5.2083(12.5)^4 + C_1(12.5) \quad (1)$$

At $x = 12.5$ ft, $\frac{dv}{dx} = 0$.

$$0 = \frac{P(12.5)^2}{2} - 20.833(12.5)^3 + C_1 \quad (2)$$

Solving Eqs. (1) and (2) for P ,

$$P = 585.94 \quad F = 3125 - 2(585.94) = 1953.12 \text{ lb}$$

$$+\uparrow \Sigma F_y = 0; \quad 2R\left(\frac{1}{12.54}\right) - 1953.12 = 0$$

$$R = 12\,246 \text{ lb} = 12.2 \text{ kip} \quad \text{Ans}$$

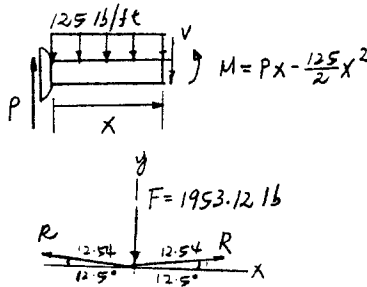
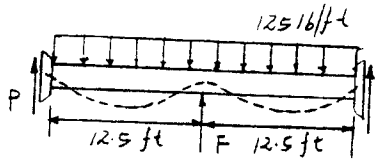

From *Mechanics of Materials*, Sixth Edition by R. C. Hibbeler, ISBN 0-13-191345-X.

© 2005 R. C. Hibbeler. Published by Pearson Prentice Hall,

Pearson Education, Inc., Upper Saddle River, NJ. All rights reserved.

This material is protected under all copyright laws as they currently exist. No portion of this material may be reproduced, in any form or by any means, without permission in writing from the publisher.

12-25 The beam is subjected to the linearly varying distributed load. Determine the maximum slope of the beam. EI is constant.

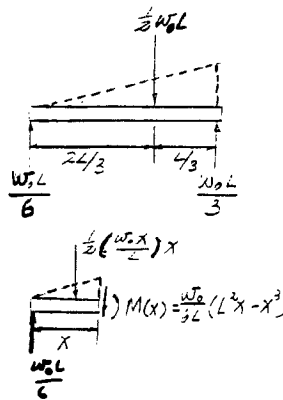
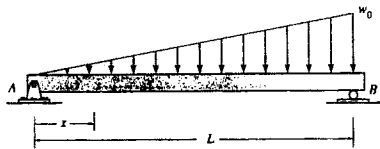

$$EI \frac{d^2 v}{dx^2} = M(x)$$

$$EI \frac{d^2 v}{dx^2} = \frac{w_0}{6L} (L^2 x - x^3)$$

$$EI \frac{dv}{dx} = \frac{w_0}{6L} \left(\frac{L^2 x^2}{2} - \frac{x^4}{4} \right) + C_1 \quad (1)$$

$$EI v = \frac{w_0}{6L} \left(\frac{L^2 x^3}{6} - \frac{x^5}{20} \right) + C_1 x + C_2 \quad (2)$$

Boundary conditions :

At $x = 0$, $v = 0$.

From Eq. (2), $C_2 = 0$

At $x = L$, $v = 0$

From Eq. (2),

$$0 = \frac{w_0}{6L} \left(\frac{L^5}{6} - \frac{L^5}{20} \right) + C_1 L; \quad C_1 = -\frac{7w_0 L^3}{360}$$

The slope :

From Eq.(1),

$$\frac{dv}{dx} = \frac{w_0}{6EI} \left(\frac{L^2 x^2}{2} - \frac{x^4}{4} - \frac{7L^4}{60} \right)$$

$$\theta_{\max} = \left. \frac{dv}{dx} \right|_{x=L} = \frac{w_0 L^3}{45EI} \quad \text{Ans}$$

From *Mechanics of Materials*, Sixth Edition by R. C. Hibbeler, ISBN 0-13-191345-X.

© 2005 R. C. Hibbeler. Published by Pearson Prentice Hall,

Pearson Education, Inc., Upper Saddle River, NJ. All rights reserved.

This material is protected under all copyright laws as they currently exist. No portion of this material may be reproduced, in any form or by any means, without permission in writing from the publisher.

12-26 The beam is subjected to the linearly varying distributed load. Determine the maximum deflection of the beam. EI is constant.

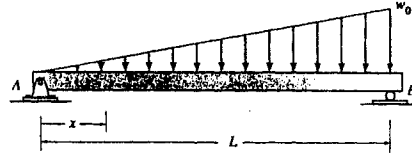

$$EI \frac{d^2 v}{dx^2} = M(x)$$

$$EI \frac{d^2 v}{dx^2} = \frac{w_0}{6L} (L^2 x - x^3)$$

$$EI \frac{dv}{dx} = \frac{w_0}{6L} \left(\frac{L^2 x^2}{2} - \frac{x^4}{4} \right) + C_1$$

$$EI v = \frac{w_0}{6L} \left(\frac{L^2 x^3}{6} - \frac{x^5}{20} \right) + C_1 x + C_2$$

Boundary conditions :

$$v = 0 \text{ at } x = 0.$$

From Eq. (2), $C_2 = 0$

$$v = 0 \text{ at } x = L.$$

From Eq. (2),

$$0 = \frac{w_0}{6L} \left(\frac{L^5}{6} - \frac{L^5}{20} \right) + C_1 L; \quad C_1 = -\frac{7w_0 L^3}{360}$$

$$\frac{dv}{dx} = \frac{w_0}{6EI} \left(\frac{L^2 x^2}{2} - \frac{x^4}{4} - \frac{7L^4}{60} \right)$$

$$\frac{dv}{dx} = 0 = \left(\frac{L^2 x^2}{2} - \frac{x^4}{4} - \frac{7L^4}{60} \right)$$

$$15x^4 - 30L^2 x^2 + 7L^4 = 0; \quad x = 0.5193L$$

$$v = \frac{w_0 x}{360EI} (10L^2 x^2 - 3x^4 - 7L^4)$$

Substitute $x = 0.5193L$ into v ,

$$v_{\max} = -\frac{0.00652w_0 L^4}{EI} \quad \text{Ans}$$

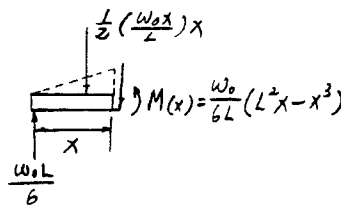
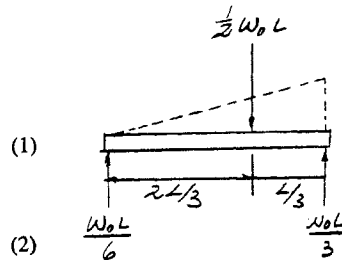

From *Mechanics of Materials*, Sixth Edition by R. C. Hibbeler, ISBN 0-13-191345-X.

© 2005 R. C. Hibbeler. Published by Pearson Prentice Hall,

Pearson Education, Inc., Upper Saddle River, NJ. All rights reserved.

This material is protected under all copyright laws as they currently exist. No portion of this material may be reproduced, in any form or by any means, without permission in writing from the publisher.

12-27 Determine the elastic curve for the simply supported beam using the x coordinate $0 \leq x \leq L/2$. Also, compute the slope at A and the maximum deflection of the beam. EI is constant.

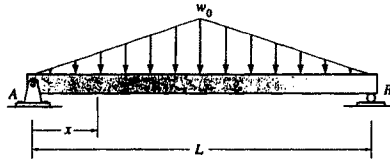

$$EI \frac{d^2 v}{dx^2} = M(x)$$

$$EI \frac{d^2 v}{dx^2} = \frac{w_0 L}{4} x - \frac{w_0}{3L} x^3$$

$$EI \frac{dv}{dx} = \frac{w_0 L}{8} x^2 - \frac{w_0}{12L} x^4 + C_1 \quad (1)$$

$$EI v = \frac{w_0 L}{24} x^3 - \frac{w_0}{60L} x^5 + C_1 x + C_2 \quad (2)$$

Boundary conditions :

Due to symmetry, at $x = \frac{L}{2}$, $\frac{dv}{dx} = 0$

From Eq. (1),

$$0 = \frac{w_0 L}{8} \left(\frac{L^2}{4}\right) - \frac{w_0}{12L} \left(\frac{L^4}{16}\right) + C_1; \quad C_1 = -\frac{5w_0 L^3}{192}$$

At $x = 0$, $v = 0$

From Eq. (2),

$$0 = 0 - 0 + 0 + C_2; \quad C_2 = 0$$

From Eq. (1),

$$\frac{dv}{dx} = \frac{w_0}{192EI} [24L^2 x^2 - 16x^4 - 5L^4]$$

$$\theta_A = \left. \frac{dv}{dx} \right|_{x=0} = -\frac{5w_0 L^3}{192EI} = \frac{5w_0 L^3}{192EI} \quad \text{Ans}$$

From Eq. (2),

$$v = \frac{w_0 x}{960EI} [40L^2 x^2 - 16x^4 - 25L^4] \quad \text{Ans}$$

$$v_{\max} = v \Big|_{x=\frac{L}{2}} = -\frac{w_0 L^4}{120EI} = \frac{w_0 L^4}{120EI} \quad \text{Ans}$$

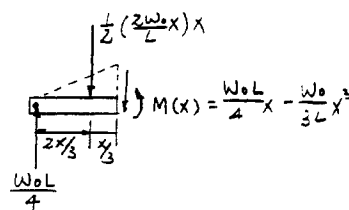
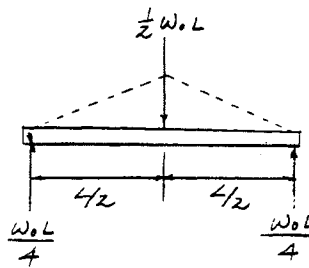

From *Mechanics of Materials*, Sixth Edition by R. C. Hibbeler, ISBN 0-13-191345-X.
 © 2005 R. C. Hibbeler. Published by Pearson Prentice Hall,
 Pearson Education, Inc., Upper Saddle River, NJ. All rights reserved.
 This material is protected under all copyright laws as they currently exist. No portion of this material may be reproduced, in any form or by any means, without permission in writing from the publisher.

*12-28 Determine the elastic curve for the cantilevered beam using the x coordinate. Also compute the maximum slope and maximum deflection. EI is constant.

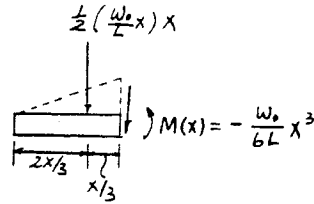
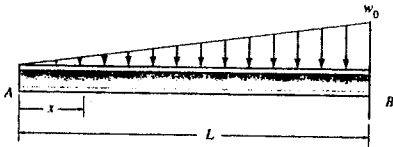

$$EI \frac{d^2 v}{dx^2} = M(x); \quad EI \frac{d^2 v}{dx^2} = -\frac{w_0 x^3}{6L}$$

$$EI \frac{dv}{dx} = -\frac{w_0 x^4}{24L} + C_1 \quad (1)$$

$$EI v = -\frac{w_0 x^5}{120L} + C_1 x + C_2 \quad (2)$$

Boundary conditions :

$$\frac{dv}{dx} = 0 \text{ at } x = L$$

From Eq. (1),

$$0 = -\frac{w_0}{24L}(L^4) + C_1; \quad C_1 = \frac{w_0 L^3}{24}$$

$$v = 0 \text{ at } x = L$$

From Eq. (2),

$$0 = -\frac{w_0}{120L}(L^5) + \frac{w_0 L^3}{24}(L) + C_2; \quad C_2 = -\frac{w_0 L^4}{30}$$

The slope :

From Eq. (1),

$$\frac{dv}{dx} = \frac{w_0}{24EI}(-x^4 + L^4)$$

$$\theta_{\max} = \left. \frac{dv}{dx} \right|_{x=0} = \frac{w_0 L^3}{24EI} \quad \text{Ans}$$

The elastic curve :

From Eq. (2),

$$v = \frac{w_0}{120EI}(-x^5 + 5L^4 x - 4L^5) \quad \text{Ans}$$

$$v_{\max} = v \Big|_{x=0} = \frac{w_0 L^4}{30EI} \quad \text{Ans}$$

From *Mechanics of Materials*, Sixth Edition by R. C. Hibbeler, ISBN 0-13-191345-X.

© 2005 R. C. Hibbeler. Published by Pearson Prentice Hall,

Pearson Education, Inc., Upper Saddle River, NJ. All rights reserved.

This material is protected under all copyright laws as they currently exist. No portion of this material may be reproduced, in any form or by any means, without permission in writing from the publisher.

12-29. The tapered beam has a rectangular cross section. Determine the deflection of its end in terms of the load P , length L , modulus of elasticity E , and the moment of inertia I_0 of its end.

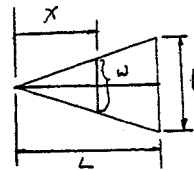
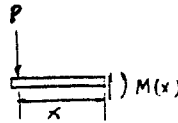
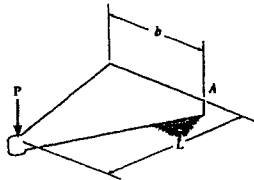

Moment function :
 $M(x) = -Px$

Moment of inertia :
 $w = \frac{b}{L}x; \quad I = \frac{1}{12}(\frac{b}{L}x)^3 = \frac{1}{12}b^3(\frac{x^3}{L^3}) = \frac{I_0}{L^3}x^3$

Slope and elastic curve :
 $EI(x)\frac{d^2v}{dx^2} = M(x)$

$$E(\frac{I_0}{L^3}x^3)\frac{d^2v}{dx^2} = -Px; \quad EI_0\frac{d^2v}{dx^2} = -PLx$$

$$EI_0\frac{dv}{dx} = -PLx + C_1 \quad (1)$$

$$EI_0v = -\frac{PL}{2}x^2 + C_1x + C_2 \quad (2)$$

Boundary conditions :
 $\frac{dv}{dx} = 0$, at $x = L$

From Eq. (1),
 $0 = -PL^2 + C_1; \quad C_1 = PL^2$

$v = 0$, at $x = L$

From Eq. (2),
 $0 = -\frac{PL^3}{2} + PL^3 + C_2; \quad C_2 = -\frac{PL^3}{2}$

$$v = \frac{PL}{2EI_0}(-x^2 + Lx - L^2)$$

at $x = 0, \quad v_{max} = v|_{x=0} = -\frac{PL^3}{2EI_0} \quad \text{Ans}$

The negative sign indicates downward displacement.

From *Mechanics of Materials*, Sixth Edition by R. C. Hibbeler, ISBN 0-13-191345-X.
 © 2005 R. C. Hibbeler. Published by Pearson Prentice Hall,
 Pearson Education, Inc., Upper Saddle River, NJ. All rights reserved.
 This material is protected under all copyright laws as they currently exist. No portion of this material may be reproduced, in any form or by any means, without permission in writing from the publisher.

12-30. The tapered beam has a rectangular cross section. Determine the deflection of its center in terms of the load P , length L , modulus of elasticity E , and the moment of inertia I_c of its center.

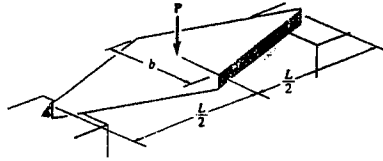

Moment of inertia :

$$w = \frac{2b}{L}x$$

$$I = \frac{1}{12} \left(\frac{2b}{L}x \right) (t^3) = \frac{1}{12} (b) (t^3) \left(\frac{2x}{L} \right) = \left(\frac{2I_c}{L} \right) x$$

Elastic curve and slope :

$$EI(x) \frac{d^2v}{dx^2} = M(x)$$

$$E \left(\frac{2I_c}{L} \right) (x) \frac{d^2v}{dx^2} = \frac{P}{2} x$$

$$EI_c \frac{dv}{dx} = \frac{PL}{4} x + C_1 \quad (1)$$

$$EI_c v_1 = \frac{PL}{8} x^2 + C_1 x + C_2 \quad (2)$$

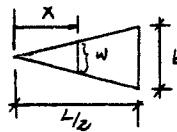
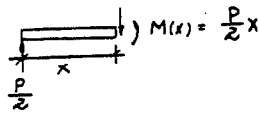

Boundary conditions :

Due to symmetry :

$$\frac{dv}{dx} = 0 \quad \text{at} \quad x = \frac{L}{2}$$

From Eq. (1),

$$0 = \frac{PL^2}{8} + C_1$$

$$C_1 = -\frac{PL^2}{8}$$

$v = 0$ at $x = 0$

$$C_2 = 0$$

$$v = \frac{PLx}{8EI_c} (x - L)$$

$$v_c = v \Big|_{x=\frac{L}{2}} = -\frac{PL^3}{32EI_c} \quad \text{Ans}$$

The negative sign indicates downward displacement.

From *Mechanics of Materials*, Sixth Edition by R. C. Hibbeler, ISBN 0-13-191345-X.

© 2005 R. C. Hibbeler. Published by Pearson Prentice Hall,

Pearson Education, Inc., Upper Saddle River, NJ. All rights reserved.

This material is protected under all copyright laws as they currently exist. No portion of this material may be reproduced, in any form or by any means, without permission in writing from the publisher.

12-31. The beam is made from a plate that has a constant thickness t and a width that varies linearly. The plate is cut into strips to form a series of leaves that are stacked to make a leaf spring consisting of n leaves. Determine the deflection at its end when loaded. Neglect friction between the leaves.

Use the triangular plate for the calculation.

$$M = Px$$

$$I = \frac{1}{12} \left(\frac{b}{L}x\right)(t)^3$$

$$\frac{d^2v}{dx^2} = \frac{M}{EI} = \frac{Px}{E\left(\frac{1}{12}\right)\left(\frac{b}{L}\right)x(t)^3}$$

$$\frac{d^2v}{dx^2} = \frac{12PL}{Ebt^3}$$

$$\frac{dv}{dx} = \frac{12PL}{Ebt^3}x + C_1$$

$$v = \frac{6PL}{Ebt^3}x^2 + C_1x + C_2$$

$$\frac{dv}{dx} = 0 \text{ at } x = L$$

$$C_1 = \frac{-12PL^2}{Ebt^3}$$

$$v = 0 \text{ at } x = L$$

$$C_2 = \frac{6PL^3}{Ebt^3}$$

When $x = 0$

$$v_{\max} = \frac{6PL^3}{Ebt^3} \quad \text{Ans}$$

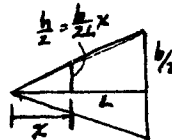
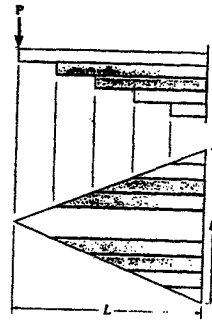

From *Mechanics of Materials*, Sixth Edition by R. C. Hibbeler, ISBN 0-13-191345-X.

© 2005 R. C. Hibbeler. Published by Pearson Prentice Hall,

Pearson Education, Inc., Upper Saddle River, NJ. All rights reserved.

This material is protected under all copyright laws as they currently exist. No portion of this material may be reproduced, in any form or by any means, without permission in writing from the publisher.

***12-32** The beam has a constant width b and is tapered as shown. If it supports a load P at its end, determine the deflection at B . The load P is applied a short distance s from the tapered end B , where $s \ll L$. EI is constant.

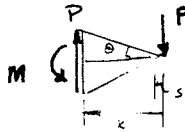
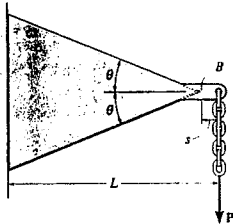

$$M = P x$$

$$I = \frac{1}{12}(b)(2x \tan \theta)^3 = \frac{2}{3}b \tan^3 \theta x^3$$

$$\frac{d^2 y}{dx^2} = \frac{M}{EI} = \frac{P(x)}{E(\frac{2}{3})b \tan^3 \theta x^3} = \frac{3P}{2Eb \tan^3 \theta} \frac{x}{x^3} = \frac{k}{x^2}$$

$$\text{where } k = \frac{3P}{2Eb \tan^3 \theta}$$

$$\frac{dy}{dx} = -k\left(\frac{1}{x}\right) + C_1$$

$$\text{At } x = L, \frac{dy}{dx} = 0,$$

$$C_1 = k\left(\frac{1}{L}\right)$$

$$y = -k(\ln x) + \frac{k}{L}x + C_2$$

$$\text{When } x = L, y = 0,$$

$$C_2 = k(\ln L - 1)$$

$$y = -k \ln x + \frac{k}{L}x + k(\ln L - 1)$$

$$\text{At } x = s,$$

$$y = -k(\ln s) + \frac{ks}{L} + k(\ln L - 1)$$

$$\text{Since } L \gg s,$$

$$y = k \ln\left(\frac{L}{s}\right) - k$$

$$y = \frac{3P}{2Eb \tan^3 \theta} \left(\ln \frac{L}{s} - 1\right) \quad \text{Ans}$$

From *Mechanics of Materials*, Sixth Edition by R. C. Hibbeler, ISBN 0-13-191345-X.

© 2005 R. C. Hibbeler. Published by Pearson Prentice Hall,

Pearson Education, Inc., Upper Saddle River, NJ. All rights reserved.

This material is protected under all copyright laws as they currently exist. No portion of this material may be reproduced, in any form or by any means, without permission in writing from the publisher.

12-33 A thin flexible 20-ft-long rod having a weight of 0.5 lb/ft rests on the smooth surface. If a force of 3 lb is applied at its end to lift it, determine the suspended length x and the maximum moment developed in the rod.

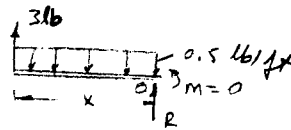
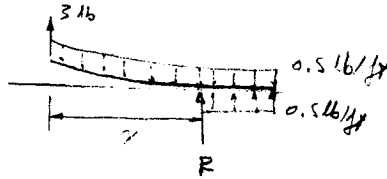
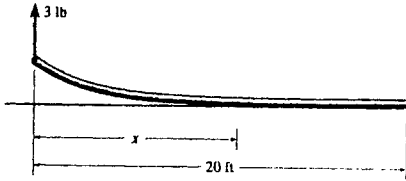

Since the horizontal section has no curvature the moment in the rod is zero. Hence, R acts at the end of the suspended portion and this portion acts like a simply-supported beam. Thus,

$$(+ \Sigma M_0 = 0; \quad -3(x) + (0.5)(x)\left(\frac{x}{2}\right) = 0$$

$$x = 12 \text{ ft} \quad \text{Ans}$$

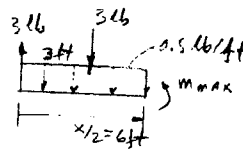

Maximum moment occurs at center.

$$M_{max} = 3(3) = 9 \text{ lb} \cdot \text{ft} \quad \text{Ans}$$

From *Mechanics of Materials*, Sixth Edition by R. C. Hibbeler, ISBN 0-13-191345-X.

© 2005 R. C. Hibbeler. Published by Pearson Prentice Hall,

Pearson Education, Inc., Upper Saddle River, NJ. All rights reserved.

This material is protected under all copyright laws as they currently exist. No portion of this material may be reproduced, in any form or by any means, without permission in writing from the publisher.

12-34. The beam is subjected to the load shown. Determine the equation of the elastic curve. EI is constant.

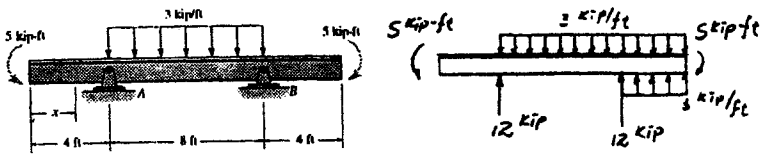

$$M = -5 \langle x-0 \rangle^0 - (-12) \langle x-4 \rangle - \frac{3}{2} \langle x-4 \rangle^2 - (-12) \langle x-12 \rangle - \left(\frac{-3}{2}\right) \langle x-12 \rangle^2$$

$$M = -5 + 12 \langle x-4 \rangle - \frac{3}{2} \langle x-4 \rangle^2 + 12 \langle x-12 \rangle + \frac{3}{2} \langle x-12 \rangle^2$$

Elastic curve and slope :

$$EI \frac{d^2 v}{dx^2} = M$$

$$EI \frac{d^2 v}{dx^2} = -5 + 12 \langle x-4 \rangle - \frac{3}{2} \langle x-4 \rangle^2 + 12 \langle x-12 \rangle + \frac{3}{2} \langle x-12 \rangle^2$$

$$EI \frac{dv}{dx} = -5x + 6 \langle x-4 \rangle^2 - \frac{1}{2} \langle x-4 \rangle^3 + 6 \langle x-12 \rangle^2 + \frac{1}{2} \langle x-12 \rangle^3 + C_1 \quad (1)$$

$$EIv = \frac{-5}{2} x^2 + 2 \langle x-4 \rangle^3 - \frac{1}{8} \langle x-4 \rangle^4 + 2 \langle x-12 \rangle^3 + \frac{1}{8} \langle x-12 \rangle^4 + C_1 x + C_2 \quad (2)$$

Boundary conditions :

$$v = 0 \quad \text{at} \quad x = 4 \text{ ft}$$

From Eq. (2)

$$0 = -40 + 0 - 0 + 0 + 0 + 4C_1 + C_2$$

$$4C_1 + C_2 = 40 \quad (3)$$

$$v = 0 \quad \text{at} \quad x = 12 \text{ ft.}$$

$$0 = -360 + 1024 - 512 + 0 + 0 + 12C_1 + C_2$$

$$12C_1 + C_2 = -152 \quad (4)$$

Solving Eqs. (3) and (4) yields :

$$C_1 = -24 \quad C_2 = 136$$

$$v = \frac{1}{EI} \left[-2.5x^2 + 2 \langle x-4 \rangle^3 - \frac{1}{8} \langle x-4 \rangle^4 + 2 \langle x-12 \rangle^3 + \frac{1}{8} \langle x-12 \rangle^4 - 24x + 136 \right] \text{kip} \cdot \text{ft}^3 \quad \text{Ans}$$

From *Mechanics of Materials*, Sixth Edition by R. C. Hibbeler, ISBN 0-13-191345-X.

© 2005 R. C. Hibbeler. Published by Pearson Prentice Hall,

Pearson Education, Inc., Upper Saddle River, NJ. All rights reserved.

This material is protected under all copyright laws as they currently exist. No portion of this material may be reproduced, in any form or by any means, without permission in writing from the publisher.

12-35 The shaft is supported at A by a journal bearing that exerts only vertical reactions on the shaft, and at C by a thrust bearing that exerts horizontal and vertical reactions on the shaft. Determine the equation of the elastic curve. EI is constant.

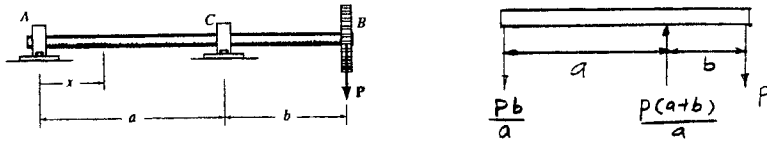

$$M = -\frac{Pb}{a} \langle x-0 \rangle - \left(-\frac{P(a+b)}{a} \right) \langle x-a \rangle = -\frac{Pb}{a}x + \frac{P(a+b)}{a} \langle x-a \rangle$$

$$EI \frac{d^2v}{dx^2} = M$$

$$EI \frac{d^2v}{dx^2} = -\frac{Pb}{a}x + \frac{P(a+b)}{a} \langle x-a \rangle$$

$$EI \frac{dv}{dx} = -\frac{Pb}{2a}x^2 + \frac{P(a+b)}{2a} \langle x-a \rangle^2 + C_1 \quad (1)$$

$$EIv = -\frac{Pb}{6a}x^3 + \frac{P(a+b)}{6a} \langle x-a \rangle^3 + C_1x + C_2 \quad (2)$$

Boundary condition :

At $x = 0, v = 0$

From Eq. (2)

$$0 = -0 + 0 + 0 + C_2; \quad C_2 = 0$$

At $x = a, v = 0$

From Eq. (2)

$$0 = -\frac{Pb}{6a}(a^3) + 0 + C_1a + 0; \quad C_1 = \frac{Pab}{6}$$

From Eq. (2)

$$v = \frac{1}{EI} \left[-\frac{Pb}{6a}x^3 + \frac{P(a+b)}{6a} \langle x-a \rangle^3 + \frac{Pab}{6}x \right] \quad \text{Ans}$$

From *Mechanics of Materials*, Sixth Edition by R. C. Hibbeler, ISBN 0-13-191345-X.

© 2005 R. C. Hibbeler. Published by Pearson Prentice Hall,

Pearson Education, Inc., Upper Saddle River, NJ. All rights reserved.

This material is protected under all copyright laws as they currently exist. No portion of this material may be reproduced, in any form or by any means, without permission in writing from the publisher.

*12-36. The beam is subjected to the load shown. Determine the equation of the elastic curve. EI is constant.

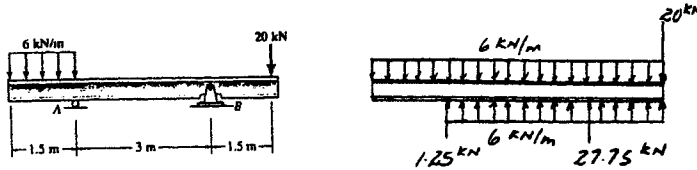

$$M = -\frac{6}{2} \langle x-0 \rangle^2 - (-1.25) \langle x-1.5 \rangle - \left(-\frac{6}{2}\right) \langle x-1.5 \rangle^2 - (-27.75) \langle x-4.5 \rangle$$

$$M = -3x^2 + 1.25 \langle x-1.5 \rangle + 3 \langle x-1.5 \rangle^2 + 27.75 \langle x-4.5 \rangle$$

Elastic curve and slope :

$$EI \frac{d^2v}{dx^2} = M = -3x^2 + 1.25 \langle x-1.5 \rangle + 3 \langle x-1.5 \rangle^2 + 27.75 \langle x-4.5 \rangle$$

$$EI \frac{dv}{dx} = -x^3 + 0.625 \langle x-1.5 \rangle^2 + \langle x-1.5 \rangle^3 + 13.875 \langle x-4.5 \rangle^2 + C_1$$

$$EIv = -0.25x^4 + 0.208 \langle x-1.5 \rangle^3 + 0.25 \langle x-1.5 \rangle^4 + 4.625 \langle x-4.5 \rangle^3 + C_1x + C_2 \quad (1)$$

Boundary conditions :

$$v = 0 \quad \text{at} \quad x = 1.5 \text{ m}$$

From Eq. (1)

$$0 = -1.266 + 1.5C_1 + C_2$$

$$1.5C_1 + C_2 = 1.266 \quad (2)$$

$$v = 0 \quad \text{at} \quad x = 4.5 \text{ m}$$

From Eq. (1)

$$0 = -102.516 + 5.625 + 20.25 + 4.5C_1 + C_2$$

$$4.5C_1 + C_2 = 76.641 \quad (3)$$

Solving Eqs. (2) and (3) yields :

$$C_1 = 25.12$$

$$C_2 = -36.42$$

Ans

$$v = \frac{1}{EI} [-0.25x^4 + 0.208 \langle x-1.5 \rangle^3 + 0.25 \langle x-1.5 \rangle^4 + 4.625 \langle x-4.5 \rangle^3 + 25.1x - 36.4] \text{ kN} \cdot \text{m}^3$$

From *Mechanics of Materials*, Sixth Edition by R. C. Hibbeler, ISBN 0-13-191345-X.

© 2005 R. C. Hibbeler. Published by Pearson Prentice Hall,

Pearson Education, Inc., Upper Saddle River, NJ. All rights reserved.

This material is protected under all copyright laws as they currently exist. No portion of this material may be reproduced, in any form or by any means, without permission in writing from the publisher.

12-37 The shaft supports the two pulley loads shown. Determine the equation of the elastic curve. The bearings at A and B exert only vertical reactions on the shaft. EI is constant.

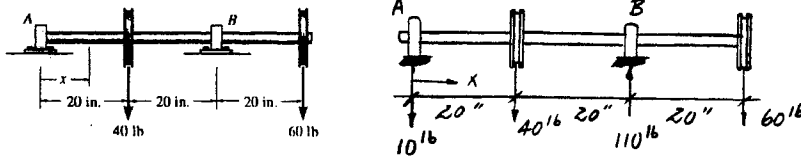

$$M = -10 \langle x-0 \rangle - 40 \langle x-20 \rangle - (-110) \langle x-40 \rangle$$

$$M = -10x - 40 \langle x-20 \rangle + 110 \langle x-40 \rangle$$

Elastic curve and slope :

$$EI \frac{d^2v}{dx^2} = M$$

$$EI \frac{d^2v}{dx^2} = -10x - 40 \langle x-20 \rangle + 110 \langle x-40 \rangle$$

$$EI \frac{dv}{dx} = -5x^2 - 20 \langle x-20 \rangle^2 + 55 \langle x-40 \rangle^2 + C_1$$

$$EIv = -1.667x^3 - 6.667 \langle x-20 \rangle^3 + 18.33 \langle x-40 \rangle^3 + C_1x + C_2 \quad (1)$$

Boundary conditions :

$$v = 0 \text{ at } x = 0$$

From Eq. (1) :

$$C_2 = 0$$

$$v = 0 \text{ at } x = 40 \text{ in.}$$

$$0 = -106,666.67 - 53,333.33 + 0 + 40C_1$$

$$C_1 = 4000$$

$$v = \frac{1}{EI} [-1.67x^3 - 6.67 \langle x-20 \rangle^3 + 18.3 \langle x-40 \rangle^3 + 4000x] \text{ lb} \cdot \text{in}^3 \quad \text{Ans}$$

From *Mechanics of Materials*, Sixth Edition by R. C. Hibbeler, ISBN 0-13-191345-X.

© 2005 R. C. Hibbeler. Published by Pearson Prentice Hall,

Pearson Education, Inc., Upper Saddle River, NJ. All rights reserved.

This material is protected under all copyright laws as they currently exist. No portion of this material may be reproduced, in any form or by any means, without permission in writing from the publisher.

12-38 The shaft supports the two pulley loads shown. Determine the equation of the elastic curve. The bearings at *A* and *B* exert only vertical reactions on the shaft. *EI* is constant.

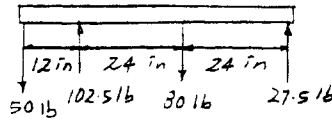
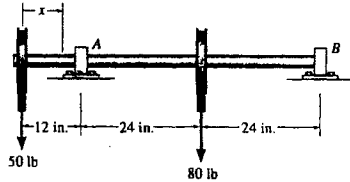

$$M = -50 \langle x-0 \rangle - (-102.5) \langle x-12 \rangle - 80 \langle x-36 \rangle$$

$$= -50x + 102.5 \langle x-12 \rangle - 80 \langle x-36 \rangle$$

$$EI \frac{d^2 v}{dx^2} = M$$

$$EI \frac{d^2 v}{dx^2} = -50x + 102.5 \langle x-12 \rangle - 80 \langle x-36 \rangle$$

$$EI \frac{dv}{dx} = -25x^2 + \frac{102.5}{2} \langle x-12 \rangle^2 - 40 \langle x-36 \rangle^2 + C_1 \quad (1)$$

$$EI v = -\frac{25}{3} x^3 + \frac{102.5}{6} \langle x-12 \rangle^3 - \frac{40}{3} \langle x-36 \rangle^3 + C_1 x + C_2 \quad (2)$$

Boundary conditions :
At $x = 12$ in., $v = 0$

From Eq. (2),

$$0 = -\frac{25}{3}(12)^3 + 0 - 0 + 12C_1 + C_2$$

$$12C_1 + C_2 = 14400 \quad (3)$$

At $x = 60$ in., $v = 0$

$$0 = -\frac{25}{3}(60)^3 + \frac{102.5}{6}(60-12)^3 - \frac{40}{3}(60-36)^3 + 60C_1 + C_2$$

$$60C_1 + C_2 = 95040 \quad (4)$$

Solving Eqs. (3) and (4) yields :

$$C_1 = 1680 \quad C_2 = -5760$$

The elastic curve. From Eq. (2),

$$v = \frac{1}{EI} [-8.33x^3 + 17.1 \langle x-12 \rangle^3 - 13.3 \langle x-36 \rangle^3 + 1680x - 5760] \text{ lb} \cdot \text{in}^3 \quad \text{Ans}$$

From *Mechanics of Materials*, Sixth Edition by R. C. Hibbeler, ISBN 0-13-191345-X.

© 2005 R. C. Hibbeler. Published by Pearson Prentice Hall,

Pearson Education, Inc., Upper Saddle River, NJ. All rights reserved.

This material is protected under all copyright laws as they currently exist. No portion of this material may be reproduced, in any form or by any means, without permission in writing from the publisher.

12-39. The shaft supports the two pulley loads shown. Determine the slope of the shaft at the bearings *A* and *B*. The bearings exert only vertical reactions on the shaft. *EI* is constant.

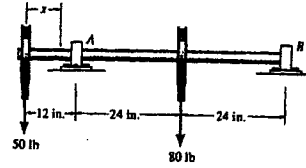

$$M = -50 \langle x-0 \rangle - (-102.5) \langle x-12 \rangle - 80 \langle x-36 \rangle$$

$$= -50x + 102.5 \langle x-12 \rangle - 80 \langle x-36 \rangle$$

$$EI \frac{d^2 v}{dx^2} = M$$

$$EI \frac{d^2 v}{dx^2} = -50x + 102.5 \langle x-12 \rangle - 80 \langle x-36 \rangle$$

$$EI \frac{dv}{dx} = -25x^2 + \frac{102.5}{2} \langle x-12 \rangle^2 - 40 \langle x-36 \rangle^2 + C_1$$

$$EIv = -\frac{25}{3}x^3 + \frac{102.5}{6} \langle x-12 \rangle^3 - \frac{40}{3} \langle x-36 \rangle^3 + C_1x + C_2 \quad (1)$$

Boundary conditions :

$$\text{At } x = 12 \text{ in.}, v = 0$$

From Eq. (2),

$$0 = -\frac{25}{3}(12)^3 + 0 - 0 + 12C_1 + C_2$$

$$12C_1 + C_2 = 14400 \quad (3)$$

$$\text{At } x = 60 \text{ in.}, v = 0$$

$$0 = -\frac{25}{3}(60)^3 + \frac{102.5}{6}(60-12)^3 - \frac{40}{3}(60-36)^3 + 60C_1 + C_2$$

$$60C_1 + C_2 = 95040 \quad (4)$$

Solving Eqs. (3) and (4) yields :

$$C_1 = 1680 \quad C_2 = -5760$$

$$EI \frac{dv}{dx} = -25x^2 + 51.25 \langle x-12 \rangle^2 - 40 \langle x-36 \rangle^2 + 1680$$

$$\text{At } x = 12 \text{ in.}$$

$$\theta_A = \frac{1}{EI} (-25(12^2) + 0 - 0 + 1680)$$

$$\theta_A = \frac{-1920}{EI} \quad \text{Ans}$$

$$\text{At } x = 60 \text{ in.},$$

$$\theta_B = \frac{1}{EI} (-25(60^2) + 51.25(60-12)^2 - 40(60-36)^2 + 1680)$$

$$\theta_B = \frac{6720 \text{ lb} \cdot \text{in}^2}{EI} \quad \text{Ans}$$

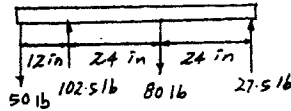

From *Mechanics of Materials*, Sixth Edition by R. C. Hibbeler, ISBN 0-13-191345-X.

© 2005 R. C. Hibbeler. Published by Pearson Prentice Hall,

Pearson Education, Inc., Upper Saddle River, NJ. All rights reserved.

This material is protected under all copyright laws as they currently exist. No portion of this material may be reproduced, in any form or by any means, without permission in writing from the publisher.

*12-40 The beam is subjected to the loads shown. Determine the equation of the elastic curve. EI is constant.

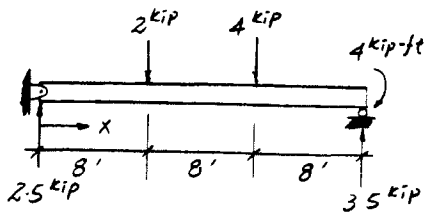
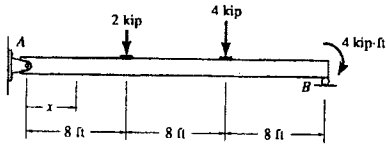

$$M = -(-2.5) \langle x-0 \rangle - 2 \langle x-8 \rangle - 4 \langle x-16 \rangle$$

$$M = 2.5x - 2 \langle x-8 \rangle - 4 \langle x-16 \rangle$$

Elastic curve and slope :

$$EI \frac{d^2v}{dx^2} = M = 2.5x - 2 \langle x-8 \rangle - 4 \langle x-16 \rangle$$

$$EI \frac{dv}{dx} = 1.25x^2 - \langle x-8 \rangle^2 - 2 \langle x-16 \rangle^2 + C_1$$

$$EIv = 0.417x^3 - 0.333 \langle x-8 \rangle^3 - 0.667 \langle x-16 \rangle^3 + C_1x + C_2 \quad (1)$$

Boundary conditions :

$$v = 0 \quad \text{at} \quad x = 0$$

From Eq. (1), $C_2 = 0$

$$v = 0 \quad \text{at} \quad x = 24 \text{ ft}$$

$$0 = 5760 - 1365.33 - 341.33 + 24C_1$$

$$C_1 = -169$$

$$v = \frac{1}{EI} [0.417x^3 - 0.333 \langle x-8 \rangle^3 - 0.667 \langle x-16 \rangle^3 - 169x] \text{ kip} \cdot \text{ft}^3 \quad \text{Ans}$$

From *Mechanics of Materials*, Sixth Edition by R. C. Hibbeler, ISBN 0-13-191345-X.

© 2005 R. C. Hibbeler. Published by Pearson Prentice Hall,

Pearson Education, Inc., Upper Saddle River, NJ. All rights reserved.

This material is protected under all copyright laws as they currently exist. No portion of this material may be reproduced, in any form or by any means, without permission in writing from the publisher.

12-41 Determine the equation of the elastic curve. EI is constant.

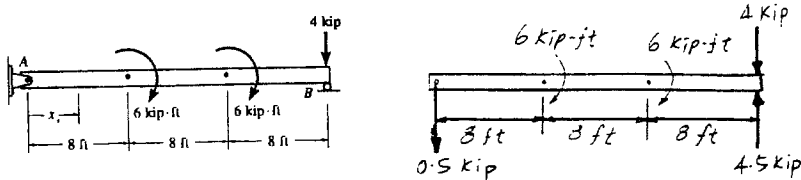

$$M = -0.5 \langle x-0 \rangle - (-6) \langle x-8 \rangle^0 - (-6) \langle x-16 \rangle^0$$

$$= -0.5x + 6 \langle x-8 \rangle^0 + 6 \langle x-16 \rangle^0$$

$$EI \frac{d^2 v}{dx^2} = M$$

$$EI \frac{d^2 v}{dx^2} = -0.5x + 6 \langle x-8 \rangle^0 + 6 \langle x-16 \rangle^0$$

$$EI \frac{dv}{dx} = -0.25x^2 + 6 \langle x-8 \rangle + 6 \langle x-16 \rangle + C_1 \quad (1)$$

$$EI v = -\frac{0.25}{3}x^3 + 3 \langle x-8 \rangle^2 + 3 \langle x-16 \rangle^2 + C_1 x + C_2 \quad (2)$$

Boundary conditions :

At $x=0$, $v = 0$

From Eq. (2),

$$0 = -0 + 0 + 0 + 0 + C_2; \quad C_2 = 0$$

At $x=24$ ft, $v = 0$

$$0 = -\frac{0.25}{3}(24)^3 + 3(24-8)^2 + 3(24-16)^2 + 24C_1; \quad C_1 = 8.0$$

The elastic curve :

$$v = \frac{1}{EI} [-0.0833x^3 + 3 \langle x-8 \rangle^2 + 3 \langle x-16 \rangle^2 + 8.00x] \quad \text{Ans}$$

From *Mechanics of Materials*, Sixth Edition by R. C. Hibbeler, ISBN 0-13-191345-X.
 © 2005 R. C. Hibbeler. Published by Pearson Prentice Hall,
 Pearson Education, Inc., Upper Saddle River, NJ. All rights reserved.
 This material is protected under all copyright laws as they currently exist. No portion of this material may be reproduced, in any form or by any means, without permission in writing from the publisher.

12-42 The beam is subjected to the load shown. Determine the equations of the slope and elastic curve. EI is constant.

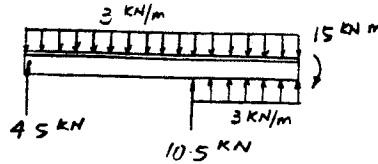
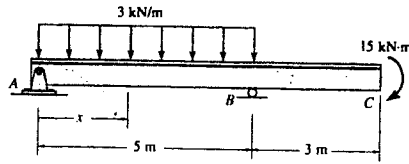

$$M = -(-4.5) \langle x-0 \rangle - \frac{3}{2} \langle x-0 \rangle^2 - (-10.5) \langle x-5 \rangle - \left(\frac{-3}{2}\right) \langle x-5 \rangle^2$$

$$M = 4.5x - 1.5x^2 + 10.5 \langle x-5 \rangle + 1.5 \langle x-5 \rangle^2$$

Elastic curve and slope :

$$EI \frac{d^2v}{dx^2} = M = 4.5x - 1.5x^2 + 10.5 \langle x-5 \rangle + 1.5 \langle x-5 \rangle^2$$

$$EI \frac{dv}{dx} = 2.25x^2 - 0.5x^3 + 5.25 \langle x-5 \rangle^2 + 0.5 \langle x-5 \rangle^3 + C_1 \quad (1)$$

$$EIv = 0.75x^3 - 0.125x^4 + 1.75 \langle x-5 \rangle^3 + 0.125 \langle x-5 \rangle^4 + C_1x + C_2 \quad (2)$$

Boundary conditions :

$$v = 0 \quad \text{at} \quad x = 0$$

From Eq. (2), $C_2 = 0$

$$v = 0 \quad \text{at} \quad x = 5$$

$$0 = 93.75 - 78.125 + 5C_1$$

$$C_1 = -3.125$$

$$\frac{dv}{dx} = \frac{1}{EI} [2.25x^2 - 0.5x^3 + 5.25 \langle x-5 \rangle^2 + 0.5 \langle x-5 \rangle^3 - 3.125] \text{ kN} \cdot \text{m}^2 \quad \text{Ans}$$

$$v = \frac{1}{EI} [0.75x^3 - 0.125x^4 + 1.75 \langle x-5 \rangle^3 + 0.125 \langle x-5 \rangle^4 - 3.125x] \text{ kN} \cdot \text{m}^3 \quad \text{Ans}$$

From *Mechanics of Materials*, Sixth Edition by R. C. Hibbeler, ISBN 0-13-191345-X.

© 2005 R. C. Hibbeler. Published by Pearson Prentice Hall,

Pearson Education, Inc., Upper Saddle River, NJ. All rights reserved.

This material is protected under all copyright laws as they currently exist. No portion of this material may be reproduced, in any form or by any means, without permission in writing from the publisher.

12-43. The beam is subjected to the load shown. Determine the equation of the elastic curve. EI is constant.

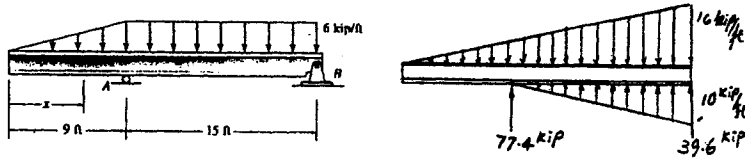

$$M = -\frac{1}{6} \left(\frac{16}{24} \right) \langle x-0 \rangle^3 - (-77.4) \langle x-9 \rangle - \left(-\frac{1}{6} \right) \left(\frac{10}{15} \right) \langle x-9 \rangle^3$$

$$M = -0.1111x^3 + 77.4 \langle x-9 \rangle + 0.1111 \langle x-9 \rangle^3$$

Elastic curve and slope :

$$EI \frac{d^2v}{dx^2} = M = -0.1111x^3 + 77.4 \langle x-9 \rangle + 0.1111 \langle x-9 \rangle^3$$

$$EI \frac{dv}{dx} = -0.02778x^4 + 38.7 \langle x-9 \rangle^2 + 0.02778 \langle x-9 \rangle^4 + C_1$$

$$EIv = -0.005556x^5 + 12.9 \langle x-9 \rangle^3 + 0.005556 \langle x-9 \rangle^5 + C_1x + C_2 \quad (1)$$

Boundary conditions :

$$v = 0 \quad \text{at} \quad x = 9 \text{ ft}$$

From Eq. (1)

$$0 = -328.05 + 0 + 0 + 9C_1 + C_2$$

$$9C_1 + C_2 = 328.05 \quad (2)$$

$$v = 0 \quad \text{at} \quad x = 24 \text{ ft}$$

$$0 = -44236.8 + 43537.5 + 4218.75 + 24C_1 + C_2$$

$$24C_1 + C_2 = -3519.45 \quad (3)$$

Solving Eqs. (2) and (3) yields,

$$C_1 = -256 \quad C_2 = 2637$$

$$v = \frac{1}{EI} [-0.005556x^5 + 12.9 \langle x-9 \rangle^3 + 0.005556 \langle x-9 \rangle^5 - 256x + 2637] \text{kip} \cdot \text{ft}^3 \quad \text{Ans}$$

From *Mechanics of Materials*, Sixth Edition by R. C. Hibbeler, ISBN 0-13-191345-X.

© 2005 R. C. Hibbeler. Published by Pearson Prentice Hall,

Pearson Education, Inc., Upper Saddle River, NJ. All rights reserved.

This material is protected under all copyright laws as they currently exist. No portion of this material may be reproduced, in any form or by any means, without permission in writing from the publisher.

*12-44. The wooden beam is subjected to the load shown. Determine the equation of the elastic curve. If $E_w = 12 \text{ GPa}$, determine the deflection and the slope at end B .

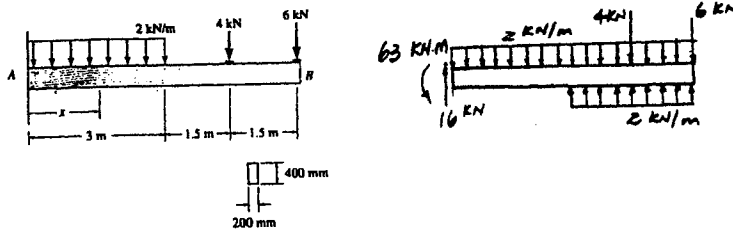

$$M = -63 \langle x-0 \rangle^0 - (-16) \langle x-0 \rangle - \frac{2}{2} \langle x-0 \rangle^2 - \left(-\frac{2}{2}\right) \langle x-3 \rangle^2 - 4 \langle x-4.5 \rangle$$

$$M = -63 + 16x - x^2 + \langle x-3 \rangle^2 - 4 \langle x-4.5 \rangle$$

Elastic curve and slope :

$$EI \frac{d^2 v}{dx^2} = M = 63 + 16x - x^2 + \langle x-3 \rangle^2 - 4 \langle x-4.5 \rangle$$

$$EI \frac{dv}{dx} = -63x + 8x^2 - \frac{x^3}{3} + \frac{1}{3} \langle x-3 \rangle^3 - 2 \langle x-4.5 \rangle^2 + C_1 \quad (1)$$

$$EIv = -31.5x^2 + \frac{8}{3}x^3 - \frac{x^4}{12} + \frac{1}{12} \langle x-3 \rangle^4 - \frac{2}{3} \langle x-4.5 \rangle^3 + C_1 x + C_2 \quad (2)$$

Boundary conditions :

$$\frac{dv}{dx} = 0 \quad \text{at } x = 0$$

From Eq. (1), $C_1 = 0$

$$v = 0 \quad \text{at } x = 0$$

From Eq. (2), $C_2 = 0$

$$\frac{dv}{dx} = \frac{1}{EI} \left[-63x + 8x^2 - \frac{x^3}{3} + \frac{1}{3} \langle x-3 \rangle^3 - 2 \langle x-4.5 \rangle^2 \right] \quad (3)$$

$$v = \frac{1}{EI} \left[-31.5x^2 + \frac{8}{3}x^3 - \frac{x^4}{12} + \frac{1}{12} \langle x-3 \rangle^4 - \frac{2}{3} \langle x-4.5 \rangle^3 \right] \text{ kN} \cdot \text{m}^3 \quad (4) \quad \text{Ans}$$

$$I = \frac{1}{12} (0.20)(0.40)^3 = 1.067(10^{-3}) \text{ m}^4$$

At point B , $x = 6 \text{ m}$

$$\theta_B = \left. \frac{dv}{dx} \right|_{x=6\text{m}} = \frac{-157.5}{EI} = \frac{-157.5(10^3)}{12(10^9)(1.067)(10^{-3})} = -0.123 \text{ rad} = -0.705^\circ \quad \text{Ans}$$

The negative sign indicates clockwise rotation.

$$v_B = \frac{-661.5}{EI} = \frac{-661.5(10^3)}{12(10^9)(1.067)(10^{-3})} = -0.0517 \text{ m} = -51.7 \text{ mm} \quad \text{Ans}$$

The negative sign indicates downward displacement.

From *Mechanics of Materials*, Sixth Edition by R. C. Hibbeler, ISBN 0-13-191345-X.

© 2005 R. C. Hibbeler. Published by Pearson Prentice Hall,

Pearson Education, Inc., Upper Saddle River, NJ. All rights reserved.

This material is protected under all copyright laws as they currently exist. No portion of this material may be reproduced, in any form or by any means, without permission in writing from the publisher.

12-45 The beam is subjected to the load shown. Determine the equation of the elastic curve. EI is constant.

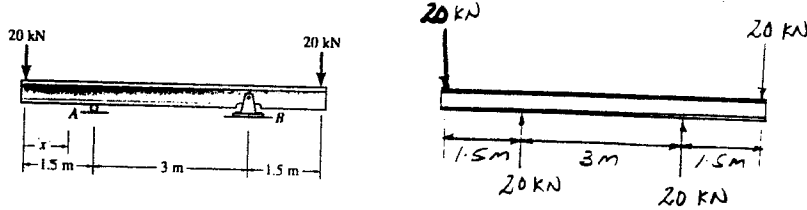

$$M = -20 \langle x-0 \rangle - (-20) \langle x-1.5 \rangle - (-20) \langle x-4.5 \rangle$$

$$= -20x + 20 \langle x-1.5 \rangle + 20 \langle x-4.5 \rangle$$

$$EI \frac{d^2v}{dx^2} = M$$

$$EI \frac{d^2v}{dx^2} = -20x + 20 \langle x-1.5 \rangle + 20 \langle x-4.5 \rangle$$

$$EI \frac{dv}{dx} = -10x^2 + 10 \langle x-1.5 \rangle^2 + 10 \langle x-4.5 \rangle^2 + C_1 \quad (1)$$

$$EIv = -\frac{10}{3}x^3 + \frac{10}{3} \langle x-1.5 \rangle^3 + \frac{10}{3} \langle x-4.5 \rangle^3 + C_1x + C_2 \quad (2)$$

Boundary conditions :

Due to symmetry, at $x = 3 \text{ m}$, $\frac{dv}{dx} = 0$

From Eq. (1),

$$0 = -10(3^2) + 10(1.5)^2 + 0 + C_1; \quad C_1 = 67.5$$

At $x = 1.5 \text{ m}$, $v = 0$

From Eq. (2),

$$0 = -\frac{10}{3}(1.5)^3 + 0 + 0 + 67.5(1.5) + C_2; \quad C_2 = -90.0$$

Hence,

$$v = \frac{1}{EI} \left[-\frac{10}{3}x^3 + \frac{10}{3} \langle x-1.5 \rangle^3 + \frac{10}{3} \langle x-4.5 \rangle^3 + 67.5x - 90 \right] \text{ kN} \cdot \text{m}^3 \quad \text{Ans}$$

From *Mechanics of Materials*, Sixth Edition by R. C. Hibbeler, ISBN 0-13-191345-X.

© 2005 R. C. Hibbeler. Published by Pearson Prentice Hall,

Pearson Education, Inc., Upper Saddle River, NJ. All rights reserved.

This material is protected under all copyright laws as they currently exist. No portion of this material may be reproduced, in any form or by any means, without permission in writing from the publisher.

12-46 The wooden beam is subjected to the load shown. Determine the equation of the elastic curve. Specify the deflection at the end C. $E_w = 1.6(10^3)$ ksi.

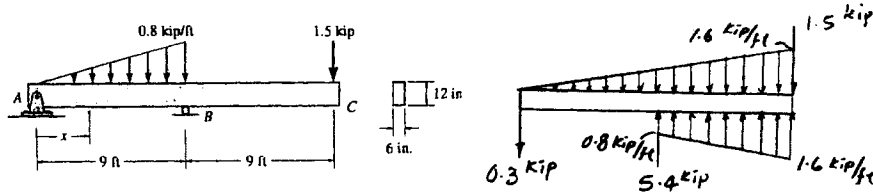

$$M = -0.3 \langle x-0 \rangle - \frac{1}{6} \left(\frac{1.6}{18} \right) \langle x-0 \rangle^3 - (-5.4) \langle x-9 \rangle - \left(-\frac{0.8}{2} \right) \langle x-9 \rangle^2 - \frac{1}{6} \left(-\frac{0.8}{9} \right) \langle x-9 \rangle^3$$

$$M = -0.3x - 0.0148x^3 + 5.4 \langle x-9 \rangle + 0.4 \langle x-9 \rangle^2 + 0.0148 \langle x-9 \rangle^3$$

Elastic curve and slope :

$$EI \frac{d^2 v}{dx^2} = M = -0.3x - 0.0148x^3 + 5.4 \langle x-9 \rangle + 0.4 \langle x-9 \rangle^2 + 0.0148 \langle x-9 \rangle^3$$

$$EI \frac{dv}{dx} = -0.15x^2 - 0.003704x^4 + 2.7 \langle x-9 \rangle^2 + 0.1333 \langle x-9 \rangle^3 + 0.003704 \langle x-9 \rangle^4 + C_1$$

$$EIv = -0.05x^3 - 0.0007407x^5 + 0.9 \langle x-9 \rangle^3 + 0.03333 \langle x-9 \rangle^4 + 0.0007407 \langle x-9 \rangle^5 + C_1x + C_2$$

Boundary conditions :

$$v = 0 \quad \text{at} \quad x = 0 \quad (1)$$

From Eq. (1)

$$C_2 = 0$$

$$v = 0 \quad \text{at} \quad x = 9 \text{ ft}$$

From Eq. (1)

$$0 = -36.45 - 43.74 + 0 + 0 + 0 + 9C_1$$

$$C_1 = 8.91$$

$$v = \frac{1}{EI} [-0.05x^3 - 0.000741x^5 + 0.9 \langle x-9 \rangle^3 + 0.0333 \langle x-9 \rangle^4 + 0.000741 \langle x-9 \rangle^5 + 8.91x] \text{kip} \cdot \text{ft}^3$$

Ans

At point C, $x = 18 \text{ ft}$

$$v_C = \frac{-612.29 \text{ kip} \cdot \text{ft}^3}{EI} = \frac{-612.29(12^3)}{1.6(10^3)(\frac{1}{12})(6)(12^3)} = -0.765 \text{ in.} \quad \text{Ans}$$

The negative sign indicates downward displacement.

From *Mechanics of Materials*, Sixth Edition by R. C. Hibbeler, ISBN 0-13-191345-X.

© 2005 R. C. Hibbeler. Published by Pearson Prentice Hall,

Pearson Education, Inc., Upper Saddle River, NJ. All rights reserved.

This material is protected under all copyright laws as they currently exist. No portion of this material may be reproduced, in any form or by any means, without permission in writing from the publisher.

12-47 Determine the slope at B and the deflection at C for the $W10 \times 45$ beam. $E_M = 29(10^3)$ ksi.

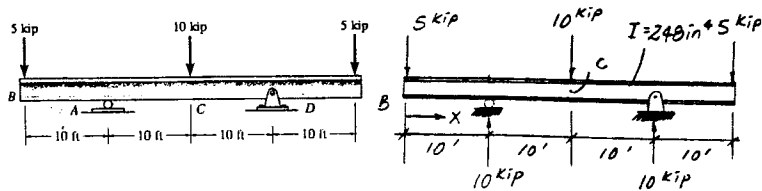

$$M = -5 \langle x-0 \rangle - (-10) \langle x-10 \rangle - 10 \langle x-20 \rangle - (-10) \langle x-30 \rangle$$

$$M = -5x + 10 \langle x-10 \rangle - 10 \langle x-20 \rangle + 10 \langle x-30 \rangle$$

Elastic curve and slope:

$$EI \frac{d^2v}{dx^2} = M = -5x + 10 \langle x-10 \rangle - 10 \langle x-20 \rangle + 10 \langle x-30 \rangle$$

$$EI \frac{dv}{dx} = -2.5x^2 + 5 \langle x-10 \rangle^2 - 5 \langle x-20 \rangle^2 + 5 \langle x-30 \rangle^2 + C_1$$

$$EIv = -0.833x^3 + 1.67 \langle x-10 \rangle^3 - 1.67 \langle x-20 \rangle^3 + 1.67 \langle x-30 \rangle^3 + C_1x + C_2 \quad (1)$$

Boundary conditions:

$$v = 0 \quad \text{at} \quad x = 10 \text{ ft}$$

From Eq. (1)

$$0 = -833.33 + 0 = 0 = 10C_1 + C_2$$

$$10C_1 + C_2 = 833.33 \quad (2)$$

$$v = 0 \quad \text{at} \quad x = 30 \text{ ft}$$

From Eq. (1)

$$0 = -22500 + 13333.33 - 1666.67 + 30C_1 + C_2$$

$$30C_1 + C_2 = 10833.33 \quad (3)$$

Solving Eqs. (2) and (3) yields:

$$C_1 = 500 \quad C_2 = -4167$$

$$\frac{dv}{dx} = \frac{1}{EI} [-2.5x^2 + 5 \langle x-10 \rangle^2 - 5 \langle x-20 \rangle^2 + 5 \langle x-30 \rangle^2 + 5000]$$

$$\theta_B = \left. \frac{dv}{dx} \right|_{x=0} = \frac{500}{EI} \quad \text{where } I = 248 \text{ in}^4 \text{ for a } W10 \times 45$$

$$= \frac{500(144)}{29(10^3)(248)} = 0.0100 \text{ rad} = 0.574^\circ \quad \text{Ans}$$

$$v = \frac{1}{EI} [-0.833x^3 + 1.67 \langle x-10 \rangle^3 - 1.67 \langle x-20 \rangle^3 + 1.67 \langle x-30 \rangle^3 + 500x - 4167]$$

At point C, $x = 20$ ft

$$v_C = \frac{833.33}{EI} = \frac{833.33(1728)}{29(10^3)(248)} = 0.200 \text{ in.} \quad \text{Ans}$$

From *Mechanics of Materials*, Sixth Edition by R. C. Hibbeler, ISBN 0-13-191345-X.

© 2005 R. C. Hibbeler. Published by Pearson Prentice Hall,

Pearson Education, Inc., Upper Saddle River, NJ. All rights reserved.

This material is protected under all copyright laws as they currently exist. No portion of this material may be reproduced, in any form or by any means, without permission in writing from the publisher.

*12-48 Determine the deflection at each of the pulleys C, D, and E. The shaft is made of steel and has a diameter of 30 mm. The bearings at A and B exert only vertical reactions on the shaft. $E_{st} = 200 \text{ GPa}$.

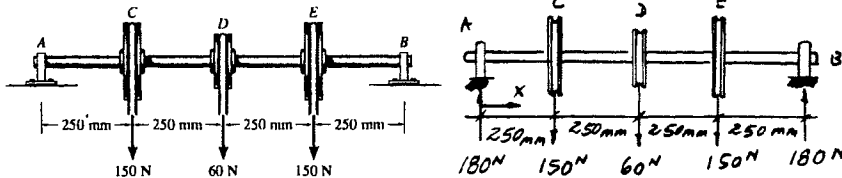

$$M = -(-180) < x - 0 > -150 < x - 0.25 > -60 < x - 0.5 > -150 < x - 0.75 >$$

$$M = 180x - 150 < x - 0.25 > -60 < x - 0.5 > -150 < x - 0.75 >$$

Elastic curve and slope :

$$EI \frac{d^2 v}{dx^2} = M = 180x - 150 < x - 0.25 > -60 < x - 0.5 > -150 < x - 0.75 >$$

$$EI \frac{dv}{dx} = 90x^2 - 75 < x - 0.25 >^2 - 30 < x - 0.50 >^2 - 75 < x - 0.75 >^2 + C_1 \quad (1)$$

$$EIv = 30x^3 - 25 < x - 0.25 >^3 - 10 < x - 0.50 >^3 - 25 < x - 0.75 >^3 + C_1 x + C_2 \quad (2)$$

Boundary conditions :

$$v = 0 \quad \text{at} \quad x = 0$$

From Eq. (2)

$$C_2 = 0$$

$$v = 0 \quad \text{at} \quad x = 1.0 \text{ m}$$

$$0 = 30 - 10.55 - 1.25 - 0.39 + C_1$$

$$C_1 = -17.8125$$

$$\frac{dv}{dx} = \frac{1}{EI} [90x^2 - 75 < x - 0.25 >^2 - 30 < x - 0.5 >^2 - 75 < x - 0.75 >^2 - 17.8125] \quad (3)$$

$$v = \frac{1}{EI} [30x^3 - 25 < x - 0.25 >^3 - 10 < x - 0.5 >^3 - 25 < x - 0.75 >^3 - 17.8125x]$$

$$v_C = v \Big|_{x=0.25 \text{ m}} = \frac{-3.984}{EI} = \frac{-3.984}{200(10^9) \frac{\pi}{4} (0.015)^4} = -0.000501 \text{ m} = -0.501 \text{ mm} \quad \text{Ans}$$

$$v_D = v \Big|_{x=0.5 \text{ m}} = \frac{-5.547}{200(10^9) \frac{\pi}{4} (0.015)^4} = -0.000698 \text{ m} = -0.698 \text{ mm} \quad \text{Ans}$$

$$v_E = v \Big|_{x=0.75 \text{ m}} = \frac{-3.984}{EI} = -0.501 \text{ mm} \quad \text{Ans} \quad (\text{symmetry check !})$$

The negative signs indicate downward displacement.

From *Mechanics of Materials*, Sixth Edition by R. C. Hibbeler, ISBN 0-13-191345-X.
 © 2005 R. C. Hibbeler. Published by Pearson Prentice Hall,
 Pearson Education, Inc., Upper Saddle River, NJ. All rights reserved.
 This material is protected under all copyright laws as they currently exist. No portion of this material may be reproduced, in any form or by any means, without permission in writing from the publisher.

12-49 Determine the slope of the shaft at the bearings at *A* and *B*. The shaft is made of steel and has a diameter of 30 mm. The bearings at *A* and *B* exert only vertical reactions on the shaft. $E_{st} = 200$ GPa.

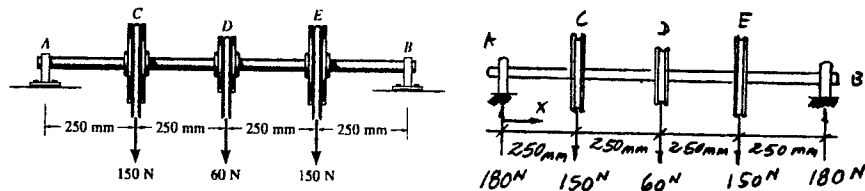

$$M = -(-180) \langle x-0 \rangle - 150 \langle x-0.25 \rangle - 60 \langle x-0.5 \rangle - 150 \langle x-0.75 \rangle$$

$$M = 180x - 150 \langle x-0.25 \rangle - 60 \langle x-0.5 \rangle - 150 \langle x-0.75 \rangle$$

Elastic curve and slope :

$$EI \frac{d^2v}{dx^2} = M = 180x - 150 \langle x-0.25 \rangle - 60 \langle x-0.5 \rangle - 150 \langle x-0.75 \rangle$$

$$EI \frac{dv}{dx} = 90x^2 - 75 \langle x-0.25 \rangle^2 - 30 \langle x-0.50 \rangle^2 - 75 \langle x-0.75 \rangle^2 + C_1 \quad (1)$$

$$EIv = 30x^3 - 25 \langle x-0.25 \rangle^3 - 10 \langle x-0.50 \rangle^3 - 25 \langle x-0.75 \rangle^3 + C_1x + C_2 \quad (2)$$

Boundary conditions :

$$v = 0 \quad \text{at} \quad x = 0$$

From Eq. (2)

$$C_2 = 0$$

$$v = 0 \quad \text{at} \quad x = 1.0 \text{ m}$$

$$0 = 30 - 10.55 - 1.25 - 0.39 + C_1$$

$$C_1 = -17.8125$$

$$\frac{dv}{dx} = \frac{1}{EI} [90x^2 - 75 \langle x-0.25 \rangle^2 - 30 \langle x-0.5 \rangle^2 - 75 \langle x-0.75 \rangle^2 - 17.8125] \quad (3)$$

$$\theta_A = \left. \frac{dv}{dx} \right|_{x=0} = \frac{-17.8125}{EI} = \frac{-17.8125}{200(10^9) \frac{\pi}{4} (0.015)^4} = -0.00224 \text{ rad} = -0.128^\circ \quad \text{Ans}$$

The negative sign indicates clockwise rotation.

$$\theta_B = \left. \frac{dv}{dx} \right|_{x=1 \text{ m}} = \frac{17.8125}{EI} = 0.128^\circ \quad \text{Ans}$$

The positive result indicates counterclockwise rotation.

From *Mechanics of Materials*, Sixth Edition by R. C. Hibbeler, ISBN 0-13-191345-X.

© 2005 R. C. Hibbeler. Published by Pearson Prentice Hall,

Pearson Education, Inc., Upper Saddle River, NJ. All rights reserved.

This material is protected under all copyright laws as they currently exist. No portion of this material may be reproduced, in any form or by any means, without permission in writing from the publisher.

12-50 Determine the equation of the elastic curve. Specify the slope at A. EI is constant.

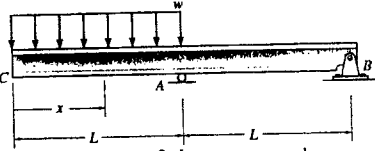

$$M = -\frac{1}{2}wx \langle x-0 \rangle^2 - \left(-\frac{3wL}{2}\right) \langle x-L \rangle - \left(-\frac{1}{2}w\right) \langle x-L \rangle^2$$

$$= -\frac{1}{2}wx^2 + \frac{3wL}{2} \langle x-L \rangle + \frac{1}{2}w \langle x-L \rangle^2$$

$$EI \frac{d^2v}{dx^2} = M$$

$$EI \frac{d^2v}{dx^2} = -\frac{1}{2}wx^2 + \frac{3wL}{2} \langle x-L \rangle + \frac{1}{2}w \langle x-L \rangle^2$$

$$EI \frac{dv}{dx} = -\frac{w}{6}x^3 + \frac{3wL}{4} \langle x-L \rangle^2 + \frac{w}{6} \langle x-L \rangle^3 + C_1 \quad (1)$$

$$EI v = -\frac{w}{24}x^4 + \frac{wL}{4} \langle x-L \rangle^3 + \frac{w}{24} \langle x-L \rangle^4 + C_1x + C_2 \quad (2)$$

Boundary conditions :

$$\text{At } x = L, v = 0$$

From Eq. (2),

$$0 = -\frac{w}{24}L^4 + C_1L + C_2 \quad (3)$$

$$\text{At } x = 2L, v = 0$$

From Eq. (2),

$$0 = -\frac{w}{24}(2L)^4 + \frac{wL}{4}(2L-L)^3 + \frac{w}{24}(2L-L)^4 + C_1(2L) + C_2$$

$$0 = -\frac{3wL^4}{8} + 2LC_1 + C_2 \quad (4)$$

Solving Eqs. (3) and (4) yields :

$$C_1 = \frac{wL^3}{3}, \quad C_2 = -\frac{7wL^4}{24}$$

The elastic curve :

$$v = \frac{1}{EI} \left[-\frac{w}{24}x^4 + \frac{wL}{4} \langle x-L \rangle^3 + \frac{w}{24} \langle x-L \rangle^4 + \frac{wL^3}{3}x - \frac{7wL^4}{24} \right] \quad \text{Ans}$$

At $x = L$, from Eq. (1),

$$EI \frac{dv}{dx} = -\frac{w}{6}L^3 + 0 + 0 + \frac{wL^3}{3}$$

$$\theta_A = \frac{wL^3}{6EI}$$

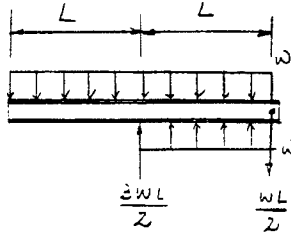

Ans

From *Mechanics of Materials*, Sixth Edition by R. C. Hibbeler, ISBN 0-13-191345-X.
 © 2005 R. C. Hibbeler. Published by Pearson Prentice Hall,
 Pearson Education, Inc., Upper Saddle River, NJ. All rights reserved.
 This material is protected under all copyright laws as they currently exist. No portion of this material may be reproduced, in any form or by any means, without permission in writing from the publisher.

12-51 Determine the equation of the elastic curve. Specify the deflection at C. EI is constant.

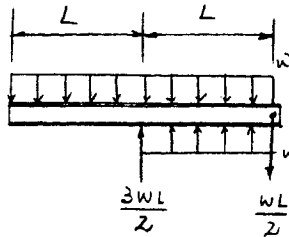
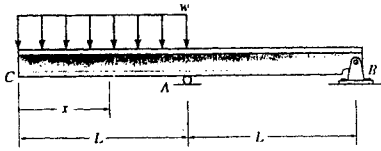

$$M = -\frac{1}{2}w \langle x-0 \rangle^2 - \left(-\frac{3wL}{2}\right) \langle x-L \rangle - \left(-\frac{1}{2}w\right) \langle x-L \rangle^2$$

$$= -\frac{1}{2}wx^2 + \frac{3wL}{2} \langle x-L \rangle + \frac{1}{2}w \langle x-L \rangle^2$$

$$EI \frac{d^2v}{dx^2} = M$$

$$EI \frac{d^2v}{dx^2} = -\frac{1}{2}wx^2 + \frac{3wL}{2} \langle x-L \rangle + \frac{1}{2}w \langle x-L \rangle^2$$

$$EI \frac{dv}{dx} = -\frac{w}{6}x^3 + \frac{3wL}{4} \langle x-L \rangle^2 + \frac{w}{6} \langle x-L \rangle^3 + C_1 \quad (1)$$

$$EI v = -\frac{w}{24}x^4 + \frac{wL}{4} \langle x-L \rangle^3 + \frac{w}{24} \langle x-L \rangle^4 + C_1x + C_2 \quad (2)$$

Boundary conditions :
At $x = L$, $v = 0$

From Eq. (2),

$$0 = -\frac{w}{24}L^4 + C_1L + C_2 \quad (3)$$

At $x = 2L$, $v = 0$

From Eq. (2),

$$0 = -\frac{w}{24}(2L)^4 + \frac{wL}{4}(2L-L)^3 + \frac{w}{24}(2L-L)^4 + C_1(2L) + C_2$$

$$0 = -\frac{3wL^4}{8} + 2LC_1 + C_2 \quad (4)$$

Solving Eqs. (3) and (4) yields :

$$C_1 = \frac{wL^3}{3}, \quad C_2 = -\frac{7wL^4}{24}$$

$$v = \frac{1}{EI} \left[-\frac{w}{24}x^4 + \frac{wL}{4} \langle x-L \rangle^3 + \frac{w}{24} \langle x-L \rangle^4 + \frac{wL^3}{3}x - \frac{7wL^4}{24} \right]$$

At $x = 0$,

$$v_C = -\frac{7wL^4}{24EI} \quad \text{Ans}$$

From *Mechanics of Materials*, Sixth Edition by R. C. Hibbeler, ISBN 0-13-191345-X.
 © 2005 R. C. Hibbeler. Published by Pearson Prentice Hall,
 Pearson Education, Inc., Upper Saddle River, NJ. All rights reserved.
 This material is protected under all copyright laws as they currently exist. No portion of this material may be reproduced, in any form or by any means, without permission in writing from the publisher.

*12-52 Determine the equation of the elastic curve. Specify the slope at B. EI is constant.

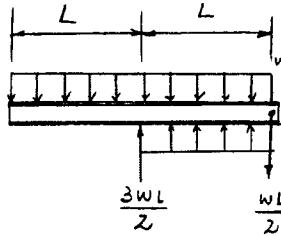
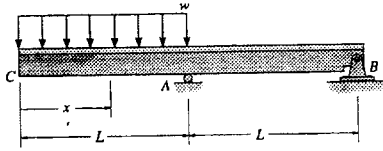

$$M = -\frac{1}{2}w \langle x-0 \rangle^2 - \left(-\frac{3wL}{2}\right) \langle x-L \rangle - \left(-\frac{1}{2}w\right) \langle x-L \rangle^2$$

$$= -\frac{1}{2}wx^2 + \frac{3wL}{2} \langle x-L \rangle + \frac{1}{2}w \langle x-L \rangle^2$$

$$EI \frac{d^2v}{dx^2} = M$$

$$EI \frac{d^2v}{dx^2} = -\frac{1}{2}wx^2 + \frac{3wL}{2} \langle x-L \rangle + \frac{1}{2}w \langle x-L \rangle^2$$

$$EI \frac{dv}{dx} = -\frac{w}{6}x^3 + \frac{3wL}{4} \langle x-L \rangle^2 + \frac{w}{6} \langle x-L \rangle^3 + C_1 \quad (1)$$

$$EI v = -\frac{w}{24}x^4 + \frac{wL}{4} \langle x-L \rangle^3 + \frac{w}{24} \langle x-L \rangle^4 + C_1x + C_2 \quad (2)$$

Boundary conditions :

$$\text{At } x = L, v = 0$$

From Eq. (2),

$$0 = -\frac{w}{24}L^4 + C_1L + C_2 \quad (3)$$

$$\text{At } x = 2L, v = 0$$

From Eq. (2),

$$0 = -\frac{w}{24}(2L)^4 + \frac{wL}{4}(2L-L)^3 + \frac{w}{24}(2L-L)^4 + C_1(2L) + C_2$$

$$0 = -\frac{3wL^4}{8} + 2LC_1 + C_2 \quad (4)$$

Solving Eqs. (3) and (4) yields :

$$C_1 = \frac{wL^3}{3}, \quad C_2 = -\frac{7wL^4}{24}$$

$$v = \frac{1}{EI} \left[-\frac{w}{24}x^4 + \frac{wL}{4} \langle x-L \rangle^3 + \frac{w}{24} \langle x-L \rangle^4 + \frac{wL^3}{3}x - \frac{7wL^4}{24} \right]$$

From Eq. (1), at $x = 2L$,

$$EI \frac{dv}{dx} = -\frac{w}{6}(2L)^3 + \frac{3wL}{4}(L)^2 + \frac{w}{6}(L)^3 + \frac{w}{3}(L^3)$$

$$\theta_B = -\frac{wL^3}{12EI} \quad \text{Ans}$$

From *Mechanics of Materials*, Sixth Edition by R. C. Hibbeler, ISBN 0-13-191345-X.

© 2005 R. C. Hibbeler. Published by Pearson Prentice Hall,

Pearson Education, Inc., Upper Saddle River, NJ. All rights reserved.

This material is protected under all copyright laws as they currently exist. No portion of this material may be reproduced, in any form or by any means, without permission in writing from the publisher.

12-53 The shaft is made of steel and has a diameter of 15 mm. Determine its maximum deflection. The bearings at A and B exert only vertical reactions on the shaft. $E_{st} = 200$ GPa.

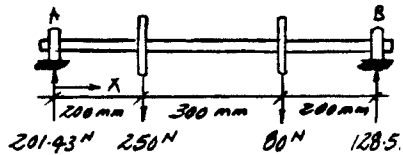
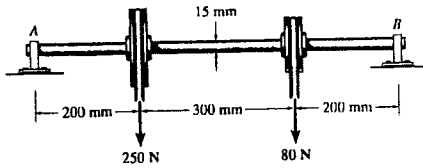

$$M = -(-201.43) < x - 0 > - 250 < x - 0.2 > - 80 < x - 0.5 >$$

$$M = 201.43x - 250 < x - 0.2 > - 80 < x - 0.5 >$$

Elastic curve and slope :

$$EI \frac{d^2 v}{dx^2} = M = 201.43x - 250 < x - 0.2 > - 80 < x - 0.5 >$$

$$EI \frac{dv}{dx} = 100.72x^2 - 125 < x - 0.2 >^2 - 40 < x - 0.5 >^2 + C_1$$

$$EIv = 33.72x^3 - 41.67 < x - 0.2 >^3 - 13.33 < x - 0.5 >^3 + C_1 x + C_2 \quad (1)$$

Boundary conditions :

$$v = 0 \text{ at } x = 0$$

From Eq. (1)

$$C_2 = 0$$

$$v = 0 \text{ at } x = 0.7 \text{ m}$$

$$0 = 11.515 - 5.2083 - 0.1067 + 0.7C_1$$

$$C_1 = -8.857$$

$$\frac{dv}{dx} = \frac{1}{EI} [100.72x^2 - 125 < x - 0.2 >^2 - 40 < x - 0.5 >^2 - 8.857]$$

Assume v_{max} occurs at $0.2 \text{ m} < x < 0.5 \text{ m}$

$$\frac{dv}{dx} = 0 = \frac{1}{EI} [100.72x^2 - 125(x - 0.2)^2 - 8.857]$$

$$24.28x^2 - 50x + 13.857 = 0$$

$$x = 0.3300 \text{ m} \quad \text{OK}$$

$$v = \frac{1}{EI} [33.57x^3 - 41.67 < x - 0.2 >^3 - 13.33 < x - 0.5 >^3 - 8.857x]$$

Substitute $x = 0.3300 \text{ m}$ into the elastic curve :

$$v_{max} = -\frac{1.808 \text{ N} \cdot \text{m}^3}{EI} = -\frac{1.808}{200(10^9) \frac{\pi}{4} (0.0075)^4} = -0.00364 = -3.64 \text{ mm} \quad \text{Ans}$$

The negative sign indicates downward displacement.

From *Mechanics of Materials*, Sixth Edition by R. C. Hibbeler, ISBN 0-13-191345-X.

© 2005 R. C. Hibbeler. Published by Pearson Prentice Hall,

Pearson Education, Inc., Upper Saddle River, NJ. All rights reserved.

This material is protected under all copyright laws as they currently exist. No portion of this material may be reproduced, in any form or by any means, without permission in writing from the publisher.

12-54. Determine the slope and deflection at C. EI is constant.

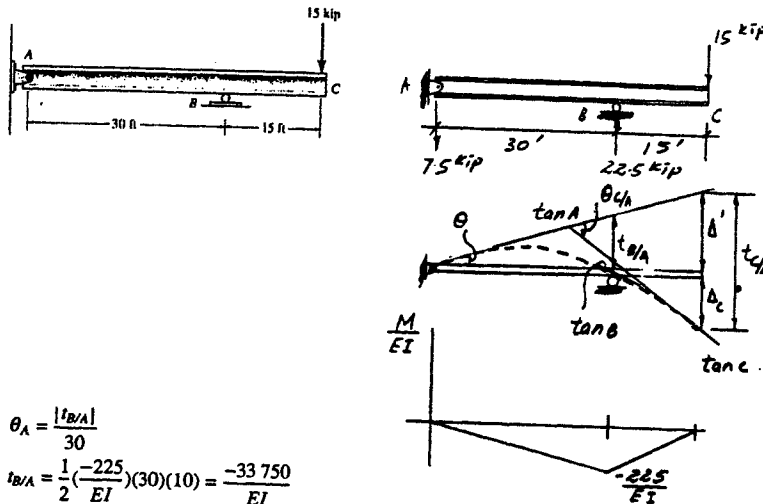

$$\theta_A = \frac{|t_{B/A}|}{30}$$

$$t_{B/A} = \frac{1}{2} \left(\frac{-225}{EI} \right) (30)(10) = \frac{-33750}{EI}$$

$$\theta_A = \frac{1125}{EI}$$

$$\theta_{C/A} = \frac{1}{2} \left(\frac{-225}{EI} \right) (30) + \frac{1}{2} \left(\frac{-225}{EI} \right) (15) = \frac{-5062.5}{EI} = \frac{5062.5}{EI}$$

$$\theta_C = \theta_{C/A} + \theta_A$$

$$\theta_C = \frac{5062.5}{EI} - \frac{1125}{EI} = \frac{3937.5}{EI} \quad \text{Ans}$$

$$\Delta_C = |t_{C/A}| - \frac{45}{30} |t_{B/A}|$$

$$t_{C/A} = \frac{1}{2} \left(\frac{-225}{EI} \right) (30)(25) + \frac{1}{2} \left(\frac{-225}{EI} \right) (15)(10) = \frac{-101250}{EI}$$

$$\Delta_C = \frac{101250}{EI} - \frac{45}{30} \left(\frac{33750}{EI} \right) = \frac{50625}{EI} \quad \text{Ans}$$

From *Mechanics of Materials*, Sixth Edition by R. C. Hibbeler, ISBN 0-13-191345-X.

© 2005 R. C. Hibbeler. Published by Pearson Prentice Hall,

Pearson Education, Inc., Upper Saddle River, NJ. All rights reserved.

This material is protected under all copyright laws as they currently exist. No portion of this material may be reproduced, in any form or by any means, without permission in writing from the publisher.

12-55 Determine the slope and deflection at B . EI is constant.

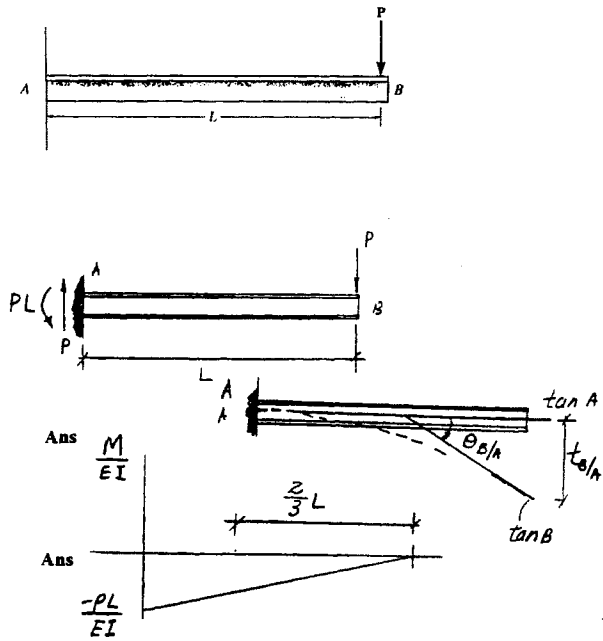

Ans $\frac{M}{EI}$

Ans $-\frac{PL}{EI}$

$$\theta_{B/A} = \frac{1}{2} \left(\frac{-PL}{EI} \right) (L) = \frac{-PL^2}{2EI} = \frac{PL^2}{2EI}$$

$$\theta_B = \theta_{B/A} = \theta_A$$

$$\theta_B = \frac{PL^2}{2EI} + 0 = \frac{PL^2}{2EI} \quad \text{Ans}$$

$$\begin{aligned} \Delta_B = |t_{B/A}| &= \frac{1}{2} \left(\frac{-PL}{EI} \right) (L) \left(\frac{2}{3} L \right) \\ &= \frac{PL^3}{3EI} \quad \text{Ans} \end{aligned}$$

From *Mechanics of Materials*, Sixth Edition by R. C. Hibbeler, ISBN 0-13-191345-X.
 © 2005 R. C. Hibbeler. Published by Pearson Prentice Hall,
 Pearson Education, Inc., Upper Saddle River, NJ. All rights reserved.
 This material is protected under all copyright laws as they currently exist. No portion of this material may be reproduced, in any form or by any means, without permission in writing from the publisher.

***12-56.** Determine the slope and deflection at B if the A-36 steel beam is (a) a solid rod having a diameter of 3 in., (b) a tube having an outer diameter of 3 in. and thickness of 0.25 in.

$$\theta_{B/A} = \frac{1}{2} \left(\frac{-PL}{EI} \right) (L) = \frac{-PL^2}{2EI} = \frac{PL^2}{2EI}$$

$$\theta_B = \theta_{B/A} + \theta_A$$

$$\theta_B = \frac{PL^2}{2EI} + 0 = \frac{PL^2}{2EI}$$

$$\Delta_B = |t_{B/A}| = \frac{1}{2} \left(\frac{-PL}{EI} \right) (L) \left(\frac{2L}{3} \right) = \frac{PL^3}{3EI}$$

a) Numerical substitution :

$$P = 500 \text{ lb} \quad L = 5 (12) = 60 \text{ in.}$$

$$I = \frac{\pi}{4} (1.5^4) = 3.9761 \text{ in}^4$$

$$\theta_B = \frac{500(60)^2}{2(29)(10^6)(3.9761)} = 0.00781 \text{ rad} \quad \text{Ans}$$

$$\Delta_B = \frac{500(60^3)}{3(29)(10^6)(3.9761)} = 0.312 \text{ in.} \quad \text{Ans}$$

$$\text{b) } I = \frac{\pi}{4} (1.5^4 - 1.25^4) = 2.0586 \text{ in}^4$$

$$\theta_B = \frac{500(60)^2}{2(29)(10^6)(2.0586)} = 0.0151 \text{ rad} \quad \text{Ans}$$

$$\Delta_B = \frac{500(60^3)}{3(29)(10^6)(2.0586)} = 0.603 \text{ in.} \quad \text{Ans}$$

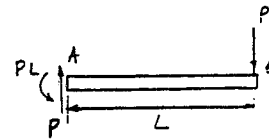
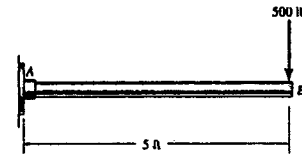
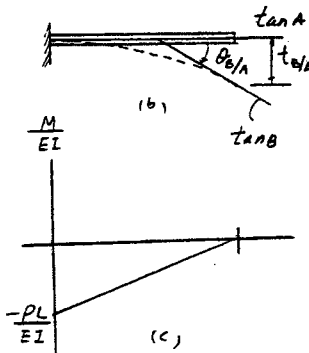

From *Mechanics of Materials*, Sixth Edition by R. C. Hibbeler, ISBN 0-13-191345-X.

© 2005 R. C. Hibbeler. Published by Pearson Prentice Hall,

Pearson Education, Inc., Upper Saddle River, NJ. All rights reserved.

This material is protected under all copyright laws as they currently exist. No portion of this material may be reproduced, in any form or by any means, without permission in writing from the publisher.

12-57. Determine the slope at B and the deflection at C .
 EI is constant.

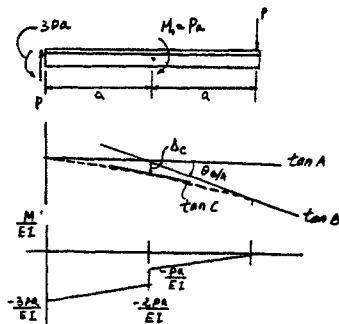
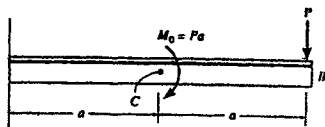

$$\theta_B = \theta_{B/A} = \frac{1}{2} \left(\frac{-Pa}{EI} \right) (a) + \frac{1}{2} \left[-\frac{3Pa}{EI} - \frac{2Pa}{EI} \right] (a)$$

$$= \frac{3Pa^2}{EI} \quad \text{Ans}$$

$$\Delta_C = \frac{1}{2} (a) \left(\frac{-2Pa}{EI} \right) (a) + \frac{2}{3} (a) \left[\left(\frac{1}{2} \right) \frac{-Pa}{EI} \right] (a)$$

$$= \frac{4Pa^3}{3EI} \quad \text{Ans}$$

From *Mechanics of Materials*, Sixth Edition by R. C. Hibbeler, ISBN 0-13-191345-X.

© 2005 R. C. Hibbeler. Published by Pearson Prentice Hall,

Pearson Education, Inc., Upper Saddle River, NJ. All rights reserved.

This material is protected under all copyright laws as they currently exist. No portion of this material may be reproduced, in any form or by any means, without permission in writing from the publisher.

12-58 Determine the slope at C and the deflection at B. EI is constant.

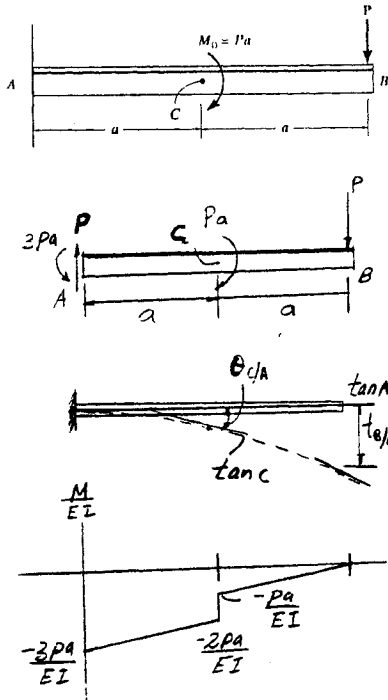

$$\theta_{C/A} = \left(-\frac{2Pa}{EI}\right)a + \frac{1}{2}\left(-\frac{Pa}{EI}\right)a = -\frac{5Pa^2}{2EI} = \frac{5Pa^2}{2EI}$$

$$\theta_C = \theta_{C/A}$$

$$\theta_C = \frac{5Pa^2}{2EI} \quad \text{Ans}$$

$$\begin{aligned} \Delta_B = |t_{B/A}| &= \frac{1}{2}\left(-\frac{Pa}{EI}\right)\left(a\right)\left(\frac{2a}{3}\right) + \frac{1}{2}\left(-\frac{Pa}{EI}\right)a\left(a + \frac{2a}{3}\right) + \left(-\frac{2Pa}{EI}\right)\left(a\right)\left(a + \frac{a}{2}\right) \\ &= \frac{25Pa^3}{6EI} \quad \text{Ans} \end{aligned}$$

From *Mechanics of Materials*, Sixth Edition by R. C. Hibbeler, ISBN 0-13-191345-X.

© 2005 R. C. Hibbeler. Published by Pearson Prentice Hall,

Pearson Education, Inc., Upper Saddle River, NJ. All rights reserved.

This material is protected under all copyright laws as they currently exist. No portion of this material may be reproduced, in any form or by any means, without permission in writing from the publisher.

12-59 If the bearings at *A* and *B* exert only vertical reactions on the shaft, determine the slope at *B* and the deflection at *C*. *EI* is constant.

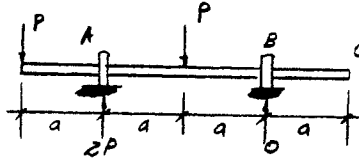
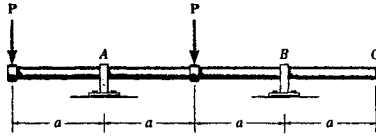

$$t_{A/B} = \frac{1}{2} \left(-\frac{Pa}{EI} \right) (a) \left(\frac{a}{3} \right) = -\frac{Pa^3}{6EI}$$

$$\theta_B = \frac{|t_{A/B}|}{2a} = \frac{Pa^3/6EI}{2a} = \frac{Pa^2}{12EI}$$

$$\Delta_C = \theta_B a = \frac{Pa^2}{12EI} (a) = \frac{Pa^3}{12EI}$$

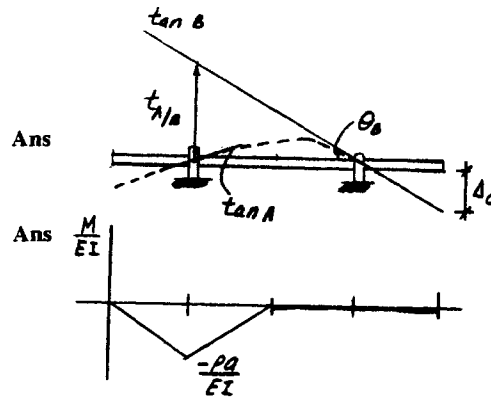

From *Mechanics of Materials*, Sixth Edition by R. C. Hibbeler, ISBN 0-13-191345-X.
 © 2005 R. C. Hibbeler. Published by Pearson Prentice Hall,
 Pearson Education, Inc., Upper Saddle River, NJ. All rights reserved.
 This material is protected under all copyright laws as they currently exist. No portion of this material may be reproduced, in any form or by any means, without permission in writing from the publisher.

*12-60 The composite simply-supported steel shaft is subjected to a force of 10 kN at its center. Determine its maximum deflection. $E_{st} = 200$ GPa.

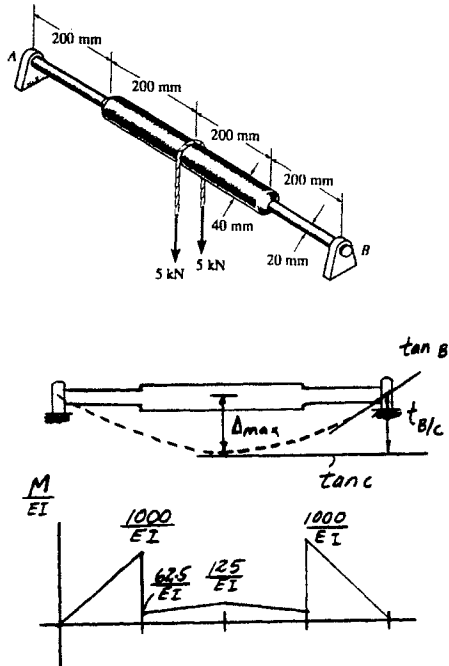

$$\Delta_{max} = |t_{B/C}| = \frac{62.5}{EI}(0.2)(0.3) + \frac{1}{2}\left(\frac{62.5}{EI}\right)(0.2)(0.3333) + \frac{1}{2}\left(\frac{1000}{EI}\right)(0.2)(0.1333)$$

$$= \frac{19.167}{EI} = \frac{19.167}{200(10^9)(7.8540)(10^{-9})} = 0.0122 \text{ m} = 12.2 \text{ mm} \quad \text{Ans}$$

From *Mechanics of Materials*, Sixth Edition by R. C. Hibbeler, ISBN 0-13-191345-X.

© 2005 R. C. Hibbeler. Published by Pearson Prentice Hall,

Pearson Education, Inc., Upper Saddle River, NJ. All rights reserved.

This material is protected under all copyright laws as they currently exist. No portion of this material may be reproduced, in any form or by any means, without permission in writing from the publisher.

12-61 Determine the maximum slope and the maximum deflection of the beam. EI is constant.

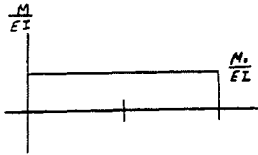
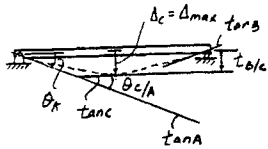
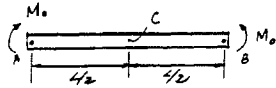
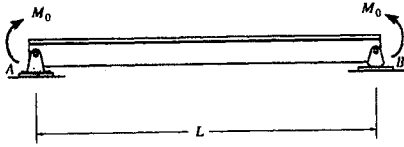

$$\theta_{C/A} = \frac{M_0}{EI} \left(\frac{L}{2}\right) = \frac{M_0 L}{2EI}$$

$$\theta_C = \theta_{C/A} + \theta_A$$

$$0 = \frac{M_0 L}{2EI} + \theta_A$$

$$\theta_{max} = \theta_A = \frac{-M_0 L}{2EI} = \frac{M_0 L}{2EI} \quad \text{Ans}$$

$$\Delta_{max} = |t_{B/C}| = \frac{M_0}{EI} \left(\frac{L}{2}\right) \left(\frac{L}{4}\right) = \frac{M_0 L^2}{8EI} \quad \text{Ans}$$

From *Mechanics of Materials*, Sixth Edition by R. C. Hibbeler, ISBN 0-13-191345-X.

© 2005 R. C. Hibbeler. Published by Pearson Prentice Hall,

Pearson Education, Inc., Upper Saddle River, NJ. All rights reserved.

This material is protected under all copyright laws as they currently exist. No portion of this material may be reproduced, in any form or by any means, without permission in writing from the publisher.

12-62. The rod is constructed from two shafts for which the moment of inertia of AB is I and of BC is $2I$. Determine the maximum slope and deflection of the rod due to the loading. The modulus of elasticity is E .

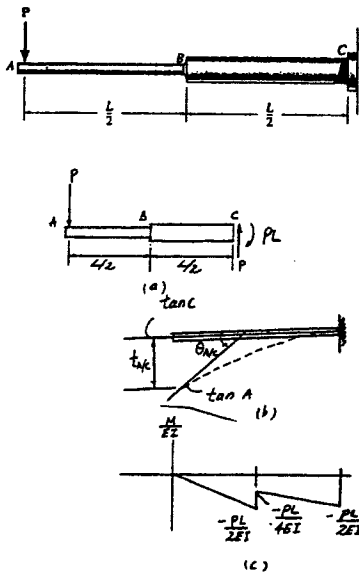

$$\theta_{AC} = \frac{1}{2} \left(\frac{-PL}{2EI} \right) \left(\frac{L}{2} \right) + \frac{1}{2} \left(\frac{-PL}{4EI} \right) \left(\frac{L}{2} \right) + \left(\frac{-PL}{4EI} \right) \left(\frac{L}{2} \right) = \frac{-5PL^2}{16EI} = \frac{5PL^2}{16EI}$$

$$\theta_A = \theta_{AC} + \theta_C$$

$$\theta_{\max} = \theta_A = \frac{5PL^2}{16EI} + 0 = \frac{5PL^2}{16EI} \quad \text{Ans}$$

$$\Delta_{\max} = \Delta_A = |t_{AC}|$$

$$\begin{aligned} &= \left| \frac{1}{2} \left(\frac{-PL}{2EI} \right) \left(\frac{L}{2} \right) \left(\frac{L}{3} \right) + \frac{1}{2} \left(\frac{-PL}{4EI} \right) \left(\frac{L}{2} \right) \left(\frac{L}{2} + \frac{L}{3} \right) + \left(\frac{-PL}{4EI} \right) \left(\frac{L}{2} \right) \left(\frac{L}{2} + \frac{L}{4} \right) \right| \\ &= \frac{3PL^3}{16EI} \quad \text{Ans} \end{aligned}$$

From *Mechanics of Materials*, Sixth Edition by R. C. Hibbeler, ISBN 0-13-191345-X.

© 2005 R. C. Hibbeler. Published by Pearson Prentice Hall,

Pearson Education, Inc., Upper Saddle River, NJ. All rights reserved.

This material is protected under all copyright laws as they currently exist. No portion of this material may be reproduced, in any form or by any means, without permission in writing from the publisher.

12-63 Determine the deflection and slope at C. EI is constant.

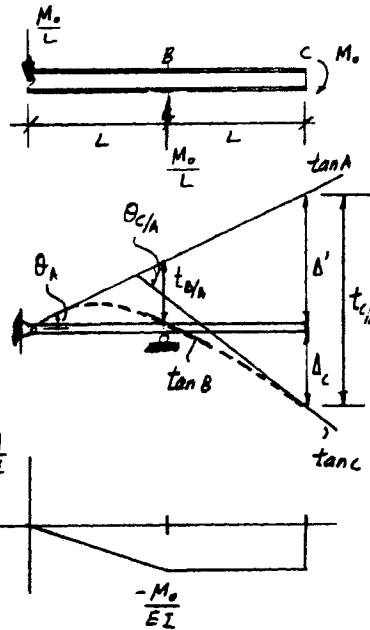
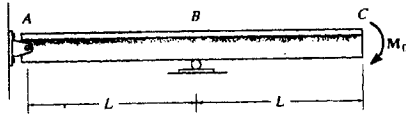

$$t_{B/A} = \frac{1}{2} \left(\frac{-M_0}{EI} \right) (L) \left(\frac{1}{3} \right) (L) = -\frac{M_0 L^2}{6EI}$$

$$\Delta_C = |t_{C/A}| - 2|t_{B/A}|$$

$$t_{C/A} = \frac{1}{2} \left(\frac{-M_0}{EI} \right) (L) \left(L + \frac{L}{3} \right) + \left(\frac{-M_0}{EI} \right) (L) \left(\frac{L}{2} \right) = -\frac{7M_0 L^2}{6EI}$$

$$\Delta_C = \frac{7M_0 L^2}{6EI} - (2) \left(\frac{M_0 L^2}{6EI} \right) = \frac{5M_0 L^2}{6EI} \quad \text{Ans } \frac{M}{EI}$$

$$\theta_A = \frac{|t_{B/A}|}{L} = \frac{M_0 L}{6EI}$$

$$\theta_{C/A} = \frac{1}{2} \left(\frac{-M_0}{EI} \right) (L) + \left(\frac{-M_0}{EI} \right) (L) = -\frac{3M_0 L}{2EI} = \frac{3M_0 L}{2EI}$$

$$\theta_C = \theta_{C/A} + \theta_A$$

$$\theta_C = \frac{3M_0 L}{2EI} - \frac{M_0 L}{6EI} = \frac{4M_0 L}{3EI} \quad \text{Ans}$$

From *Mechanics of Materials*, Sixth Edition by R. C. Hibbeler, ISBN 0-13-191345-X.
 © 2005 R. C. Hibbeler. Published by Pearson Prentice Hall,
 Pearson Education, Inc., Upper Saddle River, NJ. All rights reserved.
 This material is protected under all copyright laws as they currently exist. No portion of this material may be reproduced, in any form or by any means, without permission in writing from the publisher.

*12-64 The shaft supports the pulley at its end C. Determine the deflection at C and the slopes at the bearings A and B. EI is constant.

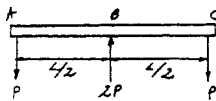
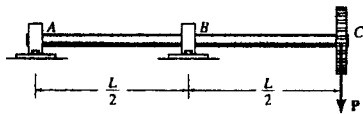

$$t_{B/A} = \frac{1}{2} \left(\frac{-PL}{2EI} \right) \left(\frac{L}{2} \right) \left(\frac{L}{6} \right) = \frac{-PL^3}{48EI}$$

$$t_{C/A} = \frac{1}{2} \left(\frac{-PL}{2EI} \right) \left(L \right) \left(\frac{L}{2} \right) = \frac{-PL^3}{8EI}$$

$$\begin{aligned} \Delta_C &= |t_{C/A}| - \left(\frac{L}{2} \right) |t_{B/A}| \\ &= \frac{PL^3}{8EI} - 2 \left(\frac{PL^3}{48EI} \right) = \frac{PL^3}{12EI} \end{aligned}$$

Ans

$$\theta_A = \frac{|t_{B/A}|}{\frac{L}{2}} = \frac{\frac{PL^3}{48EI}}{\frac{L}{2}} = \frac{PL^2}{24EI}$$

Ans

$$\theta_{B/A} = \frac{1}{2} \left(\frac{-PL}{2EI} \right) \left(\frac{L}{2} \right) = \frac{-PL^2}{8EI} = \frac{PL^2}{8EI}$$

$$\theta_B = \theta_{B/A} + \theta_A$$

$$\theta_B = \frac{PL^2}{8EI} - \frac{PL^2}{24EI} = \frac{PL^2}{12EI}$$

Ans

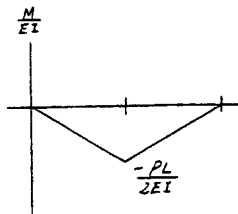
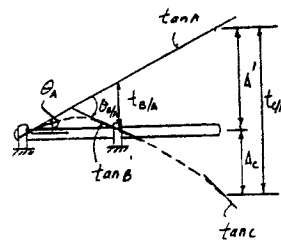

From *Mechanics of Materials*, Sixth Edition by R. C. Hibbeler, ISBN 0-13-191345-X.
 © 2005 R. C. Hibbeler. Published by Pearson Prentice Hall,
 Pearson Education, Inc., Upper Saddle River, NJ. All rights reserved.
 This material is protected under all copyright laws as they currently exist. No portion of this material may be reproduced, in any form or by any means, without permission in writing from the publisher.

12-65 The shaft supports the pulley at its end C. Determine its maximum deflection within region AB. EI is constant. The bearings exert only vertical reactions on the shaft.

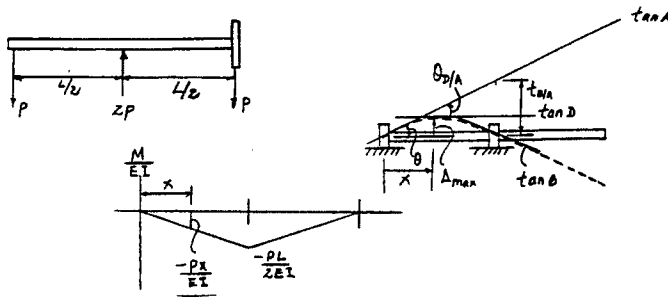
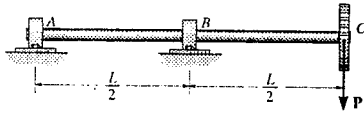

$$\theta_{D/A} = \frac{t_{B/A}}{(\frac{L}{2})}$$

$$\frac{1}{2} \left(\frac{Px}{EI} \right) x = \frac{\frac{1}{2} \left(\frac{L}{2} \right) \left(\frac{PL}{2EI} \right) \left(\frac{1}{2} \right) \left(\frac{L}{2} \right)}{\left(\frac{L}{2} \right)}; \quad x = 0.288675 L$$

$$\Delta_{\max} = \frac{1}{2} \left(\frac{P(0.288675 L)}{EI} \right) (0.288675 L) \left(\frac{2}{3} \right) (0.288675 L)$$

$$\Delta_{\max} = \frac{0.00802 PL^3}{EI} \quad \text{Ans}$$

From *Mechanics of Materials*, Sixth Edition by R. C. Hibbeler, ISBN 0-13-191345-X.

© 2005 R. C. Hibbeler. Published by Pearson Prentice Hall,

Pearson Education, Inc., Upper Saddle River, NJ. All rights reserved.

This material is protected under all copyright laws as they currently exist. No portion of this material may be reproduced, in any form or by any means, without permission in writing from the publisher.

12-66. Determine the deflection at C and the slope of the beam at A, B, and C. EI is constant.

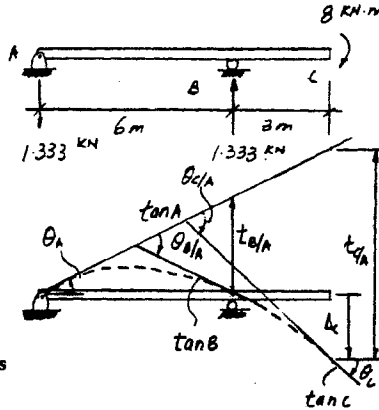
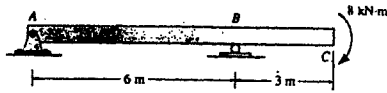

$$t_{B/A} = \frac{1}{2} \left(\frac{-8}{EI} \right) (6)(2) = \frac{-48}{EI}$$

$$t_{C/A} = \frac{1}{2} \left(\frac{-8}{EI} \right) (6)(3+2) + \left(\frac{-8}{EI} \right) (3)(1.5) = \frac{-156}{EI}$$

$$\Delta_C = |t_{C/A}| - \frac{9}{6} |t_{B/A}| = \frac{156}{EI} - \frac{9(48)}{6(EI)} = \frac{84}{EI} \quad \text{Ans}$$

$$\theta_A = \frac{|t_{B/A}|}{6} = \frac{8}{EI} \quad \text{Ans}$$

$$\theta_{B/A} = \frac{1}{2} \left(\frac{-8}{EI} \right) (6) = \frac{-24}{EI} = \frac{24}{EI}$$

$$\theta_B = \theta_{B/A} + \theta_A = \frac{24}{EI} - \frac{8}{EI} = \frac{16}{EI} \quad \text{Ans}$$

$$\theta_{C/A} = \frac{1}{2} \left(\frac{-8}{EI} \right) (6) + \left(\frac{-8}{EI} \right) (3) = \frac{-48}{EI} = \frac{48}{EI}$$

$$\theta_C = \theta_{C/A} + \theta_A = \frac{48}{EI} - \frac{8}{EI} = \frac{40}{EI} \quad \text{Ans}$$

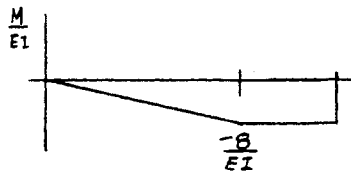

From *Mechanics of Materials*, Sixth Edition by R. C. Hibbeler, ISBN 0-13-191345-X.

© 2005 R. C. Hibbeler. Published by Pearson Prentice Hall,

Pearson Education, Inc., Upper Saddle River, NJ. All rights reserved.

This material is protected under all copyright laws as they currently exist. No portion of this material may be reproduced, in any form or by any means, without permission in writing from the publisher.

12-67 The flat spring is made of A-36 steel and has a rectangular cross section as shown. Determine the maximum elastic load P that can be applied. What is the deflection at B when P reaches its maximum value? Assume that the spring is fixed supported at A .

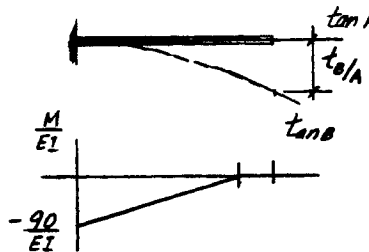
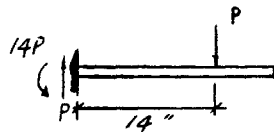

$$I = \frac{1}{12}(1.5)(0.1)^3 = 0.125(10^{-3}) \text{ in}^4$$

$$\sigma_y = \frac{Mc}{I}; \quad 36(10^3) = \frac{14P(0.05)}{0.125(10^{-3})} \quad P = 6.43 \text{ lb} \quad \text{Ans}$$

$$\begin{aligned} \Delta_B = t_{B/A} &= \frac{1}{2} \left(\frac{-90}{EI} \right) (14)(9.333 + 3) \\ &= \frac{-7770}{EI} = \frac{-7770}{29(10^6)(0.125)(10^{-3})} = 2.14 \text{ in.} \quad \text{Ans} \end{aligned}$$

From *Mechanics of Materials*, Sixth Edition by R. C. Hibbeler, ISBN 0-13-191345-X.

© 2005 R. C. Hibbeler. Published by Pearson Prentice Hall,

Pearson Education, Inc., Upper Saddle River, NJ. All rights reserved.

This material is protected under all copyright laws as they currently exist. No portion of this material may be reproduced, in any form or by any means, without permission in writing from the publisher.

*12-68 The acrobat has a weight of 150 lb, and suspends himself uniformly from the center of the high bar. Determine the maximum bending stress in the pipe (bar) and its maximum deflection. The pipe is made of L2 steel and has an outer diameter of 1 in. and a wall thickness of 0.125 in.

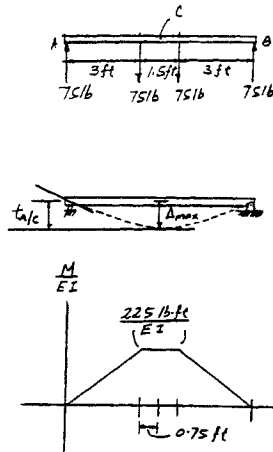
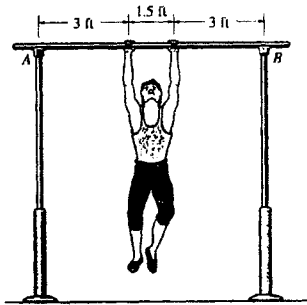

$$M_{\max} = 75(3) = 225 \text{ lb} \cdot \text{ft}$$

$$I = \frac{\pi}{4}(0.5^4 - 0.375^4) = 0.033556 \text{ in}^4$$

$$\sigma_{\max} = \frac{M_C}{I} = \frac{225(12)(0.5)}{0.033556} = 40.2 \text{ ksi} \quad \text{Ans}$$

$$40.2 \text{ ksi} < \sigma_Y = 102 \text{ ksi} \quad \text{OK}$$

$$\Delta_{\max} = t_{A/C} = \left(\frac{225}{EI}\right)(0.75)(3.375) + \frac{1}{2}\left(\frac{225}{EI}\right)(3)(2) = \frac{1244.53 \text{ lb} \cdot \text{ft}^3}{EI}$$

$$\Delta_{\max} = \frac{1244.53(12^3)}{29(10^6)(0.033556)} = 2.21 \text{ in.} \quad \text{Ans}$$

From *Mechanics of Materials*, Sixth Edition by R. C. Hibbeler, ISBN 0-13-191345-X.

© 2005 R. C. Hibbeler. Published by Pearson Prentice Hall,

Pearson Education, Inc., Upper Saddle River, NJ. All rights reserved.

This material is protected under all copyright laws as they currently exist. No portion of this material may be reproduced, in any form or by any means, without permission in writing from the publisher.

12-69 Determine the slope at C and the deflection at B. EI is constant.

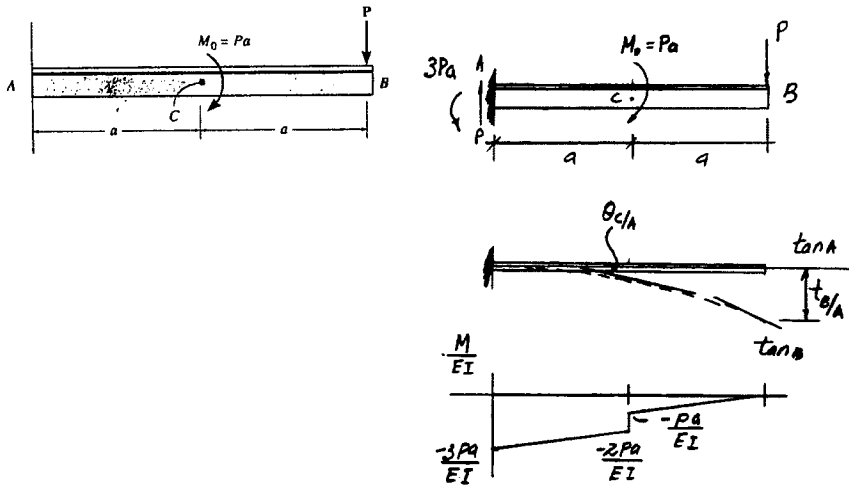

$$\theta_{C/A} = \left(-\frac{2Pa}{EI}\right)(a) + \frac{1}{2}\left(-\frac{Pa}{EI}\right)(a)$$

$$= -\frac{5Pa^2}{2EI} = \frac{5Pa^2}{2EI} \downarrow$$

$$\theta_C = \theta_{C/A}$$

$$\theta_C = +\frac{5Pa^2}{2EI} \swarrow$$

$$\Delta_B = |t_{B/A}| = \frac{1}{2}\left(-\frac{Pa}{EI}\right)(a)\left(\frac{2a}{3}\right) + \frac{1}{2}\left(-\frac{Pa}{EI}\right)(a)\left(a + \frac{2a}{3}\right) + \left(-\frac{2Pa}{EI}\right)(a)\left(a + \frac{a}{2}\right)$$

$$= \frac{25Pa^3}{6EI} \downarrow \quad \text{Ans}$$

From *Mechanics of Materials*, Sixth Edition by R. C. Hibbeler, ISBN 0-13-191345-X.

© 2005 R. C. Hibbeler. Published by Pearson Prentice Hall,

Pearson Education, Inc., Upper Saddle River, NJ. All rights reserved.

This material is protected under all copyright laws as they currently exist. No portion of this material may be reproduced, in any form or by any means, without permission in writing from the publisher.

12-70 The bar is supported by a roller constraint at B , which allows vertical displacement but resists axial load and moment. If the bar is subjected to the loading shown, determine the slope at A and the deflection at C . EI is constant.

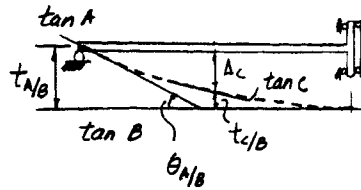
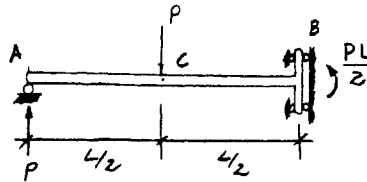
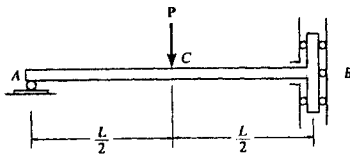

$$\theta_{A/B} = \frac{1}{2} \left(\frac{PL}{2EI} \right) \left(\frac{L}{2} \right) + \frac{PL}{2EI} \left(\frac{L}{2} \right) = \frac{3PL^2}{8EI}$$

$$\theta_A = \theta_{A/B}$$

$$\theta_A = \frac{3PL^2}{8EI} \quad \text{Ans}$$

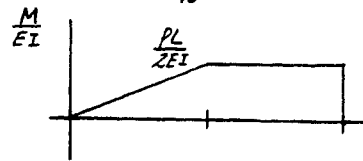

$$t_{A/B} = \frac{1}{2} \left(\frac{PL}{2EI} \right) \left(\frac{L}{2} \right) \left(\frac{L}{3} \right) + \frac{PL}{2EI} \left(\frac{L}{2} \right) \left(\frac{L}{2} + \frac{L}{4} \right) = \frac{11PL^3}{48EI}$$

$$t_{C/B} = \frac{PL}{2EI} \left(\frac{L}{2} \right) \left(\frac{L}{4} \right) = \frac{PL^3}{16EI}$$

$$\Delta_C = t_{A/B} - t_{C/B} = \frac{11PL^3}{48EI} - \frac{PL^3}{16EI} = \frac{PL^3}{6EI} \quad \text{Ans}$$

From *Mechanics of Materials*, Sixth Edition by R. C. Hibbeler, ISBN 0-13-191345-X.

© 2005 R. C. Hibbeler. Published by Pearson Prentice Hall,

Pearson Education, Inc., Upper Saddle River, NJ. All rights reserved.

This material is protected under all copyright laws as they currently exist. No portion of this material may be reproduced, in any form or by any means, without permission in writing from the publisher.

12-71. Determine the maximum deflection of the shaft.
 EI is constant. The bearings exert only vertical reactions on the shaft.

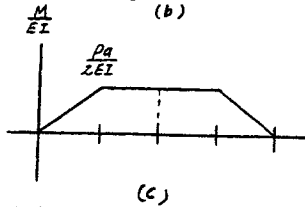
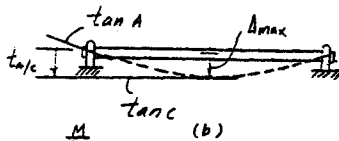
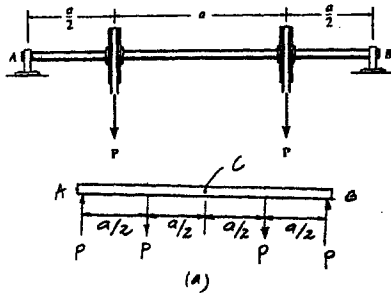

$$\begin{aligned}
 \Delta_{\max} &= t_{AC} \\
 &= \left(\frac{Pa}{2EI}\right)\left(\frac{a}{2}\right)\left(\frac{a}{2} + \frac{a}{4}\right) + \frac{1}{2}\left(\frac{Pa}{2EI}\right)\left(\frac{a}{2}\right)\left(\frac{a}{3}\right) \\
 &= \frac{11Pa^3}{48EI} \quad \text{Ans}
 \end{aligned}$$

From *Mechanics of Materials*, Sixth Edition by R. C. Hibbeler, ISBN 0-13-191345-X.

© 2005 R. C. Hibbeler. Published by Pearson Prentice Hall,

Pearson Education, Inc., Upper Saddle River, NJ. All rights reserved.

This material is protected under all copyright laws as they currently exist. No portion of this material may be reproduced, in any form or by any means, without permission in writing from the publisher.

*12-72 The beam is subjected to the load P as shown. Determine the magnitude of force F that must be applied at the end of the overhang C so that the deflection at C is zero. EI is constant.

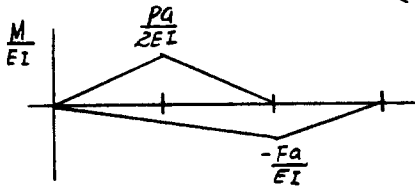
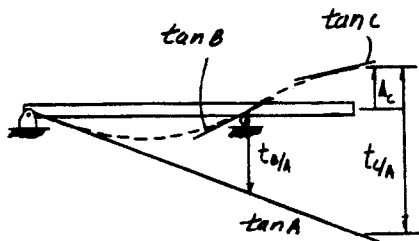
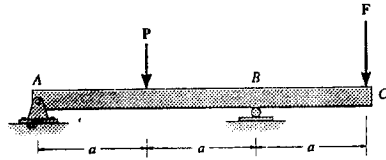

$$t_{B/A} = \frac{1}{2} \left(\frac{Pa}{2EI} \right) (2a)(a) + \frac{1}{2} \left(\frac{-Fa}{EI} \right) (2a) \left(\frac{2}{3}a \right) = \frac{Pa^3}{2EI} - \frac{2Fa^3}{3EI}$$

$$t_{C/A} = \frac{1}{2} \left(\frac{Pa}{2EI} \right) (2a)(2a) + \frac{1}{2} \left(\frac{-Fa}{EI} \right) (2a) \left(a + \frac{2a}{3} \right) + \frac{1}{2} \left(\frac{-Fa}{EI} \right) (a) \left(\frac{2a}{3} \right) = \frac{Pa^3}{EI} - \frac{2Fa^3}{EI}$$

$$\Delta_C = t_{C/A} - \frac{3}{2} t_{B/A} = 0$$

$$\frac{Pa^3}{EI} - \frac{2Fa^3}{EI} - \frac{3}{2} \left(\frac{Pa^3}{2EI} - \frac{2Fa^3}{3EI} \right) = 0$$

$$F = \frac{P}{4} \quad \text{Ans}$$

From *Mechanics of Materials*, Sixth Edition by R. C. Hibbeler, ISBN 0-13-191345-X.

© 2005 R. C. Hibbeler. Published by Pearson Prentice Hall,

Pearson Education, Inc., Upper Saddle River, NJ. All rights reserved.

This material is protected under all copyright laws as they currently exist. No portion of this material may be reproduced, in any form or by any means, without permission in writing from the publisher.

12-73. Determine the slope at B and deflection at C . EI is constant.

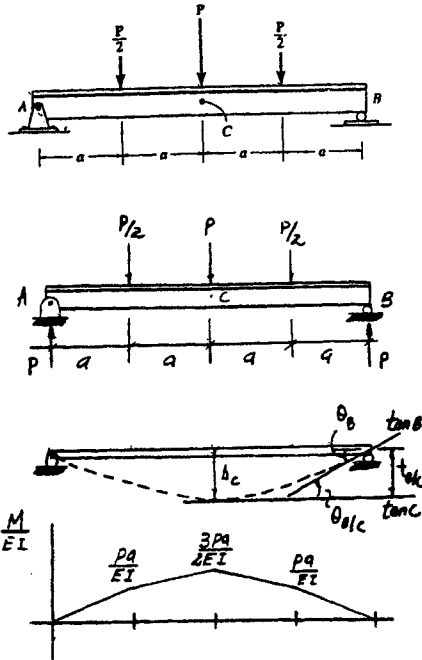

$$\theta_{B/C} = \frac{1}{2} \left(\frac{Pa}{EI} \right) (a) + \frac{1}{2} \left(\frac{Pa}{2EI} \right) (a) + \left(\frac{Pa}{EI} \right) (a) = \frac{7Pa^2}{4EI}$$

$$\theta_B = \theta_{B/C} = \frac{7Pa^2}{4EI} \quad \text{Ans}$$

$$\Delta_C = |t_{B/C}| = \frac{1}{2} \left(\frac{Pa}{EI} \right) (a) \left(\frac{2a}{3} \right) + \frac{1}{2} \left(\frac{Pa}{2EI} \right) (a) \left(a + \frac{2a}{3} \right) + \left(\frac{Pa}{EI} \right) (a) \left(a + \frac{a}{2} \right) = \frac{9Pa^3}{4EI} \quad \text{Ans}$$

From *Mechanics of Materials*, Sixth Edition by R. C. Hibbeler, ISBN 0-13-191345-X.

© 2005 R. C. Hibbeler. Published by Pearson Prentice Hall,

Pearson Education, Inc., Upper Saddle River, NJ. All rights reserved.

This material is protected under all copyright laws as they currently exist. No portion of this material may be reproduced, in any form or by any means, without permission in writing from the publisher.

12-74 The A-36 steel shaft is subjected to the loadings developed in the belts passing over the two pulleys. If the bearings at *A* and *B* exert only vertical reactions on the shaft, determine the slope at *A*. The shaft has a diameter of 0.75 in.

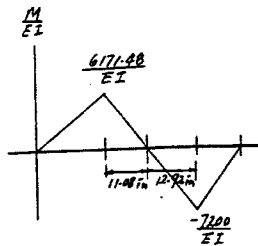
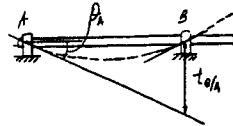
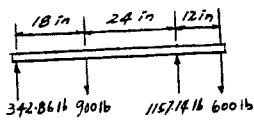
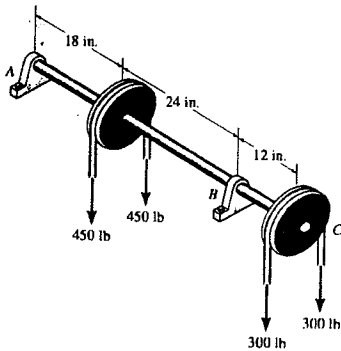

$$t_{B/A} = \frac{1}{2} \left(\frac{6171.48}{EI} \right) (18)(30) + \frac{1}{2} \left(\frac{6171.48}{EI} \right) (11.08)(20.31) + \frac{1}{2} \left(\frac{-7200}{EI} \right) (12.92)(4.31) = \frac{2160231.8}{EI}$$

$$\theta_A = \frac{|t_{B/A}|}{42} = \frac{51434.1}{EI} = \frac{51434.1}{29(10^6) \left(\frac{\pi}{4} \right) (0.375)^4} = 0.114 \text{ rad} = 6.54^\circ \quad \text{Ans}$$

From *Mechanics of Materials*, Sixth Edition by R. C. Hibbeler, ISBN 0-13-191345-X.

© 2005 R. C. Hibbeler. Published by Pearson Prentice Hall,

Pearson Education, Inc., Upper Saddle River, NJ. All rights reserved.

This material is protected under all copyright laws as they currently exist. No portion of this material may be reproduced, in any form or by any means, without permission in writing from the publisher.

12-75 The A-36 steel shaft is subjected to the loadings developed in the belts passing over the two pulleys. If the bearings at A and B exert only vertical reactions on the shaft, determine the deflection at C. The shaft has a diameter of 0.75 in.

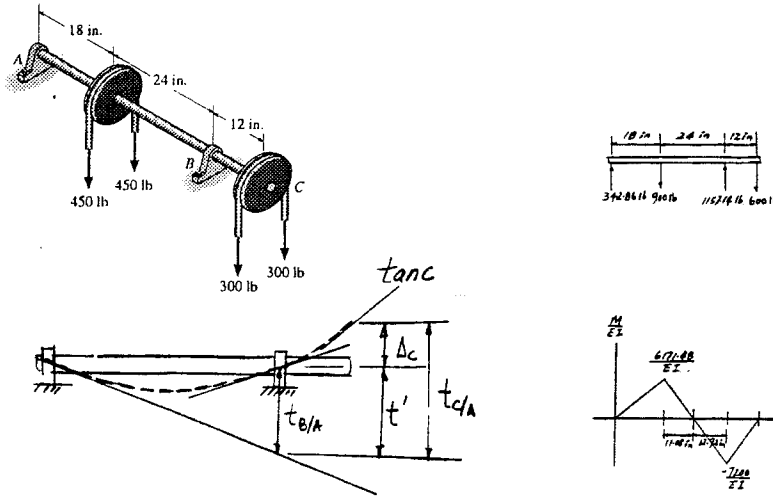

$$t_{B/A} = \frac{1}{2} \left(\frac{6171.48}{EI} \right) (18)(30) + \frac{1}{2} \left(\frac{6171.48}{EI} \right) (11.08)(20.31) + \frac{1}{2} \left(\frac{-7200}{EI} \right) (12.92)(4.31) = \frac{2160231.8}{EI}$$

$$t_B' = (t_{B/A}) \left(\frac{54}{42} \right) = \frac{2777441}{EI}$$

$$t_{C/A} = \frac{1}{2} \left(\frac{6171.48}{EI} \right) (18)(42) + \frac{1}{2} \left(\frac{6171.48}{EI} \right) (11.08)(32.31) + \frac{1}{2} \left(\frac{-7200}{EI} \right) (12.92)(16.31) + \frac{1}{2} \left(\frac{-7200}{EI} \right) (12)(8) = \frac{2333287.6}{EI}$$

$$\Delta_C = t_{C/A} - t_B' = \frac{-444,153}{29(10^6) \left(\frac{\pi}{4} \right) (0.375)^4}$$

$$\Delta_C = 0.987 \text{ in.} \quad \text{Ans}$$

From *Mechanics of Materials*, Sixth Edition by R. C. Hibbeler, ISBN 0-13-191345-X.
 © 2005 R. C. Hibbeler. Published by Pearson Prentice Hall,
 Pearson Education, Inc., Upper Saddle River, NJ. All rights reserved.
 This material is protected under all copyright laws as they currently exist. No portion of this material may be reproduced, in any form or by any means, without permission in writing from the publisher.

*12-76 The 25-mm-diameter A-36 steel shaft is supported at *A* and *B* by bearings. If the tension in the belt on the pulley at *C* is 0.75 kN, determine the largest belt tension *T* on the pulley at *D* so that the slope of the shaft at *A* or *B* does not exceed 0.02 rad. The bearings exert only vertical reactions on the shaft.

$$\theta_{B/A} = \frac{1}{2} \left(\frac{0.24T}{EI} \right) (0.2)(0.1333) + \frac{1}{2} \left(\frac{0.24T}{EI} \right) (0.3)(0.2 + 0.1) \\ + \frac{1}{2} \left(\frac{-150}{EI} \right) (0.5)(0.3333) = \frac{0.014 T}{EI} - \frac{12.5}{EI}$$

$$\theta_A = \frac{|\theta_{B/A}|}{0.5} = \frac{0.028 T}{EI} - \frac{25}{EI} \quad (1)$$

$$\theta_{B/A} = \frac{1}{2} \left(\frac{0.24 T}{EI} \right) (0.2) + \frac{1}{2} \left(\frac{0.24 T}{EI} \right) (0.3) \\ + \frac{1}{2} \left(\frac{-150}{EI} \right) (0.5) = \frac{0.06 T}{EI} - \frac{37.5}{EI}$$

$$\theta_B = \theta_{B/A} + \theta_A$$

$$\theta_B = \frac{0.06 T}{EI} - \frac{37.5}{EI} - \left(\frac{0.028 T}{EI} - \frac{25}{EI} \right) \\ = \frac{0.032 T}{EI} - \frac{12.5}{EI} \quad (2)$$

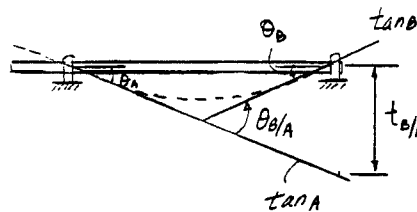
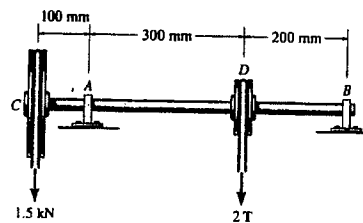

For $\theta_A = 0.02$ rad

From Eq. (1) :

$$0.02(EI) = 0.028 T - 25$$

$$0.02(200)(10^9)(19.175)(10^{-9}) = 0.028 T - 25$$

$$T = 3632 \text{ N}$$

For $\theta_B = 0.02$ rad

From Eq. (2) :

$$0.02(EI) = 0.032 T - 12.5$$

$$0.02(200)(10^9)(19.175)(10^{-9}) = 0.032 T - 12.5;$$

$$T = 2787 \text{ N} = 2.79 \text{ kN} \quad \text{controls} \quad \text{Ans}$$

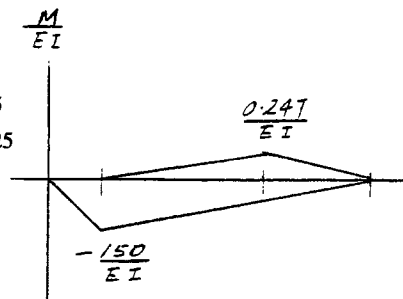

From *Mechanics of Materials*, Sixth Edition by R. C. Hibbeler, ISBN 0-13-191345-X.

© 2005 R. C. Hibbeler. Published by Pearson Prentice Hall,

Pearson Education, Inc., Upper Saddle River, NJ. All rights reserved.

This material is protected under all copyright laws as they currently exist. No portion of this material may be reproduced, in any form or by any means, without permission in writing from the publisher.

12-77 The 25-mm-diameter A-36 steel shaft is supported at A and B by bearings. If the tension in the belt on the pulley at C is 0.75 kN, determine the largest belt tension T on the pulley at D so that the slope of the shaft at A is zero. The bearings exert only vertical reactions on the shaft.

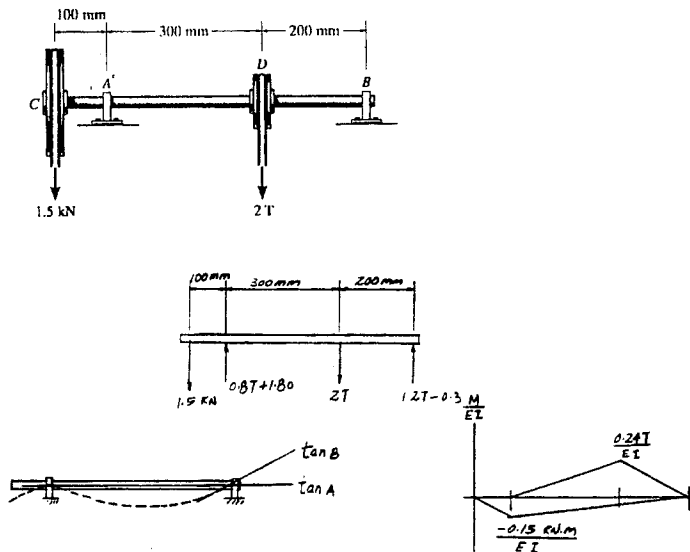

Require $t_{B/A} = 0$.

$$t_{B/A} = \frac{1}{2} \left(\frac{-1500}{EI} \right) (0.5) \left(\frac{2}{3} \right) (0.5) + \frac{1}{2} \left(\frac{0.24T}{EI} \right) (0.3) (0.3) + \frac{1}{2} \left(\frac{0.24T}{EI} \right) (0.2) \left(\frac{2}{3} \right) (0.2) = 0$$

$$T = 8928.6 \text{ N} = 8.93 \text{ kN} \quad \text{Ans}$$

From *Mechanics of Materials*, Sixth Edition by R. C. Hibbeler, ISBN 0-13-191345-X.

© 2005 R. C. Hibbeler. Published by Pearson Prentice Hall,

Pearson Education, Inc., Upper Saddle River, NJ. All rights reserved.

This material is protected under all copyright laws as they currently exist. No portion of this material may be reproduced, in any form or by any means, without permission in writing from the publisher.

12-78 The beam is subjected to the loading shown. Determine the slope at B and deflection at C . EI is constant.

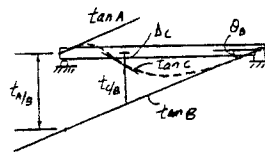
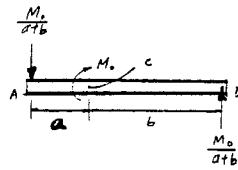
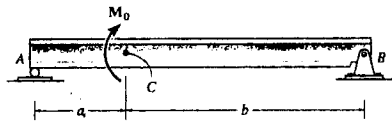

The slope :

$$t_{A/B} = \frac{1}{2} \left[\frac{-M_0 a}{EI(a+b)} \right] (a) \left(\frac{2}{3} a \right) + \frac{1}{2} \left[\frac{M_0 b}{EI(a+b)} \right] (b) \left(a + \frac{b}{3} \right)$$

$$= \frac{M_0 (b^3 + 3ab^2 - 2a^3)}{6EI(a+b)}$$

$$\theta_B = \frac{t_{A/B}}{a+b} = \frac{M_0 (b^3 + 3ab^2 - 2a^3)}{6EI(a+b)^2} \quad \text{Ans}$$

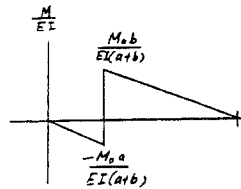

The deflection :

$$t_{C/B} = \frac{1}{2} \left[\frac{M_0 b}{EI(a+b)} \right] (b) \left(\frac{b}{3} \right) = \frac{M_0 b^3}{6EI(a+b)}$$

$$\Delta_C = \left(\frac{b}{a+b} \right) t_{A/B} - t_{C/B}$$

$$= \frac{M_0 b (b^3 + 3ab^2 - 2a^3)}{6EI(a+b)^2} - \frac{M_0 b^3}{6EI(a+b)}$$

$$= \frac{M_0 a b (b-a)}{3EI(a+b)} \quad \text{Ans}$$

From *Mechanics of Materials*, Sixth Edition by R. C. Hibbeler, ISBN 0-13-191345-X.

© 2005 R. C. Hibbeler. Published by Pearson Prentice Hall,

Pearson Education, Inc., Upper Saddle River, NJ. All rights reserved.

This material is protected under all copyright laws as they currently exist. No portion of this material may be reproduced, in any form or by any means, without permission in writing from the publisher.

12-79 If the bearings at A and B exert only vertical reactions on the shaft, determine the slope at A and the maximum deflection.

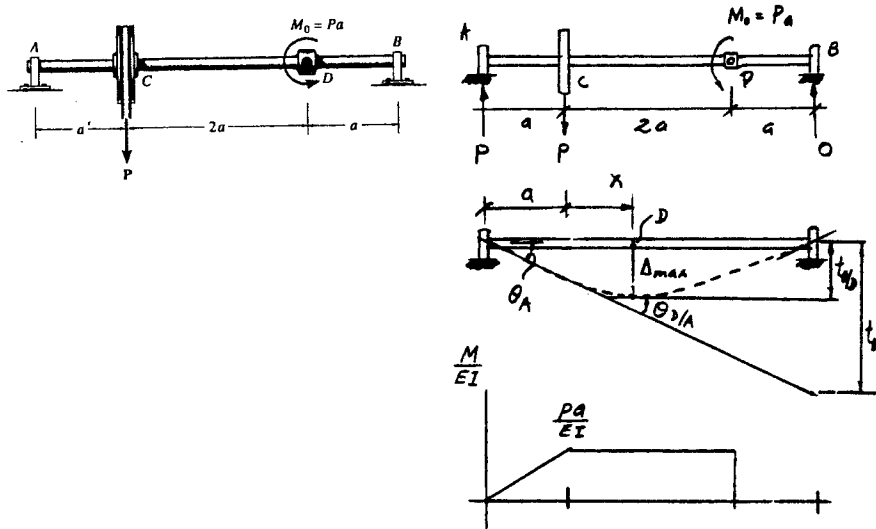

$$t_{B/A} = \frac{1}{2} \left(\frac{Pa}{EI} \right) (a) \left(3a + \frac{a}{3} \right) + \left(\frac{Pa}{EI} \right) (2a) (a + a) = \frac{17Pa^3}{3EI}$$

$$\theta_A = \frac{|t_{B/A}|}{4a} = \frac{17Pa^2}{12EI} \quad \text{Ans}$$

Assume Δ_{max} is at point D located at $0 < x < 2a$

$$\theta_{D/A} = \frac{1}{2} \left(\frac{Pa}{EI} \right) (a) + \left(\frac{Pa}{EI} \right) (x) = \frac{Pa^2}{2EI} + \frac{Pax}{EI}$$

$$\theta_D = 0 = \theta_{D/A} + \theta_A$$

$$0 = \frac{Pa^2}{2EI} + \frac{Pax}{EI} + \left(-\frac{17Pa^2}{12EI} \right)$$

$$x = \frac{11}{12}a$$

$$\Delta_{max} = |t_{D/D}| = \left(\frac{Pa}{EI} \right) \left(2a - \frac{11}{12}a \right) \left[\frac{(2a - \frac{11}{12}a)}{2} + a \right] = \frac{481Pa^3}{288EI} \quad \text{Ans}$$

From *Mechanics of Materials*, Sixth Edition by R. C. Hibbeler, ISBN 0-13-191345-X.

© 2005 R. C. Hibbeler. Published by Pearson Prentice Hall,

Pearson Education, Inc., Upper Saddle River, NJ. All rights reserved.

This material is protected under all copyright laws as they currently exist. No portion of this material may be reproduced, in any form or by any means, without permission in writing from the publisher.

*12-80 The two bars are pin connected at D . Determine the slope at A and the deflection at D . EI is constant.

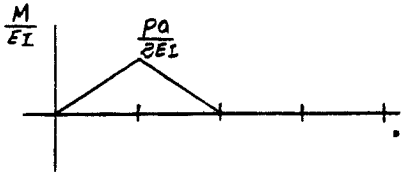
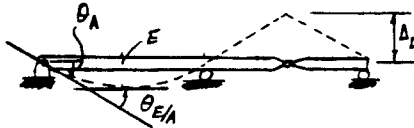
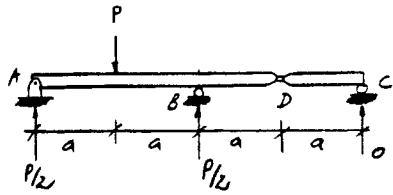
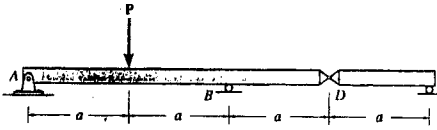

$$\theta_{E/A} = \frac{1}{2} \left(\frac{Pa}{2EI} \right) (a) = \frac{Pa^2}{4EI}$$

$$\theta_E = \theta_{E/A} + \theta_A$$

$$0 = \frac{-Pa^2}{4EI} + \theta_A$$

$$\theta_A = \frac{Pa^2}{4EI} \quad \text{Ans}$$

$$\theta_B = \theta_A = \frac{Pa^2}{4EI}$$

$$\Delta_D = \theta_B a = \frac{Pa^3}{4EI} \quad \text{Ans}$$

From *Mechanics of Materials*, Sixth Edition by R. C. Hibbeler, ISBN 0-13-191345-X.

© 2005 R. C. Hibbeler. Published by Pearson Prentice Hall,

Pearson Education, Inc., Upper Saddle River, NJ. All rights reserved.

This material is protected under all copyright laws as they currently exist. No portion of this material may be reproduced, in any form or by any means, without permission in writing from the publisher.

12-81 A beam having a constant EI is supported as shown. Attached to the beam at A is a pointer, free of load. Both the beam and pointer are originally horizontal when no load is applied to the beam. Determine the distance between the end of the beam and the pointer after each has been displaced by the loading shown.

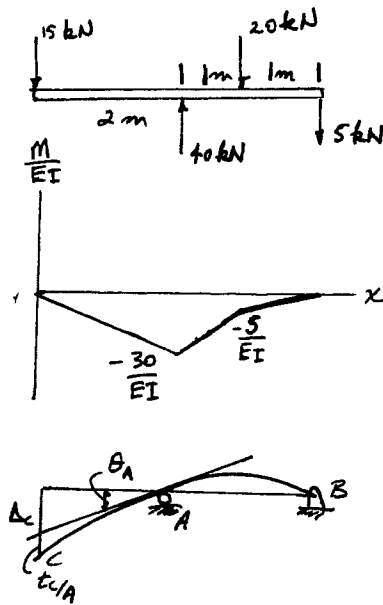
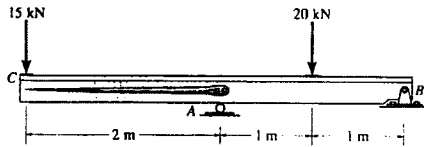

Determine $t_{C/A}$

$$t_{C/A} = \frac{1}{2} \left(\frac{30}{EI} \right) (2) \left(\frac{2}{3} \right) (2)$$

$$t_{C/A} = \frac{40}{EI} \quad \text{Ans}$$

From *Mechanics of Materials*, Sixth Edition by R. C. Hibbeler, ISBN 0-13-191345-X.

© 2005 R. C. Hibbeler. Published by Pearson Prentice Hall,

Pearson Education, Inc., Upper Saddle River, NJ. All rights reserved.

This material is protected under all copyright laws as they currently exist. No portion of this material may be reproduced, in any form or by any means, without permission in writing from the publisher.

12-82. The two A-36 steel bars have a thickness of 1 in. and a width of 4 in. They are designed to act as a spring for the machine which exerts a force of 4 kip on them at *A* and *B*. If the supports exert only vertical forces on the bars, determine the maximum deflection of the bottom bar.

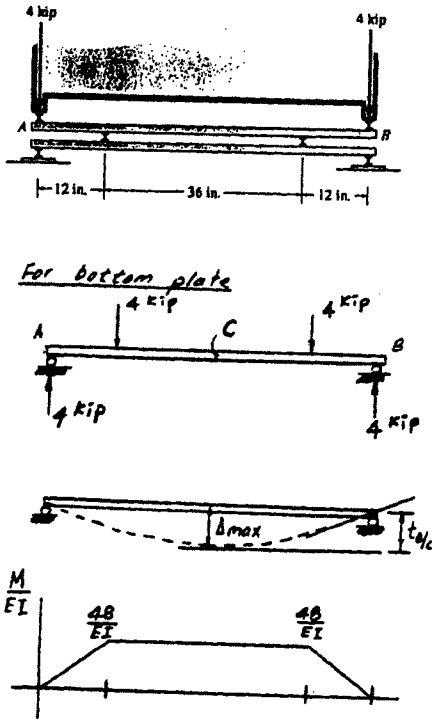

For bottom plate

$$\Delta_{max} = \Delta_{B/C} = \left(\frac{48}{EI}\right)(18)(9+12) + \frac{1}{2}\left(\frac{48}{EI}\right)(12)(8)$$

$$= \frac{20448}{EI} = \frac{20448}{29(10^3)\left(\frac{1}{12}\right)(4)(1^3)} = 2.12 \text{ in.} \quad \text{Ans}$$

From *Mechanics of Materials*, Sixth Edition by R. C. Hibbeler, ISBN 0-13-191345-X.
 © 2005 R. C. Hibbeler. Published by Pearson Prentice Hall,
 Pearson Education, Inc., Upper Saddle River, NJ. All rights reserved.
 This material is protected under all copyright laws as they currently exist. No portion of this material may be reproduced, in any form or by any means, without permission in writing from the publisher.

12-83 Beams made of fiber-reinforced plastic may one day replace many of those made of A-36 steel since they are one-fourth the weight of steel and are corrosion resistant. Using the table in Appendix B, with $\sigma_{\text{allow}} = 22$ ksi and $\tau_{\text{allow}} = 12$ ksi, select the lightest-weight steel wide-flange beam that will safely support the 5-kip load, then compute its maximum deflection. What would be the maximum deflection of this beam if it were made of a fiber-reinforced plastic with $E_p = 18(10^3)$ ksi and had the same moment of inertia as the steel beam?

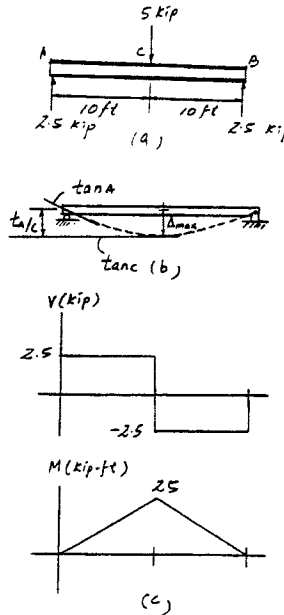
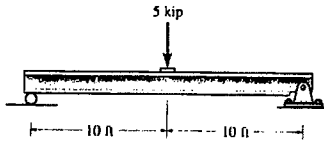

$$M_{\text{max}} = 25 \text{ kip} \cdot \text{ft}$$

$$S_{\text{req'd}} = \frac{M_{\text{max}}}{\sigma_{\text{allow}}} = \frac{25(12)}{22} = 13.63 \text{ in}^3$$

Select W 12 x 14

$$(S_x = 14.9 \text{ in}^3 \quad I_x = 88.6 \text{ in}^4 \quad d = 11.91 \text{ in.} \quad t_w = 0.200 \text{ in.})$$

Check shear :

$$\tau_{\text{max}} = \frac{V_{\text{max}}}{A_w} = \frac{2.5}{11.91(0.200)} = 1.05 \text{ ksi} < \tau_{\text{allow}} = 12 \text{ ksi} \quad \text{OK}$$

Use W 12 x 14

Ans

$$\Delta_{\text{max}} = |t_{A/C}| = \frac{1}{2} \left(\frac{25}{EI} \right) (10) \left(\frac{2}{3} \right) (10) = \frac{833.33 \text{ kip} \cdot \text{ft}^3}{EI}$$

For the A-36 steel beam :

$$\Delta_{\text{max}} = \frac{833.33(12^3)}{29(10^3)(88.6)} = 0.560 \text{ in.} \quad \text{Ans}$$

For fiber-reinforced plastic beam :

$$\Delta_{\text{max}} = \frac{833.33(12^3)}{18(10^3)(88.6)} = 0.903 \text{ in.} \quad \text{Ans}$$

From *Mechanics of Materials*, Sixth Edition by R. C. Hibbeler, ISBN 0-13-191345-X.

© 2005 R. C. Hibbeler. Published by Pearson Prentice Hall,

Pearson Education, Inc., Upper Saddle River, NJ. All rights reserved.

This material is protected under all copyright laws as they currently exist. No portion of this material may be reproduced, in any form or by any means, without permission in writing from the publisher.

***12-84.** Determine the slope at C and deflection at B . EI is constant.

Support Reactions and Elastic Curve : As shown.

M/EI Diagram : As shown.

Moment - Area Theorems : The slope at support A is zero. The slope at C is

$$\begin{aligned} \theta_C = |\theta_{C/A}| &= \frac{1}{2} \left(\frac{wa^2}{EI} \right) (a) + \left(\frac{-wa^2}{2EI} \right) (a) \\ &= \frac{wa^3}{EI} \end{aligned} \quad \text{Ans}$$

The displacement at B is

$$\begin{aligned} \Delta_B = |t_{B/A}| &= \frac{1}{2} \left(\frac{wa^2}{EI} \right) (a) \left(a + \frac{2}{3}a \right) + \left(\frac{-wa^2}{2EI} \right) (a) \left(a + \frac{a}{2} \right) \\ &\quad + \frac{1}{3} \left(\frac{-wa^2}{2EI} \right) (a) \left(\frac{3}{4}a \right) \\ &= \frac{41wa^4}{24EI} \downarrow \end{aligned} \quad \text{Ans}$$

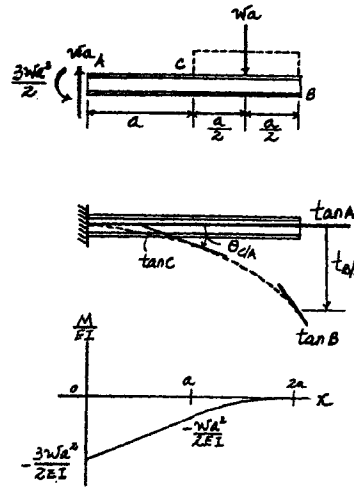

From *Mechanics of Materials*, Sixth Edition by R. C. Hibbeler, ISBN 0-13-191345-X.

© 2005 R. C. Hibbeler. Published by Pearson Prentice Hall,

Pearson Education, Inc., Upper Saddle River, NJ. All rights reserved.

This material is protected under all copyright laws as they currently exist. No portion of this material may be reproduced, in any form or by any means, without permission in writing from the publisher.

12-85. The A-36 steel shaft is used to support a rotor that exerts a uniform load of 5 kN/m within the region CD of the shaft. Determine the slope of the shaft at the bearings A and B . The bearings exert only vertical reactions on the shaft.

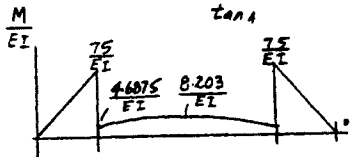
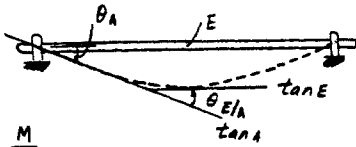
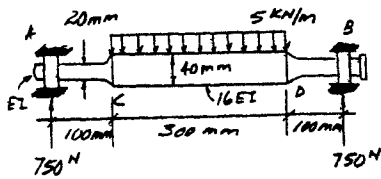
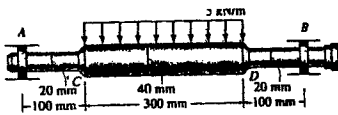

$$\theta_{B/A} = \frac{1}{2} \left(\frac{75}{EI} \right) (0.1) + \left(\frac{4.6875}{EI} \right) (0.15) + \frac{2}{3} \left(\frac{3.5156}{EI} \right) (0.15) = \frac{4.805}{EI}$$

$$\theta_A = \theta_{B/A} = \frac{4.805}{EI} = \frac{4.805}{\frac{75}{4} (0.01)^4} = 0.00306 \text{ rad} = 0.175^\circ$$

Ans

From *Mechanics of Materials*, Sixth Edition by R. C. Hibbeler, ISBN 0-13-191345-X.

© 2005 R. C. Hibbeler. Published by Pearson Prentice Hall,

Pearson Education, Inc., Upper Saddle River, NJ. All rights reserved.

This material is protected under all copyright laws as they currently exist. No portion of this material may be reproduced, in any form or by any means, without permission in writing from the publisher.

12-86 The beam is subjected to the loading shown. Determine the slope at B and deflection at C . EI is constant.

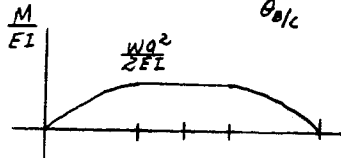
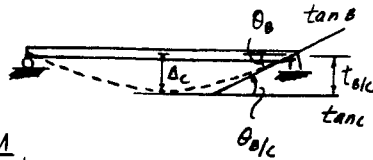
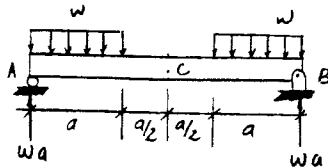
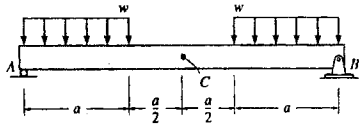

$$\theta_{B/C} = \frac{wa^2}{2EI} \left(\frac{a}{2}\right) + \frac{2}{3} \left(\frac{wa^2}{2EI}\right)(a) = \frac{7wa^3}{12EI}$$

$$\theta_B = \theta_{B/C} = \frac{7wa^3}{12EI} \quad \text{Ans}$$

$$\Delta_C = t_{B/C} = \frac{wa^2}{2EI} \left(\frac{a}{2}\right) \left(a + \frac{a}{4}\right) + \frac{2}{3} \left(\frac{wa^2}{2EI}\right)(a) \left(\frac{5}{8}a\right)$$

$$= \frac{25wa^4}{48EI} \quad \text{Ans}$$

From *Mechanics of Materials*, Sixth Edition by R. C. Hibbeler, ISBN 0-13-191345-X.

© 2005 R. C. Hibbeler. Published by Pearson Prentice Hall,

Pearson Education, Inc., Upper Saddle River, NJ. All rights reserved.

This material is protected under all copyright laws as they currently exist. No portion of this material may be reproduced, in any form or by any means, without permission in writing from the publisher.

12-87 The two bars are pin connected at D . Determine the slope at A and the deflection at D . EI is constant.

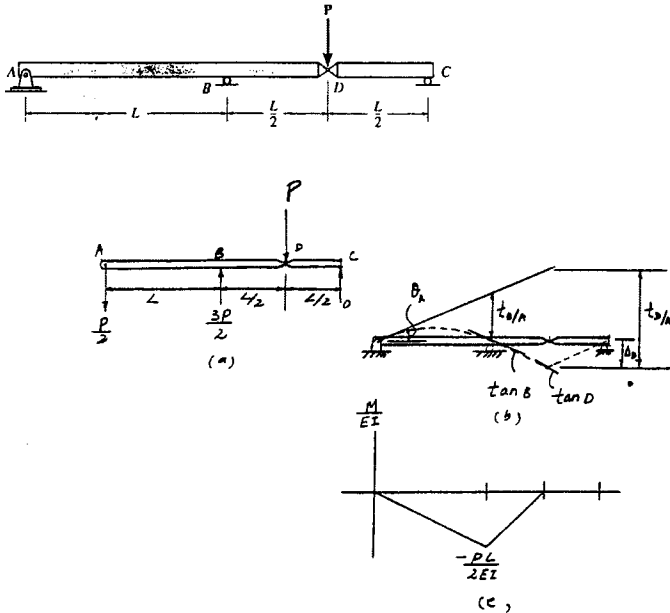

$$t_{B/A} = \frac{1}{2} \left(\frac{-PL}{2EI} \right) (L) \left(\frac{L}{3} \right) = \frac{-PL^3}{12EI}$$

$$\theta_A = \frac{|t_{B/A}|}{L} = \frac{PL^2}{12EI} \quad \text{Ans}$$

The deflection :

$$\begin{aligned} t_{D/A} &= \frac{1}{2} \left(\frac{-PL}{2EI} \right) (L) \left(\frac{L}{2} + \frac{L}{3} \right) + \frac{1}{2} \left(\frac{-PL}{2EI} \right) \left(\frac{L}{2} \right) \left(\frac{L}{3} \right) \\ &= -\frac{PL^3}{4EI} \end{aligned}$$

$$\Delta_D = |t_{D/A}| - \left(\frac{3L}{2} \right) |t_{B/A}|$$

$$= \frac{PL^3}{4EI} - \frac{3}{2} \left(\frac{PL^3}{12EI} \right) = \frac{PL^3}{8EI} \quad \text{Ans}$$

From *Mechanics of Materials*, Sixth Edition by R. C. Hibbeler, ISBN 0-13-191345-X.

© 2005 R. C. Hibbeler. Published by Pearson Prentice Hall,

Pearson Education, Inc., Upper Saddle River, NJ. All rights reserved.

This material is protected under all copyright laws as they currently exist. No portion of this material may be reproduced, in any form or by any means, without permission in writing from the publisher.

*12-88 Determine the maximum deflection of the beam.
 EI is constant.

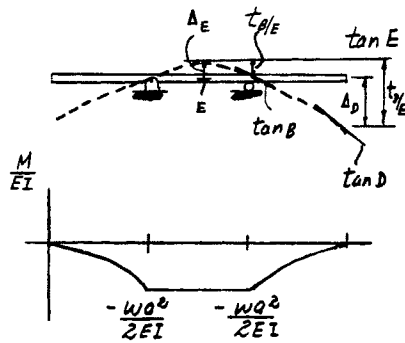
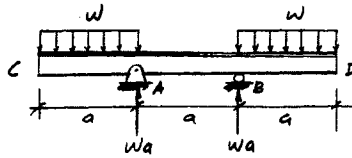
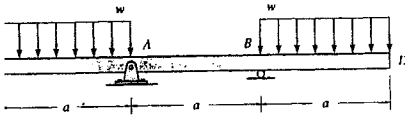

$$t_{B/E} = \left(\frac{-wa^2}{2EI}\right)\left(\frac{a}{2}\right)\left(\frac{a}{4}\right) = \frac{-wa^4}{16EI}$$

$$\Delta_E = |t_{B/E}| = \frac{wa^4}{16EI} \uparrow$$

$$t_{D/E} = \left(\frac{-wa^2}{2EI}\right)\left(\frac{a}{2}\right)\left(a + \frac{a}{4}\right) + \frac{1}{3}\left(\frac{-wa^2}{2EI}\right)(a)\left(\frac{3a}{4}\right) = -\frac{7wa^4}{16EI}$$

$$\Delta_D = |t_{D/E}| - |t_{B/E}| = \frac{7wa^4}{16EI} - \frac{wa^4}{16EI} = \frac{3wa^4}{8EI}$$

$$\Delta_{\max} = \Delta_D = \frac{3wa^4}{8EI} \quad \text{Ans}$$

From *Mechanics of Materials*, Sixth Edition by R. C. Hibbeler, ISBN 0-13-191345-X.

© 2005 R. C. Hibbeler. Published by Pearson Prentice Hall,

Pearson Education, Inc., Upper Saddle River, NJ. All rights reserved.

This material is protected under all copyright laws as they currently exist. No portion of this material may be reproduced, in any form or by any means, without permission in writing from the publisher.

12-89. The $W8 \times 48$ cantilevered beam is made of A-36 steel and is subjected to the loading shown. Determine the deflection at its end A.

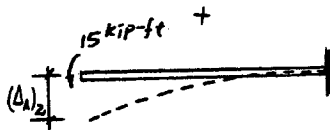
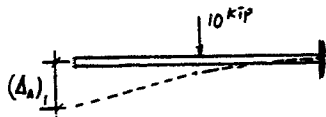
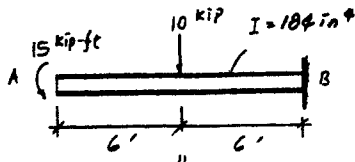
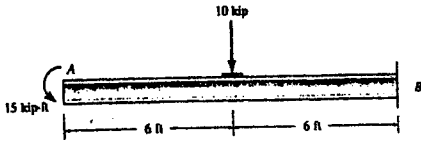

$$(\Delta_A)_1 = \frac{5PL^3}{48EI} = \frac{5(10)(12^3)}{48EI} = \frac{1800}{EI} \downarrow$$

$$(\Delta_A)_2 = \frac{ML^2}{2EI} = \frac{15(12^2)}{2EI} = \frac{1080}{EI} \downarrow$$

$$\begin{aligned} + \downarrow \Delta_A &= (\Delta_A)_1 + (\Delta_A)_2 = \frac{1800}{EI} + \frac{1080}{EI} = \frac{2880}{EI} \\ &= \frac{2880(1728)}{29(10^3)(184)} = 0.933 \text{ in.} \quad \text{Ans} \end{aligned}$$

From *Mechanics of Materials*, Sixth Edition by R. C. Hibbeler, ISBN 0-13-191345-X.

© 2005 R. C. Hibbeler. Published by Pearson Prentice Hall,

Pearson Education, Inc., Upper Saddle River, NJ. All rights reserved.

This material is protected under all copyright laws as they currently exist. No portion of this material may be reproduced, in any form or by any means, without permission in writing from the publisher.

12-90. The $W12 \times 45$ simply supported beam is made of A-36 steel and is subjected to the loading shown. Determine the deflection at its center C .

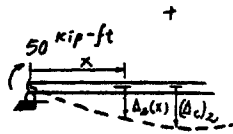
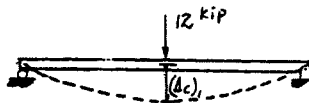
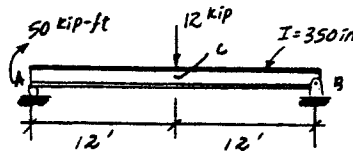
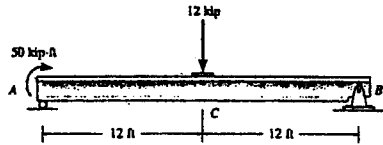

$$(\Delta_c)_1 = \frac{PL^3}{48EI} = \frac{12(24^3)}{48EI} = \frac{3456}{EI} \downarrow$$

$$\Delta_2(x) = \frac{Mx}{6LEI}(x^2 - 3Lx + 2L^2)$$

At point C , $x = \frac{L}{2}$

$$\begin{aligned} (\Delta_c)_2 &= \frac{M(\frac{L}{2})}{6LEI} \left(\frac{L^2}{4} - 3L(\frac{L}{2}) + 2L^2 \right) \\ &= \frac{ML^2}{16EI} = \frac{50(24^2)}{16EI} = \frac{1800}{EI} \downarrow \end{aligned}$$

$$\Delta_c = (\Delta_c)_1 + (\Delta_c)_2 = \frac{3456}{EI} + \frac{1800}{EI} = \frac{5256}{EI}$$

$$= \frac{5256(1728)}{29(10^3)(350)} = 0.895 \text{ in.} \downarrow \quad \text{Ans}$$

From *Mechanics of Materials*, Sixth Edition by R. C. Hibbeler, ISBN 0-13-191345-X.

© 2005 R. C. Hibbeler. Published by Pearson Prentice Hall,

Pearson Education, Inc., Upper Saddle River, NJ. All rights reserved.

This material is protected under all copyright laws as they currently exist. No portion of this material may be reproduced, in any form or by any means, without permission in writing from the publisher.

12-91 The $W14 \times 43$ simply supported beam is made of A-36 steel and is subjected to the loading shown. Determine the deflection at its center C .

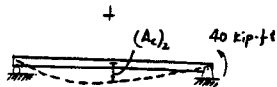
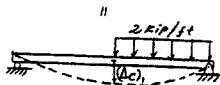
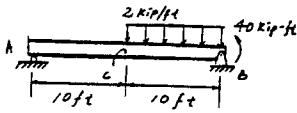
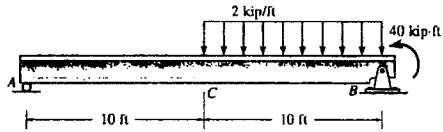

$$(\Delta_c)_1 = \frac{5wL^4}{768EI} = \frac{5(2)(20^4)}{768EI} = \frac{2083.33}{EI} \downarrow$$

$$(\Delta_c)_2 = \frac{Mx}{6EIL} (x^2 - 3Lx + 2L^2) = \frac{40(10)}{6(20)EI} [10^2 - 3(20)(10) + 2(20)^2]$$

$$= \frac{1000}{EI} \downarrow$$

$$\Delta_c = (\Delta_c)_1 + (\Delta_c)_2 = \frac{2083.33}{EI} + \frac{1000}{EI}$$

$$= \frac{3083.33}{EI} \text{ kip} \cdot \text{ft}^3$$

Numerical substitution for $W 14 \times 43$, $I_x = 428 \text{ in}^4$

$$\Delta_c = \frac{3083.33(12^3)}{29(10^3)(428)} = 0.429 \text{ in.} \quad \text{Ans}$$

From *Mechanics of Materials*, Sixth Edition by R. C. Hibbeler, ISBN 0-13-191345-X.

© 2005 R. C. Hibbeler. Published by Pearson Prentice Hall,

Pearson Education, Inc., Upper Saddle River, NJ. All rights reserved.

This material is protected under all copyright laws as they currently exist. No portion of this material may be reproduced, in any form or by any means, without permission in writing from the publisher.

*12-92 The $W14 \times 43$ simply supported beam is made of A-36 steel and is subjected to the loading shown. Determine the slope at A and B .

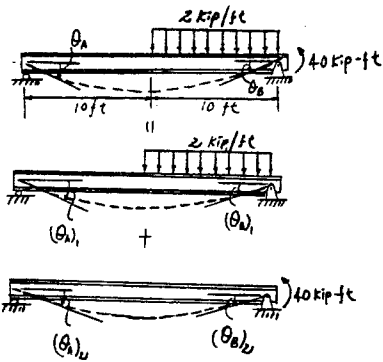
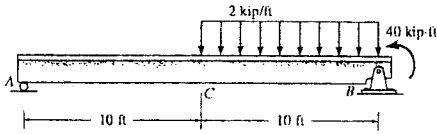

$$\begin{aligned}
 \theta_A &= \theta_{A_1} + \theta_{A_2} \\
 &= \frac{7wL^3}{384EI} + \frac{ML}{6EI} \\
 &= \frac{7(2)(240^3)}{384EI} + \frac{40(12)(240)}{6EI} = \frac{61,200}{29(10^3)(428)} \\
 &= 0.00493 \text{ rad} = 0.283^\circ \quad \text{Ans}
 \end{aligned}$$

$$\begin{aligned}
 \theta_B &= \theta_{B_1} + \theta_{B_2} \\
 &= \frac{3wL^3}{128EI} + \frac{ML}{3EI} \\
 &= \frac{3(2)(240^3)}{128EI} + \frac{40(12)(240)}{3EI} = \frac{92,400}{29(10^3)(428)} \\
 &= 0.007444 \text{ rad} = 0.427^\circ \quad \text{Ans}
 \end{aligned}$$

From *Mechanics of Materials*, Sixth Edition by R. C. Hibbeler, ISBN 0-13-191345-X.

© 2005 R. C. Hibbeler. Published by Pearson Prentice Hall,

Pearson Education, Inc., Upper Saddle River, NJ. All rights reserved.

This material is protected under all copyright laws as they currently exist. No portion of this material may be reproduced, in any form or by any means, without permission in writing from the publisher.

12-93 The $W8 \times 24$ simply supported beam is made of A-36 steel and is subjected to the loading shown. Determine the deflection at its center C.

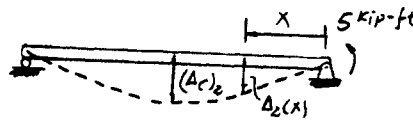
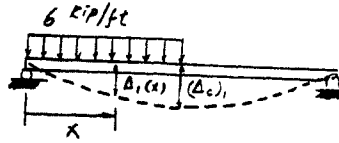
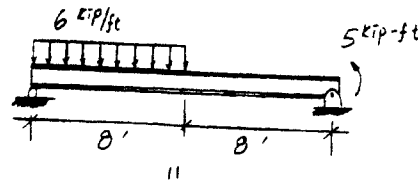
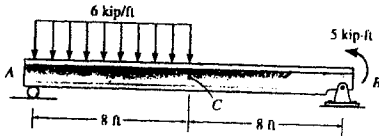

$$I = 82.8 \text{ in}^4$$

$$(\Delta_c)_1 = \frac{5wL^4}{768EI} = \frac{5(6)(16^4)}{768EI} = \frac{2560}{EI} \downarrow$$

$$\Delta_2(x) = \frac{Mx}{6LEI}(x^2 - 3Lx + 2L^2)$$

At point C, $x = \frac{L}{2}$

$$(\Delta_c)_2 = \frac{M(\frac{L}{2})}{6LEI}(\frac{L^2}{4} - 3L(\frac{L}{2}) + 2L^2)$$

$$= \frac{ML^2}{16EI} = \frac{5(16^2)}{16EI} = \frac{80}{EI} \downarrow$$

$$\Delta_c = (\Delta_c)_1 + (\Delta_c)_2 = \frac{2560}{EI} + \frac{80}{EI} = \frac{2640}{EI}$$

$$= \frac{2640(1728)}{29(10^3)(82.8)} = 1.90 \text{ in.} \quad \text{Ans}$$

From *Mechanics of Materials*, Sixth Edition by R. C. Hibbeler, ISBN 0-13-191345-X.

© 2005 R. C. Hibbeler. Published by Pearson Prentice Hall,

Pearson Education, Inc., Upper Saddle River, NJ. All rights reserved.

This material is protected under all copyright laws as they currently exist. No portion of this material may be reproduced, in any form or by any means, without permission in writing from the publisher.

12-94. The beam supports the loading shown. Code restrictions, due to a plaster ceiling, require the maximum deflection not to exceed $1/360$ of the span length. Select the lightest-weight A-36 steel wide-flange beam from Appendix B that will satisfy this requirement and safely support the load. The allowable bending stress is $\sigma_{\text{allow}} = 24$ ksi and the allowable shear stress is $\tau_{\text{allow}} = 14$ ksi. Assume A is a roller and B is a pin.

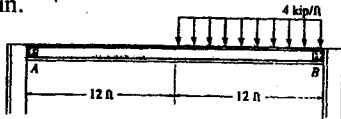

$$V_{\text{max}} = 36 \text{ kip}$$

$$M_{\text{max}} = 162 \text{ kip} \cdot \text{ft}$$

Strength criterion :

$$\sigma_{\text{allow}} = \frac{M}{S_{\text{req'd}}}$$

$$24 = \frac{162(12)}{S_{\text{req'd}}}$$

$$S_{\text{req'd}} = 81 \text{ in}^3$$

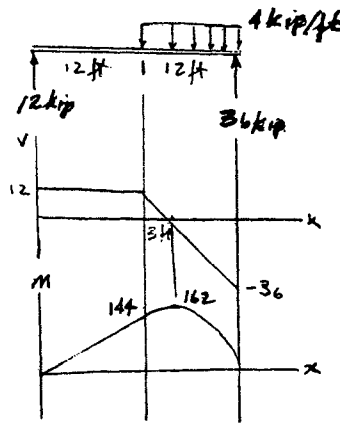

Choose $W 16 \times 50$, $S = 81.0 \text{ in}^3$, $t_w = 0.380 \text{ in.}$, $d = 16.26 \text{ in.}$, $I_x = 659 \text{ in}^4$

Check shear :

$$\tau_{\text{allow}} = \frac{V}{A_{web}}$$

$$14 \geq \frac{36}{(16.26)(0.380)} = 5.83 \text{ ksi} \quad \text{OK}$$

Deflection Criterion;

$$v_{\text{max}} = 0.006563 \frac{wL^4}{EI} = 0.006563 \left(\frac{(4)(24)^4(12)^3}{29(10^3)(659)} \right) = 0.7875 \text{ in.} < \frac{1}{360}(24)(12) = 0.800 \quad \text{OK}$$

Use $W16 \times 50$ Ans

From *Mechanics of Materials*, Sixth Edition by R. C. Hibbeler, ISBN 0-13-191345-X.

© 2005 R. C. Hibbeler. Published by Pearson Prentice Hall,

Pearson Education, Inc., Upper Saddle River, NJ. All rights reserved.

This material is protected under all copyright laws as they currently exist. No portion of this material may be reproduced, in any form or by any means, without permission in writing from the publisher.

12-95. The simply supported beam carries a uniform load of 2 kip/ft. Code restrictions, due to a plaster ceiling, require the maximum deflection not to exceed 1/360 of the span length. Select the lightest-weight A-36 steel wide-flange beam from Appendix B that will satisfy this requirement and safely support the load. The allowable bending stress is $\sigma_{\text{allow}} = 24$ ksi and the allowable shear stress is $\tau_{\text{allow}} = 14$ ksi. Assume A is a pin and B a roller support.

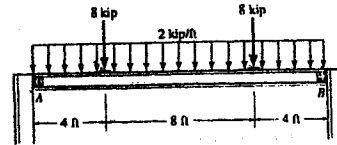

$$M_{\text{max}} = 96 \text{ kip} \cdot \text{ft}$$

Strength criterion :

$$\sigma_{\text{allow}} = \frac{M}{S_{\text{req'd}}}$$

$$24 = \frac{96(12)}{S_{\text{req'd}}}$$

$$S_{\text{req'd}} = 48 \text{ in}^3$$

Choose $W 14 \times 34$, $S = 48.6 \text{ in}^3$, $t_w = 0.285 \text{ in.}$, $d = 13.98 \text{ in.}$, $I = 340 \text{ in}^4$

$$\tau_{\text{allow}} = \frac{V}{A_{\text{web}}}$$

$$14 \geq \frac{24}{(13.98)(0.285)} = 6.02 \text{ ksi} \quad \text{OK}$$

Deflection criterion;

Maximum is at center.

$$v_{\text{max}} = \frac{5wL^4}{384EI} + (2) \frac{P(4)(8)}{6EI(16)} [(16)^2 - (4)^2 - (8)^2] (12)^3$$

$$= \left[\frac{5(2)(16)^4}{384EI} + \frac{117.33(8)}{EI} \right] (12)^3$$

$$= \frac{4.571(10^6)}{29(10^6)(340)} = 0.000464 \text{ in.} < \frac{1}{360}(16)(12) = 0.533 \text{ in.} \quad \text{OK}$$

Use $W 14 \times 34$ Ans

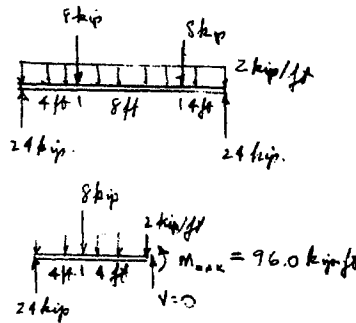

From *Mechanics of Materials*, Sixth Edition by R. C. Hibbeler, ISBN 0-13-191345-X.

© 2005 R. C. Hibbeler. Published by Pearson Prentice Hall,

Pearson Education, Inc., Upper Saddle River, NJ. All rights reserved.

This material is protected under all copyright laws as they currently exist. No portion of this material may be reproduced, in any form or by any means, without permission in writing from the publisher.

*12-96 The $W10 \times 30$ steel cantilevered beam is made of A-36 steel and is subjected to unsymmetrical bending caused by the applied moment. Determine the deflection of the centroid at its end A due to the loading. *Hint:* Resolve the moment into components and use superposition.

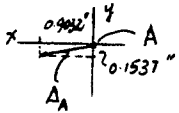
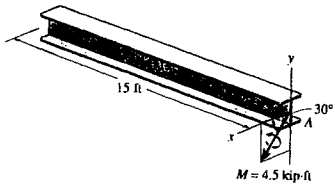

$$I_x = 170 \text{ in}^4, \quad I_y = 16.7 \text{ in}^4$$

$$x_{\max} = \frac{(M \sin \theta)L^2}{2EI_y} = \frac{4.5(\sin 30^\circ)(15^2)(12)^3}{2(29)(10^3)(16.7)} = 0.9032 \text{ in.}$$

$$y_{\max} = \frac{(M \cos \theta)L^2}{2EI_x} = \frac{4.5(\cos 30^\circ)(15^2)(12)^3}{2(29)(10^3)(170)} = 0.1537 \text{ in.}$$

$$\Delta_A = \sqrt{0.9032^2 + 0.1537^2} = 0.916 \text{ in.} \quad \text{Ans}$$

From *Mechanics of Materials*, Sixth Edition by R. C. Hibbeler, ISBN 0-13-191345-X.

© 2005 R. C. Hibbeler. Published by Pearson Prentice Hall,

Pearson Education, Inc., Upper Saddle River, NJ. All rights reserved.

This material is protected under all copyright laws as they currently exist. No portion of this material may be reproduced, in any form or by any means, without permission in writing from the publisher.

12-97. Determine the vertical deflection at the end *A* of the bracket. Assume that the bracket is fixed supported at its base *B* and neglect axial deflection. *EI* is constant.

$$\theta = \frac{ML}{EI} = \frac{Pab}{EI}$$

$$(\Delta_A)_1 = \theta(a) = \frac{Pa^2b}{EI}$$

$$(\Delta_A)_2 = \frac{PL^3}{3EI} = \frac{Pa^3}{3EI}$$

$$\Delta_A = (\Delta_A)_1 + (\Delta_A)_2 = \frac{Pa^2b}{EI} + \frac{Pa^3}{3EI} = \frac{Pa^2(3b+a)}{3EI} \quad \text{Ans}$$

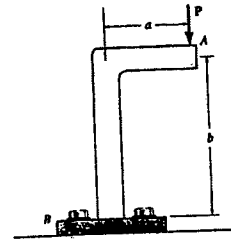
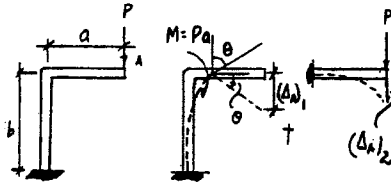

From *Mechanics of Materials*, Sixth Edition by R. C. Hibbeler, ISBN 0-13-191345-X.
 © 2005 R. C. Hibbeler. Published by Pearson Prentice Hall,
 Pearson Education, Inc., Upper Saddle River, NJ. All rights reserved.
 This material is protected under all copyright laws as they currently exist. No portion of this material may be reproduced, in any form or by any means, without permission in writing from the publisher.

12-98. The rod is pinned at its end A and attached to a torsional spring having a stiffness k , which measures the torque per radian of rotation of the spring. If a force \mathbf{P} is always applied perpendicular to the end of the rod, determine the displacement of the force. EI is constant.

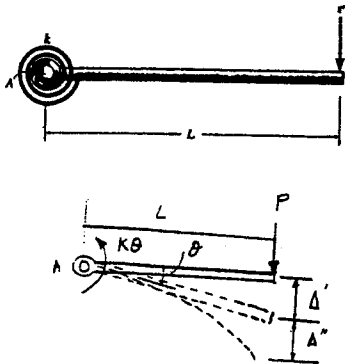

In order to maintain equilibrium, the rod has to rotate through an angle θ .

$$\zeta + \Sigma M_A = 0; \quad k\theta - PL = 0; \quad \theta = \frac{PL}{k}$$

Hence,

$$\Delta' = L\theta = L\left(\frac{PL}{k}\right) = \frac{PL^2}{k}$$

Elastic deformation :

$$\Delta'' = \frac{PL^3}{3EI}$$

Therefore,

$$\Delta = \Delta' + \Delta'' = \frac{PL^2}{k} + \frac{PL^3}{3EI} = PL^2\left(\frac{1}{k} + \frac{L}{3EI}\right) \quad \text{Ans}$$

From *Mechanics of Materials*, Sixth Edition by R. C. Hibbeler, ISBN 0-13-191345-X.

© 2005 R. C. Hibbeler. Published by Pearson Prentice Hall,

Pearson Education, Inc., Upper Saddle River, NJ. All rights reserved.

This material is protected under all copyright laws as they currently exist. No portion of this material may be reproduced, in any form or by any means, without permission in writing from the publisher.

12-99. The pipe assembly consists of three equal-sized pipes with flexibility stiffness EI and torsional stiffness GJ . Determine the vertical deflection at point A .

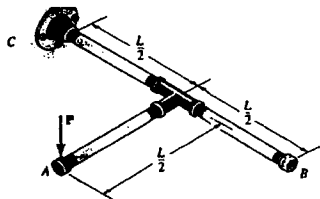

$$\Delta_B = \frac{P(\frac{L}{2})^3}{3EI} = \frac{PL^3}{24EI}$$

$$(\Delta_A)_1 = \frac{P(\frac{L}{2})^3}{3EI} = \frac{PL^3}{24EI}$$

$$\theta = \frac{TL}{JG} = \frac{(PL/2)(\frac{L}{2})}{JG} = \frac{PL^2}{4JG}$$

$$(\theta_A)_2 = \theta(\frac{L}{2}) = \frac{PL^3}{8JG}$$

$$\begin{aligned} \Delta_A &= \Delta_B + (\Delta_A)_1 + (\Delta_A)_2 \\ &= \frac{PL^3}{24EI} + \frac{PL^3}{24EI} + \frac{PL^3}{8JG} \\ &= PL^3 \left(\frac{1}{12EI} + \frac{1}{8JG} \right) \quad \text{Ans} \end{aligned}$$

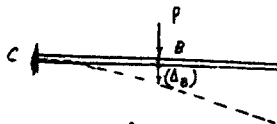
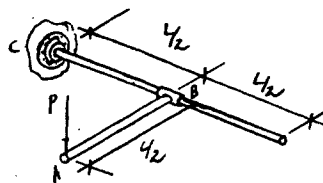

$$\Delta_B = \frac{P(\frac{L}{2})^3}{3EI} = \frac{PL^3}{24EI}$$



From *Mechanics of Materials*, Sixth Edition by R. C. Hibbeler, ISBN 0-13-191345-X.

© 2005 R. C. Hibbeler. Published by Pearson Prentice Hall,

Pearson Education, Inc., Upper Saddle River, NJ. All rights reserved.

This material is protected under all copyright laws as they currently exist. No portion of this material may be reproduced, in any form or by any means, without permission in writing from the publisher.

***12-100.** Determine the vertical deflection and slope at the end *A* of the bracket. Assume that the bracket is fixed supported at its base, and neglect the axial deformation of segment *AB*. *EI* is constant.

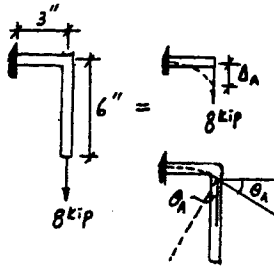
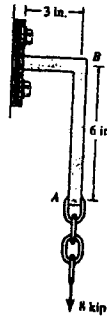

$$\Delta_A = \frac{PL^3}{3EI} = \frac{8(3)^3}{3EI} = \frac{72}{EI} \quad \text{Ans}$$

$$\theta_A = \frac{PL^2}{2EI} = \frac{8(3^2)}{2EI} = \frac{36}{EI} \quad \text{Ans}$$

From *Mechanics of Materials*, Sixth Edition by R. C. Hibbeler, ISBN 0-13-191345-X.

© 2005 R. C. Hibbeler. Published by Pearson Prentice Hall,

Pearson Education, Inc., Upper Saddle River, NJ. All rights reserved.

This material is protected under all copyright laws as they currently exist. No portion of this material may be reproduced, in any form or by any means, without permission in writing from the publisher.

12-101 The wide-flange beam acts as a cantilever. Due to an error it is installed at an angle θ with the vertical. Determine the ratio of its deflection in the x direction to its deflection in the y direction at A when a load P is applied at this point. The moments of inertia are I_x and I_y . For the solution, resolve P into components and use the method of superposition. *Note:* The result indicates that large lateral deflections (x direction) can occur in narrow beams, $I_y \ll I_x$, when they are improperly installed in this manner. To show this numerically, compute the deflections in the x and y directions for an A-36 steel $W10 \times 15$, with $P = 1.5$ kip, $\theta = 10^\circ$, and $L = 12$ ft.

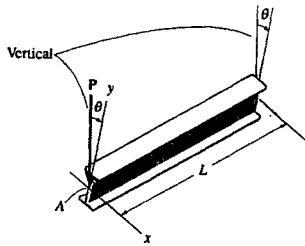

$$y_{\max} = \frac{P \cos \theta L^3}{3EI_x}; \quad x_{\max} = \frac{P \sin \theta L^3}{3EI_y}$$

$$\frac{x_{\max}}{y_{\max}} = \frac{\frac{P \sin \theta L^3}{3EI_y}}{\frac{P \cos \theta L^3}{3EI_x}} = \frac{I_x}{I_y} \tan \theta \quad \text{Ans}$$

$$W 10 \times 15 \quad I_x = 68.9 \text{ in}^4 \quad I_y = 2.89 \text{ in}^4$$

$$y_{\max} = \frac{1.5(\cos 10^\circ)(144)^3}{3(29)(10^3)(68.9)} = 0.736 \text{ in.} \quad \text{Ans}$$

$$x_{\max} = \frac{1.5(\sin 10^\circ)(144)^3}{3(29)(10^3)(2.89)} = 3.09 \text{ in.} \quad \text{Ans}$$

From *Mechanics of Materials*, Sixth Edition by R. C. Hibbeler, ISBN 0-13-191345-X.

© 2005 R. C. Hibbeler. Published by Pearson Prentice Hall,

Pearson Education, Inc., Upper Saddle River, NJ. All rights reserved.

This material is protected under all copyright laws as they currently exist. No portion of this material may be reproduced, in any form or by any means, without permission in writing from the publisher.

12-102. The framework consists of two A-36 steel cantilevered beams CD and BA and a simply supported beam CB . If each beam is made of steel and has a moment of inertia about its principal axis of $I_x = 118 \text{ in}^4$, determine the deflection at the center G of beam CB .

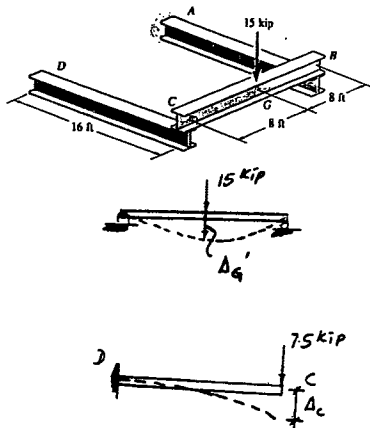

$$\Delta_c = \frac{PL^3}{3EI} = \frac{7.5(16^3)}{3EI} = \frac{10,240}{EI} \downarrow$$

$$\Delta'_G = \frac{PL^3}{48EI} = \frac{15(16^3)}{48EI} = \frac{1,280}{EI} \downarrow$$

$$\begin{aligned} \Delta_G &= \Delta_c + \Delta'_G \\ &= \frac{10,240}{EI} + \frac{1,280}{EI} = \frac{11,520}{EI} \\ &= \frac{11,520(1,768)}{29(10^3)(118)} = 5.82 \text{ in.} \downarrow \quad \text{Ans} \end{aligned}$$

From *Mechanics of Materials*, Sixth Edition by R. C. Hibbeler, ISBN 0-13-191345-X.

© 2005 R. C. Hibbeler. Published by Pearson Prentice Hall,

Pearson Education, Inc., Upper Saddle River, NJ. All rights reserved.

This material is protected under all copyright laws as they currently exist. No portion of this material may be reproduced, in any form or by any means, without permission in writing from the publisher.

12-103. Determine the reactions at the supports A and B , then draw the shear and moment diagrams. Use discontinuity functions. EI is constant.

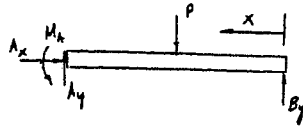
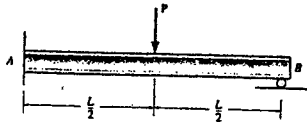

$$\begin{aligned} \rightarrow \Sigma F_x = 0 & \quad A_x = 0 \quad \text{Ans} \\ + \uparrow \Sigma F_y = 0 & \quad A_y + B_y - P = 0 \\ & \quad A_y = P - B_y \quad (1) \\ \curvearrowright + \Sigma M_A = 0 & \quad M_A + B_y(L) - P(L/2) = 0 \\ & \quad M_A = \frac{PL}{2} - B_y L \quad (2) \end{aligned}$$

Bending Moment $M(x)$:

$$M(x) = -(-B_y) \langle x - 0 \rangle - P \langle x - \frac{L}{2} \rangle = B_y x - P \langle x - \frac{L}{2} \rangle$$

Elastic curve and slope:

$$EI \frac{d^2 v}{dx^2} = M(x)$$

$$EI \frac{d^2 v}{dx^2} = B_y x - P \langle x - \frac{L}{2} \rangle$$

$$EI \frac{dv}{dx} = \frac{B_y x^2}{2} - \frac{P}{2} \langle x - \frac{L}{2} \rangle^2 + C_1 \quad (3)$$

$$EIv = \frac{B_y x^3}{6} - \frac{P}{6} \langle x - \frac{L}{2} \rangle^3 + C_1 x + C_2 \quad (4)$$

Boundary conditions:

$$v = 0 \quad \text{at} \quad x = 0$$

From Eq. (4)

$$C_2 = 0$$

$$v = 0 \quad \text{at} \quad x = L$$

From Eq. (4)

$$0 = \frac{B_y L^3}{6} - \frac{PL^3}{48} + C_1 L \quad (5)$$

$$\frac{dv}{dx} = 0 \quad \text{at} \quad x = L$$

From Eq. (3),

$$0 = \frac{B_y L^2}{2} - \frac{PL^2}{8} + C_1 \quad (6)$$

Solving Eqs. (5) and (6) yields,

$$B_y = \frac{5}{16} P \quad \text{Ans} \quad C_1 = \frac{-PL^2}{32}$$

Substitute $B_y = \frac{5}{16} P$ into Eqs. (1) and (2),

$$A_y = \frac{11}{16} P \quad \text{Ans} \quad M_A = \frac{3PL}{16} \quad \text{Ans}$$

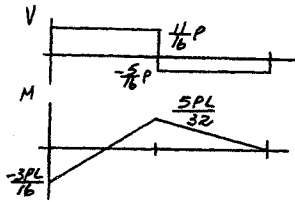

From *Mechanics of Materials*, Sixth Edition by R. C. Hibbeler, ISBN 0-13-191345-X.

© 2005 R. C. Hibbeler. Published by Pearson Prentice Hall,

Pearson Education, Inc., Upper Saddle River, NJ. All rights reserved.

This material is protected under all copyright laws as they currently exist. No portion of this material may be reproduced, in any form or by any means, without permission in writing from the publisher.

***12-104** Determine the reactions at the supports *A* and *B*, then draw the shear and moment diagrams. *EI* is constant. Neglect the effect of axial load.

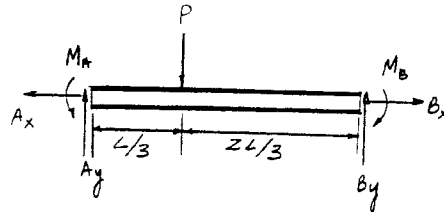
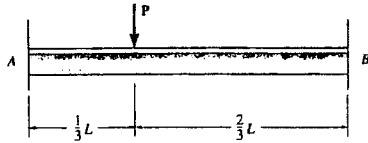

$$\sum M_A = 0; \quad M_A + B_y L - P\left(\frac{L}{3}\right) - M_B = 0 \quad (1)$$

$$+\uparrow \sum F_y = 0; \quad A_y + B_y - P = 0 \quad (2)$$

Moment functions :

$$M_1(x) = B_y x_1 - M_B$$

$$M_2(x) = A_y x_2 - M_A$$

Slope and elastic curve :

$$EI \frac{d^2 v}{dx^2} = M(x)$$

$$\text{For } M_1(x) = B_y x_1 - M_B; \quad EI \frac{d^2 v_1}{dx_1^2} = B_y x_1 - M_B$$

$$EI \frac{dv_1}{dx_1} = \frac{B_y x_1^2}{2} - M_B x_1 + C_1$$

$$EI v_1 = \frac{B_y x_1^3}{6} - \frac{M_B x_1^2}{2} + C_1 x_1 + C_2$$

$$\text{For } M_2(x) = A_y x_2 - M_A$$

$$EI \frac{d^2 v_2}{dx_2^2} = A_y x_2 - M_A$$

$$EI \frac{dv_2}{dx_2} = \frac{A_y x_2^2}{2} - M_A x_2 + C_3$$

$$EI v_2 = \frac{A_y x_2^3}{6} - \frac{M_A x_2^2}{2} + C_3 x_2 + C_4$$

Boundary conditions :

$$\text{At } x_1 = 0, \quad \frac{dv_1}{dx_1} = 0$$

From Eq. (3),

$$0 = 0 - 0 + C_1; \quad C_1 = 0$$

$$\text{At } x_1 = 0, \quad v_1 = 0$$

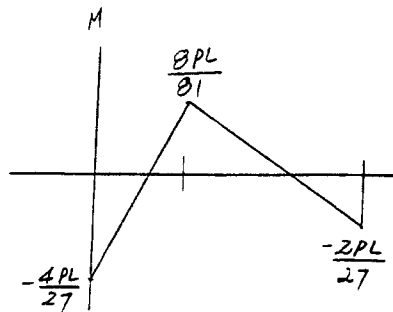
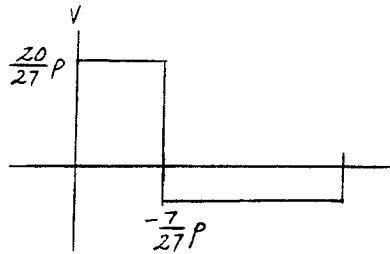
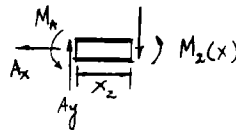
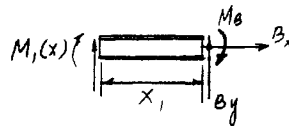

From *Mechanics of Materials*, Sixth Edition by R. C. Hibbeler, ISBN 0-13-191345-X.

© 2005 R. C. Hibbeler. Published by Pearson Prentice Hall,

Pearson Education, Inc., Upper Saddle River, NJ. All rights reserved.

This material is protected under all copyright laws as they currently exist. No portion of this material may be reproduced, in any form or by any means, without permission in writing from the publisher.

12-105 Determine the reactions at the supports A and B , then draw the shear and moment diagrams. EI is constant.

$$\leftarrow \Sigma F_x = 0; \quad A_x = 0 \quad \text{Ans}$$

$$+\uparrow \Sigma F_y = 0; \quad A_y + B_y - wL = 0 \quad (1)$$

$$\curvearrowleft + \Sigma M_A = 0; \quad M_A + B_y L - wL\left(\frac{L}{2}\right) = 0 \quad (2)$$

$$\curvearrowleft + \Sigma M_{NA} = 0; \quad B_y(x) - wx\left(\frac{x}{2}\right) - M(x) = 0$$

$$M(x) = B_y x - \frac{wx^2}{2}$$

$$EI \frac{d^2 v}{dx^2} = M(x)$$

$$EI \frac{d^2 v}{dx^2} = B_y x - \frac{wx^2}{2}$$

$$EI \frac{dv}{dx} = \frac{B_y x^2}{2} - \frac{wx^3}{6} + C_1 \quad (3)$$

$$EI v = \frac{B_y x^3}{6} - \frac{wx^4}{24} + C_1 x + C_2 \quad (4)$$

Boundary conditions :

$$\text{At } x = 0, v = 0$$

From Eq. (4),

$$0 = 0 - 0 + 0 + C_2; \quad C_2 = 0$$

$$\text{At } x = L, \frac{dv}{dx} = 0$$

From Eq. (3),

$$0 = \frac{B_y L^2}{2} - \frac{wL^3}{6} + C_1 \quad (5)$$

$$\text{At } x = L, v = 0$$

From Eq. (4),

$$0 = \frac{B_y L^3}{6} - \frac{wL^4}{24} + C_1 L \quad (6)$$

Solving Eqs. (5) and (6) yields :

$$B_y = \frac{3wL}{8} \quad \text{Ans}$$

$$C_1 = -\frac{wL^3}{48}$$

Substituting B_y into Eqs. (1) and (2) yields :

$$A_y = \frac{5wL}{8} \quad \text{Ans}$$

$$M_A = \frac{wL^2}{8} \quad \text{Ans}$$

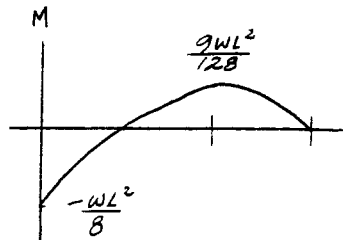
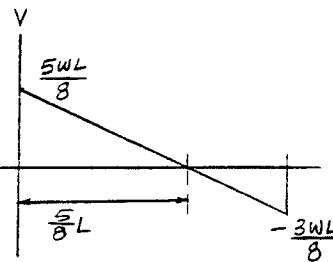
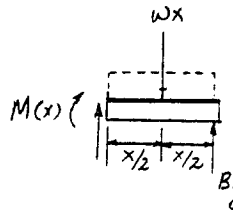
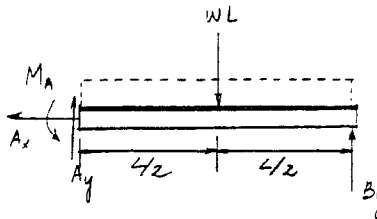
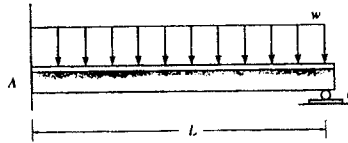

From *Mechanics of Materials*, Sixth Edition by R. C. Hibbeler, ISBN 0-13-191345-X.

© 2005 R. C. Hibbeler. Published by Pearson Prentice Hall,

Pearson Education, Inc., Upper Saddle River, NJ. All rights reserved.

This material is protected under all copyright laws as they currently exist. No portion of this material may be reproduced, in any form or by any means, without permission in writing from the publisher.

12-106. The loading on a floor beam used in the airplane is shown. Use discontinuity functions and determine the reactions at the supports *A* and *B*, and then draw the moment diagram for the beam. The beam is made of aluminum and has a moment of inertia of $I = 320 \text{ in}^4$.

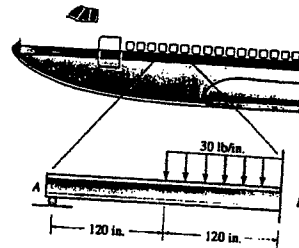

$$\begin{aligned} \rightarrow \Sigma F_x = 0 \quad B_x = 0 \quad \text{Ans} \\ \uparrow \Sigma F_y = 0 \quad A_y + B_y - \frac{wL}{2} = 0; \quad B_y = \frac{wL}{2} - A_y \quad (1) \\ \curvearrowright \Sigma M_A = 0 \quad M_B + A_y L - \frac{wL^2}{8} = 0 \quad M_B = \frac{wL^2}{8} - A_y L \quad (2) \end{aligned}$$

Bending Moment $M(x)$:

$$M(x) = -(A_y) \langle x - 0 \rangle + \frac{w}{2} \langle x - \frac{L}{2} \rangle^2 = A_y x - \frac{w}{2} \langle x - \frac{L}{2} \rangle^2$$

Elastic curve and slope:

$$EI \frac{d^2 v}{dx^2} = M(x)$$

$$EI \frac{d^2 v}{dx^2} = A_y x - \frac{w}{2} \langle x - \frac{L}{2} \rangle^2$$

$$EI \frac{dv}{dx} = \frac{A_y x^2}{2} - \frac{w}{6} \langle x - \frac{L}{2} \rangle^3 + C_1 \quad (3)$$

$$EIv = \frac{A_y x^3}{6} - \frac{w}{24} \langle x - \frac{L}{2} \rangle^4 + C_1 x + C_2 \quad (4)$$

Boundary conditions:

$$v = 0 \quad \text{at} \quad x = 0$$

From Eq. (4)

$$C_2 = 0$$

$$v = 0 \quad \text{at} \quad x = L$$

From Eq. (4)

$$0 = \frac{A_y L^3}{6} - \frac{wL^4}{384} + C_1 L \quad (5)$$

$$\frac{dv}{dx} = 0 \quad \text{at} \quad x = L$$

From Eq. (3)

$$0 = \frac{A_y L^2}{2} - \frac{wL^3}{48} + C_1 \quad (6)$$

Solving Eqs. (5) and (6) yield:

$$A_y = \frac{7}{128} wL \quad C_1 = \frac{-5}{768} wL^2$$

Substitute A_y into Eqs. (1) and (2):

$$B_y = \frac{57}{128} wL \quad M_B = \frac{9}{128} wL^2$$

Substitute numerical values:

$$A_y = \frac{7}{128} (30)(240) = 394 \text{ lb} \quad \text{Ans}$$

$$B_y = \frac{57}{128} (30)(240) = 3206 \text{ lb} = 3.21 \text{ kip} \quad \text{Ans}$$

$$M_B = \frac{9}{128} (30)(240)^2 = 121500 \text{ lb} \cdot \text{in.} = 122 \text{ kip} \cdot \text{in.} \quad \text{Ans}$$

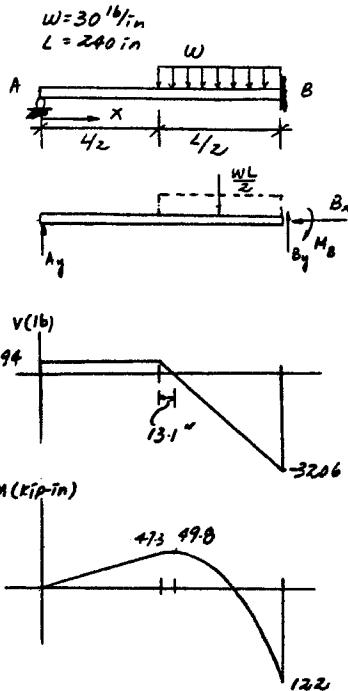

From *Mechanics of Materials*, Sixth Edition by R. C. Hibbeler, ISBN 0-13-191345-X.

© 2005 R. C. Hibbeler. Published by Pearson Prentice Hall,

Pearson Education, Inc., Upper Saddle River, NJ. All rights reserved.

This material is protected under all copyright laws as they currently exist. No portion of this material may be reproduced, in any form or by any means, without permission in writing from the publisher.

12-107 Determine the reactions at the supports A and B .
 EI is constant.

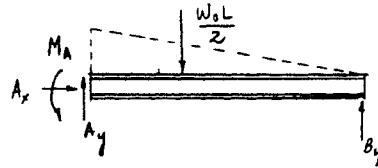
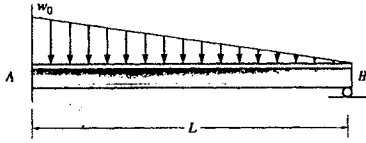

$$\rightarrow \Sigma F_x = 0 \quad A_x = 0 \quad \text{Ans}$$

$$+\uparrow \Sigma F_y = 0 \quad A_y + B_y - \frac{w_0 L}{2} = 0 \quad A_y = \frac{w_0 L}{2} - B_y \quad (1)$$

$$\curvearrowleft + \Sigma M_A = 0 \quad M_A + B_y L - \frac{w_0 L}{2} \left(\frac{L}{3}\right) = 0 \quad M_A = \frac{w_0 L^2}{6} - B_y L \quad (2)$$

Bending Moment $M(x)$:

$$M(x) = B_y x - \frac{w_0 x^3}{6L}$$

Elastic curve and slope :

$$EI \frac{d^2 v}{dx^2} = M(x)$$

$$EI \frac{d^2 v}{dx^2} = B_y x - \frac{w_0 x^3}{6L}$$

$$EI \frac{dv}{dx} = \frac{B_y x^2}{2} - \frac{w_0 x^4}{24L} + C_1 \quad (3)$$

$$EI v = \frac{B_y x^3}{6} - \frac{w_0 x^5}{120L} + C_1 x + C_2 \quad (4)$$

Boundary conditions :

$$v = 0 \quad \text{at} \quad x = 0$$

From Eq. (4)

$$C_2 = 0$$

$$v = 0 \quad \text{at} \quad x = L$$

From Eq. (4)

$$0 = \frac{B_y L^3}{6} - \frac{w_0 L^4}{120} + C_1 L \quad (5)$$

$$\frac{dv}{dx} = 0 \quad \text{at} \quad x = L$$

From Eq. (3)

$$0 = \frac{B_y L^2}{2} - \frac{w_0 L^3}{24} + C_1 \quad (6)$$

Solving Eqs. (5) and (6) yield :

$$B_y = \frac{1}{10} w_0 L \quad \text{Ans}$$

$$C_1 = -\frac{w_0 L^2}{120}$$

Substitute B_y into Eqs. (1) and (2) :

$$A_y = \frac{2}{5} w_0 L \quad \text{Ans}$$

$$M_A = \frac{1}{15} w_0 L^2 \quad \text{Ans}$$

$$M(x) = B_y x - \frac{w_0 x^3}{6L}$$

From *Mechanics of Materials*, Sixth Edition by R. C. Hibbeler, ISBN 0-13-191345-X.
 © 2005 R. C. Hibbeler. Published by Pearson Prentice Hall,
 Pearson Education, Inc., Upper Saddle River, NJ. All rights reserved.
 This material is protected under all copyright laws as they currently exist. No portion of this material may be reproduced, in any form or by any means, without permission in writing from the publisher.

***12-108.** Use discontinuity functions and determine the reactions at the supports, then draw the shear and moment diagrams. EI is constant.

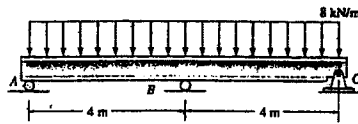

$$\begin{aligned} \rightarrow \Sigma F_x = 0; & \quad C_x = 0 \quad \text{Ans} \\ + \uparrow \Sigma F_y = 0; & \quad A_y + B_y + C_y - 2wL = 0 \quad (1) \\ \curvearrowright \Sigma M_C = 0; & \quad A_y(2L) + B_y(L) - 2wL(L) = 0; \quad B_y = 2wL - 2A_y \end{aligned}$$

Bending moment $M(x)$:

$$\begin{aligned} M(x) &= -(-A_y) \langle x-0 \rangle - \frac{w}{2} \langle x-0 \rangle^2 - (-B_y) \langle x-L \rangle \\ &= A_y x - \frac{w}{2} x^2 + B_y \langle x-L \rangle \end{aligned}$$

Elastic curve and slope:

$$EI \frac{d^2 v}{dx^2} = M(x)$$

$$EI \frac{d^2 v}{dx^2} = A_y x - \frac{w}{2} x^2 + B_y \langle x-L \rangle$$

$$EI \frac{dv}{dx} = \frac{A_y x^2}{2} - \frac{wx^3}{6} + \frac{B_y}{2} \langle x-L \rangle^2 + C_1 \quad (3)$$

$$EIv = \frac{A_y x^3}{6} - \frac{wx^4}{24} + \frac{B_y}{6} \langle x-L \rangle^3 + C_1 x + C_2 \quad (4)$$

Boundary Conditions:

$$v = 0 \quad \text{at} \quad x = 0$$

From Eq. (4)

$$C_2 = 0$$

$$v = 0 \quad \text{at} \quad x = L$$

From Eq. (4)

$$0 = \frac{A_y L^3}{6} - \frac{wL^4}{24} + C_1 L \quad (5)$$

$$\frac{dv}{dx} = 0 \quad \text{at} \quad x = L$$

From Eq. (3)

$$0 = \frac{A_y L^2}{2} - \frac{wL^3}{6} + C_1 \quad (6)$$

Solving for Eqs. (5) and (6) yield:

$$C_1 = -\frac{wL^2}{48}$$

$$A_y = \frac{3}{8} wL = \frac{3}{8} (8)(4) = 12.0 \text{ kN} \quad \text{Ans}$$

Substitute A_y into Eqs. (1) and (2)

$$B_y = \frac{5}{4} wL = \frac{5}{4} (8)(4) = 40.0 \text{ kN} \quad \text{Ans}$$

$$C_y = \frac{3}{8} wL = \frac{3}{8} (8)(4) = 12.0 \text{ kN} \quad \text{Ans}$$

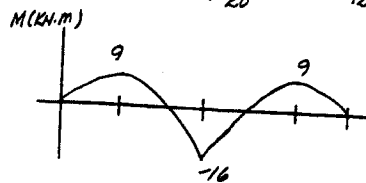
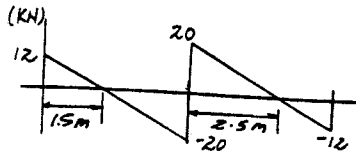
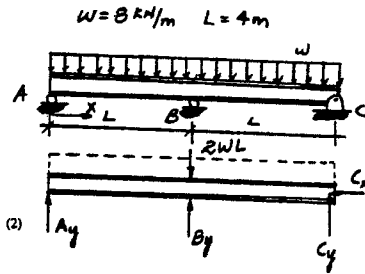

From *Mechanics of Materials*, Sixth Edition by R. C. Hibbeler, ISBN 0-13-191345-X.

© 2005 R. C. Hibbeler. Published by Pearson Prentice Hall,

Pearson Education, Inc., Upper Saddle River, NJ. All rights reserved.

This material is protected under all copyright laws as they currently exist. No portion of this material may be reproduced, in any form or by any means, without permission in writing from the publisher.

12-109. Use discontinuity functions and determine the reactions at the supports, then draw the shear and moment diagrams. EI is constant.

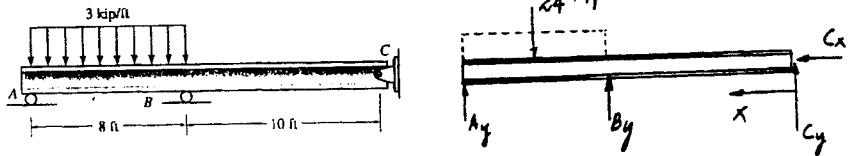

$$\begin{aligned} \rightarrow \Sigma F_x = 0 \quad C_x = 0 \quad \text{Ans} \\ + \uparrow \Sigma F_y = 0 \quad A_y + B_y + C_y - 24 = 0 \quad (1) \\ \curvearrowleft + \Sigma M_A = 0 \quad 18 C_y + 8 B_y - 24(4) = 0 \quad (2) \end{aligned}$$

Bending Moment $M(x)$:

$$\begin{aligned} M(x) &= -(-C_y) \langle x-0 \rangle - (-B_y) \langle x-10 \rangle - \frac{3}{2} \langle x-10 \rangle^2 \\ &= C_y x + B_y \langle x-10 \rangle - \frac{3}{2} \langle x-10 \rangle^2 \end{aligned}$$

Elastic curve and slope:

$$EI \frac{d^2 v}{dx^2} = M(x) = C_y x + B_y \langle x-10 \rangle - \frac{3}{2} \langle x-10 \rangle^2$$

$$EI \frac{dv}{dx} = \frac{C_y x^2}{2} + \frac{B_y}{2} \langle x-10 \rangle^2 - \frac{1}{2} \langle x-10 \rangle^3 + C_1 \quad (3)$$

$$EI v = \frac{C_y x^3}{6} + \frac{B_y}{6} \langle x-10 \rangle^3 - \frac{1}{8} \langle x-10 \rangle^4 + C_1 x + C_2 \quad (4)$$

Boundary conditions:

$$v = 0 \quad \text{at} \quad x = 0$$

From Eq. (4)

$$C_2 = 0$$

$$v = 0 \quad \text{at} \quad x = 10 \text{ ft.}$$

From Eq. (4)

$$0 = 166.67 C_y + 10 C_1 \quad (5)$$

$$v = 0 \quad \text{at} \quad x = 18 \text{ ft.}$$

$$0 = 972 C_y + 85.33 B_y - 512 + 18 C_1$$

Solving Eqs. (2), (5), and (6) yields:

$$B_y = 14.4 \text{ kip} \quad \text{Ans}$$

$$C_y = -1.07 \text{ kip} = 1.07 \text{ kip} \downarrow \quad \text{Ans}$$

$$C_1 = 17.78$$

From Eq. (1):

$$A_y = 10.7 \text{ kip} \quad \text{Ans}$$

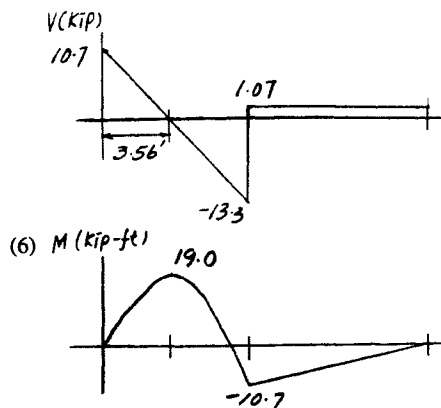

From *Mechanics of Materials*, Sixth Edition by R. C. Hibbeler, ISBN 0-13-191345-X.

© 2005 R. C. Hibbeler. Published by Pearson Prentice Hall,

Pearson Education, Inc., Upper Saddle River, NJ. All rights reserved.

This material is protected under all copyright laws as they currently exist. No portion of this material may be reproduced, in any form or by any means, without permission in writing from the publisher.

12-110. The beam has a constant $E_1 I_1$ and is supported by the fixed wall at B and the rod AC . If the rod has a cross-sectional area A_2 and the material has a modulus of elasticity E_2 , determine the force in the rod.

$$\begin{aligned}
 + \uparrow \Sigma F_y = 0 \quad T_{AC} + B_y - wL_1 &= 0 \\
 (\curvearrowright) \Sigma M_B = 0 \quad T_{AC}(L_1) + M_B - \frac{wL_1^2}{2} &= 0 \\
 M_B = \frac{wL_1^2}{2} - T_{AC}L_1 &\quad (2)
 \end{aligned}$$

Bending Moment $M(x)$:

$$M(x) = T_{AC}x - \frac{wx^2}{2}$$

Elastic curve and slope :

$$EI \frac{d^2 v}{dx^2} = M(x) = T_{AC}x - \frac{wx^2}{2}$$

$$EI \frac{dv}{dx} = \frac{T_{AC}x^2}{2} - \frac{wx^3}{6} + C_1 \quad (3)$$

$$EIv = \frac{T_{AC}x^3}{6} - \frac{wx^4}{24} + C_1x + C_2 \quad (4)$$

Boundary conditions :

$$v = -\frac{T_{AC}L_2}{A_2 E_2} \quad x = 0$$

From Eq. (4)

$$-E_1 I_1 \left(\frac{T_{AC}L_2}{A_2 E_2} \right) = 0 - 0 + 0 + C_2$$

$$C_2 = \left(\frac{-E_1 I_1 L_2}{A_2 E_2} \right) T_{AC}$$

$$v = 0 \quad \text{at} \quad x = L_1$$

From Eq. (4)

$$0 = \frac{T_{AC}L_1^3}{6} - \frac{wL_1^4}{24} + C_1 L_1 - \frac{E_1 I_1 L_2}{A_2 E_2} T_{AC} \quad (5)$$

$$\frac{dv}{dx} = 0 \quad \text{at} \quad x = L_1$$

From Eq. (3)

$$0 = \frac{T_{AC}L_1^2}{2} - \frac{wL_1^3}{6} + C_1 \quad (6)$$

Solving Eqs. (5) and (6) yields :

$$T_{AC} = \frac{3A_2 E_2 w L_1^4}{8(A_2 E_2 L_1^3 + 3E_1 I_1 L_2)} \quad \text{Ans}$$

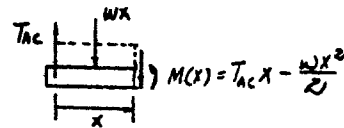
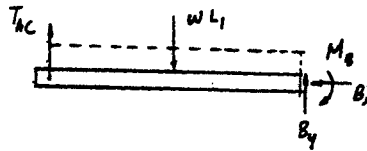
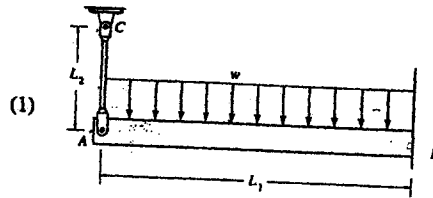

F1

From

From

From *Mechanics of Materials*, Sixth Edition by R. C. Hibbeler, ISBN 0-13-191345-X.

© 2005 R. C. Hibbeler. Published by Pearson Prentice Hall,

Pearson Education, Inc., Upper Saddle River, NJ. All rights reserved.

This material is protected under all copyright laws as they currently exist. No portion of this material may be reproduced, in any form or by any means, without permission in writing from the publisher.

12-111. Determine the moment reactions at the supports A and B , and then draw the shear and moment diagrams. Solve by expressing the internal moment in the beam in terms of A_y and M_A . EI is constant.

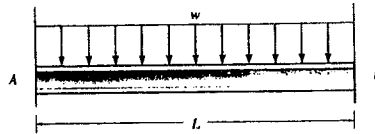

$$M(x) = A_y x - M_A - \frac{wx^2}{2}$$

Elastic curve and slope :

$$EI \frac{d^2 v}{dx^2} = M(x) = A_y x - M_A - \frac{wx^2}{2}$$

$$EI \frac{dv}{dx} = \frac{A_y x^2}{2} - M_A x - \frac{wx^3}{6} + C_1 \quad (1)$$

$$EI v = \frac{A_y x^3}{6} - \frac{M_A x^2}{2} - \frac{wx^4}{24} + C_1 x + C_2 \quad (2)$$

Boundary conditions :

$$\frac{dv}{dx} = 0 \quad \text{at} \quad x = 0$$

From Eq. (1)

$$C_1 = 0$$

$$v = 0 \quad \text{at} \quad x = 0$$

From Eq. (2)

$$C_2 = 0$$

$$\frac{dv}{dx} = 0 \quad \text{at} \quad x = L$$

From Eq. (1)

$$0 = \frac{A_y L^2}{2} - M_A L - \frac{wL^3}{6} \quad (3)$$

$$v = 0 \quad \text{at} \quad x = L$$

From Eq. (2)

$$0 = \frac{A_y L^3}{6} - \frac{M_A L^2}{2} - \frac{wL^4}{24} \quad (4)$$

Solving Eqs. (3) and (4) yields :

$$A_y = \frac{wL}{2}$$

$$M_A = \frac{wL^2}{12} \quad \text{Ans}$$

Due to symmetry :

$$M_B = \frac{wL^2}{12} \quad \text{Ans}$$

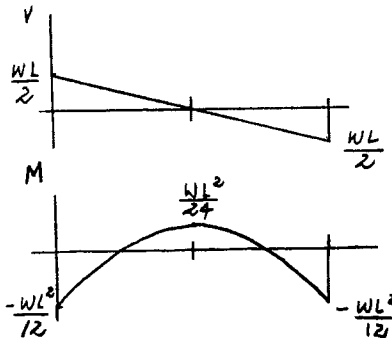
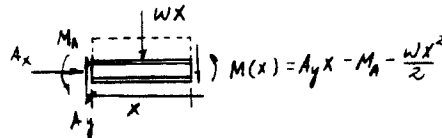

From *Mechanics of Materials*, Sixth Edition by R. C. Hibbeler, ISBN 0-13-191345-X.

© 2005 R. C. Hibbeler. Published by Pearson Prentice Hall,

Pearson Education, Inc., Upper Saddle River, NJ. All rights reserved.

This material is protected under all copyright laws as they currently exist. No portion of this material may be reproduced, in any form or by any means, without permission in writing from the publisher.

*12-112. Determine the moment reactions at the supports A and B . EI is constant.

Support Reactions : FBD(a).

$$\rightarrow \Sigma F_x = 0; \quad A_x = 0 \quad \text{Ans} \quad [1]$$

$$+\uparrow \Sigma F_y = 0; \quad A_y + B_y - \frac{w_0 L}{2} = 0 \quad [2]$$

$$\curvearrowright \Sigma M_A = 0; \quad B_y L + M_A - \frac{w_0 L}{2} \left(\frac{L}{3} \right) = 0$$

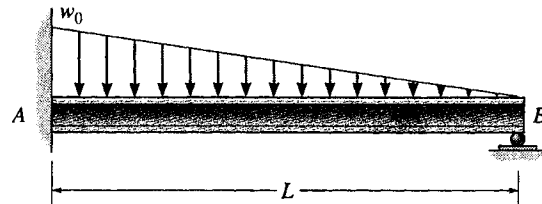

Moment Function : FBD(b).

$$\curvearrowright \Sigma M_{NA} = 0; \quad -M(x) - \frac{1}{2} \left(\frac{w_0}{L} x \right) x \left(\frac{x}{3} \right) + B_y x = 0$$

$$M(x) = B_y x - \frac{w_0 x^3}{6L}$$

Slope and Elastic Curve :

$$EI \frac{d^2 v}{dx^2} = M(x)$$

$$EI \frac{d^2 v}{dx^2} = B_y x - \frac{w_0 x^3}{6L} \quad [3]$$

$$EI \frac{dv}{dx} = \frac{B_y}{2} x^2 - \frac{w_0}{24L} x^4 + C_1$$

$$EI v = \frac{B_y}{6} x^3 - \frac{w_0}{120L} x^5 + C_1 x + C_2 \quad [4]$$

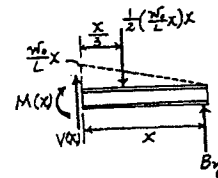
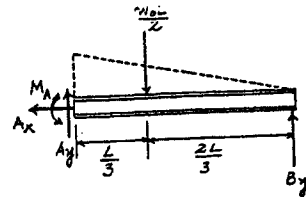

Boundary Conditions :

At $x = 0, v = 0$. From Eq. [4]. $C_2 = 0$

At $x = L, \frac{dv}{dx} = 0$. From Eq. [3],

$$0 = \frac{B_y L^2}{2} - \frac{w_0 L^3}{24} + C_1$$

$$C_1 = -\frac{B_y L^2}{2} + \frac{w_0 L^3}{24}$$

At $x = L, v = 0$. From Eq. [4],

$$0 = \frac{B_y L^3}{6} - \frac{w_0 L^4}{120} + \left(-\frac{B_y L^2}{2} + \frac{w_0 L^3}{24} \right) L$$

$$B_y = \frac{w_0 L}{10} \quad \text{Ans}$$

Substituting B_y into Eq. [1] and [2] yields,

$$A_y = \frac{2w_0 L}{5} \quad M_A = \frac{w_0 L^2}{15} \quad \text{Ans}$$

From *Mechanics of Materials*, Sixth Edition by R. C. Hibbeler, ISBN 0-13-191345-X.

© 2005 R. C. Hibbeler. Published by Pearson Prentice Hall,

Pearson Education, Inc., Upper Saddle River, NJ. All rights reserved.

This material is protected under all copyright laws as they currently exist. No portion of this material may be reproduced, in any form or by any means, without permission in writing from the publisher.

12-113. Determine the moment reactions at the supports A and B . EI is constant.

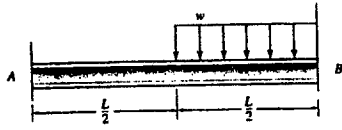

$$\theta_{B/A} = 0 = \frac{1}{2} \left(\frac{A_y L}{EI} \right) (L) + \left(\frac{-M_A}{EI} \right) (L) + \frac{1}{3} \left(\frac{-wL^2}{8EI} \right) \left(\frac{L}{2} \right)$$

$$0 = \frac{A_y L}{2} - M_A - \frac{wL^2}{48} \quad (2)$$

$$t_{B/A} = 0 = \frac{1}{2} \left(\frac{A_y L}{EI} \right) (L) \left(\frac{L}{3} \right) + \left(\frac{-M_A}{EI} \right) (L) \left(\frac{L}{2} \right) + \frac{1}{3} \left(\frac{-wL^2}{8EI} \right) \left(\frac{L}{2} \right) \left(\frac{L}{8} \right)$$

$$0 = \frac{A_y L}{6} - \frac{M_A}{2} - \frac{wL^2}{384} \quad (3)$$

Solving Eqs. (2) and (3) yields :

$$A_y = \frac{3wL}{32}$$

$$M_A = \frac{5wL^2}{192} \quad \text{Ans}$$

$$\zeta + \Sigma M_B = 0; \quad M_B + \frac{3wL}{32} (L) - \frac{5wL^2}{192} - \frac{wL}{2} \left(\frac{L}{4} \right) = 0$$

$$M_B = \frac{11wL^2}{192} \quad \text{Ans}$$

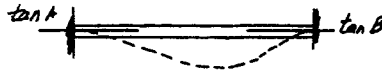

$$t_{B/A} = 0 \quad \theta_{B/A} = 0$$

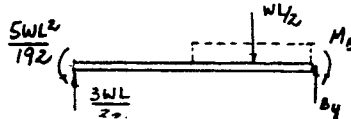
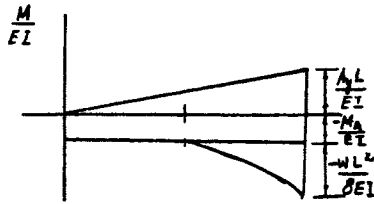
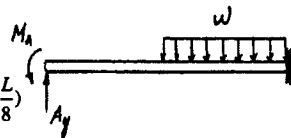

From *Mechanics of Materials*, Sixth Edition by R. C. Hibbeler, ISBN 0-13-191345-X.

© 2005 R. C. Hibbeler. Published by Pearson Prentice Hall,

Pearson Education, Inc., Upper Saddle River, NJ. All rights reserved.

This material is protected under all copyright laws as they currently exist. No portion of this material may be reproduced, in any form or by any means, without permission in writing from the publisher.

12-114. Determine the moment reactions at the supports A and B , then draw the shear and moment diagrams. EI is constant.

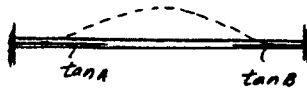
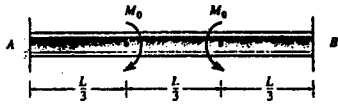

$$\theta_{B/A} = 0 = \left(\frac{M_0}{EI}\right)\left(\frac{L}{3}\right) + \frac{1}{2}\left(\frac{A_y L}{EI}\right)(L) + \left(\frac{-M_A}{EI}\right)(L)$$

$$t_{B/A} = 0 \quad \theta_{B/A} = 0$$

$$0 = \frac{M_0}{3} + \frac{1}{2}A_y L - M_A \quad (1)$$



$$t_{B/A} = 0 = \left(\frac{M_0}{EI}\right)\left(\frac{L}{3}\right)\left(\frac{L}{3} + \frac{L}{6}\right) + \frac{1}{2}\left(\frac{A_y L}{EI}\right)(L)\left(\frac{L}{3}\right) + \left(\frac{-M_A}{EI}\right)(L)\left(\frac{L}{2}\right)$$

$$0 = \frac{M_0}{6} + \frac{A_y L}{6} - \frac{M_A}{2} \quad (2)$$

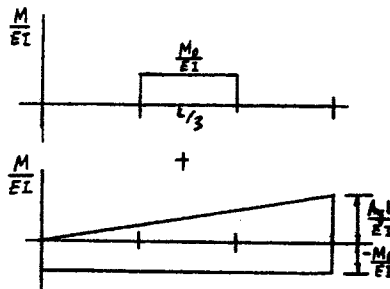

Solving Eqs. (1) and (2) yields :

$$A_y = 0$$

$$M_A = \frac{M_0}{3} \quad \text{Ans}$$

Due to symmetry :

$$B_y = 0$$

$$M_B = \frac{M_0}{3} \quad \text{Ans}$$

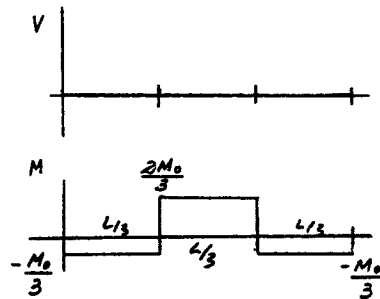

From *Mechanics of Materials*, Sixth Edition by R. C. Hibbeler, ISBN 0-13-191345-X.
 © 2005 R. C. Hibbeler. Published by Pearson Prentice Hall,
 Pearson Education, Inc., Upper Saddle River, NJ. All rights reserved.
 This material is protected under all copyright laws as they currently exist. No portion of this material may be reproduced, in any form or by any means, without permission in writing from the publisher.

12-115 Determine the reactions at the supports, and then draw the shear and moment diagrams. EI is constant.

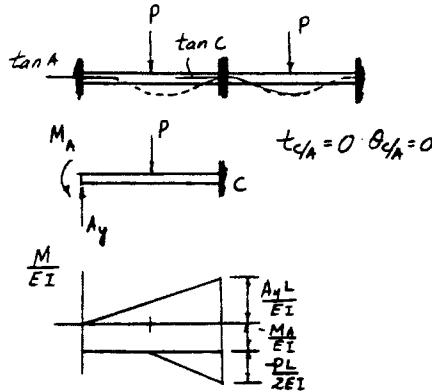
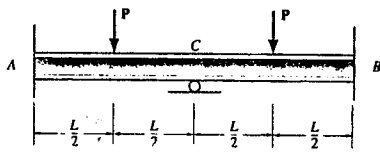

$$\theta_{C/A} = 0 = \frac{1}{2} \left(\frac{A_y L}{EI} \right) (L) + \left(\frac{-M_A}{EI} \right) (L) + \frac{1}{2} \left(\frac{-PL}{2EI} \right) \left(\frac{L}{2} \right)$$

$$0 = \frac{1}{2} A_y L - M_A - \frac{PL}{8} \quad (1)$$

$$t_{C/A} = 0 = \frac{1}{2} \left(\frac{A_y L}{EI} \right) (L) \left(\frac{L}{3} \right) + \left(\frac{-M_A}{EI} \right) (L) \left(\frac{L}{2} \right) + \frac{1}{2} \left(\frac{-PL}{2EI} \right) \left(\frac{L}{2} \right) \left(\frac{L}{6} \right)$$

$$0 = \frac{A_y L}{6} - \frac{M_A}{2} - \frac{PL}{48} \quad (2)$$

Solving Eqs. (1) and (2) yields :

$$A_y = \frac{P}{2} \quad \text{Ans}$$

$$M_A = \frac{PL}{8} \quad \text{Ans}$$

Due to symmetry :

$$B_y = \frac{P}{2} \quad \text{Ans}$$

$$M_B = \frac{PL}{8} \quad \text{Ans}$$

$$C_y = P \quad \text{Ans}$$

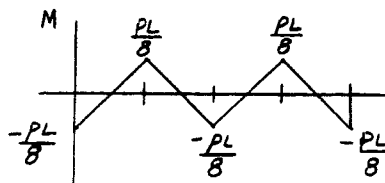
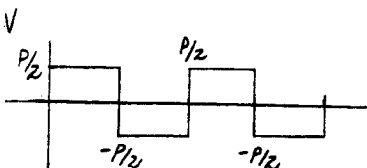
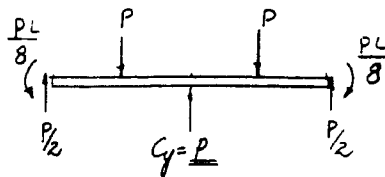

From *Mechanics of Materials*, Sixth Edition by R. C. Hibbeler, ISBN 0-13-191345-X.

© 2005 R. C. Hibbeler. Published by Pearson Prentice Hall,

Pearson Education, Inc., Upper Saddle River, NJ. All rights reserved.

This material is protected under all copyright laws as they currently exist. No portion of this material may be reproduced, in any form or by any means, without permission in writing from the publisher.

*12-116 Determine the reactions at the supports, then draw the shear and moment diagrams. EI is constant.

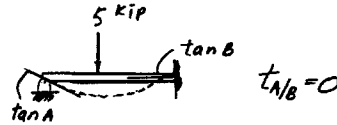
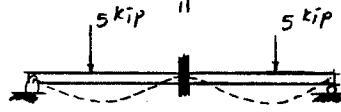
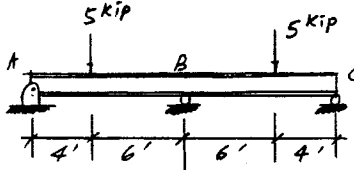
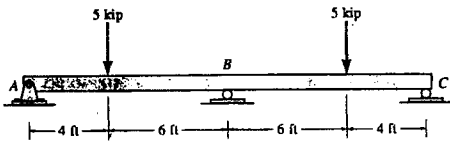

$$(t_{A/B})_1 = \frac{1}{2} \left(\frac{-30}{EI} \right) (6)(4+4) = \frac{-720}{EI}$$

$$(t_{A/B})_2 = \frac{1}{2} \left(\frac{10A_y}{EI} \right) (10) \left(\frac{20}{3} \right) = \frac{333.33 A_y}{EI}$$

$$t_{A/B} = 0 = (t_{A/B})_1 + (t_{A/B})_2$$

$$0 = \frac{-720}{EI} + \frac{333.33 A_y}{EI}$$

$$A_y = 2.16 \text{ kip} \quad \text{Ans}$$

Due to symmetry :

$$C_y = 2.16 \text{ kip} \quad \text{Ans}$$

$$B_y = 5.68 \text{ kip} \quad \text{Ans}$$

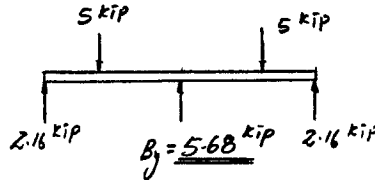
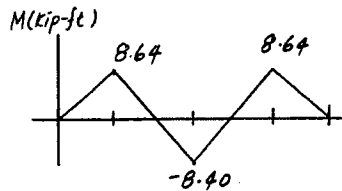
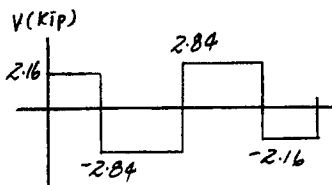
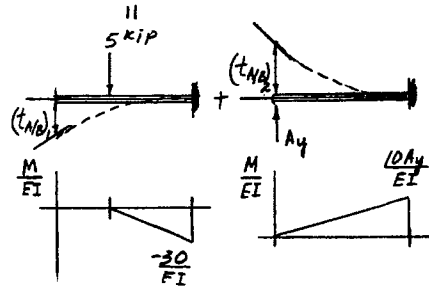

From *Mechanics of Materials*, Sixth Edition by R. C. Hibbeler, ISBN 0-13-191345-X.

© 2005 R. C. Hibbeler. Published by Pearson Prentice Hall,

Pearson Education, Inc., Upper Saddle River, NJ. All rights reserved.

This material is protected under all copyright laws as they currently exist. No portion of this material may be reproduced, in any form or by any means, without permission in writing from the publisher.

12-117 Determine the reactions at the supports, then draw the shear and moment diagrams. EI is constant.

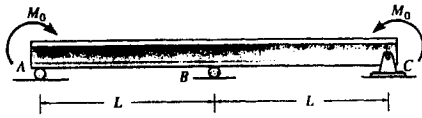

Require :

$$t_{A/B} = 0 = \left(\frac{M_0}{EI}\right)(L)\left(\frac{L}{2}\right) + \frac{1}{2}\left(\frac{-A_y L}{EI}\right)(L)\left(\frac{2L}{3}\right)$$

$$0 = \frac{M_0 L^2}{2EI} - \frac{A_y L^3}{3EI}; \quad A_y = \frac{3M_0}{2L} \quad \text{Ans}$$

Equilibrium :

$$+\circlearrowleft \Sigma M_B = 0; \quad \frac{3M_0}{2L}(L) - C_y(L) = 0$$

$$C_y = \frac{3M_0}{2L} \quad \text{Ans}$$

$$+\uparrow \Sigma F_y = 0; \quad B_y - \frac{3M_0}{2L} - \frac{3M_0}{2L} = 0$$

$$B_y = \frac{3M_0}{L} \quad \text{Ans}$$

$$+\rightarrow \Sigma F_x = 0; \quad C_x = 0 \quad \text{Ans}$$

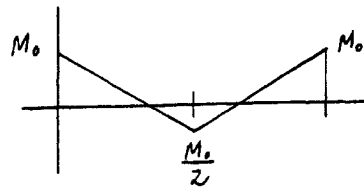
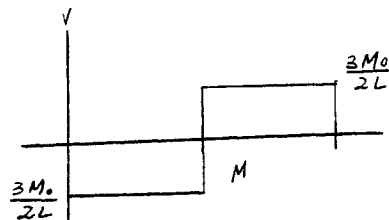
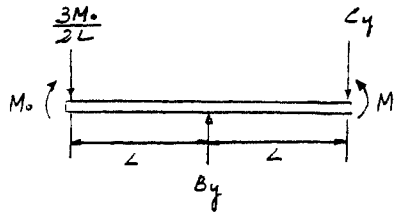
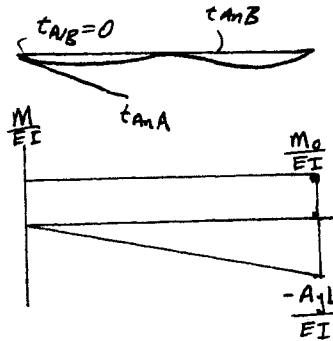

From *Mechanics of Materials*, Sixth Edition by R. C. Hibbeler, ISBN 0-13-191345-X.

© 2005 R. C. Hibbeler. Published by Pearson Prentice Hall,

Pearson Education, Inc., Upper Saddle River, NJ. All rights reserved.

This material is protected under all copyright laws as they currently exist. No portion of this material may be reproduced, in any form or by any means, without permission in writing from the publisher.

12-118 Determine the reactions at the supports A and B , then draw the shear and moment diagrams. EI is constant.

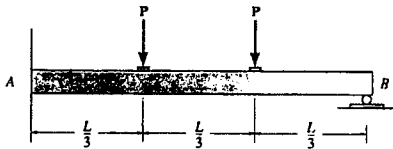

$$(t_{B/A})_1 = \frac{1}{2} \left(\frac{-PL}{3EI} \right) \left(\frac{L}{3} \right) \left(\frac{2L}{3} + \frac{2L}{9} \right) + \frac{1}{2} \left(\frac{-2PL}{3EI} \right) \left(\frac{2L}{3} \right) \left(\frac{L}{3} + \frac{4L}{9} \right) = -\frac{2PL^3}{9EI}$$

$$(t_{B/A})_2 = \frac{1}{2} \left(\frac{B_y L}{EI} \right) \left(L \right) \left(\frac{2L}{3} \right) = \frac{B_y L^3}{3EI}$$

$$t_{B/A} = 0 = (t_{B/A})_1 + (t_{B/A})_2$$

$$0 = -\frac{2PL^3}{9EI} + \frac{B_y L^3}{3EI}$$

$$B_y = \frac{2}{3}P \quad \text{Ans}$$

From the free-body diagram,

$$M_A = \frac{PL}{3} \quad \text{Ans}$$

$$A_y = \frac{4}{3}P \quad \text{Ans}$$

$$A_x = 0 \quad \text{Ans}$$

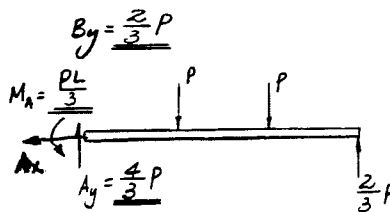
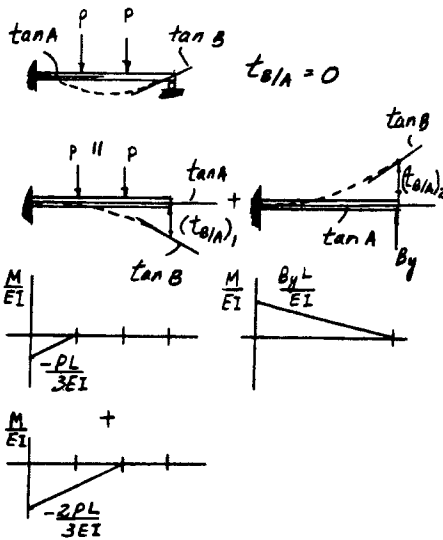
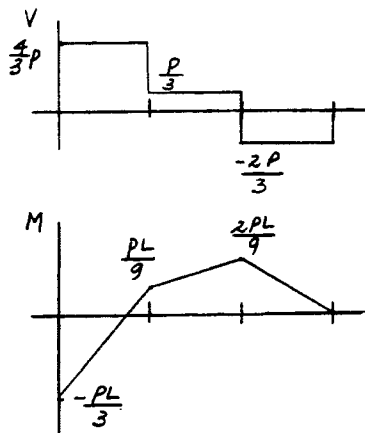

From *Mechanics of Materials*, Sixth Edition by R. C. Hibbeler, ISBN 0-13-191345-X.
 © 2005 R. C. Hibbeler. Published by Pearson Prentice Hall,
 Pearson Education, Inc., Upper Saddle River, NJ. All rights reserved.
 This material is protected under all copyright laws as they currently exist. No portion of this material may be reproduced, in any form or by any means, without permission in writing from the publisher.

12-119. Determine the value of a for which the maximum positive moment has the same magnitude as the maximum negative moment. EI is constant.

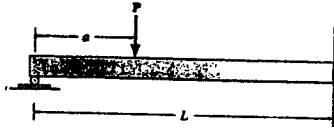

$$(t_{NB})_1 = \frac{1}{2} \left(\frac{-P(L-a)}{EI} \right) (L-a) \left(a + \frac{2(L-a)}{3} \right) = \frac{-P(L-a)^2(2L+a)}{6EI}$$

$$(t_{NB})_2 = \frac{1}{2} \left(\frac{A_y L}{EI} \right) (L) \left(\frac{2L}{3} \right) = \frac{A_y L^3}{3EI}$$

$$t_{NB} = 0 = (t_{NB})_1 + (t_{NB})_2$$

$$0 = \frac{-P(L-a)^2(2L+a)}{6EI} + \frac{A_y L^3}{3EI}$$

$$A_y = \frac{P(L-a)^2(2L+a)}{2L^3}$$

Require:

$$|M_1| = |M_2|$$

$$\frac{Pa(L-a)^2(2L+a)}{2L^3} = \frac{Pa(L-a)(L+a)}{2L^2}$$

$$a^2 + 2La - L^2 = 0$$

$$a = 0.414L \quad \text{Ans}$$

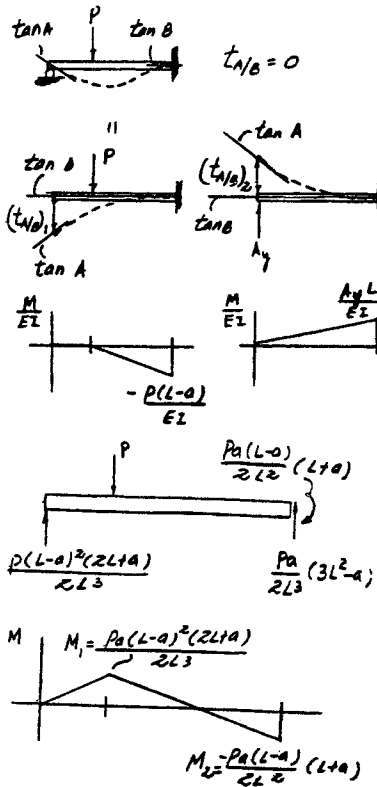

From *Mechanics of Materials*, Sixth Edition by R. C. Hibbeler, ISBN 0-13-191345-X.
 © 2005 R. C. Hibbeler. Published by Pearson Prentice Hall,
 Pearson Education, Inc., Upper Saddle River, NJ. All rights reserved.
 This material is protected under all copyright laws as they currently exist. No portion of this material may be reproduced, in any form or by any means, without permission in writing from the publisher.

***12-120.** Determine the moment reactions at the supports *A* and *B*. *EI* is constant.

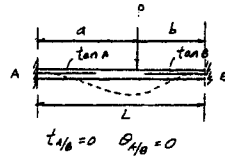
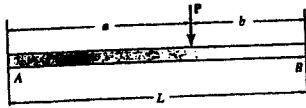

Require :

$$\theta_{NB} = 0 = \frac{1}{2} \left(\frac{A_y L}{EI} \right) L + \frac{1}{2} \left(-\frac{Pb}{EI} \right) (b) + \left(-\frac{M_A}{EI} \right) (L)$$

$$A_y L^2 - Pb^2 - 2M_A L = 0 \quad (1)$$

$$t_{NB} = 0 = \frac{1}{2} \left(\frac{A_y L}{EI} \right) (L) \left(\frac{2L}{3} \right) + \frac{1}{2} \left(-\frac{Pb}{EI} \right) (b) \left(L - \frac{b}{3} \right) + \left(-\frac{M_A}{EI} \right) (L) \left(\frac{L}{2} \right)$$

$$2A_y L^3 - 3Pb^2 L + Pb^3 - 3M_A L^2 = 0 \quad (2)$$

Solving Eqs. (1) and (2) yields :

$$M_A = \frac{Pb^2(L-b)}{L^2}; \quad L-b = a$$

$$M_A = \frac{Pa b^2}{L^2} \quad \text{Ans}$$

$$A_y = \frac{Pb^2}{L^3} (L + 2a)$$

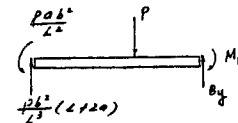
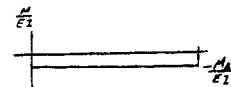
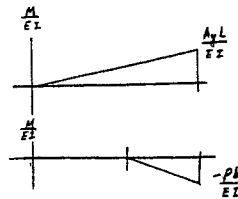
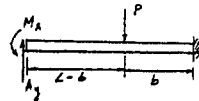

Equilibrium :

$$+\Sigma M_B = 0; \quad \frac{Pa b^2}{L^2} - \left[\frac{Pb^2}{L^3} (L + 2a) \right] L + Pb - M_B = 0$$

$$\begin{aligned} M_B &= \frac{PbL^2 - Pb^2L - Pa b^2}{L^2} \\ &= \frac{Pb(a+b)^2 - Pb^2(a+b) - Pa b^2}{L^2} \\ &= \frac{Pa^2 b}{L^2} \quad \text{Ans} \end{aligned}$$

From *Mechanics of Materials*, Sixth Edition by R. C. Hibbeler, ISBN 0-13-191345-X.

© 2005 R. C. Hibbeler. Published by Pearson Prentice Hall,

Pearson Education, Inc., Upper Saddle River, NJ. All rights reserved.

This material is protected under all copyright laws as they currently exist. No portion of this material may be reproduced, in any form or by any means, without permission in writing from the publisher.

12-121. The assembly consists of a steel and an aluminum bar, each of which is 1 in. thick, fixed at its ends *A* and *B*, and pin connected to the *rigid* short link *CD*. If a horizontal force of 80 lb is applied to the link as shown, determine the moments created at *A* and *B*. $E_{st} = 29(10^3)$ ksi, $E_{al} = 10(10^3)$ ksi.

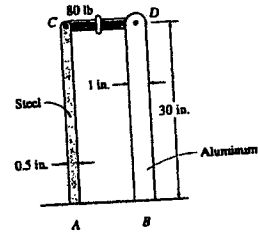

$$\leftarrow \Sigma F_x = 0 \quad P_{al} + P_{st} - 80 = 0 \quad (1)$$

Compatibility condition :

$$\Delta_{st} = \Delta_{al}$$

$$\frac{P_{st} L^3}{3E_{st} I_{st}} = \frac{P_{al} L^3}{3E_{al} I_{al}}$$

$$P_{st} = \left(\frac{E_{st} I_{st}}{E_{al} I_{al}} \right) (P_{al}) = \frac{(29)(10^3) \left(\frac{1}{12} \right) (1) (0.5^3)}{(10)(10^3) \left(\frac{1}{12} \right) (1) (1^3)} P_{al}$$

$$P_{st} = 0.3625 P_{al} \quad (2)$$

Solving Eqs. (1) and (2) yields :

$$P_{al} = 58.72 \text{ lb} \quad P_{st} = 21.28 \text{ lb}$$

$$M_A = P_{st} (30) = 639 \text{ lb} \cdot \text{in.} = 0.639 \text{ kip} \cdot \text{in.} \quad \text{Ans}$$

$$M_B = P_{al} (30) = 1761 \text{ lb} \cdot \text{in.} = 1.76 \text{ kip} \cdot \text{in.} \quad \text{Ans}$$

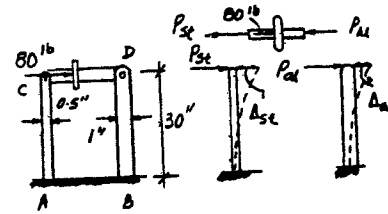

From *Mechanics of Materials*, Sixth Edition by R. C. Hibbeler, ISBN 0-13-191345-X.

© 2005 R. C. Hibbeler. Published by Pearson Prentice Hall,

Pearson Education, Inc., Upper Saddle River, NJ. All rights reserved.

This material is protected under all copyright laws as they currently exist. No portion of this material may be reproduced, in any form or by any means, without permission in writing from the publisher.

12-122 Determine the reactions at the supports, then draw the shear and moment diagrams. EI is constant. The bearings exert only vertical reactions on the shaft.

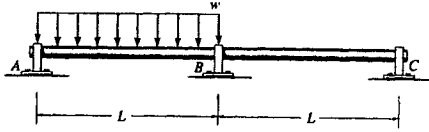

$$\Delta = \frac{5w(2L)^4}{768EI} = \frac{5wL^4}{48EI} \downarrow$$

$$\Delta' = \frac{B_y(2L)^3}{48EI} = \frac{B_y L^3}{6EI} \uparrow$$

Require :

$$(+\downarrow) \quad 0 = \Delta - \Delta'$$

$$0 = \frac{5wL^4}{48EI} - \frac{B_y L^3}{6EI}$$

$$B_y = \frac{5}{8}wL \uparrow \quad \text{Ans}$$

$$(+\Sigma M_A = 0; \quad wL\left(\frac{L}{2}\right) - \frac{5}{8}wL(L) - C_y(2L) = 0$$

$$C_y = -\frac{wL}{16} = \frac{wL}{16} \downarrow \quad \text{Ans}$$

$$+\uparrow \Sigma F_y = 0; \quad -wL - \frac{wL}{16} + \frac{5}{8}wL + A_y = 0$$

$$A_y = \frac{7}{16}wL \quad \text{Ans}$$

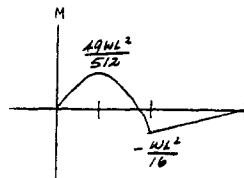
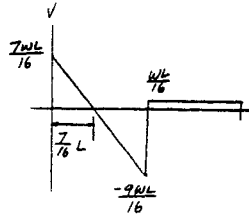
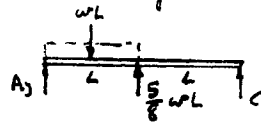
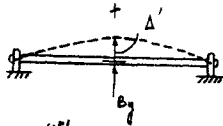
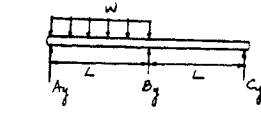

From *Mechanics of Materials*, Sixth Edition by R. C. Hibbeler, ISBN 0-13-191345-X.

© 2005 R. C. Hibbeler. Published by Pearson Prentice Hall,

Pearson Education, Inc., Upper Saddle River, NJ. All rights reserved.

This material is protected under all copyright laws as they currently exist. No portion of this material may be reproduced, in any form or by any means, without permission in writing from the publisher.

12-123. The A-36 steel beam and rod are used to support the load of 8 kip. If it is required that the allowable normal stress for the steel is $\sigma_{\text{allow}} = 18$ ksi, and the maximum deflection not exceed 0.05 in., determine the smallest diameter rod that should be used. The beam is rectangular, having a height of 5 in. and a thickness of 3 in.

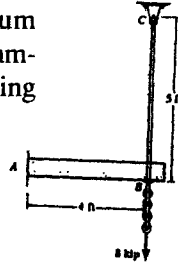

$$\delta_r = \delta_b$$

$$\frac{F(5)(12)}{AE} = \frac{(8-F)(48)^3}{3E(\frac{1}{12})(3)(5)^3}$$

Assume rod reaches its maximum stress.

$$\sigma = \frac{F}{A} = 18(10^3)$$

$$\frac{18(5)(12)}{E} = \frac{1179.648(8-F)}{E}$$

$$F = 7.084 \text{ kip}$$

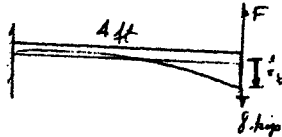

Maximum stress in beam,

$$\sigma = \frac{Mc}{I} = \frac{(8-7.084)(48)(2.5)}{\frac{1}{12}(3)(5)^3} = 3.52 \text{ ksi} < 18 \text{ ksi} \quad \text{OK}$$

Maximum deflection

$$\delta = \frac{PL^3}{3EI} = \frac{(8-7.084)(48)^3}{3(29)(10^3)(\frac{1}{12})(3)(5)^3} = 0.0372 \text{ in.} < 0.05 \text{ in.} \quad \text{OK}$$

Thus,

$$A = \frac{7.084}{18} = 0.39356 \text{ in}^2 = \frac{1}{4}\pi d^2$$

$$d = 0.708 \text{ in.} \quad \text{Ans}$$

From *Mechanics of Materials*, Sixth Edition by R. C. Hibbeler, ISBN 0-13-191345-X.

© 2005 R. C. Hibbeler. Published by Pearson Prentice Hall,

Pearson Education, Inc., Upper Saddle River, NJ. All rights reserved.

This material is protected under all copyright laws as they currently exist. No portion of this material may be reproduced, in any form or by any means, without permission in writing from the publisher.

***12-124.** The beam has a constant $E_1 I_1$ and is supported by the fixed wall at B and the rod AC . If the rod has a cross-sectional area A_2 and the material has a modulus of elasticity E_2 , determine the force in the rod.

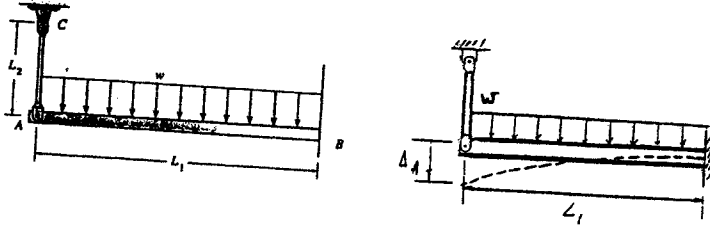

$$(\Delta_A)' = \frac{wL_1^4}{8E_1 I_1}; \quad \Delta_A = \frac{T_{AC} L_2}{A_2 E_2}$$

$$\delta_A = \frac{T_{AC} L_1^3}{3E_1 I_1}$$

By superposition :

$$(+\downarrow) \quad \Delta_A = (\Delta_A)' - \delta_A$$

$$\frac{T_{AC} L_2}{A_2 E_2} = \frac{wL_1^4}{8E_1 I_1} - \frac{T_{AC} L_1^3}{3E_1 I_1}$$

$$T_{AC} \left(\frac{L_2}{A_2 E_2} + \frac{L_1^3}{3E_1 I_1} \right) = \frac{wL_1^4}{8E_1 I_1}$$

$$T_{AC} = \frac{3wA_2 E_2 L_1^4}{8[3E_1 I_1 L_2 + A_2 E_2 L_1^3]}$$

Ans

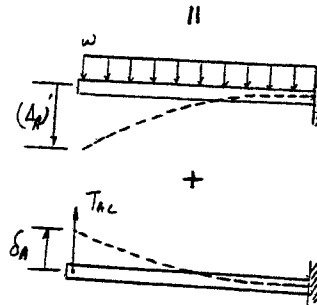

From *Mechanics of Materials*, Sixth Edition by R. C. Hibbeler, ISBN 0-13-191345-X.
 © 2005 R. C. Hibbeler. Published by Pearson Prentice Hall,
 Pearson Education, Inc., Upper Saddle River, NJ. All rights reserved.
 This material is protected under all copyright laws as they currently exist. No portion of this material may be reproduced, in any form or by any means, without permission in writing from the publisher.

12-125. The assembly consists of three simply supported beams for which the bottom of the top beam rests on the top of the bottom two. If a uniform load of 3 kN/m is applied to the top beam, determine the vertical reactions at each of the supports. EI is constant.

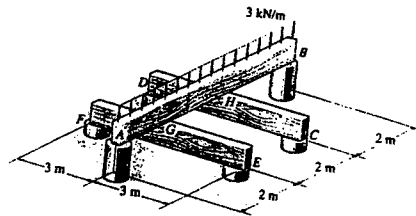

$$\delta_C = \delta_C'$$

$$\delta_C = \delta_1 + \delta_2 + \delta_3$$

$$\delta_1 = \frac{w(L/3)((L/3)^3 - 2L(L/3)^2 + L^3)}{24EI}$$

$$\text{Set } L = 8\text{m}, w = 3\text{ kN/m}$$

$$\delta_1 = \frac{139.062}{EI} \downarrow$$

$$\delta_2 = \frac{P(\frac{1}{2}L)(\frac{1}{2}L)(L^2 - (\frac{1}{3}L)^2 - (\frac{1}{3}L)^2)}{6EI(L)}$$

$$\text{Set } L = 8\text{m}, P = R$$

$$\delta_2 = \frac{7.374 R}{EI} \uparrow$$

$$\delta_3 = \frac{P(\frac{1}{2}L)(\frac{1}{2}L)(L^2 - (\frac{2}{3}L)^2 - (\frac{1}{3}L)^2)}{6EIL}$$

$$\text{Set } L = 8\text{m}, P = R$$

$$\delta_3 = \frac{8.428 R}{EI} \uparrow$$

Thus,

$$\frac{139.062}{EI} - \frac{7.374 R}{EI} - \frac{8.428 R}{EI} = \frac{R(6)^3}{48 EI}$$

$$R = 6.850\text{ kN}$$

Thus,

$$A_y = B_y = 9 - 6.850 = 2.15\text{ kN} \quad \text{Ans}$$

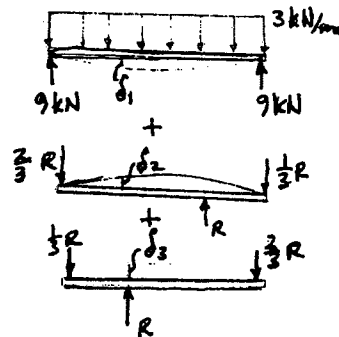
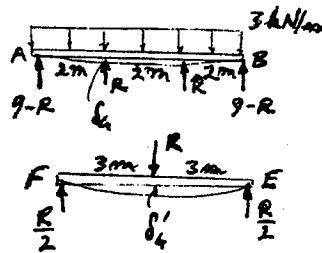

From *Mechanics of Materials*, Sixth Edition by R. C. Hibbeler, ISBN 0-13-191345-X.

© 2005 R. C. Hibbeler. Published by Pearson Prentice Hall,

Pearson Education, Inc., Upper Saddle River, NJ. All rights reserved.

This material is protected under all copyright laws as they currently exist. No portion of this material may be reproduced, in any form or by any means, without permission in writing from the publisher.

12-126 Determine the reactions at A and B . Assume the support at A only exerts a moment on the beam. EI is constant.

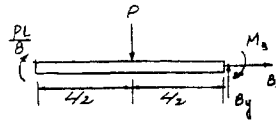
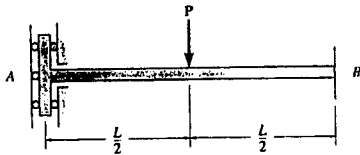

$$(\theta_A)_1 = \frac{PL^2}{8EI}; \quad (\theta_A)_2 = \frac{M_A L}{EI}$$

By superposition :

$$0 = (\theta_A)_1 - (\theta_A)_2$$

$$0 = \frac{PL^2}{8EI} - \frac{M_A L}{EI}$$

$$M_A = \frac{PL}{8} \quad \text{Ans}$$

Equilibrium :

$$\curvearrowleft + \Sigma M_B = 0; \quad -\frac{PL}{8} + \frac{PL}{2} - M_B = 0$$

$$M_B = \frac{3PL}{8} \quad \text{Ans}$$

$$\rightarrow + \Sigma F_x = 0; \quad B_x = 0 \quad \text{Ans}$$

$$\uparrow + \Sigma F_y = 0; \quad B_y = P \quad \text{Ans}$$

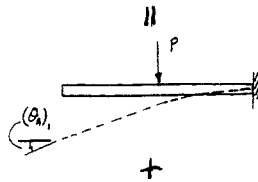
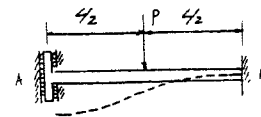

From *Mechanics of Materials*, Sixth Edition by R. C. Hibbeler, ISBN 0-13-191345-X.

© 2005 R. C. Hibbeler. Published by Pearson Prentice Hall,

Pearson Education, Inc., Upper Saddle River, NJ. All rights reserved.

This material is protected under all copyright laws as they currently exist. No portion of this material may be reproduced, in any form or by any means, without permission in writing from the publisher.

12-127 The compound beam segments meet in the center using a smooth contact (roller). Determine the reactions at the fixed supports A and B when the load P is applied. EI is constant.

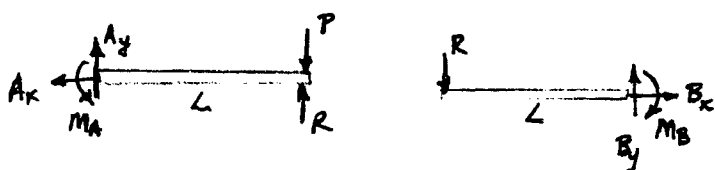
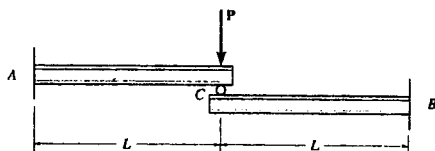

$$\Delta_C = \frac{(P - R)L^3}{3EI} = \frac{RL^3}{3EI}$$

$$R = \frac{P}{2}$$

Member AC :

$$\Sigma F_y = 0; \quad A_y = \frac{P}{2} \quad \text{Ans}$$

$$\Sigma F_x = 0; \quad A_x = 0 \quad \text{Ans}$$

$$\Sigma M_A = 0; \quad M_A = \frac{PL}{2} \quad \text{Ans}$$

Member BC :

$$\Sigma F_y = 0; \quad B_y = \frac{P}{2} \quad \text{Ans}$$

$$\Sigma F_x = 0; \quad B_x = 0 \quad \text{Ans}$$

$$\Sigma M_B = 0; \quad M_B = \frac{PL}{2} \quad \text{Ans}$$

From *Mechanics of Materials*, Sixth Edition by R. C. Hibbeler, ISBN 0-13-191345-X.

© 2005 R. C. Hibbeler. Published by Pearson Prentice Hall,

Pearson Education, Inc., Upper Saddle River, NJ. All rights reserved.

This material is protected under all copyright laws as they currently exist. No portion of this material may be reproduced, in any form or by any means, without permission in writing from the publisher.

***12-128.** Each of the two members is made from 6061-T6 aluminum and has a square cross section 1 in. \times 1 in. They are pin connected at their ends and a jack is placed between them and opened until the force it exerts on each member is 500 lb. Determine the greatest force P that can be applied to the center of the top member without causing either of the two members to yield. For the analysis neglect the axial force in each member. Assume the jack is rigid.

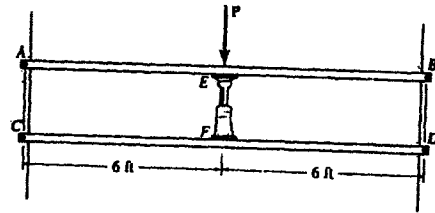

$$\delta_E = \delta_F$$

$$\frac{[P - (R + 50)]L^3}{48 EI} = \frac{(R + 50)L^3}{48 EI}$$

$$P = 2R + 100$$

$$R = \frac{P}{2} - 50$$

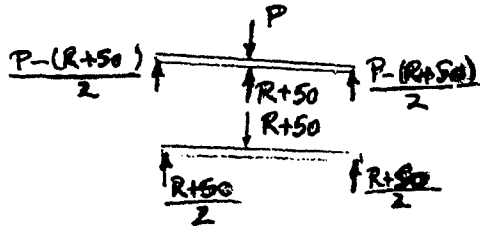

Maximum moment occurs at center of each member.

Top member :

$$M_{\max} = \frac{1}{2}[(P - (\frac{P}{2} - 50 + 50))(6)(12)] = 18P$$

Bottom member :

$$M_{\max} = \frac{1}{2}[(\frac{P}{2} - 50 + 50)(6)(12)] = 18P$$

Both members will yield at the same time.

$$\sigma_{\max} = \frac{Mc}{I}$$

$$37(10^3) = \frac{18P(\frac{1}{2})}{\frac{1}{12}(1)(1)^3}$$

$$P = 343 \text{ lb} \quad \text{Ans}$$

From *Mechanics of Materials*, Sixth Edition by R. C. Hibbeler, ISBN 0-13-191345-X.

© 2005 R. C. Hibbeler. Published by Pearson Prentice Hall,

Pearson Education, Inc., Upper Saddle River, NJ. All rights reserved.

This material is protected under all copyright laws as they currently exist. No portion of this material may be reproduced, in any form or by any means, without permission in writing from the publisher.

12-129 The fixed supported beam AB is strengthened using the simply supported beam CD and the roller at F which is set in place just before application of the load P . Determine the reactions at the supports if EI is constant.

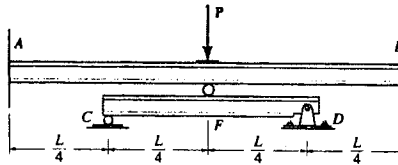

δ_F = Deflection of top beam at F

δ'_F = Deflection of bottom beam at F

$$\delta_F = \delta'_F$$

$$(+ \downarrow) \frac{(P-Q)(L^3)}{48EI} - \frac{2M(\frac{L}{2})}{6EIL} \left(\left(\frac{L}{2}\right)^2 - 3L\left(\frac{L}{2}\right) + 2L^2 \right) = \frac{Q(\frac{L}{2})^3}{48EI}$$

$$\frac{(P-Q)L}{48} - \frac{1}{6}M\left(\frac{1}{4} - \frac{3}{2} + 2\right) = \frac{QL}{48(8)}$$

$$8PL - 48M = 9QL \quad (1)$$

$$\theta_A = \theta'_A + \theta''_A = 0$$

$$\curvearrowright -\frac{ML}{6EI} - \frac{ML}{3EI} + \frac{(P-Q)L^2}{16EI} = 0$$

$$8M = (P-Q)L \quad (2)$$

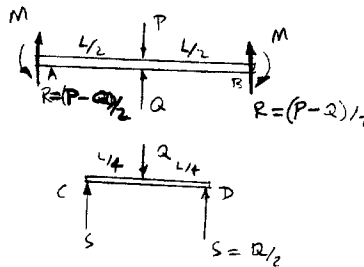

Solving Eqs. (1) and (2) :

$$M = QL/16$$

$$Q = 2P/3$$

$$S = P/3$$

$$R = P/6$$

$$M = PL/24$$

Thus,

$$M_A = M_B = \frac{1}{24}PL \quad \text{Ans}$$

$$A_y = B_y = \frac{1}{6}P \quad \text{Ans}$$

$$C_y = D_y = \frac{1}{3}P \quad \text{Ans}$$

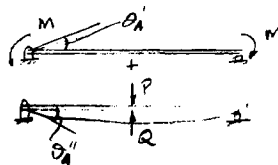

From *Mechanics of Materials*, Sixth Edition by R. C. Hibbeler, ISBN 0-13-191345-X.

© 2005 R. C. Hibbeler. Published by Pearson Prentice Hall,

Pearson Education, Inc., Upper Saddle River, NJ. All rights reserved.

This material is protected under all copyright laws as they currently exist. No portion of this material may be reproduced, in any form or by any means, without permission in writing from the publisher.

12-130. The 1-in.-diameter A-36 steel shaft is supported by unyielding bearings at *A* and *C*. The bearing at *B* rests on a simply supported steel wide-flange beam having a moment of inertia of $I = 500 \text{ in}^4$. If the belt loads on the pulley are 400 lb each, determine the vertical reactions at *A*, *B*, and *C*.

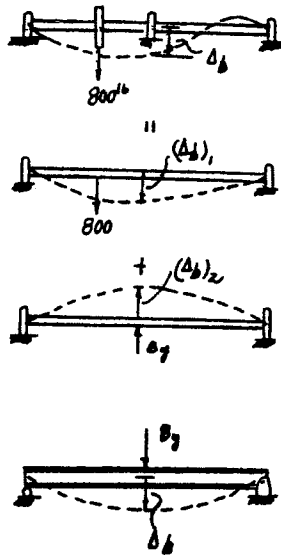
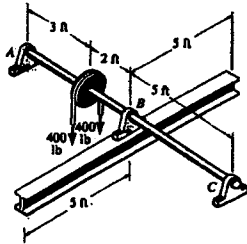

For the shaft :

$$(\Delta_b)_1 = \frac{800(3)(5)}{6EI_s(10)}(-5^2 - 3^2 + 10^2) = \frac{13200}{EI_s}$$

$$(\Delta_b)_2 = \frac{B_y(10^3)}{48EI_s} = \frac{20.833B_y}{EI_s}$$

For the beam :

$$\Delta_b = \frac{B_y(10^3)}{48EI_b} = \frac{20.833B_y}{EI_b}$$

Compatibility condition :

$$+\downarrow \Delta_b = (\Delta_b)_1 - (\Delta_b)_2$$

$$\frac{20.833B_y}{EI_b} = \frac{13200}{EI_s} - \frac{20.833B_y}{EI_s}$$

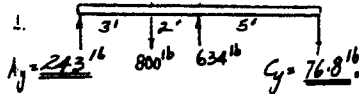

$$I_s = \frac{\pi}{4}(0.5)^4 = 0.04909 \text{ in}^4$$

$$\frac{20.833B_y(0.04909)}{500} = 13200 - 20.833B_y$$

$$B_y = 634 \text{ lb} \quad \text{Ans}$$

From the free-body diagram,

$$A_y = 243 \text{ lb} \quad \text{Ans}$$

$$C_y = 76.8 \text{ lb} \quad \text{Ans}$$

From *Mechanics of Materials*, Sixth Edition by R. C. Hibbeler, ISBN 0-13-191345-X.

© 2005 R. C. Hibbeler. Published by Pearson Prentice Hall,

Pearson Education, Inc., Upper Saddle River, NJ. All rights reserved.

This material is protected under all copyright laws as they currently exist. No portion of this material may be reproduced, in any form or by any means, without permission in writing from the publisher.

*12-132 Determine the deflection at the end B of the clamped A-36 steel strip. The spring has a stiffness of $k = 2 \text{ N/mm}$. The strip is 5 mm wide and 10 mm high. Also, draw the shear and moment diagrams for the strip.

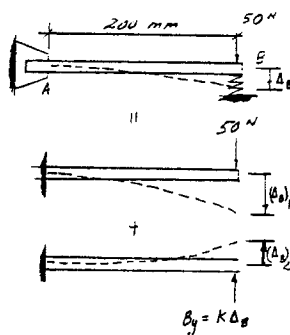
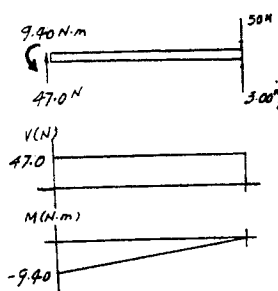
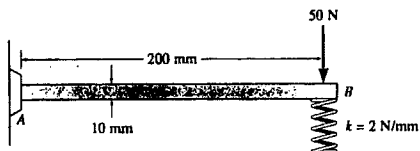

$$I = \frac{1}{12} (0.005)(0.01)^3 = 0.4166 (10^{-9}) \text{ m}^4$$

$$(\Delta_B)_1 = \frac{PL^3}{3EI} = \frac{50(0.2^3)}{3(200)(10^9)(0.4166)(10^{-9})} = 0.0016 \text{ m}$$

$$(\Delta_B)_2 = \frac{PL^3}{3EI} = \frac{2000\Delta_B(0.2^3)}{3(200)(10^9)(0.4166)(10^{-9})} = 0.064 \Delta_B$$

Compatibility condition :

$$+\downarrow \quad \Delta_B = (\Delta_B)_1 - (\Delta_B)_2$$

$$\Delta_B = 0.0016 - 0.064\Delta_B$$

$$\Delta_B = 0.001503 \text{ m} = 1.50 \text{ mm} \quad \text{Ans}$$

$$B_y = k\Delta_B = 2(1.5) = 3.00 \text{ N}$$

From *Mechanics of Materials*, Sixth Edition by R. C. Hibbeler, ISBN 0-13-191345-X.

© 2005 R. C. Hibbeler. Published by Pearson Prentice Hall,

Pearson Education, Inc., Upper Saddle River, NJ. All rights reserved.

This material is protected under all copyright laws as they currently exist. No portion of this material may be reproduced, in any form or by any means, without permission in writing from the publisher.

12-133. The beam is made from a soft elastic material having a constant EI . If it is originally a distance Δ from the surface of its end support, determine the distance a at which it rests on this support when it is subjected to the uniform load w_0 , which is great enough to cause this to happen.

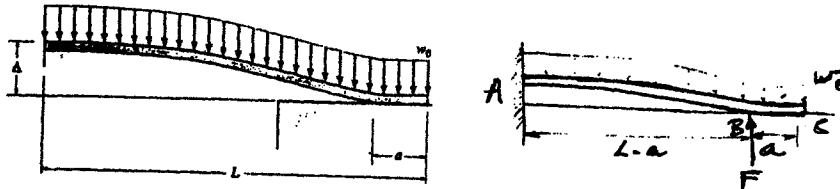

The curvature of the beam in region BC is zero, therefore there is no bending moment in the region BC . The reaction F is at B where it touches the support. The slope is zero at this point and the deflection is Δ where

$$\Delta = \frac{w_0(L-a)^4}{8EI} - \frac{R(L-a)^3}{3EI}$$

$$\theta = \frac{w_0(L-a)^3}{6EI} - \frac{R(L-a)^2}{2EI}$$

Thus,

$$R = \left(\frac{8\Delta EI}{9w_0} \right)^{1/4} \quad \text{Ans}$$

$$L-a = \left(\frac{72\Delta EI}{w_0} \right)^{1/4}$$

$$a = L - \left(\frac{72\Delta EI}{w_0} \right)^{1/4} \quad \text{Ans}$$

From *Mechanics of Materials*, Sixth Edition by R. C. Hibbeler, ISBN 0-13-191345-X.

© 2005 R. C. Hibbeler. Published by Pearson Prentice Hall,

Pearson Education, Inc., Upper Saddle River, NJ. All rights reserved.

This material is protected under all copyright laws as they currently exist. No portion of this material may be reproduced, in any form or by any means, without permission in writing from the publisher.

12-134 The beam is supported by the bolted supports at its ends. When loaded these supports do not provide an actual fixed connection, but instead allow a slight rotation α before becoming fixed. Determine the moment at the connections and the maximum deflection of the beam.

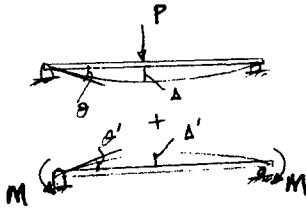
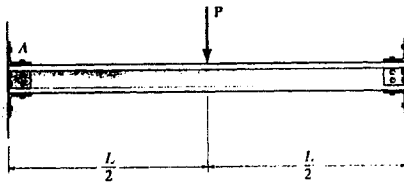

$$\theta - \theta' = \alpha$$

$$\frac{PL^2}{16EI} - \frac{ML}{3EI} - \frac{ML}{6EI} = \alpha$$

$$M = \left(\frac{PL^2}{16EI} - \alpha \right) (2EI)$$

$$M = \left(\frac{PL}{8} - \frac{2EI}{L} \alpha \right) \quad \text{Ans}$$

$$\Delta_{\max} = \Delta - \Delta' = \frac{PL^3}{48EI} - 2 \left[\frac{M(\frac{L}{2})}{6EI} \left[(L/2)^2 - \frac{3L^2}{2} + 2L^2 \right] \right]$$

$$\Delta_{\max} = \frac{PL^3}{48EI} - \frac{L^2}{8EI} \left(\frac{PL}{8} - \frac{2EI\alpha}{L} \right)$$

$$\Delta_{\max} = \frac{PL^3}{192EI} + \frac{\alpha L}{4} \quad \text{Ans}$$

From *Mechanics of Materials*, Sixth Edition by R. C. Hibbeler, ISBN 0-13-191345-X.

© 2005 R. C. Hibbeler. Published by Pearson Prentice Hall,

Pearson Education, Inc., Upper Saddle River, NJ. All rights reserved.

This material is protected under all copyright laws as they currently exist. No portion of this material may be reproduced, in any form or by any means, without permission in writing from the publisher.

12-134 The beam is supported by the bolted supports at its ends. When loaded these supports do not provide an actual fixed connection, but instead allow a slight rotation α before becoming fixed. Determine the moment at the connections and the maximum deflection of the beam.

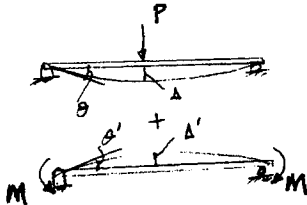
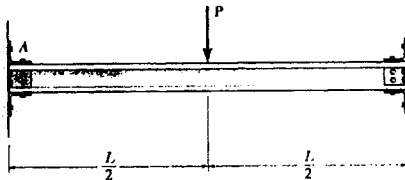

$$\theta - \theta' = \alpha$$

$$\frac{PL^2}{16EI} - \frac{ML}{3EI} - \frac{ML}{6EI} = \alpha$$

$$M = \left(\frac{PL^2}{16EI} - \alpha \right) (2EI)$$

$$M = \left(\frac{PL}{8} - \frac{2EI}{L} \alpha \right) \quad \text{Ans}$$

$$\Delta_{\max} = \Delta - \Delta' = \frac{PL^3}{48EI} - 2 \left[\frac{M(\frac{L}{2})}{6EI} \left[(L/2)^2 - \frac{3L^2}{2} + 2L^2 \right] \right]$$

$$\Delta_{\max} = \frac{PL^3}{48EI} - \frac{L^2}{8EI} \left(\frac{PL}{8} - \frac{2EI\alpha}{L} \right)$$

$$\Delta_{\max} = \frac{PL^3}{192EI} + \frac{\alpha L}{4} \quad \text{Ans}$$

From *Mechanics of Materials*, Sixth Edition by R. C. Hibbeler, ISBN 0-13-191345-X.

© 2005 R. C. Hibbeler. Published by Pearson Prentice Hall,

Pearson Education, Inc., Upper Saddle River, NJ. All rights reserved.

This material is protected under all copyright laws as they currently exist. No portion of this material may be reproduced, in any form or by any means, without permission in writing from the publisher.

12-135. The shaft supports the two pulley loads shown. Using discontinuity functions, determine the equation of the elastic curve. The bearings at A and B exert only vertical reactions on the shaft. EI is constant.

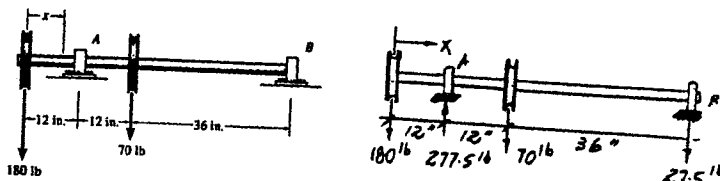

$$M = -180 \langle x-0 \rangle - (-277.5) \langle x-12 \rangle - 70 \langle x-24 \rangle$$

$$M = -180x + 277.5 \langle x-12 \rangle - 70 \langle x-24 \rangle$$

Elastic curve and slope :

$$EI \frac{d^2v}{dx^2} = M = -180x + 277.5 \langle x-12 \rangle - 70 \langle x-24 \rangle$$

$$EI \frac{dv}{dx} = -90x^2 + 138.75 \langle x-12 \rangle^2 - 35 \langle x-24 \rangle^2 + C_1$$

$$EIv = -30x^3 + 46.25 \langle x-12 \rangle^3 - 11.67 \langle x-24 \rangle^3 + C_1x + C_2 \quad (1)$$

Boundary conditions :

$$v = 0 \quad \text{at} \quad x = 12 \text{ in.}$$

From Eq. (1)

$$0 = -51,840 + 12C_1 + C_2$$

$$12C_1 + C_2 = 51,840$$

$$v = 0 \quad \text{at} \quad x = 60 \text{ in.} \quad (2)$$

From Eq. (1)

$$0 = -6,480,000 + 5,114,880 - 544,320 + 60C_1 + C_2$$

$$60C_1 + C_2 = 1,909,440 \quad (3)$$

Solving Eqs. (2) and (3) yields :

$$C_1 = 38,700 \quad C_2 = -412,560$$

$$v = \frac{1}{EI} [-30x^3 + 46.25 \langle x-12 \rangle^3 - 11.67 \langle x-24 \rangle^3 + 38,700x - 412,560] \quad \text{Ans}$$

From *Mechanics of Materials*, Sixth Edition by R. C. Hibbeler, ISBN 0-13-191345-X.

© 2005 R. C. Hibbeler. Published by Pearson Prentice Hall,

Pearson Education, Inc., Upper Saddle River, NJ. All rights reserved.

This material is protected under all copyright laws as they currently exist. No portion of this material may be reproduced, in any form or by any means, without permission in writing from the publisher.

***12-136** Determine the equations of the elastic curve for the beam using the x_1 and x_2 coordinates. Specify the slope at A and the maximum deflection. EI is constant. Use the method of integration.

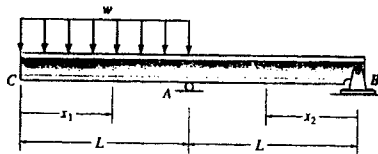

Elastic curve and slope :

$$EI \frac{d^2 v}{dx^2} = M(x)$$

For $M_1(x) = \frac{-wx_1^2}{2}$

$$EI \frac{d^2 v_1}{dx_1^2} = \frac{-wx_1^2}{2}$$

$$EI \frac{dv_1}{dx_1} = \frac{-wx_1^3}{6} + C_1 \quad (1)$$

$$EI v_1 = \frac{-wx_1^4}{24} + C_1 x_1 + C_2 \quad (2)$$

For $M_2(x) = \frac{-wLx_2}{2}$

$$EI \frac{d^2 v_2}{dx_2^2} = \frac{-wLx_2}{2}$$

$$EI \frac{dv_2}{dx_2} = \frac{-wLx_2^2}{4} + C_3 \quad (3)$$

$$EI v_2 = \frac{-wLx_2^3}{12} + C_3 x_2 + C_4 \quad (4)$$

Boundary Conditions :

$$v_2 = 0 \quad \text{at} \quad x_2 = 0$$

From Eq. (4) :

$$C_4 = 0$$

$$v_2 = 0 \quad \text{at} \quad x_2 = L$$

From Eq. (4) :

$$0 = \frac{-wL^4}{12} + C_3 L$$

$$C_3 = \frac{wL^3}{12}$$

$$v_1 = 0 \quad \text{at} \quad x_1 = L$$

From Eq. (2) :

$$0 = \frac{-wL^4}{24} + C_1 L + C_2 \quad (5)$$

Continuity conditions :

$$\frac{dv_1}{dx_1} = \frac{dv_2}{dx_2} \quad \text{at} \quad x_1 = x_2 = L$$

From Eqs. (1) and (3)

$$-\frac{wL^3}{6} + C_1 = -\left(-\frac{wL^3}{4} + \frac{wL^3}{12}\right)$$

$$C_1 = \frac{wL^3}{3}$$

Substitute C_1 into Eq. (5)

$$C_2 = -\frac{7wL^4}{24}$$

$$\frac{dv_1}{dx_1} = \frac{w}{6EI} (2L^3 - x_1^3)$$

$$\frac{dv_2}{dx_2} = \frac{w}{12EI} (L^3 - 3Lx_2^2) \quad (6)$$

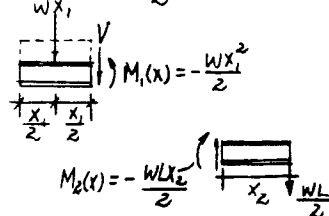
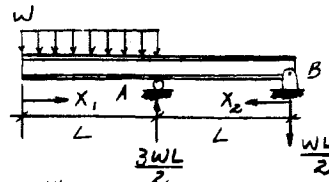

$$\theta_A = \left. \frac{dv_1}{dx_1} \right|_{x_1=L} = -\left. \frac{dv_2}{dx_2} \right|_{x_2=L} = \frac{wL^2}{6EI} \quad \text{Ans}$$

$$v_1 = \frac{w}{24EI} (-x_1^4 + 8L^3 x_1 - 7L^4) \quad \text{Ans}$$

$$(v_1)_{\max} = \frac{-7wL^4}{24EI} \quad (x_1 = 0)$$

The negative sign indicates downward displacement.

$$v_2 = \frac{wL}{12EI} (L^2 x_2 - x_2^3) \quad (7) \quad \text{Ans}$$

$$(v_2)_{\max} \text{ occurs when } \frac{dv_2}{dx_2} = 0$$

From Eq. (6)

$$L^3 - 3Lx_2^2 = 0$$

$$x_2 = \frac{L}{\sqrt{3}}$$

Substitute x_2 into Eq. (7),

$$(v_2)_{\max} = \frac{wL^4}{18\sqrt{3}EI} \quad (8)$$

$$v_{\max} = (v_1)_{\max} = \frac{7wL^4}{24EI} \quad (9) \quad \text{Ans}$$

From *Mechanics of Materials*, Sixth Edition by R. C. Hibbeler, ISBN 0-13-191345-X.

© 2005 R. C. Hibbeler. Published by Pearson Prentice Hall,

Pearson Education, Inc., Upper Saddle River, NJ. All rights reserved.

This material is protected under all copyright laws as they currently exist. No portion of this material may be reproduced, in any form or by any means, without permission in writing from the publisher.

12-137 Determine the maximum deflection between the supports A and B. EI is constant. Use the method of integration.

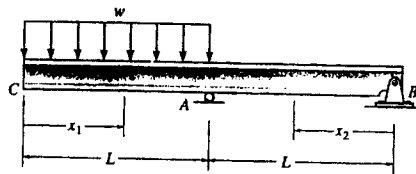

Elastic curve and slope :

$$EI \frac{d^2 v}{dx^2} = M(x)$$

For $M_1(x) = \frac{-wx_1^2}{2}$

$$EI \frac{d^2 v_1}{dx_1^2} = \frac{-wx_1^2}{2}$$

$$EI \frac{dv_1}{dx_1} = \frac{-wx_1^3}{6} + C_1 \quad (1)$$

$$EI v_1 = \frac{-wx_1^4}{24} + C_1 x_1 + C_2 \quad (2)$$

For $M_2(x) = \frac{-wLx_2}{2}$

$$EI \frac{d^2 v_2}{dx_2^2} = \frac{-wLx_2}{2}$$

$$EI \frac{dv_2}{dx_2} = \frac{-wLx_2^2}{4} + C_3 \quad (3)$$

$$EI v_2 = \frac{-wLx_2^3}{12} + C_3 x_2 + C_4 \quad (4)$$

Boundary Conditions :

$$v_2 = 0 \quad \text{at} \quad x_2 = 0$$

From Eq. (4) :

$$C_4 = 0$$

$$v_2 = 0 \quad \text{at} \quad x_2 = L$$

From Eq. (4) :

$$0 = \frac{-wL^3}{12} + C_3 L$$

$$C_3 = \frac{wL^2}{12}$$

$$v_1 = 0 \quad \text{at} \quad x_1 = L$$

From Eq. (2)

$$0 = \frac{-wL^4}{24} + C_1 L + C_2 \quad (5)$$

Continuity conditions :

$$\frac{dv_1}{dx_1} = \frac{dv_2}{dx_2} \quad \text{at} \quad x_1 = x_2 = L$$

From Eqs. (1) and (3)

$$-\frac{wL^3}{6} + C_1 = -\left(-\frac{wL^3}{4} + \frac{wL^3}{12}\right)$$

$$C_1 = \frac{wL^3}{3}$$

Substitute C_1 into Eq. (5)

$$C_2 = -\frac{7wL^4}{24}$$

$$\frac{dv_1}{dx_1} = \frac{w}{6EI} (2L^3 - x_1^3)$$

$$\frac{dv_2}{dx_2} = \frac{w}{12EI} (L^3 - 3Lx_2^2) \quad (6)$$

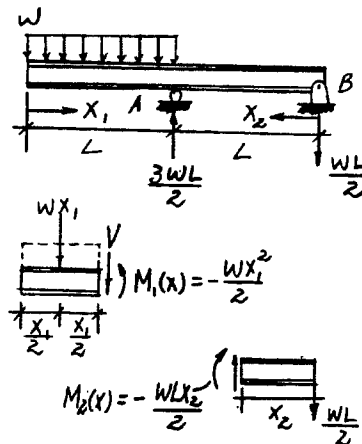

$$\theta_A = \frac{dv_1}{dx_1} \Big|_{x_1=L} = -\frac{dv_2}{dx_2} \Big|_{x_2=L} = \frac{wL^3}{6EI} \quad \text{Ans}$$

$$v_1 = \frac{w}{24EI} (-x_1^4 + 8L^3 x_1 - 7L^4) \quad \text{Ans}$$

$$(v_1)_{\max} = \frac{-7wL^4}{24EI} \quad (x_1 = 0)$$

The negative sign indicates downward displacement.

$$v_2 = \frac{wL}{12EI} (L^2 x_2 - x_2^3) \quad (7) \quad \text{Ans}$$

$$(v_2)_{\max} \text{ occurs when } \frac{dv_2}{dx_2} = 0$$

From Eq. (6)

$$L^3 - 3Lx_2^2 = 0$$

$$x_2 = \frac{L}{\sqrt{3}}$$

Substitute x_2 into Eq. (7).

$$(v_2)_{\max} = \frac{wL^4}{18\sqrt{3}EI} \quad \text{Ans}$$

12-138. If the bearings at A and B exert only vertical reactions on the shaft, determine the slope at B and the deflection at C . EI is constant. Use the moment-area theorems.

Support Reaction and Elastic Curve: As shown.

M/EI Diagram: As shown.

Moment-Area Theorems:

$$\theta_{B/D} = \frac{1}{2} \left(\frac{Pa}{2EI} \right) (a) = \frac{Pa^2}{4EI}$$

Due to symmetry, the slope at point D is zero. Hence, the slope at B is

$$\theta_B = |\theta_{B/D}| = \frac{Pa^2}{4EI} \quad \text{Ans}$$

The displacement at C is

$$\Delta_C = \theta_B L_{BC} = \frac{Pa^2}{4EI} (a) = \frac{Pa^3}{4EI} \uparrow \quad \text{Ans}$$

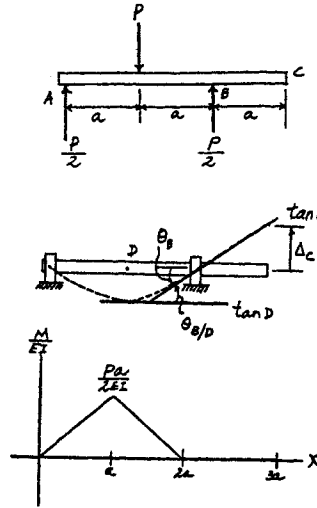

From *Mechanics of Materials*, Sixth Edition by R. C. Hibbeler, ISBN 0-13-191345-X.

© 2005 R. C. Hibbeler. Published by Pearson Prentice Hall,

Pearson Education, Inc., Upper Saddle River, NJ. All rights reserved.

This material is protected under all copyright laws as they currently exist. No portion of this material may be reproduced, in any form or by any means, without permission in writing from the publisher.

12-139. The bearing supports A , B , and C exert only vertical reactions on the shaft. Determine these reactions, then draw the shear and moment diagrams. EI is constant. Use the moment-area theorems.

$$(t_{B/A})_1 = \frac{1}{2} \left(\frac{3PL}{8EI} \right) \left(\frac{L}{2} \right) \left(\frac{L}{2} + \frac{L}{6} \right) + \frac{1}{2} \left(\frac{PL}{8EI} \right) \left(\frac{L}{2} \right) \left(\frac{L}{3} \right) + \frac{PL}{4EI} \left(\frac{L}{2} \right) \left(\frac{L}{4} \right) = \frac{5PL^3}{48EI}$$

$$(t_{C/A})_1 = \frac{1}{2} \left(\frac{3PL}{8EI} \right) \left(\frac{L}{2} \right) \left(\frac{3L}{2} + \frac{L}{6} \right) + \frac{1}{2} \left(\frac{3PL}{8EI} \right) \left(\frac{3L}{2} \right) (L) = \frac{7PL^3}{16EI}$$

$$(t_{B/A})_2 = \frac{1}{2} \left(\frac{-B_y L}{2EI} \right) (L) \left(\frac{L}{3} \right) = \frac{-B_y L^3}{12EI}$$

$$(t_{C/A})_2 = \frac{1}{2} \left(\frac{-B_y L}{2EI} \right) (L) \left(L + \frac{L}{3} \right) + \frac{1}{2} \left(\frac{-B_y L}{2EI} \right) (L) \left(\frac{2}{3} L \right) = \frac{-B_y L^3}{2EI}$$

$$2t_{B/A} = t_{C/A}$$

$$2[(t_{B/A})_1 + (t_{B/A})_2] = (t_{C/A})_1 + (t_{C/A})_2$$

$$2 \left[\frac{5PL^3}{48EI} + \left(\frac{-B_y L^3}{12EI} \right) \right] = \frac{7PL^3}{16EI} + \left(\frac{-B_y L^3}{2EI} \right)$$

$$B_y = \frac{11}{16} P$$

Thus,

$$B_y = \frac{11}{16} (200) = 138 \text{ N} \quad \text{Ans}$$

As shown on the free-body diagram

$$A_y = 81.3 \text{ N} \quad \text{Ans}$$

$$C_y = 18.8 \text{ N} \quad \text{Ans}$$

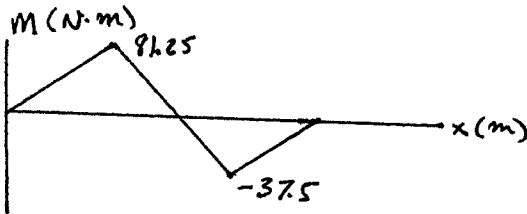
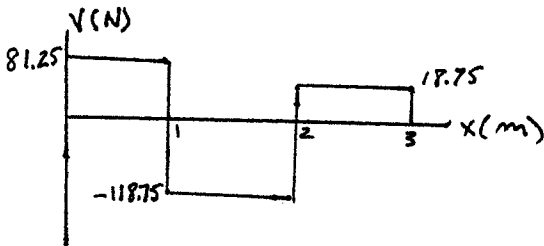
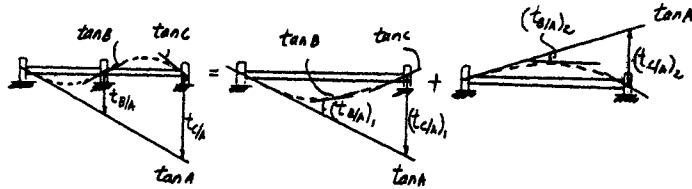

From *Mechanics of Materials*, Sixth Edition by R. C. Hibbeler, ISBN 0-13-191345-X.

© 2005 R. C. Hibbeler. Published by Pearson Prentice Hall,

Pearson Education, Inc., Upper Saddle River, NJ. All rights reserved.

This material is protected under all copyright laws as they currently exist. No portion of this material may be reproduced, in any form or by any means, without permission in writing from the publisher.

*12-140 The shaft is supported by a journal bearing at *A*, which exerts only vertical reactions on the shaft, and by a thrust bearing at *B*, which exerts both horizontal and vertical reactions on the shaft. Draw the bending-moment diagram for the shaft and then, from this diagram, sketch the deflection or elastic curve of the shaft's centerline. Determine the equations of the elastic curve using the coordinates x_1 and x_2 . EI is constant.

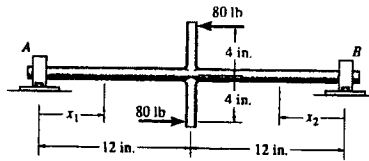

For $M_1(x) = 26.67x_1$

$$EI \frac{d^2v_1}{dx_1^2} = 26.67x_1$$

$$EI \frac{dv_1}{dx_1} = 13.33x_1^2 + C_1$$

$$EIv_1 = 4.44x_1^3 + C_1x_1 + C_2$$

For $M_2(x) = -26.67x_2$

$$EI \frac{d^2v_2}{dx_2^2} = -26.67x_2$$

$$EI \frac{dv_2}{dx_2} = -13.33x_2^2 + C_3$$

$$EIv_2 = -4.44x_2^3 + C_3x_2 + C_4$$

Boundary conditions :

$$v_1 = 0 \quad \text{at} \quad x_1 = 0$$

From Eq. (2)

$$C_2 = 0$$

$$v_2 = 0 \quad \text{at} \quad x_2 = 0$$

$$C_4 = 0$$

Continuity conditions :

$$\frac{dv_1}{dx_1} = -\frac{dv_2}{dx_2} \quad \text{at} \quad x_1 = x_2 = 12$$

From Eqs. (1) and (3)

$$1920 + C_1 = -(-1920 + C_3)$$

$$C_1 = -C_3 \quad (5)$$

$$v_1 = v_2 \quad \text{at} \quad x_1 = x_2 = 12$$

$$7680 + 12C_1 = -7680 + 12C_3$$

$$C_3 - C_1 = 1280 \quad (6)$$

Solving Eqs. (5) and (6) yields :

$$C_3 = 640 \quad C_1 = -640$$

$$v_1 = \frac{1}{EI} (4.44x_1^3 - 640x_1) \text{ lb} \cdot \text{in}^3 \quad \text{Ans}$$

$$v_2 = \frac{1}{EI} (-4.44x_2^3 + 640x_2) \text{ lb} \cdot \text{in}^3 \quad \text{Ans}$$

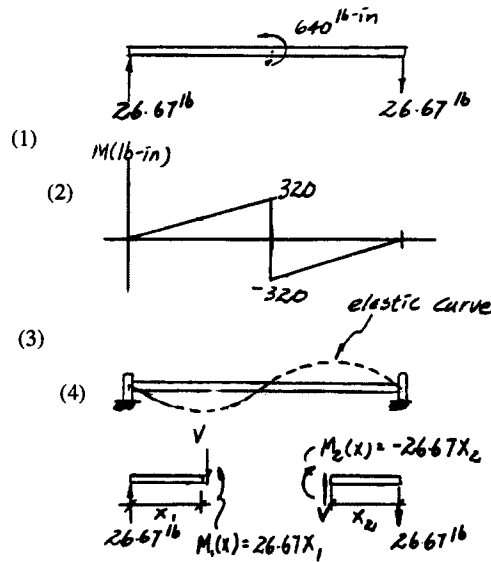

From *Mechanics of Materials*, Sixth Edition by R. C. Hibbeler, ISBN 0-13-191345-X.

© 2005 R. C. Hibbeler. Published by Pearson Prentice Hall,

Pearson Education, Inc., Upper Saddle River, NJ. All rights reserved.

This material is protected under all copyright laws as they currently exist. No portion of this material may be reproduced, in any form or by any means, without permission in writing from the publisher.

12-141 Determine the reactions at the supports. EI is constant. Use the method of superposition.

$$\Delta_B = \Delta_C = \frac{wL}{24EI} [L^3 - 2(3L)L^2 + (3L)^3]$$

$$= \frac{11wL^4}{12EI}$$

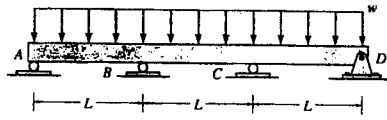

Due to symmetry, $B_y = C_y$

$$\Delta_{BB} = \Delta_{CC} = \frac{B_y(L)(2L)}{6EI(3L)} [(3L)^2 - (2L)^2 - L^2]$$

$$= \frac{4B_y L^3}{9EI}$$

$$\Delta_{BC} = \Delta_{CB} = \frac{B_y(L)(L)}{6EI(3L)} [-L^2 - L^2 + (3L)^2]$$

$$= \frac{7B_y L^3}{18EI}$$

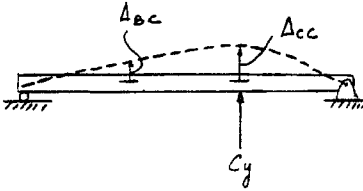
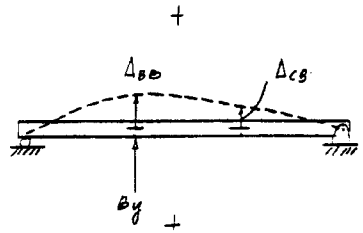
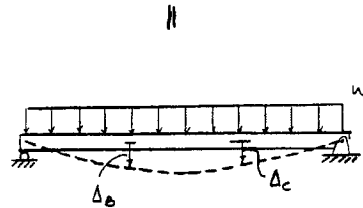

By superposition :

$$+\downarrow 0 = \Delta_B - \Delta_{BB} - \Delta_{BC}$$

$$0 = \frac{11wL^4}{12EI} - \frac{4B_y L^3}{9EI} - \frac{7B_y L^3}{18EI}$$

$$B_y = C_y = \frac{11wL}{10} \quad \text{Ans}$$

Equilibrium :

$$\left(+ \sum M_D = 0; \quad 3wL\left(\frac{3L}{2}\right) - \frac{11wL}{10}(L) - \frac{11wL}{10}(2L) - A_y(3L) = 0 \right.$$

$$A_y = \frac{2wL}{5} \quad \text{Ans}$$

$$\uparrow + \sum F_y = 0; \quad \frac{2wL}{5} + \frac{11wL}{10} + \frac{11wL}{10} + D_y - 3wL = 0$$

$$D_y = \frac{2wL}{5} \quad \text{Ans}$$

$$+\sum F_x = 0; \quad D_x = 0 \quad \text{Ans}$$

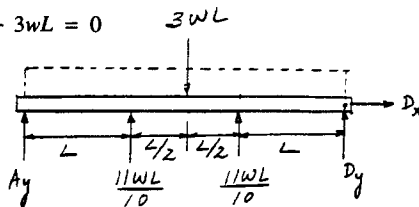

From *Mechanics of Materials*, Sixth Edition by R. C. Hibbeler, ISBN 0-13-191345-X.

© 2005 R. C. Hibbeler. Published by Pearson Prentice Hall,

Pearson Education, Inc., Upper Saddle River, NJ. All rights reserved.

This material is protected under all copyright laws as they currently exist. No portion of this material may be reproduced, in any form or by any means, without permission in writing from the publisher.

12-142. Determine the value of a so that the deflection at C is equal to zero. EI is constant. Use the moment-area theorems.

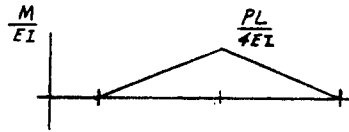
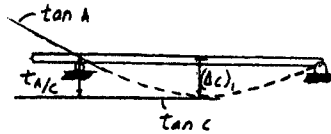
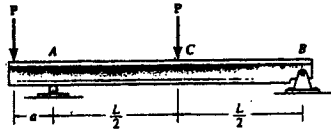

$$(\Delta_C)_1 = t_{WC} = \frac{1}{2} \left(\frac{PL}{4EI} \right) \left(\frac{L}{2} \right) \left(\frac{2}{3} \right) \left(\frac{L}{2} \right) = \frac{PL^3}{48EI} \downarrow$$

$$t_{B/A} = \frac{1}{2} \left(\frac{-Pa}{EI} \right) \left(L \right) \left(\frac{2}{3} \right) \left(L \right) = -\frac{PaL^2}{3EI}$$

$$t_{C/A} = \left(\frac{-Pa}{2EI} \right) \left(\frac{L}{2} \right) \left(\frac{L}{4} \right) + \frac{1}{2} \left(\frac{-Pa}{2EI} \right) \left(\frac{L}{2} \right) \left(\frac{2}{3} \right) \left(\frac{L}{2} \right) = -\frac{5PaL^2}{48EI}$$

$$(\Delta_C)_2 = \frac{1}{2} |t_{B/A}| - |t_{C/A}| = \frac{PaL^2}{6EI} - \frac{5PaL^2}{48EI} = \frac{PaL^2}{16EI} \uparrow$$

Require:

$$+ \uparrow \quad 0 = (\Delta_C)_2 - (\Delta_C)_1$$

$$0 = \frac{PaL^2}{16EI} - \frac{PL^3}{48EI}$$

$$a = \frac{L}{3} \quad \text{Ans}$$

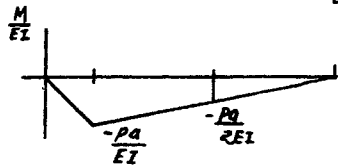
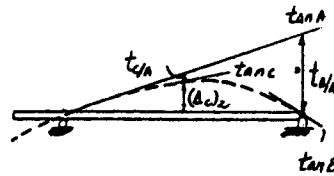

From *Mechanics of Materials*, Sixth Edition by R. C. Hibbeler, ISBN 0-13-191345-X.

© 2005 R. C. Hibbeler. Published by Pearson Prentice Hall,

Pearson Education, Inc., Upper Saddle River, NJ. All rights reserved.

This material is protected under all copyright laws as they currently exist. No portion of this material may be reproduced, in any form or by any means, without permission in writing from the publisher.

*12-143. Using the method of superposition, determine the magnitude of M_0 in terms of the distributed load w and dimension a so that the deflection at the center of the beam is zero. EI is constant.

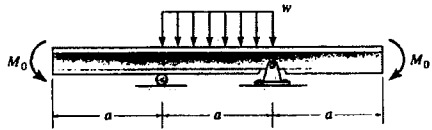

$$(\Delta_C)_1 = \frac{5wa^4}{384EI} \downarrow$$

$$(\Delta_C)_2 = (\Delta_C)_3 = \frac{M_0 a^2}{16EI} \uparrow$$

$$\Delta_C = 0 = (\Delta_C)_1 + (\Delta_C)_2 + (\Delta_C)_3$$

$$+\uparrow \quad 0 = \frac{-5wa^4}{384EI} + \frac{M_0 a^2}{8EI}$$

$$M_0 = \frac{5wa^2}{48} \quad \text{Ans}$$

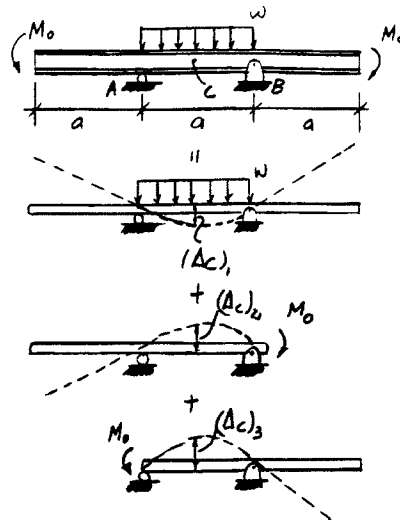

From *Mechanics of Materials*, Sixth Edition by R. C. Hibbeler, ISBN 0-13-191345-X.

© 2005 R. C. Hibbeler. Published by Pearson Prentice Hall,

Pearson Education, Inc., Upper Saddle River, NJ. All rights reserved.

This material is protected under all copyright laws as they currently exist. No portion of this material may be reproduced, in any form or by any means, without permission in writing from the publisher.

13-1. Determine the critical buckling load for the column.
The material can be assumed rigid.

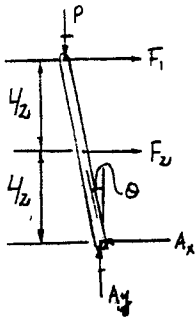
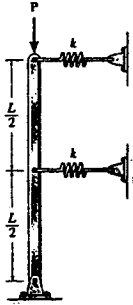

$$F_1 = k(L\theta); \quad F_2 = k\left(\frac{L}{2}\theta\right)$$

$$\left(\sum M_A = 0; \quad P(\theta)(L) - (F_1 L) - F_2\left(\frac{L}{2}\right) = 0\right.$$

$$P(\theta)(L) - kL^2\theta - k\left(\frac{L}{2}\right)^2\theta = 0$$

Require :

$$P_{cr} = kL + \frac{kL}{4} = \frac{5kL}{4}$$

Ans

From *Mechanics of Materials*, Sixth Edition by R. C. Hibbeler, ISBN 0-13-191345-X.

© 2005 R. C. Hibbeler. Published by Pearson Prentice Hall,

Pearson Education, Inc., Upper Saddle River, NJ. All rights reserved.

This material is protected under all copyright laws as they currently exist. No portion of this material may be reproduced, in any form or by any means, without permission in writing from the publisher.

13-2. The column consists of a rigid member that is pinned at its bottom and attached to a spring at its top. If the spring is unstretched when the column is in the vertical position, determine the critical load that can be placed on the column.

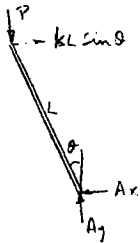
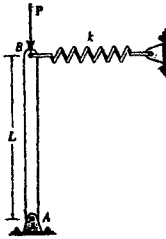

$$\sum M_A = 0; \quad PL \sin \theta - (kL \sin \theta)(L \cos \theta) = 0$$

$$P = kL \cos \theta$$

Since θ is small $\cos \theta \approx 1$

$$P_{cr} = kL \quad \text{Ans}$$

From *Mechanics of Materials*, Sixth Edition by R. C. Hibbeler, ISBN 0-13-191345-X.

© 2005 R. C. Hibbeler. Published by Pearson Prentice Hall,

Pearson Education, Inc., Upper Saddle River, NJ. All rights reserved.

This material is protected under all copyright laws as they currently exist. No portion of this material may be reproduced, in any form or by any means, without permission in writing from the publisher.

13-3 The leg in (a) acts as a column and can be modeled (b) by the two pin-connected members that are attached to a torsional spring having a stiffness k (torque/rad). Determine the critical buckling load. Assume the bone material is rigid.

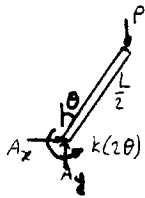
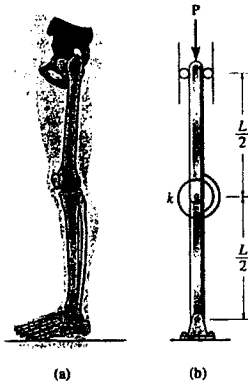

$$\left(+ \Sigma M_A = 0; \quad -P(\theta)\left(\frac{L}{2}\right) + 2k\theta = 0 \right.$$

Require :

$$P_{cr} = \frac{4k}{L} \quad \text{Ans}$$

From *Mechanics of Materials*, Sixth Edition by R. C. Hibbeler, ISBN 0-13-191345-X.

© 2005 R. C. Hibbeler. Published by Pearson Prentice Hall,

Pearson Education, Inc., Upper Saddle River, NJ. All rights reserved.

This material is protected under all copyright laws as they currently exist. No portion of this material may be reproduced, in any form or by any means, without permission in writing from the publisher.

***13-4.** The aircraft link is made from an A-36 steel rod. Determine the smallest diameter of the rod, to the nearest $\frac{1}{16}$ in., that will support the load of 4 kip without buckling. The ends are pin connected.

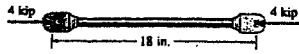

$$I = \frac{\pi}{4} \left(\frac{d}{2}\right)^4 = \frac{\pi d^4}{64}$$

$$K = 1.0$$

$$P_{cr} = \frac{\pi^2 EI}{(KL)^2}$$

$$4 = \frac{\pi^2 (29)(10^3) \left(\frac{\pi d^4}{64}\right)}{((1.0)(18))^2}$$

$$d = 0.551 \text{ in.}$$

$$\text{Use } d = \frac{9}{16} \text{ in.} \quad \text{Ans}$$

Check :

$$\sigma_{cr} = \frac{P_{cr}}{A} = \frac{4}{\frac{\pi}{4}(0.551^2)} = 16.7 \text{ ksi} < \sigma_y$$

Therefore, Euler's formula is valid.

From *Mechanics of Materials*, Sixth Edition by R. C. Hibbeler, ISBN 0-13-191345-X.

© 2005 R. C. Hibbeler. Published by Pearson Prentice Hall,

Pearson Education, Inc., Upper Saddle River, NJ. All rights reserved.

This material is protected under all copyright laws as they currently exist. No portion of this material may be reproduced, in any form or by any means, without permission in writing from the publisher.

13-5 A square bar is made from PVC plastic that has a modulus of elasticity of $E = 1.25(10^6)$ psi and a yield strain of $\epsilon_Y = 0.001$ in./in. Determine its smallest cross-sectional dimensions a so it does not fail from elastic buckling. It is pinned at its ends and has a length of 50 in.

$$\sigma_Y = E\epsilon_Y = 1.25(10^6)(0.001) = 1.25(10^3) \text{ psi}$$

$$P_{cr} = \frac{\pi^2 EI}{(KL)^2}$$

$$1.25(10^3)(a)^2 = \frac{\pi^2(1.25)(10^6)(\frac{1}{12}a^4)}{(1.0(50))^2}$$

$$a = 1.74 \text{ in.} \quad \mathbf{Ans}$$

From *Mechanics of Materials*, Sixth Edition by R. C. Hibbeler, ISBN 0-13-191345-X.

© 2005 R. C. Hibbeler. Published by Pearson Prentice Hall,

Pearson Education, Inc., Upper Saddle River, NJ. All rights reserved.

This material is protected under all copyright laws as they currently exist. No portion of this material may be reproduced, in any form or by any means, without permission in writing from the publisher.

13-6. A rod made from polyurethane has a stress-strain diagram in compression as shown. If the rod is pinned at its ends and is 37 in. long, determine its smallest diameter so it does not fail from elastic buckling.

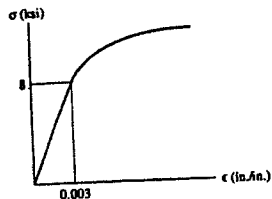

$$E = \frac{\sigma}{\epsilon} = \frac{8(10^3)}{0.003} = 2.667(10^6) \text{ psi}$$

$$P_{cr} = \frac{\pi^2 EI}{(KL)^2}$$

$$8(10^3)\pi (d/2)^2 = \frac{\pi^2 (2.667)(10^6) (\frac{\pi}{4}) (\frac{d}{2})^4}{(1.0(37))^2}$$

$$d = 2.58 \text{ in.} \quad \text{Ans}$$

From *Mechanics of Materials*, Sixth Edition by R. C. Hibbeler, ISBN 0-13-191345-X.

© 2005 R. C. Hibbeler. Published by Pearson Prentice Hall,

Pearson Education, Inc., Upper Saddle River, NJ. All rights reserved.

This material is protected under all copyright laws as they currently exist. No portion of this material may be reproduced, in any form or by any means, without permission in writing from the publisher.

13-7. A rod made from polyurethane has a stress-strain diagram in compression as shown. If the rod is pinned at its top and fixed at its base, and is 37 in. long, determine its smallest diameter so it does not fail from elastic buckling.

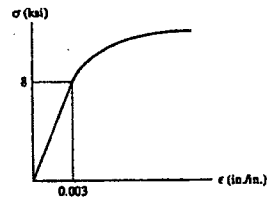

$$E = \frac{8(10^3)}{0.003} = 2.667(10^6) \text{ psi}$$

$$P_{cr} = \frac{\pi^2 EI}{(KL)^2}$$

$$8(10^3)\pi (d/2)^2 = \frac{\pi^2 (2.667)(10^6) (\frac{\pi}{4}) (\frac{d}{2})^4}{[(0.7)(37)]^2}$$

$$d = 1.81 \text{ in.} \quad \text{Ans}$$

From *Mechanics of Materials*, Sixth Edition by R. C. Hibbeler, ISBN 0-13-191345-X.

© 2005 R. C. Hibbeler. Published by Pearson Prentice Hall,

Pearson Education, Inc., Upper Saddle River, NJ. All rights reserved.

This material is protected under all copyright laws as they currently exist. No portion of this material may be reproduced, in any form or by any means, without permission in writing from the publisher.

*13-8 An A-36 steel column has a length of 5 m and is fixed at both ends. If the cross-sectional area has the dimensions shown, determine the critical load.

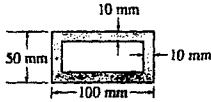

$$I = \frac{1}{12}(0.1)(0.05^3) - \frac{1}{12}(0.08)(0.03^3) = 0.86167 (10^{-6}) \text{ m}^4$$

$$P_{cr} = \frac{\pi^2 EI}{(KL)^2} = \frac{\pi^2 (200)(10^9)(0.86167)(10^{-6})}{[(0.5)(5)]^2}$$

$$= 272\,138 \text{ N}$$

$$= 272 \text{ kN} \quad \text{Ans}$$

$$\sigma_{cr} = \frac{P_{cr}}{A}; \quad A = (0.1)(0.05) - (0.08)(0.03) = 2.6 (10^{-3}) \text{ m}^2$$

$$= \frac{272\,138}{2.6 (10^{-3})} = 105 \text{ MPa} < \sigma_y$$

Therefore, Euler's formula is valid.

From *Mechanics of Materials*, Sixth Edition by R. C. Hibbeler, ISBN 0-13-191345-X.

© 2005 R. C. Hibbeler. Published by Pearson Prentice Hall,

Pearson Education, Inc., Upper Saddle River, NJ. All rights reserved.

This material is protected under all copyright laws as they currently exist. No portion of this material may be reproduced, in any form or by any means, without permission in writing from the publisher.

13-9 An A-36 steel column has a length of 15 ft and is pinned at both ends. If the cross-sectional area has the dimensions shown, determine the critical load.

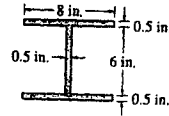

$$I_x = \frac{1}{12}(8)(7^3) - \frac{1}{12}(7.5)(6^3) = 93.67 \text{ in}^4$$

$$I_y = 2\left(\frac{1}{12}\right)(0.5)(8^3) + \frac{1}{12}(6)(0.5^3) = 42.729 \text{ in}^4 \text{ (controls)}$$

$$P_{cr} = \frac{\pi^2 EI}{(KL)^2} = \frac{\pi^2(29)(10^3)(42.729)}{[(1.0)(15)(12)]^2}$$

$$= 377 \text{ kip} \quad \text{Ans}$$

Check :

$$A = (2)(8)(0.5) + 6(0.5) = 11 \text{ in}^2$$

$$\sigma_{cr} = \frac{P_{cr}}{A} = \frac{377}{11} = 34.3 \text{ ksi} < \sigma_y$$

Therefore, Euler's formula is valid

From *Mechanics of Materials*, Sixth Edition by R. C. Hibbeler, ISBN 0-13-191345-X.

© 2005 R. C. Hibbeler. Published by Pearson Prentice Hall,

Pearson Education, Inc., Upper Saddle River, NJ. All rights reserved.

This material is protected under all copyright laws as they currently exist. No portion of this material may be reproduced, in any form or by any means, without permission in writing from the publisher.

13-10 Solve Prob. 13-9 if the column is fixed at its bottom and free at its top.

$$I_x = \frac{1}{12}(8)(7^3) - \frac{1}{12}(7.5)(6^3) = 93.67 \text{ in}^4$$

$$I_y = 2\left(\frac{1}{12}\right)(0.5)(8^3) + \frac{1}{12}(6)(0.5^3) = 42.729 \text{ in}^4 \text{ (controls)}$$

$$P_{cr} = \frac{\pi^2 EI}{(KL)^2} = \frac{\pi^2(29)(10^3)(42.729)}{(2.0(15)(12))^2} = 94.4 \text{ kip} \quad \text{Ans}$$

Check :

$$A = 2(8)(0.5) + 6(0.5) = 11 \text{ in}^2$$

$$\sigma_{cr} = \frac{P}{A} = \frac{94.4}{11} = 8.58 \text{ ksi} < \sigma_Y$$

Therefore, Euler's formula is valid.

From *Mechanics of Materials*, Sixth Edition by R. C. Hibbeler, ISBN 0-13-191345-X.

© 2005 R. C. Hibbeler. Published by Pearson Prentice Hall,

Pearson Education, Inc., Upper Saddle River, NJ. All rights reserved.

This material is protected under all copyright laws as they currently exist. No portion of this material may be reproduced, in any form or by any means, without permission in writing from the publisher.

13-11 The A-36 steel angle has a cross-sectional area of $A = 2.48 \text{ in}^2$ and a radius of gyration about the x axis of $r_x = 1.26 \text{ in.}$ and about the y axis of $r_y = 0.879 \text{ in.}$ The smallest radius of gyration occurs about the z axis and is $r_z = 0.644 \text{ in.}$ If the angle is to be used as a pin-connected 10-ft-long column, determine the largest axial load that can be applied through its centroid C without causing it to buckle.

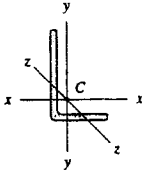

The least radius of gyration :

$$r_z = 0.644 \text{ in.} \quad \text{controls.}$$

$$\begin{aligned} \sigma_{cr} &= \frac{\pi^2 E}{\left(\frac{KL}{r}\right)^2}; \quad K = 1.0 \\ &= \frac{\pi^2 (29)(10^3)}{\left[\frac{1.0 (120)}{0.644}\right]^2} = 8.243 \text{ ksi} < \sigma_y \quad \text{OK} \end{aligned}$$

$$P_{cr} = \sigma_{cr} A = 8.243 (2.48) = 20.4 \text{ kip} \quad \text{Ans}$$

From *Mechanics of Materials*, Sixth Edition by R. C. Hibbeler, ISBN 0-13-191345-X.

© 2005 R. C. Hibbeler. Published by Pearson Prentice Hall,

Pearson Education, Inc., Upper Saddle River, NJ. All rights reserved.

This material is protected under all copyright laws as they currently exist. No portion of this material may be reproduced, in any form or by any means, without permission in writing from the publisher.

*13-12 Determine the maximum force P that can be applied to the handle so that the A-36 steel control rod AB does not buckle. The rod has a diameter of 1.25 in. It is pin connected at its ends.

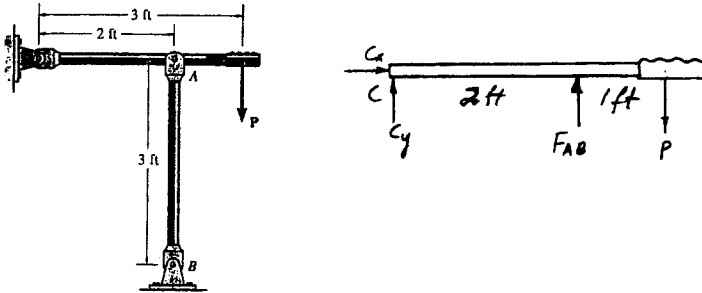

$$\begin{aligned} (+ \Sigma M_C = 0; \quad F_{AB}(2) - P(3) &= 0 \\ P &= \frac{2}{3}F_{AB} \end{aligned} \quad (1)$$

Buckling load for rod AB :

$$I = \frac{\pi}{4} (0.625^4) = 0.1198 \text{ in}^4$$

$$A = \pi (0.625^2) = 1.2272 \text{ in}^2$$

$$P_{cr} = \frac{\pi^2 EI}{(KL)^2}$$

$$F_{AB} = P_{cr} = \frac{\pi^2 (29)(10^3)(0.1198)}{[1.0(3)(12)]^2} = 26.46 \text{ kip}$$

From Eq. (1)

$$P = \frac{2}{3} (26.46) = 17.6 \text{ kip} \quad \text{Ans}$$

Check :

$$\sigma_{cr} = \frac{P_{cr}}{A} = \frac{26.46}{1.2272} = 21.6 \text{ ksi} < \sigma_Y \text{ OK}$$

Therefore, Euler's formula is valid.

From *Mechanics of Materials*, Sixth Edition by R. C. Hibbeler, ISBN 0-13-191345-X.

© 2005 R. C. Hibbeler. Published by Pearson Prentice Hall,

Pearson Education, Inc., Upper Saddle River, NJ. All rights reserved.

This material is protected under all copyright laws as they currently exist. No portion of this material may be reproduced, in any form or by any means, without permission in writing from the publisher.

13-13 The two steel channels are to be laced together to form a 30-ft-long bridge column assumed to be pin connected at its ends. Each channel has a cross-sectional area of $A = 3.10 \text{ in}^2$ and moments of inertia $I_x = 55.4 \text{ in}^4$, $I_y = 0.382 \text{ in}^4$. The centroid C of its area is located in the figure. Determine the proper distance d between the centroids of the channels so that buckling occurs about the $x-x$ and $y'-y'$ axes due to the same load. What is the value of this critical load? Neglect the effect of the lacing. $E_{st} = 29(10^3) \text{ ksi}$, $\sigma_Y = 50 \text{ ksi}$.

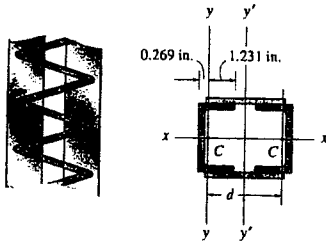

$$I_x = 2(55.4) = 110.8 \text{ in}^4$$

$$I_y = 2(0.382) + 2(3.10)\left(\frac{d}{2}\right)^2 = 0.764 + 1.55d^2$$

In order for the column to buckle about $x-x$ and $y-y$ axes at the same time, I_y must be equal to I_x

$$I_y = I_x$$

$$0.764 + 1.55d^2 = 110.8$$

$$d = 8.43 \text{ in.}$$

Ans

Check :

$$d > 2(1.231) = 2.462 \text{ in. OK}$$

$$P_{cr} = \frac{\pi^2 EI}{(KL)^2} = \frac{\pi^2 (29)(10^3)(110.8)}{[1.0(360)]^2}$$

$$= 245 \text{ kip}$$

Ans

Check stress :

$$\sigma_{cr} = \frac{P_{cr}}{A} = \frac{245}{2(3.10)} = 39.5 \text{ ksi} < \sigma_Y$$

Therefore, Euler's formula is valid.

From *Mechanics of Materials*, Sixth Edition by R. C. Hibbeler, ISBN 0-13-191345-X.

© 2005 R. C. Hibbeler. Published by Pearson Prentice Hall,

Pearson Education, Inc., Upper Saddle River, NJ. All rights reserved.

This material is protected under all copyright laws as they currently exist. No portion of this material may be reproduced, in any form or by any means, without permission in writing from the publisher.

13-14 A column is constructed using four A-36 steel angles that are laced together as shown in Prob. 13-13. The length of the column is to be 25 ft and the ends are assumed to be pin connected. Each angle shown below has an area of $A = 2.75 \text{ in}^2$ and moments of inertia of $I_x = I_y = 2.22 \text{ in}^4$. Determine the distance d between the centroids C of the angles so that the column can support an axial load of $P = 350 \text{ kip}$ without buckling. Neglect the effect of the lacing.

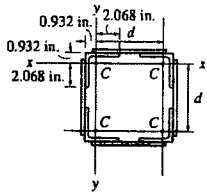

$$I_x = I_y = 4 \left[2.22 + 2.75 \left(\frac{d}{2} \right)^2 \right] = 8.88 + 2.75 d^2$$

$$\sigma_{cr} = \frac{P_{cr}}{A} = \frac{350}{4(2.75)} = 31.8 \text{ ksi} < \sigma_y \quad \text{OK}$$

Therefore, Euler's formula is valid.

$$P_{cr} = \frac{\pi^2 E I}{(K L)^2}$$

$$350 = \frac{\pi^2 (29)(10^3)(8.88 + 2.75 d^2)}{[1.0 (300)]^2}$$

$$d = 6.07 \text{ in.} \quad \text{Ans}$$

Check dimension :

$$d > 2 (2.068) = 4.136 \text{ in.} \quad \text{OK}$$

From *Mechanics of Materials*, Sixth Edition by R. C. Hibbeler, ISBN 0-13-191345-X.

© 2005 R. C. Hibbeler. Published by Pearson Prentice Hall,

Pearson Education, Inc., Upper Saddle River, NJ. All rights reserved.

This material is protected under all copyright laws as they currently exist. No portion of this material may be reproduced, in any form or by any means, without permission in writing from the publisher.

13-15 . A column is constructed using four A-36 steel angles that are laced together as shown in Prob. 13-13. The length of the column is to be 40 ft and the ends are assumed to be fixed connected. Each angle shown below has an area of $A = 2.75 \text{ in}^2$ and moments of inertia of $I_x = I_y = 2.22 \text{ in}^4$. Determine the distance d between the centroids C of the angles so that the column can support an axial load of $P = 350 \text{ kip}$ without buckling. Neglect the effect of the lacing.

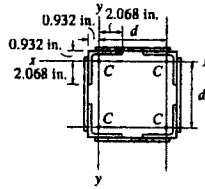

$$I_x = I_y = 4 \left[2.22 + 2.75 \left(\frac{d}{2} \right)^2 \right] = 8.88 + 2.75 d^2$$

$$\sigma_{cr} = \frac{P_{cr}}{A} = \frac{350}{4(2.75)} = 31.8 \text{ ksi} < \sigma_y \quad \text{OK}$$

Therefore, Euler's formula is valid.

$$P_{cr} = \frac{\pi^2 E I}{(K L)^2} ; \quad 350 = \frac{\pi^2 (29)(10^3)(8.88 + 2.75 d^2)}{[0.5 (12)(40)]^2}$$

$$d = 4.73 \text{ in.} \quad \text{Ans}$$

Check dimension :

$$d > 2 (2.068) = 4.136 \text{ in.} \quad \text{OK}$$

From *Mechanics of Materials*, Sixth Edition by R. C. Hibbeler, ISBN 0-13-191345-X.

© 2005 R. C. Hibbeler. Published by Pearson Prentice Hall,

Pearson Education, Inc., Upper Saddle River, NJ. All rights reserved.

This material is protected under all copyright laws as they currently exist. No portion of this material may be reproduced, in any form or by any means, without permission in writing from the publisher.

***13-16.** The $W12 \times 87$ structural A-36 steel column has a length of 12 ft. If its bottom end is fixed supported while its top is free, and it is subjected to an axial load of $P = 380$ kip, determine the factor of safety with respect to buckling.



$$W 12 \times 87 \quad A = 25.6 \text{ in}^2 \quad I_x = 740 \text{ in}^4 \quad I_y = 241 \text{ in}^4 \text{ (controls)}$$

$$K = 2.0$$

$$P_{cr} = \frac{\pi^2 EI}{(KL)^2} = \frac{\pi^2 (29)(10^3)(241)}{[(2.0)(12)(12)]^2} = 831.63 \text{ kip}$$

$$\text{F.S.} = \frac{P_{cr}}{P} = \frac{831.63}{380} = 2.19 \quad \text{Ans}$$

Check :

$$\begin{aligned} \sigma_{cr} &= \frac{P_{cr}}{A} \\ &= \frac{831.63}{25.6} = 32.5 \text{ ksi} < \sigma_y \quad \text{OK} \end{aligned}$$

From *Mechanics of Materials*, Sixth Edition by R. C. Hibbeler, ISBN 0-13-191345-X.

© 2005 R. C. Hibbeler. Published by Pearson Prentice Hall,

Pearson Education, Inc., Upper Saddle River, NJ. All rights reserved.

This material is protected under all copyright laws as they currently exist. No portion of this material may be reproduced, in any form or by any means, without permission in writing from the publisher.

13-17. The $W12 \times 87$ structural A-36 steel column has a length of 12 ft. If its bottom end is fixed supported while its top is free, determine the largest axial load it can support. Use a factor of safety with respect to buckling of 1.75.



$$W12 \times 87 \quad A = 25.6 \text{ in}^2 \quad I_x = 740 \text{ in}^4 \quad I_y = 241 \text{ in}^4 \quad (\text{controls})$$

$$K = 2.0$$

$$P_{cr} = \frac{\pi^2 EI}{(KL)^2} = \frac{\pi^2 (29)(10^3)(241)}{(2.0(12)(12))^2} = 831.63 \text{ kip}$$

$$P = \frac{P_{cr}}{F.S.} = \frac{831.63}{1.75} = 475 \text{ kip} \quad \text{Ans}$$

Check :

$$\sigma_{cr} = \frac{P}{A} = \frac{475}{25.6} = 18.6 \text{ ksi} < \sigma_y \quad \text{OK}$$

From *Mechanics of Materials*, Sixth Edition by R. C. Hibbeler, ISBN 0-13-191345-X.

© 2005 R. C. Hibbeler. Published by Pearson Prentice Hall,

Pearson Education, Inc., Upper Saddle River, NJ. All rights reserved.

This material is protected under all copyright laws as they currently exist. No portion of this material may be reproduced, in any form or by any means, without permission in writing from the publisher.

13-18. The 12-ft A-36 steel pipe column has an outer diameter of 3 in. and a thickness of 0.25 in. Determine the critical load if the ends are assumed to be pin connected.

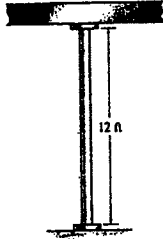

$$A = \pi(1.5^2 - 1.25^2) = 2.1598 \text{ in}^2$$

$$I = \frac{\pi}{4}(1.5^4 - 1.25^4) = 2.0586 \text{ in}^4$$

$$K = 1.0$$

$$P_{cr} = \frac{\pi^2 EI}{(KL)^2} = \frac{\pi^2 (29)(10^3)(2.0586)}{[(1.0)(12)(12)]^2} = 28.4 \text{ kip} \quad \text{Ans}$$

Check :

$$\sigma_{cr} = \frac{P_{cr}}{A} = \frac{28.4}{2.1598} = 13.1 \text{ ksi} < \sigma_y \quad \text{OK}$$

From *Mechanics of Materials*, Sixth Edition by R. C. Hibbeler, ISBN 0-13-191345-X.

© 2005 R. C. Hibbeler. Published by Pearson Prentice Hall,

Pearson Education, Inc., Upper Saddle River, NJ. All rights reserved.

This material is protected under all copyright laws as they currently exist. No portion of this material may be reproduced, in any form or by any means, without permission in writing from the publisher.

13-19. The 12-ft A-36 steel column has an outer diameter of 3 in. and a thickness of 0.25 in. Determine the critical load if the bottom is fixed and the top is pinned.

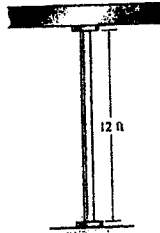

$$A = \pi(1.5^2 - 1.25^2) = 2.1598 \text{ in}^2$$

$$I = \frac{\pi}{4}(1.5^4 - 1.25^4) = 2.0586 \text{ in}^4$$

$$K = 0.7$$

$$P_{cr} = \frac{\pi^2 EI}{(KL)^2} = \frac{\pi^2 (29)(10^3)(2.0586)}{[(0.7)(12)(12)]^2} = 58.0 \text{ kip} \quad \text{Ans}$$

Check :

$$\sigma_{cr} = \frac{P_{cr}}{A} = \frac{58.0}{2.1598} = 26.8 \text{ ksi} < \sigma_Y \quad \text{OK}$$

From *Mechanics of Materials*, Sixth Edition by R. C. Hibbeler, ISBN 0-13-191345-X.

© 2005 R. C. Hibbeler. Published by Pearson Prentice Hall,

Pearson Education, Inc., Upper Saddle River, NJ. All rights reserved.

This material is protected under all copyright laws as they currently exist. No portion of this material may be reproduced, in any form or by any means, without permission in writing from the publisher.

***13-20.** The A-36 steel pipe has an outer diameter of 2 in. and a thickness of 0.5 in. If it is held in place by a guywire, determine the largest horizontal force P that can be applied without causing the pipe to buckle. Assume that the ends of the pipe are pin connected.

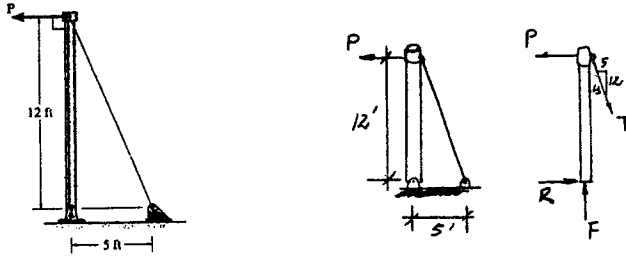

$$\begin{aligned} \rightarrow \Sigma F_x &= 0; & \frac{5}{13}T - P &= 0 \\ & & T &= \frac{13}{5}P \\ + \uparrow \Sigma F_y &= 0; & F - \frac{12}{13}T &= 0 \\ & & F &= \frac{12}{13} \left(\frac{13}{5}P \right) = \frac{12}{5}P \end{aligned}$$

Buckling Load :

$$\begin{aligned} A &= \pi(1^2 - 0.5^2) = 2.356 \text{ in}^2 \\ I &= \frac{\pi}{4}(1^4 - 0.5^4) = 0.7363 \text{ in}^4 \\ K &= 1.0 \\ P_{cr} &= \frac{\pi^2 EI}{(KL)^2} \\ F &= \frac{12}{5}P = \frac{\pi^2(29)(10^3)(0.7363)}{[(1.0)(12)(12)]^2} \end{aligned}$$

$$\begin{aligned} P &= 4.23 \text{ kip} \quad \text{Ans} \\ P_{cr} = F &= 10.16 \text{ kip} \end{aligned}$$

Check :

$$\sigma_{cr} = \frac{P_{cr}}{A} = \frac{10.16}{2.356} = 4.31 \text{ ksi} < \sigma_Y \quad \text{OK}$$

From *Mechanics of Materials*, Sixth Edition by R. C. Hibbeler, ISBN 0-13-191345-X.

© 2005 R. C. Hibbeler. Published by Pearson Prentice Hall,

Pearson Education, Inc., Upper Saddle River, NJ. All rights reserved.

This material is protected under all copyright laws as they currently exist. No portion of this material may be reproduced, in any form or by any means, without permission in writing from the publisher.

13-21. The A-36 steel pipe has an outer diameter of 2 in. If it is held in place by a guywire, determine the pipe's required inner diameter to the nearest $\frac{1}{8}$ in., so that it can support a maximum horizontal load of $P = 4$ kip without causing the pipe to buckle. Assume the ends of the pipe are pin connected

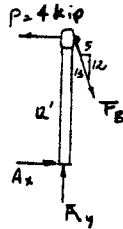
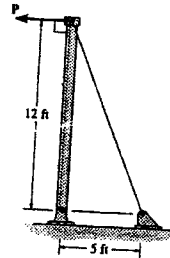

$$\begin{aligned} \curvearrowleft + \Sigma M_A = 0; & \quad 4(12) - F_B\left(\frac{5}{13}\right)(12) = 0 \\ & \quad F_B = 10.4 \text{ kip} \\ + \uparrow \Sigma F_y = 0; & \quad A_y - 10.4\left(\frac{12}{13}\right) = 0 \\ & \quad A_y = 9.60 \text{ kip} \end{aligned}$$

Section properties :

$$A = \frac{\pi}{4}(2^2 - d^2); \quad I = \frac{\pi}{4}\left(1^4 - \frac{d^4}{16}\right)$$

Critical load :

$$P_{cr} = \frac{\pi^2 EI}{(KL)^2}; \quad \text{where } K = 1.0$$

$$9.60 = \frac{\pi^2 (29)(10^3)\left(\frac{\pi}{4}\right)\left(1^4 - \frac{d^4}{16}\right)}{(1.0(12)(12))^2}$$

$$d = 1.163 \text{ in.}$$

Check critical stress :

$$\sigma_{cr} = \frac{P_{cr}}{A} = \frac{9.60}{\frac{\pi}{4}(2^2 - (1.163)^2)} = 4.62 \text{ ksi} < \sigma_Y \quad \text{OK}$$

Hence, Euler's equation is still valid.

$$\text{Use } d = 1\frac{1}{8} \text{ in.} \quad \text{Ans}$$

From *Mechanics of Materials*, Sixth Edition by R. C. Hibbeler, ISBN 0-13-191345-X.

© 2005 R. C. Hibbeler. Published by Pearson Prentice Hall,

Pearson Education, Inc., Upper Saddle River, NJ. All rights reserved.

This material is protected under all copyright laws as they currently exist. No portion of this material may be reproduced, in any form or by any means, without permission in writing from the publisher.

13-22 The members of the truss are assumed to be pin connected. If member BD is an A-36 steel rod of radius 2 in., determine the maximum load P that can be supported by the truss without causing the member to buckle.

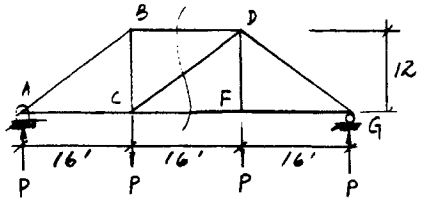
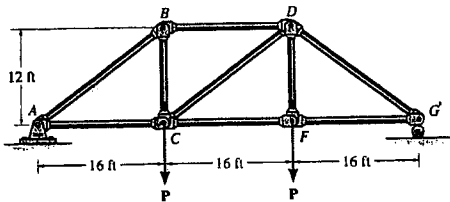

$$\begin{aligned} \curvearrow + \sum M_C = 0; \quad F_{BD}(12) - P(16) &= 0 \\ F_{BD} &= \frac{4}{3}P \end{aligned}$$

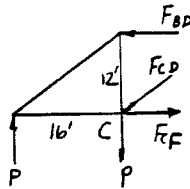

Buckling Load :

$$\begin{aligned} A &= \pi(2^2) = 12.56 \text{ in}^2 \\ I &= \frac{\pi(2^4)}{4} = 4\pi \text{ in}^4 \\ L &= 16(12) = 192 \text{ in.} \\ K &= 1.0 \\ P_{cr} &= \frac{\pi^2 EI}{(KL)^2} \\ F_{BD} = \frac{4}{3}P &= \frac{\pi^2(29)(10^3)(4\pi)}{[(1.0)(192)]^2} \end{aligned}$$

$$\begin{aligned} P &= 73.2 \text{ kip} \quad \text{Ans} \\ P_{cr} = F_{BD} &= 97.56 \text{ kip} \end{aligned}$$

Check :

$$\sigma_{cr} = \frac{P_{cr}}{A} = \frac{97.56}{12.56} = 7.76 \text{ ksi} < \sigma_Y \quad \text{OK}$$

From *Mechanics of Materials*, Sixth Edition by R. C. Hibbeler, ISBN 0-13-191345-X.

© 2005 R. C. Hibbeler. Published by Pearson Prentice Hall,

Pearson Education, Inc., Upper Saddle River, NJ. All rights reserved.

This material is protected under all copyright laws as they currently exist. No portion of this material may be reproduced, in any form or by any means, without permission in writing from the publisher.

13-23 Solve Prob. 13-22 in the case of member AB , which has a radius of 2 in.

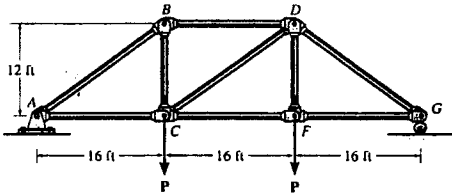

$$+\uparrow \Sigma F_y = 0; \quad P - \frac{3}{5}F_{AB} = 0$$

$$F_{AB} = 1.667 P$$

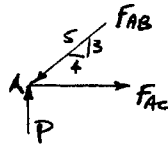

Buckling load :

$$A = \pi (2)^2 = 12.57 \text{ in}^2$$

$$I = \frac{\pi (2)^4}{4} = 4\pi \text{ in}^4$$

$$L = 20(12) = 240 \text{ in.}$$

$$K = 1.0$$

$$P_{cr} = \frac{\pi^2 EI}{(KL)^2} = \frac{\pi^2 (29)(10^3)(4\pi)}{(1.0(240))^2} = 62.443 \text{ kip}$$

$$P_{cr} = F_{AB} = 1.667 P = 62.443$$

$$P = 37.5 \text{ kip} \quad \text{Ans}$$

Check :

$$\sigma_{cr} = \frac{P}{A} = \frac{37.5}{12.57} = 2.98 \text{ ksi} < \sigma_y \quad \text{OK}$$

From *Mechanics of Materials*, Sixth Edition by R. C. Hibbeler, ISBN 0-13-191345-X.

© 2005 R. C. Hibbeler. Published by Pearson Prentice Hall,

Pearson Education, Inc., Upper Saddle River, NJ. All rights reserved.

This material is protected under all copyright laws as they currently exist. No portion of this material may be reproduced, in any form or by any means, without permission in writing from the publisher.

***13-24.** The truss is made from A-36 steel bars, each of which has a circular cross section with a diameter of 1.5 in. Determine the maximum force P that can be applied without causing any of the members to buckle. The members are pin connected at their ends.

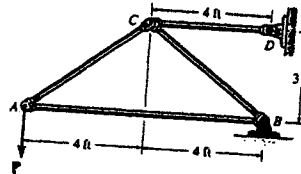

$$I = \frac{\pi}{4}(0.75^4) = 0.2485 \text{ in}^4$$

$$A = \pi(0.75^2) = 1.7671 \text{ in}^2$$

Members AB and BC are in compression :

Joint A :

$$+\uparrow \Sigma F_y = 0; \quad \frac{3}{5}F_{AC} - P = 0$$

$$F_{AC} = \frac{5P}{3}$$

$$+\leftarrow \Sigma F_x = 0; \quad F_{AB} - \frac{4}{5}\left(\frac{5P}{3}\right) = 0$$

$$F_{AB} = \frac{4P}{3}$$

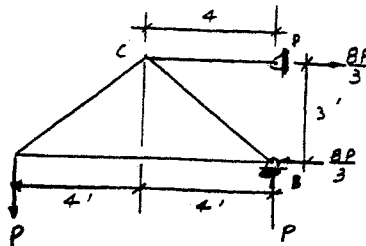

Joint B :

$$+\rightarrow \Sigma F_x = 0; \quad \frac{4}{5}F_{BC} + \frac{4P}{3} - \frac{8P}{3} = 0$$

$$F_{BC} = \frac{5P}{3}$$

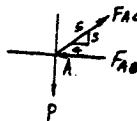

Failure of rod AB :

$$K = 1.0 \quad L = 8(12) = 96 \text{ in.}$$

$$P_{cr} = \frac{\pi^2 EI}{(KL)^2}$$

$$F_{AB} = \frac{4P}{3} = \frac{\pi^2(29)(10^3)(0.2485)}{((1.0)(96))^2}$$

$$P = 5.79 \text{ kip} \quad (\text{controls}) \quad \text{Ans}$$

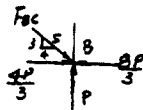

Check :

$$P_{cr} = F_{AB} = 7.72 \text{ kip}$$

$$\sigma_{cr} = \frac{P_{cr}}{A} = \frac{7.72}{1.7671} = 4.36 \text{ ksi} < \sigma_y \quad \text{OK}$$

rod BC :

$$L = 5(12) = 60 \text{ in.}$$

$$P_{cr} = \frac{\pi^2(29)(10^3)(0.2485)}{((1.0)(60))^2}$$

$$7.9 \text{ kip}$$

From *Mechanics of Materials*, Sixth Edition by R. C. Hibbeler, ISBN 0-13-191345-X.

© 2005 R. C. Hibbeler. Published by Pearson Prentice Hall,

Pearson Education, Inc., Upper Saddle River, NJ. All rights reserved.

This material is protected under all copyright laws as they currently exist. No portion of this material may be reproduced, in any form or by any means, without permission in writing from the publisher.

13-25. The truss is made from A-36 steel bars, each of which has a circular cross section. If the applied load $P = 10$ kip, determine the diameter of member AB to the nearest $\frac{1}{8}$ in. that will prevent this member from buckling. The members are pin supported at their ends.

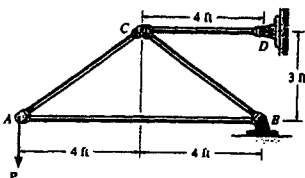

Joint A :

$$+\uparrow \Sigma F_y = 0; \quad -10 + F_{AC}\left(\frac{3}{5}\right) = 0; \quad F_{AC} = 16.667 \text{ kip}$$

$$\rightarrow \Sigma F_x = 0; \quad -F_{AB} + 16.667\left(\frac{4}{5}\right) = 0; \quad F_{AB} = 13.33 \text{ kip}$$

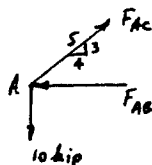

$$P_{cr} = \frac{\pi^2 EI}{(KL)^2}$$

$$13.33 = \frac{\pi^2 (29)(10^3)\left(\frac{\pi}{4}\right)(r)^4}{(1.0)(8)(12)^2}$$

$$r = 0.8599 \text{ in.}$$

$$d = 2r = 1.72 \text{ in.}$$

Use :

$$d = 1\frac{3}{4} \text{ in.} \quad \text{Ans}$$

Check :

$$\sigma_{cr} = \frac{P_{cr}}{A} = \frac{13.33}{\frac{\pi}{4}(1.75)^2} = 5.54 \text{ ksi} < \sigma_y \quad \text{OK}$$

From *Mechanics of Materials*, Sixth Edition by R. C. Hibbeler, ISBN 0-13-191345-X.

© 2005 R. C. Hibbeler. Published by Pearson Prentice Hall,

Pearson Education, Inc., Upper Saddle River, NJ. All rights reserved.

This material is protected under all copyright laws as they currently exist. No portion of this material may be reproduced, in any form or by any means, without permission in writing from the publisher.

13-26 The control linkage for a machine consists of two L2 steel rods BE and FG , each with a diameter of 1 in. If a device at G causes the end G to freeze up and become pin-connected, determine the maximum horizontal force P that can be applied to the handle without causing either of the two rods to buckle. The members are pin connected at A , B , D , E , and F .

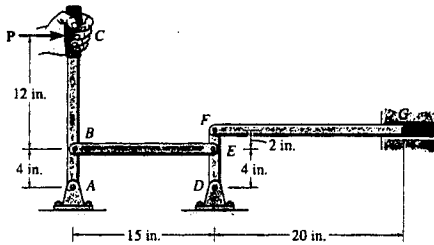

$$\begin{aligned} (+\Sigma M_A = 0; \quad F_{BE}(4) - P(16) &= 0 \\ F_{BE} &= 4P \end{aligned}$$

$$\begin{aligned} (+\Sigma M_D = 0; \quad F_{FG}(6) - 4P(4) &= 0 \\ F_{FG} &= 2.6667P \end{aligned}$$

For rod BE ,

$$P_{cr} = \frac{\pi^2 EI}{(KL)^2}; \quad K = 1.0$$

$$4P = \frac{\pi^2 (29)(10^3)(\frac{\pi}{4})(0.5^4)}{[1.0(15)]^2}$$

$$P = 15.6 \text{ kip}$$

Check stress :

$$\sigma_{cr} = \frac{P_{cr}}{A} = \frac{4(15.6)}{\frac{\pi}{4}(1^2)} = 79.5 \text{ ksi} < \sigma_y = 102 \text{ ksi} \quad \text{OK}$$

For rod FG :

$$P_{cr} = \frac{\pi^2 EI}{(KL)^2}; \quad K = 1.0$$

$$2.6667P = \frac{\pi^2 [(29)(10^3)]\frac{\pi}{4}(0.5^4)}{[1.0(20)]^2}$$

$$P = 13.2 \text{ kip} \quad (\text{controls}) \quad \text{Ans}$$

Check stress :

$$\sigma_{cr} = \frac{P_{cr}}{A} = \frac{2.6667(13.2)}{\frac{\pi}{4}(1^2)} = 44.7 \text{ ksi} < \sigma_y = 102 \text{ ksi} \quad \text{OK}$$

Hence, Euler's equation is still valid.

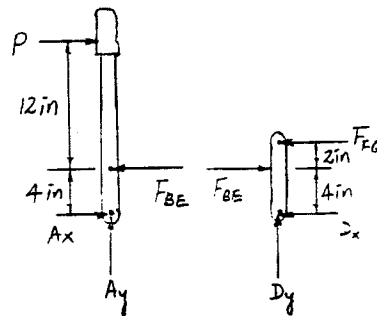

From *Mechanics of Materials*, Sixth Edition by R. C. Hibbeler, ISBN 0-13-191345-X.

© 2005 R. C. Hibbeler. Published by Pearson Prentice Hall,

Pearson Education, Inc., Upper Saddle River, NJ. All rights reserved.

This material is protected under all copyright laws as they currently exist. No portion of this material may be reproduced, in any form or by any means, without permission in writing from the publisher.

13-27 The linkage is made using two A-36 steel rods, each having a circular cross section. Determine the diameter of each rod to the nearest $\frac{1}{8}$ in. that will support a load of $P = 6$ kip. Assume that the rods are pin connected at their ends. Use a factor of safety with respect to buckling of 1.8.

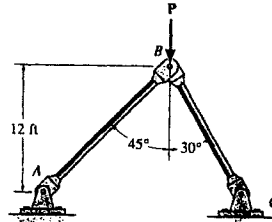

$$I = \frac{\pi}{4} \left(\frac{d}{2}\right)^4 = \frac{\pi d^4}{64}$$

Joint B :

$$\begin{aligned} \rightarrow \Sigma F_x = 0; \quad F_{AB} \cos 45^\circ - F_{BC} \sin 30^\circ &= 0 \\ F_{AB} &= 0.7071 F_{BC} \quad (1) \\ + \uparrow \Sigma F_y = 0; \quad F_{AB} \sin 45^\circ + F_{BC} \cos 30^\circ - 6 &= 0 \quad (2) \end{aligned}$$

Solving Eqs. (1) and (2) yields :

$$F_{BC} = 4.392 \text{ kip} \quad F_{AB} = 3.106 \text{ kip}$$

For rod AB :

$$P_{cr} = 3.106 (1.8) = 5.591 \text{ kip}$$

$$K = 1.0 \quad L_{AB} = \frac{12(12)}{\cos 45^\circ} = 203.64 \text{ in.}$$

$$P_{cr} = \frac{\pi^2 EI}{(KL)^2}$$

$$5.591 = \frac{\pi^2 (29)(10^3) \left(\frac{\pi d_{AB}^4}{64}\right)}{[(1.0)(203.64)]^2}$$

$$d_{AB} = 2.015 \text{ in.} \quad \text{Use } d_{AB} = 2\frac{1}{8} \text{ in.} \quad \text{Ans}$$

Check :

$$\sigma_{cr} = \frac{P_{cr}}{A} = \frac{5.591}{\frac{\pi}{4}(2.125^2)} = 1.58 \text{ ksi} < \sigma_r \quad \text{OK}$$

For rod BC :

$$P_{cr} = 4.392 (1.8) = 7.9056 \text{ kip}$$

$$K = 1.0 \quad L_{BC} = \frac{12(12)}{\cos 30^\circ} = 166.28 \text{ in.}$$

$$P_{cr} = \frac{\pi^2 EI}{(KL)^2}$$

$$7.9056 = \frac{\pi^2 (29)(10^3) \left(\frac{\pi d_{BC}^4}{64}\right)}{[(1.0)(166.28)]^2}$$

$$d_{BC} = 1.986 \text{ in.}$$

Use $d_{BC} = 2$ in. Ans

Check :

$$\sigma_{cr} = \frac{P_{cr}}{A} = \frac{7.9056}{\frac{\pi}{4}(2^2)} = 2.52 \text{ ksi} < \sigma_r \quad \text{OK}$$

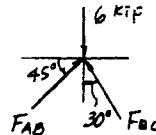

From *Mechanics of Materials*, Sixth Edition by R. C. Hibbeler, ISBN 0-13-191345-X.

© 2005 R. C. Hibbeler. Published by Pearson Prentice Hall,

Pearson Education, Inc., Upper Saddle River, NJ. All rights reserved.

This material is protected under all copyright laws as they currently exist. No portion of this material may be reproduced, in any form or by any means, without permission in writing from the publisher.

***13-28.** The linkage is made using two A-36 steel rods, each having a circular cross section. If each rod has a diameter of $\frac{3}{4}$ in., determine the largest load it can support without causing any rod to buckle. Assume that the rods are pin-connected at their ends.

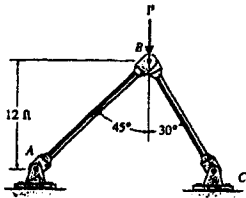

$$\begin{aligned} \rightarrow \Sigma F_x = 0; & \quad F_{AB} \sin 45^\circ - F_{BC} \sin 30^\circ = 0 \\ + \uparrow \Sigma F_y = 0; & \quad F_{AB} \cos 45^\circ - F_{BC} \cos 30^\circ - P = 0 \end{aligned}$$

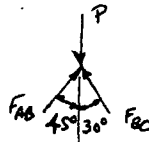

$$\begin{aligned} F_{AB} &= 0.5176 P \\ F_{BC} &= 0.73205 P \end{aligned}$$

$$L_{AB} = \frac{12}{\cos 45^\circ} = 16.971 \text{ ft}$$

$$L_{BC} = \frac{12}{\cos 30^\circ} = 13.856 \text{ ft}$$

Assume rod AB buckles :

$$\begin{aligned} P_{cr} &= \frac{\pi^2 EI}{(KL)^2} \\ 0.5176 P &= \frac{\pi^2 (29)(10^6) \left(\frac{\pi}{4}\right) \left(\frac{3}{8}\right)^4}{(1.0)(16.971)(12)^2} \\ P &= 207 \text{ lb} \quad (\text{controls}) \quad \text{Ans} \end{aligned}$$

$$\sigma_{cr} = \frac{P_{cr}}{A} = \frac{207}{\pi \left(\frac{3}{8}\right)^2} = 469 \text{ psi} < \sigma_Y \quad \text{OK}$$

Assume rod BC buckles :

$$\begin{aligned} 0.73205 P &= \frac{\pi^2 (29)(10^6) \left(\frac{\pi}{4}\right) \left(\frac{3}{8}\right)^4}{(1.0)(13.856)(12)^2} \\ P &= 220 \text{ lb} \end{aligned}$$

From *Mechanics of Materials*, Sixth Edition by R. C. Hibbeler, ISBN 0-13-191345-X.

© 2005 R. C. Hibbeler. Published by Pearson Prentice Hall,

Pearson Education, Inc., Upper Saddle River, NJ. All rights reserved.

This material is protected under all copyright laws as they currently exist. No portion of this material may be reproduced, in any form or by any means, without permission in writing from the publisher.

13-29 The frame supports the load of $P = 4$ kN. As a result, the A-36 steel member BC is subjected to a compressive load. Due to the forked ends on this member, consider the supports at B and C to act as pins for $x-x$ axis buckling and as fixed supports for $y-y$ axis buckling. Determine the factor of safety with respect to buckling about each of these axes.

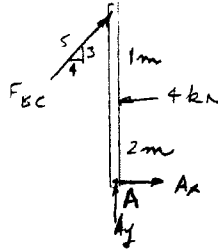
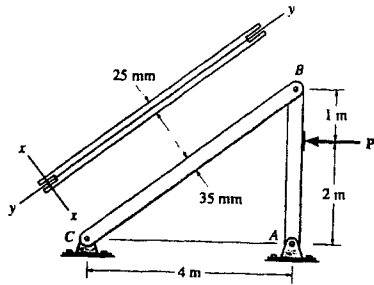

$$\begin{aligned} \curvearrowright + \Sigma M_A = 0; \quad 4(2) - F_{BC}\left(\frac{4}{5}\right)(3) &= 0 \\ F_{BC} &= 3.333 \text{ kN} \end{aligned}$$

$x-x$ axis buckling :

$$P_{cr} = \frac{\pi^2 EI}{(KL)^2} = \frac{\pi^2(200)(10^9)\left(\frac{1}{12}\right)(0.025)(0.035)^3}{(1.0(5))^2} = 7.053 \text{ kN}$$

$$\text{F.S.} = \frac{7.053}{3.333} = 2.12 \quad \text{Ans}$$

$y-y$ axis buckling :

$$P_{cr} = \frac{\pi^2 EI}{(KL)^2} = \frac{\pi^2(200)(10^9)\left(\frac{1}{12}\right)(0.035)(0.025)^3}{(0.5(5))^2} = 14.39 \text{ kN}$$

$$\text{F.S.} = \frac{14.39}{3.333} = 4.32 \quad \text{Ans}$$

From *Mechanics of Materials*, Sixth Edition by R. C. Hibbeler, ISBN 0-13-191345-X.

© 2005 R. C. Hibbeler. Published by Pearson Prentice Hall,

Pearson Education, Inc., Upper Saddle River, NJ. All rights reserved.

This material is protected under all copyright laws as they currently exist. No portion of this material may be reproduced, in any form or by any means, without permission in writing from the publisher.

13-30 Determine the greatest load P the frame will support without causing the A-36 steel member BC to buckle. Due to the forked ends on the member, consider the supports at B and C to act as pins for $x-x$ axis buckling and as fixed supports for $y-y$ axis buckling.

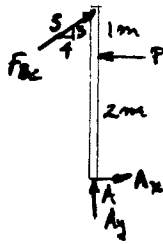
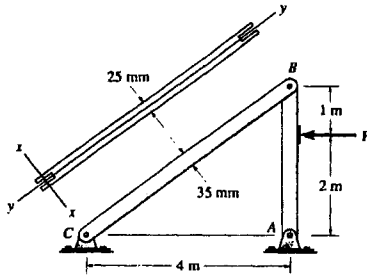

$$\begin{aligned} \sum M_A = 0; \quad P(2) - 3\left(\frac{4}{5}\right)F_{BC} &= 0 \\ F_{BC} &= 0.8333 P \end{aligned}$$

$x-x$ axis buckling :

$$P_{cr} = \frac{\pi^2 EI}{(KL)^2} = \frac{\pi^2 (200)(10^9) \left(\frac{1}{12}\right) (0.025)(0.035)^3}{(1.0(5))^2} = 7.053 \text{ kN}$$

$y-y$ axis buckling :

$$P_{cr} = \frac{\pi^2 EI}{(KL)^2} = \frac{\pi^2 (200)(10^9) \left(\frac{1}{12}\right) (0.035)(0.025)^3}{(0.5(5))^2} = 14.39 \text{ kN}$$

Thus,

$$0.8333 P = 7.053$$

$$P = 8.46 \text{ kN} \quad \text{Ans}$$

From *Mechanics of Materials*, Sixth Edition by R. C. Hibbeler, ISBN 0-13-191345-X.

© 2005 R. C. Hibbeler. Published by Pearson Prentice Hall,

Pearson Education, Inc., Upper Saddle River, NJ. All rights reserved.

This material is protected under all copyright laws as they currently exist. No portion of this material may be reproduced, in any form or by any means, without permission in writing from the publisher.

13-31 The beam supports the load of $P = 6$ kip. As a result, the A-36 steel member BC is subjected to a compressive load. Due to the forked ends on the member, consider the supports at B and C to act as pins for $x-x$ axis buckling and as fixed supports for $y-y$ axis buckling. Determine the factor of safety with respect to buckling about each of these axes.

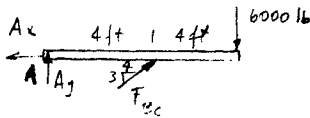
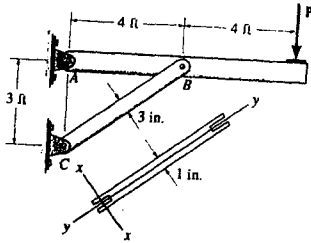

$$\begin{aligned} \sum M_A = 0; \quad F_{BC} \left(\frac{3}{5}\right)(4) - 6000(8) &= 0 \\ F_{BC} &= 20 \text{ kip} \end{aligned}$$

$x-x$ axis buckling :

$$P_{cr} = \frac{\pi^2 EI}{(KL)^2} = \frac{\pi^2 (29)(10^3) \left(\frac{1}{12}\right)(1)(3)^3}{(1.0(5)(12))^2} = 178.9 \text{ kip}$$

$$\text{F.S.} = \frac{178.9}{20} = 8.94 \quad \text{Ans}$$

$y-y$ axis buckling :

$$P_{cr} = \frac{\pi^2 EI}{(KL)^2} = \frac{\pi^2 (29)(10^3) \left(\frac{1}{12}\right)(3)(1)^3}{(0.5(5)(12))^2} = 79.51$$

$$\text{F.S.} = \frac{79.51}{20} = 3.98 \quad \text{Ans}$$

From *Mechanics of Materials*, Sixth Edition by R. C. Hibbeler, ISBN 0-13-191345-X.

© 2005 R. C. Hibbeler. Published by Pearson Prentice Hall,

Pearson Education, Inc., Upper Saddle River, NJ. All rights reserved.

This material is protected under all copyright laws as they currently exist. No portion of this material may be reproduced, in any form or by any means, without permission in writing from the publisher.

***13-32** Determine the greatest load P the frame will support without causing the A-36 steel member BC to buckle. Due to the forked ends on the member, consider the supports at B and C to act as pins for $x-x$ axis buckling and as fixed supports for $y-y$ axis buckling.

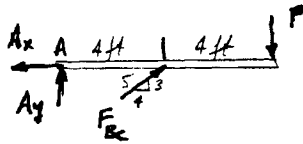
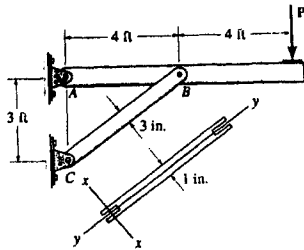

$$\begin{aligned} \circlearrowleft \Sigma M_A = 0; \quad F_{BC} \left(\frac{3}{5}\right)(4) - P(8) &= 0 \\ F_{BC} &= 3.33 P \end{aligned}$$

$x-x$ axis buckling :

$$P_{cr} = \frac{\pi^2 EI}{(KL)^2} = \frac{\pi^2 (29)(10^3) \left(\frac{1}{12}\right)(1)(3)^3}{(1.0)(5)(12)^2} = 178.9 \text{ kip}$$

$y-y$ axis buckling :

$$P_{cr} = \frac{\pi^2 EI}{(KL)^2} = \frac{\pi^2 (29)(10^3) \left(\frac{1}{12}\right)(3)(1)^3}{(0.5)(5)(12)^2} = 79.51 \text{ kip}$$

Thus,

$$3.33 P = 79.51$$

$$P = 23.9 \text{ kip} \quad \mathbf{Ans}$$

From *Mechanics of Materials*, Sixth Edition by R. C. Hibbeler, ISBN 0-13-191345-X.

© 2005 R. C. Hibbeler. Published by Pearson Prentice Hall,

Pearson Education, Inc., Upper Saddle River, NJ. All rights reserved.

This material is protected under all copyright laws as they currently exist. No portion of this material may be reproduced, in any form or by any means, without permission in writing from the publisher.

13-33 The steel bar AB of the frame is pin-connected at its ends. If $P = 18$ kN, determine the factor of safety with respect to buckling about the y - y axis due to the applied loading. $E_{st} = 200$ GPa, $\sigma_Y = 360$ MPa.

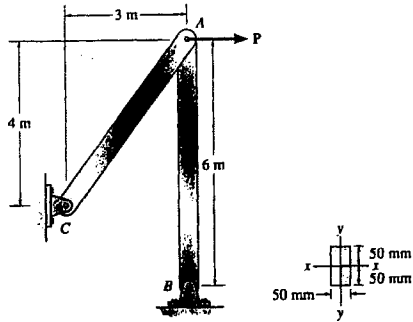

$$I_y = \frac{1}{12}(0.10)(0.05^3) = 1.04167 (10^{-6}) \text{ m}^4$$

Joint A :

$$\begin{aligned} \leftarrow \Sigma F_x = 0; \quad \frac{3}{5}F_{AC} - 18 &= 0 \\ F_{AC} &= 30 \text{ kN} \\ + \uparrow \Sigma F_y = 0; \quad F_{AB} - \frac{4}{5}(30) &= 0 \\ F_{AB} &= 24 \text{ kN} \end{aligned}$$

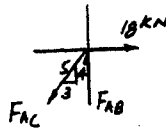

$$P_{cr} = \frac{\pi^2 EI}{(KL)^2} = \frac{\pi^2 (200)(10^9)(1.04167)(10^{-6})}{[(1.0)(6)]^2} = 57116 \text{ N} = 57.12 \text{ kN}$$

$$\text{F.S.} = \frac{P_{cr}}{F_{AB}} = \frac{57.12}{24} = 2.38 \quad \text{Ans}$$

Check :

$$\sigma_{cr} = \frac{P_{cr}}{A} = \frac{57.12 (10^3)}{0.1 (0.05)} = 11.4 \text{ MPa} < \sigma_Y \quad \text{OK}$$

From *Mechanics of Materials*, Sixth Edition by R. C. Hibbeler, ISBN 0-13-191345-X.

© 2005 R. C. Hibbeler. Published by Pearson Prentice Hall,

Pearson Education, Inc., Upper Saddle River, NJ. All rights reserved.

This material is protected under all copyright laws as they currently exist. No portion of this material may be reproduced, in any form or by any means, without permission in writing from the publisher.

13-34 Determine the maximum load P the frame can support without buckling member AB . Assume that AB is made of steel and is pinned at its ends for y - y axis buckling and fixed at its ends for x - x axis buckling. $E_{st} = 200$ GPa, $\sigma_Y = 360$ MPa.

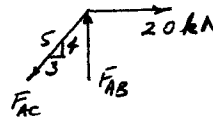
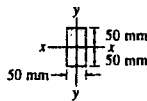
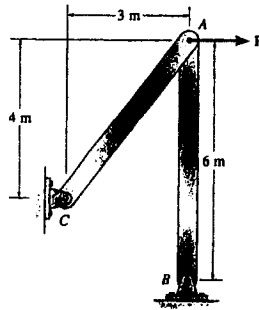

$$\rightarrow \Sigma F_x = 0; \quad -F_{AC}\left(\frac{3}{5}\right) + P = 0$$

$$F_{AC} = \frac{5}{3}P$$

$$+ \uparrow \Sigma F_y = 0; \quad F_{AB} - \frac{5}{3}P\left(\frac{4}{5}\right) = 0$$

$$F_{AB} = \frac{4}{3}P$$

$$I_y = \frac{1}{12}(0.10)(0.05)^3 = 1.04167(10^{-6})\text{m}^4$$

$$I_x = \frac{1}{12}(0.05)(0.10)^3 = 4.16667(10^{-6})\text{m}^4$$

$$P_{cr} = \frac{\pi^2 EI}{(KL)^2}$$

x - x axis buckling :

$$P_{cr} = \frac{\pi^2(200)(10^9)(4.16667)(10^{-6})}{(0.5(6))^2} = 914 \text{ kN}$$

y - y axis buckling :

$$P_{cr} = \frac{\pi^2(200)(10^9)(1.04167)(10^{-6})}{(1(6))^2} = 57.12 \text{ kN}$$

y - y axis buckling controls

$$\frac{4}{3}P = 57.12$$

$$P = 42.8 \text{ kN} \quad \text{Ans}$$

Check :

$$\sigma_{cr} = \frac{P}{A} = \frac{57.12(10^3)}{(0.1)(0.05)} = 11.4 \text{ MPa} < \sigma_Y \quad \text{OK}$$

From *Mechanics of Materials*, Sixth Edition by R. C. Hibbeler, ISBN 0-13-191345-X.

© 2005 R. C. Hibbeler. Published by Pearson Prentice Hall,

Pearson Education, Inc., Upper Saddle River, NJ. All rights reserved.

This material is protected under all copyright laws as they currently exist. No portion of this material may be reproduced, in any form or by any means, without permission in writing from the publisher.

13-35. The A-36 steel bar AB has a square cross section. If it is pin-connected at its ends, determine the maximum allowable load P that can be applied to the frame. Use a factor of safety with respect to buckling of 2.

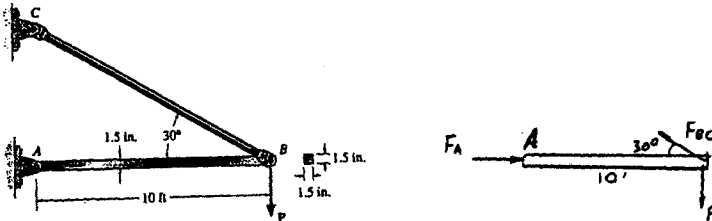

$$\begin{aligned}
 (+ \Sigma M_A = 0; & \quad F_{BC} \sin 30^\circ (10) - P (10) = 0 \\
 & \quad F_{BC} = 2P \\
 + \Sigma F_x = 0; & \quad F_A - 2P \cos 30^\circ = 0 \\
 & \quad F_A = 1.732P
 \end{aligned}$$

Buckling load :

$$P_{cr} = F_A(\text{F.S.}) = 1.732P(2) = 3.464P$$

$$L = 10(12) = 120 \text{ in.}$$

$$I = \frac{1}{12} (1.5)(1.5)^3 = 0.421875 \text{ in}^4$$

$$P_{cr} = \frac{\pi^2 EI}{(KL)^2}$$

$$3.464P = \frac{\pi^2 (29)(10^3)(0.421875)}{[(1.0)(120)]^2}$$

$$P = 2.42 \text{ kip} \quad \text{Ans}$$

$$P_{cr} = F_A(\text{F.S.}) = 1.732(2.42)(2) = 8.38 \text{ kip}$$

Check :

$$\sigma_{cr} = \frac{P_{cr}}{A} = \frac{8.38}{1.5(1.5)} = 3.72 \text{ ksi} < \sigma_Y \quad \text{OK}$$

From *Mechanics of Materials*, Sixth Edition by R. C. Hibbeler, ISBN 0-13-191345-X.

© 2005 R. C. Hibbeler. Published by Pearson Prentice Hall,

Pearson Education, Inc., Upper Saddle River, NJ. All rights reserved.

This material is protected under all copyright laws as they currently exist. No portion of this material may be reproduced, in any form or by any means, without permission in writing from the publisher.

*13-36 The steel bar AB has a rectangular cross section. If it is pin connected at its ends, determine the maximum allowable intensity w of the distributed load that can be applied to BC without causing bar AB to buckle. Use a factor of safety with respect to buckling of 1.5. $E_{st} = 200$ GPa, $\sigma_Y = 360$ MPa.

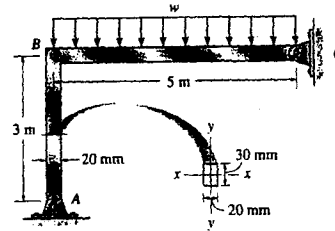

Buckling load :

$$P_{cr} = F_{AB}(\text{F.S.}) = 2.5 w (1.5) = 3.75 w$$

$$I = \frac{1}{12} (0.03)(0.02)^3 = 20 (10^{-9}) \text{ m}^4$$

$$K = 1.0$$

$$P_{cr} = \frac{\pi^2 E I}{(K L)^2}$$

$$3.75 w = \frac{\pi^2 (200)(10^9)(20)(10^{-9})}{[(1.0)(3)]^2}$$

$$w = 1170 \text{ N/m} = 1.17 \text{ kN/m} \quad \text{Ans}$$

$$P_{cr} = 4.38 \text{ kN}$$

Check :

$$\sigma_{cr} = \frac{P_{cr}}{A} = \frac{4.38 (10^3)}{0.02 (0.03)} = 7.31 \text{ MPa} < \sigma_Y \quad \text{OK}$$

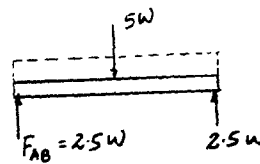

From *Mechanics of Materials*, Sixth Edition by R. C. Hibbeler, ISBN 0-13-191345-X.

© 2005 R. C. Hibbeler. Published by Pearson Prentice Hall,

Pearson Education, Inc., Upper Saddle River, NJ. All rights reserved.

This material is protected under all copyright laws as they currently exist. No portion of this material may be reproduced, in any form or by any means, without permission in writing from the publisher.

13-37 Determine the maximum allowable intensity w of the distributed load that can be applied to member BC without causing member AB to buckle. Assume that AB is made of steel and is pinned at its ends for $x-x$ axis buckling and fixed at its ends for $y-y$ axis buckling. Use a factor of safety with respect to buckling of 3. $E_{st} = 200$ GPa, $\sigma_Y = 360$ MPa.

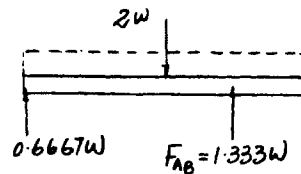
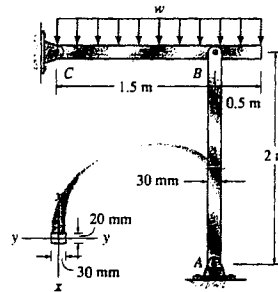

Moment of inertia :

$$I_x = \frac{1}{12}(0.02)(0.03^3) = 45.0(10^{-9})\text{m}^4$$

$$I_y = \frac{1}{12}(0.03)(0.02^3) = 20(10^{-9})\text{m}^4$$

$x-x$ axis :

$$P_{cr} = F_{AB}(\text{F.S.}) = 1.333w(3) = 4.0w$$

$$K = 1.0, \quad L = 2\text{m}$$

$$P_{cr} = \frac{\pi^2 EI}{(KL)^2}$$

$$4.0w = \frac{\pi^2(200)(10^9)(45.0)(10^{-9})}{[(1.0)(2)]^2}$$

$$w = 5552 \text{ N/m} = 5.55 \text{ kN/m} \quad (\text{controls}) \quad \text{Ans}$$

$y-y$ axis

$$K = 0.5, \quad L = 2\text{m}$$

$$4.0w = \frac{\pi^2(200)(10^9)(20)(10^{-9})}{[(0.5)(2)]^2}$$

$$w = 9870 \text{ N/m} = 9.87 \text{ kN/m}$$

Check :

$$\sigma_{cr} = \frac{P_{cr}}{A} = \frac{4(5552)}{(0.02)(0.03)} = 37.0 \text{ MPa} < \sigma_Y \quad \text{OK}$$

From *Mechanics of Materials*, Sixth Edition by R. C. Hibbeler, ISBN 0-13-191345-X.

© 2005 R. C. Hibbeler. Published by Pearson Prentice Hall,

Pearson Education, Inc., Upper Saddle River, NJ. All rights reserved.

This material is protected under all copyright laws as they currently exist. No portion of this material may be reproduced, in any form or by any means, without permission in writing from the publisher.

13-38 Determine if the frame can support a load of $w = 6 \text{ kN/m}$ if the factor of safety with respect to buckling of member AB is 3. Assume that AB is made of steel and is pinned at its ends for $x-x$ axis buckling and fixed at its ends for $y-y$ axis buckling. $E_{st} = 200 \text{ GPa}$, $\sigma_y = 360 \text{ MPa}$.

Check $x-x$ axis buckling :

$$I_x = \frac{1}{12}(0.02)(0.03)^3 = 45.0(10^{-9}) \text{ m}^4$$

$$K = 1.0 \quad L = 2 \text{ m}$$

$$P_{cr} = \frac{\pi^2 EI}{(KL)^2} = \frac{\pi^2(200)(10^9)(45.0)(10^{-9})}{((1.0)(2))^2}$$

$$P_{cr} = 22.2 \text{ kN}$$

$$\begin{aligned} \sum M_C = 0; \quad F_{AB}(1.5) - 6(2)(1) &= 0 \\ F_{AB} &= 8 \text{ kN} \end{aligned}$$

$$P_{req'd} = 8(3) = 24 \text{ kN} > 22.0 \text{ kN}$$

No, AB will fail. **Ans**

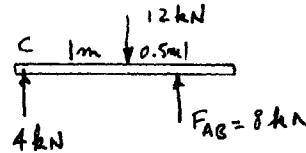
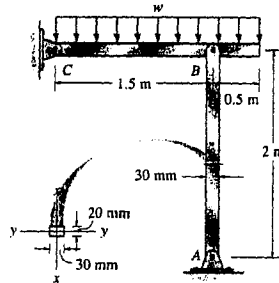

From *Mechanics of Materials*, Sixth Edition by R. C. Hibbeler, ISBN 0-13-191345-X.

© 2005 R. C. Hibbeler. Published by Pearson Prentice Hall,

Pearson Education, Inc., Upper Saddle River, NJ. All rights reserved.

This material is protected under all copyright laws as they currently exist. No portion of this material may be reproduced, in any form or by any means, without permission in writing from the publisher.

13-39. The deck is supported by the two 40-mm-square columns. Column AB is pinned at A and fixed at B , whereas CD is pinned at C and D . If the deck is prevented from side-sway, determine the greatest weight of the load that can be applied without causing the deck to collapse. The center of gravity of the load is located at $d = 2$ m. Both columns are made from Douglas Fir.

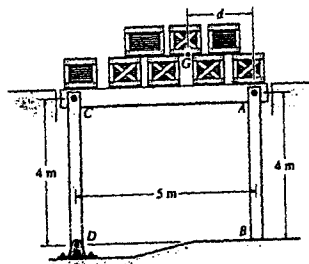

$$\zeta + \Sigma M_C = 0; \quad F_{AB}(5) - W(3) = 0$$

$$F_{AB} = 0.6 W$$

$$+ \uparrow \Sigma F_y = 0; \quad F_{CD} + 0.6 W - W = 0$$

$$F_{CD} = 0.4 W$$



Column CD :

$$P_{cr} = \frac{\pi^2 EI}{(KL)^2} = \frac{\pi^2 (13.1)(10^9) \left(\frac{1}{12}\right) (0.04)^4}{(1(4))^2} = 0.4 W$$

$$W = 4.31 \text{ kN}$$

Column AB :

$$P_{cr} = \frac{\pi^2 EI}{(KL)^2} = \frac{\pi^2 (13.1)(10^9) \left(\frac{1}{12}\right) (0.04)^4}{(0.7(4))^2} = 0.6 W$$

$$W = 5.86 \text{ kN}$$

Thus,

$$W = 4.31 \text{ kN} \quad \text{Ans}$$

From *Mechanics of Materials*, Sixth Edition by R. C. Hibbeler, ISBN 0-13-191345-X.

© 2005 R. C. Hibbeler. Published by Pearson Prentice Hall,

Pearson Education, Inc., Upper Saddle River, NJ. All rights reserved.

This material is protected under all copyright laws as they currently exist. No portion of this material may be reproduced, in any form or by any means, without permission in writing from the publisher.

***13-40.** The deck is supported by the two 40-mm-square columns. Column AB is pinned at A and fixed at B , whereas CD is pinned at C and D . If the deck is prevented from side-sway, determine the position d of the center of gravity of the load and the load's greatest magnitude without causing the deck to collapse. Both columns are made from Douglas Fir.

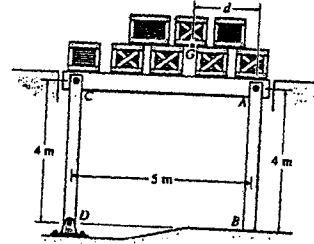

Column CD :

$$P_{cr} = \frac{\pi^2 EI}{(KL)^2}$$

$$F_{CD} = \frac{\pi^2 (13.1)(10^9) \left(\frac{1}{12}\right) (0.04)^4}{(1.0(4))^2} = 1.7239(10^3) \text{ N}$$

Column AB :

$$P_{cr} = \frac{\pi^2 EI}{(KL)^2}$$

$$F_{AB} = \frac{\pi^2 (13.1)(10^9) \left(\frac{1}{12}\right) (0.04)^4}{(0.7(4))^2} = 3.5181(10^3) \text{ N}$$

Thus,

$$+\uparrow \Sigma F_y = 0; \quad 1.7239(10^3) + 3.5181(10^3) - W = 0$$

$$W = 5.2420(10^3) \text{ N} = 5.24 \text{ kN} \quad \text{Ans}$$

$$\curvearrowright \Sigma M_A = 0; \quad 5.2420(10^3)(d) - 1.7239(10^3)(5) = 0$$

$$d = 1.64 \text{ m} \quad \text{Ans}$$

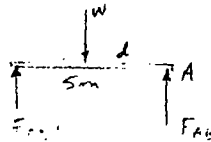

From *Mechanics of Materials*, Sixth Edition by R. C. Hibbeler, ISBN 0-13-191345-X.

© 2005 R. C. Hibbeler. Published by Pearson Prentice Hall,

Pearson Education, Inc., Upper Saddle River, NJ. All rights reserved.

This material is protected under all copyright laws as they currently exist. No portion of this material may be reproduced, in any form or by any means, without permission in writing from the publisher.

13-41. The beam is supported by the three pin-connected suspender bars, each having a diameter of 0.5 in. and made from A-36 steel. Determine the greatest uniform load w that can be applied to the beam without causing AB and CB to buckle.

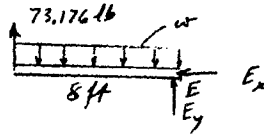
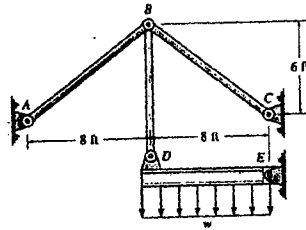

$$P_{cr} = \frac{\pi^2 EI}{(KL)^2} = \frac{\pi^2 (29)(10^6) \left(\frac{\pi}{4}\right) (0.25)^4}{(1.0)(10)(12)^2} = 60.98 \text{ lb}$$

$$+\uparrow \Sigma F_y = 0; \quad 2\left((60.98)\left(\frac{3}{5}\right)\right) - T_{BD} = 0$$

$$T_{BD} = 73.176 \text{ lb}$$

$$\curvearrowleft + \Sigma M_E = 0; \quad -73.176(8) + w(8)(4) = 0$$

$$w = 18.3 \text{ lb/ft} \quad \text{Ans}$$

From *Mechanics of Materials*, Sixth Edition by R. C. Hibbeler, ISBN 0-13-191345-X.

© 2005 R. C. Hibbeler. Published by Pearson Prentice Hall,

Pearson Education, Inc., Upper Saddle River, NJ. All rights reserved.

This material is protected under all copyright laws as they currently exist. No portion of this material may be reproduced, in any form or by any means, without permission in writing from the publisher.

13-42. The rod is made from a 1-in.-diameter steel rod. Determine the critical buckling load if the ends are roller supported. $E_{st} = 29(10^3)$ ksi, $\sigma_Y = 50$ ksi.

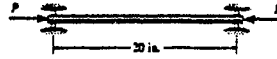

Critical Buckling Load : $I = \frac{\pi}{4} (0.5^4) = 0.015625\pi$ in⁴

and $K = 1$ for roller supported ends column. Applying *Euler's formula*,

$$P_{cr} = \frac{\pi^2 EI}{(KL)^2}$$

$$= \frac{\pi^2 (29)(10^3)(0.015625\pi)}{[1(20)]^2}$$

$$= 35.12 \text{ kip} = 35.1 \text{ kip} \quad \text{Ans}$$

Critical Stress : *Euler's formula* is only valid if $\sigma_{cr} < \sigma_Y$.

$$\sigma_{cr} = \frac{P_{cr}}{A} = \frac{35.12}{\frac{\pi}{4}(1^2)} = 44.72 \text{ ksi} < \sigma_Y = 50 \text{ ksi} \quad (O.K.)$$

From *Mechanics of Materials*, Sixth Edition by R. C. Hibbeler, ISBN 0-13-191345-X.

© 2005 R. C. Hibbeler. Published by Pearson Prentice Hall,

Pearson Education, Inc., Upper Saddle River, NJ. All rights reserved.

This material is protected under all copyright laws as they currently exist. No portion of this material may be reproduced, in any form or by any means, without permission in writing from the publisher.

13-43. Consider an ideal column as in Fig. 13-12c, having both ends fixed. Show that the critical load on the column is given by $P_{cr} = 4\pi^2 EI/L^2$. Hint: Due to the vertical deflection of the top of the column, a constant moment M' will be developed at the supports. Show that $d^2v/dx^2 + (P/EI)v = M'/EI$. The solution is of the form $v = C_1 \sin(\sqrt{P/EI}x) + C_2 \cos(\sqrt{P/EI}x) + M'/P$.

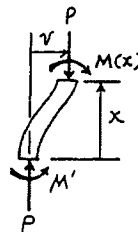

Moment Functions :

$$M(x) = M' - Pv$$

Differential Equation of The Elastic Curve :

$$\begin{aligned} EI \frac{d^2 v}{dx^2} &= M(x) \\ EI \frac{d^2 v}{dx^2} &= M' - Pv \\ \frac{d^2 v}{dx^2} + \frac{P}{EI} v &= \frac{M'}{EI} \quad (Q. E. D.) \end{aligned}$$

The solution of the above differential equation is of the form

$$v = C_1 \sin\left(\sqrt{\frac{P}{EI}}x\right) + C_2 \cos\left(\sqrt{\frac{P}{EI}}x\right) + \frac{M'}{P}$$

and

$$\frac{dv}{dx} = C_1 \sqrt{\frac{P}{EI}} \cos\left(\sqrt{\frac{P}{EI}}x\right) - C_2 \sqrt{\frac{P}{EI}} \sin\left(\sqrt{\frac{P}{EI}}x\right)$$

The integration constants can be determined from the boundary conditions.

Boundary Conditions :

$$\text{At } x = 0, \quad v = 0. \quad \text{From Eq. [1],} \quad C_2 = -\frac{M'}{P}$$

$$\text{At } x = 0, \quad \frac{dv}{dx} = 0. \quad \text{From Eq. [2],} \quad C_1 = 0$$

Elastic Curve :

$$v = \frac{M'}{P} \left[1 - \cos\left(\sqrt{\frac{P}{EI}}x\right) \right]$$

and

$$\frac{dv}{dx} = \frac{M'}{P} \sqrt{\frac{P}{EI}} \sin\left(\sqrt{\frac{P}{EI}}x\right)$$

However, due to symmetry $\frac{dv}{dx} = 0$ at $x = \frac{L}{2}$. Then,

$$[1] \quad \sin\left[\sqrt{\frac{P}{EI}}\left(\frac{L}{2}\right)\right] = 0 \quad \text{or} \quad \sqrt{\frac{P}{EI}}\left(\frac{L}{2}\right) = n\pi \quad \text{where } n = 1, 2, 3.$$

[2] The smallest critical load occurs when $n = 1$.

$$P_{cr} = \frac{4\pi^2 EI}{L^2} \quad (Q. E. D.)$$

From *Mechanics of Materials*, Sixth Edition by R. C. Hibbeler, ISBN 0-13-191345-X.

© 2005 R. C. Hibbeler. Published by Pearson Prentice Hall,

Pearson Education, Inc., Upper Saddle River, NJ. All rights reserved.

This material is protected under all copyright laws as they currently exist. No portion of this material may be reproduced, in any form or by any means, without permission in writing from the publisher.

*13-44. Consider an ideal column as in Fig. 13-12d, having one end fixed and the other pinned. Show that the critical load on the column is given by $P_{cr} = 20.19 EI/L^2$. *Hint:* Due to the vertical deflection at the top of the column, a constant moment M' will be developed at the fixed support and horizontal reactive forces R' will be developed at both supports. Show that $d^2v/dx^2 + (P/EI)v = (R'/EI)(L-x)$. The solution is of the form $v = C_1 \sin(\sqrt{P/EI}x) + C_2 \cos(\sqrt{P/EI}x) + (R'/P)(L-x)$. After application of the boundary conditions show that $\tan(\sqrt{P/EI}L) = \sqrt{P/EI}L$. Solve by trial and error for the smallest root.

Equilibrium : FBD(a).

Moment Functions : FBD(b).

$$M(x) = R'(L-x) - Pv$$

Differential Equation of The Elastic Curve :

$$\begin{aligned} EI \frac{d^2v}{dx^2} &= M(x) \\ EI \frac{d^2v}{dx^2} &= R'(L-x) - Pv \\ \frac{d^2v}{dx^2} + \frac{P}{EI}v &= \frac{R'}{EI}(L-x) \end{aligned}$$

The solution of the above differential equation is of the form

$$v = C_1 \sin\left(\sqrt{\frac{P}{EI}}x\right) + C_2 \cos\left(\sqrt{\frac{P}{EI}}x\right) + \frac{R'}{P}(L-x) \quad [1]$$

and

$$\frac{dv}{dx} = C_1 \sqrt{\frac{P}{EI}} \cos\left(\sqrt{\frac{P}{EI}}x\right) - C_2 \sqrt{\frac{P}{EI}} \sin\left(\sqrt{\frac{P}{EI}}x\right) - \frac{R'}{P} \quad [2]$$

The integration constants can be determined from the boundary conditions.

Boundary Conditions :

At $x=0$, $v=0$. From Eq. [1], $C_2 = -\frac{R'L}{P}$

At $x=0$, $\frac{dv}{dx} = 0$. From Eq. [2], $C_1 = \frac{R'}{P} \sqrt{\frac{EI}{P}}$

Elastic Curve :

$$\begin{aligned} v &= \frac{R'}{P} \sqrt{\frac{EI}{P}} \sin\left(\sqrt{\frac{P}{EI}}x\right) - \frac{R'L}{P} \cos\left(\sqrt{\frac{P}{EI}}x\right) + \frac{R'}{P}(L-x) \\ &= \frac{R'}{P} \left[\sqrt{\frac{EI}{P}} \sin\left(\sqrt{\frac{P}{EI}}x\right) - L \cos\left(\sqrt{\frac{P}{EI}}x\right) + (L-x) \right] \end{aligned}$$

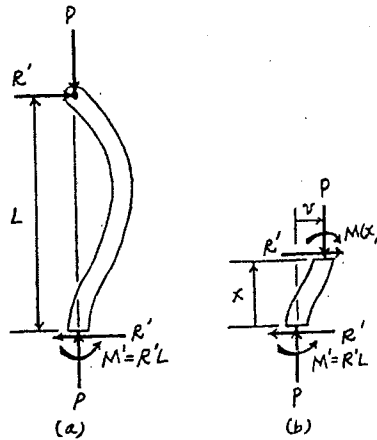

However, $v=0$ at $x=L$. Then,

$$\begin{aligned} 0 &= \sqrt{\frac{EI}{P}} \sin\left(\sqrt{\frac{P}{EI}}L\right) - L \cos\left(\sqrt{\frac{P}{EI}}L\right) \\ \tan\left(\sqrt{\frac{P}{EI}}L\right) &= \sqrt{\frac{P}{EI}}L \quad (Q. E. D.) \end{aligned}$$

By trial and error and choosing the smallest root, we have

$$\sqrt{\frac{P}{EI}}L = 4.49341$$

Then,

$$P_{cr} = \frac{20.19EI}{L^2} \quad (Q. E. D.)$$

From *Mechanics of Materials*, Sixth Edition by R. C. Hibbeler, ISBN 0-13-191345-X.

© 2005 R. C. Hibbeler. Published by Pearson Prentice Hall,

Pearson Education, Inc., Upper Saddle River, NJ. All rights reserved.

This material is protected under all copyright laws as they currently exist. No portion of this material may be reproduced, in any form or by any means, without permission in writing from the publisher.

13-45. The column is supported at B by a support that does not permit rotation but allows vertical deflection. Determine the critical load P_{cr} . EI is constant.

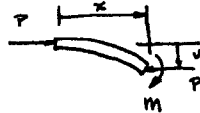
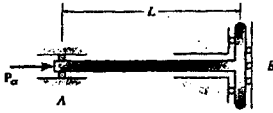

Elastic curve :

$$EI \frac{d^2 v}{dx^2} = M = -P v$$

$$\frac{d^2 v}{dx^2} + \frac{P}{EI} v = 0$$

$$v = C_1 \sin \left[\sqrt{\frac{P}{EI}} x \right] + C_2 \cos \left[\sqrt{\frac{P}{EI}} x \right]$$

Boundary conditions :

$$\text{At } x = 0; \quad v = 0$$

$$0 = 0 + C_2; \quad C_2 = 0$$

$$\text{At } x = L; \quad \frac{dv}{dx} = 0$$

$$\frac{dv}{dx} = C_1 \sqrt{\frac{P}{EI}} \cos \left[\sqrt{\frac{P}{EI}} L \right] = 0; \quad C_1 \sqrt{\frac{P}{EI}} \neq 0$$

$$\cos \left[\sqrt{\frac{P}{EI}} L \right] = 0; \quad \sqrt{\frac{P}{EI}} L = n \left(\frac{\pi}{2} \right)$$

$$\text{For } n = 1; \quad \frac{P}{EI} = \frac{\pi^2}{4L^2}$$

$$P_{cr} = \frac{\pi^2 EI}{4L^2} \quad \text{Ans}$$

From *Mechanics of Materials*, Sixth Edition by R. C. Hibbeler, ISBN 0-13-191345-X.

© 2005 R. C. Hibbeler. Published by Pearson Prentice Hall,

Pearson Education, Inc., Upper Saddle River, NJ. All rights reserved.

This material is protected under all copyright laws as they currently exist. No portion of this material may be reproduced, in any form or by any means, without permission in writing from the publisher.

13-46. The ideal column is subjected to the force F at its midpoint and the axial load P . Determine the maximum moment in the column at midspan. EI is constant. *Hint:* Establish the differential equation for deflection Eq. 13-1. The general solution is $v = A \sin kx + B \cos kx - c^2x/k^2$, where $c^2 = F/2EI$, $k^2 = P/EI$.

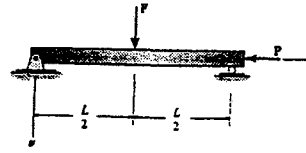

Moment Functions : FBD(b).

$$\left(+\Sigma M_o = 0; \quad M(x) + \frac{F}{2}x + P(v) = 0 \right.$$

$$\left. M(x) = -\frac{F}{2}x - Pv \right. \quad [1]$$

Differential Equation of The Elastic Curve :

$$EI \frac{d^2v}{dx^2} = M(x)$$

$$EI \frac{d^2v}{dx^2} = -\frac{F}{2}x - Pv$$

$$\frac{d^2v}{dx^2} + \frac{P}{EI}v = -\frac{F}{2EI}x$$

The solution of the above differential equation is of the form,

$$v = C_1 \sin\left(\sqrt{\frac{P}{EI}}x\right) + C_2 \cos\left(\sqrt{\frac{P}{EI}}x\right) - \frac{F}{2P}x \quad [2]$$

and

$$\frac{dv}{dx} = C_1 \sqrt{\frac{P}{EI}} \cos\left(\sqrt{\frac{P}{EI}}x\right) - C_2 \sqrt{\frac{P}{EI}} \sin\left(\sqrt{\frac{P}{EI}}x\right) - \frac{F}{2P} \quad [3]$$

The integration constants can be determined from the boundary conditions.

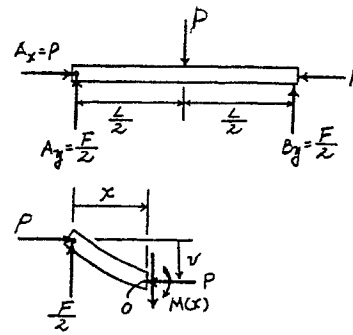

Boundary Conditions :

At $x = 0$, $v = 0$. From Eq.[2], $C_2 = 0$

At $x = \frac{L}{2}$, $\frac{dv}{dx} = 0$. From Eq.[3],

$$0 = C_1 \sqrt{\frac{P}{EI}} \cos\left(\sqrt{\frac{P}{EI}} \frac{L}{2}\right) - \frac{F}{2P}$$

$$C_1 = \frac{F}{2P} \sqrt{\frac{EI}{P}} \sec\left(\sqrt{\frac{P}{EI}} \frac{L}{2}\right)$$

Elastic Curve :

$$v = \frac{F}{2P} \sqrt{\frac{EI}{P}} \sec\left(\sqrt{\frac{P}{EI}} \frac{L}{2}\right) \sin\left(\sqrt{\frac{P}{EI}}x\right) - \frac{F}{2P}x$$

$$= \frac{F}{2P} \left[\sqrt{\frac{EI}{P}} \sec\left(\sqrt{\frac{P}{EI}} \frac{L}{2}\right) \sin\left(\sqrt{\frac{P}{EI}}x\right) - x \right]$$

However, $v = v_{\max}$ at $x = \frac{L}{2}$. Then,

$$v_{\max} = \frac{F}{2P} \left[\sqrt{\frac{EI}{P}} \sec\left(\sqrt{\frac{P}{EI}} \frac{L}{2}\right) \sin\left(\sqrt{\frac{P}{EI}} \frac{L}{2}\right) - \frac{L}{2} \right]$$

$$= \frac{F}{2P} \left[\sqrt{\frac{EI}{P}} \tan\left(\sqrt{\frac{P}{EI}} \frac{L}{2}\right) - \frac{L}{2} \right] \quad \text{Ans}$$

Maximum Moment : The maximum moment occurs at $x = \frac{L}{2}$. From Eq.[1],

$$M_{\max} = -\frac{F}{2} \left(\frac{L}{2}\right) - Pv_{\max}$$

$$= -\frac{FL}{4} - P \left\{ \frac{F}{2P} \left[\sqrt{\frac{EI}{P}} \tan\left(\sqrt{\frac{P}{EI}} \frac{L}{2}\right) - \frac{L}{2} \right] \right\}$$

$$= -\frac{F}{2} \sqrt{\frac{EI}{P}} \tan\left(\sqrt{\frac{P}{EI}} \frac{L}{2}\right) \quad \text{Ans}$$

From *Mechanics of Materials*, Sixth Edition by R. C. Hibbeler, ISBN 0-13-191345-X.

© 2005 R. C. Hibbeler. Published by Pearson Prentice Hall,

Pearson Education, Inc., Upper Saddle River, NJ. All rights reserved.

This material is protected under all copyright laws as they currently exist. No portion of this material may be reproduced, in any form or by any means, without permission in writing from the publisher.

13-47. The ideal column has a weight w (force/length) and rests in the horizontal position when it is subjected to the axial load P . Determine the maximum moment in the column at midspan. EI is constant. *Hint:* Establish the differential equation for deflection Eq. 13-1, with the origin at the midspan.

The general solution is $v = A \sin kx + B \cos kx + C_1 + C_2x + C_3x^2$, where $k^2 = P/EI$.

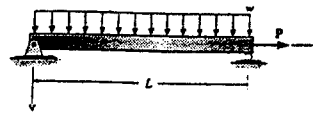

Moment Functions : FBD(b).

$$\left(\sum M_O = 0; \quad wx \left(\frac{x}{2} \right) - M(x) - \frac{wL}{2}x - Pv = 0 \right.$$

$$\left. M(x) = \frac{w}{2}(x^2 - Lx) - Pv \right. \quad [1]$$

Differential Equation of The Elastic Curve :

$$EI \frac{d^2v}{dx^2} = M(x)$$

$$EI \frac{d^2v}{dx^2} = \frac{w}{2}(x^2 - Lx) - Pv$$

$$\frac{d^2v}{dx^2} + \frac{P}{EI}v = \frac{w}{2EI}(x^2 - Lx)$$

The solution of the above differential equation is of the form

$$v = C_1 \sin \left(\sqrt{\frac{P}{EI}}x \right) + C_2 \cos \left(\sqrt{\frac{P}{EI}}x \right) + \frac{w}{2P}x^2 - \frac{wL}{2P}x - \frac{wEI}{P^2} \quad [2]$$

and

$$\frac{dv}{dx} = C_1 \sqrt{\frac{P}{EI}} \cos \left(\sqrt{\frac{P}{EI}}x \right) - C_2 \sqrt{\frac{P}{EI}} \sin \left(\sqrt{\frac{P}{EI}}x \right) + \frac{w}{P}x - \frac{wL}{2P} \quad [3]$$

The integration constants can be determined from the boundary conditions.

Boundary Conditions :

At $x = 0$, $v = 0$. From Eq. [2],

$$0 = C_2 - \frac{wEI}{P^2} \quad C_2 = \frac{wEI}{P^2}$$

At $x = \frac{L}{2}$, $\frac{dv}{dx} = 0$. From Eq. [3],

$$0 = C_1 \sqrt{\frac{P}{EI}} \cos \left(\sqrt{\frac{P}{EI}} \frac{L}{2} \right) - \frac{wEI}{P^2} \sqrt{\frac{P}{EI}} \sin \left(\sqrt{\frac{P}{EI}} \frac{L}{2} \right) + \frac{w}{P} \left(\frac{L}{2} \right) - \frac{wL}{2P}$$

$$C_1 = \frac{wEI}{P^2} \tan \left(\sqrt{\frac{P}{EI}} \frac{L}{2} \right)$$

Elastic Curve :

$$v = \frac{w}{P} \left[\frac{EI}{P} \tan \left(\sqrt{\frac{P}{EI}} \frac{L}{2} \right) \sin \left(\sqrt{\frac{P}{EI}}x \right) + \frac{EI}{P} \cos \left(\sqrt{\frac{P}{EI}}x \right) + \frac{x^2}{2} - \frac{L}{2}x - \frac{EI}{P} \right]$$

However, $v = v_{\max}$ at $x = \frac{L}{2}$. Then,

$$v_{\max} = \frac{w}{P} \left[\frac{EI}{P} \tan \left(\sqrt{\frac{P}{EI}} \frac{L}{2} \right) \sin \left(\sqrt{\frac{P}{EI}} \frac{L}{2} \right) + \frac{EI}{P} \cos \left(\sqrt{\frac{P}{EI}} \frac{L}{2} \right) - \frac{L^2}{8} - \frac{EI}{P} \right]$$

$$= \frac{wEI}{P^2} \left[\sec \left(\sqrt{\frac{P}{EI}} \frac{L}{2} \right) - \frac{PL^2}{8EI} - 1 \right] \quad \text{Ans}$$

Maximum Moment : The maximum moment occurs at $x = \frac{L}{2}$. From Eq. [1],

$$M_{\max} = \frac{w}{2} \left[\frac{L^2}{4} - L \left(\frac{L}{2} \right) \right] - Pv_{\max}$$

$$= -\frac{wL^2}{8} - P \left\{ \frac{wEI}{P^2} \left[\sec \left(\sqrt{\frac{P}{EI}} \frac{L}{2} \right) - \frac{PL^2}{8EI} - 1 \right] \right\}$$

$$= -\frac{wEI}{P} \left[\sec \left(\sqrt{\frac{P}{EI}} \frac{L}{2} \right) - 1 \right] \quad \text{Ans}$$

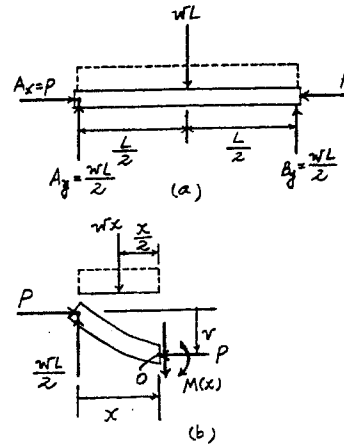

From *Mechanics of Materials*, Sixth Edition by R. C. Hibbeler, ISBN 0-13-191345-X.

© 2005 R. C. Hibbeler. Published by Pearson Prentice Hall,

Pearson Education, Inc., Upper Saddle River, NJ. All rights reserved.

This material is protected under all copyright laws as they currently exist. No portion of this material may be reproduced, in any form or by any means, without permission in writing from the publisher.

*13-48 Determine the load P required to cause the A-36 steel $W 8 \times 15'$ column to fail either by buckling or by yielding. The column is fixed at its base and free at its top.

Section properties for $W 8 \times 15$:

$$A = 4.44 \text{ in}^2 \quad I_x = 48.0 \text{ in}^4 \quad I_y = 3.41 \text{ in}^4 \\ r_x = 3.29 \text{ in.} \quad d = 8.11 \text{ in.}$$

Buckling about y - y axis :

$$K = 2.0 \quad L = 8(12) = 96 \text{ in.}$$

$$P = P_{cr} = \frac{\pi^2 EI_y}{(KL)^2} = \frac{\pi^2 (29)(10^3)(3.41)}{[(2.0)(96)]^2} = 26.5 \text{ kip} \quad \text{controls} \quad \text{Ans}$$



$$\text{Check :} \quad \sigma_{cr} = \frac{P_{cr}}{A} = \frac{26.5}{4.44} = 5.96 \text{ ksi} < \sigma_Y \quad \text{OK}$$

Check yielding about x - x axis :

$$\sigma_{max} = \frac{P}{A} \left[1 + \frac{ec}{r^2} \sec \left(\frac{KL}{2r} \sqrt{\frac{P}{EA}} \right) \right]$$

$$\frac{P}{A} = \frac{26.5}{4.44} = 5.963 \text{ ksi}$$

$$\frac{ec}{r^2} = \frac{(1)\left(\frac{8.11}{2}\right)}{(3.29)^2} = 0.37463$$

$$\frac{KL}{2r} \sqrt{\frac{P}{EA}} = \frac{2.0(96)}{2(3.29)} \sqrt{\frac{26.5}{29(10^3)(4.44)}} = 0.4184$$

$$\sigma_{max} = 5.963[1 + 0.37463 \sec(0.4184)] = 8.41 \text{ ksi} < \sigma_Y = 36 \text{ ksi} \quad \text{OK}$$

From *Mechanics of Materials*, Sixth Edition by R. C. Hibbeler, ISBN 0-13-191345-X.

© 2005 R. C. Hibbeler. Published by Pearson Prentice Hall,

Pearson Education, Inc., Upper Saddle River, NJ. All rights reserved.

This material is protected under all copyright laws as they currently exist. No portion of this material may be reproduced, in any form or by any means, without permission in writing from the publisher.

13-49. The $W10 \times 12$ structural A-36 steel column is used to support a load of 4 kip. If the column is fixed at the base and free at the top, determine the deflection at the top of the column due to the loading.



Section properties for $W 10 \times 12$

$$A = 3.54 \text{ in}^2 \quad I_x = 53.8 \text{ in}^4 \quad r_x = 3.90 \text{ in.} \quad d = 9.89 \text{ in.}$$

Maximum deflection :

$$v_{\max} = e \left[\sec \left(\sqrt{\frac{P}{EI}} \frac{KL}{2} \right) - 1 \right] \quad K = 2.0$$

$$\sqrt{\frac{P}{EI}} \frac{KL}{2} = \sqrt{\frac{4}{29 (10^3) 53.8}} \left(\frac{2.0 (15)(12)}{2} \right) = 0.2882$$

$$v_{\max} = 9 \left[\sec (0.2882) - 1 \right] = 0.387 \text{ in.} \quad \text{Ans}$$

From *Mechanics of Materials*, Sixth Edition by R. C. Hibbeler, ISBN 0-13-191345-X.

© 2005 R. C. Hibbeler. Published by Pearson Prentice Hall,

Pearson Education, Inc., Upper Saddle River, NJ. All rights reserved.

This material is protected under all copyright laws as they currently exist. No portion of this material may be reproduced, in any form or by any means, without permission in writing from the publisher.

13-50. The $W10 \times 12$ structural A-36 steel column is used to support a load of 4 kip. If the column is fixed at its base and free at its top, determine the maximum stress in the column due to this loading.



Section properties for $W10 \times 12$

$$A = 3.54 \text{ in}^2 \quad I_x = 53.8 \text{ in}^4 \quad r_x = 3.90 \text{ in.} \quad d = 9.89 \text{ in.}$$

$$\sigma_{\max} = \frac{P}{A} \left[1 + \frac{e c}{r^2} \sec \left(\frac{KL}{2r} \sqrt{\frac{P}{EA}} \right) \right]$$

$$\frac{P}{A} = \frac{4}{3.54} = 1.13 \text{ ksi}$$

$$\frac{e c}{r^2} = \frac{9 \left(\frac{9.89}{2} \right)}{3.90^2} = 2.926$$

$$\frac{KL}{2r} \sqrt{\frac{P}{EA}} = \frac{2.0(15)(12)}{2(3.90)} \sqrt{\frac{4}{29(10^3)(3.54)}} = 0.2881$$

$$\sigma_{\max} = 1.13[1 + 2.926 \sec(0.2881)] = 4.57 \text{ ksi} < \sigma_y \quad \text{OK} \quad \text{Ans}$$

From *Mechanics of Materials*, Sixth Edition by R. C. Hibbeler, ISBN 0-13-191345-X.

© 2005 R. C. Hibbeler. Published by Pearson Prentice Hall,

Pearson Education, Inc., Upper Saddle River, NJ. All rights reserved.

This material is protected under all copyright laws as they currently exist. No portion of this material may be reproduced, in any form or by any means, without permission in writing from the publisher.

13-51 The wood column has a square cross section with dimensions 100 mm by 100 mm. It is fixed at its base and free at its top. Determine the load P that can be applied to the edge of the column without causing the column to fail either by buckling or by yielding. $E_w = 12 \text{ GPa}$, $\sigma_Y = 55 \text{ MPa}$.

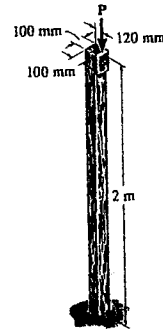

Section properties :

$$A = 0.1(0.1) = 0.01 \text{ m}^2 \quad I = \frac{1}{12}(0.1)(0.1^3) = 8.333(10^{-6}) \text{ m}^4$$

$$r = \sqrt{\frac{I}{A}} = \sqrt{\frac{8.333(10^{-6})}{0.01}} = 0.02887 \text{ m}$$

Buckling :

$$P_{cr} = \frac{\pi^2 EI}{(KL)^2} = \frac{\pi^2 (12)(10^9)(8.333)(10^{-6})}{[2.0(2)]^2} = 61.7 \text{ kN}$$

$$\text{Check :} \quad \sigma_{cr} = \frac{P_{cr}}{A} = \frac{61.7(10^3)}{0.01} = 6.17 \text{ MPa} < \sigma_Y \quad \text{OK}$$

Yielding :

$$\sigma_{max} = \frac{P}{A} \left[1 + \frac{ec}{r^2} \sec \left(\frac{KL}{2r} \sqrt{\frac{P}{EA}} \right) \right]$$

$$\frac{ec}{r^2} = \frac{0.12(0.05)}{(0.02887)^2} = 7.20$$

$$\frac{KL}{2r} \sqrt{\frac{P}{EA}} = \frac{2.0(2)}{2(0.02887)} \sqrt{\frac{P}{12(10^9)(0.01)}} = 0.006324\sqrt{P}$$

$$55(10^6)(0.01) = P[1 + 7.20 \sec(0.006324\sqrt{P})]$$

By trial and error :

$$P = 31400 \text{ N} = 31.4 \text{ kN} \quad \text{controls} \quad \text{Ans}$$

From *Mechanics of Materials*, Sixth Edition by R. C. Hibbeler, ISBN 0-13-191345-X.

© 2005 R. C. Hibbeler. Published by Pearson Prentice Hall,

Pearson Education, Inc., Upper Saddle River, NJ. All rights reserved.

This material is protected under all copyright laws as they currently exist. No portion of this material may be reproduced, in any form or by any means, without permission in writing from the publisher.

***13-52.** The $W14 \times 26$ structural A-36 steel member is used as a 20-ft-long column that is assumed to be fixed at its top and fixed at its bottom. If the 15-kip load is applied at an eccentric distance of 10 in., determine the maximum stress in the column.

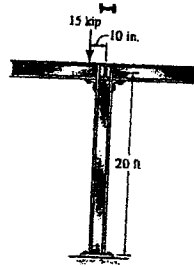

Section properties for $W 14 \times 26$

$$A = 7.69 \text{ in}^2 \quad d = 13.91 \text{ in.} \quad I_x = 245 \text{ in}^4 \quad r_x = 5.65 \text{ in.}$$

Yielding about $x-x$ axis :

$$\sigma_{\max} = \frac{P}{A} \left[1 + \frac{ec}{r^2} \sec \left(\frac{KL}{2r} \sqrt{\frac{P}{EA}} \right) \right]; \quad K = 0.5$$

$$\frac{P}{A} = \frac{15}{7.69} = 1.9506 \text{ ksi}; \quad \frac{ec}{r^2} = \frac{10 \left(\frac{13.91}{2} \right)}{(5.65)^2} = 2.178714$$

$$\frac{KL}{2r} \sqrt{\frac{P}{EA}} = \frac{0.5 (20)(12)}{2(5.65)} \sqrt{\frac{15}{29 (10^3)(7.69)}} = 0.087094$$

$$\begin{aligned} \sigma_{\max} &= 1.9506 [1 + 2.178714 \sec (0.087094)] \\ &= 6.22 \text{ ksi} < \sigma_y = 36 \text{ ksi} \quad \text{OK} \quad \text{Ans} \end{aligned}$$

From *Mechanics of Materials*, Sixth Edition by R. C. Hibbeler, ISBN 0-13-191345-X.

© 2005 R. C. Hibbeler. Published by Pearson Prentice Hall,

Pearson Education, Inc., Upper Saddle River, NJ. All rights reserved.

This material is protected under all copyright laws as they currently exist. No portion of this material may be reproduced, in any form or by any means, without permission in writing from the publisher.

13-53. The $W14 \times 26$ structural A-36 steel member is used as a column that is assumed to be fixed at its top and pinned at its bottom. If the 15-kip load is applied at an eccentric distance of 10 in., determine the maximum stress in the column.

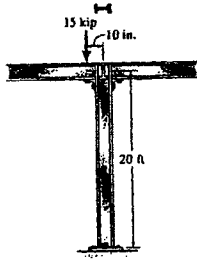

Section properties for $W14 \times 26$

$$A = 7.69 \text{ in}^2 \quad d = 13.91 \text{ in.} \quad I_x = 245 \text{ in}^4 \quad r_x = 5.65 \text{ in.}$$

Yielding about $x-x$ axis :

$$\sigma_{\max} = \frac{P}{A} \left[1 + \frac{ec}{r^2} \sec\left(\frac{KL}{2r} \sqrt{\frac{P}{EA}}\right) \right]; \quad K = 0.7$$

$$\frac{P}{A} = \frac{15}{7.69} = 1.9506 \text{ ksi}; \quad \frac{ec}{r^2} = \frac{10 \left(\frac{13.91}{2}\right)}{(5.65)^2} = 2.178714$$

$$\frac{KL}{2r} \sqrt{\frac{P}{EA}} = \frac{0.7(20)(12)}{2(5.65)} \sqrt{\frac{15}{29(10^3)(7.69)}} = 0.121931$$

$$\begin{aligned} \sigma_{\max} &= 1.9506[1 + 2.178714 \sec(0.121931)] \\ &= 6.24 \text{ ksi} < \sigma_Y = 36 \text{ ksi} \quad \text{OK} \quad \text{Ans} \end{aligned}$$

From *Mechanics of Materials*, Sixth Edition by R. C. Hibbeler, ISBN 0-13-191345-X.

© 2005 R. C. Hibbeler. Published by Pearson Prentice Hall,

Pearson Education, Inc., Upper Saddle River, NJ. All rights reserved.

This material is protected under all copyright laws as they currently exist. No portion of this material may be reproduced, in any form or by any means, without permission in writing from the publisher.

13-54. The $W10 \times 30$ structural A-36 steel column is pinned at its top and bottom. If it is subjected to the eccentric load of 85 kip, determine the factor of safety with respect to yielding.

Section properties for $W10 \times 30$:

$$A = 8.84 \text{ in}^2 \quad I_x = 170 \text{ in}^4 \quad r_x = 4.38 \text{ in.}$$

$$d = 10.47 \text{ in.} \quad I_y = 16.7 \text{ in}^4$$

Yielding about $x-x$ axis :

$$\sigma_{max} = \frac{P}{A} \left[1 + \frac{ec}{r^2} \sec \left(\frac{KL}{2r} \sqrt{\frac{P}{EA}} \right) \right]$$

$$\frac{ec}{r^2} = \frac{8 \left(\frac{10.47}{2} \right)}{4.38^2} = 2.1830$$

$$\frac{KL}{2r} \sqrt{\frac{P}{EA}} = \frac{1.0(15)(12)}{2(4.38)} \sqrt{\frac{P}{29(10^3)(8.84)}} = 0.040583\sqrt{P}$$

$$36(8.84) = P[1 + 2.1830 \sec(0.040583\sqrt{P})]$$

By trial and error :

$$P = 94.8 \text{ kip} \quad \text{controls}$$

Buckling about $y-y$ axis :

$$P_{cr} = \frac{\pi^2 EI}{(KL)^2} = \frac{\pi^2 (29)(10^3)(16.7)}{[(1.0)(15)(12)]^2} = 147.5 \text{ kip}$$

$$\text{Check : } \sigma_{cr} = \frac{P_{cr}}{A} = \frac{147.5}{8.84} = 16.7 \text{ ksi} < \sigma_y \quad \text{OK}$$

$$\text{F.S.} = \frac{94.8}{85} = 1.12 \quad \text{Ans}$$

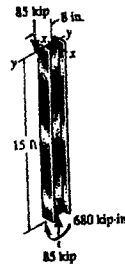

From *Mechanics of Materials*, Sixth Edition by R. C. Hibbeler, ISBN 0-13-191345-X.

© 2005 R. C. Hibbeler. Published by Pearson Prentice Hall,

Pearson Education, Inc., Upper Saddle River, NJ. All rights reserved.

This material is protected under all copyright laws as they currently exist. No portion of this material may be reproduced, in any form or by any means, without permission in writing from the publisher.

13-55. The $W10 \times 30$ structural A-36 steel column is fixed at its bottom and free at its top. If it is subjected to the eccentric load of 85 kip, determine if the column fails by yielding. The column is braced so that it does not buckle about the y - y axis.

Section properties for $W10 \times 30$:

$$A = 8.84 \text{ in}^2 \quad I_x = 170 \text{ in}^4 \quad r_x = 4.38 \text{ in.}$$

$$d = 10.47 \text{ in.} \quad I_y = 16.7 \text{ in}^4$$

Yielding about x - x axis :

$$\sigma_{\max} = \frac{P}{A} \left[1 + \frac{ec}{r^2} \sec \left(\frac{KL}{2r} \sqrt{\frac{P}{EA}} \right) \right]$$

$$\frac{ec}{r^2} = \frac{8 \left(\frac{10.47}{2} \right)}{4.38^2} = 2.1830$$

$$\frac{KL}{2r} \sqrt{\frac{P}{EA}} = \frac{(2)(15)(12)}{2(4.38)} \sqrt{\frac{P}{29(10^3)(8.84)}} = 0.081166\sqrt{P}$$

$$36(8.84) = P[1 + 2.1830 \sec(0.081166\sqrt{P})]$$

By trial and error :

$$P = 81.0 \text{ kip}$$

Since $81.0 \text{ kip} < 85 \text{ kip}$ the column fails by yielding.

Yes. Ans

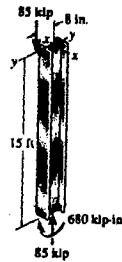

From *Mechanics of Materials*, Sixth Edition by R. C. Hibbeler, ISBN 0-13-191345-X.

© 2005 R. C. Hibbeler. Published by Pearson Prentice Hall,

Pearson Education, Inc., Upper Saddle River, NJ. All rights reserved.

This material is protected under all copyright laws as they currently exist. No portion of this material may be reproduced, in any form or by any means, without permission in writing from the publisher.

***13-56.** A $W12 \times 26$ structural A-36 steel column is fixed connected at its ends and has a length $L = 23$ ft. Determine the maximum eccentric load P that can be applied so the column does not buckle or yield. Compare this value with an axial critical load P' applied through the centroid of the column.



Section properties for $W12 \times 26$:

$$A = 7.65 \text{ in}^2 \quad I_x = 204 \text{ in}^4 \quad I_y = 17.3 \text{ in}^4$$

$$r_x = 5.17 \text{ in.} \quad d = 12.22 \text{ in.}$$

Buckling about y - y axis :

$$P_{cr} = \frac{\pi^2 EI}{(KL)^2}$$

$$P_{cr} = P_{cr} = \frac{\pi^2 (29)(10^3)(17.3)}{[(0.5)(23)(12)]^2} = 260 \text{ kip}$$

$$\text{Check : } \sigma_{cr} = \frac{P_{cr}}{A} = \frac{260}{7.65} = 34.0 \text{ ksi} < \sigma_y \quad \text{OK}$$

Yielding about x - x axis :

$$\sigma_{max} = \frac{P}{A} \left[1 + \frac{ec}{r^2} \sec \left(\frac{KL}{2r} \sqrt{\frac{P}{EA}} \right) \right]$$

$$\frac{ec}{r^2} = \frac{6 \left(\frac{12.22}{2} \right)}{5.17^2} = 1.37155$$

$$\frac{KL}{2r} \sqrt{\frac{P}{EA}} = \frac{(0.5)(23)(12)}{2(5.17)} \sqrt{\frac{P}{29(10^3)(7.65)}} = 0.028335 \sqrt{P}$$

$$36(7.65) = P[1 + 1.37155 \sec(0.028335 \sqrt{P})]$$

By trial and error :

$$P = 112.7 \text{ kip} = 113 \text{ kip} \quad \text{controls} \quad \text{Ans}$$

From *Mechanics of Materials*, Sixth Edition by R. C. Hibbeler, ISBN 0-13-191345-X.

© 2005 R. C. Hibbeler. Published by Pearson Prentice Hall,

Pearson Education, Inc., Upper Saddle River, NJ. All rights reserved.

This material is protected under all copyright laws as they currently exist. No portion of this material may be reproduced, in any form or by any means, without permission in writing from the publisher.

13-57. A $W14 \times 30$ structural A-36 steel column is fixed connected at its ends and has a length $L = 20$ ft. Determine the maximum eccentric load P that can be applied so the column does not buckle or yield. Compare this value with an axial critical load P' applied through the centroid of the column.



Section properties for $W14 \times 30$

$$A = 8.85 \text{ in}^2 \quad d = 13.84 \text{ in.} \quad I_x = 291 \text{ in}^4 \quad r_x = 5.73 \text{ in.} \quad I_y = 19.6 \text{ in}^4$$

Buckling about y - y axis :

$$P_{cr} = \frac{\pi^2 E I}{(K L)^2} \quad K = 0.5$$

$$P' = \frac{\pi^2 (29)(10^3)(19.6)}{[0.5 (20)(12)]^2} = 390 \text{ kip} \quad \text{Ans}$$

Yielding about x - x axis :

$$\sigma_{max} = \frac{P}{A} \left[1 + \frac{e c}{r^2} \sec \left(\frac{K L}{2 r} \sqrt{\frac{P}{E A}} \right) \right]$$

$$36 = \frac{P}{8.85} \left[1 + \frac{6 \left(\frac{13.84}{2} \right)}{5.73^2} \sec \left(\frac{0.5 (20)(12)}{2 (5.73)} \sqrt{\frac{P}{29(10^3)(8.85)}} \right) \right]$$

Solving by trial and error :

$$P = 139 \text{ kip} \quad \text{controls} \quad \text{Ans}$$

From *Mechanics of Materials*, Sixth Edition by R. C. Hibbeler, ISBN 0-13-191345-X.

© 2005 R. C. Hibbeler. Published by Pearson Prentice Hall,

Pearson Education, Inc., Upper Saddle River, NJ. All rights reserved.

This material is protected under all copyright laws as they currently exist. No portion of this material may be reproduced, in any form or by any means, without permission in writing from the publisher.

13-58 Solve Prob. 13-57 if the column is fixed at its bottom and free at its top.

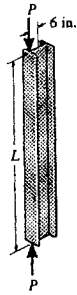

Section properties : For W 14 x 30

$$A = 8.85 \text{ in}^2 \quad d = 13.84 \text{ in.} \quad I_x = 291 \text{ in}^4 \quad r_x = 5.73 \text{ in.} \quad I_y = 19.6 \text{ in}^4$$

Buckling about y-y axis :

$$P_{cr} = \frac{\pi^2 E I}{(K L)^2} \quad K = 2$$

$$P' = P_{cr} = \frac{\pi^2 (29)(10^3)(19.6)}{[2(20)(12)]^2} = 24.3 \text{ kip} \quad \text{(controls)} \quad \mathbf{Ans}$$

Yielding about x-x axis :

$$\sigma_{max} = \frac{P}{A} \left[1 + \frac{e c}{r^2} \sec \left(\frac{K L}{2 r} \sqrt{\frac{P}{E A}} \right) \right]$$

$$36 = \frac{P}{8.85} \left[1 + \frac{6 \left(\frac{13.84}{2} \right)}{5.73^2} \sec \left(\frac{2(20)(12)}{2(5.73)} \sqrt{\frac{P}{29(10^3)(8.85)}} \right) \right]$$

Solving by trial and error,

$$P = 108.4 \text{ kip} \quad \mathbf{Ans}$$

From *Mechanics of Materials*, Sixth Edition by R. C. Hibbeler, ISBN 0-13-191345-X.

© 2005 R. C. Hibbeler. Published by Pearson Prentice Hall,

Pearson Education, Inc., Upper Saddle River, NJ. All rights reserved.

This material is protected under all copyright laws as they currently exist. No portion of this material may be reproduced, in any form or by any means, without permission in writing from the publisher.

13-59 The wood column is fixed at its base and can be assumed pin connected at its top. Determine the maximum eccentric load P that can be applied without causing the column to buckle or yield. $E_w = 1.8(10^3)$ ksi, $\sigma_Y = 8$ ksi.

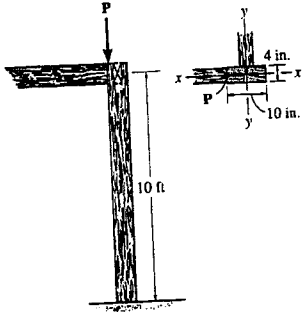

Section Properties :

$$A = 10(4) = 40 \text{ in}^2 \quad I_x = \frac{1}{12}(4)(10^3) = 333.33 \text{ in}^4 \quad I_y = \frac{1}{12}(10)(4^3) = 53.33 \text{ in}^4$$

$$r_x = \sqrt{\frac{I_x}{A}} = \sqrt{\frac{333.33}{40}} = 2.8868 \text{ in.}$$

Buckling about y - y axis :

$$P = P_{cr} = \frac{\pi^2 EI}{(KL)^2} = \frac{\pi^2 (1.8)(10^3)(53.33)}{[(0.7)(10)(12)]^2} = 134 \text{ kip}$$

$$\text{Check : } \sigma_{cr} = \frac{P_{cr}}{A} = \frac{134}{40} = 3.36 \text{ ksi} < \sigma_Y \quad \text{OK}$$

Yielding about x - x axis :

$$\sigma_{max} = \frac{P}{A} \left[1 + \frac{ec}{r^2} \sec\left(\frac{KL}{2r}\right) \sqrt{\frac{P}{EA}} \right]$$

$$\frac{ec}{r^2} = \frac{5(5)}{2.8868^2} = 3.0$$

$$\left(\frac{KL}{2r}\right) \sqrt{\frac{P}{EA}} = \frac{0.7(10)(12)}{2(2.8868)} \sqrt{\frac{P}{1.8(10^3)(40)}} = 0.054221\sqrt{P}$$

$$8(40) = P[1 + 3.0 \sec(0.054221\sqrt{P})]$$

By trial and error :

$$P = 73.5 \text{ kip} \quad \text{controls} \quad \text{Ans}$$

From *Mechanics of Materials*, Sixth Edition by R. C. Hibbeler, ISBN 0-13-191345-X.

© 2005 R. C. Hibbeler. Published by Pearson Prentice Hall,

Pearson Education, Inc., Upper Saddle River, NJ. All rights reserved.

This material is protected under all copyright laws as they currently exist. No portion of this material may be reproduced, in any form or by any means, without permission in writing from the publisher.

*13-60 The wood column is fixed at its base and can be assumed fixed connected at its top. Determine the maximum eccentric load P that can be applied without causing the column to buckle or yield. $E_w = 1.8(10^3)$ ksi, $\sigma_Y = 8$ ksi.

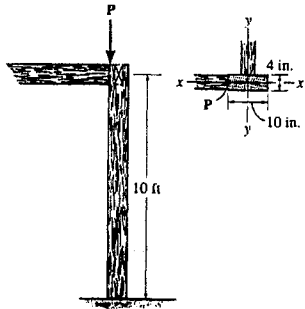

Section Properties :

$$A = 10(4) = 40 \text{ in}^2 \quad I_x = \frac{1}{12}(4)(10^3) = 333.33 \text{ in}^4 \quad I_y = \frac{1}{12}(10)(4^3) = 53.33 \text{ in}^4$$

$$r_x = \sqrt{\frac{I_x}{A}} = \sqrt{\frac{333.33}{40}} = 2.8868 \text{ in.}$$

Buckling about y - y axis :

$$P = P_{cr} = \frac{\pi^2 EI}{(KL)^2} = \frac{\pi^2 (1.8)(10^3)(53.33)}{[(0.5)(10)(12)]^2} = 263 \text{ kip}$$

$$\text{Check : } \sigma_{cr} = \frac{P_{cr}}{A} = \frac{263}{40} = 6.58 \text{ ksi} < \sigma_Y \quad \text{OK}$$

Yielding about x - x axis :

$$\sigma_{max} = \frac{P}{A} \left[1 + \frac{ec}{r^2} \sec \left(\frac{KL}{2r} \sqrt{\frac{P}{EA}} \right) \right]$$

$$\frac{ec}{r^2} = \frac{5(5)}{2.8868^2} = 3.0$$

$$\left(\frac{KL}{2r} \right) \sqrt{\frac{P}{EA}} = \frac{0.5(10)(12)}{2(2.8868)} \sqrt{\frac{P}{1.8(10^3)(40)}} = 0.038729\sqrt{P}$$

$$8(40) = P[1 + 3.0 \sec(0.038729\sqrt{P})]$$

By trial and error :

$$P = 76.6 \text{ kip} \quad (\text{controls}) \quad \text{Ans}$$

From *Mechanics of Materials*, Sixth Edition by R. C. Hibbeler, ISBN 0-13-191345-X.

© 2005 R. C. Hibbeler. Published by Pearson Prentice Hall,

Pearson Education, Inc., Upper Saddle River, NJ. All rights reserved.

This material is protected under all copyright laws as they currently exist. No portion of this material may be reproduced, in any form or by any means, without permission in writing from the publisher.

13-61. The aluminum column has the cross section shown. If it is fixed at the bottom and free at the top, determine the maximum force P that can be applied at A without causing it to buckle or yield. Use a factor of safety of 3 with respect to buckling and yielding. $E_{al} = 70 \text{ GPa}$, $\sigma_Y = 95 \text{ MPa}$.

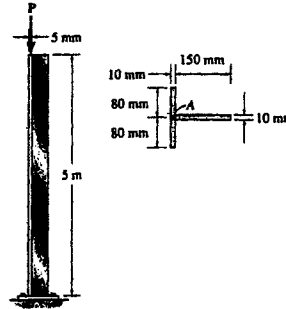

$$\bar{x} = \frac{(0.005)(0.16)(0.01) + (0.085)(0.15)(0.01)}{0.16(0.01) + 0.15(0.01)} = 0.04371 \text{ m}$$

$$I_x = \frac{1}{12}(0.16)(0.01)^3 + (0.16)(0.01)(0.04371 - 0.005)^2 + \frac{1}{12}(0.01)(0.15)^3 + (0.15)(0.01)(0.085 - 0.04371)^2 = 7.7807(10^{-6}) \text{ m}^4$$

$$I_y = \frac{1}{12}(0.01)(0.16^3) + \frac{1}{12}(0.15)(0.01^3) = 3.42583(10^{-6}) \text{ m}^4$$

$$A = (0.16)(0.01) + (0.15)(0.01) = 3.1(10^{-3}) \text{ m}^2$$

$$r_x = \sqrt{\frac{I_x}{A}} = \sqrt{\frac{7.7807(10^{-6})}{3.1(10^{-3})}} = 0.0501 \text{ m}$$

Buckling about $x-x$ axis :

$$P = P_{cr} = \frac{\pi^2 EI}{(KL)^2} = \frac{\pi^2 (70)(10^9)(3.42583)(10^{-6})}{\{2.0(5)\}^2} = 23668 \text{ N}$$

$$P_{\text{allow}} = \frac{P_{cr}}{3} = 7.89 \text{ kN} \quad (\text{controls}) \quad \text{Ans}$$

$$\text{Check: } \sigma_{cr} = \frac{P_{cr}}{A} = \frac{23668 \text{ N}}{3.1(10^{-3})} = 7.63 \text{ MPa} < \sigma_Y \quad \text{OK}$$

Yielding about $y-y$ axis :

$$\sigma_{\text{max}} = \frac{P}{A} \left[1 + \frac{ec}{r^2} \sec\left(\frac{KL}{2r}\right) \sqrt{\frac{P}{EA}} \right]$$

$$\frac{ec}{r^2} = \frac{(0.03871)(0.04371)}{0.0501^2} = 0.6741$$

$$\left(\frac{KL}{2r}\right) \sqrt{\frac{P}{EA}} = \frac{2.0(5)}{2(0.0501)} \sqrt{\frac{P}{70(10^9)(3.1)(10^{-3})}} = 6.7749(10^{-3}) \sqrt{P}$$

$$95(10^6)(3.1)(10^{-3}) = P \left[1 + 0.6741 \sec(6.7749(10^{-3}) \sqrt{P}) \right]$$

By trial and error :

$$P = 45.61 \text{ kN} \quad P_{\text{allow}} = \frac{45.61}{3} = 15.2 \text{ kN}$$

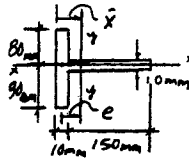

From *Mechanics of Materials*, Sixth Edition by R. C. Hibbeler, ISBN 0-13-191345-X.
 © 2005 R. C. Hibbeler. Published by Pearson Prentice Hall,
 Pearson Education, Inc., Upper Saddle River, NJ. All rights reserved.
 This material is protected under all copyright laws as they currently exist. No portion of this material may be reproduced, in any form or by any means, without permission in writing from the publisher.

13-62 A $W 10 \times 15$ structural A-36 steel member is used as a fixed-connected column. Determine the maximum eccentric load P that can be applied so the column does not buckle or yield. Compare this value with an axial critical load P' applied through the centroid of the column.

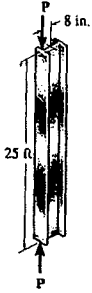

Section properties for $W 10 \times 15$

$$A = 4.41 \text{ in}^2 \quad d = 9.99 \text{ in.} \quad I_x = 68.9 \text{ in}^4 \quad r_x = 3.95 \text{ in.} \quad I_y = 2.89 \text{ in}^4$$

Buckling about $y-y$ axis :

$$P' = P = P_{cr} = \frac{\pi^2 E I}{(K L)^2} = \frac{\pi^2 (29)(10^3)(2.89)}{[0.5(25)(12)]^2}$$

$$= 36.8 \text{ kip} \quad (\text{controls}) \quad \text{Ans}$$

$$\sigma_{cr} = \frac{P_{cr}}{A} = \frac{36.8}{4.41} = 8.34 \text{ ksi} < \sigma_y = 36 \text{ ksi} \quad \text{OK}$$

Yielding about $x-x$ axis :

$$\sigma_{max} = \frac{P}{A} \left[1 + \frac{e c}{r^2} \sec \left(\frac{K L}{2 r} \sqrt{\frac{P}{E A}} \right) \right]$$

$$\frac{e c}{r^2} = \frac{8 \left(\frac{9.99}{2} \right)}{(3.95)^2} = 2.561128$$

$$\frac{K L}{2 r} \sqrt{\frac{P}{E A}} = \frac{0.5(25)(12)}{2(3.95)} \sqrt{\frac{P}{29(10^3)(4.41)}} = 0.05309 \sqrt{P}$$

$$36(4.41) = P [1 + 2.561128 \sec(0.05309 \sqrt{P})]$$

By trial and error,

$$P = 42.6 \text{ kip}$$

From *Mechanics of Materials*, Sixth Edition by R. C. Hibbeler, ISBN 0-13-191345-X.

© 2005 R. C. Hibbeler. Published by Pearson Prentice Hall,

Pearson Education, Inc., Upper Saddle River, NJ. All rights reserved.

This material is protected under all copyright laws as they currently exist. No portion of this material may be reproduced, in any form or by any means, without permission in writing from the publisher.

13-63 Solve Prob. 13-62 if the column is pin-connected at its ends.

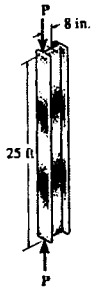

Section properties for W 10 x 15

$$A = 4.41 \text{ in}^2 \quad d = 9.99 \text{ in.} \quad I_x = 68.9 \text{ in}^4 \quad r_x = 3.95 \text{ in.} \quad I_y = 2.89 \text{ in}^4$$

Buckling about y-y axis :

$$P' = P = P_{cr} = \frac{\pi^2 E I}{(K L)^2} = \frac{\pi^2 (29)(10^3)(2.89)}{[1.0 (25)(12)]^2}$$

$$= 9.19 \text{ kip} \quad (\text{controls}) \quad \mathbf{Ans}$$

$$\sigma_{cr} = \frac{P_{cr}}{A} = \frac{9.19}{4.41} = 2.08 \text{ ksi} < \sigma_y = 36 \text{ ksi} \quad \mathbf{OK}$$

Yielding about x-x axis :

$$\sigma_{max} = \frac{P}{A} \left[1 + \frac{e c}{r^2} \sec \left(\frac{K L}{2 r} \sqrt{\frac{P}{E A}} \right) \right]$$

$$\frac{e c}{r^2} = \frac{8 \left(\frac{9.99}{2} \right)}{(3.95)^2} = 2.561128024$$

$$\frac{K L}{2 r} \sqrt{\frac{P}{E A}} = \frac{1.0 (25)(12)}{2 (3.95)} \sqrt{\frac{P}{29 (10^3)(4.41)}} = 0.106188104 \sqrt{P}$$

$$36 (4.41) = P [1 + 2.561128 \sec (0.106188104 \sqrt{P})]$$

By trial and error,

$$P = 37.6 \text{ kip}$$

From *Mechanics of Materials*, Sixth Edition by R. C. Hibbeler, ISBN 0-13-191345-X.

© 2005 R. C. Hibbeler. Published by Pearson Prentice Hall,

Pearson Education, Inc., Upper Saddle River, NJ. All rights reserved.

This material is protected under all copyright laws as they currently exist. No portion of this material may be reproduced, in any form or by any means, without permission in writing from the publisher.

*13-64 Solve Prob. 13-62 if the column is fixed at its bottom and pinned at its top.

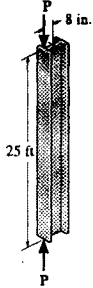

Section properties for W 10 x 15

$$A = 4.41 \text{ in}^2 \quad d = 9.99 \text{ in.} \quad I_x = 68.9 \text{ in}^4 \quad r_x = 3.95 \text{ in.} \quad I_y = 2.89 \text{ in}^4$$

Buckling about $y-y$ axis :

$$P' = P = P_{cr} = \frac{\pi^2 E I}{(K L)^2} = \frac{\pi^2 (29)(10^3)(2.89)}{[0.7(25)(12)]^2}$$

$$= 18.8 \text{ kip} \quad (\text{controls}) \quad \text{Ans}$$

$$\sigma_{cr} = \frac{P_{cr}}{A} = \frac{18.8}{4.41} = 4.25 \text{ ksi} < \sigma_Y = 36 \text{ ksi} \quad \text{OK}$$

Yielding about $x-x$ axis :

$$\sigma_{max} = \frac{P}{A} \left[1 + \frac{e c}{r^2} \sec \left(\frac{K L}{2 r} \sqrt{\frac{P}{E A}} \right) \right]$$

$$\frac{e c}{r^2} = \frac{8 \left(\frac{9.99}{2} \right)}{(3.95)^2} = 2.561128024$$

$$\frac{K L}{2 r} \sqrt{\frac{P}{E A}} = \frac{0.7(25)(12)}{2(3.95)} \sqrt{\frac{P}{29(10^3)(4.41)}} = 0.074331673 \sqrt{P}$$

$$36(4.41) = P [1 + 2.561128024 \sec(0.074331673 \sqrt{P})]$$

By trial and error,

$$P = 40.9 \text{ kip}$$

From *Mechanics of Materials*, Sixth Edition by R. C. Hibbeler, ISBN 0-13-191345-X.

© 2005 R. C. Hibbeler. Published by Pearson Prentice Hall,

Pearson Education, Inc., Upper Saddle River, NJ. All rights reserved.

This material is protected under all copyright laws as they currently exist. No portion of this material may be reproduced, in any form or by any means, without permission in writing from the publisher.

13-65 The $W 14 \times 53$ structural A-36 steel column is fixed at its base and free at its top. If $P = 75$ kip, determine the sideway deflection at its top and the maximum stress in the column.



Section properties for a $W 14 \times 53$:

$$A = 15.6 \text{ in}^2 \quad I_x = 541 \text{ in}^4 \quad I_y = 57.7 \text{ in}^4$$

$$r_x = 5.89 \text{ in.} \quad d = 13.92 \text{ in.}$$

Maximum deflection :

$$v_{\max} = e \left[\sec \left(\sqrt{\frac{P KL}{EI}} \right) - 1 \right]$$

$$\sqrt{\frac{P KL}{EI}} = \sqrt{\frac{75}{29(10^3)541}} \left(\frac{2.0(18)(12)}{2} \right) = 0.472267$$

$$v_{\max} = 10 [\sec(0.472267) - 1] = 1.23 \text{ in.} \quad \text{Ans}$$

Maximum stress :

$$\sigma_{\max} = \frac{P}{A} \left[1 + \frac{ec}{r^2} \sec \left(\frac{KL}{2r} \sqrt{\frac{P}{EA}} \right) \right]$$

$$\frac{P}{A} = \frac{75}{15.6} = 4.808 \text{ ksi}$$

$$\frac{ec}{r^2} = \frac{10 \left(\frac{13.92}{2} \right)}{5.89^2} = 2.0062$$

$$\frac{KL}{2r} \sqrt{\frac{P}{EA}} = \frac{2.0(18)(12)}{2(5.89)} \sqrt{\frac{75}{29(10^3)(15.6)}} = 0.47218$$

$$\sigma_{\max} = 4.808 [1 + 2.0062 \sec(0.47218)] = 15.6 \text{ ksi} < \sigma_Y \quad \text{Ans}$$

From *Mechanics of Materials*, Sixth Edition by R. C. Hibbeler, ISBN 0-13-191345-X.

© 2005 R. C. Hibbeler. Published by Pearson Prentice Hall,

Pearson Education, Inc., Upper Saddle River, NJ. All rights reserved.

This material is protected under all copyright laws as they currently exist. No portion of this material may be reproduced, in any form or by any means, without permission in writing from the publisher.

13-66 The $W 14 \times 53$ steel column is fixed at its base and free at its top. Determine the maximum eccentric load P that it can support without causing it to buckle or yield. $E_{st} = 29(10^3)$ ksi, $\sigma_Y = 50$ ksi.



Section properties for a $W 14 \times 53$:

$$A = 15.6 \text{ in}^2 \quad I_x = 541 \text{ in}^4 \quad I_y = 57.7 \text{ in}^4$$

$$r_x = 5.89 \text{ in.} \quad d = 13.92 \text{ in.}$$

Buckling about $y-y$ axis :

$$P = P_{cr} = \frac{\pi^2 EI}{(KL)^2} = \frac{\pi^2 (29)(10^3)(57.7)}{[(2.0)(18)(12)]^2} = 88.5 \text{ kip} \quad \text{controls} \quad \text{Ans}$$

$$\text{Check :} \quad \sigma_{cr} = \frac{P_{cr}}{A} = \frac{88.5}{15.6} = 5.67 \text{ ksi} < \sigma_Y \quad \text{OK}$$

Yielding about $x-x$ axis :

$$\sigma_{max} = \frac{P}{A} \left[1 + \frac{ec}{r^2} \sec \left(\frac{KL}{2r} \sqrt{\frac{P}{EA}} \right) \right]$$

$$\frac{ec}{r^2} = \frac{10 \left(\frac{13.92}{2} \right)}{5.89^2} = 2.0062$$

$$\left(\frac{KL}{2r} \right) \sqrt{\frac{P}{EA}} = \frac{2.0(18)(12)}{2(5.89)} \sqrt{\frac{P}{29(10^3)(15.6)}} = 0.054523 \sqrt{P}$$

$$50(15.6) = P [1 + 2.0062 \sec (0.054523 \sqrt{P})]$$

By trial and error :

$$P = 204 \text{ kip}$$

From *Mechanics of Materials*, Sixth Edition by R. C. Hibbeler, ISBN 0-13-191345-X.

© 2005 R. C. Hibbeler. Published by Pearson Prentice Hall,

Pearson Education, Inc., Upper Saddle River, NJ. All rights reserved.

This material is protected under all copyright laws as they currently exist. No portion of this material may be reproduced, in any form or by any means, without permission in writing from the publisher.

13-67. The $W10 \times 45$ structural A-36 steel column is assumed to be pinned at its top and fixed at its bottom. If the 12-kip load is applied at an eccentric distance of 8 in., determine the maximum stress in the column.

Section properties for $W10 \times 45$:

$$A = 13.3 \text{ in}^2 \quad I_x = 248 \text{ in}^4 \quad I_y = 53.4 \text{ in}^4$$

$$r_x = 4.32 \text{ in.} \quad d = 10.10 \text{ in.}$$



Secant formula :

$$\sigma_{\max} = \frac{P}{A} \left[1 + \frac{ec}{r^2} \sec \left(\frac{KL}{2r} \sqrt{\frac{P}{EA}} \right) \right]$$

$$\frac{P}{A} = \frac{12}{13.3} = 0.90226 \text{ ksi}$$

$$\frac{ec}{r^2} = \frac{8 \left(\frac{10.10}{2} \right)}{4.32^2} = 2.16478$$

$$\left(\frac{KL}{2r} \right) \sqrt{\frac{P}{EA}} = \frac{0.7(18)(12)}{2(4.32)} \sqrt{\frac{12}{29(10^3)(13.3)}} = 0.097612$$

$$\sigma_{\max} = 0.90226 [1 + 2.16478 \sec (0.097612)] = 2.86 \text{ ksi} \quad \text{Ans}$$

From *Mechanics of Materials*, Sixth Edition by R. C. Hibbeler, ISBN 0-13-191345-X.

© 2005 R. C. Hibbeler. Published by Pearson Prentice Hall,

Pearson Education, Inc., Upper Saddle River, NJ. All rights reserved.

This material is protected under all copyright laws as they currently exist. No portion of this material may be reproduced, in any form or by any means, without permission in writing from the publisher.

*13-68 The $W 10 \times 45$ structural A-36 steel column is assumed to be fixed at its top and bottom. If the 12-kip load is applied at an eccentric distance of 8 in., determine the maximum stress in the column.

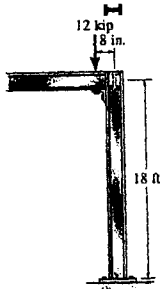

Section properties for $W 10 \times 45$:

$$A = 13.3 \text{ in}^2 \quad I_x = 248 \text{ in}^4 \quad I_y = 53.4 \text{ in}^4$$

$$r_x = 4.32 \text{ in.} \quad d = 10.10 \text{ in.}$$

Secant formula :

$$\sigma_{\max} = \frac{P}{A} \left[1 + \frac{ec}{r^2} \sec \left(\frac{KL}{2r} \sqrt{\frac{P}{EA}} \right) \right]$$

$$\frac{P}{A} = \frac{12}{13.3} = 0.90226 \text{ ksi}$$

$$\frac{ec}{r^2} = \frac{8 \left(\frac{10.10}{2} \right)}{4.32^2} = 2.16478$$

$$\left(\frac{KL}{2r} \right) \sqrt{\frac{P}{EA}} = \frac{0.5(18)(12)}{2(4.32)} \sqrt{\frac{12}{29(10^3)(13.3)}} = 0.069723$$

$$\sigma_{\max} = 0.90226 [1 + 2.16478 \sec (0.069723)] = 2.86 \text{ ksi} \quad \text{Ans}$$

From *Mechanics of Materials*, Sixth Edition by R. C. Hibbeler, ISBN 0-13-191345-X.

© 2005 R. C. Hibbeler. Published by Pearson Prentice Hall,

Pearson Education, Inc., Upper Saddle River, NJ. All rights reserved.

This material is protected under all copyright laws as they currently exist. No portion of this material may be reproduced, in any form or by any means, without permission in writing from the publisher.

13-69 The aluminum rod is fixed at its base and free at its top. If the eccentric load $P = 200$ kN is applied, determine the greatest allowable length L of the rod so that it does not buckle or yield. $E_{al} = 72$ GPa, $\sigma_Y = 410$ MPa.

Section properties :

$$A = \pi (0.1^2) = 0.031416 \text{ m}^2 \quad I = \frac{\pi}{4} (0.1^4) = 78.54(10^{-6}) \text{ m}^4$$

$$r = \sqrt{\frac{I}{A}} = \sqrt{\frac{78.54(10^{-6})}{0.031416}} = 0.05 \text{ m}$$

Yielding :

$$\sigma_{\max} = \frac{P}{A} \left[1 + \frac{ec}{r^2} \sec \left(\frac{KL}{2r} \sqrt{\frac{P}{EA}} \right) \right]$$

$$\frac{P}{A} = \frac{200(10^3)}{0.031416} = 6.3662(10^6) \text{ Pa}$$

$$\frac{ec}{r^2} = \frac{0.005(0.1)}{(0.05)^2} = 0.2$$

$$\left(\frac{KL}{2r} \right) \sqrt{\frac{P}{EA}} = \frac{2.0(L)}{2(0.05)} \sqrt{\frac{200(10^3)}{72(10^9)(0.031416)}} = 0.188063L$$

$$410(10^6) = 6.3662(10^6) [1 + 0.2 \sec(0.188063L)]$$

$$L = 8.34 \text{ m} \quad (\text{controls}) \quad \text{Ans}$$

Buckling about $x-x$ axis :

$$\frac{P}{A} = 6.36 \text{ MPa} < \sigma_Y \quad \text{Euler formula is valid.}$$

$$P_{cr} = \frac{\pi^2 EI}{(KL)^2}$$

$$200(10^3) = \frac{\pi^2 (72)(10^9)(78.54)(10^{-6})}{[(2.0)(L)]^2}$$

$$L = 8.35 \text{ m}$$

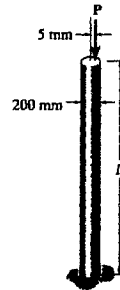

From *Mechanics of Materials*, Sixth Edition by R. C. Hibbeler, ISBN 0-13-191345-X.

© 2005 R. C. Hibbeler. Published by Pearson Prentice Hall,

Pearson Education, Inc., Upper Saddle River, NJ. All rights reserved.

This material is protected under all copyright laws as they currently exist. No portion of this material may be reproduced, in any form or by any means, without permission in writing from the publisher.

13-70 The aluminum rod is fixed at its base and free at its top. If the length of the rod is $L = 2$ m, determine the greatest allowable load P that can be applied so that the rod does not buckle or yield. Also, determine the largest sideways deflection of the rod due to the loading. $E_{al} = 72$ GPa, $\sigma_Y = 410$ MPa.

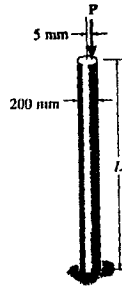

Section properties :

$$A = \pi (0.1^2) = 0.031416 \text{ m}^2 \quad I = \frac{\pi}{4} (0.1^4) = 78.54(10^{-6}) \text{ m}^4$$

$$r = \sqrt{\frac{I}{A}} = \sqrt{\frac{78.54(10^{-6})}{0.031416}} = 0.05 \text{ m}$$

Yielding :

$$\sigma_{\max} = \frac{P}{A} \left[1 + \frac{ec}{r^2} \sec \left(\frac{KL}{2r} \sqrt{\frac{P}{EA}} \right) \right]$$

$$\frac{ec}{r^2} = \frac{(0.005)(0.1)}{0.05^2} = 0.2$$

$$\left(\frac{KL}{2r} \right) \sqrt{\frac{P}{EA}} = \frac{2(2)}{2(0.05)} \sqrt{\frac{P}{72(10^9)(0.031416)}} = 0.8410(10^{-3}) \sqrt{P}$$

$$410(10^6)(0.031416) = P \left[1 + 0.2 \sec (0.8410(10^{-3}) \sqrt{P}) \right]$$

By trial and error :

$$P = 3.20 \text{ MN} \quad (\text{controls}) \quad \text{Ans}$$

Buckling :

$$P = P_{cr} = \frac{\pi^2 EI}{(KL)^2} = \frac{\pi^2 (72)(10^9)(78.54)(10^{-6})}{[(2.0)(2)]^2} = 3488 \text{ kN}$$

$$\text{Check : } \sigma_{cr} = \frac{P_{cr}}{A} = \frac{3488(10^3)}{0.031416} = 111 \text{ MPa} < \sigma_Y \quad \text{OK}$$

Maximum deflection :

$$v_{\max} = e \left[\sec \left(\sqrt{\frac{P}{EI}} \frac{KL}{2} \right) - 1 \right]$$

$$\sqrt{\frac{P}{EI}} \frac{KL}{2} = \sqrt{\frac{3.20(10^6)}{72(10^9)(78.54)(10^{-6})}} \left(\frac{2.0(2)}{2} \right) = 1.5045$$

$$v_{\max} = 5 \left[\sec(1.5045) - 1 \right] = 70.5 \text{ mm} \quad \text{Ans}$$

From *Mechanics of Materials*, Sixth Edition by R. C. Hibbeler, ISBN 0-13-191345-X.

© 2005 R. C. Hibbeler. Published by Pearson Prentice Hall,

Pearson Education, Inc., Upper Saddle River, NJ. All rights reserved.

This material is protected under all copyright laws as they currently exist. No portion of this material may be reproduced, in any form or by any means, without permission in writing from the publisher.

13-71. Construct the buckling curve, P/A versus L/r , for a column that has a bilinear stress-strain curve in compression as shown.

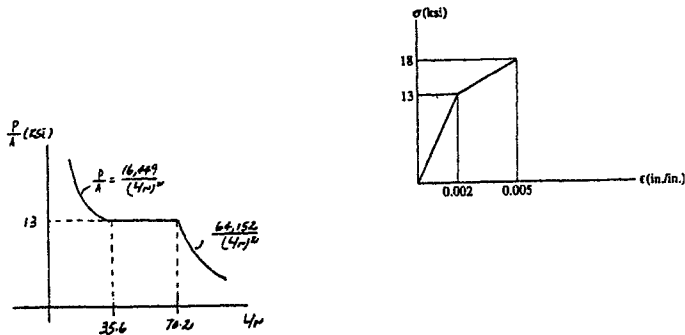

$$E_1 = \frac{13}{0.002} = 6.5 (10^3) \text{ ksi}$$

$$E_2 = \frac{18 - 13}{0.005 - 0.002} = 1.6667 (10^3) \text{ ksi}$$

For $E_t = E_1$

$$\sigma_{cr} = \frac{P}{A} = \frac{\pi^2 E_t}{\left(\frac{L}{r}\right)^2} = \frac{\pi^2 (6.5)(10^3)}{\left(\frac{L}{r}\right)^2} = \frac{64152}{\left(\frac{L}{r}\right)^2}$$

$$\sigma_{cr} = 13 = \frac{\pi^2 (6.5)(10^3)}{\left(\frac{L}{r}\right)^2}; \quad \frac{L}{r} = 70.2$$

For $E_t = E_2$

$$\sigma_{cr} = \frac{P}{A} = \frac{\pi^2 (1.6667)(10^3)}{\left(\frac{L}{r}\right)^2} = \frac{16449}{\left(\frac{L}{r}\right)^2}$$

$$\sigma_{cr} = 13 = \frac{\pi^2 (1.6667)(10^3)}{\left(\frac{L}{r}\right)^2}; \quad \frac{L}{r} = 35.6$$

From *Mechanics of Materials*, Sixth Edition by R. C. Hibbeler, ISBN 0-13-191345-X.

© 2005 R. C. Hibbeler. Published by Pearson Prentice Hall,

Pearson Education, Inc., Upper Saddle River, NJ. All rights reserved.

This material is protected under all copyright laws as they currently exist. No portion of this material may be reproduced, in any form or by any means, without permission in writing from the publisher.

*13-72 Construct the buckling curve, P/A versus L/r , for a column that has a bilinear stress-strain curve in compression as shown.

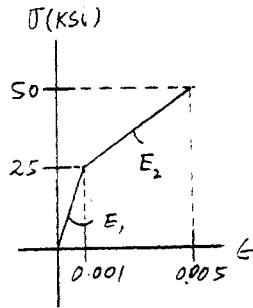
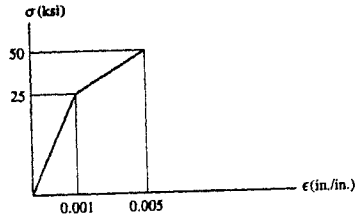

From Fig. (a) :

$$E_1 = \frac{25}{0.001} = 25 (10^3) \text{ ksi}$$

$$E_2 = \frac{50 - 25}{0.005 - 0.001} = 6.25 (10^3) \text{ ksi}$$

For $E_t = E_1$

$$\begin{aligned} \sigma_{cr} &= \frac{P}{A} = \frac{\pi^2 E_t}{\left(\frac{L}{r}\right)^2} \\ &= \frac{\pi^2 (25)(10^3)}{\left(\frac{L}{r}\right)^2} = \frac{247 (10^3)}{\left(\frac{L}{r}\right)^2} \end{aligned}$$

$$\sigma_{cr} = 25 = \frac{\pi^2 (25)(10^3)}{\left(\frac{L}{r}\right)^2}; \quad \frac{L}{r} = 99.3$$

For $E_t = E_2$

$$\begin{aligned} \sigma_{cr} &= \frac{P}{A} = \frac{\pi^2 (6.25)(10^3)}{\left(\frac{L}{r}\right)^2} \\ &= \frac{61.7 (10^3)}{\left(\frac{L}{r}\right)^2} \end{aligned}$$

$$\sigma_{cr} = 25 = \frac{\pi^2 (6.25)(10^3)}{\left(\frac{L}{r}\right)^2}; \quad \frac{L}{r} = 49.7$$

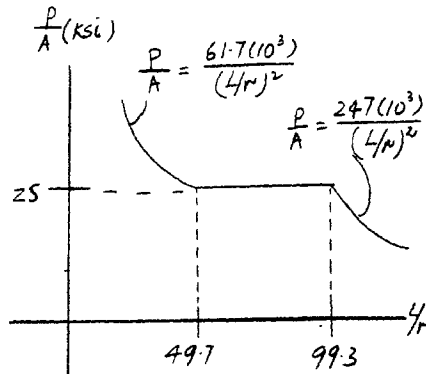

From *Mechanics of Materials*, Sixth Edition by R. C. Hibbeler, ISBN 0-13-191345-X.

© 2005 R. C. Hibbeler. Published by Pearson Prentice Hall,

Pearson Education, Inc., Upper Saddle River, NJ. All rights reserved.

This material is protected under all copyright laws as they currently exist. No portion of this material may be reproduced, in any form or by any means, without permission in writing from the publisher.

13-73 A column of intermediate length buckles when the compressive strength is 40 ksi. If the slenderness ratio is 60, determine the tangent modulus.

$$\sigma_{cr} = \frac{\pi^2 E_t}{\left(\frac{KL}{r}\right)^2}; \quad \left(\frac{KL}{r}\right) = 60$$

$$40 = \frac{\pi^2 E_t}{(60)^2}$$

$$E_t = 14590 \text{ ksi} = 14.6 (10^3) \text{ ksi} \quad \text{Ans}$$

From *Mechanics of Materials*, Sixth Edition by R. C. Hibbeler, ISBN 0-13-191345-X.

© 2005 R. C. Hibbeler. Published by Pearson Prentice Hall,

Pearson Education, Inc., Upper Saddle River, NJ. All rights reserved.

This material is protected under all copyright laws as they currently exist. No portion of this material may be reproduced, in any form or by any means, without permission in writing from the publisher.

13-74 The stress-strain diagram for a material can be approximated by the two line segments shown. If a bar having a diameter of 80 mm and a length of 1.5 m is made from this material, determine the critical load provided the ends are pinned. Assume that the load acts through the axis of the bar. Use Engesser's equation.

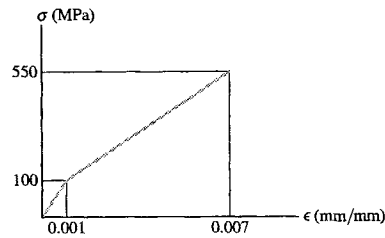

$$E_1 = \frac{100 (10^6)}{0.001} = 100 \text{ GPa}$$

$$E_2 = \frac{550 (10^6) - 100 (10^6)}{0.007 - 0.001} = 75 \text{ GPa}$$

Section properties :

$$I = \frac{\pi}{4} c^4; \quad A = \pi c^2$$

$$r = \sqrt{\frac{I}{A}} = \sqrt{\frac{\frac{\pi}{4} c^4}{\pi c^2}} = \frac{c}{2} = \frac{0.04}{2} = 0.02 \text{ m}$$

Engesser's equation :

$$\frac{KL}{r} = \frac{1.0 (1.5)}{0.02} = 75$$

$$\sigma_{cr} = \frac{\pi^2 E_t}{\left(\frac{KL}{r}\right)^2} = \frac{\pi^2 E_t}{(75)^2} = 1.7546 (10^{-3}) E_t$$

Assume $E_t = E_1 = 100 \text{ GPa}$

$$\sigma_{cr} = 1.7546 (10^{-3}) (200)(10^9) = 175 \text{ MPa} > 100 \text{ MPa}$$

Therefore, inelastic buckling occurs :

Assume $E_t = E_2 = 75 \text{ GPa}$

$$\sigma_{cr} = 1.7546 (10^{-3}) (75)(10^9) = 131.6 \text{ MPa}$$

$$100 \text{ MPa} < \sigma_{cr} < 550 \text{ MPa} \quad \text{OK}$$

Critical load :

$$P_{cr} = \sigma_{cr} A = 131.6 (10^6) (\pi) (0.04^2) = 661 \text{ kN} \quad \text{Ans}$$

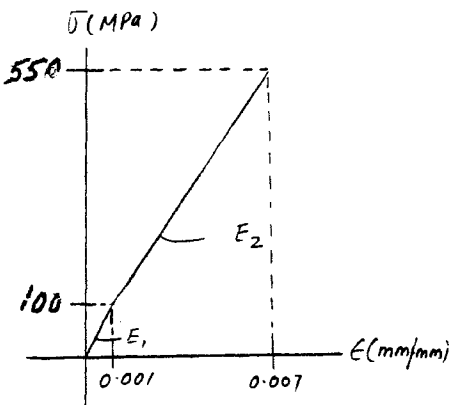

From *Mechanics of Materials*, Sixth Edition by R. C. Hibbeler, ISBN 0-13-191345-X.

© 2005 R. C. Hibbeler. Published by Pearson Prentice Hall,

Pearson Education, Inc., Upper Saddle River, NJ. All rights reserved.

This material is protected under all copyright laws as they currently exist. No portion of this material may be reproduced, in any form or by any means, without permission in writing from the publisher.

13-75 The stress-strain diagram for a material can be approximated by the two line segments shown. If a bar having a diameter of 80 mm and a length of 1.5 m is made from this material, determine the critical load provided the ends are fixed. Assume that the load acts through the axis of the bar. Use Engesser's equation.

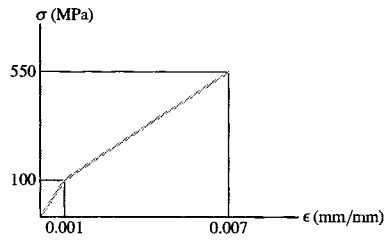

$$E_1 = \frac{100 (10^6)}{0.001} = 100 \text{ GPa}$$

$$E_2 = \frac{550 (10^6) - 100 (10^6)}{0.007 - 0.001} = 75 \text{ GPa}$$

Section properties :

$$I = \frac{\pi}{4} c^4; \quad A = \pi c^2$$

$$r = \sqrt{\frac{I}{A}} = \sqrt{\frac{\frac{\pi}{4} c^4}{\pi c^2}} = \frac{c}{2} = \frac{0.04}{2} = 0.02 \text{ m}$$

Engesser's equation :

$$\frac{KL}{r} = \frac{0.5 (1.5)}{0.02} = 37.5$$

$$\sigma_{cr} = \frac{\pi^2 E_t}{\left(\frac{KL}{r}\right)^2} = \frac{\pi^2 E_t}{(37.5)^2} = 7.018385 (10^{-3}) E_t$$

Assume $E_t = E_1 = 100 \text{ GPa}$

$$\sigma_{cr} = 7.018385 (10^{-3}) (100)(10^9) = 701.8 \text{ MPa} > 100 \text{ MPa} \quad \text{NG}$$

Assume $E_t = E_2 = 75 \text{ GPa}$

$$\sigma_{cr} = 7.018385 (10^{-3}) (75)(10^9) = 526.4 \text{ MPa}$$

$$100 \text{ MPa} < \sigma_{cr} < 550 \text{ MPa} \quad \text{OK}$$

Critical load :

$$P_{cr} = \sigma_{cr} A = 526.4 (10^6)(\pi)(0.04^2) = 2645.9 \text{ kN} \quad \text{Ans}$$

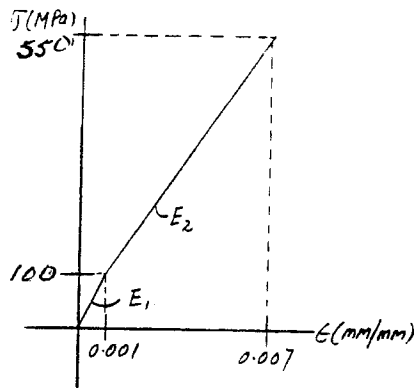

From *Mechanics of Materials*, Sixth Edition by R. C. Hibbeler, ISBN 0-13-191345-X.

© 2005 R. C. Hibbeler. Published by Pearson Prentice Hall,

Pearson Education, Inc., Upper Saddle River, NJ. All rights reserved.

This material is protected under all copyright laws as they currently exist. No portion of this material may be reproduced, in any form or by any means, without permission in writing from the publisher.

*13-76 The stress-strain diagram for a material can be approximated by the two line segments shown. If a bar having a diameter of 80 mm and length of 1.5 m is made from this material, determine the critical load provided one end is pinned and the other is fixed. Assume that the load acts through the axis of the bar. Use Engesser's equation.

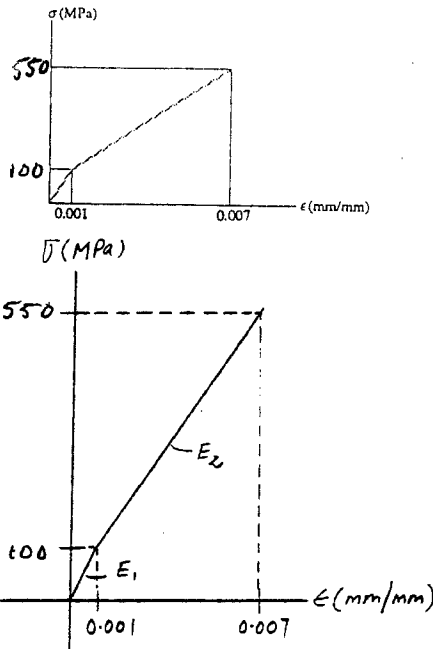

$$E_1 = \frac{100 (10^6)}{0.001} = 100 \text{ GPa}$$

$$E_2 = \frac{550 (10^6) - 100 (10^6)}{0.007 - 0.001} = 75 \text{ GPa}$$

Section properties :

$$I = \frac{\pi}{4} c^4; \quad A = \pi c^2$$

$$r = \sqrt{\frac{I}{A}} = \sqrt{\frac{\frac{\pi}{4} c^4}{\pi c^2}} = \frac{c}{2} = \frac{0.04}{2} = 0.02 \text{ m}$$

Engesser's equation :

$$\frac{KL}{r} = \frac{0.7 (1.5)}{0.02} = 52.5$$

$$\sigma_{cr} = \frac{\pi^2 E_t}{\left(\frac{KL}{r}\right)^2} = \frac{\pi^2 E_t}{(52.5)^2} = 3.58081 (10^{-3}) E_t$$

Assume $E_t = E_1 = 100 \text{ GPa}$

$$\sigma_{cr} = 3.58081 (10^{-3}) (100) (10^9) = 358.1 \text{ MPa} > 100 \text{ MPa} \quad \text{NG}$$

Assume $E_t = E_2 = 75 \text{ GPa}$

$$\sigma_{cr} = 3.58081 (10^{-3}) (75) (10^9) = 268.6 \text{ MPa}$$

$$100 \text{ MPa} < \sigma_{cr} < 550 \text{ MPa} \quad \text{OK}$$

Critical load :

$$P_{cr} = \sigma_{cr} A = 268.6 (10^6) (\pi) (0.04^2) = 1350 \text{ kN} \quad \text{Ans}$$

From *Mechanics of Materials*, Sixth Edition by R. C. Hibbeler, ISBN 0-13-191345-X.

© 2005 R. C. Hibbeler. Published by Pearson Prentice Hall,

Pearson Education, Inc., Upper Saddle River, NJ. All rights reserved.

This material is protected under all copyright laws as they currently exist. No portion of this material may be reproduced, in any form or by any means, without permission in writing from the publisher.

13-77. Determine the largest length of a $W10 \times 12$ structural A-36 steel section if it is pin supported and is subjected to an axial load of 28 kip. Use the AISC equations.

For a $W10 \times 12$, $r_y = 0.785$ in. $A = 3.54$ in²

$$\sigma = \frac{P}{A} = \frac{28}{3.54} = 7.91 \text{ ksi}$$

Assume a long column :

$$\sigma_{\text{allow}} = \frac{12\pi^2 E}{23(KL/r)^2}$$

$$\left(\frac{KL}{r}\right)^2 = \sqrt{\frac{12\pi^2 E}{23\sigma_{\text{allow}}}} = \sqrt{\frac{12\pi^2(29)(10^3)}{23(7.91)}} = 137.4$$

$$\left(\frac{KL}{r}\right)_c = \sqrt{\frac{2\pi^2 E}{\sigma_Y}} = \sqrt{\frac{2\pi^2(29)(10^3)}{36}} = 126.1, \quad \frac{KL}{r} > \left(\frac{KL}{r}\right)_c$$

Long column.

$$\frac{KL}{r} = 137.4$$

$$L = 137.4 \left(\frac{r}{K}\right) = 137.4 \left(\frac{0.785}{1}\right) = 107.86 \text{ in.} \quad \text{Ans.}$$

$$= 8.99 \text{ ft} \quad \text{Ans.}$$

From *Mechanics of Materials*, Sixth Edition by R. C. Hibbeler, ISBN 0-13-191345-X.

© 2005 R. C. Hibbeler. Published by Pearson Prentice Hall,

Pearson Education, Inc., Upper Saddle River, NJ. All rights reserved.

This material is protected under all copyright laws as they currently exist. No portion of this material may be reproduced, in any form or by any means, without permission in writing from the publisher.

13-78 Determine the largest length of a $W 10 \times 12$ structural A-36 steel section if it is fixed supported and is subjected to an axial load of 28 kip. Use the AISC equations.

For a $W 10 \times 12$, $r_y = 0.785$ in. $A = 3.54$ in²

$$\sigma = \frac{P}{A} = \frac{28}{3.54} = 7.91 \text{ ksi}$$

Assume a long column :

$$\sigma_{\text{allow}} = \frac{12\pi^2 E}{23(KL/r)^2}$$

$$\left(\frac{KL}{r}\right)^2 = \frac{12\pi^2 E}{23\sigma_{\text{allow}}} = \sqrt{\frac{12\pi^2 E}{23\sigma_{\text{allow}}}} = \sqrt{\frac{12\pi^2(29)(10^3)}{23(7.91)}} = 137.4$$

$$\left(\frac{KL}{r}\right)_c = \sqrt{\frac{2\pi^2 E}{\sigma_Y}} = \sqrt{\frac{2\pi^2(29)(10^3)}{36}} = 126.1, \quad \frac{KL}{r} > \left(\frac{KL}{r}\right)_c$$

Long column.

$$\frac{KL}{r} = 137.4$$

$$L = 137.4\left(\frac{r}{K}\right) = 137.4\left(\frac{0.785}{0.5}\right) = 215.72 \text{ in.}$$

$$L = 18.0 \text{ ft} \quad \mathbf{Ans}$$

From *Mechanics of Materials*, Sixth Edition by R. C. Hibbeler, ISBN 0-13-191345-X.

© 2005 R. C. Hibbeler. Published by Pearson Prentice Hall,

Pearson Education, Inc., Upper Saddle River, NJ. All rights reserved.

This material is protected under all copyright laws as they currently exist. No portion of this material may be reproduced, in any form or by any means, without permission in writing from the publisher.

13-79. Determine the largest length of a $W8 \times 31$ structural A-36 steel section if it is pin supported and is subjected to an axial load of 130 kip. Use the AISC equations.

For a $W8 \times 31$, $A = 9.13 \text{ in}^2$ $r_y = 2.02 \text{ in}$.

$$\sigma = \frac{P}{A} = \frac{130}{9.13} = 14.239 \text{ ksi}$$

Assume a long column :

$$\sigma_{\text{allow}} = \frac{12\pi^2 E}{23(KL/r)^2}$$

$$\left(\frac{KL}{r}\right) = \sqrt{\frac{12\pi^2 E}{23\sigma_{\text{allow}}}} = \sqrt{\frac{12\pi^2(29)(10^3)}{23(14.239)}} = 102.4$$

$$\left(\frac{KL}{r}\right)_c = \sqrt{\frac{2\pi^2 E}{\sigma_y}} = \sqrt{\frac{2\pi^2(29)(10^3)}{36}} = 126.1, \quad \frac{KL}{r} < \left(\frac{KL}{r}\right)_c$$

Intermediate column

$$\sigma_{\text{allow}} = \frac{[1 - \frac{1}{2}(\frac{KL/r}{(KL/r)_c})^2]\sigma_y}{[\frac{5}{8} + \frac{3}{8}(\frac{KL/r}{(KL/r)_c}) - \frac{1}{8}(\frac{KL/r}{(KL/r)_c})^3]}$$

$$14.239 = \frac{[1 - \frac{1}{2}(\frac{KL/r}{126.1})^2]36}{[\frac{5}{8} + \frac{3}{8}(\frac{KL/r}{126.1}) - \frac{1}{8}(\frac{KL/r}{126.1})^3]}$$

$$1.132(10^{-3})\left(\frac{KL}{r}\right)^2 + 0.042344\left(\frac{KL}{r}\right) - 0.887655(10^{-6})\left(\frac{KL}{r}\right)^3 = 12.268$$

By trial and error :

$$\frac{KL}{r} = 89.71$$

$$L = 89.71\left(\frac{2.02}{1.0}\right) = 181.21 \text{ in.} = 15.1 \text{ ft} \quad \text{Ans}$$

From *Mechanics of Materials*, Sixth Edition by R. C. Hibbeler, ISBN 0-13-191345-X.

© 2005 R. C. Hibbeler. Published by Pearson Prentice Hall,

Pearson Education, Inc., Upper Saddle River, NJ. All rights reserved.

This material is protected under all copyright laws as they currently exist. No portion of this material may be reproduced, in any form or by any means, without permission in writing from the publisher.

***13-80** Determine the largest length of a $W 8 \times 31$ structural A-36 steel section if it is pin supported and is subjected to an axial load of 80 kip. Use the AISC equations.

For a $W 8 \times 31$ $A = 9.13 \text{ in}^2$ $r_y = 2.02 \text{ in}$.

$$\sigma = \frac{P}{A} = \frac{80}{9.13} = 8.762 \text{ ksi}$$

Assume a long column :

$$\sigma_{\text{allow}} = \frac{12\pi^2 E}{23(KL/r)^2}$$

$$\left(\frac{KL}{r}\right) = \sqrt{\frac{12\pi^2 E}{23\sigma_{\text{allow}}}} = \sqrt{\frac{12\pi^2(29)(10^3)}{23(8.762)}} = 130.54$$

$$\left(\frac{KL}{r}\right)_c = \sqrt{\frac{2\pi^2 E}{\sigma_y}} = \sqrt{\frac{2\pi^2(29)(10^3)}{36}} = 126.1$$

$$\frac{KL}{r} > \left(\frac{KL}{r}\right)_c \quad (\text{Assumption OK})$$

$$\frac{KL}{r} = 130.54$$

$$L = 130.54\left(\frac{2.02}{1.0}\right) = 263.7 \text{ in.} = 22.0 \text{ ft} \quad \text{Ans}$$

From *Mechanics of Materials*, Sixth Edition by R. C. Hibbeler, ISBN 0-13-191345-X.

© 2005 R. C. Hibbeler. Published by Pearson Prentice Hall,

Pearson Education, Inc., Upper Saddle River, NJ. All rights reserved.

This material is protected under all copyright laws as they currently exist. No portion of this material may be reproduced, in any form or by any means, without permission in writing from the publisher.

13-81 Using the AISC equations, select from Appendix B the lightest-weight structural A-36 steel column that is 12 ft long and supports an axial load of 20 kip. The ends are pinned.

Try $W\ 6\times 12$ $A = 3.55\ \text{in}^2$ $r_y = 0.918\ \text{in.}$

$$\left(\frac{KL}{r}\right)_c = \sqrt{\frac{2\pi^2 E}{\sigma_Y}} = \sqrt{\frac{2\pi^2(29)(10^3)}{36}} = 126.1$$

$$\left(\frac{KL}{r_y}\right) = \frac{(1.0)(12)(12)}{0.918} = 156.9, \quad \left(\frac{KL}{r_y}\right) > \left(\frac{KL}{r}\right)_c$$

Long column

$$\sigma_{\text{allow}} = \frac{12\pi^2 E}{23(KL/r)^2} = \frac{12\pi^2(29)(10^3)}{23(156.9)^2} = 6.069\ \text{ksi}$$

$$\begin{aligned} P_{\text{allow}} &= \sigma_{\text{allow}} A \\ &= 6.069(3.55) = 21.5\ \text{kip} > 20\ \text{kip} \quad \text{OK} \end{aligned}$$

Use $W\ 6\times 12$ **Ans**

From *Mechanics of Materials*, Sixth Edition by R. C. Hibbeler, ISBN 0-13-191345-X.

© 2005 R. C. Hibbeler. Published by Pearson Prentice Hall,

Pearson Education, Inc., Upper Saddle River, NJ. All rights reserved.

This material is protected under all copyright laws as they currently exist. No portion of this material may be reproduced, in any form or by any means, without permission in writing from the publisher.

13-82. Using the AISC equations, select from Appendix B the lightest-weight structural steel column that is 14 ft long and supports an axial load of 40 kip. The ends are pinned. Take $\sigma_y = 50$ ksi.

Try, W 6x15 ($A = 4.43 \text{ in}^2$ $r_y = 1.46 \text{ in.}$)

$$\left(\frac{KL}{r}\right)_c = \sqrt{\frac{2\pi^2 E}{\sigma_y}} = \sqrt{\frac{2\pi^2(29)(10^3)}{50}} = 107$$

$$\left(\frac{KL}{r_y}\right) = \frac{(1.0)(14)(12)}{1.46} = 115.1, \quad \left(\frac{KL}{r_y}\right) > \left(\frac{KL}{r}\right)_c$$

Long column

$$\sigma_{\text{allow}} = \frac{12\pi^2 E}{23(KL/r)^2} = \frac{12\pi^2(29)(10^3)}{23(115.1)^2} = 11.28 \text{ ksi}$$

$$P_{\text{allow}} = \sigma_{\text{allow}} A \\ = 11.28(4.43) = 50.0 \text{ kip} > 40 \text{ kip} \quad \text{OK}$$

Use W 6x15 **Ans**

From *Mechanics of Materials*, Sixth Edition by R. C. Hibbeler, ISBN 0-13-191345-X.

© 2005 R. C. Hibbeler. Published by Pearson Prentice Hall,

Pearson Education, Inc., Upper Saddle River, NJ. All rights reserved.

This material is protected under all copyright laws as they currently exist. No portion of this material may be reproduced, in any form or by any means, without permission in writing from the publisher.

13-83. Using the AISC equations, select from Appendix B the lightest-weight structural A-36 steel column that is 12 ft long and supports an axial load of 40 kip. The ends are fixed. Take $\sigma_y = 50$ ksi.

Try W 6x9 $A = 2.68 \text{ in}^2$ $r_y = 0.905 \text{ in}$.

$$\left(\frac{KL}{r}\right)_c = \sqrt{\frac{2\pi^2 E}{\sigma_Y}} = \sqrt{\frac{2\pi^2(29)(10^3)}{36}} = 126.1$$

$$\frac{KL}{r_y} = \frac{0.5(12)(12)}{0.905} = 79.56$$

$$\frac{KL}{r_y} < \left(\frac{KL}{r}\right)_c$$

Intermediate column

$$\sigma_{\text{allow}} = \frac{[1 - \frac{1}{2}(\frac{KL/r}{(KL/r)_c})^2]\sigma_Y}{[\frac{5}{3} + \frac{3}{8}(\frac{KL/r}{(KL/r)_c}) - \frac{1}{8}(\frac{KL/r}{(KL/r)_c})^3]} = \frac{[1 - \frac{1}{2}(\frac{79.56}{126.1})^2]36 \text{ ksi}}{[\frac{5}{3} + \frac{3}{8}(\frac{79.56}{126.1}) - \frac{1}{8}(\frac{79.56}{126.1})^3]} = 15.40 \text{ ksi}$$

$$\begin{aligned} P_{\text{allow}} &= \sigma_{\text{allow}} A \\ &= 15.40(2.68) \\ &= 41.3 \text{ kip} > 40 \text{ kip} \quad \text{OK} \end{aligned}$$

Use W6x9 **Ans**

From *Mechanics of Materials*, Sixth Edition by R. C. Hibbeler, ISBN 0-13-191345-X.

© 2005 R. C. Hibbeler. Published by Pearson Prentice Hall,

Pearson Education, Inc., Upper Saddle River, NJ. All rights reserved.

This material is protected under all copyright laws as they currently exist. No portion of this material may be reproduced, in any form or by any means, without permission in writing from the publisher.

***13-84.** Using the AISC equations, select from Appendix B the lightest-weight structural A-36 steel column that is 14 ft long and supports an axial load of 40 kip. The ends are fixed.

Try W 6x9 $A = 2.68 \text{ in}^2$ $r_y = 0.905 \text{ in.}$

$$\left(\frac{KL}{r}\right)_c = \sqrt{\frac{2\pi^2 E}{\sigma_y}} = \sqrt{\frac{2\pi^2(29)(10^3)}{50}} = 107$$

$$\frac{KL}{r_y} = \frac{0.5(14)(12)}{0.905} = 92.82$$

$$\frac{KL}{r_y} < \left(\frac{KL}{r}\right)_c$$

Intermediate column

$$\sigma_{\text{allow}} = \frac{\left[1 - \frac{1}{2}\left(\frac{KL/r}{(KL/r)_c}\right)^2\right]\sigma_y}{\left[\frac{5}{8} + \frac{3}{8}\left(\frac{KL/r}{(KL/r)_c}\right) - \frac{1}{8}\left(\frac{KL/r}{(KL/r)_c}\right)^3\right]} = \frac{\left[1 - \frac{1}{2}\left(\frac{92.82}{107}\right)^2\right]50}{\left[\frac{5}{8} + \frac{3}{8}\left(\frac{92.82}{107}\right) - \frac{1}{8}\left(\frac{92.82}{107}\right)^3\right]} = 16.33 \text{ ksi}$$

$$\begin{aligned} P_{\text{allow}} &= \sigma_{\text{allow}}A \\ &= 16.33(2.68) \\ &= 43.8 \text{ kip} > 40 \text{ kip} \quad \text{OK} \end{aligned}$$

Use W6x9 **Ans**

From *Mechanics of Materials*, Sixth Edition by R. C. Hibbeler, ISBN 0-13-191345-X.

© 2005 R. C. Hibbeler. Published by Pearson Prentice Hall,

Pearson Education, Inc., Upper Saddle River, NJ. All rights reserved.

This material is protected under all copyright laws as they currently exist. No portion of this material may be reproduced, in any form or by any means, without permission in writing from the publisher.

13-85. Determine the largest length of a $W8 \times 48$ structural A-36 steel section if it is pin supported and is subjected to an axial load of 55 kip. Use the AISC equations.

Section Properties : For a $W8 \times 48$ wide flange section,

$$A = 14.1 \text{ in}^2 \quad r_y = 2.08 \text{ in}$$

Slenderness Ratio : For a column pinned at both ends, $K = 1$. Thus,

$$\left(\frac{KL}{r}\right)_y = \frac{1(L)}{2.08} = 0.4808L$$

AISC Column Formula : Assume it is a long column.

$$\sigma_{\text{allow}} = \frac{12\pi^2 E}{23\left(\frac{KL}{r}\right)^2}$$

$$\frac{55}{14.1} = \frac{12\pi^2 [29(10^3)]}{23(0.4808L)^2}$$

$$L = 407.0 \text{ in.}$$

Here, $\frac{KL}{r} = 0.4808(407.0) = 195.7$ and for A-36 steel, $\left(\frac{KL}{r}\right)_c$

$$= \sqrt{\frac{2\pi^2 E}{\sigma_Y}} = \sqrt{\frac{2\pi^2 [29(10^3)]}{36}} = 126.1. \text{ Since } \left(\frac{KL}{r}\right)_c \leq \frac{KL}{r} \leq 200,$$

the assumption is correct. Thus,

$$L = 407.0 \text{ in.} = 33.9 \text{ ft} \quad \text{Ans}$$

From *Mechanics of Materials*, Sixth Edition by R. C. Hibbeler, ISBN 0-13-191345-X.

© 2005 R. C. Hibbeler. Published by Pearson Prentice Hall,

Pearson Education, Inc., Upper Saddle River, NJ. All rights reserved.

This material is protected under all copyright laws as they currently exist. No portion of this material may be reproduced, in any form or by any means, without permission in writing from the publisher.

13-86 Determine the largest length of a $W 8 \times 31$ structural A-36 steel section if it is pin supported and is subjected to an axial load of 18 kip. Use the AISC equations.

Section properties : For $W 8 \times 31$ $r_y = 2.02$ in. $A = 9.13$ in²

Assume it as a long column :

$$\sigma_{\text{allow}} = \frac{12 \pi^2 E}{23 \left(\frac{KL}{r}\right)^2}; \quad \left(\frac{KL}{r}\right)^2 = \frac{12 \pi^2 E}{23 \sigma_{\text{allow}}}$$

$$\frac{KL}{r} = \sqrt{\frac{12 \pi^2 E}{23 \sigma_{\text{allow}}}}$$

$$\text{Here } \sigma_{\text{allow}} = \frac{P}{A} = \frac{18}{9.13} = 1.9715 \text{ ksi}$$

$$\frac{KL}{r} = \sqrt{\frac{12 \pi^2 (29)(10^3)}{23 (1.9715)}} = 275.2 > 200$$

$$\text{Thus use } \frac{KL}{r} = 200$$

$$\frac{1.0(L)}{2.02} = 200$$

$$L = 404 \text{ in.} = 33.7 \text{ ft} \quad \mathbf{Ans}$$

From *Mechanics of Materials*, Sixth Edition by R. C. Hibbeler, ISBN 0-13-191345-X.

© 2005 R. C. Hibbeler. Published by Pearson Prentice Hall,

Pearson Education, Inc., Upper Saddle River, NJ. All rights reserved.

This material is protected under all copyright laws as they currently exist. No portion of this material may be reproduced, in any form or by any means, without permission in writing from the publisher.

13-87 Using the AISC equations, select from Appendix B the lightest-weight structural A-36 steel column that is 30 ft long and supports an axial load of 200 kip. The ends are fixed.

Try $W 8 \times 48$ $r_y = 2.08$ in. $A = 14.1$ in²

$$\left(\frac{KL}{r}\right)_c = \sqrt{\frac{2 \pi^2 E}{\sigma_Y}} = \sqrt{\frac{2 \pi^2 (29)(10^3)}{36}} = 126.1$$

$$\frac{KL}{r_y} = \frac{0.5(30)(12)}{2.08} = 86.54$$

$$\left(\frac{KL}{r_y}\right) < \left(\frac{KL}{r}\right)_c \text{ intermediate column.}$$

$$\begin{aligned} \sigma_{\text{allow}} &= \frac{\left\{1 - \frac{1}{2} \left[\frac{KL}{\left(\frac{KL}{r}\right)_c}\right]^2\right\} \sigma_Y}{\left\{\frac{5}{3} + \frac{3}{8} \left[\frac{KL}{\left(\frac{KL}{r}\right)_c}\right] - \frac{1}{8} \left[\frac{KL}{\left(\frac{KL}{r}\right)_c}\right]^3\right\}} \\ &= \frac{\left\{1 - \frac{1}{2} \left[\frac{86.54}{126.1}\right]^2\right\} 36}{\left\{\frac{5}{3} + \frac{3}{8} \left[\frac{86.54}{126.1}\right] - \frac{1}{8} \left[\frac{86.54}{126.1}\right]^3\right\}} = 14.611 \text{ ksi} \end{aligned}$$

$$P_{\text{allow}} = \sigma_{\text{allow}} A = 14.611(14.1) = 206 \text{ kip} > P = 200 \text{ kip} \quad \text{OK}$$

Use $W 8 \times 48$ **Ans**

From *Mechanics of Materials*, Sixth Edition by R. C. Hibbeler, ISBN 0-13-191345-X.

© 2005 R. C. Hibbeler. Published by Pearson Prentice Hall,

Pearson Education, Inc., Upper Saddle River, NJ. All rights reserved.

This material is protected under all copyright laws as they currently exist. No portion of this material may be reproduced, in any form or by any means, without permission in writing from the publisher.

*13-88 Determine the largest length of a $W 8 \times 31$ structural A-36 steel column if it is to support an axial load of 10 kip. The ends are pinned.

$$W 8 \times 31 \quad r_y = 2.02 \text{ in.} \quad A = 9.13 \text{ in}^2$$

$$\left(\frac{KL}{r}\right)_c = \sqrt{\frac{2\pi^2 E}{\sigma_Y}} = \sqrt{\frac{2\pi^2 (29)(10^3)}{36}} = 126.1$$

$$\frac{KL}{r_y} = \frac{1.0L}{2.02}$$

$$\text{Assume } \frac{KL}{r_y} > \left(\frac{KL}{r}\right)_c$$

$$\sigma_{\text{allow}} = \frac{12\pi^2 E}{23\left(\frac{KL}{r}\right)^2}; \quad \frac{KL}{r} = \sqrt{\frac{12\pi^2 E}{23\sigma_{\text{allow}}}}$$

$$\text{Here } \sigma_{\text{allow}} = \frac{P}{A} = \frac{10}{9.13} = 1.10$$

$$\frac{KL}{r} = \sqrt{\frac{12\pi^2 (29)(10^3)}{23(1.10)}} = 369.2 > \left(\frac{KL}{r}\right)_c \quad \text{Assumption OK}$$

$$\frac{1.0(L)}{2.02} = 369.2$$

$$L = 745.9 \text{ in.} = 62.2 \text{ ft} \quad \text{Ans}$$

From *Mechanics of Materials*, Sixth Edition by R. C. Hibbeler, ISBN 0-13-191345-X.

© 2005 R. C. Hibbeler. Published by Pearson Prentice Hall,

Pearson Education, Inc., Upper Saddle River, NJ. All rights reserved.

This material is protected under all copyright laws as they currently exist. No portion of this material may be reproduced, in any form or by any means, without permission in writing from the publisher.

13-89. The beam and column arrangement is used in a railroad yard for loading and unloading cars. If the maximum anticipated hoist load is 12 kip, determine if the $W8 \times 31$ structural A-36 steel column is adequate for supporting the load. The hoist travels along the bottom flange of the beam, $1 \text{ ft} \leq x \leq 25 \text{ ft}$, and has negligible size. Assume the beam is pinned to the column at B and pin-supported at A . The column is also pinned at C and is braced so it will not buckle out of the plane of the loading.

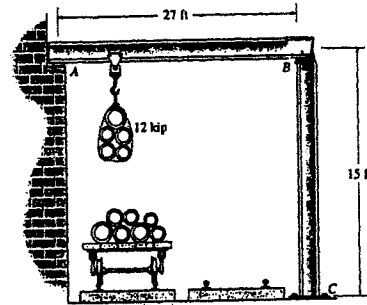

For $W8 \times 31$, $r_x = 3.47 \text{ in.}$, $A = 9.13 \text{ in}^2$
 Maximum axial load occurs when $x = 25 \text{ ft}$

$$\frac{KL}{r} = \frac{(1.0)(15)(12)}{3.47} = 51.87$$

$$\left(\frac{KL}{r}\right)_c = \sqrt{\frac{2\pi^2 E}{\sigma_Y}} = \sqrt{\frac{2\pi^2(29)(10^3)}{36}} = 126.1$$

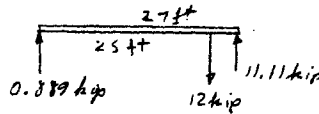

Here $0 < 51.87 < 126.1$

Intermediate column:

$$\sigma_{\text{allow}} = \frac{[1 - \frac{1}{2}(\frac{KL}{r})^2] \sigma_Y}{[\frac{5}{3} + \frac{3}{8}(\frac{KL}{r}) - \frac{1}{8}(\frac{KL}{r})^2]}$$

$$= \frac{(1 - \frac{1}{2}(51.87/126.1)^2) 36}{\{\frac{5}{3} + [\frac{3}{8}(51.87/126.1)] - [\frac{1}{8}(51.87/126.1)^2]\}} = 18.2 \text{ ksi}$$

$$\sigma = \frac{P}{A} = \frac{11.11}{9.13} = 1.22 \text{ ksi} < 18.2 \text{ ksi} \quad \text{OK} \quad \text{Ans}$$

From *Mechanics of Materials*, Sixth Edition by R. C. Hibbeler, ISBN 0-13-191345-X.

© 2005 R. C. Hibbeler. Published by Pearson Prentice Hall,

Pearson Education, Inc., Upper Saddle River, NJ. All rights reserved.

This material is protected under all copyright laws as they currently exist. No portion of this material may be reproduced, in any form or by any means, without permission in writing from the publisher.

13-90. The 1-in.-diameter rod is used to support an axial load of 5 kip. Determine its greatest allowable length L if it is made of 2014-T6 aluminum. Assume that the ends are pin connected.



Section Properties :

$$A = \pi (0.5^2) = 0.7854 \text{ in}^2$$

$$r = \frac{0.5}{2} = 0.25 \text{ in.}$$

Allowable Stress :

$$\sigma_{\text{allow}} = \frac{P}{A} = \frac{5}{0.7854} = 6.366 \text{ ksi}$$

Assume long column :

$$\sigma_{\text{allow}} = \frac{54000}{(KL/r)^2}$$

$$\frac{KL}{r} = \sqrt{\frac{54000}{\sigma_{\text{allow}}}} = \sqrt{\frac{54000}{6.366}} = 92.1 > 55 \quad \text{Assumption OK}$$

$$\frac{KL}{r} = 92.1$$

$$L = 92.1 \left(\frac{0.25}{1.0} \right) = 23.02 \text{ in.} = 1.92 \text{ ft} \quad \text{Ans}$$

From *Mechanics of Materials*, Sixth Edition by R. C. Hibbeler, ISBN 0-13-191345-X.

© 2005 R. C. Hibbeler. Published by Pearson Prentice Hall,

Pearson Education, Inc., Upper Saddle River, NJ. All rights reserved.

This material is protected under all copyright laws as they currently exist. No portion of this material may be reproduced, in any form or by any means, without permission in writing from the publisher.

13-91. The 1-in.-diameter rod is used to support an axial load of 5 kip. Determine its greatest allowable length L if it is made of 2014-T6 aluminum. Assume that the ends are fixed connected.

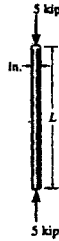

Section Properties :

$$A = \pi (0.5^2) = 0.7854 \text{ in}^2$$

$$r = \frac{0.5}{2} = 0.25 \text{ in.}$$

Allowable Stress :

$$\sigma_{\text{allow}} = \frac{P}{A} = \frac{5}{0.7854} = 6.366 \text{ ksi}$$

Assume long column :

$$\sigma_{\text{allow}} = \frac{54\,000}{(KL/r)^2}$$

$$\frac{KL}{r} = \sqrt{\frac{54\,000}{\sigma_{\text{allow}}}} = \sqrt{\frac{54\,000}{6.366}} = 92.1 \gg 55 \quad \text{Assumption OK.}$$

$$\frac{KL}{r} = 92.1$$

$$L = 92.1 \left(\frac{0.25}{0.5} \right) = 46.05 \text{ in.} = 3.84 \text{ ft} \quad \text{Ans}$$

From *Mechanics of Materials*, Sixth Edition by R. C. Hibbeler, ISBN 0-13-191345-X.

© 2005 R. C. Hibbeler. Published by Pearson Prentice Hall,

Pearson Education, Inc., Upper Saddle River, NJ. All rights reserved.

This material is protected under all copyright laws as they currently exist. No portion of this material may be reproduced, in any form or by any means, without permission in writing from the publisher.

*13-92 The tube is 0.5 in. thick, is made from aluminum alloy 2014-T6, and is pin connected at its ends. Determine the largest axial load that it can support.

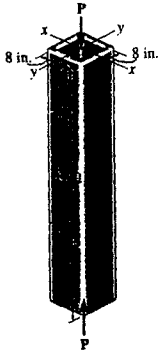

Section properties :

$$A = (8)(8) - (7)(7) = 15 \text{ in}^2$$

$$I_x = I_y = \frac{1}{12}(8)(8^3) - \frac{1}{12}(7)(7^3) = 141.25 \text{ in}^4$$

$$r_x = r_y = \sqrt{\frac{I}{A}} = \sqrt{\frac{141.25}{15}} = 3.069 \text{ in.}$$

Allowable stress :

$$\frac{KL}{r} = \frac{1.0(12)(12)}{3.069} = 46.93, \quad 12 < \frac{KL}{r} < 55$$

Intermediate column

$$\begin{aligned} \sigma_{\text{allow}} &= 30.7 - 0.23\left(\frac{KL}{r}\right) \\ &= 30.7 - 0.23(46.93) = 19.91 \text{ ksi} \end{aligned}$$

$$\begin{aligned} P_{\text{allow}} &= \sigma_{\text{allow}}A \\ &= 19.91(15) = 299 \text{ kip} \quad \text{Ans} \end{aligned}$$

From *Mechanics of Materials*, Sixth Edition by R. C. Hibbeler, ISBN 0-13-191345-X.

© 2005 R. C. Hibbeler. Published by Pearson Prentice Hall,

Pearson Education, Inc., Upper Saddle River, NJ. All rights reserved.

This material is protected under all copyright laws as they currently exist. No portion of this material may be reproduced, in any form or by any means, without permission in writing from the publisher.

13-93 The tube is 0.5 in. thick, is made of aluminum alloy 2014-T6, and is fixed connected at its ends. Determine the largest axial load that it can support.

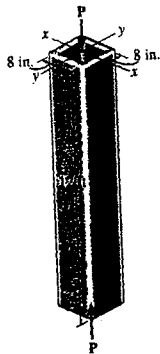

Section Properties :

$$A = (8)(8) - (7)(7) = 15 \text{ in}^2$$

$$I_x = I_y = \frac{1}{12}(8)(8^3) - \frac{1}{12}(7)(7^3) = 141.25 \text{ in}^4$$

$$r_x = r_y = \sqrt{\frac{I}{A}} = \sqrt{\frac{141.25}{15}} = 3.069 \text{ in.}$$

Allowable stress :

$$\frac{KL}{r} = \frac{0.5(12)(12)}{3.069} = 23.46, 12 < \frac{KL}{r} < 55$$

Intermediate column

$$\begin{aligned} \sigma_{\text{allow}} &= 30.7 - 0.23\left(\frac{KL}{r}\right) \\ &= 30.7 - 0.23(23.46) = 25.30 \text{ ksi} \end{aligned}$$

$$\begin{aligned} P_{\text{allow}} &= \sigma_{\text{allow}}A \\ &= 25.30(15) = 380 \text{ kip} \quad \text{Ans} \end{aligned}$$

From *Mechanics of Materials*, Sixth Edition by R. C. Hibbeler, ISBN 0-13-191345-X.

© 2005 R. C. Hibbeler. Published by Pearson Prentice Hall,

Pearson Education, Inc., Upper Saddle River, NJ. All rights reserved.

This material is protected under all copyright laws as they currently exist. No portion of this material may be reproduced, in any form or by any means, without permission in writing from the publisher.

13-94 The tube is 0.5 in. thick, is made from aluminum alloy 2014-T6, and is fixed at its bottom and pinned at its top. Determine the largest axial load that it can support.

Section Properties :

$$A = (8)(8) - (7)(7) = 15 \text{ in}^2$$

$$I_x = I_y = \frac{1}{12}(8)(8^3) - \frac{1}{12}(7)(7^3) = 141.25 \text{ in}^4$$

$$r_x = r_y = \sqrt{\frac{I}{A}} = \sqrt{\frac{141.25}{15}} = 3.069 \text{ in.}$$

Allowable stress :

$$\frac{KL}{r} = \frac{0.7(12)(12)}{3.069} = 32.8446, \quad 12 < \frac{KL}{r} < 55$$

Intermediate column

$$\sigma_{\text{allow}} = 30.7 - 0.23\left(\frac{KL}{r}\right) = 30.7 - 0.23(32.8446) = 23.15 \text{ ksi}$$

$$P_{\text{allow}} = \sigma_{\text{allow}}A = 23.15(15) = 347 \text{ kip} \quad \text{Ans}$$

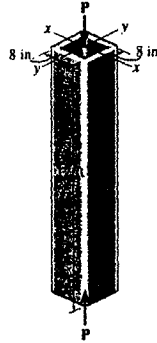

From *Mechanics of Materials*, Sixth Edition by R. C. Hibbeler, ISBN 0-13-191345-X.

© 2005 R. C. Hibbeler. Published by Pearson Prentice Hall,

Pearson Education, Inc., Upper Saddle River, NJ. All rights reserved.

This material is protected under all copyright laws as they currently exist. No portion of this material may be reproduced, in any form or by any means, without permission in writing from the publisher.

13-95 The bar is made of aluminum alloy 2014-T6. Determine its thickness b if its width is $1.5b$. Assume that it is pin connected at its ends.

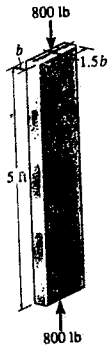

Section properties :

$$A = 1.5 b^2 \quad I_y = \frac{1}{12}(1.5b)(b^3) = 0.125 b^4$$

$$r_y = \sqrt{\frac{I_y}{A}} = \sqrt{\frac{0.125 b^4}{1.5 b^2}} = 0.2887 b$$

$$\sigma_{\text{allow}} = \frac{P}{A} = \frac{0.8}{1.5 b^2} = \frac{0.5333}{b^2}$$

Assume long column :

$$\sigma_{\text{allow}} = \frac{54\,000}{(KL/r)^2}$$

$$\frac{0.5333}{b^2} = \frac{54\,000}{\left[\frac{(1.0)(5)(12)}{0.2887 b}\right]^2}$$

$$b = 0.808 \text{ in.}$$

$$r_y = 0.2887(0.808) = 0.2333 \text{ in.}$$

$$\frac{KL}{r_y} = \frac{(1.0)(5)(12)}{0.2333} = 257$$

$$\frac{KL}{r_y} > 55 \quad \text{Assumption OK}$$

Use $b = 0.808 \text{ in.}$ **Ans**

From *Mechanics of Materials*, Sixth Edition by R. C. Hibbeler, ISBN 0-13-191345-X.

© 2005 R. C. Hibbeler. Published by Pearson Prentice Hall,

Pearson Education, Inc., Upper Saddle River, NJ. All rights reserved.

This material is protected under all copyright laws as they currently exist. No portion of this material may be reproduced, in any form or by any means, without permission in writing from the publisher.

*13-96 The bar is made of aluminum alloy 2014-T6. Determine its thickness b if its width is $1.5b$. Assume that it is fixed connected at its ends.

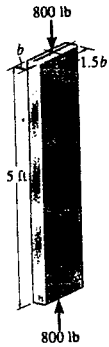

Section properties :

$$A = 1.5 b^2$$

$$I_y = \frac{1}{12}(1.5b)(b^3) = 0.125 b^4$$

$$r_y = \sqrt{\frac{I_y}{A}} = \sqrt{\frac{0.125 b^4}{1.5 b^2}} = 0.2887 b$$

$$\sigma_{\text{allow}} = \frac{P}{A} = \frac{0.8}{1.5 b^2} = \frac{0.5333}{b^2}$$

Assume long column :

$$\sigma_{\text{allow}} = \frac{54\,000}{(KL/r)^2}$$

$$\frac{0.5333}{b^2} = \frac{54\,000}{\left[\frac{(0.5)(5)(12)}{0.2887 b}\right]^2}$$

$$b = 0.571 \text{ in.}$$

$$r_y = 0.2887(0.571) = 0.1650 \text{ in.}$$

$$\frac{KL}{r_y} = \frac{(0.5)(5)(12)}{0.1650} = 181.8, \quad \frac{KL}{r_y} > 55 \quad \text{Assumption OK}$$

Use $b = 0.571 \text{ in.}$ **Ans**

From *Mechanics of Materials*, Sixth Edition by R. C. Hibbeler, ISBN 0-13-191345-X.

© 2005 R. C. Hibbeler. Published by Pearson Prentice Hall,

Pearson Education, Inc., Upper Saddle River, NJ. All rights reserved.

This material is protected under all copyright laws as they currently exist. No portion of this material may be reproduced, in any form or by any means, without permission in writing from the publisher.

13-97 A 5-ft-long rod is used in a machine to transmit an axial compressive load of 3 kip. Determine its diameter if it is pin connected at its ends and is made of a 2014-T6 aluminum alloy.

Section properties :

$$A = \frac{\pi}{4} d^2; \quad I = \frac{\pi}{4} \left(\frac{d}{2}\right)^4 = \frac{\pi d^4}{64}$$

$$r = \sqrt{\frac{I}{A}} = \sqrt{\frac{\frac{\pi d^4}{64}}{\frac{\pi}{4} d^2}} = \frac{d}{4}$$

$$\sigma_{\text{allow}} = \frac{P}{A} = \frac{3}{\frac{\pi}{4} d^2} = \frac{3.820}{d^2}$$

Assume long column :

$$\frac{KL}{r} = \frac{1.0(5)(12)}{\frac{d}{4}} = \frac{240}{d}$$

$$\sigma_{\text{allow}} = \frac{54\,000}{\left(\frac{KL}{r}\right)^2}; \quad \frac{3.820}{d^2} = \frac{54\,000}{\left[\frac{240}{d}\right]^2}$$

$$d = 1.42 \text{ in.} \quad \text{Ans}$$

$$\frac{KL}{r} = \frac{240}{1.42} = 169 > 55 \quad (\text{OK})$$

From *Mechanics of Materials*, Sixth Edition by R. C. Hibbeler, ISBN 0-13-191345-X.

© 2005 R. C. Hibbeler. Published by Pearson Prentice Hall,

Pearson Education, Inc., Upper Saddle River, NJ. All rights reserved.

This material is protected under all copyright laws as they currently exist. No portion of this material may be reproduced, in any form or by any means, without permission in writing from the publisher.

13-98 Solve Prob. 13-97 if the rod is fixed connected at its ends.

Section properties :

$$A = \frac{\pi}{4} d^2 ; \quad I = \frac{\pi}{4} \left(\frac{d}{2}\right)^4 = \frac{\pi d^4}{64}$$

$$r = \sqrt{\frac{I}{A}} = \sqrt{\frac{\frac{\pi d^4}{64}}{\frac{\pi}{4} d^2}} = \frac{d}{4}$$

$$\sigma_{\text{allow}} = \frac{P}{A} = \frac{3}{\frac{\pi}{4} d^2} = \frac{3.820}{d^2}$$

Assume a long column :

$$\frac{KL}{r} = \frac{0.5(5)(12)}{\frac{d}{4}} = \frac{120}{d}$$

$$\sigma_{\text{allow}} = \frac{54\,000}{\left(\frac{KL}{r}\right)^2} ; \quad \frac{3.820}{d^2} = \frac{54\,000}{\left[\frac{120}{d}\right]^2}$$

$$d = 1.00 \text{ in.} \quad \text{Ans}$$

$$\frac{KL}{r} = \frac{120}{1.79} = 67.2 > 55 \quad \text{OK}$$

From *Mechanics of Materials*, Sixth Edition by R. C. Hibbeler, ISBN 0-13-191345-X.

© 2005 R. C. Hibbeler. Published by Pearson Prentice Hall,

Pearson Education, Inc., Upper Saddle River, NJ. All rights reserved.

This material is protected under all copyright laws as they currently exist. No portion of this material may be reproduced, in any form or by any means, without permission in writing from the publisher.

13-99 The timber column has a square cross section and is assumed to be pin connected at its top and bottom. If it supports an axial load of 50 kip, determine its side dimensions a to the nearest $\frac{1}{2}$ in. Use the NFPA formulas.

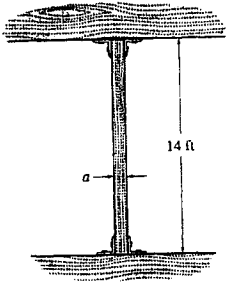

Section properties :

$$A = a^2 \quad \sigma_{\text{allow}} = \sigma = \frac{P}{A} = \frac{50}{a^2}$$

Assume long column :

$$\sigma_{\text{allow}} = \frac{540}{\left(\frac{KL}{d}\right)^2}$$

$$\frac{50}{a^2} = \frac{540}{\left[\frac{(1.0)(14)(12)}{a}\right]^2}$$

$$a = 7.15 \text{ in.}$$

$$\frac{KL}{d} = \frac{(1.0)(14)(12)}{7.15} = 23.5, \quad \frac{KL}{d} < 26 \quad \text{Assumption NG}$$

Assume intermediate column :

$$\sigma_{\text{allow}} = 1.20 \left[1 - \frac{1}{3} \left(\frac{KL/d}{26.0} \right)^2 \right]$$

$$\frac{50}{a^2} = 1.20 \left[1 - \frac{1}{3} \left(\frac{1.0(14)(12)}{a \cdot 26.0} \right)^2 \right]$$

$$a = 7.45 \text{ in.}$$

$$\frac{KL}{d} = \frac{1.0(14)(12)}{7.45} = 22.53, \quad 11 < \frac{KL}{d} < 26 \quad \text{Assumption OK}$$

Use $a = 7\frac{1}{2}$ in. **Ans**

From *Mechanics of Materials*, Sixth Edition by R. C. Hibbeler, ISBN 0-13-191345-X.

© 2005 R. C. Hibbeler. Published by Pearson Prentice Hall,

Pearson Education, Inc., Upper Saddle River, NJ. All rights reserved.

This material is protected under all copyright laws as they currently exist. No portion of this material may be reproduced, in any form or by any means, without permission in writing from the publisher.

*13-100 Solve Prob. 13-99 if the column is assumed to be fixed connected at its top and bottom.

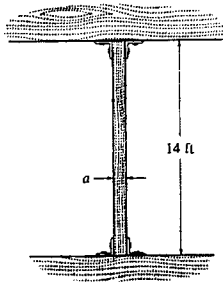

$$\sigma_{\text{allow}} = \sigma = \frac{P}{A} = \frac{50}{a^2}$$

Assume long column :

$$\sigma_{\text{allow}} = \frac{540}{(KL/d)^2}$$

$$\frac{50}{a^2} = \frac{540}{\left(\frac{0.5(14)(12)}{a}\right)^2}$$

$$a = 5.056 \text{ in.}$$

$$\frac{KL}{d} = \frac{0.5(14)(12)}{5.056} = 16.615, \quad \frac{KL}{d} < 26 \quad \text{Assumption N.G.}$$

Assume intermediate column :

$$\sigma_{\text{allow}} = 1.20 \left[1 - \frac{1}{3} \left(\frac{KL/d}{26.0} \right)^2 \right]$$

$$\frac{50}{a^2} = 1.20 \left[1 - \frac{1}{3} \left(\frac{0.5(14)(12)}{a} \right)^2 \right]$$

$$a = 6.72 \text{ in.}$$

$$\frac{KL}{d} = \frac{0.5(14)(12)}{6.72} = 12.5, \quad 11 < \frac{KL}{d} < 26 \quad \text{Assumption OK}$$

Use $a = 7.00 \text{ in.}$ **Ans**

From *Mechanics of Materials*, Sixth Edition by R. C. Hibbeler, ISBN 0-13-191345-X.

© 2005 R. C. Hibbeler. Published by Pearson Prentice Hall,

Pearson Education, Inc., Upper Saddle River, NJ. All rights reserved.

This material is protected under all copyright laws as they currently exist. No portion of this material may be reproduced, in any form or by any means, without permission in writing from the publisher.

13-101 The wood column is used to support an axial load of $P = 30$ kip. If it is fixed at the bottom and free at the top, determine the minimum width of the column based on the NFPA formulas.

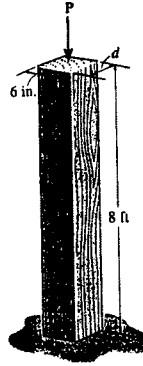

Section properties :

$$A = 6d, \quad \sigma_{\text{allow}} = \frac{P}{A} = \frac{30}{6d} = \frac{5}{d}$$

Buckling about $x-x$ axis :

$$d < 6 \text{ in.}$$

Assume long column :

$$\sigma_{\text{allow}} = \frac{540}{\left(\frac{KL}{d}\right)^2}$$

$$\frac{5}{d} = \frac{540}{\left(\frac{2(8)(12)}{d}\right)^2}$$

$$d = 6.99 \text{ in} > 6 \text{ in.} \quad \text{Assumption N.G.}$$

Buckling about $y-y$ axis :

$$d > 6 \text{ in.}$$

$$\frac{KL}{d} = \frac{2.0(12)8}{6} = 32, \quad 26 < \frac{KL}{d} < 50$$

Long column

$$\sigma_{\text{allow}} = \frac{540}{(KL/d)^2}$$

$$\frac{5}{d} = \frac{540}{32^2}$$

$$d = 9.48 \text{ in.} > 6 \text{ in.} \quad \text{OK} \quad \text{Ans.}$$

From *Mechanics of Materials*, Sixth Edition by R. C. Hibbeler, ISBN 0-13-191345-X.

© 2005 R. C. Hibbeler. Published by Pearson Prentice Hall,

Pearson Education, Inc., Upper Saddle River, NJ. All rights reserved.

This material is protected under all copyright laws as they currently exist. No portion of this material may be reproduced, in any form or by any means, without permission in writing from the publisher.

13-102 The timber column has a length of 18 ft and is pin connected at its ends. Use the NFPA formulas to determine the largest axial force P that it can support.



$$\frac{KL}{d} = \frac{(1.0)(18)(12)}{6} = 43.2, \quad 26 < \frac{KL}{d} < 50$$

Long column

$$\begin{aligned} \sigma_{\text{allow}} &= \frac{540}{(KL/d)^2} \\ &= \frac{540}{43.2^2} = 0.28935 \text{ ksi} \end{aligned}$$

$$\begin{aligned} P_{\text{allow}} &= \sigma_{\text{allow}} A \\ &= 0.28935(6)(6) \\ &= 8.68 \text{ kip} \quad \text{Ans} \end{aligned}$$

From *Mechanics of Materials*, Sixth Edition by R. C. Hibbeler, ISBN 0-13-191345-X.

© 2005 R. C. Hibbeler. Published by Pearson Prentice Hall,

Pearson Education, Inc., Upper Saddle River, NJ. All rights reserved.

This material is protected under all copyright laws as they currently exist. No portion of this material may be reproduced, in any form or by any means, without permission in writing from the publisher.

13-103 The timber column has a length of 18 ft and is fixed connected at its ends. Use the NFPA formulas to determine the largest axial force P that it can support.

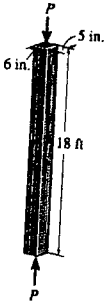

$$\frac{KL}{d} = \frac{(0.5)(18)(12)}{6} = 21.6, 11 < \frac{KL}{d} < 26$$

Intermediate column

$$\sigma_{\text{allow}} = 1.20 \left[1 - \frac{1}{3} \left(\frac{KL/d}{26} \right)^2 \right]$$

$$= 1.20 \left[1 - \frac{1}{3} \left(\frac{21.6}{26} \right)^2 \right] = 0.92393 \text{ ksi}$$

$$P_{\text{allow}} = \sigma_{\text{allow}} A$$

$$= 0.92393(6)(5) = 27.7 \text{ kip} \quad \text{Ans}$$

From *Mechanics of Materials*, Sixth Edition by R. C. Hibbeler, ISBN 0-13-191345-X.

© 2005 R. C. Hibbeler. Published by Pearson Prentice Hall,

Pearson Education, Inc., Upper Saddle River, NJ. All rights reserved.

This material is protected under all copyright laws as they currently exist. No portion of this material may be reproduced, in any form or by any means, without permission in writing from the publisher.

***13-104.** The column is made of wood. It is fixed at its bottom and free at its top. Use the NFPA formulas to determine its greatest allowable length if it supports an axial load of $P = 6$ kip.

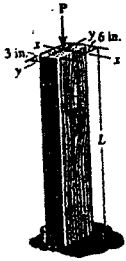

Assume long column :

$$\sigma_{\text{allow}} = \sigma = \frac{P}{A} = \frac{6}{6(3)} = 0.3333 \text{ ksi}$$

$$\sigma_{\text{allow}} = \frac{540}{(KL/d)^2} \quad K = 2.0 \quad d = 3 \text{ in.}$$

$$0.3333 = \frac{540}{[2.0(L)/3]^2}$$

$$L = 60.37 \text{ in.} = 5.03 \text{ ft} \quad \text{Ans}$$

Check :

$$\frac{KL}{d} = \frac{2.0(60.37)}{3} = 40.25, \quad 26 < \frac{KL}{d} < 50 \quad \text{Assumption OK.}$$

From *Mechanics of Materials*, Sixth Edition by R. C. Hibbeler, ISBN 0-13-191345-X.

© 2005 R. C. Hibbeler. Published by Pearson Prentice Hall,

Pearson Education, Inc., Upper Saddle River, NJ. All rights reserved.

This material is protected under all copyright laws as they currently exist. No portion of this material may be reproduced, in any form or by any means, without permission in writing from the publisher.

13-105. The column is made of wood. It is fixed at its bottom and free at its top. Use the NFPA formulas to determine the largest allowable axial load P that it can support if it has a length $L = 6$ ft.

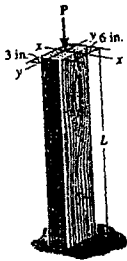

$$K = 2.0 \quad L = 6(12) = 72 \text{ in.} \quad d = 3 \text{ in.}$$

$$\frac{KL}{d} = \frac{2.0(72)}{3} = 48, \quad 26 < \frac{KL}{d} < 50$$

Long column

$$\sigma_{\text{allow}} = \frac{540}{(KL/d)^2} = \frac{540}{(48)^2} = 0.2344 \text{ ksi}$$

$$P_{\text{allow}} = \sigma_{\text{allow}} A \\ = 0.2344(6)(3) = 4.22 \text{ kip} \quad \text{Ans}$$

From *Mechanics of Materials*, Sixth Edition by R. C. Hibbeler, ISBN 0-13-191345-X.

© 2005 R. C. Hibbeler. Published by Pearson Prentice Hall,

Pearson Education, Inc., Upper Saddle River, NJ. All rights reserved.

This material is protected under all copyright laws as they currently exist. No portion of this material may be reproduced, in any form or by any means, without permission in writing from the publisher.

13-106 A 16-ft-long column is made of aluminum alloy 2014-T6. If it is fixed at its top and bottom, and a compressive load P is applied at point A , determine the maximum allowable magnitude of P using the equations of Sec. 13.6 and Eq. 13-30.

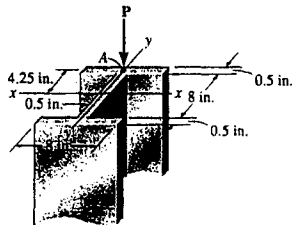

Section properties :

$$A = 2(0.5)(8) + 8(0.5) = 12 \text{ in}^2$$

$$I_x = \frac{1}{12}(8)(9^3) - \frac{1}{12}(7.5)(8^3) = 166 \text{ in}^4$$

$$I_y = 2\left(\frac{1}{12}\right)(0.5)(8^3) + \frac{1}{12}(8)(0.5^3) = 42.75 \text{ in}^4$$

$$r_y = \sqrt{\frac{I_y}{A}} = \sqrt{\frac{42.75}{12}} = 1.8875 \text{ in.}$$

Allowable stress method :

$$\frac{KL}{r_y} = \frac{0.5(16)(12)}{1.8875} = 50.86, \quad 12 < \frac{KL}{r_y} < 55$$

$$\sigma_{\text{allow}} = \left[30.7 - 0.23\left(\frac{KL}{r}\right)\right]$$

$$= [30.7 - 0.23(50.86)] = 19.00 \text{ ksi}$$

$$\sigma_{\text{max}} = \sigma_{\text{allow}} = \frac{P}{A} + \frac{M_x c}{I_x}$$

$$19.00 = \frac{P}{12} + \frac{P(4.25)(4.5)}{166}$$

$$P = 95.7 \text{ kip} \quad \text{Ans}$$

From *Mechanics of Materials*, Sixth Edition by R. C. Hibbeler, ISBN 0-13-191345-X.

© 2005 R. C. Hibbeler. Published by Pearson Prentice Hall,

Pearson Education, Inc., Upper Saddle River, NJ. All rights reserved.

This material is protected under all copyright laws as they currently exist. No portion of this material may be reproduced, in any form or by any means, without permission in writing from the publisher.

13-107 A 16-ft-long column is made of aluminum alloy 2014-T6. If it is fixed at its top and bottom, and a compressive load P is applied at point A , determine the maximum allowable magnitude of P using the equations of Sec. 13.6 and the interaction formula with $(\sigma_b)_{\text{allow}} = 20$ ksi.

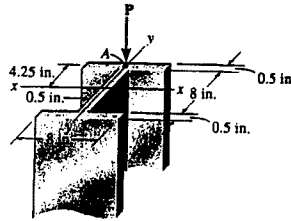

Section properties :

$$A = 2(0.5)(8) + 8(0.5) = 12 \text{ in}^2$$

$$I_x = \frac{1}{12}(8)(9^3) - \frac{1}{12}(7.5)(8^3) = 166 \text{ in}^4$$

$$I_y = 2\left(\frac{1}{12}\right)(0.5)(8^3) + \frac{1}{12}(8)(0.5^3) = 42.75 \text{ in}^4$$

$$r_y = \sqrt{\frac{I_y}{A}} = \sqrt{\frac{42.75}{12}} = 1.8875 \text{ in.}$$

Interaction method :

$$\frac{KL}{r_y} = \frac{0.5(16)(12)}{1.8875} = 50.86, \quad 12 < \frac{KL}{r_y} < 55$$

$$\begin{aligned} \sigma_{\text{allow}} &= [30.7 - 0.23\left(\frac{KL}{r}\right)] \\ &= [30.7 - 0.23(50.86)] \\ &= 19.00 \text{ ksi} \end{aligned}$$

$$\sigma_a = \frac{P}{A} = \frac{P}{12} = 0.08333P$$

$$\begin{aligned} \sigma_b &= \frac{Mc}{I_x} = \frac{P(4.25)(4.50)}{166} = 0.1152P \\ \frac{\sigma_a}{(\sigma_a)_{\text{allow}}} + \frac{\sigma_b}{(\sigma_b)_{\text{allow}}} &= 1.0 \end{aligned}$$

$$\frac{0.08333P}{19.00} + \frac{0.1152P}{20} = 1$$

$$P = 98.6 \text{ kip} \quad \text{Ans}$$

From *Mechanics of Materials*, Sixth Edition by R. C. Hibbeler, ISBN 0-13-191345-X.

© 2005 R. C. Hibbeler. Published by Pearson Prentice Hall,

Pearson Education, Inc., Upper Saddle River, NJ. All rights reserved.

This material is protected under all copyright laws as they currently exist. No portion of this material may be reproduced, in any form or by any means, without permission in writing from the publisher.

***13-108.** The $W8 \times 15$ structural A-36 steel column is fixed at its top and bottom. If it supports end moments of $M = 5 \text{ kip} \cdot \text{ft}$, determine the axial force P that can be applied. Bending is about the x - x axis. Use the AISC equations of Sec. 13.6 and Eq. 13-30.

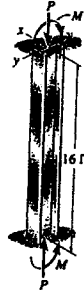

Section properties for $W8 \times 15$:

$$A = 4.44 \text{ in}^2 \quad I_x = 48.0 \text{ in}^4 \quad r_y = 0.876 \text{ in.} \quad d = 8.11 \text{ in.}$$

Allowable stress method :

$$\frac{KL}{r_y} = \frac{0.5(16)(12)}{0.876} = 109.59$$

$$\left(\frac{KL}{r}\right)_c = \sqrt{\frac{2\pi^2 E}{\sigma_Y}} = \sqrt{\frac{2\pi^2(29)(10^3)}{36}} = 126.1$$

$$\frac{KL}{r_y} < \left(\frac{KL}{r}\right)_c$$

$$(\sigma_a)_{\text{allow}} = \frac{[1 - \frac{1}{2}(\frac{KL}{r})^2] \sigma_Y}{[\frac{5}{3} + \frac{3}{8}(\frac{KL}{r}) - \frac{1}{8}(\frac{KL}{r})^3]} = \frac{[1 - \frac{1}{2}(\frac{109.59}{126.1})^2] 36}{[\frac{5}{3} + \frac{3}{8}(\frac{109.59}{126.1}) - \frac{1}{8}(\frac{109.59}{126.1})^3]} = 11.727 \text{ ksi}$$

$$\sigma_{\text{max}} = (\sigma_a)_{\text{allow}} = \frac{P}{A} + \frac{Mc}{I}$$

$$11.727 = \frac{P}{4.44} + \frac{5(12)(\frac{8.11}{2})}{48}$$

$$P = 29.6 \text{ kip} \quad \text{Ans}$$

From *Mechanics of Materials*, Sixth Edition by R. C. Hibbeler, ISBN 0-13-191345-X.

© 2005 R. C. Hibbeler. Published by Pearson Prentice Hall,

Pearson Education, Inc., Upper Saddle River, NJ. All rights reserved.

This material is protected under all copyright laws as they currently exist. No portion of this material may be reproduced, in any form or by any means, without permission in writing from the publisher.

13-109. The $W8 \times 15$ structural A-36 steel column is fixed at its top and bottom. If it supports end moments of $M = 23 \text{ kip} \cdot \text{ft}$, determine the axial force P that can be applied. Bending is about the $x-x$ axis. Use the interaction formula with $(\sigma_b)_{\text{allow}} = 24 \text{ ksi}$.



Section properties for $W8 \times 15$:

$$A = 4.44 \text{ in}^2 \quad I_x = 48.0 \text{ in}^4 \quad r_y = 0.876 \text{ in.} \quad d = 8.11 \text{ in.}$$

Interaction method :

$$\frac{KL}{r_y} = \frac{0.5(16)(12)}{0.876} = 109.59$$

$$\left(\frac{KL}{r}\right)_c = \sqrt{\frac{2\pi^2 E}{\sigma_y}} = \sqrt{\frac{2\pi^2(29)(10^3)}{36}} = 126.1, \quad \frac{KL}{r_y} < \left(\frac{KL}{r}\right)_c$$

$$(\sigma_a)_{\text{allow}} = \frac{[1 - \frac{1}{2}(\frac{KL/r}{(KL/r)_c})^2] \sigma_y}{[\frac{5}{8} + \frac{3}{8}(\frac{KL/r}{(KL/r)_c}) - \frac{1}{8}(\frac{KL/r}{(KL/r)_c})^3]} = \frac{[1 - \frac{1}{2}(\frac{109.59}{126.1})^2] 36}{[\frac{5}{8} + \frac{3}{8}(\frac{109.59}{126.1}) - \frac{1}{8}(\frac{109.59}{126.1})^3]} = 11.727 \text{ ksi}$$

$$\sigma_a = \frac{P}{A} = \frac{P}{4.44} = 0.2252P$$

$$\sigma_b = \frac{Mc}{I} = \frac{23(12)(\frac{8.11}{2})}{48} = 23.316 \text{ ksi}$$

$$\frac{\sigma_a}{(\sigma_a)_{\text{allow}}} + \frac{\sigma_b}{(\sigma_b)_{\text{allow}}} = 1$$

$$\frac{0.2252P}{11.727} + \frac{23.316}{24} = 1$$

$$P = 1.48 \text{ kip} \quad \text{Ans}$$

$$\text{Note : } \frac{\sigma_a}{(\sigma_a)_{\text{allow}}} = \frac{0.2252(1.48)}{11.727} = 0.0285 < 0.15$$

Therefore the method is allowed.

From *Mechanics of Materials*, Sixth Edition by R. C. Hibbeler, ISBN 0-13-191345-X.

© 2005 R. C. Hibbeler. Published by Pearson Prentice Hall,

Pearson Education, Inc., Upper Saddle River, NJ. All rights reserved.

This material is protected under all copyright laws as they currently exist. No portion of this material may be reproduced, in any form or by any means, without permission in writing from the publisher.

13-110. The $W8 \times 15$ structural A-36 steel column is assumed to be pinned at its top and bottom. Determine the largest eccentric load P that can be applied using Eq. 13-30 and the AISC equations of Sec. 13.6.

Section Properties : For a $W8 \times 15$ wide flange section,

$$A = 4.44 \text{ in}^2 \quad d = 8.11 \text{ in.} \quad I_x = 48.0 \text{ in}^4 \quad r_x = 3.29 \text{ in.} \\ r_y = 0.876 \text{ in.}$$

Slenderness Ratio : By observation, the largest slenderness ratio is about $y-y$ axis. For a column pinned at both ends, $K = 1$. Thus,

$$\left(\frac{KL}{r}\right)_y = \frac{1(10)(12)}{0.876} = 137.0$$

Allowable Stress : The allowable stress can be determined using

AISC Column Formulas. For A-36 steel, $\left(\frac{KL}{r}\right)_c = \sqrt{\frac{2\pi^2 E}{\sigma_Y}}$
 $= \sqrt{\frac{2\pi^2 [29(10^3)]}{36}} = 126.1$. Since $\left(\frac{KL}{r}\right)_c \leq \frac{KL}{r} \leq 200$, the column is a long column. Applying Eq. 13-21,

$$\sigma_{\text{allow}} = \frac{12\pi^2 E}{23(KL/r)^2} \\ = \frac{12\pi^2 (29.0)(10^3)}{23(137.0)^2} \\ = 7.958 \text{ ksi}$$

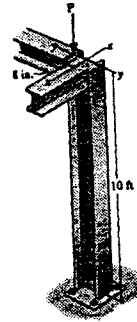

Maximum Stress : Bending is about $x-x$ axis. Applying Eq. 13-30, we have

$$\sigma_{\text{max}} = \sigma_{\text{allow}} = \frac{P}{A} + \frac{Mc}{I} \\ 7.958 = \frac{P}{4.44} + \frac{P(8)\left(\frac{8.11}{2}\right)}{48}$$

$$P = 8.83 \text{ kip}$$

Ans

From *Mechanics of Materials*, Sixth Edition by R. C. Hibbeler, ISBN 0-13-191345-X.

© 2005 R. C. Hibbeler. Published by Pearson Prentice Hall,

Pearson Education, Inc., Upper Saddle River, NJ. All rights reserved.

This material is protected under all copyright laws as they currently exist. No portion of this material may be reproduced, in any form or by any means, without permission in writing from the publisher.

13-111. Solve Prob. 13-110 if the column is fixed at its top and bottom.

Section Properties : For a W8 × 15 wide flange section,

$$A = 4.44 \text{ in}^2 \quad d = 8.11 \text{ in.} \quad I_x = 48.0 \text{ in}^4 \quad r_x = 3.29 \text{ in.} \\ r_y = 0.876 \text{ in.}$$

Slenderness Ratio : By observation, the largest slenderness ratio is about $y-y$ axis. For a column fixed at both ends, $K = 0.7$. Thus,

$$\left(\frac{KL}{r}\right)_y = \frac{0.7(10)(12)}{0.876} = 95.89$$

Allowable Stress : The allowable stress can be determined using

AISC Column Formulas. For A-36 steel, $\left(\frac{KL}{r}\right)_c = \sqrt{\frac{2\pi^2 E}{\sigma_y}}$

$= \sqrt{\frac{2\pi^2 [29(10^3)]}{36}} = 126.1$. Since $\frac{KL}{r} < \left(\frac{KL}{r}\right)_c$, the column is an *intermediate* column. Applying Eq. 13-23,

$$\sigma_{\text{allow}} = \frac{\left[1 - \frac{(KL/r)^2}{2(KL/r)_c^2}\right] \sigma_y}{\frac{5}{3} + \frac{3(KL/r)}{8(KL/r)_c} - \frac{(KL/r)^3}{8(KL/r)_c^3}} \\ = \frac{\left[1 - \frac{(95.89)^2}{2(126.1)^2}\right] (36)}{\frac{5}{3} + \frac{3(95.89)}{8(126.1)} - \frac{(95.89)^3}{8(126.1)^3}} \\ = 13.491 \text{ ksi}$$

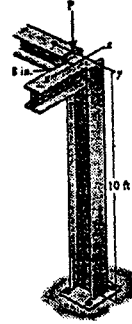

Maximum Stress : Bending is about $x-x$ axis. Applying Eq. 13-30, we have

$$\sigma_{\text{max}} = \sigma_{\text{allow}} = \frac{P}{A} + \frac{Mc}{I} \\ 13.491 = \frac{P}{4.44} + \frac{P(8)\left(\frac{8.11}{2}\right)}{48} \\ P = 15.0 \text{ kip} \quad \text{Ans}$$

From *Mechanics of Materials*, Sixth Edition by R. C. Hibbeler, ISBN 0-13-191345-X.

© 2005 R. C. Hibbeler. Published by Pearson Prentice Hall,

Pearson Education, Inc., Upper Saddle River, NJ. All rights reserved.

This material is protected under all copyright laws as they currently exist. No portion of this material may be reproduced, in any form or by any means, without permission in writing from the publisher.

***13-112.** Solve Prob. 13–110 if the column is fixed at its bottom and pinned at its top.

Section Properties : For a W8×15 wide flange section,

$$A = 4.44 \text{ in}^2 \quad d = 8.11 \text{ in.} \quad I_x = 48.0 \text{ in}^4 \quad r_x = 3.29 \text{ in.} \\ r_y = 0.876 \text{ in.}$$

Slenderness Ratio : By observation, the largest slenderness ratio is about $y - y$ axis. For a column fixed at both ends, $K = 0.5$. Thus,

$$\left(\frac{KL}{r}\right)_y = \frac{0.5(10)(12)}{0.876} = 68.49$$

Allowable Stress : The allowable stress can be determined using

AISC Column Formulas. For A-36 steel, $\left(\frac{KL}{r}\right)_c = \sqrt{\frac{2\pi^2 E}{\sigma_y}}$
 $= \sqrt{\frac{2\pi^2 [29(10^3)]}{36}} = 126.1$. Since $\frac{KL}{r} < \left(\frac{KL}{r}\right)_c$, the column is an *intermediate* column. Applying Eq. 13–23,

$$\sigma_{\text{allow}} = \frac{\left[1 - \frac{(KL/r)^2}{2(KL/r)_c^2}\right] \sigma_y}{\frac{5}{3} + \frac{3(KL/r)}{8(KL/r)_c} - \frac{(KL/r)^3}{8(KL/r)_c^3}} \\ = \frac{\left[1 - \frac{(68.49)^2}{2(126.1)^2}\right] (36)}{\frac{5}{3} + \frac{3(68.49)}{8(126.1)} - \frac{(68.49)^3}{8(126.1)^3}} \\ = 16.586 \text{ ksi}$$

Maximum Stress : Bending is about $x - x$ axis. Applying Eq. 13–30, we have

$$\sigma_{\text{max}} = \sigma_{\text{allow}} = \frac{P}{A} + \frac{Mc}{I} \\ 16.586 = \frac{P}{4.44} + \frac{P(8)\left(\frac{8.11}{2}\right)}{48} \\ P = 18.4 \text{ kip} \quad \text{Ans}$$

From *Mechanics of Materials*, Sixth Edition by R. C. Hibbeler, ISBN 0-13-191345-X.

© 2005 R. C. Hibbeler. Published by Pearson Prentice Hall,

Pearson Education, Inc., Upper Saddle River, NJ. All rights reserved.

This material is protected under all copyright laws as they currently exist. No portion of this material may be reproduced, in any form or by any means, without permission in writing from the publisher.

13-113 The $W 10 \times 19$ structural A-36 steel column is assumed to be pinned at its top and bottom. Determine the largest eccentric load P that can be applied using Eq. 13-30 and the AISC equations of Sec. 13.6.

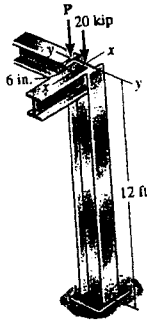

Section properties for $W 10 \times 19$:

$$A = 5.62 \text{ in}^2 \quad d = 10.24 \text{ in.} \quad I_x = 96.3 \text{ in}^4$$

$$r_x = 4.14 \text{ in.} \quad r_y = 0.874 \text{ in.}$$

Allowable stress method :

$$\frac{KL}{r_y} = \frac{1.0(12)(12)}{0.874} = 164.76$$

$$\left(\frac{KL}{r}\right)_c = \sqrt{\frac{2\pi^2 E}{\sigma_Y}} = \sqrt{\frac{2\pi^2(29)(10^3)}{36}} = 126.1, \quad \frac{KL}{r_y} > \left(\frac{KL}{r}\right)_c$$

$$(\sigma_a)_{\text{allow}} = \frac{12\pi^2 E}{23(KL/r)^2} = \frac{12\pi^2(29)(10^3)}{23(164.76)^2} = 5.501 \text{ ksi}$$

$$\sigma_{\text{max}} = (\sigma_a)_{\text{allow}} = \frac{P}{A} + \frac{M_x c}{I_x}$$

$$5.501 = \frac{P + 20}{5.62} + \frac{P(6)\left(\frac{10.24}{2}\right)}{96.3}$$

$$P = 3.91 \text{ kip} \quad \text{Ans}$$

From *Mechanics of Materials*, Sixth Edition by R. C. Hibbeler, ISBN 0-13-191345-X.

© 2005 R. C. Hibbeler. Published by Pearson Prentice Hall,

Pearson Education, Inc., Upper Saddle River, NJ. All rights reserved.

This material is protected under all copyright laws as they currently exist. No portion of this material may be reproduced, in any form or by any means, without permission in writing from the publisher.

13-114 The $W 14 \times 22$ structural A-36 steel column is fixed at its top and bottom. If it supports end moments of $M = 10 \text{ kip} \cdot \text{ft}$, determine the maximum allowable axial force P that can be applied. Bending is about the $x-x$ axis. Use the AISC equations of Sec. 13.6 and Eq. 13-30.

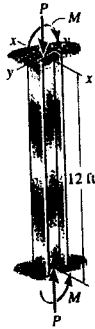

Section properties for $W 14 \times 22$:

$$A = 6.49 \text{ in}^2 \quad d = 13.74 \text{ in} \quad I_x = 199 \text{ in}^4 \quad r_y = 1.04 \text{ in.}$$

Allowable stress method :

$$\frac{KL}{r_y} = \frac{0.5(12)(12)}{1.04} = 69.231$$

$$\left(\frac{KL}{r}\right)_c = \sqrt{\frac{2\pi^2 E}{\sigma_Y}} = \sqrt{\frac{2\pi^2(29)(10^3)}{36}} = 126.1, \quad \frac{KL}{r_y} < \left(\frac{KL}{r}\right)_c$$

Hence,

$$(\sigma_a)_{\text{allow}} = \frac{\left[1 - \frac{1}{2} \left(\frac{\frac{KL}{r_y}}{\left(\frac{KL}{r}\right)_c}\right)^2\right] \sigma_Y}{\left[\frac{5}{3} + \frac{3}{8} \frac{\frac{KL}{r_y}}{\left(\frac{KL}{r}\right)_c} - \frac{1}{8} \left(\frac{\frac{KL}{r_y}}{\left(\frac{KL}{r}\right)_c}\right)^3\right]} = \frac{\left[1 - \frac{1}{2} \left(\frac{69.231}{126.1}\right)^2\right] 36}{\left[\frac{5}{3} + \frac{3}{8} \left(\frac{69.231}{126.1}\right) - \frac{1}{8} \left(\frac{69.231}{126.1}\right)^3\right]} = 16.510 \text{ ksi}$$

$$\sigma_{\text{max}} = (\sigma_a)_{\text{allow}} = \frac{P}{A} + \frac{M_y c}{I_x}$$

$$16.510 = \frac{P}{6.49} + \frac{10(12)\left(\frac{13.74}{2}\right)}{199}$$

$$P = 80.3 \text{ kip} \quad \text{Ans}$$

From *Mechanics of Materials*, Sixth Edition by R. C. Hibbeler, ISBN 0-13-191345-X.

© 2005 R. C. Hibbeler. Published by Pearson Prentice Hall,

Pearson Education, Inc., Upper Saddle River, NJ. All rights reserved.

This material is protected under all copyright laws as they currently exist. No portion of this material may be reproduced, in any form or by any means, without permission in writing from the publisher.

13-115 The $W 14 \times 22$ column is fixed at its top and bottom. If it supports end moments of $M = 15 \text{ kip} \cdot \text{ft}$, determine the maximum allowable axial force P that can be applied. Bending is about the $x-x$ axis. Use the interaction formula with $(\sigma_b)_{\text{allow}} = 24 \text{ ksi}$.

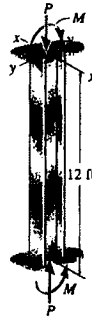

Section Properties for $W 14 \times 22$:

$$A = 6.49 \text{ in}^2 \quad d = 13.74 \text{ in}^2 \quad I_x = 199 \text{ in}^4 \quad r_y = 1.04 \text{ in.}$$

Interaction method :

$$\frac{KL}{r_y} = \frac{0.5(12)(12)}{1.04} = 69.231$$

$$\left(\frac{KL}{r}\right)_c = \sqrt{\frac{2\pi^2 E}{\sigma_Y}} = \sqrt{\frac{2\pi^2(29)(10^3)}{36}} = 126.1, \quad \frac{KL}{r_y} < \left(\frac{KL}{r}\right)_c$$

Hence,

$$(\sigma_a)_{\text{allow}} = \frac{\left[1 - \frac{1}{2} \left(\frac{KL/r}{(KL/r)_c}\right)^2\right] \sigma_Y}{\left[\frac{5}{3} + \frac{3}{8} \left(\frac{KL/r}{(KL/r)_c}\right) - \frac{1}{8} \left(\frac{KL/r}{(KL/r)_c}\right)^3\right]} = \frac{\left[1 - \frac{1}{2} \left(\frac{69.231}{126.1}\right)^2\right] 36}{\left[\frac{5}{3} + \frac{3}{8} \left(\frac{69.231}{126.1}\right) - \frac{1}{8} \left(\frac{69.231}{126.1}\right)^3\right]} = 16.510 \text{ ksi}$$

$$\sigma_a = \frac{P}{A} = \frac{P}{6.49} = 0.15408 P$$

$$\sigma_b = \frac{M_x c}{I_x} = \frac{15(12) \left(\frac{13.74}{2}\right)}{199} = 6.214 \text{ ksi}$$

$$\frac{\sigma_a}{(\sigma_a)_{\text{allow}}} + \frac{\sigma_b}{(\sigma_b)_{\text{allow}}} = 1.0$$

$$\frac{0.15408 P}{16.510} + \frac{6.214}{24} = 1.0$$

$$P = 79.4 \text{ kip} \quad \text{Ans}$$

From *Mechanics of Materials*, Sixth Edition by R. C. Hibbeler, ISBN 0-13-191345-X.

© 2005 R. C. Hibbeler. Published by Pearson Prentice Hall,

Pearson Education, Inc., Upper Saddle River, NJ. All rights reserved.

This material is protected under all copyright laws as they currently exist. No portion of this material may be reproduced, in any form or by any means, without permission in writing from the publisher.

*13-116 The $W 12 \times 50$ structural A-36 steel column is fixed at its bottom and free at its top. Determine the greatest eccentric load P that can be applied using Eq. 13-30 and the AISC equations of Sec. 13.6.



Section properties for $W 12 \times 50$:

$$A = 14.7 \text{ in}^2 \quad d = 12.19 \text{ in.} \quad I_y = 56.3 \text{ in}^4$$

$$r_y = 1.96 \text{ in.} \quad b_y = 8.08 \text{ in.}$$

Allowable stress method :

$$\frac{KL}{r_y} = \frac{2.0(10)(12)}{1.96} = 122.45$$

$$\left(\frac{KL}{r}\right)_c = \sqrt{\frac{2\pi^2 E}{\sigma_Y}} = \sqrt{\frac{2\pi^2(29)(10^3)}{36}} = 126.1$$

$$\frac{KL}{r_y} < \left(\frac{KL}{r}\right)_c$$

$$(\sigma_a)_{\text{allow}} = \frac{[1 - \frac{1}{2}(\frac{KL/r}{(KL/r)_c})^2] \sigma_Y}{[\frac{5}{3} + \frac{3}{8}(\frac{KL/r}{(KL/r)_c}) - \frac{1}{8}(\frac{KL/r}{(KL/r)_c})^3]}$$

$$= \frac{[1 - \frac{1}{2}(\frac{122.45}{126.1})^2] 36}{[\frac{5}{3} + \frac{3}{8}(\frac{122.45}{126.1}) - \frac{1}{8}(\frac{122.45}{126.1})^3]} = 9.929 \text{ ksi}$$

$$\sigma_{\text{max}} = (\sigma_a)_{\text{allow}} = \frac{P}{A} + \frac{M_y c}{I_y}$$

$$9.929 = \frac{P + 40}{14.7} + \frac{P(16)(\frac{8.08}{2})}{56.3}$$

$$P = 5.93 \text{ kip} \quad \text{Ans}$$

From *Mechanics of Materials*, Sixth Edition by R. C. Hibbeler, ISBN 0-13-191345-X.

© 2005 R. C. Hibbeler. Published by Pearson Prentice Hall,

Pearson Education, Inc., Upper Saddle River, NJ. All rights reserved.

This material is protected under all copyright laws as they currently exist. No portion of this material may be reproduced, in any form or by any means, without permission in writing from the publisher.

13-117 The $W 12 \times 87$ structural A-36 steel column is fixed at its bottom and free at its top. Determine the greatest eccentric load P that can be applied using Eq. 13-30 and the AISC equations of Sec. 13.6.



Section properties for $W 12 \times 87$:

$$A = 25.6 \text{ in}^2 \quad d = 12.53 \text{ in.}$$

$$I_y = 241 \text{ in}^4 \quad r_y = 3.07 \text{ in.}$$

$$b = 12.125$$

Allowable stress method :

$$\frac{KL}{r_y} = \frac{2.0(10)(12)}{3.07} = 78.176$$

$$\left(\frac{KL}{r}\right)_c = \sqrt{\frac{2\pi^2 E}{\sigma_Y}} = \sqrt{\frac{2\pi^2(29)(10^3)}{36}} = 126.1, \quad \frac{KL}{r_y} < \left(\frac{KL}{r}\right)_c$$

$$(\sigma_a)_{\text{allow}} = \frac{\left[1 - \frac{1}{2}\left(\frac{KL/r}{(KL/r)_c}\right)^2\right]\sigma_Y}{\frac{5}{3} + \frac{3}{8}\left(\frac{KL/r}{(KL/r)_c}\right) - \frac{1}{8}\left(\frac{KL/r}{(KL/r)_c}\right)^3} = \frac{\left[1 - \frac{1}{2}\left(\frac{78.176}{126.1}\right)^2\right]36}{\frac{5}{3} + \frac{3}{8}\left(\frac{78.176}{126.1}\right) - \frac{1}{8}\left(\frac{78.176}{126.1}\right)^3} = 15.56 \text{ ksi}$$

$$\sigma_{\text{allow}} = \frac{P}{A} + \frac{M_y c}{I_y}$$

$$15.56 = \frac{P + 40}{25.6} + \frac{P(16)\left(\frac{12.125}{2}\right)}{241}$$

$$P = 31.7 \text{ kip} \quad \text{Ans}$$

From *Mechanics of Materials*, Sixth Edition by R. C. Hibbeler, ISBN 0-13-191345-X.

© 2005 R. C. Hibbeler. Published by Pearson Prentice Hall,

Pearson Education, Inc., Upper Saddle River, NJ. All rights reserved.

This material is protected under all copyright laws as they currently exist. No portion of this material may be reproduced, in any form or by any means, without permission in writing from the publisher.

13-118. The $W14 \times 43$ structural A-36 steel column is fixed at its bottom and free at its top. Determine the greatest eccentric load P that can be applied using Eq. 13–30 and the AISC equations of Sec. 13.6.

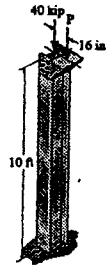

Section properties for $W14 \times 43$:

$$A = 12.6 \text{ in}^2 \quad d = 13.66 \text{ in.}$$

$$I_y = 45.2 \text{ in}^4 \quad r_y = 1.89 \text{ in.}$$

$$b = 7.995$$

Allowable stress method :

$$\frac{KL}{r_y} = \frac{2(10)(12)}{1.89} = 126.98$$

$$\left(\frac{KL}{r}\right)_c = \sqrt{\frac{2\pi^2 E}{\sigma_Y}} = \sqrt{\frac{2\pi^2 (29)(10^3)}{36}} = 126.1, 200 > \frac{KL}{r_y} > \left(\frac{KL}{r}\right)_c$$

$$(\sigma_a)_{\text{allow}} = \frac{12\pi^2 E}{23(KL/r)^2} = \frac{12\pi^2 (29)(10^3)}{23(126.98)^2} = 9.26 \text{ ksi}$$

$$\sigma_{\text{max}} = (\sigma_a)_{\text{allow}} = \frac{P}{A} + \frac{M_y c}{I_y}$$

$$9.26 = \frac{P + 40}{12.6} + \frac{P(16)\left(\frac{7.995}{2}\right)}{45.2}$$

$$P = 4.07 \text{ kip} \quad \text{Ans}$$

From *Mechanics of Materials*, Sixth Edition by R. C. Hibbeler, ISBN 0-13-191345-X.

© 2005 R. C. Hibbeler. Published by Pearson Prentice Hall,

Pearson Education, Inc., Upper Saddle River, NJ. All rights reserved.

This material is protected under all copyright laws as they currently exist. No portion of this material may be reproduced, in any form or by any means, without permission in writing from the publisher.

13-119. The $W10 \times 45$ structural A-36 steel column is fixed at its bottom and free at its top. If it is subjected to a load of $P = 2$ kip, determine if it is safe based on the AISC equations of Sec. 13.6 and Eq. 13-30.

Section properties for $W10 \times 45$:

$$A = 13.3 \text{ in}^2 \quad d = 10.10 \text{ in.}$$

$$I_y = 53.4 \text{ in}^4 \quad r_y = 2.01 \text{ in.}$$

$$b = 8.020 \text{ in.}$$

Allowable stress method :

$$\frac{KL}{r_y} = \frac{2.0(10)(12)}{2.01} = 119.4$$

$$\left(\frac{KL}{r}\right)_c = \sqrt{\frac{2\pi^2 E}{\sigma_y}} = \sqrt{\frac{2\pi^2(29)(10^3)}{36}} = 126.1$$

$$\frac{KL}{r} < \left(\frac{KL}{r}\right)_c$$

$$(\sigma_a)_{\text{allow}} \geq \frac{[1 - \frac{1}{2}(\frac{KL/r}{(KL/r)_c})^2] \sigma_y}{\frac{5}{3} + \frac{3}{8}(\frac{KL/r}{(KL/r)_c}) - \frac{1}{8}(\frac{KL/r}{(KL/r)_c})^3} = \frac{[1 - \frac{1}{2}(\frac{119.4}{126.1})^2] 36}{\frac{5}{3} + \frac{3}{8}(\frac{119.4}{126.1}) - \frac{1}{8}(\frac{119.4}{126.1})^3} = 10.37 \text{ ksi}$$

$$(\sigma_a)_{\text{allow}} = \frac{P}{A} + \frac{M_y c}{I_y}$$

$$10.37 \geq \frac{42}{13.3} + \frac{2(16)(\frac{8.020}{2})}{53.4}$$

$$10.37 \geq 5.56 \quad \text{OK} \quad \text{Column is safe.}$$

Yes. Ans

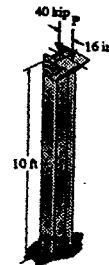

From *Mechanics of Materials*, Sixth Edition by R. C. Hibbeler, ISBN 0-13-191345-X.

© 2005 R. C. Hibbeler. Published by Pearson Prentice Hall,

Pearson Education, Inc., Upper Saddle River, NJ. All rights reserved.

This material is protected under all copyright laws as they currently exist. No portion of this material may be reproduced, in any form or by any means, without permission in writing from the publisher.

***13-120.** Check if the wood column is adequate for supporting the eccentric load of $P = 800$ lb applied at its top. It is fixed at its base and free at its top. Use the NFPA equations of Sec. 13.6 and Eq. 13-30.



Section properties :

$$A = 3(6) = 18 \text{ in}^2 \quad I_x = \frac{1}{12}(3)(6^3) = 54 \text{ in}^4$$

$$d = 3 \text{ in.}$$

Allowable stress method :

$$\frac{KL}{d} = \frac{2.0(6)(12)}{3} = 48 \text{ in.}, \quad 26 < \frac{KL}{d} < 50$$

$$(\sigma_e)_{\text{allow}} = \frac{540}{(KL/d)^2} = \frac{540}{(48)^2} = 0.2344 \text{ ksi}$$

$$\sigma_{\text{max}} = \frac{P}{A} + \frac{M_x c}{I_x}$$

$$= \frac{0.8}{18} + \frac{0.8(5)(3)}{54} = 0.2667 \text{ ksi}$$

$$\sigma_{\text{max}} > (\sigma_e)_{\text{allow}}$$

The column is inadequate

No. Ans

From *Mechanics of Materials*, Sixth Edition by R. C. Hibbeler, ISBN 0-13-191345-X.

© 2005 R. C. Hibbeler. Published by Pearson Prentice Hall,

Pearson Education, Inc., Upper Saddle River, NJ. All rights reserved.

This material is protected under all copyright laws as they currently exist. No portion of this material may be reproduced, in any form or by any means, without permission in writing from the publisher.

13-121. Determine the maximum allowable eccentric load P that can be applied to the wood column. The column is fixed at its base and free at its top. Use the NFPA equations of Sec. 13.6 and Eq. 13-30.



Section properties :

$$A = 6(3) = 18 \text{ in}^2 \quad I_x = \frac{1}{12}(3)(6)^3 = 54 \text{ in}^4$$

$$d = 3 \text{ in.}$$

Allowable stress method :

$$\frac{KL}{d} = \frac{2.0(6)(12)}{3} = 48 \text{ in.}, \quad 26 < \frac{KL}{d} < 50$$

$$(\sigma_s)_{\text{allow}} = \frac{540}{(KL/d)^2} = \frac{540}{(48)^2} = 0.2344 \text{ ksi}$$

$$\sigma_{\text{max}} = \sigma_{\text{allow}} = \frac{P}{A} + \frac{M_x c}{I_x}$$

$$0.2344 = \frac{P}{18} + \frac{P(5)(3)}{54}$$

$$P = 0.703 \text{ kip} = 703 \text{ lb} \quad \text{Ans}$$

From *Mechanics of Materials*, Sixth Edition by R. C. Hibbeler, ISBN 0-13-191345-X.

© 2005 R. C. Hibbeler. Published by Pearson Prentice Hall,

Pearson Education, Inc., Upper Saddle River, NJ. All rights reserved.

This material is protected under all copyright laws as they currently exist. No portion of this material may be reproduced, in any form or by any means, without permission in writing from the publisher.

13-122 The 10-in.-diameter utility pole supports the transformer that has a weight of 600 lb and center of gravity at *G*. If the pole is fixed to the ground and free at its top, determine if it is adequate according to the NFPA equations of Sec. 13.6 and Eq. 13-30.

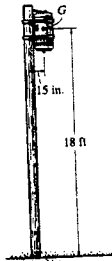

$$\frac{KL}{d} = \frac{2(18)(12)}{10} = 43.2 \text{ in.}$$

$$26 < 43.2 \leq 50$$

Use Eq. 13-29,

$$\sigma_{\text{allow}} = \frac{540}{(KL/d)} = \frac{540}{(43.2)^2} = 0.2894 \text{ ksi}$$

$$\sigma_{\text{max}} = \frac{P}{A} + \frac{Mc}{I}$$

$$\sigma_{\text{max}} = \frac{600}{\pi (5)^2} + \frac{(600)(15)(5)}{\left(\frac{\pi}{4}\right)(5)^4}$$

$$\sigma_{\text{max}} = 99.31 \text{ psi} < 0.289 \text{ ksi} \quad \text{OK}$$

Yes. **Ans**

From *Mechanics of Materials*, Sixth Edition by R. C. Hibbeler, ISBN 0-13-191345-X.

© 2005 R. C. Hibbeler. Published by Pearson Prentice Hall,

Pearson Education, Inc., Upper Saddle River, NJ. All rights reserved.

This material is protected under all copyright laws as they currently exist. No portion of this material may be reproduced, in any form or by any means, without permission in writing from the publisher.

13-123 Determine if the column can support the eccentric compressive load of 1.5 kip. Assume that the ends are pin connected. Use the NFPA equations in Sec. 13.6 and Eq. 13-30.

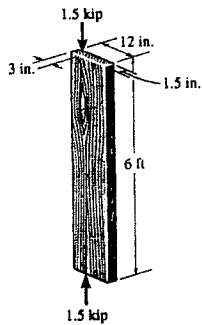

$$A = 12(1.5) = 18 \text{ in}^2; \quad I_x = \frac{1}{12}(1.5)(12)^3 = 216 \text{ in}^4$$

$$d = 1.5 \text{ in.}$$

$$\frac{KL}{d} = \frac{1.0(6)(12)}{1.5} = 48$$

$$26 < \frac{KL}{d} < 50$$

$$(\sigma_a)_{\text{allow}} = \frac{540}{\left(\frac{KL}{d}\right)^2} = \frac{540}{(48)^2} = 0.2344$$

$$\begin{aligned} \sigma_{\text{max}} &= \frac{P}{A} + \frac{M_x c}{I_x} \\ &= \frac{1.5}{18} + \frac{1.5(3)(6)}{216} = 0.208 \text{ ksi} \end{aligned}$$

$$(\sigma_a)_{\text{allow}} > \sigma_{\text{max}}$$

The column is adequate.

Yes. **Ans**

From *Mechanics of Materials*, Sixth Edition by R. C. Hibbeler, ISBN 0-13-191345-X.

© 2005 R. C. Hibbeler. Published by Pearson Prentice Hall,

Pearson Education, Inc., Upper Saddle River, NJ. All rights reserved.

This material is protected under all copyright laws as they currently exist. No portion of this material may be reproduced, in any form or by any means, without permission in writing from the publisher.

*13-124 Determine if the column can support the eccentric compressive load of 1.5 kip. Assume that the bottom is fixed and the top is pinned. Use the NFPA equations in Sec. 13.6 and Eq. 13-30.

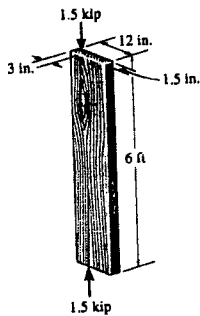

$$A = 12(1.5) = 18 \text{ in}^2; \quad I_x = \frac{1}{12}(1.5)(12)^3 = 216 \text{ in}^4$$

$$d = 1.5 \text{ in.}$$

$$\frac{KL}{d} = \frac{0.7(6)(12)}{1.5} = 33.6$$

$$26 < \frac{KL}{d} < 50$$

$$(\sigma_a)_{\text{allow}} = \frac{540}{\left(\frac{KL}{d}\right)^2} = \frac{540}{(33.6)^2} = 0.4783$$

$$\sigma_{\text{max}} = \frac{P}{A} + \frac{M_x c}{I_x} = \frac{1.5}{18} + \frac{1.5(3)(6)}{216} = 0.208 \text{ ksi}$$

$$(\sigma_a)_{\text{allow}} > \sigma_{\text{max}}$$

The column is adequate.

Yes. Ans

From *Mechanics of Materials*, Sixth Edition by R. C. Hibbeler, ISBN 0-13-191345-X.

© 2005 R. C. Hibbeler. Published by Pearson Prentice Hall,

Pearson Education, Inc., Upper Saddle River, NJ. All rights reserved.

This material is protected under all copyright laws as they currently exist. No portion of this material may be reproduced, in any form or by any means, without permission in writing from the publisher.

13-125 The wood column has a thickness of 4 in. and a width of 6 in. Using the NFPA equations of Sec. 13.6 and Eq. 13-30, determine the maximum allowable eccentric load P that can be applied. Assume that the column is pinned at both its top and bottom.

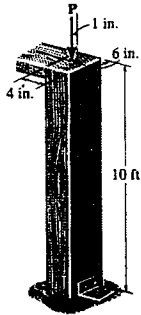

Section properties :

$$A = 6(4) = 24 \text{ in}^2 \quad I_y = \frac{1}{12}(6)(4^3) = 32 \text{ in}^4$$

$$d = 4 \text{ in.}$$

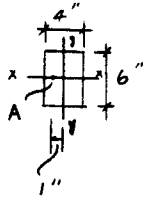

Allowable stress method :

$$\frac{KL}{d} = \frac{1.0(10)(12)}{4} = 30 \text{ in.}$$

$$26 < \frac{KL}{d} < 50$$

$$(\sigma_a)_{\text{allow}} = \frac{540}{(KL/d)^2} = \frac{540}{30^2} = 0.6 \text{ ksi}$$

$$\sigma_{\text{max}} = (\sigma_a)_{\text{allow}} = \frac{P}{A} + \frac{M_y c}{I_y}$$

$$0.6 = \frac{P}{24} + \frac{P(1)(2)}{32}$$

$$P = 5.76 \text{ kip} \quad \text{Ans}$$

From *Mechanics of Materials*, Sixth Edition by R. C. Hibbeler, ISBN 0-13-191345-X.

© 2005 R. C. Hibbeler. Published by Pearson Prentice Hall,

Pearson Education, Inc., Upper Saddle River, NJ. All rights reserved.

This material is protected under all copyright laws as they currently exist. No portion of this material may be reproduced, in any form or by any means, without permission in writing from the publisher.

13-126 The wood column has a thickness of 4 in. and a width of 6 in. Using the NFPA equations of Sec. 13.6 and Eq. 13-30, determine the maximum allowable eccentric load P that can be applied. Assume that the column is pinned at the top and fixed at the bottom.

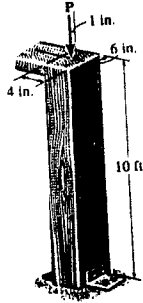

Section properties :

$$A = 6(4) = 24 \text{ in}^2 \quad I_y = \frac{1}{12}(6)(4^3) = 32 \text{ in}^4$$

$$d = 4 \text{ in.}$$

Allowable stress method :

$$\frac{KL}{d} = \frac{0.7(10)(12)}{4} = 21$$

$$11 < \frac{KL}{d} < 26$$

$$(\sigma_a)_{\text{allow}} = 1.20 \left[1 - \frac{1}{3} \left(\frac{KL/d}{26} \right)^2 \right] = 1.20 \left[1 - \frac{1}{3} \left(\frac{21}{26} \right)^2 \right] = 0.9391 \text{ ksi}$$

$$\sigma_{\text{max}} = (\sigma_a)_{\text{allow}} = \frac{P}{A} + \frac{M_y c}{I_y}$$

$$0.9391 = \frac{P}{24} + \frac{P(1)(2)}{32}$$

$$P = 9.01 \text{ kip} \quad \text{Ans}$$

From *Mechanics of Materials*, Sixth Edition by R. C. Hibbeler, ISBN 0-13-191345-X.

© 2005 R. C. Hibbeler. Published by Pearson Prentice Hall,

Pearson Education, Inc., Upper Saddle River, NJ. All rights reserved.

This material is protected under all copyright laws as they currently exist. No portion of this material may be reproduced, in any form or by any means, without permission in writing from the publisher.

13-127. The member has a symmetric cross section. If it is pin connected at its ends, determine the largest force it can support. It is made of 2014-T6 aluminum alloy.

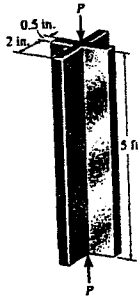

Section properties :

$$A = 4.5(0.5) + 4(0.5) = 4.25 \text{ in}^2$$

$$I = \frac{1}{12}(0.5)(4.5^3) + \frac{1}{12}(4)(0.5)^3 = 3.839 \text{ in}^4$$

$$r = \sqrt{\frac{I}{A}} = \sqrt{\frac{3.839}{4.25}} = 0.9504 \text{ in.}$$

Allowable stress :

$$\frac{KL}{r} = \frac{1.0(5)(12)}{0.9504} = 63.13$$

$$\frac{KL}{r} > 55$$

Long column

$$\sigma_{\text{allow}} = \frac{54000}{(KL/r)^2} = \frac{54000}{63.13^2} = 13.55 \text{ ksi}$$

$$P_{\text{allow}} = \sigma_{\text{allow}}A$$

$$= 13.55(4.25) = 57.6 \text{ kip} \quad \text{Ans}$$

From *Mechanics of Materials*, Sixth Edition by R. C. Hibbeler, ISBN 0-13-191345-X.

© 2005 R. C. Hibbeler. Published by Pearson Prentice Hall,

Pearson Education, Inc., Upper Saddle River, NJ. All rights reserved.

This material is protected under all copyright laws as they currently exist. No portion of this material may be reproduced, in any form or by any means, without permission in writing from the publisher.

*13-128 A steel column has a length of 5 m and is free at one end and fixed at the other end. If the cross-sectional area has the dimensions shown, determine the critical load. $E_{st} = 200 \text{ GPa}$, $\sigma_Y = 360 \text{ MPa}$.

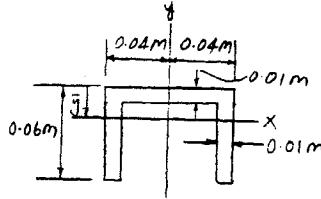
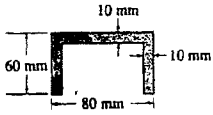

Section properties :

$$A = 0.06(0.01) + 2(0.06)(0.01) = 1.80(10^{-3}) \text{ m}^2$$

$$\bar{y} = \frac{\sum \bar{y}A}{\sum A} = \frac{0.005(0.06)(0.01) + 2[0.03(0.06)(0.01)]}{0.06(0.01) + 2(0.06)(0.01)} = 0.02167 \text{ m}$$

$$I_x = \frac{1}{12}(0.06)(0.01)^3 + 0.06(0.01)(0.02167 - 0.005)^2 + 2\left[\frac{1}{12}(0.01)(0.06)^3 + 0.01(0.06)(0.03 - 0.02167)^2\right] = 0.615(10^{-6}) \text{ m}^4 \quad (\text{controls})$$

$$I_y = \frac{1}{12}(0.06)(0.08)^3 - \frac{1}{12}(0.05)(0.06)^3 = 1.66(10^{-6}) \text{ m}^4$$

Critical load :

$$P_{cr} = \frac{\pi^2 EI}{(KL)^2}; \quad K = 2.0$$

$$= \frac{\pi^2 (200)(10^9)(0.615)(10^{-6})}{[2.0(5)]^2}$$

$$= 12140 \text{ N} = 12.1 \text{ kN} \quad \text{Ans}$$

Check stress :

$$\sigma_{cr} = \frac{P_{cr}}{A} = \frac{12140}{1.80(10^{-3})} = 6.74 \text{ MPa} < \sigma_Y = 360 \text{ MPa}$$

Hence, Euler's equation is still valid.

From *Mechanics of Materials*, Sixth Edition by R. C. Hibbeler, ISBN 0-13-191345-X.

© 2005 R. C. Hibbeler. Published by Pearson Prentice Hall,

Pearson Education, Inc., Upper Saddle River, NJ. All rights reserved.

This material is protected under all copyright laws as they currently exist. No portion of this material may be reproduced, in any form or by any means, without permission in writing from the publisher.

13-129 The square structural A-36 steel tubing has outer dimensions of 8 in. by 8 in. Its cross-sectional area is 14.40 in² and its moments of inertia are $I_x = I_y = 131 \text{ in}^4$. If a load of 120 kip is applied at its top as shown, determine the factor of safety of the tube with respect to yielding. The column can be assumed fixed at its base and free at its top.

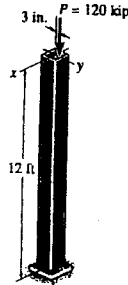

Section properties :

$$A = 14.4 \text{ in}^2; \quad I_x = I_y = 131 \text{ in}^4$$

$$r = \sqrt{\frac{I}{A}} = \sqrt{\frac{131}{14.4}} = 3.01616 \text{ in.}$$

Yielding :

$$\sigma_{\max} = \frac{P}{A} \left[1 + \frac{e c}{r^2} \sec \left(\frac{K L}{2 r} \sqrt{\frac{P}{E A}} \right) \right]; \quad K = 2.0$$

$$\frac{e c}{r^2} = \frac{3(4)}{(3.01616)^2} = 1.319084$$

$$\frac{K L}{2 r} \sqrt{\frac{P}{E A}} = \frac{2(12)(12)}{2(3.01616)} \sqrt{\frac{P}{29(10^3)(14.40)}} = 0.073880 \sqrt{P}$$

$$36(14.4) = P [1 + 1.319084 \sec(0.073880 \sqrt{P})]$$

By trial and error :

$$P = 160.70 \text{ kip} \quad (\text{controls})$$

Buckling :

$$P = P_{\text{cr}} = \frac{\pi^2 E I}{(K L)^2} = \frac{\pi^2 (29)(10^3)(131)}{[2(12)(12)]^2} = 452 \text{ kip}$$

$$\sigma_{\text{cr}} = \frac{P_{\text{cr}}}{A} = \frac{452}{14.4} = 31.4 \text{ ksi} < \sigma_Y = 36 \text{ ksi} \quad (\text{OK})$$

$$\text{F.S.} = \frac{160.70}{120} = 1.34 \quad \text{Ans}$$

From *Mechanics of Materials*, Sixth Edition by R. C. Hibbeler, ISBN 0-13-191345-X.

© 2005 R. C. Hibbeler. Published by Pearson Prentice Hall,

Pearson Education, Inc., Upper Saddle River, NJ. All rights reserved.

This material is protected under all copyright laws as they currently exist. No portion of this material may be reproduced, in any form or by any means, without permission in writing from the publisher.

13-130. The steel pipe is fixed supported at its ends. If it is 4 m long and has an outer diameter of 50 mm, determine its required thickness so that it can support an axial load of $P = 100 \text{ kN}$ without buckling. $E_{st} = 200 \text{ GPa}$, $\sigma_Y = 250 \text{ MPa}$.



$$I = \frac{\pi}{4} (0.025^4 - r_i^4)$$

Critical load :

$$P_{cr} = \frac{\pi^2 E I}{(K L)^2}; \quad K = 0.5$$

$$100 (10^3) = \frac{\pi^2 (200)(10^9) [\frac{\pi}{4} (0.025^4 - r_i^4)]}{[0.5 (4)]^2}$$

$$r_i = 0.01908 \text{ m} = 19.1 \text{ mm}$$

$$t = 25 \text{ mm} - 19.1 \text{ mm} = 5.92 \text{ mm} \quad \text{Ans}$$

Check stress :

$$\sigma = \frac{P_{cr}}{A} = \frac{100 (10^3)}{\pi (0.025^2 - 0.0191^2)} = 122 \text{ MPa} < \sigma_Y = 250 \text{ MPa} \quad (\text{OK})$$

From *Mechanics of Materials*, Sixth Edition by R. C. Hibbeler, ISBN 0-13-191345-X.

© 2005 R. C. Hibbeler. Published by Pearson Prentice Hall,

Pearson Education, Inc., Upper Saddle River, NJ. All rights reserved.

This material is protected under all copyright laws as they currently exist. No portion of this material may be reproduced, in any form or by any means, without permission in writing from the publisher.

13-131 The structural A-36 steel column has the cross section shown. If it is fixed at the bottom and free at the top, determine the maximum force P that can be applied at A without causing it to buckle or yield. Use a factor of safety of 3 with respect to buckling and yielding.

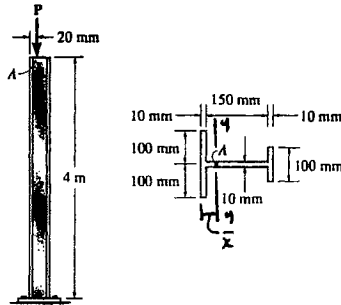

Section properties :

$$\Sigma A = 0.2(0.01) + 0.15(0.01) + 0.1(0.01) = 4.5(10^{-3}) \text{ m}^2$$

$$\bar{x} = \frac{\Sigma \bar{x}A}{\Sigma A} = \frac{0.005(0.2)(0.01) + 0.085(0.15)(0.01) + 0.165(0.1)(0.01)}{4.5(10^{-3})} = 0.06722 \text{ m}$$

$$I_x = \frac{1}{12}(0.2)(0.01^3) + 0.2(0.01)(0.06722 - 0.005)^2 + \frac{1}{12}(0.01)(0.15^3) + 0.01(0.15)(0.085 - 0.06722)^2 + \frac{1}{12}(0.1)(0.01^3) + 0.1(0.01)(0.165 - 0.06722)^2 = 20.615278(10^{-6}) \text{ m}^4$$

$$I_y = \frac{1}{12}(0.01)(0.2^3) + \frac{1}{12}(0.15)(0.01^3) + \frac{1}{12}(0.01)(0.1^3) = 7.5125(10^{-6}) \text{ m}^4$$

$$r_y = \sqrt{\frac{I_x}{A}} = \sqrt{\frac{20.615278(10^{-6})}{4.5(10^{-3})}} = 0.06783648 \text{ m}$$

Buckling about $x-x$ axis :

$$P_{cr} = \frac{\pi^2 EI}{(KL)^2} = \frac{\pi^2(200)(10^9)(7.5125)(10^{-6})}{[2.0(4)]^2} = 231.70 \text{ kN} \quad (\text{controls})$$

$$\sigma_{cr} = \frac{P_{cr}}{A} = \frac{231.7(10^3)}{4.5(10^{-3})} = 51.5 \text{ MPa} < \sigma_y = 250 \text{ MPa}$$

Yielding about $y-y$ axis :

$$\sigma_{max} = \frac{P}{A} \left[1 + \frac{e c}{r^2} \sec\left(\frac{KL}{2r} \sqrt{\frac{P}{EA}}\right) \right]; \quad e = 0.06722 - 0.02 = 0.04722 \text{ m}$$

$$\frac{e c}{r^2} = \frac{0.04722(0.06722)}{(0.06783648)^2} = 0.689815$$

$$\frac{KL}{2r} \sqrt{\frac{P}{EA}} = \frac{2.0(4)}{2(0.06783648)} \sqrt{\frac{P}{200(10^9)(4.5)(10^{-3})}} = 1.965511(10^{-3})\sqrt{P}$$

$$250(10^6)(4.5)(10^{-3}) = P [1 + 0.689815 \sec(1.965511(10^{-3})\sqrt{P})]$$

By trial and error :

$$P = 379.8 \text{ kN}$$

Hence,

$$P_{allow} = \frac{231.70}{3} = 77.2 \text{ kN} \quad \text{Ans}$$

From *Mechanics of Materials*, Sixth Edition by R. C. Hibbeler, ISBN 0-13-191345-X.

© 2005 R. C. Hibbeler. Published by Pearson Prentice Hall,

Pearson Education, Inc., Upper Saddle River, NJ. All rights reserved.

This material is protected under all copyright laws as they currently exist. No portion of this material may be reproduced, in any form or by any means, without permission in writing from the publisher.

*13-132 The structural A-36 steel column has the cross section shown. If it is fixed at the bottom and free at the top, determine if the column will buckle or yield when the load $P = 10$ kN. Use a factor of safety of 3 with respect to buckling and yielding.

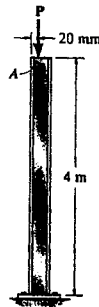

Section properties :

$$\Sigma A = 0.2(0.01) + 0.15(0.01) + 0.1(0.01) = 4.5(10^{-3}) \text{ m}^2$$

$$\bar{x} = \frac{\Sigma \bar{x}A}{\Sigma A} = \frac{0.005(0.2)(0.01) + 0.085(0.15)(0.01) + 0.165(0.1)(0.01)}{4.5(10^{-3})} = 0.06722 \text{ m}$$

$$I_x = \frac{1}{12}(0.2)(0.01^3) + 0.2(0.01)(0.06722 - 0.005)^2 + \frac{1}{12}(0.01)(0.15^3) + 0.01(0.15)(0.085 - 0.06722)^2 + \frac{1}{12}(0.1)(0.01^3) + 0.1(0.01)(0.165 - 0.06722)^2 = 20.615278(10^{-6}) \text{ m}^4$$

$$I_y = \frac{1}{12}(0.01)(0.2^3) + \frac{1}{12}(0.15)(0.01^3) + \frac{1}{12}(0.01)(0.1^3) = 7.5125(10^{-6}) \text{ m}^4$$

$$r_y = \sqrt{\frac{I_y}{A}} = \sqrt{\frac{20.615278(10^{-6})}{4.5(10^{-3})}} = 0.06783648 \text{ m}$$

Buckling about $x-x$ axis :

$$P_{cr} = \frac{\pi^2 EI}{(KL)^2} = \frac{\pi^2(200)(10^9)(7.5125)(10^{-6})}{[2.0(4)]^2} = 231.70 \text{ kN}$$

$$\sigma_{cr} = \frac{P_{cr}}{A} = \frac{231.7(10^3)}{4.5(10^{-3})} = 51.5 \text{ MPa} < \sigma_y = 250 \text{ MPa} \quad (\text{OK})$$

$$P_{allow} = \frac{P_{cr}}{\text{FS}} = \frac{231.7}{3} = 77.2 \text{ kN} > P = 10 \text{ kN}$$

Hence the column does not buckle !

Yielding about $y-y$ axis :

$$\sigma_{max} = \frac{P}{A} \left[1 + \frac{e c}{r^2} \sec\left(\frac{KL}{2r} \sqrt{\frac{P}{EA}}\right) \right] \quad e = 0.06722 - 0.02 = 0.04722 \text{ m}$$

$$P = \frac{10}{3} = 3.333 \text{ kN}$$

$$\frac{P}{A} = \frac{3.333(10^3)}{4.5(10^{-3})} = 0.7407 \text{ MPa}$$

$$\frac{e c}{r^2} = \frac{0.04722(0.06722)}{(0.06783648)^2} = 0.689815$$

$$\frac{KL}{2r} \sqrt{\frac{P}{EA}} = \frac{2.0(4)}{2(0.06783648)} \sqrt{\frac{3.333(10^3)}{200(10^9)(4.5)(10^{-3})}} = 0.1134788$$

$$\sigma_{max} = 0.7407 [1 + 0.689815 \sec(0.1134788)] = 1.25 \text{ MPa} < \sigma_y = 250 \text{ MPa}$$

Hence the column does not yield!

No. Ans

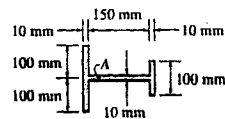

From *Mechanics of Materials*, Sixth Edition by R. C. Hibbeler, ISBN 0-13-191345-X.

© 2005 R. C. Hibbeler. Published by Pearson Prentice Hall,

Pearson Education, Inc., Upper Saddle River, NJ. All rights reserved.

This material is protected under all copyright laws as they currently exist. No portion of this material may be reproduced, in any form or by any means, without permission in writing from the publisher.

13-133 The $W 10 \times 45$ steel column supports an axial load of 60 kip in addition to an eccentric load P . Determine the maximum allowable value of P based on the AISC equations of Sec. 13.6 and Eq. 13-30. Assume that in the $x-z$ plane $K_x = 1.0$ and in the $y-z$ plane $K_y = 2.0$. $E_s = 29(10^3)$ ksi, $\sigma_Y = 50$ ksi.

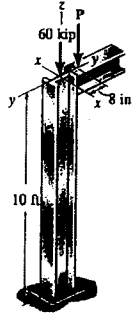

Section properties for $W 10 \times 45$:

$$A = 13.3 \text{ in}^2 \quad d = 10.10 \text{ in.} \quad I_x = 248 \text{ in}^4$$

$$r_x = 4.32 \text{ in.} \quad r_y = 2.01 \text{ in.}$$

Allowable stress method :

$$\left(\frac{KL}{r}\right)_x = \frac{1.0(10)(12)}{4.32} = 27.8$$

$$\left(\frac{KL}{r}\right)_y = \frac{2.0(10)(12)}{2.01} = 119.4 \quad (\text{controls})$$

$$\left(\frac{KL}{r}\right)_c = \sqrt{\frac{2\pi^2 E}{\sigma_Y}} = \sqrt{\frac{2\pi^2(29)(10^3)}{50}} = 107$$

$$\frac{KL}{r} > \left(\frac{KL}{r}\right)_c$$

$$(\sigma_a)_{\text{allow}} = \frac{12\pi^2 E}{23(KL/r)^2} = \frac{12\pi^2(29)(10^3)}{23(119.4)^2} = 10.47 \text{ ksi}$$

$$\sigma_{\text{max}} = (\sigma_a)_{\text{allow}} = \frac{P}{A} + \frac{Mc}{I}$$

$$10.47 = \frac{P + 60}{13.3} + \frac{P(8)\left(\frac{10.10}{2}\right)}{248}$$

$$P = 25.0 \text{ kip} \quad \text{Ans}$$

From *Mechanics of Materials*, Sixth Edition by R. C. Hibbeler, ISBN 0-13-191345-X.

© 2005 R. C. Hibbeler. Published by Pearson Prentice Hall,

Pearson Education, Inc., Upper Saddle River, NJ. All rights reserved.

This material is protected under all copyright laws as they currently exist. No portion of this material may be reproduced, in any form or by any means, without permission in writing from the publisher.

13-134 The $W_{14} \times 53$ structural A-36 steel column supports an axial load of 60 kip in addition to an eccentric load P . Determine the maximum allowable value of P based on the AISC equations of Sec. 13.6 and Eq. 13-30. Assume that in the x - z plane $K_x = 1.0$ and in the y - z plane $K_y = 2.0$.

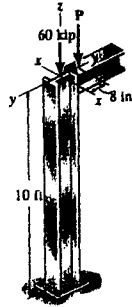

Section properties for $W_{14} \times 53$:

$$A = 15.6 \text{ in}^2 \quad d = 13.92 \text{ in.}$$

$$I_x = 541 \text{ in}^4 \quad r_x = 5.89 \text{ in.} \quad r_y = 1.92 \text{ in.}$$

Allowable stress method :

$$\left(\frac{KL}{r}\right)_x = \frac{1.0(10)(12)}{5.89} = 20.37$$

$$\left(\frac{KL}{r}\right)_y = \frac{2.0(10)(12)}{1.92} = 125$$

$$\left(\frac{KL}{r}\right)_c = \sqrt{\frac{2\pi^2 E}{r_y}} = \sqrt{\frac{2\pi^2(29)(10^3)}{36}} = 126.1$$

$$\left(\frac{KL}{r}\right)_y < \left(\frac{KL}{r}\right)_c$$

$$(\sigma_a)_{\text{allow}} = \frac{[1 - \frac{1}{2}(\frac{KL/r}{(KL/r)_c})^2] \sigma_Y}{\frac{5}{3} + \frac{3}{8}(\frac{KL/r}{(KL/r)_c}) - \frac{1}{8}(\frac{KL/r}{(KL/r)_c})^3} = \frac{[1 - \frac{1}{2}(\frac{125}{126.1})^2] 36}{\frac{5}{3} + \frac{3}{8}(\frac{125}{126.1}) - \frac{1}{8}(\frac{125}{126.1})^3} = 9.55 \text{ ksi}$$

$$\sigma_{\text{max}} = \sigma_{\text{allow}} = \frac{P}{A} + \frac{Mc}{I}$$

$$9.55 = \frac{P + 60}{15.6} + \frac{P(8)(\frac{13.92}{2})}{541}$$

$$P = 34.2 \text{ ksi} \quad \text{Ans}$$

From *Mechanics of Materials*, Sixth Edition by R. C. Hibbeler, ISBN 0-13-191345-X.

© 2005 R. C. Hibbeler. Published by Pearson Prentice Hall,

Pearson Education, Inc., Upper Saddle River, NJ. All rights reserved.

This material is protected under all copyright laws as they currently exist. No portion of this material may be reproduced, in any form or by any means, without permission in writing from the publisher.

14-1. A material is subjected to a general state of plane stress. Express the strain energy density in terms of the elastic constants E , G , and ν and the stress components σ_x , σ_y , and τ_{xy} .

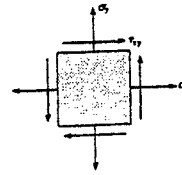

Strain Energy Due to Normal Stresses : We will consider the application of normal stresses on the element in two successive stages. For the first stage, we apply only σ_x on the element. Since σ_x is a constant, from Eq. 14-8, we have

$$(U_i)_1 = \int_V \frac{\sigma_x^2}{2E} dV = \frac{\sigma_x^2 V}{2E}$$

When σ_y is applied in the second stage, the normal strain ϵ_x will be strained by $\epsilon_x' = -\nu\epsilon_y = -\frac{\nu\sigma_y}{E}$. Therefore, the strain energy for the second stage is

$$\begin{aligned} (U_i)_2 &= \int_V \left(\frac{\sigma_x^2}{2E} + \sigma_x \epsilon_x' \right) dV \\ &= \int_V \left[\frac{\sigma_x^2}{2E} + \sigma_x \left(-\frac{\nu\sigma_y}{E} \right) \right] dV \end{aligned}$$

Since σ_x and σ_y are constants,

$$(U_i)_2 = \frac{V}{2E} (\sigma_x^2 - 2\nu\sigma_x\sigma_y)$$

Strain Energy Due to Shear Stress : The application of τ_{xy} does not strain the element in normal direction. Thus, from Eq. 14-11, we have

$$(U_i)_3 = \int_V \frac{\tau_{xy}^2}{2G} dV = \frac{\tau_{xy}^2 V}{2G}$$

The total strain energy is

$$\begin{aligned} U_i &= (U_i)_1 + (U_i)_2 + (U_i)_3 \\ &= \frac{\sigma_x^2 V}{2E} + \frac{V}{2E} (\sigma_x^2 - 2\nu\sigma_x\sigma_y) + \frac{\tau_{xy}^2 V}{2G} \\ &= \frac{V}{2E} (\sigma_x^2 + \sigma_y^2 - 2\nu\sigma_x\sigma_y) + \frac{\tau_{xy}^2 V}{2G} \end{aligned}$$

and the strain energy density is

$$\frac{U_i}{V} = \frac{1}{2E} (\sigma_x^2 + \sigma_y^2 - 2\nu\sigma_x\sigma_y) + \frac{\tau_{xy}^2}{2G} \quad \text{Ans}$$

From *Mechanics of Materials*, Sixth Edition by R. C. Hibbeler, ISBN 0-13-191345-X.

© 2005 R. C. Hibbeler. Published by Pearson Prentice Hall,

Pearson Education, Inc., Upper Saddle River, NJ. All rights reserved.

This material is protected under all copyright laws as they currently exist. No portion of this material may be reproduced, in any form or by any means, without permission in writing from the publisher.

14-2 The strain-energy density must be the same whether the state of stress is represented by σ_x , σ_y , and τ_{xy} , or by the principal stresses σ_1 and σ_2 . This being the case, equate the strain-energy expressions for each of these two cases and show that $G = E/[2(1 + \nu)]$.

$$U = \int_V \left[\frac{1}{2E} (\sigma_x^2 + \sigma_y^2) - \frac{\nu}{E} \sigma_x \sigma_y + \frac{1}{2G} \tau_{xy}^2 \right] dV$$

$$U = \int_V \left[\frac{1}{2E} (\sigma_1^2 + \sigma_2^2) - \frac{\nu}{E} \sigma_1 \sigma_2 \right] dV$$

Equating the above two equations yields.

$$\frac{1}{2E} (\sigma_x^2 + \sigma_y^2) - \frac{\nu}{E} \sigma_x \sigma_y + \frac{1}{2G} \tau_{xy}^2 = \frac{1}{2E} (\sigma_1^2 + \sigma_2^2) - \frac{\nu}{E} \sigma_1 \sigma_2 \quad (1)$$

$$\text{However, } \sigma_{1,2} = \frac{\sigma_x + \sigma_y}{2} \pm \sqrt{\left(\frac{\sigma_x - \sigma_y}{2}\right)^2 + \tau_{xy}^2}$$

$$\text{Thus, } (\sigma_1^2 + \sigma_2^2) = \sigma_x^2 + \sigma_y^2 + 2\tau_{xy}^2$$

$$\sigma_1 \sigma_2 = \sigma_x \sigma_y - \tau_{xy}^2$$

Substitute into Eq.(1)

$$\frac{1}{2E} (\sigma_x^2 + \sigma_y^2) - \frac{\nu}{E} \sigma_x \sigma_y + \frac{1}{2G} \tau_{xy}^2 = \frac{1}{2E} (\sigma_x^2 + \sigma_y^2 + 2\tau_{xy}^2) - \frac{\nu}{E} \sigma_x \sigma_y + \frac{\nu}{E} \tau_{xy}^2$$

$$\frac{1}{2G} \tau_{xy}^2 = \frac{\tau_{xy}^2}{E} + \frac{\nu}{E} \tau_{xy}^2$$

$$\frac{1}{2G} = \frac{1}{E} + \frac{\nu}{E}$$

$$\frac{1}{2G} = \frac{1}{E} (1 + \nu)$$

$$G = \frac{E}{2(1 + \nu)} \quad \text{QED}$$

From *Mechanics of Materials*, Sixth Edition by R. C. Hibbeler, ISBN 0-13-191345-X.

© 2005 R. C. Hibbeler. Published by Pearson Prentice Hall,

Pearson Education, Inc., Upper Saddle River, NJ. All rights reserved.

This material is protected under all copyright laws as they currently exist. No portion of this material may be reproduced, in any form or by any means, without permission in writing from the publisher.

14-3 Determine the strain energy in the rod assembly. Portion AB is steel, BC is brass, and CD is aluminum. $E_{st} = 200 \text{ GPa}$, $E_{br} = 101 \text{ GPa}$, $E_{al} = 73.1 \text{ GPa}$.

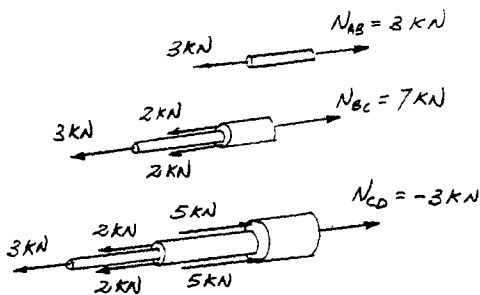
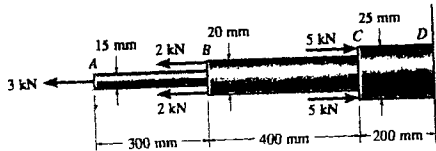

$$\begin{aligned}
 U_i &= \sum \frac{N^2 L}{2 A E} \\
 &= \frac{[3 (10^3)]^2 (0.3)}{2 \left(\frac{\pi}{4}\right) (0.015^2) (200) (10^9)} + \frac{[7 (10^3)]^2 (0.4)}{2 \left(\frac{\pi}{4}\right) (0.02^2) (101) (10^9)} + \frac{[-3 (10^3)]^2 (0.2)}{2 \left(\frac{\pi}{4}\right) (0.025^2) (73.1) (10^9)} \\
 &= 0.372 \text{ N.m} = 0.372 \text{ J} \quad \text{Ans}
 \end{aligned}$$

From *Mechanics of Materials*, Sixth Edition by R. C. Hibbeler, ISBN 0-13-191345-X.

© 2005 R. C. Hibbeler. Published by Pearson Prentice Hall,

Pearson Education, Inc., Upper Saddle River, NJ. All rights reserved.

This material is protected under all copyright laws as they currently exist. No portion of this material may be reproduced, in any form or by any means, without permission in writing from the publisher.

*14-4 Using bolts of the same material and cross-sectional area, two possible attachments for a cylinder head are shown. Compare the strain energy developed in each case, and then explain which design is better for resisting an axial shock or impact load.

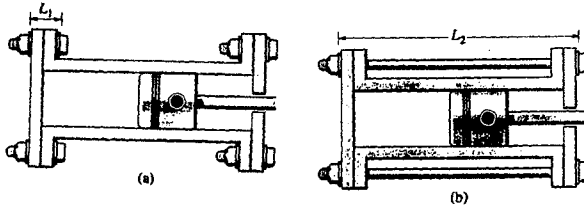

Case (a)

$$U_A = \frac{N^2 L_1}{2AE}$$

Case (b)

$$U_B = \frac{N^2 L_2}{2AE}$$

Since $U_B > U_A$,i.e., $L_2 > L_1$ the design for case (b) is better able to absorb energy.

Case (b) **Ans**

From *Mechanics of Materials*, Sixth Edition by R. C. Hibbeler, ISBN 0-13-191345-X.

© 2005 R. C. Hibbeler. Published by Pearson Prentice Hall,

Pearson Education, Inc., Upper Saddle River, NJ. All rights reserved.

This material is protected under all copyright laws as they currently exist. No portion of this material may be reproduced, in any form or by any means, without permission in writing from the publisher.

14-5. Determine the torsional strain energy in the A-36 steel shaft. The shaft has a radius of 30 mm.

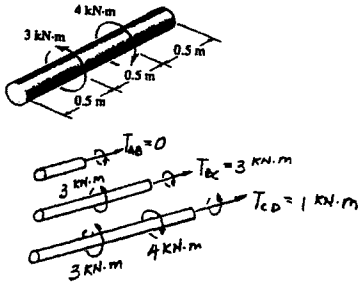

$$\begin{aligned}
 U_i &= \sum \frac{T^2 L}{2JG} = \frac{1}{2JG} [0^2(0.5) + ((3)(10^3))^2(0.5) + ((1)(10^3))^2(0.5)] \\
 &= \frac{2.5(10^6)}{JG} \\
 &= \frac{2.5(10^6)}{75(10^9)(\frac{\pi}{4})(0.03)^4} = 26.2 \text{ N} \cdot \text{m} = 26.2 \text{ J} \quad \text{Ans}
 \end{aligned}$$

From *Mechanics of Materials*, Sixth Edition by R. C. Hibbeler, ISBN 0-13-191345-X.

© 2005 R. C. Hibbeler. Published by Pearson Prentice Hall,

Pearson Education, Inc., Upper Saddle River, NJ. All rights reserved.

This material is protected under all copyright laws as they currently exist. No portion of this material may be reproduced, in any form or by any means, without permission in writing from the publisher.

14-6. Determine the bending strain energy in the A-36 structural steel $W10 \times 12$ beam. Obtain the answer using the coordinates (a) x_1 and x_4 , and (b) x_2 and x_3 .

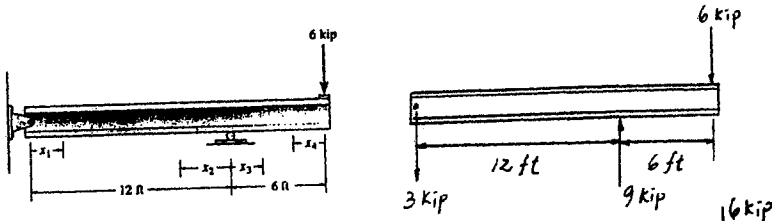

$$\begin{aligned}
 a) \quad U_i &= \int_0^L \frac{M^2 dx}{2EI} \\
 &= \int_0^{144} \frac{(-3x_1)^2 dx_1}{2EI} + \int_0^{72} \frac{(-6x_4)^2 dx_4}{2EI} \\
 &= \frac{9}{2EI} \frac{144^3}{3} + \frac{36}{2EI} \frac{72^3}{3} \\
 &= \frac{6718464}{29 (53.8)} = 4306 \text{ lb}\cdot\text{in.} \quad \text{Ans}
 \end{aligned}$$

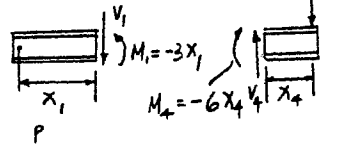

$$\begin{aligned}
 b) \quad M_3 &= 6x_3 - 432 \\
 M_2 &= 9x_2 - 6(x_2 + 72) = 3x_2 - 432
 \end{aligned}$$

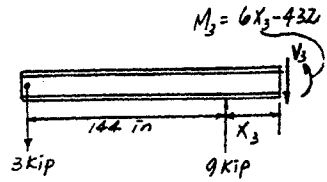

$$\begin{aligned}
 U_i &= \int_0^{144} \frac{(3x_2 - 432)^2 dx_2}{2EI} + \int_0^{72} \frac{(6x_3 - 432)^2 dx_3}{2EI} \\
 &= \int_0^{144} \frac{(9x_2^2 - 2592x_2 + 186624) dx_2}{2EI} + \int_0^{72} \frac{(36x_3^2 - 5184x_3 + 186624) dx_3}{2EI} \\
 &= \frac{1}{2EI} \left[3(144)^3 - \frac{2592}{2}(144)^2 + 186624(144) \right. \\
 &\quad \left. + 12(72)^3 - \frac{5184}{2}(72)^2 + 186624(72) \right] \\
 &= \frac{6718464}{29 (53.8)} = 4306 \text{ lb}\cdot\text{in.} \quad \text{Ans}
 \end{aligned}$$

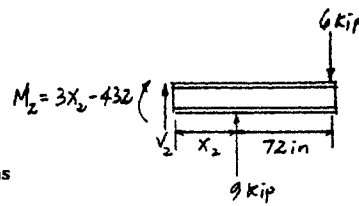

From *Mechanics of Materials*, Sixth Edition by R. C. Hibbeler, ISBN 0-13-191345-X.
 © 2005 R. C. Hibbeler. Published by Pearson Prentice Hall,
 Pearson Education, Inc., Upper Saddle River, NJ. All rights reserved.
 This material is protected under all copyright laws as they currently exist. No portion of this material may be reproduced, in any form or by any means, without permission in writing from the publisher.

14-7. Determine the bending strain energy in the beam due to the loading shown. EI is constant.

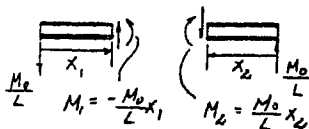
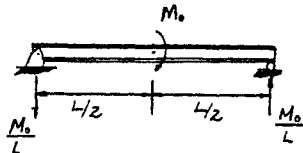
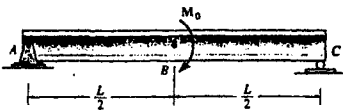

$$\begin{aligned}
 U_i &= \int_0^L \frac{M^2 dx}{2EI} \\
 &= \frac{1}{2EI} \left[\int_0^{L/2} \left(\frac{-M_0}{L} x_1 \right)^2 dx_1 + \int_0^{L/2} \left(\frac{M_0}{L} x_2 \right)^2 dx_2 \right] \\
 &= \frac{M_0^2 L}{24EI} \quad \text{Ans}
 \end{aligned}$$

Note : Strain energy is always positive regardless of the sign of the moment function.

From *Mechanics of Materials*, Sixth Edition by R. C. Hibbeler, ISBN 0-13-191345-X.

© 2005 R. C. Hibbeler. Published by Pearson Prentice Hall,

Pearson Education, Inc., Upper Saddle River, NJ. All rights reserved.

This material is protected under all copyright laws as they currently exist. No portion of this material may be reproduced, in any form or by any means, without permission in writing from the publisher.

***14-8.** Determine the total axial and bending strain energy in the A-36 steel beam. $A = 2300 \text{ mm}^2$, $I = 9.5(10^6) \text{ mm}^4$,

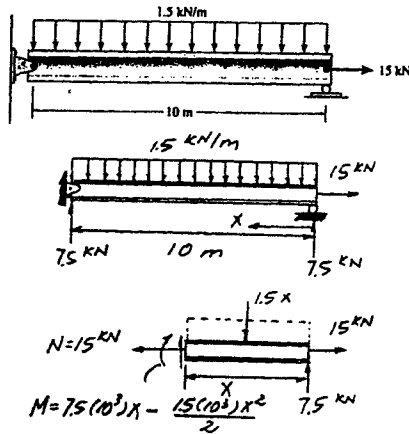

Axial load :

$$(U_a)_i = \int_0^L \frac{N^2 dx}{2EA} = \frac{N^2 L}{2EA}$$

$$(U_a)_i = \frac{((15)(10^3))^2 (10)}{2(200)(10^9)(2.3)(10^{-3})} = 2.4456 \text{ J}$$

Bending :

$$(U_b)_i = \int_0^L \frac{M^2 dx}{2EI} = \frac{1}{2EI} \int_0^{10} [(7.5)(10^3)x - 0.75(10^3)x^2]^2 dx$$

$$= \frac{1}{2EI} \int_0^{10} [56.25(10^6)x^2 + 562.5(10^3)x^4 - 11.25(10^6)x^3] dx$$

$$(U_b)_i = \frac{0.9375(10^9)}{200(10^9)(9.5)(10^{-6})} = 493.4210 \text{ J}$$

$$U_i = (U_a)_i + (U_b)_i = 2.4456 + 493.4210 = 496 \text{ J} \quad \text{Ans}$$

From *Mechanics of Materials*, Sixth Edition by R. C. Hibbeler, ISBN 0-13-191345-X.

© 2005 R. C. Hibbeler. Published by Pearson Prentice Hall,

Pearson Education, Inc., Upper Saddle River, NJ. All rights reserved.

This material is protected under all copyright laws as they currently exist. No portion of this material may be reproduced, in any form or by any means, without permission in writing from the publisher.

14-9. Determine the total axial and bending strain energy in the A-36 structural steel $W8 \times 58$ beam.

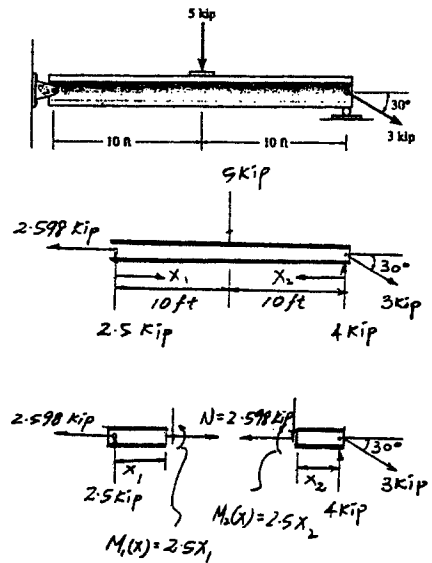

Axial load :

$$\begin{aligned}
 (U_a)_i &= \int_0^L \frac{N^2 dx}{2AE} = \frac{N^2 L}{2AE} \\
 &= \frac{[2.598]^2 (20)(12)}{2(17.1)(29)(10^3)} = 1.6334 (10^{-3}) \text{ in} \cdot \text{kip} \\
 &= 0.1361 (10^{-3}) \text{ ft} \cdot \text{kip}
 \end{aligned}$$

Bending :

$$\begin{aligned}
 (U_b)_i &= \int_0^L \frac{M^2 dx}{2EI} = \frac{2}{2EI} \int_0^{120 \text{ in.}} (2.5x)^2 dx \\
 &= \frac{3.6 (10^6)}{EI} = \frac{3.6 (10^6)}{29 (10^3)(228)} \\
 &= 0.5446 \text{ in} \cdot \text{kip} = 0.04537 \text{ ft} \cdot \text{kip}
 \end{aligned}$$

Total strain energy :

$$\begin{aligned}
 U_i &= (U_a)_i + (U_b)_i \\
 &= 0.1361 (10^{-3}) + 0.04537 \\
 &= 0.0455 \text{ ft} \cdot \text{kip} = 45.5 \text{ ft} \cdot \text{lb} \quad \text{Ans}
 \end{aligned}$$

From *Mechanics of Materials*, Sixth Edition by R. C. Hibbeler, ISBN 0-13-191345-X.

© 2005 R. C. Hibbeler. Published by Pearson Prentice Hall,

Pearson Education, Inc., Upper Saddle River, NJ. All rights reserved.

This material is protected under all copyright laws as they currently exist. No portion of this material may be reproduced, in any form or by any means, without permission in writing from the publisher.

14-10 The simply supported beam is subjected to the loading shown. Determine the bending strain energy in the beam.

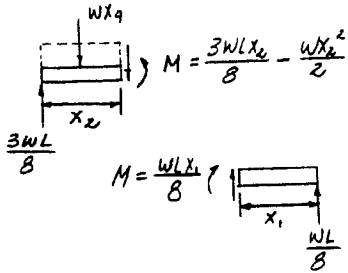
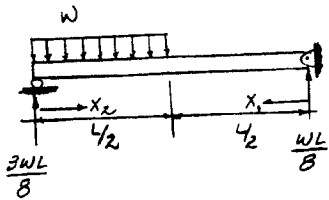
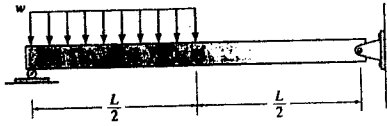

$$\begin{aligned}
 U_i &= \int_0^L \frac{M^2 dx}{2EI} = \frac{1}{2EI} \left[\int_0^{L/2} \left(\frac{3wLx_2}{8} - \frac{wx_2^2}{2} \right)^2 dx_2 + \int_0^{L/2} \left(\frac{wLx_1}{8} \right)^2 dx_1 \right] \\
 &= \frac{1}{2EI} \left[\int_0^{L/2} \left(\frac{9w^2L^2x_2^2}{64} + \frac{w^2x_2^4}{4} - \frac{3w^2Lx_2^3}{8} \right) dx_2 + \int_0^{L/2} \frac{w^2L^2x_1^2}{64} dx_1 \right] \\
 &= \frac{0.00111w^2L^5}{EI} \quad \text{Ans}
 \end{aligned}$$

From *Mechanics of Materials*, Sixth Edition by R. C. Hibbeler, ISBN 0-13-191345-X.

© 2005 R. C. Hibbeler. Published by Pearson Prentice Hall,

Pearson Education, Inc., Upper Saddle River, NJ. All rights reserved.

This material is protected under all copyright laws as they currently exist. No portion of this material may be reproduced, in any form or by any means, without permission in writing from the publisher.

14-11 Determine the bending strain energy in the A-36 steel beam due to the loading shown. Obtain the answer using the coordinates (a) x_1 and x_4 , and (b) x_2 and x_3 . $I = 53.8 \text{ in}^4$.

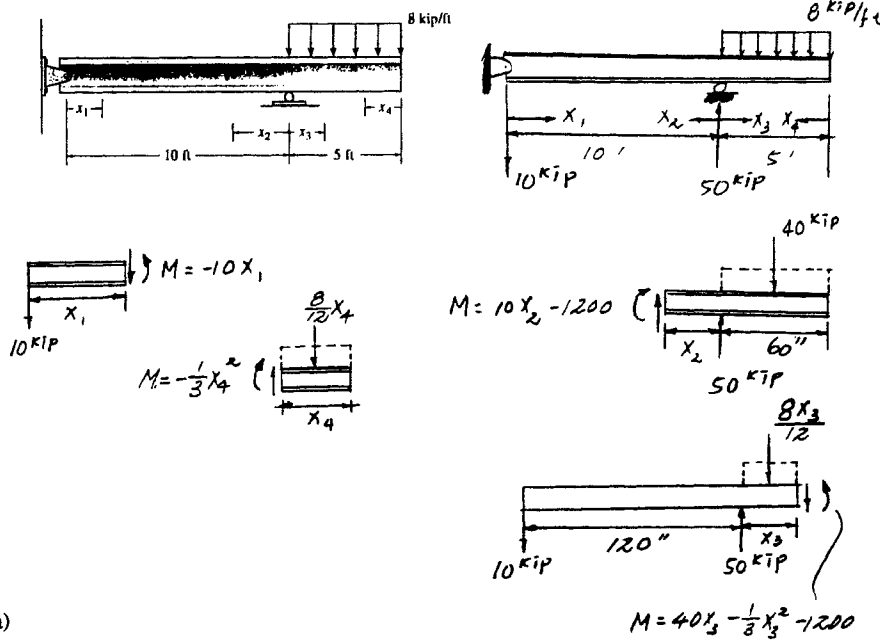

a)

$$U_i = \int_0^L \frac{M^2 dx}{2EI} = \frac{1}{2EI} \left[\int_0^{120 \text{ in.}} (-10x_1)^2 dx_1 + \int_0^{60 \text{ in.}} \left(-\frac{1}{3}x_4^2\right)^2 dx_4 \right]$$

$$= \frac{37.44(10^6)}{EI} = \frac{37.44(10^6)}{29(10^3)(53.8)} = 24.00 \text{ in.} \cdot \text{kip} = 2.00 \text{ ft} \cdot \text{kip} \quad \text{Ans}$$

b)

$$U_i = \int_0^L \frac{M^2 dx}{2EI} = \frac{1}{2EI} \left[\int_0^{60 \text{ in.}} \left(40x_3 - \frac{1}{3}x_3^2 - 1200\right)^2 dx_3 + \int_0^{120 \text{ in.}} (10x_2 - 1200)^2 dx_2 \right]$$

$$= \frac{1}{2EI} \left[\int_0^{60 \text{ in.}} \left(\frac{1}{9}x_3^4 - \frac{80}{3}x_3^3 + 2400x_3^2 - 96000x_3 + 1440000\right) dx_3 + \int_0^{120 \text{ in.}} (100x_2^2 - 24000x_2 + 1440000) dx_2 \right]$$

$$= \frac{37.44(10^6)}{EI} = \frac{37.44(10^6)}{29(10^3)(53.8)} = 24.00 \text{ in.} \cdot \text{kip} = 2.00 \text{ ft} \cdot \text{kip} \quad \text{Ans}$$

From *Mechanics of Materials*, Sixth Edition by R. C. Hibbeler, ISBN 0-13-191345-X.

© 2005 R. C. Hibbeler. Published by Pearson Prentice Hall,

Pearson Education, Inc., Upper Saddle River, NJ. All rights reserved.

This material is protected under all copyright laws as they currently exist. No portion of this material may be reproduced, in any form or by any means, without permission in writing from the publisher.

*14-12. Determine the bending strain energy in the simply supported beam due to a uniform load w . Solve the problem two ways. (a) Apply Eq. 14-17. (b) The load $w dx$ acting on the segment dx of the beam is displaced a distance y , where $y = w(-x^4 + 2Lx^3 - L^3x)/(24EI)$, the equation of the elastic curve. Hence the internal strain energy in the differential segment dx of the beam is equal to the external work, i.e., $dU_i = \frac{1}{2}(w dx)(-y)$. Integrate this equation to obtain the total strain energy in the beam. EI is constant.

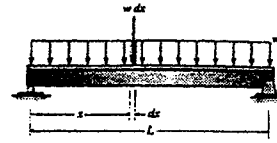

Support Reactions : As shown on FBD(a).

Internal Moment Function : As shown on FBD(b).

Bending Strain Energy : a) Applying Eq. 14-17 gives

$$\begin{aligned}
 U_i &= \int_0^L \frac{M^2 dx}{2EI} \\
 &= \frac{1}{2EI} \left[\int_0^L \left[\frac{w}{2} (Lx - x^2) \right]^2 dx \right] \\
 &= \frac{w^2}{8EI} \left[\int_0^L (L^2x^2 + x^4 - 2Lx^3) dx \right] \\
 &= \frac{w^2 L^3}{240EI} \quad \text{Ans}
 \end{aligned}$$

b) Integrating $dU_i = \frac{1}{2}(w dx)(-y)$

$$dU_i = \frac{1}{2}(w dx) \left[-\frac{w}{24EI} (-x^4 + 2Lx^3 - L^3x) \right]$$

$$dU_i = \frac{w^2}{48EI} (x^4 - 2Lx^3 + L^3x) dx$$

$$\begin{aligned}
 U_i &= \frac{w^2}{48EI} \int_0^L (x^4 - 2Lx^3 + L^3x) dx \\
 &= \frac{w^2 L^3}{240EI} \quad \text{Ans}
 \end{aligned}$$

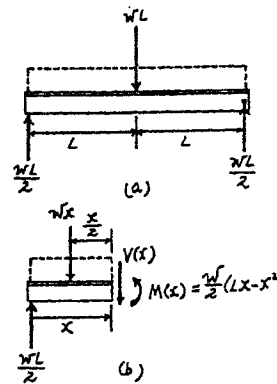

From *Mechanics of Materials*, Sixth Edition by R. C. Hibbeler, ISBN 0-13-191345-X.

© 2005 R. C. Hibbeler. Published by Pearson Prentice Hall,

Pearson Education, Inc., Upper Saddle River, NJ. All rights reserved.

This material is protected under all copyright laws as they currently exist. No portion of this material may be reproduced, in any form or by any means, without permission in writing from the publisher.

- * 14-13. Determine the bending strain energy in the cantilevered beam due to a uniform load w . Solve the problem two ways (a) Apply Eq. 14-17. (b) The load $w dx$ acting on a segment dx of the beam is displaced a distance y , where $y = w(-x^4 + 4L^3x - 3L^4)/(24EI)$, the equation of the elastic curve. Hence the internal strain energy in the differential segment dx of the beam is equal to the external work, i.e., $dU_i = \frac{1}{2}(w dx)(-y)$. Integrate this equation to obtain the total strain energy in the beam. EI is constant.

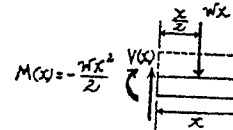
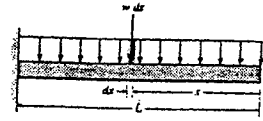

Internal Moment Function : As shown on FBD.

Bending Strain Energy : a) Applying Eq. 14-17 gives

$$\begin{aligned}
 U_i &= \int_0^L \frac{M^2 dx}{2EI} \\
 &= \frac{1}{2EI} \left[\int_0^L \left[-\frac{w}{2} x^2 \right]^2 dx \right] \\
 &= \frac{w^2}{8EI} \left[\int_0^L x^4 dx \right] \\
 &= \frac{w^2 L^5}{40EI}
 \end{aligned}$$

Ans

b) Integrating $dU_i = \frac{1}{2}(w dx)(-y)$

$$\begin{aligned}
 dU_i &= \frac{1}{2}(w dx) \left[-\frac{w}{24EI} (-x^4 + 4L^3x - 3L^4) \right] \\
 dU_i &= \frac{w^2}{48EI} (x^4 - 4L^3x + 3L^4) dx \\
 U_i &= \frac{w^2}{48EI} \int_0^L (x^4 - 4L^3x + 3L^4) dx \\
 &= \frac{w^2 L^5}{40EI}
 \end{aligned}$$

Ans

From *Mechanics of Materials*, Sixth Edition by R. C. Hibbeler, ISBN 0-13-191345-X.

© 2005 R. C. Hibbeler. Published by Pearson Prentice Hall,

Pearson Education, Inc., Upper Saddle River, NJ. All rights reserved.

This material is protected under all copyright laws as they currently exist. No portion of this material may be reproduced, in any form or by any means, without permission in writing from the publisher.

14-14 Determine the shear strain energy in the beam. The beam has a rectangular cross section of area A , and the shear modulus is G .

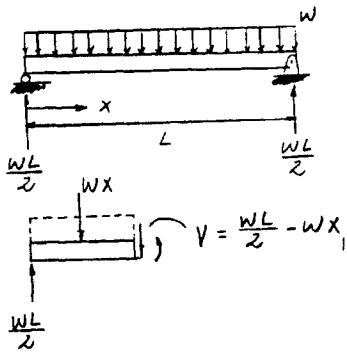
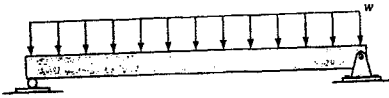

$$\begin{aligned}
 U_i &= \int_0^L \frac{f_s V^2 dx}{2GA} = \frac{f_s}{2GA} \int_0^L \left(\frac{wL}{2} - wx \right)^2 dx \\
 &= \frac{f_s}{2GA} \int_0^L \left(\frac{w^2 L^2}{4} + w^2 x^2 - w^2 Lx \right) dx \\
 &= \frac{f_s w^2 L^3}{24GA}
 \end{aligned}$$

For a rectangular section $f_s = \frac{6}{5}$

$$U_i = \frac{w^2 L^3}{20GA} \quad \text{Ans}$$

From *Mechanics of Materials*, Sixth Edition by R. C. Hibbeler, ISBN 0-13-191345-X.

© 2005 R. C. Hibbeler. Published by Pearson Prentice Hall,

Pearson Education, Inc., Upper Saddle River, NJ. All rights reserved.

This material is protected under all copyright laws as they currently exist. No portion of this material may be reproduced, in any form or by any means, without permission in writing from the publisher.

14-15 The concrete column contains six 1-in.-diameter steel reinforcing rods. If the column supports a load of 300 kip, determine the strain energy in the column. $E_{st} = 29(10^3)$ ksi, $E_c = 3.6(10^3)$ ksi:

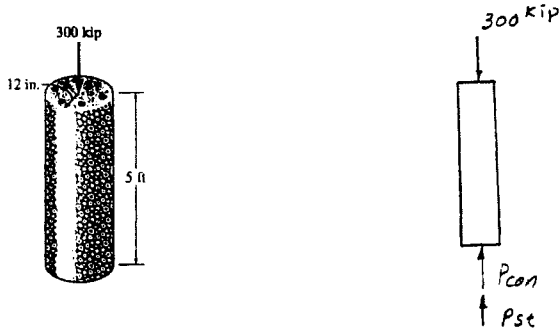

Equilibrium :

$$+\uparrow \Sigma F_y = 0; \quad P_{con} + P_{st} - 300 = 0 \quad (1)$$

Compatibility condition :

$$\Delta_{con} = \Delta_{st}$$

$$\frac{P_{con} L}{[\pi (12^2) - 6\pi (0.5^2)](3.6)(10^3)} = \frac{P_{st} L}{6\pi (0.5^2)(29)(10^3)}$$

$$P_{con} = 11.7931 P_{st} \quad (2)$$

Solving Eqs. (1) and (2) yields :

$$P_{st} = 23.45 \text{ kip}$$

$$P_{con} = 276.55 \text{ kip}$$

$$U_i = \Sigma \frac{N^2 L}{2AE} = \frac{(23.45)^2 (5)(12)}{2(6)(\pi)(0.5)^2 (29)(10^3)} + \frac{(276.55)^2 (5)(12)}{2[(\pi)(12^2) - 6\pi(0.5^2)](3.6)(10^3)}$$

$$= 1.544 \text{ in.} \cdot \text{kip} = 0.129 \text{ ft} \cdot \text{kip} \quad \text{Ans}$$

From *Mechanics of Materials*, Sixth Edition by R. C. Hibbeler, ISBN 0-13-191345-X.

© 2005 R. C. Hibbeler. Published by Pearson Prentice Hall,

Pearson Education, Inc., Upper Saddle River, NJ. All rights reserved.

This material is protected under all copyright laws as they currently exist. No portion of this material may be reproduced, in any form or by any means, without permission in writing from the publisher.

*14-16. Determine the bending strain energy in the beam and the axial strain energy in each of the two posts. All members are made of aluminum and have a square cross section 50 mm by 50 mm. Assume the posts only support an axial load. $E_{al} = 70$ GPa.

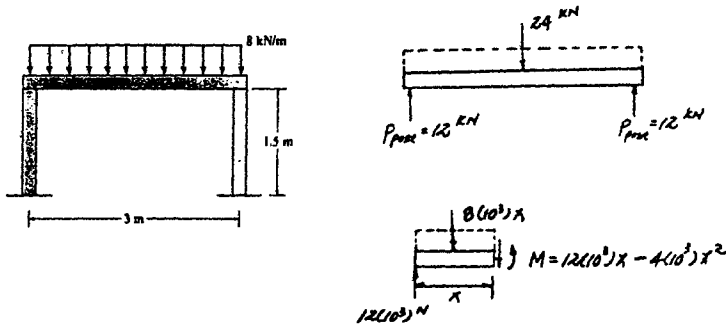

Section properties :

$$A = (0.05)(0.05) = 2.5(10^{-3})\text{m}^2$$

$$I = \frac{1}{12}(0.05)(0.05)^3 = 0.52083(10^{-6})\text{m}^4$$

Bending strain energy :

$$\begin{aligned} (U_b)_i &= \int_0^L \frac{M^2 dx}{2EI} = \frac{1}{2EI} \left[\int_0^3 (12(10^3)x - 4(10^3)x^2)^2 dx \right] \\ &= \frac{1}{2EI} \left[\int_0^3 (144(10^6)x^2 + 16(10^6)x^4 - 96(10^6)x^3) dx \right] \\ &= \frac{64.8(10^6)}{EI} = \frac{64.8(10^6)}{70(10^9)(0.52083)(10^{-6})} = 1777 \text{ J} = 1.78 \text{ kJ} \quad \text{Ans} \end{aligned}$$

Axial strain energy :

$$U_i = \int_0^L \frac{N^2 dx}{2EA} = \frac{N^2 L}{2EA} = \frac{[12(10^3)]^2 (1.5)}{2(70)(10^9)(2.5)(10^{-3})} = 0.617 \text{ J} \quad \text{Ans}$$

From *Mechanics of Materials*, Sixth Edition by R. C. Hibbeler, ISBN 0-13-191345-X.

© 2005 R. C. Hibbeler. Published by Pearson Prentice Hall,

Pearson Education, Inc., Upper Saddle River, NJ. All rights reserved.

This material is protected under all copyright laws as they currently exist. No portion of this material may be reproduced, in any form or by any means, without permission in writing from the publisher.

14–17. Determine the bending strain energy in the beam due to the distributed load. EI is constant.

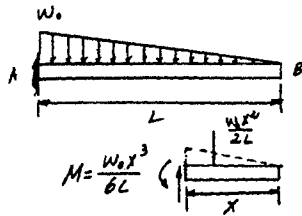
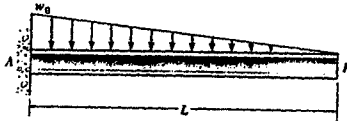

$$U_i = \int_0^L \frac{M^2 dx}{2EI} = \frac{1}{2EI} \int_0^L \left(\frac{w_0 x^3}{6L} \right)^2 dx = \frac{w_0^2 L^5}{504 EI} \quad \text{Ans}$$

From *Mechanics of Materials*, Sixth Edition by R. C. Hibbeler, ISBN 0-13-191345-X.

© 2005 R. C. Hibbeler. Published by Pearson Prentice Hall,

Pearson Education, Inc., Upper Saddle River, NJ. All rights reserved.

This material is protected under all copyright laws as they currently exist. No portion of this material may be reproduced, in any form or by any means, without permission in writing from the publisher.

14-18. The beam shown is tapered along its width. If a force P is applied to its end, determine the strain energy in the beam and compare this result with that of a beam that has a constant rectangular cross section of width b and height h .

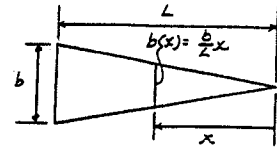

Moment of Inertia : For the beam with the uniform section,

$$I = \frac{bh^3}{12} = I_0$$

For the beam with the tapered section,

$$I = \frac{1}{12} \left(\frac{b}{L}x \right) (h^3) = \frac{bh^3}{12L}x = \frac{I_0}{L}x$$

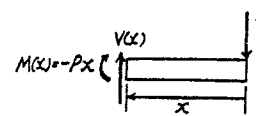
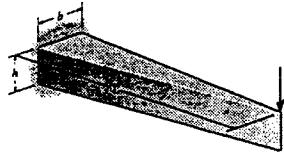

Internal Moment Function : As shown on FBD.

For the beam with the uniform section,

Bending Strain Energy : For the beam with the tapered section, applying Eq. 14-17 gives

$$\begin{aligned} U_i &= \int_0^L \frac{M^2 dx}{2EI} \\ &= \frac{1}{2E} \int_0^L \frac{(-Px)^2}{\frac{I_0}{L}x} dx \\ &= \frac{P^2 L}{2EI_0} \int_0^L x dx \\ &= \frac{P^2 L^3}{4EI_0} = \frac{3P^2 L^3}{hk^3 E} \end{aligned}$$

Ans

$$\begin{aligned} U_i &= \int_0^L \frac{M^2 dx}{2EI} \\ &= \frac{1}{2EI_0} \int_0^L (-Px)^2 dx \\ &= \frac{P^2 L^3}{6EI_0} \end{aligned}$$

The strain energy in the tapered beam is 1.5 times as great as that in the beam having a uniform cross section.

Ans

From *Mechanics of Materials*, Sixth Edition by R. C. Hibbeler, ISBN 0-13-191345-X.

© 2005 R. C. Hibbeler. Published by Pearson Prentice Hall,

Pearson Education, Inc., Upper Saddle River, NJ. All rights reserved.

This material is protected under all copyright laws as they currently exist. No portion of this material may be reproduced, in any form or by any means, without permission in writing from the publisher.

14-19 Determine the total strain energy in the steel assembly. Consider the axial strain energy in the two 0.5-in.-diameter rods and the bending strain energy in the beam, which has a moment of inertia of $I = 43.4 \text{ in}^4$ about its neutral axis. $E_{st} = 29(10^3) \text{ ksi}$.

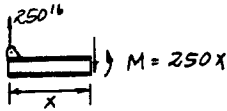
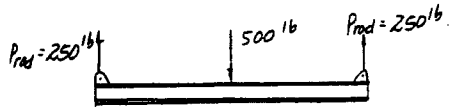
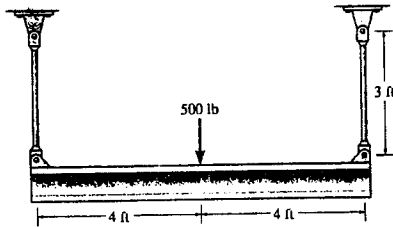

Bending strain energy :

$$(U_b)_i = \int_0^L \frac{M^2 dx}{2EI} = (2) \frac{1}{2EI} \int_0^{4(12)} (250x)^2 dx$$

$$= \frac{2.304(10^9)}{EI} = \frac{2.304(10^9)}{29(10^6)(43.4)} = 1.831 \text{ in.} \cdot \text{lb}$$

Rods strain energy :

$$(U_a)_i = \int_0^L \frac{N^2 dx}{2EA} = (2) \frac{N^2 L}{2EA} = \frac{(250)^2 (3)(12)}{29(10^6) \frac{\pi}{4} (0.5)^2} = 0.395 \text{ in.} \cdot \text{lb}$$

$$U_i = (U_b)_i + (U_a)_i = 1.831 + 0.395 = 2.23 \text{ in.} \cdot \text{lb} \quad \text{Ans}$$

From *Mechanics of Materials*, Sixth Edition by R. C. Hibbeler, ISBN 0-13-191345-X.

© 2005 R. C. Hibbeler. Published by Pearson Prentice Hall,

Pearson Education, Inc., Upper Saddle River, NJ. All rights reserved.

This material is protected under all copyright laws as they currently exist. No portion of this material may be reproduced, in any form or by any means, without permission in writing from the publisher.

*14-20 A load of 5 kN is applied to the center of the A-36 steel beam, for which $I = 4.5(10^6) \text{ mm}^4$. If the beam is supported on two springs, each having a stiffness of $k = 8 \text{ MN/m}$, determine the strain energy in each of the springs and the bending strain energy in the beam.

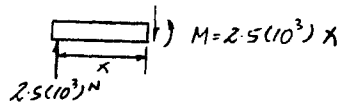
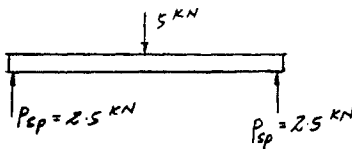
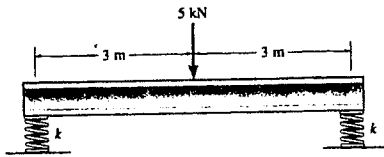

Bending strain energy :

$$(U_b)_i = \int_0^L \frac{M^2 dx}{2EI} = (2) \frac{1}{2EI} \int_0^3 (2.5(10^3)x)^2 dx$$

$$= \frac{56.25(10^6)}{EI} = \frac{56.25(10^6)}{200(10^9)(4.5)(10^{-6})} = 62.5 \text{ J} \quad \text{Ans}$$

Spring strain energy :

$$\Delta_{sp} = \frac{P_{sp}}{k} = \frac{2.5(10^3)}{8(10^6)} = 0.3125(10^{-3}) \text{ m}$$

$$(U_i)_{sp} = (U_e)_{sp} = \frac{1}{2} k \Delta_{sp}^2 = \frac{1}{2} (8)(10^6) [0.3125(10^{-3})]^2 = 0.391 \text{ J} \quad \text{Ans}$$

From *Mechanics of Materials*, Sixth Edition by R. C. Hibbeler, ISBN 0-13-191345-X.

© 2005 R. C. Hibbeler. Published by Pearson Prentice Hall,

Pearson Education, Inc., Upper Saddle River, NJ. All rights reserved.

This material is protected under all copyright laws as they currently exist. No portion of this material may be reproduced, in any form or by any means, without permission in writing from the publisher.

14-21 The pipe lies in the horizontal plane. If it is subjected to a vertical force P at its end, determine the strain energy due to bending and torsion. Express the results in terms of the cross-sectional properties I and J , and the material properties E and G .

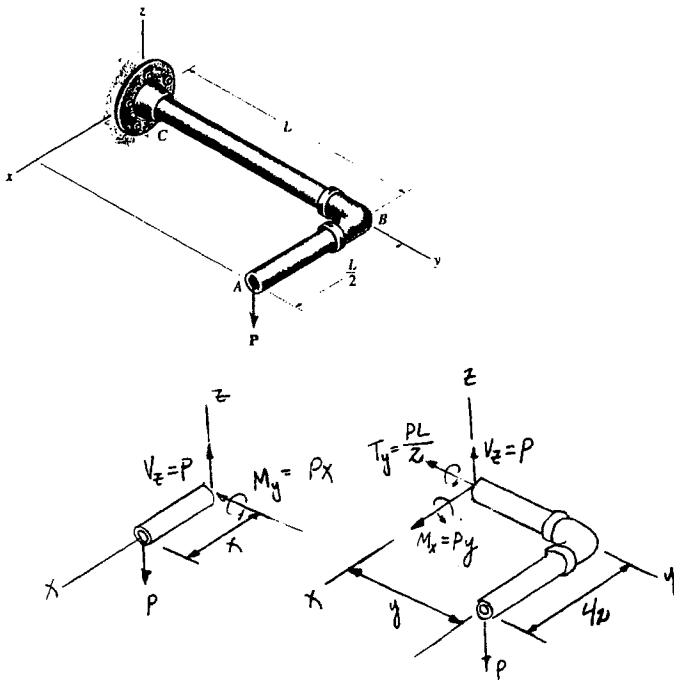

$$\begin{aligned}
 U_i &= \int \frac{M^2 dx}{2EI} + \int \frac{T^2 dx}{2JG} \\
 &= \int_0^{L/2} \frac{(Px)^2 dx}{2EI} + \int_0^L \frac{(Px)^2 dx}{2EI} + \int_0^L \frac{(\frac{PL}{2})^2 dx}{2JG} \\
 &= \frac{P^2}{2EI} \left(\frac{L}{2}\right)^3 \frac{1}{3} + \frac{P^2}{2EI} \frac{L^3}{3} + \frac{P^2 L^2}{8JG} (L) \\
 &= \frac{9P^2 L^3}{48EI} + \frac{P^2 L^3}{8JG} \\
 &= P^2 L^3 \left[\frac{9}{48EI} + \frac{1}{8JG} \right] \quad \text{Ans}
 \end{aligned}$$

From *Mechanics of Materials*, Sixth Edition by R. C. Hibbeler, ISBN 0-13-191345-X.

© 2005 R. C. Hibbeler. Published by Pearson Prentice Hall,

Pearson Education, Inc., Upper Saddle River, NJ. All rights reserved.

This material is protected under all copyright laws as they currently exist. No portion of this material may be reproduced, in any form or by any means, without permission in writing from the publisher.

14-22 Determine the strain energy in the horizontal curved bar due to torsion. There is a vertical force P acting at its end. JG is constant.

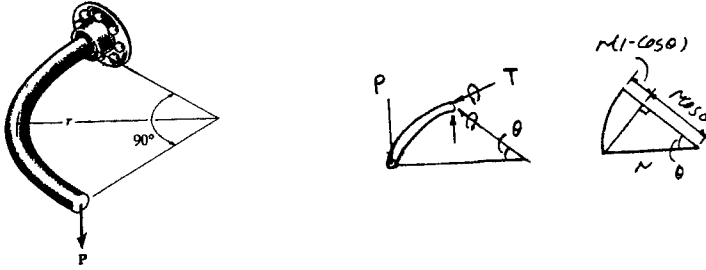

$$T = Pr(1 - \cos \theta)$$

Strain energy :

$$U_i = \int_0^L \frac{T^2 ds}{2JG}$$

However,

$$s = r\theta; \quad ds = r d\theta$$

$$\begin{aligned} U_i &= \int_0^{\pi/2} \frac{T^2 r d\theta}{2JG} = \frac{r}{2JG} \int_0^{\pi/2} [Pr(1 - \cos \theta)]^2 d\theta \\ &= \frac{P^2 r^3}{2JG} \int_0^{\pi/2} (1 - \cos \theta)^2 d\theta \\ &= \frac{P^2 r^3}{2JG} \int_0^{\pi/2} (1 + \cos^2 \theta - 2\cos \theta) d\theta \\ &= \frac{P^2 r^3}{2JG} \int_0^{\pi/2} \left(1 + \frac{\cos 2\theta + 1}{2} - 2\cos \theta\right) d\theta \\ &= \frac{P^2 r^3}{JG} \left(\frac{3\pi}{8} - 1\right) \quad \text{Ans} \end{aligned}$$

From *Mechanics of Materials*, Sixth Edition by R. C. Hibbeler, ISBN 0-13-191345-X.

© 2005 R. C. Hibbeler. Published by Pearson Prentice Hall,

Pearson Education, Inc., Upper Saddle River, NJ. All rights reserved.

This material is protected under all copyright laws as they currently exist. No portion of this material may be reproduced, in any form or by any means, without permission in writing from the publisher.

14-23 Consider the thin-walled tube of Fig. 5-30. Use the formula for shear stress, $\tau_{avg} = T/2A_m$, Eq. 5-18, and the general equation of shear strain energy, Eq. 14-11, to show that the twist of the tube is given by Eq. 5-20. *Hint:* Equate the work done by the torque T to the strain energy in the tube, determined from integrating the strain energy for a differential element, Fig. 14-4, over the volume of material.

$$U_i = \int_V \frac{\tau^2 dV}{2G} \quad \text{but } \tau = \frac{T}{2tA_m}$$

Thus,

$$\begin{aligned} U_i &= \int_V \frac{T^2}{8t^2 A_m^2 G} dV \\ &= \frac{T^2}{8A_m^2 G} \int_V \frac{dV}{t^2} = \frac{T^2}{8A_m^2 G} \int_A \frac{dV}{t^2} \int_0^L dx = \frac{T^2 L}{8A_m^2 G} \int_A \frac{dA}{t^2} \end{aligned}$$

However, $dA = t ds$. Thus,

$$U_i = \frac{T^2 L}{8A_m^2 G} \int \frac{ds}{t}$$

$$U_e = \frac{1}{2} T \phi$$

$$U_e = U_i$$

$$\frac{1}{2} T \phi = \frac{T^2 L}{8A_m^2 G} \int \frac{ds}{t}$$

$$\phi = \frac{TL}{4A_m^2 G} \int \frac{ds}{t} \quad \mathbf{QED}$$

From *Mechanics of Materials*, Sixth Edition by R. C. Hibbeler, ISBN 0-13-191345-X.

© 2005 R. C. Hibbeler. Published by Pearson Prentice Hall,

Pearson Education, Inc., Upper Saddle River, NJ. All rights reserved.

This material is protected under all copyright laws as they currently exist. No portion of this material may be reproduced, in any form or by any means, without permission in writing from the publisher.

***14-24.** Determine the vertical displacement of joint C . AE is constant.

Joint C :

$$\begin{aligned} \rightarrow \Sigma F_x = 0 \quad F_{CB} \cos 30^\circ - F_{CA} \cos 30^\circ = 0 \\ F_{CB} = F_{CA} \end{aligned}$$

$$\begin{aligned} + \uparrow \Sigma F_y = 0 \quad F_{CA} \sin 30^\circ + F_{CB} \sin 30^\circ - P = 0 \\ F_{CB} = F_{CA} = P \end{aligned}$$

Conservation of energy:

$$U_e = U_i$$

$$\frac{1}{2} P \Delta_C = \Sigma \frac{N^2 L}{2EA}$$

$$\frac{1}{2} P \Delta_C = \frac{L}{2EA} [F_{CB}^2 + F_{CA}^2]$$

$$P \Delta_C = \frac{L}{EA} (P^2 + P^2)$$

$$\Delta_C = \frac{2PL}{AE} \quad \text{Ans}$$

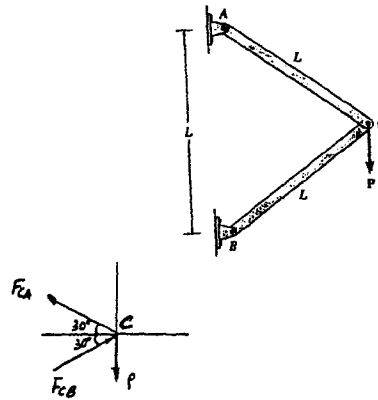

From *Mechanics of Materials*, Sixth Edition by R. C. Hibbeler, ISBN 0-13-191345-X.
 © 2005 R. C. Hibbeler. Published by Pearson Prentice Hall,
 Pearson Education, Inc., Upper Saddle River, NJ. All rights reserved.
 This material is protected under all copyright laws as they currently exist. No portion of this material may be reproduced, in any form or by any means, without permission in writing from the publisher.

14-25. Determine the horizontal displacement of joint D .
 AE is constant.

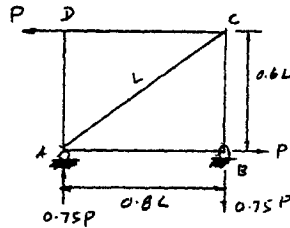
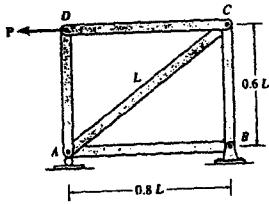

Joint B :

$$+\uparrow \Sigma F_y = 0; \quad F_{BC} = 0.75P$$

$$\leftarrow \Sigma F_x = 0; \quad F_{BA} = P$$

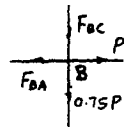

Joint D :

$$+\downarrow \Sigma F_y = 0; \quad F_{DA} = 0$$

$$\rightarrow \Sigma F_x = 0; \quad F_{DC} = P$$

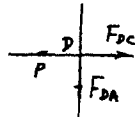

Joint A :

$$+\downarrow \Sigma F_y = 0; \quad \frac{3}{5}F_{AC} - 0.75P = 0$$

$$F_{AC} = 1.25P$$

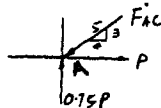

Conservation of energy :

$$U_e = U_i$$

$$\frac{1}{2}P\Delta_D = \Sigma \frac{N^2L}{2AE}$$

$$\frac{1}{2}P\Delta_D = \frac{1}{2AE} [(0.75P)^2(0.6L) + (P)^2(0.8L) + (0)^2(0.6L) + (P^2)(0.8L) + (1.25P)^2(L)]$$

$$\Delta_D = \frac{3.50PL}{AE} \quad \text{Ans}$$

From *Mechanics of Materials*, Sixth Edition by R. C. Hibbeler, ISBN 0-13-191345-X.

© 2005 R. C. Hibbeler. Published by Pearson Prentice Hall,

Pearson Education, Inc., Upper Saddle River, NJ. All rights reserved.

This material is protected under all copyright laws as they currently exist. No portion of this material may be reproduced, in any form or by any means, without permission in writing from the publisher.

14-26 The cantilevered beam is subjected to a couple moment M_0 applied at its end. Determine the slope of the beam at B . EI is constant.

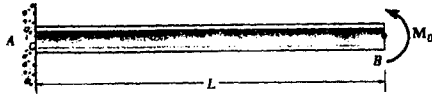

$$M = M_0 \quad \left(\begin{array}{c} \text{---} \\ \text{---} \end{array} \right) M_0$$

x

$$U_i = \int_0^L \frac{M^2 dx}{2EI} = \frac{1}{2EI} \int_0^L M_0^2 dx = \frac{M_0^2 L}{2EI}$$

$$U_e = \frac{1}{2} (M_0 \theta_B)$$

Conservation of energy :

$$U_e = U_i$$

$$\frac{1}{2} M_0 \theta_B = \frac{M_0^2 L}{2EI}$$

$$\theta_B = \frac{M_0 L}{EI} \quad \text{Ans}$$

From *Mechanics of Materials*, Sixth Edition by R. C. Hibbeler, ISBN 0-13-191345-X.

© 2005 R. C. Hibbeler. Published by Pearson Prentice Hall,

Pearson Education, Inc., Upper Saddle River, NJ. All rights reserved.

This material is protected under all copyright laws as they currently exist. No portion of this material may be reproduced, in any form or by any means, without permission in writing from the publisher.

14-27 Determine the slope at the end B of the A-36 steel beam. $I = 80(10^6) \text{ mm}^4$.

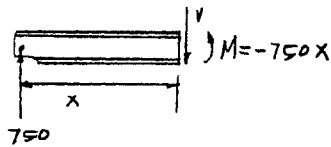
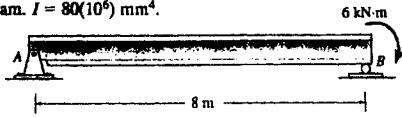

$$M = -750x$$

$$\frac{1}{2} M \theta_B = \int_0^L \frac{M^2 dx}{2EI}$$

$$\frac{1}{2} (6(10^3)) \theta_B = \int_0^8 \frac{(-750x)^2 dx}{2EI}$$

$$\theta_B = \frac{16000}{200(10^9)(80)(10^{-6})} = 1(10^{-3}) \text{ rad} \quad \mathbf{Ans}$$

From *Mechanics of Materials*, Sixth Edition by R. C. Hibbeler, ISBN 0-13-191345-X.

© 2005 R. C. Hibbeler. Published by Pearson Prentice Hall,

Pearson Education, Inc., Upper Saddle River, NJ. All rights reserved.

This material is protected under all copyright laws as they currently exist. No portion of this material may be reproduced, in any form or by any means, without permission in writing from the publisher.

*14-28 Determine the displacement of point B on the A-36 steel beam. $I = 250 \text{ in}^4$.

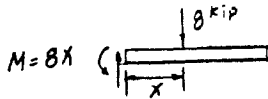
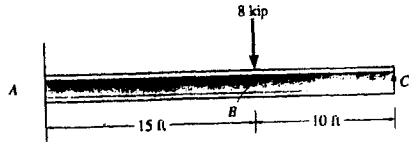

$$U_i = \int_0^L \frac{M^2 dx}{2EI} = \frac{1}{2EI} \int_0^{15(12)} (8x)^2 dx = \frac{62208000}{EI}$$

$$U_e = \frac{1}{2} P \Delta_B = \frac{1}{2} (8) \Delta_B = 4 \Delta_B$$

Conservation of energy :

$$U_e = U_i$$

$$4 \Delta_B = \frac{62208000}{EI}$$

$$\Delta_B = \frac{15552000}{EI} = \frac{15552000}{29(10^3)(250)} = 2.15 \text{ in.} \quad \text{Ans}$$

From *Mechanics of Materials*, Sixth Edition by R. C. Hibbeler, ISBN 0-13-191345-X.

© 2005 R. C. Hibbeler. Published by Pearson Prentice Hall,

Pearson Education, Inc., Upper Saddle River, NJ. All rights reserved.

This material is protected under all copyright laws as they currently exist. No portion of this material may be reproduced, in any form or by any means, without permission in writing from the publisher.

14-29. Determine the displacement of point B on the A-36 steel beam. $I = 80(10^6) \text{ mm}^4$.

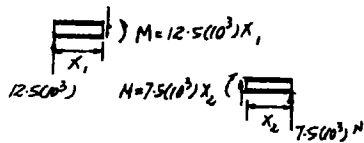
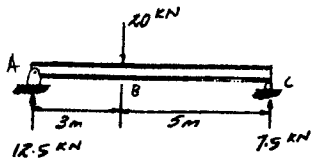
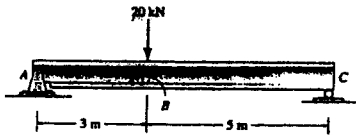

$$U_i = \int_0^L \frac{M^2 dx}{2EI} = \frac{1}{2EI} \left[\int_0^3 [(12.5)(10^3)(x_1)]^2 dx_1 + \int_0^5 [(7.5)(10^3)(x_2)]^2 dx_2 \right] = \frac{1.875(10^9)}{EI}$$

$$U_e = \frac{1}{2} P \Delta = \frac{1}{2} (20)(10^3) \Delta_B = 10(10^3) \Delta_B$$

Conservation of energy :

$$U_e = U_i$$

$$10(10^3) \Delta_B = \frac{1.875(10^9)}{EI}$$

$$\Delta_B = \frac{187500}{EI} = \frac{187500}{200(10^9)(80)(10^{-6})} = 0.0117 \text{ m} = 11.7 \text{ mm} \quad \text{Ans}$$

From *Mechanics of Materials*, Sixth Edition by R. C. Hibbeler, ISBN 0-13-191345-X.

© 2005 R. C. Hibbeler. Published by Pearson Prentice Hall,

Pearson Education, Inc., Upper Saddle River, NJ. All rights reserved.

This material is protected under all copyright laws as they currently exist. No portion of this material may be reproduced, in any form or by any means, without permission in writing from the publisher.

14-30 Use the method of work and energy and determine the slope of the beam at point B in Prob. 14-7. EI is constant.

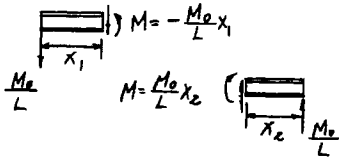
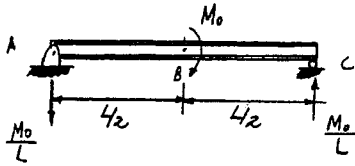
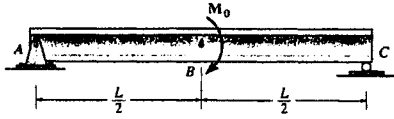

$$U_i = \int_0^L \frac{M^2 dx}{2EI} = \frac{1}{2EI} \left[\int_0^{L/2} \left(-\frac{M_0}{L} x_1 \right)^2 dx_1 + \int_0^{L/2} \left(\frac{M_0}{L} x_2 \right)^2 dx_2 \right]$$

$$= \frac{M_0^2 L}{24EI}$$

$$U_e = \frac{1}{2} M \theta = \frac{1}{2} M_0 \theta_B$$

Conservation of energy :

$$U_e = U_i$$

$$\frac{1}{2} M_0 \theta_B = \frac{M_0^2 L}{24EI}$$

$$\theta_B = \frac{M_0 L}{12EI} \quad \text{Ans}$$

From *Mechanics of Materials*, Sixth Edition by R. C. Hibbeler, ISBN 0-13-191345-X.

© 2005 R. C. Hibbeler. Published by Pearson Prentice Hall,

Pearson Education, Inc., Upper Saddle River, NJ. All rights reserved.

This material is protected under all copyright laws as they currently exist. No portion of this material may be reproduced, in any form or by any means, without permission in writing from the publisher.

14-31 Determine the slope at point A of the beam. EI is constant.

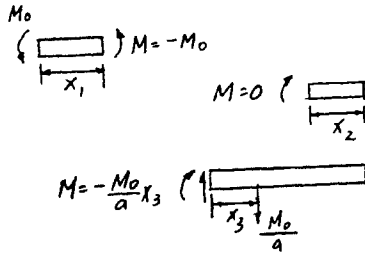
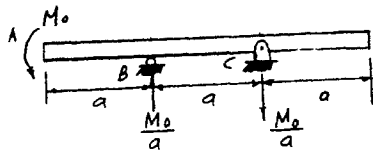
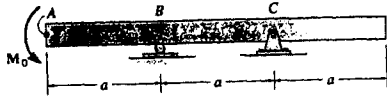

$$U_i = \int_0^L \frac{M^2 dx}{2EI} = \frac{1}{2EI} \left[\int_0^a (-M_0)^2 dx_1 + \int_0^a (0)^2 dx_2 + \int_0^a \left(-\frac{M_0}{a} x_3\right)^2 dx_3 \right]$$

$$= \frac{2M_0^2 a}{3EI}$$

$$U_e = \frac{1}{2} M \theta = \frac{1}{2} M_0 \theta_A$$

Conservation of energy :

$$U_e = U_i$$

$$\frac{1}{2} M_0 \theta_A = \frac{2M_0^2 a}{3EI}$$

$$\theta_A = \frac{4M_0 a}{3EI} \quad \text{Ans}$$

From *Mechanics of Materials*, Sixth Edition by R. C. Hibbeler, ISBN 0-13-191345-X.

© 2005 R. C. Hibbeler. Published by Pearson Prentice Hall,

Pearson Education, Inc., Upper Saddle River, NJ. All rights reserved.

This material is protected under all copyright laws as they currently exist. No portion of this material may be reproduced, in any form or by any means, without permission in writing from the publisher.

***14-32.** Determine the slope at point C of the A-36 steel beam. $I = 9.50(10^6) \text{ mm}^4$.

Support Reactions : As shown on FBD(a).

Moment Functions : As shown on FBD(b) and (c).

Bending Strain Energy : Applying 14–17, we have

$$\begin{aligned}
 U_i &= \int_0^L \frac{M^2 dx}{2EI} \\
 &= \frac{1}{2EI} \left[\int_0^{4m} (-3.00x_1)^2 dx_1 + \int_0^{4m} (-12.0)^2 dx_2 \right] \\
 &= \frac{384 \text{ kN}^2 \cdot \text{m}^3}{EI} \\
 &= \frac{384(10^6)}{200(10^9)[9.50(10^6)]} = 202.11 \text{ N} \cdot \text{m}
 \end{aligned}$$

External Work : The external work done by 12 kN · m couple moment is

$$U_e = \frac{1}{2} [12(10^3)] (\theta_C) = 6.00(10^3) \theta_C$$

Conservation of Energy :

$$\begin{aligned}
 U_e &= U_i \\
 6.00(10^3) \theta_C &= 202.11
 \end{aligned}$$

$$\theta_C = 0.0337 \text{ rad} \approx 1.93^\circ \quad \text{Ans}$$

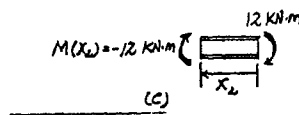
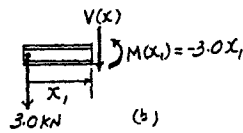
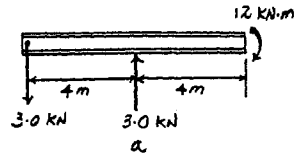

From *Mechanics of Materials*, Sixth Edition by R. C. Hibbeler, ISBN 0-13-191345-X.
 © 2005 R. C. Hibbeler. Published by Pearson Prentice Hall,
 Pearson Education, Inc., Upper Saddle River, NJ. All rights reserved.
 This material is protected under all copyright laws as they currently exist. No portion of this material may be reproduced, in any form or by any means, without permission in writing from the publisher.

14-33 The A-36 steel bars are pin connected at C. If they each have a diameter of 2 in., determine the displacement at E.

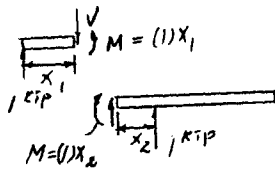
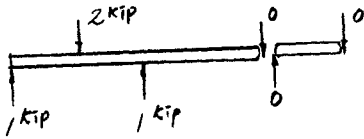
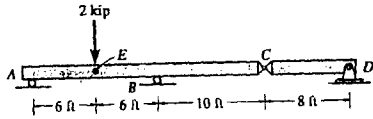

$$U_i = \int_0^L \frac{M^2 dx}{2EI} = (2) \frac{1}{2EI} \int_0^{6(12)} (x_1)^2 dx_1 = \frac{124416}{EI}$$

$$U_e = \frac{1}{2} P \Delta = \frac{1}{2} (2) \Delta_E = \Delta_E$$

Conservation of energy :

$$U_e = U_i$$

$$\Delta_E = \frac{124416}{EI} = \frac{124416}{29(10^3)(\frac{\pi}{4})(1^4)} = 5.46 \text{ in.} \quad \text{Ans}$$

From *Mechanics of Materials*, Sixth Edition by R. C. Hibbeler, ISBN 0-13-191345-X.

© 2005 R. C. Hibbeler. Published by Pearson Prentice Hall,

Pearson Education, Inc., Upper Saddle River, NJ. All rights reserved.

This material is protected under all copyright laws as they currently exist. No portion of this material may be reproduced, in any form or by any means, without permission in writing from the publisher.

14-34 The A-36 steel bars are pin connected at C and D. If they each have the same rectangular cross section, with a height of 200 mm and a width of 100 mm, determine the vertical displacement at B. Neglect the axial load in the bars.

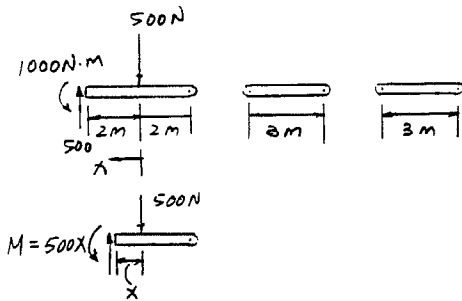
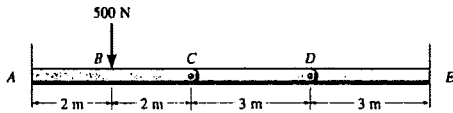

Internal strain energy :

$$U_i = \int_0^L \frac{M^2 dx}{2EI} = \frac{1}{2EI} \int_0^{2\text{ m}} [500x]^2 dx = \frac{0.3333 (10^6)}{EI}$$

External work :

$$U_e = \frac{1}{2} P \Delta_B = \frac{1}{2} (500) \Delta_B = 250 \Delta_B$$

Conservation of energy :

$$U_e = U_i$$

$$250 \Delta_B = \frac{0.3333 (10^6)}{EI}$$

$$\Delta_B = \frac{1333.33}{EI} = \frac{1333.33}{200 (10^9) \left(\frac{1}{12}\right) (0.1) (0.2^3)}$$

$$= 0.1 (10^{-3}) \text{ m} = 0.100 \text{ mm} \quad \text{Ans}$$

From *Mechanics of Materials*, Sixth Edition by R. C. Hibbeler, ISBN 0-13-191345-X.

© 2005 R. C. Hibbeler. Published by Pearson Prentice Hall,

Pearson Education, Inc., Upper Saddle River, NJ. All rights reserved.

This material is protected under all copyright laws as they currently exist. No portion of this material may be reproduced, in any form or by any means, without permission in writing from the publisher.

14-35 The A-36 steel bars are pin connected at *B* and *C*. If they each have a diameter of 30 mm, determine the slope at *E*.

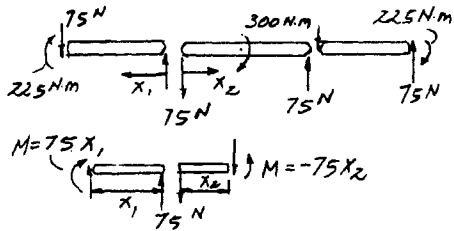
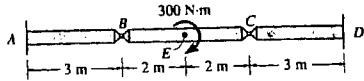

$$U_i = \int_0^L \frac{M^2 dx}{2EI} = (2) \frac{1}{2EI} \int_0^3 (75x_1)^2 dx_1 + (2) \frac{1}{2EI} \int_0^2 (-75x_2)^2 dx_2 = \frac{65625}{EI}$$

$$U_e = \frac{1}{2}(M)\theta = \frac{1}{2}(300)\theta_E = 150\theta_E$$

Conservation of energy :

$$U_e = U_i$$

$$150\theta_E = \frac{65625}{EI}$$

$$\theta_E = \frac{473.5}{EI} = \frac{473.5}{(200)(10^9)(\frac{\pi}{4})(0.015^4)} = 0.0550 \text{ rad} = 3.15^\circ \quad \text{Ans}$$

From *Mechanics of Materials*, Sixth Edition by R. C. Hibbeler, ISBN 0-13-191345-X.

© 2005 R. C. Hibbeler. Published by Pearson Prentice Hall,

Pearson Education, Inc., Upper Saddle River, NJ. All rights reserved.

This material is protected under all copyright laws as they currently exist. No portion of this material may be reproduced, in any form or by any means, without permission in writing from the publisher.

***14-36.** The rod has a circular cross section with a moment of inertia I . If a vertical force P is applied at A , determine the vertical displacement at this point. Only consider the strain energy due to bending. The modulus of elasticity is E .

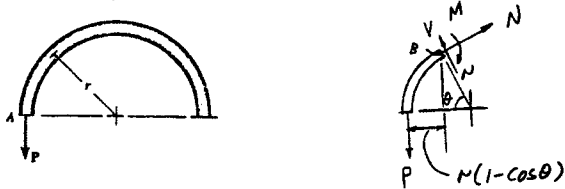

Moment function :

$$(\sum M_B = 0; \quad P[r(1 - \cos \theta)] - M = 0; \quad M = P r (1 - \cos \theta)$$

Bending strain energy :

$$\begin{aligned} U_i &= \int_0^s \frac{M^2 ds}{2EI} \quad ds = r d\theta \\ &= \int_0^\pi \frac{M^2 r d\theta}{2EI} = \frac{r}{2EI} \int_0^\pi [P r (1 - \cos \theta)]^2 d\theta \\ &= \frac{P^2 r^3}{2EI} \int_0^\pi (1 + \cos^2 \theta - 2\cos \theta) d\theta \\ &= \frac{P^2 r^3}{2EI} \int_0^\pi \left(1 + \frac{1}{2} + \frac{\cos 2\theta}{2} - 2\cos \theta\right) d\theta \\ &= \frac{P^2 r^3}{2EI} \int_0^\pi \left(\frac{3}{2} + \frac{\cos 2\theta}{2} - 2\cos \theta\right) d\theta = \frac{P^2 r^3}{2EI} \left(\frac{3}{2}\pi\right) = \frac{3\pi P^2 r^3}{4EI} \end{aligned}$$

Conservation of energy :

$$U_e = U_i; \quad \frac{1}{2} P \Delta_A = \frac{3\pi P^2 r^3}{4EI}$$

$$\Delta_A = \frac{3\pi P r^3}{2EI} \quad \text{Ans}$$

From *Mechanics of Materials*, Sixth Edition by R. C. Hibbeler, ISBN 0-13-191345-X.

© 2005 R. C. Hibbeler. Published by Pearson Prentice Hall,

Pearson Education, Inc., Upper Saddle River, NJ. All rights reserved.

This material is protected under all copyright laws as they currently exist. No portion of this material may be reproduced, in any form or by any means, without permission in writing from the publisher.

14-37 The rod has a circular cross section with a polar moment of inertia J and moment of inertia I . If a vertical force P is applied at A , determine the vertical displacement at this point. Consider the strain energy due to bending and torsion. The material constants are E and G .

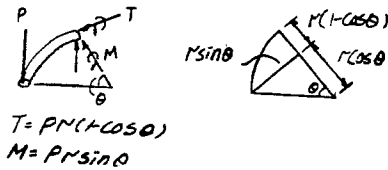
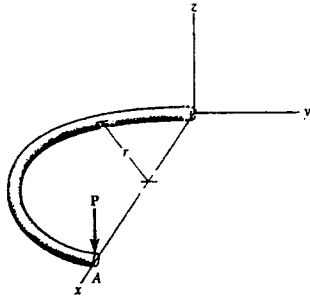

$$T = Pr(1 - \cos \theta); \quad M = Pr \sin \theta$$

Torsion strain energy :

$$\begin{aligned}
 U_i &= \int_0^s \frac{T^2 ds}{2GJ} = \int_0^\theta \frac{T^2 r d\theta}{2GJ} \\
 &= \frac{r}{2GJ} \int_0^\pi [Pr(1 - \cos \theta)]^2 d\theta \\
 &= \frac{P^2 r^3}{2GJ} \int_0^\pi (1 + \cos^2 \theta - 2\cos \theta) d\theta \\
 &= \frac{P^2 r^3}{2GJ} \int_0^\pi \left(1 + \frac{\cos 2\theta + 1}{2} - 2\cos \theta\right) d\theta \\
 &= \frac{3P^2 r^3 \pi}{4GJ}
 \end{aligned}$$

Bending strain energy :

$$\begin{aligned}
 U_i &= \int_0^s \frac{M^2 ds}{2EI} \\
 &= \int_0^\theta \frac{M^2 r d\theta}{2EI} = \frac{r}{2EI} \int_0^\pi [Pr \sin \theta]^2 d\theta \\
 &= \frac{P^2 r^3}{2EI} \int_0^\pi \left(\frac{1 - \cos 2\theta}{2}\right) d\theta = \frac{P^2 r^3 \pi}{4EI}
 \end{aligned}$$

Conservation of energy :

$$U_c = U_i$$

$$\frac{1}{2} P \Delta = \frac{3P^2 r^3 \pi}{4GJ} + \frac{P^2 r^3 \pi}{4EI}$$

$$\Delta = \frac{Pr^3 \pi}{2} \left(\frac{3}{GJ} + \frac{1}{EI} \right) \quad \text{Ans}$$

From *Mechanics of Materials*, Sixth Edition by R. C. Hibbeler, ISBN 0-13-191345-X.

© 2005 R. C. Hibbeler. Published by Pearson Prentice Hall,

Pearson Education, Inc., Upper Saddle River, NJ. All rights reserved.

This material is protected under all copyright laws as they currently exist. No portion of this material may be reproduced, in any form or by any means, without permission in writing from the publisher.

14-38 The load P causes the open coils of the spring to make an angle θ with the horizontal when the spring is stretched. Show that for this position this causes a torque $T = PR \cos \theta$ and a bending moment $M = PR \sin \theta$ at the cross section. Use these results to determine the maximum normal stress in the material.

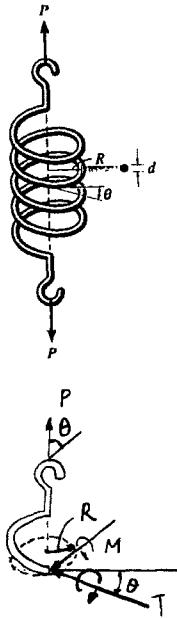

$$T = PR \cos \theta; \quad M = PR \sin \theta$$

Bending :

$$\sigma_{\max} = \frac{Mc}{I} = \frac{PR \sin \theta d}{2 \left(\frac{\pi}{4}\right) \left(\frac{d^4}{16}\right)}$$

$$\tau_{\max} = \frac{Tc}{J} = \frac{PR \cos \theta \frac{d}{2}}{\frac{\pi}{2} \left(\frac{d^4}{16}\right)}$$

$$\begin{aligned} \sigma_{\max} &= \frac{\sigma_x + \sigma_y}{2} + \sqrt{\left(\frac{\sigma_x - \sigma_y}{2}\right)^2 + \tau_{xy}^2} \\ &= \frac{16 PR \sin \theta}{\pi d^3} + \sqrt{\left(\frac{16 PR \sin \theta}{\pi d^3}\right)^2 + \left(\frac{16 PR \cos \theta}{\pi d^3}\right)^2} \\ &= \frac{16 PR}{\pi d^3} [\sin \theta + 1] \quad \text{Ans} \end{aligned}$$

From *Mechanics of Materials*, Sixth Edition by R. C. Hibbeler, ISBN 0-13-191345-X.

© 2005 R. C. Hibbeler. Published by Pearson Prentice Hall,

Pearson Education, Inc., Upper Saddle River, NJ. All rights reserved.

This material is protected under all copyright laws as they currently exist. No portion of this material may be reproduced, in any form or by any means, without permission in writing from the publisher.

14-39. The coiled spring has n coils and is made from a material having a shear modulus G . Determine the stretch of the spring when it is subjected to the load P . Assume that the coils are close to each other so that $\theta \approx 0^\circ$ and the deflection is caused entirely by the torsional stress in the coil.

Bending Strain Energy : Applying 14-22, we have

$$U_i = \frac{T^2 L}{2GJ} = \frac{P^2 R^2 L}{2G \left[\frac{\pi}{32} (d^4) \right]} = \frac{16P^2 R^2 L}{\pi d^4 G}$$

However, $L = n(2\pi R) = 2n\pi R$. Then

$$U_i = \frac{32n P^2 R^3}{d^4 G}$$

External Work : The external work done by force P is

$$U_e = \frac{1}{2} P \Delta$$

Conservation of Energy :

$$U_e = U_i$$

$$\frac{1}{2} P \Delta = \frac{32n P^2 R^3}{d^4 G}$$

$$\Delta = \frac{64n P R^3}{d^4 G}$$

Ans

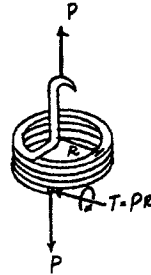
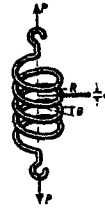

From *Mechanics of Materials*, Sixth Edition by R. C. Hibbeler, ISBN 0-13-191345-X.
 © 2005 R. C. Hibbeler. Published by Pearson Prentice Hall,
 Pearson Education, Inc., Upper Saddle River, NJ. All rights reserved.
 This material is protected under all copyright laws as they currently exist. No portion of this material may be reproduced, in any form or by any means, without permission in writing from the publisher.

***14-40** A bar is 4 m long and has a diameter of 30 mm. If it is to be used to absorb energy in tension from an impact loading, determine the total amount of elastic energy that it can absorb if (a) it is made of steel for which $E_{st} = 200 \text{ GPa}$, $\sigma_Y = 800 \text{ MPa}$, and (b) it is made from an aluminum alloy for which $E_{al} = 70 \text{ GPa}$, $\sigma_Y = 405 \text{ MPa}$.

$$a) \quad \epsilon_Y = \frac{\sigma_Y}{E} = \frac{800(10^6)}{200(10^9)} = 4(10^{-3}) \text{ m/m}$$

$$u_r = \frac{1}{2}(\sigma_Y)(\epsilon_Y) = \frac{1}{2}(800)(10^6)(\text{N/m}^2)(4)(10^{-3})\text{m/m} = 1.6 \text{ MJ/m}^3$$

$$V = \frac{\pi}{4}(0.03)^2(4) = 0.9(10^{-3})\pi \text{ m}^3$$

$$u_i = 1.6(10^6)(0.9)(10^{-3})\pi = 4.52 \text{ kJ} \quad \text{Ans}$$

b)

$$\epsilon_Y = \frac{\sigma_Y}{E} = \frac{405(10^6)}{70(10^9)} = 5.786(10^{-3}) \text{ m/m}$$

$$u_r = \frac{1}{2}(\sigma_Y)(\epsilon_Y) = \frac{1}{2}(405)(10^6)(\text{N/m}^2)(5.786)(10^{-3})\text{m/m} = 1.172 \text{ MJ/m}^3$$

$$V = \frac{\pi}{4}(0.03)^2(4) = 0.9(10^{-3})\pi \text{ m}^3$$

$$u_i = 1.172(10^6)(0.9)(10^{-3})\pi = 3.31 \text{ kJ} \quad \text{Ans}$$

From *Mechanics of Materials*, Sixth Edition by R. C. Hibbeler, ISBN 0-13-191345-X.

© 2005 R. C. Hibbeler. Published by Pearson Prentice Hall,

Pearson Education, Inc., Upper Saddle River, NJ. All rights reserved.

This material is protected under all copyright laws as they currently exist. No portion of this material may be reproduced, in any form or by any means, without permission in writing from the publisher.

14-41 Determine the diameter of a red brass C83400 bar that is 8 ft long if it is to be used to absorb 800 ft · lb of energy in tension from an impact loading.

$$\epsilon_y = \frac{\sigma_y}{E} = \frac{10}{14.6 (10^3)} = 0.68493 (10^{-3}) \text{ in./in.}$$

$$\begin{aligned} u_r &= \frac{1}{2} \sigma_y \epsilon_y = \frac{1}{2} (10)(10^3) \frac{\text{lb}}{\text{in}^2} (0.68493)(10^{-3}) \text{ in./in.} \\ &= 3.4247 \frac{\text{in.} \cdot \text{lb}}{\text{in}^3} \end{aligned}$$

$$V = \frac{\pi}{4} (d^2)(8)(12) = 75.398 d^2$$

$$800(12) = 3.4247 (75.398 d^2)$$

$$d = 6.10 \text{ in.} \quad \text{Ans}$$

From *Mechanics of Materials*, Sixth Edition by R. C. Hibbeler, ISBN 0-13-191345-X.

© 2005 R. C. Hibbeler. Published by Pearson Prentice Hall,

Pearson Education, Inc., Upper Saddle River, NJ. All rights reserved.

This material is protected under all copyright laws as they currently exist. No portion of this material may be reproduced, in any form or by any means, without permission in writing from the publisher.

14-42 The collar has a weight of 50 lb and falls down the titanium bar. If the bar has a diameter of 0.5 in, determine the maximum stress developed in the bar if the weight is (a) dropped from a height of $h = 1$ ft, (b) released from a height $h \approx 0$, and (c) placed slowly on the flange at A. $E_{Ti} = 16(10^3)$ ksi, $\sigma_Y = 60$ ksi.

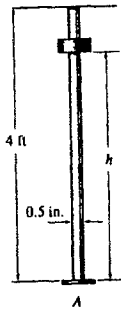

a)

$$\Delta_{st} = \frac{WL}{AE} = \frac{50(4)(12)}{\frac{\pi}{4}(0.5)^2(16)(10^6)} = 0.7639(10^{-3}) \text{ in.}$$

$$P_{max} = W \left[1 + \sqrt{1 + 2 \left(\frac{h}{\Delta_{st}} \right)} \right] = 50 \left[1 + \sqrt{1 + 2 \left(\frac{(1)(12)}{0.7639(10^{-3})} \right)} \right] = 8912 \text{ lb}$$

$$\sigma_{max} = \frac{P_{max}}{A} = \frac{8912}{\frac{\pi}{4}(0.5)^2} = 45390 \text{ psi} = 45.4 \text{ ksi} < \sigma_Y \quad \text{Ans}$$

b)

$$P_{max} = W \left[1 + \sqrt{1 + 2 \left(\frac{h}{\Delta_{st}} \right)} \right] = 50 \left[1 + \sqrt{1 + 2(0)} \right] = 100 \text{ lb}$$

$$\sigma_{max} = \frac{P_{max}}{A} = \frac{100}{\frac{\pi}{4}(0.5)^2} = 509 \text{ psi} < \sigma_Y \quad \text{Ans}$$

c)

$$\sigma_{max} = \frac{W}{A} = \frac{50}{\frac{\pi}{4}(0.5)^2} = 254 \text{ psi} < \sigma_Y \quad \text{Ans}$$

From *Mechanics of Materials*, Sixth Edition by R. C. Hibbeler, ISBN 0-13-191345-X.

© 2005 R. C. Hibbeler. Published by Pearson Prentice Hall,

Pearson Education, Inc., Upper Saddle River, NJ. All rights reserved.

This material is protected under all copyright laws as they currently exist. No portion of this material may be reproduced, in any form or by any means, without permission in writing from the publisher.

14-43 The collar has a weight of 50 lb and falls down the titanium bar. If the bar has a diameter of 0.5 in., determine the largest height h at which the weight can be released and not permanently damage the bar after striking the flange at A . $E_t = 16(10^3)$ ksi, $\sigma_Y = 60$ ksi.

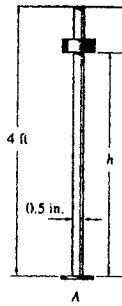

$$\Delta_{st} = \frac{WL}{AE} = \frac{50(4)(12)}{\frac{\pi}{4}(0.5)^2(16)(10^6)} = 0.7639(10^{-3}) \text{ in.}$$

$$P_{max} = W \left[1 + \sqrt{1 + 2\left(\frac{h}{\Delta_{st}}\right)} \right]$$

$$60(10^3)\left(\frac{\pi}{4}\right)(0.5^2) = 50 \left[1 + \sqrt{1 + 2\left(\frac{h}{0.7639(10^{-3})}\right)} \right]$$

$$235.62 = 1 + \sqrt{1 + 2618h}$$

$$h = 21.02 \text{ in.} = 1.75 \text{ ft} \quad \mathbf{Ans}$$

From *Mechanics of Materials*, Sixth Edition by R. C. Hibbeler, ISBN 0-13-191345-X.

© 2005 R. C. Hibbeler. Published by Pearson Prentice Hall,

Pearson Education, Inc., Upper Saddle River, NJ. All rights reserved.

This material is protected under all copyright laws as they currently exist. No portion of this material may be reproduced, in any form or by any means, without permission in writing from the publisher.

*14-44 The mass of 50 Mg is held just over the top of the steel post having a length of $L = 2$ m and a cross-sectional area of 0.01 m². If the mass is released, determine the maximum stress developed in the bar and its maximum deflection. $E_{st} = 200$ GPa, $\sigma_Y = 600$ MPa.



$$n = \left[1 + \sqrt{1 + 2\left(\frac{h}{\Delta_{st}}\right)} \right] = 1 + \sqrt{1 + 2(0)} = 2$$

$$\sigma_{\max} = n\sigma_{st} = (2)\left(\frac{50(10^3)(9.81)}{0.01}\right) = 98.1 \text{ MPa} < \sigma_Y \quad \text{Ans}$$

$$\Delta_{st} = \frac{WL}{AE} = \frac{50(10^3)(9.81)(2)}{(0.01)(200)(10^9)} = 0.4905(10^{-3})\text{m}$$

$$\Delta_{\max} = n\Delta_{st} = 2(0.4905)(10^{-3}) = 0.981(10^{-3}) \text{ m} = 0.981 \text{ mm} \quad \text{Ans}$$

From *Mechanics of Materials*, Sixth Edition by R. C. Hibbeler, ISBN 0-13-191345-X.

© 2005 R. C. Hibbeler. Published by Pearson Prentice Hall,

Pearson Education, Inc., Upper Saddle River, NJ. All rights reserved.

This material is protected under all copyright laws as they currently exist. No portion of this material may be reproduced, in any form or by any means, without permission in writing from the publisher.

14-45. Determine the speed v of the 50-Mg mass when it is just over the top of the steel post, if after impact, the maximum stress developed in the post is 550 MPa. The post has a length of $L = 1$ m and a cross-sectional area of 0.01 m². $E_{st} = 200$ GPa, $\sigma_Y = 600$ MPa.



The maximum stress :

$$\sigma_{\max} = \frac{P_{\max}}{A}$$

$$550 (10^6) = \frac{P_{\max}}{0.01}; \quad P_{\max} = 5500 \text{ kN}$$

$$\Delta_{\max} = \frac{P_{\max}}{k} \quad \text{Here } k = \frac{AE}{L} = \frac{0.01(200)(10^9)}{1} = 2 (10^9) \text{ N/m}$$

$$= \frac{5500 (10^3)}{2 (10^9)} = 2.75 (10^{-3}) \text{ m}$$

Conservation of energy :

$$U_e = U_i$$

$$\frac{1}{2} mv^2 + W \Delta_{\max} = \frac{1}{2} k \Delta_{\max}^2$$

$$\frac{1}{2} (50)(10^3)(v^2) + 50(10^3)(9.81) [2.75 (10^{-3})] = \frac{1}{2} (2)(10^9)[2.75 (10^{-3})]^2$$

$$v = 0.499 \text{ m/s}$$

Ans

From *Mechanics of Materials*, Sixth Edition by R. C. Hibbeler, ISBN 0-13-191345-X.

© 2005 R. C. Hibbeler. Published by Pearson Prentice Hall,

Pearson Education, Inc., Upper Saddle River, NJ. All rights reserved.

This material is protected under all copyright laws as they currently exist. No portion of this material may be reproduced, in any form or by any means, without permission in writing from the publisher.

14-46. The composite aluminum bar is made from two segments having diameters of 5 mm and 10 mm. Determine the maximum axial stress developed in the bar if the 5-kg collar is dropped from a height of $h = 100$ mm. $E_{al} = 70$ GPa, $\sigma_Y = 410$ MPa.

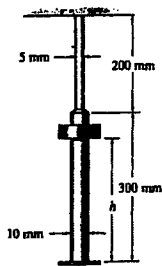

$$\Delta_{st} = \sum \frac{WL}{AE} = \frac{5(9.81)(0.2)}{\frac{\pi}{4}(0.005^2)(70)(10^9)} + \frac{5(9.81)(0.3)}{\frac{\pi}{4}(0.01^2)(70)(10^9)} = 9.8139(10^{-6}) \text{ m}$$

$$P_{max} = W \left[1 + \sqrt{1 + 2 \left(\frac{h}{\Delta_{st}} \right)} \right]$$

$$= 5(9.81) \left[1 + \sqrt{1 + 2 \left(\frac{0.1}{9.8139(10^{-6})} \right)} \right] = 7051 \text{ N}$$

$$\sigma_{max} = \frac{P_{max}}{A} = \frac{7051}{\frac{\pi}{4}(0.005^2)} = 359 \text{ MPa} < \sigma_Y \quad \text{OK} \quad \text{Ans}$$

From *Mechanics of Materials*, Sixth Edition by R. C. Hibbeler, ISBN 0-13-191345-X.

© 2005 R. C. Hibbeler. Published by Pearson Prentice Hall,

Pearson Education, Inc., Upper Saddle River, NJ. All rights reserved.

This material is protected under all copyright laws as they currently exist. No portion of this material may be reproduced, in any form or by any means, without permission in writing from the publisher.

14-47. The composite aluminum bar is made from two segments having diameters of 5 mm and 10 mm. Determine the maximum height h from which the 5-kg collar should be dropped so that it produces a maximum axial stress in the bar of $\sigma_{\max} = 300$ MPa. $E_{al} = 70$ GPa, $\sigma_Y = 410$ MPa.

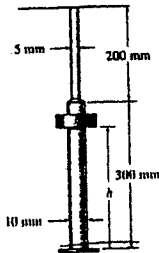

$$\Delta_{st} = \sum \frac{WL}{AE} = \frac{5(9.81)(0.2)}{\frac{\pi}{4}(0.005^2)(70)(10^9)} + \frac{5(9.81)(0.3)}{\frac{\pi}{4}(0.01^2)(70)(10^9)} = 9.8139(10^{-6}) \text{ m}$$

$$P_{\max} = W \left[1 + \sqrt{1 + 2 \left(\frac{h}{\Delta_{st}} \right)} \right]$$

$$300(10^6) \left(\frac{\pi}{4} \right) (0.005^2) = 5(9.81) \left[1 + \sqrt{1 + 2 \left(\frac{h}{9.8139(10^{-6})} \right)} \right]$$

$$120.1 = 1 + \sqrt{1 + 203791.6 h}$$

$$h = 0.0696 \text{ m} = 69.6 \text{ mm} \quad \text{Ans}$$

From *Mechanics of Materials*, Sixth Edition by R. C. Hibbeler, ISBN 0-13-191345-X.

© 2005 R. C. Hibbeler. Published by Pearson Prentice Hall,

Pearson Education, Inc., Upper Saddle River, NJ. All rights reserved.

This material is protected under all copyright laws as they currently exist. No portion of this material may be reproduced, in any form or by any means, without permission in writing from the publisher.

*14-48 A steel cable having a diameter of 0.4 in. wraps over a drum and is used to lower an elevator having a weight of 800 lb. The elevator is 150 ft below the drum and is descending at the constant rate of 2 ft/s when the drum suddenly stops. Determine the maximum stress developed in the cable when this occurs. $E_{st} = 29(10^3)$ ksi, $\sigma_y = 50$ ksi.

$$k = \frac{AE}{L} = \frac{\frac{\pi}{4}(0.4^2)(29)(10^3)}{150(12)} = 2.0246 \text{ kip/in.}$$

$$U_e = U_i$$

$$\frac{1}{2}mv^2 + W\Delta_{max} = \frac{1}{2}k\Delta_{max}^2$$

$$\frac{1}{2}\left[\frac{800}{32.2(12)}\right][(12)(2)]^2 + 800\Delta_{max} = \frac{1}{2}(2.0246)(10^3)\Delta_{max}^2$$

$$596.27 + 800\Delta_{max} = 1012.29\Delta_{max}^2$$

$$\Delta_{max} = 1.2584 \text{ in.}$$

$$P_{max} = k\Delta_{max} = 2.0246(1.2584) = 2.5477 \text{ kip}$$

$$\sigma_{max} = \frac{P_{max}}{A} = \frac{2.5477}{\frac{\pi}{4}(0.4)^2} = 20.3 \text{ ksi} < \sigma_y \quad \text{OK} \quad \text{Ans}$$

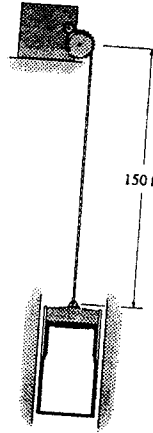

From *Mechanics of Materials*, Sixth Edition by R. C. Hibbeler, ISBN 0-13-191345-X.

© 2005 R. C. Hibbeler. Published by Pearson Prentice Hall,

Pearson Education, Inc., Upper Saddle River, NJ. All rights reserved.

This material is protected under all copyright laws as they currently exist. No portion of this material may be reproduced, in any form or by any means, without permission in writing from the publisher.

14-49 Solve Probl. 14-48 if the elevator is descending at the constant rate of 3 ft/s.

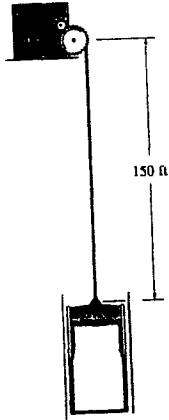

$$k = \frac{AE}{L} = \frac{\frac{\pi}{4}(0.4^2)(29)(10^3)}{150(12)} = 2.0246 \text{ kip/in.}$$

$$U_e = U_i$$

$$\frac{1}{2}mv^2 + W\Delta_{\max} = \frac{1}{2}k\Delta_{\max}^2$$

$$\frac{1}{2}\left[\frac{800}{32.2(12)}\right][(12)(3)]^2 + 800\Delta_{\max} = \frac{1}{2}(2.0246)(10^3)\Delta_{\max}^2$$

$$1341.61 + 800\Delta_{\max} = 1012.29\Delta_{\max}^2$$

$$\Delta_{\max} = 1.6123 \text{ in.}$$

$$P_{\max} = k\Delta_{\max} = 2.0246(1.6123) = 3.2643 \text{ kip}$$

$$\sigma_{\max} = \frac{P_{\max}}{A} = \frac{3.2643}{\frac{\pi}{4}(0.4)^2} = 26.0 \text{ ksi} < \sigma_y \quad \text{OK} \quad \text{Ans}$$

From *Mechanics of Materials*, Sixth Edition by R. C. Hibbeler, ISBN 0-13-191345-X.

© 2005 R. C. Hibbeler. Published by Pearson Prentice Hall,

Pearson Education, Inc., Upper Saddle River, NJ. All rights reserved.

This material is protected under all copyright laws as they currently exist. No portion of this material may be reproduced, in any form or by any means, without permission in writing from the publisher.

14-50 The steel chisel has a diameter of 0.5 in. and a length of 10 in. It is struck by a hammer that weighs 3 lb, and at the instant of impact it is moving at 12 ft/s. Determine the maximum compressive stress in the chisel, assuming that 80% of the impacting energy goes into the chisel. $E_{st} = 29(10^3)$ ksi, $\sigma_Y = 100$ ksi.

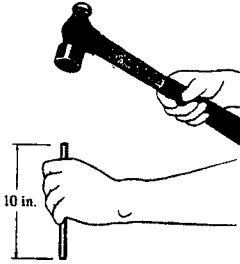

$$k = \frac{AE}{L} = \frac{\frac{\pi}{4}(0.5^2)(29)(10^3)}{10} = 569.41 \text{ kip/in.}$$

$$0.8U_e = U_i$$

$$0.8\left[\frac{1}{2}\left(\frac{3}{32.2}\right)((12)(12))^2 + 3\Delta_{\max}\right] = \frac{1}{2}(569.41)(10^3)\Delta_{\max}^2$$

$$\Delta_{\max} = 0.015044 \text{ in.}$$

$$P = k\Delta_{\max} = 569.41(0.015044) = 8.566 \text{ kip}$$

$$\sigma_{\max} = \frac{P_{\max}}{A} = \frac{8.566}{\frac{\pi}{4}(0.5)^2} = 43.6 \text{ ksi} < \sigma_Y \quad \text{OK} \quad \text{Ans}$$

From *Mechanics of Materials*, Sixth Edition by R. C. Hibbeler, ISBN 0-13-191345-X.

© 2005 R. C. Hibbeler. Published by Pearson Prentice Hall,

Pearson Education, Inc., Upper Saddle River, NJ. All rights reserved.

This material is protected under all copyright laws as they currently exist. No portion of this material may be reproduced, in any form or by any means, without permission in writing from the publisher.

14-51. The A-36 steel bolt is required to absorb the energy of a 2-kg mass that falls $h = 30$ mm. If the bolt has a diameter of 4 mm, determine its required length L so the stress in the bolt does not exceed 150 MPa.

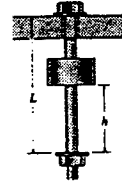

$$\text{Maximum Stress : With } \Delta_{st} = \frac{WL}{AE} = \frac{2(9.81)(L)}{\frac{\pi}{4}(0.004^2)[200(10^9)]}$$

$$= 7.80655(10^{-6})L \text{ and } \sigma_{st} = \frac{W}{A} = \frac{2(9.81)}{\frac{\pi}{4}(0.004^2)} = 1.56131 \text{ MPa, we have}$$

$$\sigma_{max} = n\sigma_{st} \text{ where } n = 1 + \sqrt{1 + 2\left(\frac{h}{\Delta_{st}}\right)}$$

$$150(10^6) = \left[1 + \sqrt{1 + 2\left(\frac{0.03}{7.80655(10^{-6})L}\right)} \right] [1.56131(10^6)]$$

$$L = 0.8504 \text{ m} = 850 \text{ mm} \quad \text{Ans}$$

From *Mechanics of Materials*, Sixth Edition by R. C. Hibbeler, ISBN 0-13-191345-X.

© 2005 R. C. Hibbeler. Published by Pearson Prentice Hall,

Pearson Education, Inc., Upper Saddle River, NJ. All rights reserved.

This material is protected under all copyright laws as they currently exist. No portion of this material may be reproduced, in any form or by any means, without permission in writing from the publisher.

***14-52.** The A-36 steel bolt is required to absorb the energy of a 2-kg mass that falls $h = 30$ mm. If the bolt has a diameter of 4 mm and a length of $L = 200$ mm, determine if the stress in the bolt will exceed 175 MPa.

Maximum Stress : With

$$\Delta_{st} = \frac{WL}{AE} = \frac{2(9.81)(0.2)}{\frac{\pi}{4}(0.004^2)[200(10^9)]} = 1.56131(10^{-6}) \text{ m}$$

$$\sigma_{st} = \frac{W}{A} = \frac{2(9.81)}{\frac{\pi}{4}(0.004^2)} = 1.56131 \text{ MPa}$$

Applying Eq. 14-34, we have

$$n = 1 + \sqrt{1 + 2\left(\frac{h}{\Delta_{st}}\right)} = 1 + \sqrt{1 + 2\left(\frac{0.03}{1.56131(10^{-6})}\right)} = 197.04$$

Thus,

$$\sigma_{max} = n\sigma_{st} = 197.04(1.56131) = 307.6 \text{ MPa}$$

Yes, σ_{max} exceeded 175 MPa.

Ans



From *Mechanics of Materials*, Sixth Edition by R. C. Hibbeler, ISBN 0-13-191345-X.

© 2005 R. C. Hibbeler. Published by Pearson Prentice Hall,

Pearson Education, Inc., Upper Saddle River, NJ. All rights reserved.

This material is protected under all copyright laws as they currently exist. No portion of this material may be reproduced, in any form or by any means, without permission in writing from the publisher.

14-53. The A-36 steel bolt is required to absorb the energy of a 2-kg mass that falls along the 4-mm-diameter bolt shank that is 150 mm long. Determine the maximum height h of release so the stress in the bolt does not exceed 150 MPa.

$$\text{Maximum Stress: With } \Delta_{st} = \frac{WL}{AE} = \frac{2(9.81)(0.15)}{\frac{\pi}{4}(0.004^2)[200(10^9)]}$$

$$= 1.17098(10^{-6}) \text{ m and } \sigma_{st} = \frac{W}{A} = \frac{2(9.81)}{\frac{\pi}{4}(0.004^2)} = 1.56131 \text{ MPa,}$$

we have

$$\sigma_{\max} = n\sigma_{st} \quad \text{where } n = 1 + \sqrt{1 + 2\left(\frac{h}{\Delta_{st}}\right)}$$

$$150(10^6) = \left[1 + \sqrt{1 + 2\left(\frac{h}{1.17098(10^{-6})}\right)}\right][1.56131(10^6)]$$

$$h = 5.292(10^{-3}) \text{ m} = 5.29 \text{ mm} \quad \text{Ans}$$

From *Mechanics of Materials*, Sixth Edition by R. C. Hibbeler, ISBN 0-13-191345-X.

© 2005 R. C. Hibbeler. Published by Pearson Prentice Hall,

Pearson Education, Inc., Upper Saddle River, NJ. All rights reserved.

This material is protected under all copyright laws as they currently exist. No portion of this material may be reproduced, in any form or by any means, without permission in writing from the publisher.

14-54. The composite aluminum 2014-16 bar is made from two segments having diameters of 7.5 mm and 15 mm. Determine the maximum axial stress developed in the bar if the 10-kg collar is dropped from a height of $h = 100$ mm.

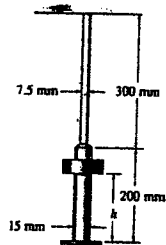

$$\Delta_{st} = \sum \frac{WL}{AE} = \frac{10(9.81)(0.3)}{\frac{\pi}{4}(0.0075)^2(73.1)(10^9)} + \frac{10(9.81)(0.2)}{\frac{\pi}{4}(0.015)^2(73.1)(10^9)}$$

$$= 10.63181147(10^{-6}) \text{ m}$$

$$n = \left[1 + \sqrt{1 + 2\left(\frac{h}{\Delta_{st}}\right)} \right] = \left[1 + \sqrt{1 + 2\left(\frac{0.1}{10.63181147(10^{-6})}\right)} \right] = 138.16$$

$$\sigma_{\max} = n \sigma_{st} \quad \text{Here } \sigma_{st} = \frac{W}{A} = \frac{10(9.81)}{\frac{\pi}{4}(0.0075^2)} = 2.22053 \text{ MPa}$$

$$\sigma_{\max} = 138.16(2.22053)$$

$$= 307 \text{ MPa} < \sigma_y = 414 \text{ MPa} \quad \text{OK} \quad \text{Ans}$$

From *Mechanics of Materials*, Sixth Edition by R. C. Hibbeler, ISBN 0-13-191345-X.

© 2005 R. C. Hibbeler. Published by Pearson Prentice Hall,

Pearson Education, Inc., Upper Saddle River, NJ. All rights reserved.

This material is protected under all copyright laws as they currently exist. No portion of this material may be reproduced, in any form or by any means, without permission in writing from the publisher.

14-55. The composite aluminum 2014-T6 bar is made from two segments having diameters of 7.5 mm and 15 mm. Determine the maximum height h from which the 10-kg collar should be dropped so that it produces a maximum axial stress in the bar of $\sigma_{\max} = 300$ MPa.

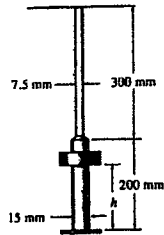

$$\Delta_{st} = \sum \frac{WL}{AE} = \frac{10(9.81)(0.3)}{\frac{\pi}{4}(0.0075)^2(73.1)(10^9)} + \frac{10(9.81)(0.2)}{\frac{\pi}{4}(0.015)^2(73.1)(10^9)}$$

$$= 10.63181147(10^{-6}) \text{ m}$$

$$n = \left[1 + \sqrt{1 + 2\left(\frac{h}{\Delta_{st}}\right)} \right] = \left[1 + \sqrt{1 + 2\left(\frac{h}{10.63181147(10^{-6})}\right)} \right]$$

$$= \left[1 + \sqrt{1 + 188114.7 h} \right]$$

$$\sigma_{\max} = n \sigma_{st} \quad \text{Here } \sigma_{st} = \frac{W}{A} = \frac{10(9.81)}{\frac{\pi}{4}(0.0075)^2} = 2.22053 \text{ MPa}$$

$$300(10^6) = \left[1 + \sqrt{1 + 188114.7 h} \right] (2220530)$$

$$h = 0.09559 \text{ m} = 95.6 \text{ mm} \quad \text{Ans}$$

From *Mechanics of Materials*, Sixth Edition by R. C. Hibbeler, ISBN 0-13-191345-X.

© 2005 R. C. Hibbeler. Published by Pearson Prentice Hall,

Pearson Education, Inc., Upper Saddle River, NJ. All rights reserved.

This material is protected under all copyright laws as they currently exist. No portion of this material may be reproduced, in any form or by any means, without permission in writing from the publisher.

***14-56.** A cylinder having the dimensions shown is made from magnesium Am 1004-T61. If it is struck by a rigid block having a weight of 800 lb and traveling at 2 ft/s, determine the maximum stress in the cylinder. Neglect the mass of the cylinder.



Conservation of Energy : The equivalent spring constant for the post

$$k = \frac{AE}{L} = \frac{\frac{\pi}{4}(6^2)[6.48(10^6)]}{1.5(12)} = 10.1788(10^6) \text{ lb/in.}$$

$$U_e = U_i$$

$$\frac{1}{2}mv^2 = \frac{1}{2}k\Delta_{\max}^2$$

$$\left[\frac{1}{2}\left(\frac{800}{32.2}\right)\right](2^2) = \frac{1}{2}[10.1788(10^6)]\Delta_{\max}^2$$

$$\Delta_{\max} = 0.01082 \text{ in.}$$

Maximum Stress : The maximum axial force is

$$P_{\max} = k\Delta_{\max} = 10.1788(10^6)(0.01082) = 110175.5 \text{ lb.}$$

$$\sigma_{\max} = \frac{P_{\max}}{A} = \frac{110175.5}{\frac{\pi}{4}(6^2)} = 3897 \text{ psi} = 3.90 \text{ ksi} \quad \text{Ans}$$

Since $\sigma_{\max} < \sigma_Y = 22 \text{ ksi}$, the above analysis is valid.

From *Mechanics of Materials*, Sixth Edition by R. C. Hibbeler, ISBN 0-13-191345-X.
 © 2005 R. C. Hibbeler. Published by Pearson Prentice Hall,
 Pearson Education, Inc., Upper Saddle River, NJ. All rights reserved.
 This material is protected under all copyright laws as they currently exist. No portion of this material may be reproduced, in any form or by any means, without permission in writing from the publisher.

14-57 The wide-flange beam has a length of $2L$, a depth $2c$, and a constant EI . Determine the maximum height h at which a weight W can be dropped on its end without exceeding a maximum elastic stress σ_{\max} in the beam.

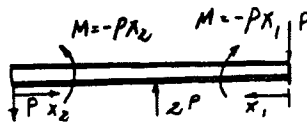
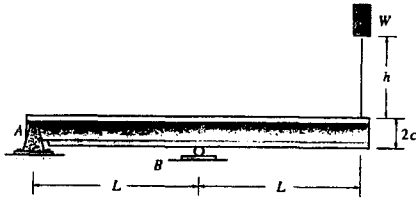

$$\frac{1}{2}P\Delta_C = 2\left(\frac{1}{2EI}\right)\int_0^L (-Px)^2 dx$$

$$\Delta_C = \frac{2PL^3}{3EI}$$

$$\Delta_{st} = \frac{2WL^3}{3EI}$$

$$n = 1 + \sqrt{1 + 2\left(\frac{h}{\Delta_{st}}\right)}$$

$$\sigma_{\max} = n(\sigma_{st})_{\max} \quad (\sigma_{st})_{\max} = \frac{WLC}{I}$$

$$\sigma_{\max} = \left[1 + \sqrt{1 + 2\left(\frac{h}{\Delta_{st}}\right)}\right] \frac{WLC}{I}$$

$$\left(\frac{\sigma_{\max} I}{WLC} - 1\right)^2 = 1 + \frac{2h}{\Delta_{st}}$$

$$h = \frac{\Delta_{st}}{2} \left[\left(\frac{\sigma_{\max} I}{WLC} - 1\right)^2 - 1 \right]$$

$$= \frac{WL^3}{3EI} \left[\left(\frac{\sigma_{\max} I}{WLC}\right)^2 - \frac{2\sigma_{\max} I}{WLC} \right] = \frac{\sigma_{\max} L^2}{3Ec} \left[\frac{\sigma_{\max} I}{WLC} - 2 \right] \quad \text{Ans}$$

From *Mechanics of Materials*, Sixth Edition by R. C. Hibbeler, ISBN 0-13-191345-X.

© 2005 R. C. Hibbeler. Published by Pearson Prentice Hall,

Pearson Education, Inc., Upper Saddle River, NJ. All rights reserved.

This material is protected under all copyright laws as they currently exist. No portion of this material may be reproduced, in any form or by any means, without permission in writing from the publisher.

14-58. The diver weighs 150 lb and, while holding himself rigid, strikes the end of a wooden diving board ($h = 0$) with a downward velocity of 2 ft/s. Determine the maximum bending stress developed in the board. The board has a thickness of 1.5 in. and width of 1.5 ft. $E_w = 1.8(10^3)$ ksi, $\sigma_Y = 8$ ksi.

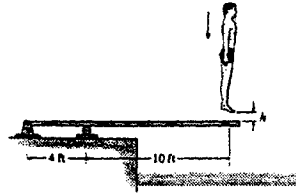

Static Displacement : The static displacement at the end of the diving board can be determined using the conservation of energy.

$$\begin{aligned} \frac{1}{2} P \Delta &= \int_0^L \frac{M^2 dx}{2EI} \\ \frac{1}{2} (150) \Delta_{st} &= \frac{1}{2EI} \left[\int_0^{4ft} (-375x_1)^2 dx_1 + \int_0^{10ft} (-150x_2)^2 dx_2 \right] \\ \Delta_{st} &= \frac{70.0(10^3) \text{ lb} \cdot \text{ft}^3}{EI} \\ &= \frac{70.0(10^3)(12^3)}{1.8(10^6) \left[\frac{1}{12}(18)(1.5^3) \right]} \\ &= 13.274 \text{ in.} \end{aligned}$$

Conservation of Energy : The equivalent spring constant for the board is $k = \frac{W}{\Delta_{st}} = \frac{150}{13.274} = 11.30 \text{ lb/in.}$

$$\begin{aligned} U_e &= U_i \\ \frac{1}{2} m v^2 + W \Delta_{max} &= \frac{1}{2} k \Delta_{max}^2 \\ \left[\frac{1}{2} \left(\frac{150}{32.2} \right) (4^2) \right] (12) + 150 \Delta_{max} &= \frac{1}{2} (11.30) \Delta_{max}^2 \end{aligned}$$

Solving for the positive root, we have

$$\Delta_{max} = 29.2538 \text{ in.}$$

Maximum Stress : The maximum force on the beam is $P_{max} = k \Delta_{max} = 11.30(29.2538) = 330.57 \text{ lb}$. The maximum moment occurs at the middle support. $M_{max} = 330.57(10)(12) = 39668.90 \text{ lb} \cdot \text{in}$.

$$\sigma_{max} = \frac{M_{max} c}{I} = \frac{39668.90(0.75)}{\frac{1}{12}(18)(1.5^3)} = 5877 \text{ psi} = 5.88 \text{ ksi} \quad \text{Ans}$$

Note : The result will be somewhat inaccurate since the static displacement is so large.

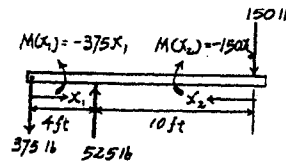

From *Mechanics of Materials*, Sixth Edition by R. C. Hibbeler, ISBN 0-13-191345-X.

© 2005 R. C. Hibbeler. Published by Pearson Prentice Hall,

Pearson Education, Inc., Upper Saddle River, NJ. All rights reserved.

This material is protected under all copyright laws as they currently exist. No portion of this material may be reproduced, in any form or by any means, without permission in writing from the publisher.

14-59. The diver weighs 150 lb and, while holding himself rigid, strikes the end of the wooden diving board. Determine the maximum height h from which he can jump onto the board so that the maximum bending stress in the wood does not exceed 6 ksi. The board has a thickness of 1.5 in. and width of 1.5 ft. $E_w = 1.8(10^3)$ ksi.

Static Displacement : The static displacement at the end of the diving board can be determined using the conservation of energy.

$$\begin{aligned} \frac{1}{2} P \Delta &= \int_0^L \frac{M^2 dx}{2EI} \\ \frac{1}{2} (150) \Delta_{st} &= \frac{1}{2EI} \left[\int_0^{4ft} (-375x_1)^2 dx_1 + \int_0^{10ft} (-150x_2)^2 dx_2 \right] \\ \Delta_{st} &= \frac{70.0(10^3) \text{ lb} \cdot \text{ft}^3}{EI} \\ &= \frac{70.0(10^3)(12^3)}{1.8(10^6) \left[\frac{1}{12}(18)(1.5^3) \right]} \\ &= 13.274 \text{ in.} \end{aligned}$$

Maximum Stress : The maximum force on the beam is P_{max} . The maximum moment occurs at the middle support. $M_{max} = P_{max}(10)(12) = 120P_{max}$.

$$\begin{aligned} \sigma_{max} &= \frac{M_{max} c}{I} \\ 6(10^3) &= \frac{120P_{max}(0.75)}{\frac{1}{12}(18)(1.5^3)} \\ P_{max} &= 337.5 \text{ lb} \end{aligned}$$

Conservation of Energy : The equivalent spring constant for the board is

$$k = \frac{W}{\Delta_{st}} = \frac{150}{13.274} = 11.30 \text{ lb/in.} \quad \text{The maximum displacement at the end}$$

$$\text{of the board is } \Delta_{max} = \frac{P_{max}}{k} = \frac{337.5}{11.30} = 29.867 \text{ in.}$$

$$\begin{aligned} U_s &= U_i \\ W(h + \Delta_{max}) &= \frac{1}{2} k \Delta_{max}^2 \\ 150(h + 29.867) &= \frac{1}{2} (11.30) (29.867^2) \end{aligned}$$

$$h = 3.73 \text{ in.} \quad \text{Ans}$$

Note : The result will be somewhat inaccurate since the static displacement is so large.

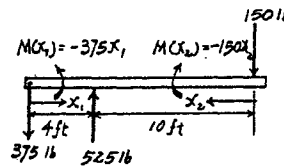
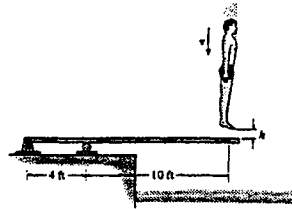

From *Mechanics of Materials*, Sixth Edition by R. C. Hibbeler, ISBN 0-13-191345-X.
 © 2005 R. C. Hibbeler. Published by Pearson Prentice Hall,
 Pearson Education, Inc., Upper Saddle River, NJ. All rights reserved.
 This material is protected under all copyright laws as they currently exist. No portion of this material may be reproduced, in any form or by any means, without permission in writing from the publisher.

*14-60 A 40-lb weight is dropped from a height of $h = 2$ ft onto the center of the cantilevered A-36 steel beam. If the beam is a $W 10 \times 15$, determine the maximum bending stress developed in the beam.

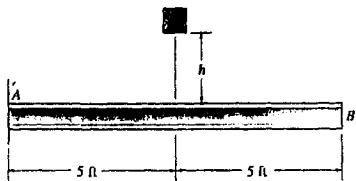

From Appendix C :

$$\Delta_{st} = \frac{P L^3}{3 E I} = \frac{40 [5(12)]^3}{3 (29)(10^6)(68.9)} = 1.44137 (10^{-3}) \text{ in.}$$

$$n = \left[1 + \sqrt{1 + 2\left(\frac{h}{\Delta_{st}}\right)} \right] = \left[1 + \sqrt{1 + 2\left(\frac{2(12)}{1.44137 (10^{-3})}\right)} \right] = 183.49$$

$$\sigma_{st} = \frac{M c}{I}; \quad \text{Here } M = 40(5)(12) = 2400 \text{ lb} \cdot \text{in.}$$

$$\text{For } W 10 \times 15 : \quad I = 68.9 \text{ in}^4 \quad d = 9.99 \text{ in.}$$

$$\sigma_{st} = \frac{2400 (4.995)}{68.9}, \quad c = \frac{9.99}{2} = 4.995 \text{ in.}$$

$$= 174.0 \text{ psi}$$

$$\sigma_{max} = n \sigma_{st} = 183.49 (174.0)$$

$$= 31926 \text{ psi} = 31.9 \text{ ksi} < \sigma_Y = 36 \text{ ksi} \quad \text{OK} \quad \text{Ans}$$

From *Mechanics of Materials*, Sixth Edition by R. C. Hibbeler, ISBN 0-13-191345-X.

© 2005 R. C. Hibbeler. Published by Pearson Prentice Hall,

Pearson Education, Inc., Upper Saddle River, NJ. All rights reserved.

This material is protected under all copyright laws as they currently exist. No portion of this material may be reproduced, in any form or by any means, without permission in writing from the publisher.

14-61 If the maximum allowable bending stress for the $W 10 \times 15$ structural A-36 steel beam is $\sigma_{\text{allow}} = 20 \text{ ksi}$, determine the maximum height h from which a 50-lb weight can be released from rest and strike the center of the beam.

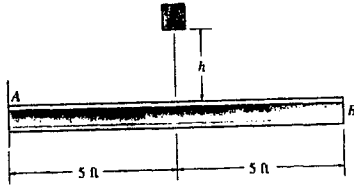

From Appendix C :

$$\Delta_{\text{st}} = \frac{P L^3}{3 E I} = \frac{50 [5(12)]^3}{3 (29)(10^6)(68.9)} = 1.80171 (10^{-3}) \text{ in.}$$

$$\sigma_{\text{st}} = \frac{M c}{I}; \quad \text{Here } M = 50(5)(12) = 3000 \text{ lb} \cdot \text{in.}$$

$$\text{For } W 10 \times 15 : \quad I = 68.9 \text{ in}^4 \quad d = 9.99 \text{ in.}$$

$$\sigma_{\text{st}} = \frac{3000 (4.995)}{68.9}, \quad c = \frac{9.99}{2} = 4.995 \text{ in.}$$

$$= 217.49 \text{ psi}$$

$$\sigma_{\text{max}} = n \sigma_{\text{st}}$$

$$20 (10^3) = n(217.49); \quad n = 91.96$$

$$n = \left[1 + \sqrt{1 + 2\left(\frac{h}{\Delta_{\text{st}}}\right)} \right]$$

$$91.96 = \left[1 + \sqrt{1 + 2\left(\frac{h}{1.80171 (10^{-3})}\right)} \right]$$

$$91.96 = \left[1 + \sqrt{1 + 1110.06 h} \right]$$

$$h = 7.45 \text{ in.} \quad \text{Ans}$$

From *Mechanics of Materials*, Sixth Edition by R. C. Hibbeler, ISBN 0-13-191345-X.

© 2005 R. C. Hibbeler. Published by Pearson Prentice Hall,

Pearson Education, Inc., Upper Saddle River, NJ. All rights reserved.

This material is protected under all copyright laws as they currently exist. No portion of this material may be reproduced, in any form or by any means, without permission in writing from the publisher.

14-62 A 40-lb weight is dropped from a height of $h = 2$ ft onto the center of the cantilevered A-36 steel beam. If the beam is a $W 10 \times 15$, determine the vertical displacement of its end B due to the impact.

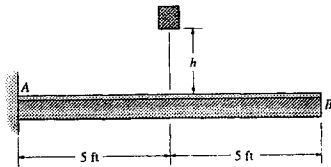

From Appendix C :

$$\Delta_{st} = \frac{P L^3}{3 E I} = \frac{40 [5(12)]^3}{3 (29)(10^6)(68.9)} = 1.44137 (10^{-3}) \text{ in.}$$

$$n = \left[1 + \sqrt{1 + 2\left(\frac{h}{\Delta_{st}}\right)} \right] = \left[1 + \sqrt{1 + 2\left(\frac{24}{1.44137 (10^{-3})}\right)} \right] = 183.49$$

From Appendix C :

$$\theta_{st} = \frac{P L^2}{2 E I} = \frac{40 [5(12)]^2}{2 (29)(10^6)(68.9)} = 36.034 (10^{-6}) \text{ rad}$$

$$\theta_{\max} = n \theta_{st} = 183.49 [36.034 (10^{-6})] = 6.612 (10^{-3}) \text{ rad}$$

$$\Delta_{\max} = n \Delta_{st} = 183.49 [1.44137 (10^{-3})] = 0.26448 \text{ in.}$$

$$\begin{aligned} (\Delta_B)_{\max} &= \Delta_{\max} + \theta_{\max} L = 0.26448 + 6.612 (10^{-3})(5)(12) \\ &= 0.661 \text{ in.} \quad \text{Ans} \end{aligned}$$

From *Mechanics of Materials*, Sixth Edition by R. C. Hibbeler, ISBN 0-13-191345-X.

© 2005 R. C. Hibbeler. Published by Pearson Prentice Hall,

Pearson Education, Inc., Upper Saddle River, NJ. All rights reserved.

This material is protected under all copyright laws as they currently exist. No portion of this material may be reproduced, in any form or by any means, without permission in writing from the publisher.

14-63 The steel beam AB acts to stop the oncoming railroad car, which has a mass of 10 Mg and is coasting towards it at $v = 0.5\text{ m/s}$. Determine the maximum stress developed in the beam if it is struck at its center by the car. The beam is simply supported and only horizontal forces occur at A and B . Assume that the railroad car and the supporting framework for the beam remains rigid. Also, compute the maximum deflection of the beam. $E_{st} = 200\text{ GPa}$, $\sigma_Y = 250\text{ MPa}$.

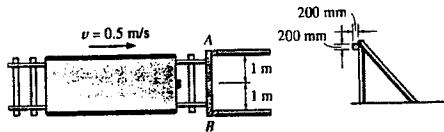

From Appendix C :

$$\Delta_{st} = \frac{PL^3}{48EI} = \frac{10(10^3)(9.81)(2^3)}{48(200)(10^4)(\frac{1}{12})(0.2)(0.2^3)} = 0.613125(10^{-3})\text{ m}$$

$$k = \frac{W}{\Delta_{st}} = \frac{10(10^3)(9.81)}{0.613125(10^{-3})} = 160(10^6)\text{ N/m}$$

$$W = k\Delta_{\max} = 160(10^6)(3.953)(10^{-3}) = 632455.53\text{ N}$$

$$M = \frac{w'L}{4} = \frac{632455.53(2)}{4} = 316228\text{ N}\cdot\text{m}$$

$$\sigma_{\max} = \frac{M'c}{I} = \frac{316228(0.1)}{\frac{1}{12}(0.2)(0.2^3)} = 237\text{ MPa} < \sigma_Y \quad \text{OK} \quad \text{Ans}$$

$$\Delta_{\max} = \sqrt{\frac{\Delta_{st}v^2}{g}} = \sqrt{\frac{0.613125(10^{-3})(0.5^2)}{9.81}} = 3.953(10^{-3})\text{ m} = 3.95\text{ mm} \quad \text{Ans}$$

From *Mechanics of Materials*, Sixth Edition by R. C. Hibbeler, ISBN 0-13-191345-X.

© 2005 R. C. Hibbeler. Published by Pearson Prentice Hall,

Pearson Education, Inc., Upper Saddle River, NJ. All rights reserved.

This material is protected under all copyright laws as they currently exist. No portion of this material may be reproduced, in any form or by any means, without permission in writing from the publisher.

***14-64.** The tugboat has a weight of 120 000 lb and is traveling forward at 2 ft/s when it strikes the 12-in.-diameter fender post AB used to protect a bridge pier. If the post is made from treated white spruce and is assumed fixed at the river bed, determine the maximum horizontal distance the top of the post will move due to the impact. Assume the tugboat is rigid and neglect the effect of the water.

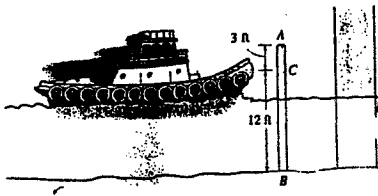

From Appendix C :

$$P_{\max} = \frac{3EI(\Delta_C)_{\max}}{(L_{BC})^3}$$

Conservation of energy :

$$\frac{1}{2}mv^2 = \frac{1}{2}P_{\max}(\Delta_C)_{\max}$$

$$\frac{1}{2}mv^2 = \frac{1}{2} \left(\frac{3EI(\Delta_C)_{\max}^2}{(L_{BC})^3} \right)$$

$$(\Delta_C)_{\max} = \sqrt{\frac{mv^2 L_{BC}^3}{3EI}}$$

$$(\Delta_C)_{\max} = \sqrt{\frac{(120\,000/32.2)(2)^2(12)^3}{(3)(1.40)(10^6)(\frac{\pi}{4})(144)(0.5)^4}} = 0.9315 \text{ ft} = 11.177 \text{ in.}$$

$$P_{\max} = \frac{3[1.40(10^6)](\frac{\pi}{4})(6)^4(11.177)}{(144)^3} = 16.00 \text{ kip}$$

$$\theta_C = \frac{P_{\max} L_{BC}^2}{2EI} = \frac{16.00(10^3)(144)^2}{2(1.40)(10^6)(\frac{\pi}{4})(6)^4} = 0.11644 \text{ rad}$$

$$(\Delta_A)_{\max} = (\Delta_C)_{\max} + \theta_C(L_{CA})$$

$$(\Delta_A)_{\max} = 11.177 + 0.11644(36) = 15.4 \text{ in.} \quad \text{Ans}$$

From *Mechanics of Materials*, Sixth Edition by R. C. Hibbeler, ISBN 0-13-191345-X.

© 2005 R. C. Hibbeler. Published by Pearson Prentice Hall,

Pearson Education, Inc., Upper Saddle River, NJ. All rights reserved.

This material is protected under all copyright laws as they currently exist. No portion of this material may be reproduced, in any form or by any means, without permission in writing from the publisher.

14-65 The $W 10 \times 12$ beam is made from A-36 steel and is cantilevered from the wall at B . The spring mounted on the beam has a stiffness of $k = 1000$ lb/in. If a weight of 8 lb is dropped onto the spring from a height of 3 ft, determine the maximum bending stress developed in the beam.

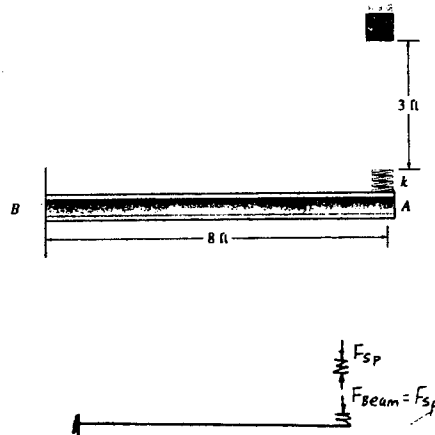

For $W 10 \times 12$: $I = 53.8 \text{ in}^4$ $d = 9.87 \text{ in}$.

From Appendix C :

$$\Delta_{\text{beam}} = \frac{P L^3}{3 E I}$$

$$k_{\text{beam}} = \frac{3 E I}{L^3} = \frac{3 (29)(10^3)(53.8)}{[8(12)]^3} = 5.2904 \text{ kip/in.}$$

Equilibrium (equivalent system) :

$$F_{sp} = F_{\text{beam}}$$

$$k_{sp} \Delta_{sp} = k_{\text{beam}} \Delta_{\text{beam}}$$

$$\Delta_{sp} = \frac{5.2904(10^3)}{1000} \Delta_{\text{beam}}$$

$$\Delta_{sp} = 5.2904 \Delta_{\text{beam}} \quad (1)$$

Conservation of energy :

$$U_e = U_i$$

$$W (h + \Delta_{sp} + \Delta_{\text{beam}}) = \frac{1}{2} k_{\text{beam}} \Delta_{\text{beam}}^2 + \frac{1}{2} k_{sp} \Delta_{sp}^2$$

From Eq. (1)

$$8[(3)(12) + 5.2904 \Delta_{\text{beam}} + \Delta_{\text{beam}}] = \frac{1}{2} (5.2904)(10^3) \Delta_{\text{beam}}^2 + \frac{1}{2} (1000)(5.2904 \Delta_{\text{beam}})^2$$

$$16639.37 \Delta_{\text{beam}}^2 - 50.32 \Delta_{\text{beam}} - 288 = 0$$

$$\Delta_{\text{beam}} = 0.13308 \text{ in.}$$

$$F_{\text{beam}} = k_{\text{beam}} \Delta_{\text{beam}} = 5.2904 (0.13308) = 0.70406 \text{ kip}$$

$$M_{\text{max}} = 0.70406(8)(12) = 67.59 \text{ kip} \cdot \text{in.}$$

$$\sigma_{\text{max}} = \frac{M_{\text{max}} c}{I} = \frac{67.59 (\frac{9.87}{2})}{53.8} = 6.20 \text{ ksi} < \sigma_y \quad \text{OK} \quad \text{Ans}$$

From *Mechanics of Materials*, Sixth Edition by R. C. Hibbeler, ISBN 0-13-191345-X.

© 2005 R. C. Hibbeler. Published by Pearson Prentice Hall,

Pearson Education, Inc., Upper Saddle River, NJ. All rights reserved.

This material is protected under all copyright laws as they currently exist. No portion of this material may be reproduced, in any form or by any means, without permission in writing from the publisher.

14-66 The 200-lb block has a downward velocity of 4 ft/s when it is 3 ft from the top of the wooden beam. Determine the maximum stress in the beam due to the impact and compute the maximum deflection of its end C. $E_w = 1.9(10^3)$ ksi, $\sigma_y = 6$ ksi.

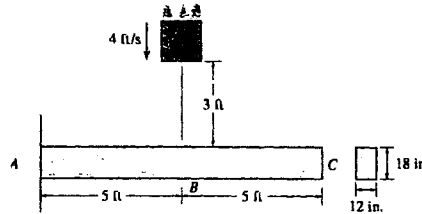

From Appendix C :

$$\Delta_{st} = \frac{PL^3}{3EI}$$

$$k = \frac{3EI}{L^3} = \frac{3(1.9)(10^3)(\frac{1}{12})(12)(18^3)}{(5(12))^3} = 153.9 \text{ kip/in.}$$

Conservation of energy :

$$U_e = U_i$$

$$\frac{1}{2}mv^2 + W(h + \Delta_{max}) = \frac{1}{2}k\Delta_{max}^2$$

$$\frac{1}{2}\left(\frac{200}{32.2(12)}\right)(4(12))^2 + 200(3(12) + \Delta_{max}) = \frac{1}{2}(153.9)(10^3)\Delta_{max}^2$$

$$7796.27 + 200\Delta_{max} = 76950\Delta_{max}^2$$

$$\Delta_{max} = 0.31960 \text{ in.}$$

$$W' = k\Delta_{max} = 153.9(0.31960) = 49.187 \text{ kip}$$

$$M' = 49.187(5)(12) = 2951.22 \text{ kip} \cdot \text{in.}$$

$$\sigma_{max} = \frac{M'c}{I} = \frac{2951.22(9)}{\frac{1}{12}(12)(18^3)} = 4.55 \text{ ksi} < \sigma_y \quad \text{OK} \quad \text{Ans}$$

From Appendix C :

$$\theta_B = \frac{WL^2}{2EI} = \frac{49.187(5(12))^2}{2(1.9)(10^3)(\frac{1}{12})(12)(18^3)} = 7.990(10^{-3}) \text{ rad}$$

$$\Delta_B = \Delta_{max} = 0.31960 \text{ in.}$$

$$\Delta_C = \Delta_B + \theta_B(5)(12)$$

$$= 0.31960 + 7.990(10^{-3})(60) = 0.799 \text{ in.} \quad \text{Ans}$$

From *Mechanics of Materials*, Sixth Edition by R. C. Hibbeler, ISBN 0-13-191345-X.

© 2005 R. C. Hibbeler. Published by Pearson Prentice Hall,

Pearson Education, Inc., Upper Saddle River, NJ. All rights reserved.

This material is protected under all copyright laws as they currently exist. No portion of this material may be reproduced, in any form or by any means, without permission in writing from the publisher.

14-67 The 100-lb block has a downward velocity of 4 ft/s when it is 3 ft from the top of the wooden beam. Determine the maximum stress in the beam due to the impact and compute the maximum deflection of point *B*. $E_w = 1.9(10^3)$ ksi, $\sigma_y = 8$ ksi.

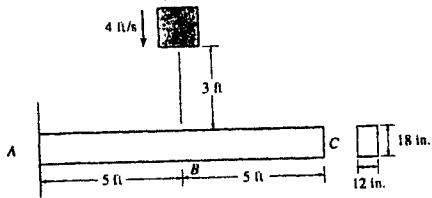

From Appendix C :

$$\Delta_{st} = \frac{PL^3}{3EI}$$

$$k = \frac{3EI}{L^3} = \frac{3(1.9)(10^3)(\frac{1}{12})(12)(18^3)}{(5(12))^3} = 153.9 \text{ kip/in.}$$

Conservation of energy :

$$U_c = U_i$$

$$\frac{1}{2}mv^2 + W(h + \Delta_{max}) = \frac{1}{2}k\Delta_{max}^2$$

$$\frac{1}{2}(\frac{100}{32.2})(4(12))^2 + 100(3(12) + \Delta_{max}) = \frac{1}{2}(153.9)(10^3)\Delta_{max}^2$$

$$3898.14 + 100\Delta_{max} = 76950\Delta_{max}^2$$

$$\Delta_{max} = 0.2257 \text{ in.} = 0.226 \text{ in.} \quad \text{Ans}$$

$$W = k\Delta_{max} = 153.9(0.2257) = 34.739 \text{ kip}$$

$$M = 34.739(5)(12) = 2084.33 \text{ kip} \cdot \text{in.}$$

$$\sigma_{max} = \frac{M'c}{I} = \frac{2084.33(9)}{\frac{1}{12}(12)(18^3)} = 3.22 \text{ ksi} < \sigma_y \quad \text{OK} \quad \text{Ans}$$

From *Mechanics of Materials*, Sixth Edition by R. C. Hibbeler, ISBN 0-13-191345-X.

© 2005 R. C. Hibbeler. Published by Pearson Prentice Hall,

Pearson Education, Inc., Upper Saddle River, NJ. All rights reserved.

This material is protected under all copyright laws as they currently exist. No portion of this material may be reproduced, in any form or by any means, without permission in writing from the publisher.

*14-68 The weight of 175 lb is dropped from a height of 4 ft from the top of the A-36 steel beam. Determine the maximum deflection and maximum stress in the beam if the supporting springs at *A* and *B* each have a stiffness of $k = 500$ lb/in. The beam is 3 in. thick and 4 in. wide.

From Appendix C :

$$\Delta_{\text{beam}} = \frac{PL^3}{48EI}$$

$$k_{\text{beam}} = \frac{48EI}{L^3} = \frac{48(29)(10^3)(\frac{1}{12})(4)(3^3)}{(16(12))^3} = 1.7700 \text{ kip/in.}$$

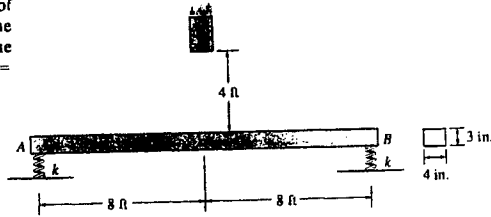

From equilibrium (equivalent system) :

$$2F_{\text{sp}} = F_{\text{beam}}$$

$$2k_{\text{sp}}\Delta_{\text{sp}} = k_{\text{beam}}\Delta_{\text{beam}}$$

$$\Delta_{\text{sp}} = \frac{1.7700(10^3)}{2(500)}\Delta_{\text{beam}}$$

$$\Delta_{\text{sp}} = 1.7700\Delta_{\text{beam}} \quad (1)$$



Conservation of energy :

$$U_e = U_i$$

$$W(h + \Delta_{\text{sp}} + \Delta_{\text{beam}}) = \frac{1}{2}k_{\text{beam}}\Delta_{\text{beam}}^2 + 2(\frac{1}{2})k_{\text{sp}}\Delta_{\text{sp}}^2$$

From Eq. (1) :

$$175[(4)(12) + 1.770\Delta_{\text{beam}} + \Delta_{\text{beam}}] = \frac{1}{2}(1.7700)(10^3)\Delta_{\text{beam}}^2 + 500(1.7700\Delta_{\text{beam}})^2$$

$$2451.5\Delta_{\text{beam}}^2 - 484.75\Delta_{\text{beam}} - 8400 = 0$$

$$\Delta_{\text{beam}} = 1.9526 \text{ in.}$$

From Eq. (1) :

$$\Delta_{\text{sp}} = 3.4561 \text{ in.}$$

$$\Delta_{\text{max}} = \Delta_{\text{sp}} + \Delta_{\text{beam}}$$

$$= 3.4561 + 1.9526 = 5.41 \text{ in.} \quad \text{Ans}$$

$$F_{\text{beam}} = k_{\text{beam}}\Delta_{\text{beam}}$$

$$= 1.7700(1.9526) = 3.4561 \text{ kip}$$

$$M_{\text{max}} = \frac{F_{\text{beam}}L}{4} = \frac{3.4561(16)(12)}{4} = 165.893 \text{ kip} \cdot \text{in.}$$

$$\sigma_{\text{max}} = \frac{M_{\text{max}}c}{I} = \frac{165.893(1.5)}{\frac{1}{12}(4)(3^3)} = 27.6 \text{ ksi} < \sigma_Y \quad \text{OK} \quad \text{Ans}$$

From *Mechanics of Materials*, Sixth Edition by R. C. Hibbeler, ISBN 0-13-191345-X.

© 2005 R. C. Hibbeler. Published by Pearson Prentice Hall,

Pearson Education, Inc., Upper Saddle River, NJ. All rights reserved.

This material is protected under all copyright laws as they currently exist. No portion of this material may be reproduced, in any form or by any means, without permission in writing from the publisher.

14-69 The weight of 175 lb is dropped from a height of 4 ft from the top of the A-36 steel beam. Determine the load factor n if the supporting springs at A and B each have a stiffness of $k = 300$ lb/in. The beam is 3 in. thick and 4 in. wide.

From Appendix C :

$$\Delta_{\text{beam}} = \frac{PL^3}{48EI}$$

$$k_{\text{beam}} = \frac{48EI}{L^3} = \frac{48(29)(10^3)(\frac{1}{12})(4)(3^3)}{(16(12))^3} = 1.7700 \text{ kip/in.}$$

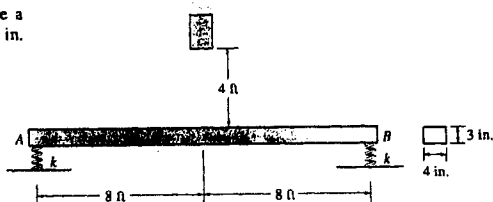

From equilibrium (equivalent system) :

$$2F_{\text{sp}} = F_{\text{beam}}$$

$$2F_{\text{sp}}\Delta_{\text{sp}} = k_{\text{beam}}\Delta_{\text{beam}}$$

$$\Delta_{\text{sp}} = \frac{1.7700(10^3)}{2(300)}\Delta_{\text{beam}}$$

$$\Delta_{\text{sp}} = 2.95\Delta_{\text{beam}} \quad (1)$$

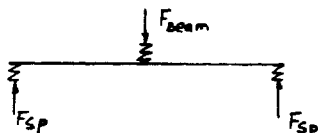

Conservation of energy :

$$U_e = U_i$$

$$W(h + \Delta_{\text{beam}} + \Delta_{\text{sp}}) = \frac{1}{2}k_{\text{beam}}\Delta_{\text{beam}}^2 + 2(\frac{1}{2})k_{\text{sp}}\Delta_{\text{sp}}^2$$

From Eq. (1) :

$$175[(4)(12) + \Delta_{\text{beam}} + 2.95\Delta_{\text{beam}}] = \frac{1}{2}(1.7700)(10^3)\Delta_{\text{beam}}^2 + 300(2.95\Delta_{\text{beam}})^2$$

$$3495.75\Delta_{\text{beam}}^2 - 691.25\Delta_{\text{beam}} - 8400 = 0$$

$$\Delta_{\text{beam}} = 1.6521 \text{ in.}$$

$$F_{\text{beam}} = k_{\text{beam}}\Delta_{\text{beam}}$$

$$= 1.7700(1.6521) = 2.924 \text{ kip}$$

$$n = \frac{2.924(10^3)}{175} = 16.7 \quad \text{Ans}$$

$$\sigma_{\text{max}} = n(\sigma_{\text{st}})_{\text{max}} = n\left(\frac{Mc}{I}\right)$$

$$M = \frac{175(16)(12)}{4} = 8.40 \text{ kip} \cdot \text{in.}$$

$$\sigma_{\text{max}} = 16.7 \left(\frac{8.40(1.5)}{\frac{1}{12}(4)(3^3)} \right) = 23.4 \text{ ksi} < \sigma_y \quad \text{OK}$$

From *Mechanics of Materials*, Sixth Edition by R. C. Hibbeler, ISBN 0-13-191345-X.

© 2005 R. C. Hibbeler. Published by Pearson Prentice Hall,

Pearson Education, Inc., Upper Saddle River, NJ. All rights reserved.

This material is protected under all copyright laws as they currently exist. No portion of this material may be reproduced, in any form or by any means, without permission in writing from the publisher.

14-70 The simply supported $W 10 \times 15$ structural A-36 steel beam lies in the horizontal plane and acts as a shock absorber for the 500-lb block which is traveling toward it at 5 ft/s. Determine the maximum deflection of the beam and the maximum stress in the beam during the impact. The spring has a stiffness of $k = 1000$ lb/in.

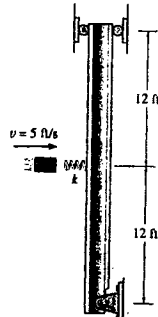

For $W 10 \times 15$: $I = 68.9 \text{ in}^4$ $d = 9.99 \text{ in.}$

From Appendix C :

$$\Delta_{\text{beam}} = \frac{PL^3}{48EI}$$

$$k_{\text{beam}} = \frac{48EI}{L^3} = \frac{48(29)(10^3)(68.9)}{(24(12))^3} = 4.015 \text{ kip/in.}$$

Equilibrium (equivalent system) :

$$F_{sp} = F_{\text{beam}}$$

$$k_{sp} \Delta_{sp} = k_{\text{beam}} \Delta_{\text{beam}}$$

$$\Delta_{sp} = \frac{4.015(10^3)}{1000} \Delta_{\text{beam}}$$

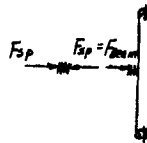

$$\Delta_{sp} = 4.015 \Delta_{\text{beam}} \quad (1)$$

Conservation of energy :

$$U_e = U_i$$

$$\frac{1}{2}mv^2 = \frac{1}{2}k_{\text{beam}} \Delta_{\text{beam}}^2 + \frac{1}{2}k_{sp} \Delta_{sp}^2$$

From Eq. (1) :

$$\frac{1}{2} \left(\frac{500}{32.2(12)} \right) (5(12))^2 = \frac{1}{2} (4.015)(10^3) \Delta_{\text{beam}}^2 + \frac{1}{2} (1000)(4.015 \Delta_{\text{beam}})^2$$

$$10067.6 \Delta_{\text{beam}}^2 = 2329.2$$

$$\Delta_{\text{beam}} = 0.481 \text{ in.} \quad \text{Ans}$$

$$F_{\text{beam}} = k_{\text{beam}} \Delta_{\text{beam}}$$

$$= 4.015(0.481) = 1.931 \text{ kip}$$

$$M_{\text{max}} = \left(\frac{1.931}{2} \right) (12)(12) = 139.05 \text{ kip} \cdot \text{in.}$$

$$\sigma_{\text{max}} = \frac{M_{\text{max}} c}{I} = \frac{139.05 \left(\frac{9.99}{2} \right)}{68.9} = 10.1 \text{ ksi} < \sigma_Y \quad \text{OK} \quad \text{Ans}$$

From *Mechanics of Materials*, Sixth Edition by R. C. Hibbeler, ISBN 0-13-191345-X.
 © 2005 R. C. Hibbeler. Published by Pearson Prentice Hall,
 Pearson Education, Inc., Upper Saddle River, NJ. All rights reserved.
 This material is protected under all copyright laws as they currently exist. No portion of this material may be reproduced, in any form or by any means, without permission in writing from the publisher.

14-71 Determine the horizontal displacement of point *B* on the two-member frame. Each A-36 steel member has a cross-sectional area of 2 in².

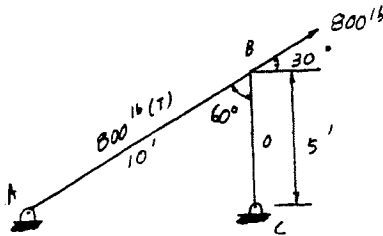
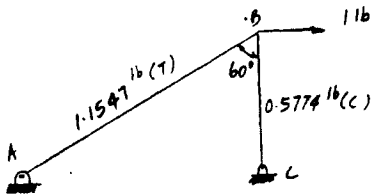
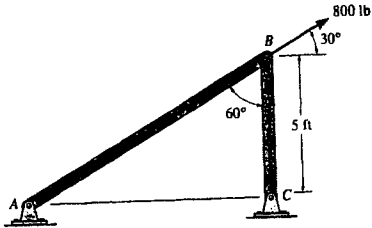

Member	<i>n</i>	<i>N</i>	<i>L</i>	<i>nNL</i>
AB	1.1547	800	120	11085.25
BC	-0.5774	0	60	0

$$\Sigma = 110\,851.25$$

$$1 \cdot \Delta_{B_h} = \Sigma \frac{nNL}{AE}$$

$$\Delta_{B_h} = \frac{110851.25}{AE} = \frac{110851.25}{29(10^6)(2)} = 0.00191 \text{ in.} \quad \text{Ans}$$

From *Mechanics of Materials*, Sixth Edition by R. C. Hibbeler, ISBN 0-13-191345-X.

© 2005 R. C. Hibbeler. Published by Pearson Prentice Hall,

Pearson Education, Inc., Upper Saddle River, NJ. All rights reserved.

This material is protected under all copyright laws as they currently exist. No portion of this material may be reproduced, in any form or by any means, without permission in writing from the publisher.

*14-72 Determine the horizontal displacement of point *B*.
 Each A-36 steel member has a cross-sectional area of 2 in².

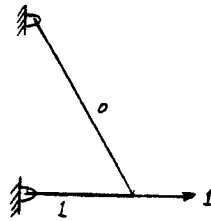
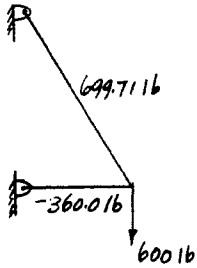
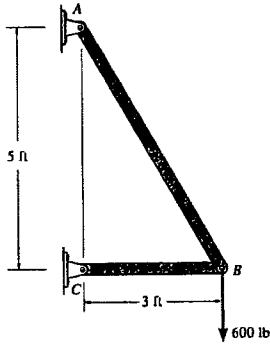

$$1 \cdot \Delta_{B_h} = \sum \frac{nNL}{AE}$$

$$\Delta_{B_h} = \frac{1(-360)(3)(12)}{2(29)(10^6)} = -0.223(10^{-3}) \text{ in.}$$

$$= 0.223(10^{-3}) \text{ in.} \leftarrow \text{Ans}$$

From *Mechanics of Materials*, Sixth Edition by R. C. Hibbeler, ISBN 0-13-191345-X.

© 2005 R. C. Hibbeler. Published by Pearson Prentice Hall,

Pearson Education, Inc., Upper Saddle River, NJ. All rights reserved.

This material is protected under all copyright laws as they currently exist. No portion of this material may be reproduced, in any form or by any means, without permission in writing from the publisher.

14-73 Determine the vertical displacement of point *B*.
 Each A-36 steel member has a cross-sectional area of 2 in².

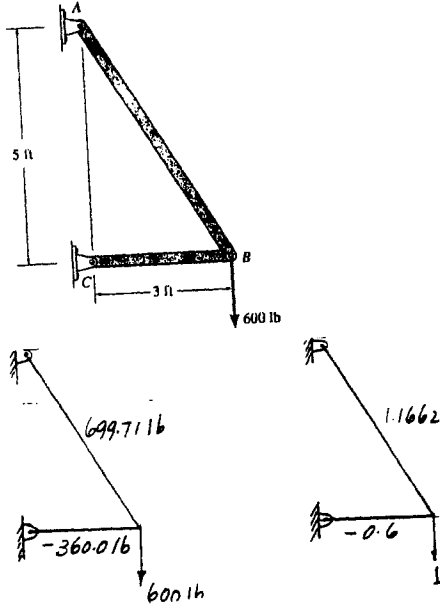

$$1 \cdot \Delta_{B_v} = \sum \frac{nNL}{AE}$$

$$\Delta_{B_v} = \frac{1.1662 (699.71)(5.831)(12)}{AE} + \frac{-0.60 (-360)(3)(12)}{AE}$$

$$= \frac{64872.807}{2 (29)(10^6)} = 0.00112 \text{ in. } \downarrow \quad \text{Ans}$$

From *Mechanics of Materials*, Sixth Edition by R. C. Hibbeler, ISBN 0-13-191345-X.

© 2005 R. C. Hibbeler. Published by Pearson Prentice Hall,

Pearson Education, Inc., Upper Saddle River, NJ. All rights reserved.

This material is protected under all copyright laws as they currently exist. No portion of this material may be reproduced, in any form or by any means, without permission in writing from the publisher.

14-74. Determine the vertical displacement of joint B of the truss. Each A-36 steel member has a cross-sectional area of 300 mm^2 .

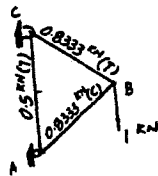
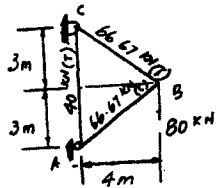
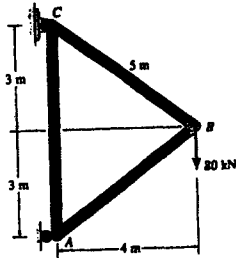

Member	n	N	L	nNL
AB	-0.8333	-66.67	5	277.78
BC	0.8333	66.67	5	277.78
AC	0.5	40	6	120.00
Σ				675.56

$$1 \cdot \Delta_B = \frac{\Sigma nNL}{AE}$$

$$\Delta_B = \frac{675.56(10^3)}{300(10^{-6})(200)(10^9)} = 0.01126 \text{ m} = 11.3 \text{ mm} \quad \text{Ans}$$

From *Mechanics of Materials*, Sixth Edition by R. C. Hibbeler, ISBN 0-13-191345-X.

© 2005 R. C. Hibbeler. Published by Pearson Prentice Hall,

Pearson Education, Inc., Upper Saddle River, NJ. All rights reserved.

This material is protected under all copyright laws as they currently exist. No portion of this material may be reproduced, in any form or by any means, without permission in writing from the publisher.

14-75. Determine the horizontal displacement of joint B of the truss. Each A-36 steel member has a cross-sectional area of 300 mm^2 .

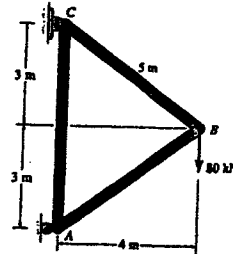

Member	n	N	L	nNL
AB	0.625	-66.67	5	-208.33
BC	0.625	66.67	5	208.33
AC	-0.375	40	6	-90.00

$$\Sigma = -90.00$$

$$1 \cdot \Delta_{B_x} = \Sigma \frac{nNL}{AE}$$

$$\Delta_{B_x} = \frac{-90(10^3)}{300(10^{-6})(200)(10^9)} = -1.50(10^{-3}) \text{ m} = -1.50 \text{ mm} = 1.50 \text{ mm} \leftarrow \text{Ans}$$

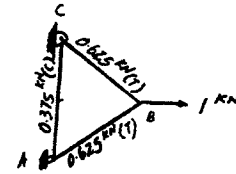
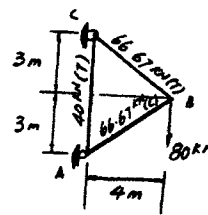

From *Mechanics of Materials*, Sixth Edition by R. C. Hibbeler, ISBN 0-13-191345-X.
 © 2005 R. C. Hibbeler. Published by Pearson Prentice Hall,
 Pearson Education, Inc., Upper Saddle River, NJ. All rights reserved.
 This material is protected under all copyright laws as they currently exist. No portion of this material may be reproduced, in any form or by any means, without permission in writing from the publisher.

*14-76 Determine the horizontal displacement of joint C on the truss. Each A-36 steel member has a cross-sectional area of 3 in².

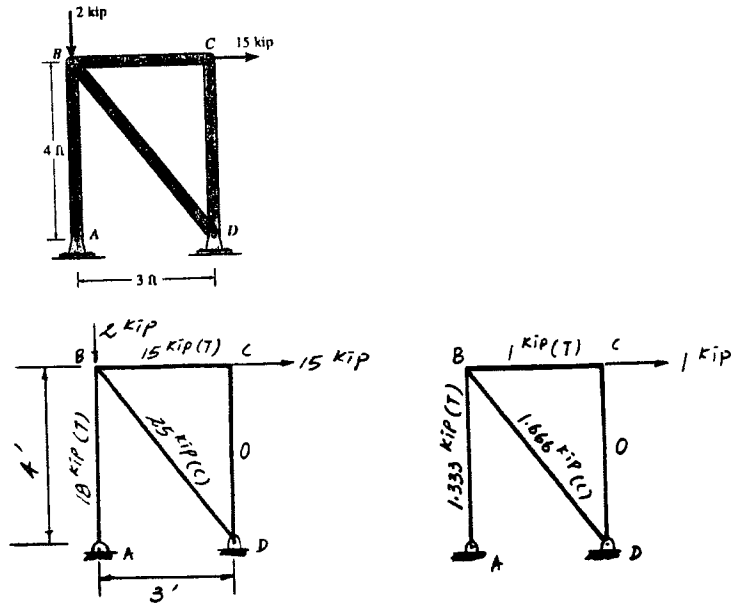

Member	n	N	L	nNL
AB	1.333	18.00	48	1152
BC	1.000	15.00	36	540
BD	-1.666	-25.00	60	2500
CD	0	0	48	0

$$\Sigma = 4192$$

$$1 \cdot \Delta_{C_x} = \frac{\Sigma nNL}{AE}$$

$$\Delta_{C_x} = \frac{4192}{(3)(29)(10^3)} = 0.0482 \text{ in.} \quad \text{Ans}$$

From *Mechanics of Materials*, Sixth Edition by R. C. Hibbeler, ISBN 0-13-191345-X.
 © 2005 R. C. Hibbeler. Published by Pearson Prentice Hall,
 Pearson Education, Inc., Upper Saddle River, NJ. All rights reserved.
 This material is protected under all copyright laws as they currently exist. No portion of this material may be reproduced, in any form or by any means, without permission in writing from the publisher.

14-77 Determine the horizontal displacement of joint *B* on the truss. Each A-36 steel member has a cross-sectional area of 3 in².

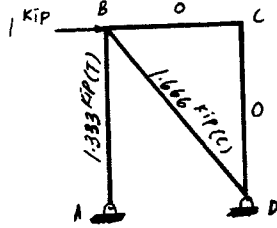
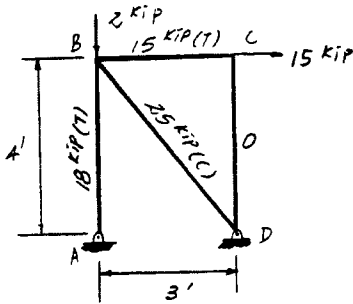
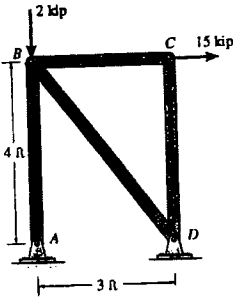

Member	<i>n</i>	<i>N</i>	<i>L</i> (in.)	<i>nNL</i>
AB	1.333	18.00	48	1152
BC	0	15.00	36	0
BD	-1.666	-25.00	60	2500
CD	0	0	48	0

$$\Sigma = 3652$$

$$1 \cdot \Delta_{B_h} = \frac{\Sigma nNL}{AE}$$

$$\Delta_{B_h} = \frac{3652}{(3)(29)(10^3)} = 0.0420 \text{ in.} \quad \text{Ans}$$

From *Mechanics of Materials*, Sixth Edition by R. C. Hibbeler, ISBN 0-13-191345-X.

© 2005 R. C. Hibbeler. Published by Pearson Prentice Hall,

Pearson Education, Inc., Upper Saddle River, NJ. All rights reserved.

This material is protected under all copyright laws as they currently exist. No portion of this material may be reproduced, in any form or by any means, without permission in writing from the publisher.

14-78. Determine the vertical displacement of joint B . For each A-36 steel member $A = 1.5 \text{ in}^2$.

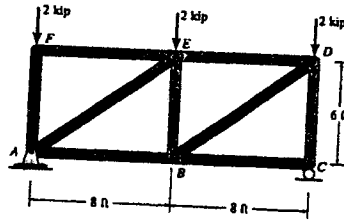

$$1 \cdot \Delta_B = \sum \frac{nNL}{AE}$$

$$\Delta_B = \frac{1}{AE} \{ (-1.667)(-0.8333)(10) + (1.667)(0.8333)(10) + (0.6667)(1.333)(8) + (-0.6667)(-1.333)(8) + (-1)(0.5)(6) + (-0.5)(-3)(6) \} (12)$$

$$= \frac{576}{1.5(29)(10^3)} = 0.0132 \text{ in.} \quad \text{Ans}$$

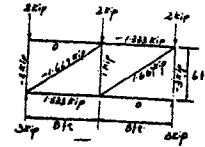
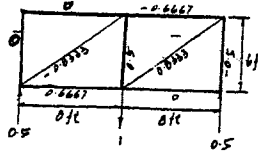

From *Mechanics of Materials*, Sixth Edition by R. C. Hibbeler, ISBN 0-13-191345-X.
 © 2005 R. C. Hibbeler. Published by Pearson Prentice Hall,
 Pearson Education, Inc., Upper Saddle River, NJ. All rights reserved.
 This material is protected under all copyright laws as they currently exist. No portion of this material may be reproduced, in any form or by any means, without permission in writing from the publisher.

14-79. Determine the vertical displacement of joint E . For each A-36 steel member $A = 1.5 \text{ in}^2$.

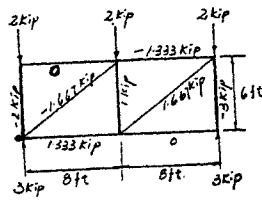
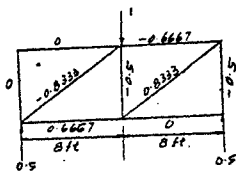
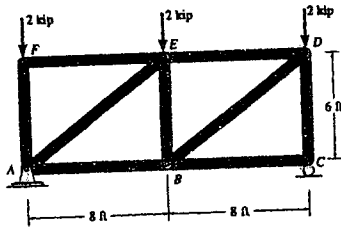

$$1 \cdot \Delta_E = \sum \frac{nNL}{AE}$$

$$\Delta_E = \frac{1}{AE} [(-1.667)(-0.833)(10) + (1.667)(0.8333)(10) + (0.667)(1.33)(8) + (-0.667)(-1.33)(8) + (-1)(-0.5)(6) + (-0.5)(-3)(6)](12)$$

$$= \frac{648}{1.5(29)(10^3)} = 0.0149 \text{ in.} \quad \text{Ans}$$

From *Mechanics of Materials*, Sixth Edition by R. C. Hibbeler, ISBN 0-13-191345-X.

© 2005 R. C. Hibbeler. Published by Pearson Prentice Hall,

Pearson Education, Inc., Upper Saddle River, NJ. All rights reserved.

This material is protected under all copyright laws as they currently exist. No portion of this material may be reproduced, in any form or by any means, without permission in writing from the publisher.

*14-80 Determine the vertical displacement of joint C on the truss. Each A-36 steel member has a cross-sectional area of $A = 300 \text{ mm}^2$.

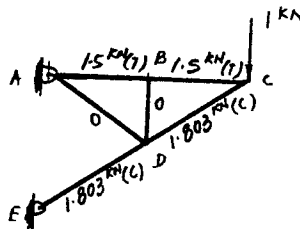
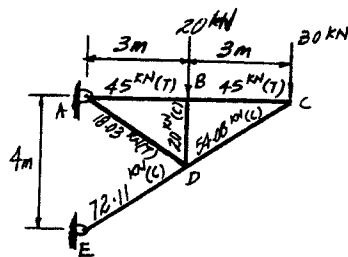
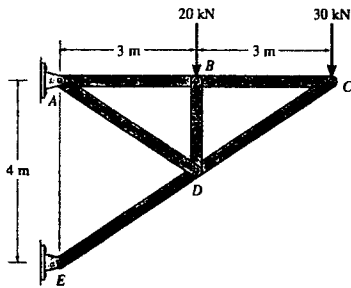

Member	n	N	L	nNL
AB	1.50	45.0	3	202.5
AD	0	18.03	$\sqrt{13}$	0
BC	1.50	45.0	3	202.5
BD	0	-20.0	2	0
CD	-1.803	-54.08	$\sqrt{13}$	351.56
DE	-1.803	-72.11	$\sqrt{13}$	468.77

$$\Sigma = 1225.33$$

$$1 \cdot \Delta_{C_v} = \Sigma \frac{nNL}{AE}$$

$$\Delta_{C_v} = \frac{1225.33(10^3)}{300(10^{-6})(200)(10^9)} = 0.0204 \text{ m} = 20.4 \text{ mm} \quad \text{Ans}$$

From *Mechanics of Materials*, Sixth Edition by R. C. Hibbeler, ISBN 0-13-191345-X.

© 2005 R. C. Hibbeler. Published by Pearson Prentice Hall,

Pearson Education, Inc., Upper Saddle River, NJ. All rights reserved.

This material is protected under all copyright laws as they currently exist. No portion of this material may be reproduced, in any form or by any means, without permission in writing from the publisher.

14-81 Determine the vertical displacement of joint D on the truss. Each A-36 steel member has a cross-sectional area of $A = 300 \text{ mm}^2$.

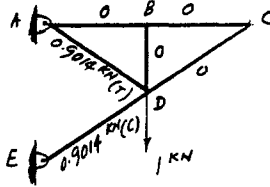
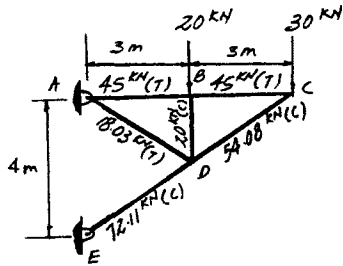
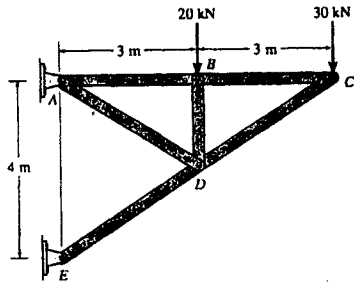

Member	n	N	L	nNL
AB	0	45.0	3	0
AD	0.9014	18.03	$\sqrt{13}$	58.60
BC	0	45.0	3	0
BD	0	-20.0	2	0
CD	0	-54.08	$\sqrt{13}$	0
DE	-0.9014	-72.11	$\sqrt{13}$	234.36

$$\Sigma = 292.96$$

$$1 \cdot \Delta_D = \Sigma \frac{nNL}{AE}$$

$$\Delta_D = \frac{292.96(10^3)}{300(10^{-6})(200)(10^9)} = 4.88(10^{-3}) \text{ m} = 4.88 \text{ mm} \quad \text{Ans}$$

From *Mechanics of Materials*, Sixth Edition by R. C. Hibbeler, ISBN 0-13-191345-X.

© 2005 R. C. Hibbeler. Published by Pearson Prentice Hall,

Pearson Education, Inc., Upper Saddle River, NJ. All rights reserved.

This material is protected under all copyright laws as they currently exist. No portion of this material may be reproduced, in any form or by any means, without permission in writing from the publisher.

14-82 Determine the horizontal displacement of joint *B* of the truss. Each A-36 steel member has a cross-sectional area of 400 mm².

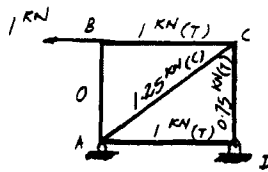
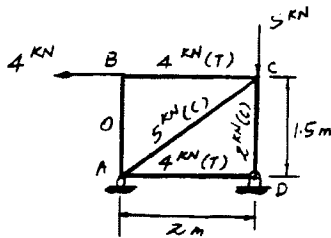
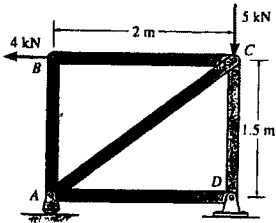

Member	<i>n</i>	<i>N</i>	<i>L</i>	<i>nNL</i>
<i>AB</i>	0	0	1.5	0
<i>AC</i>	-1.25	-5.00	2.5	15.625
<i>AD</i>	1.00	4.00	2.0	8.000
<i>BC</i>	1.00	4.00	2.0	8.000
<i>CD</i>	0.75	-2.00	1.5	-2.25

$$\Sigma = 29.375$$

$$1 \cdot \Delta_{B_x} = \Sigma \frac{nNL}{AE}$$

$$\Delta_{B_x} = \frac{29.375(10^3)}{400(10^{-6})(200)(10^9)} = 0.3672(10^{-3})\text{m} = 0.367 \text{ mm} \quad \text{Ans}$$

From *Mechanics of Materials*, Sixth Edition by R. C. Hibbeler, ISBN 0-13-191345-X.

© 2005 R. C. Hibbeler. Published by Pearson Prentice Hall,

Pearson Education, Inc., Upper Saddle River, NJ. All rights reserved.

This material is protected under all copyright laws as they currently exist. No portion of this material may be reproduced, in any form or by any means, without permission in writing from the publisher.

14-83 Determine the vertical displacement of joint C of the truss. Each A-36 steel member has a cross-sectional area of 400 mm².

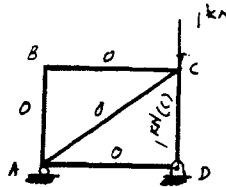
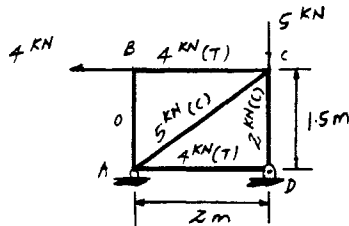
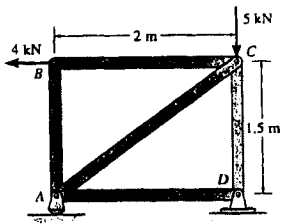

Member	n	N	L	nNL
AB	0	0	1.5	0
AC	0	-5.00	2.5	0
AD	0	4.00	2.0	0
BC	0	4.00	2.0	0
CD	-1.00	-2.00	1.5	3.00

$$\Sigma = 3.00$$

$$1 \cdot \Delta_{C_v} = \Sigma \frac{nNL}{AE}$$

$$\Delta_{C_v} = \frac{3.00 (10^3)}{400(10^{-6})(200)(10^9)} = 37.5(10^{-6})\text{m} = 0.0375 \text{ mm} \quad \text{Ans}$$

From *Mechanics of Materials*, Sixth Edition by R. C. Hibbeler, ISBN 0-13-191345-X.

© 2005 R. C. Hibbeler. Published by Pearson Prentice Hall,

Pearson Education, Inc., Upper Saddle River, NJ. All rights reserved.

This material is protected under all copyright laws as they currently exist. No portion of this material may be reproduced, in any form or by any means, without permission in writing from the publisher.

*14-84 Determine the vertical displacement of joint A. Each A-36 steel member has a cross-sectional area of 400 mm².

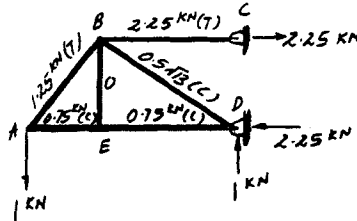
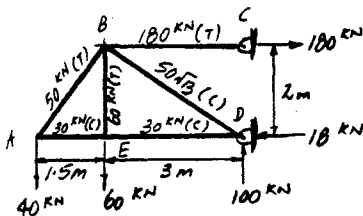
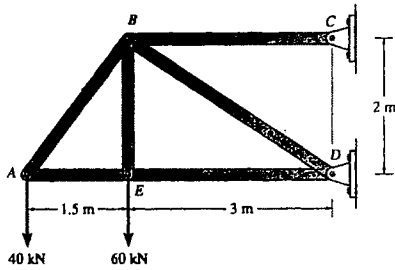

Member	n	N	L	nNL
AB	1.25	50	2.5	156.25
AE	-0.75	-30	1.5	33.75
BC	2.25	180	3.0	1215.00
BD	$-0.5\sqrt{13}$	$-50\sqrt{13}$	$\sqrt{13}$	1171.80
BE	0	60	2.0	0
DE	-0.75	-30	3.0	67.5

$$\Sigma = 2644.30$$

$$1 \cdot \Delta_A = \Sigma \frac{nNL}{AE}$$

$$\Delta_A = \frac{2644.30(10^3)}{400(10^{-6})(200)(10^9)} = 0.0331 \text{ m} = 33.1 \text{ mm} \quad \text{Ans}$$

From *Mechanics of Materials*, Sixth Edition by R. C. Hibbeler, ISBN 0-13-191345-X.

© 2005 R. C. Hibbeler. Published by Pearson Prentice Hall,

Pearson Education, Inc., Upper Saddle River, NJ. All rights reserved.

This material is protected under all copyright laws as they currently exist. No portion of this material may be reproduced, in any form or by any means, without permission in writing from the publisher.

14-85. Determine the vertical displacement of joint C. Each A-36 steel member has a cross-sectional area of 4.5 in².

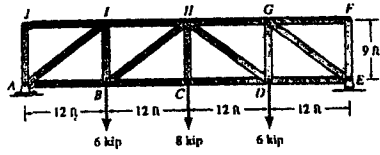

Member	n	N	L	nNL
AJ	0	0	108	0
AI	-0.67	-0.833	180	2540
AB	13.33	0.667	144	1280
BI	10.0	0.500	180	900
BM	-6.67	-0.333	180	1080
BC	18.67	1.333	144	3584
CM	8.00	1.00	108	864
CD	18.67	1.333	144	3584
DM	-6.67	-0.333	180	1080
DG	18.00	0.50	180	900
DE	13.33	0.667	144	1280
EG	-16.57	-0.833	180	2540
EF	0	0	108	0
FG	0	0	108	0
GH	-13.33	-0.667	144	1280
HT	-12.00	-0.667	144	1280

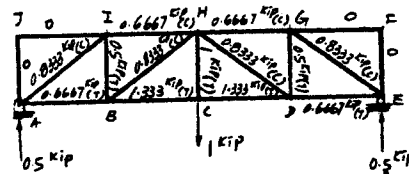
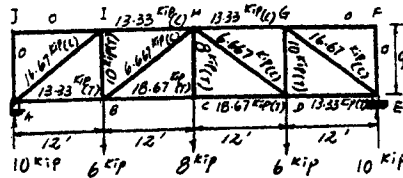

$$1 \cdot \Delta_C = \sum \frac{nNL}{AE}$$

$$\Delta_C = \frac{21232}{4.5 (29 (10^3))} = 0.163 \text{ in.} \quad \text{Ans}$$

From *Mechanics of Materials*, Sixth Edition by R. C. Hibbeler, ISBN 0-13-191345-X.

© 2005 R. C. Hibbeler. Published by Pearson Prentice Hall,

Pearson Education, Inc., Upper Saddle River, NJ. All rights reserved.

This material is protected under all copyright laws as they currently exist. No portion of this material may be reproduced, in any form or by any means, without permission in writing from the publisher.

14-86. Determine the vertical displacement of joint *H*. Each A-36 steel member has a cross-sectional area of 4.5 in².

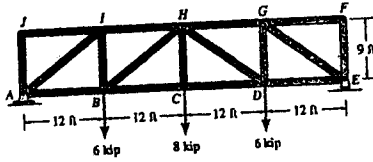

Member	<i>n</i>	<i>N</i>	<i>L</i>	<i>nNL</i>
AJ	0	0	108	0
AI	-16.67	-0.8333	180	2500
AB	13.33	0.6667	144	1280
BI	10.00	0.5000	108	540
BH	-6.67	-0.3333	180	1000
BC	18.67	1.3333	144	3584
CH	8.00	0	108	0
CD	18.67	1.3333	144	3580
DH	-6.67	-0.3333	180	1000
DG	18.00	0.5000	108	540
DE	13.33	0.6667	144	1280
EG	-16.67	-0.8333	180	2500
EF	0	0	108	0
FG	0	0	144	0
GH	-13.33	-0.6667	144	1280
HI	-13.33	-0.6667	144	1280
IJ	0	0	144	0

Σ 20368

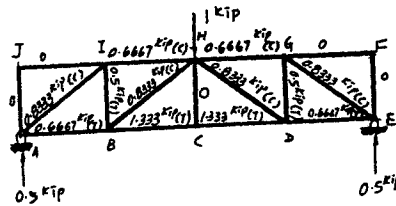
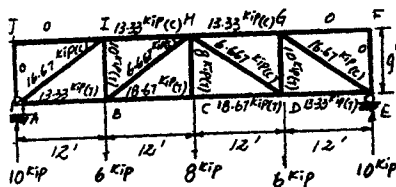

$$1 \cdot \Delta_H = \sum \frac{nNL}{AE}$$

$$\Delta_H = \frac{20368}{4.5 (29 (10^3))} = 0.156 \text{ in.} \quad \text{Ans}$$

From *Mechanics of Materials*, Sixth Edition by R. C. Hibbeler, ISBN 0-13-191345-X.
 © 2005 R. C. Hibbeler. Published by Pearson Prentice Hall,
 Pearson Education, Inc., Upper Saddle River, NJ. All rights reserved.
 This material is protected under all copyright laws as they currently exist. No portion of this material may be reproduced, in any form or by any means, without permission in writing from the publisher.

14-87. Determine the displacement at point C. EI is constant.

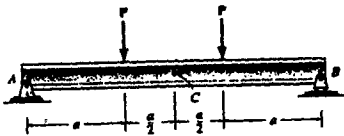

$$1 \cdot \Delta_C = \int_0^L \frac{mM}{EI} dx$$

$$\Delta_C = 2 \left(\frac{1}{EI} \right) \left[\int_0^a \left(\frac{1}{2} x_1 \right) (P x_1) dx_1 + \int_0^{a/2} \frac{1}{2} (a + x_2) (P a) dx_2 \right]$$

$$= \frac{23Pa^3}{24EI} \quad \text{Ans}$$

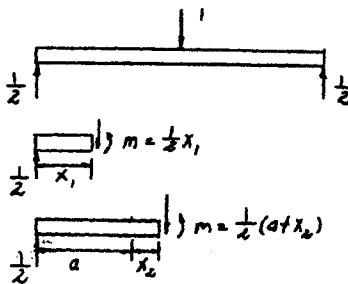
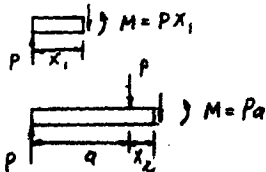

From *Mechanics of Materials*, Sixth Edition by R. C. Hibbeler, ISBN 0-13-191345-X.
 © 2005 R. C. Hibbeler. Published by Pearson Prentice Hall,
 Pearson Education, Inc., Upper Saddle River, NJ. All rights reserved.
 This material is protected under all copyright laws as they currently exist. No portion of this material may be reproduced, in any form or by any means, without permission in writing from the publisher.

*14-88 Determine the displacement at point C. EI is constant.

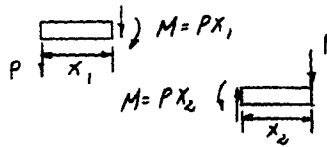
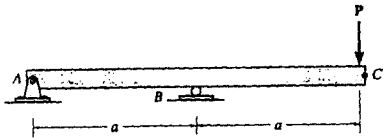

$$1 \cdot \Delta_C = \int_0^L \frac{mM}{EI} dx$$

$$\Delta_C = \frac{1}{EI} \left[\int_0^a (x_1)(Px_1) dx_1 + \int_0^a (x_2)(Px_2) dx_2 \right]$$

$$= \frac{2Pa^3}{3EI} \quad \text{Ans}$$

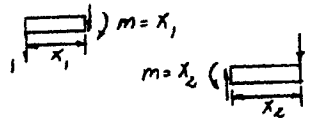
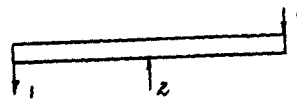

From *Mechanics of Materials*, Sixth Edition by R. C. Hibbeler, ISBN 0-13-191345-X.

© 2005 R. C. Hibbeler. Published by Pearson Prentice Hall,

Pearson Education, Inc., Upper Saddle River, NJ. All rights reserved.

This material is protected under all copyright laws as they currently exist. No portion of this material may be reproduced, in any form or by any means, without permission in writing from the publisher.

14-89 Determine the slope at point C. EI is constant.

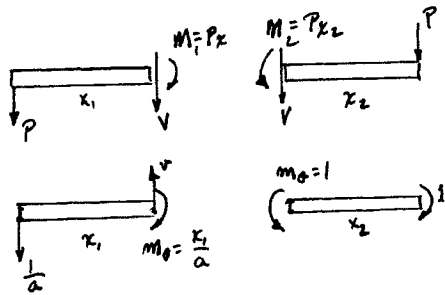

$$1. \theta_C = \int_0^L \frac{m_\theta M dx}{EI}$$

$$\theta_C = \int_0^a \frac{(\frac{x_1}{a})Px_1 dx_1}{EI} + \int_0^a \frac{(1)Px_2 dx_2}{EI}$$

$$= \frac{Pa^2}{3EI} + \frac{Pa^2}{2EI} = \frac{5Pa^2}{6EI} \quad \text{Ans}$$

From *Mechanics of Materials*, Sixth Edition by R. C. Hibbeler, ISBN 0-13-191345-X.

© 2005 R. C. Hibbeler. Published by Pearson Prentice Hall,

Pearson Education, Inc., Upper Saddle River, NJ. All rights reserved.

This material is protected under all copyright laws as they currently exist. No portion of this material may be reproduced, in any form or by any means, without permission in writing from the publisher.

14-90 Determine the slope at point A. EI is constant.

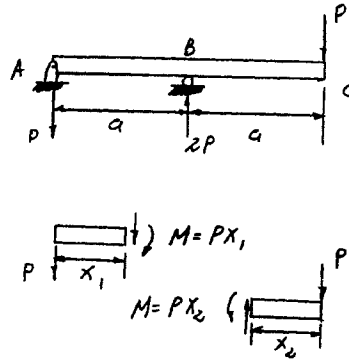
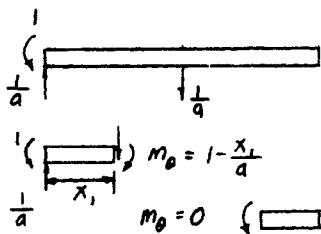
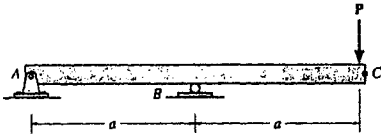

$$1. \theta_A = \int_0^L \frac{m_\theta M}{EI} dx$$

$$\theta_A = \frac{1}{EI} \left[\int_0^a \left(1 - \frac{x_1}{a}\right) (Px_1) dx_1 + \int_0^a (0) (Px_2) dx_2 \right] = \frac{Pa^2}{6EI} \quad \text{Ans}$$

From *Mechanics of Materials*, Sixth Edition by R. C. Hibbeler, ISBN 0-13-191345-X.

© 2005 R. C. Hibbeler. Published by Pearson Prentice Hall,

Pearson Education, Inc., Upper Saddle River, NJ. All rights reserved.

This material is protected under all copyright laws as they currently exist. No portion of this material may be reproduced, in any form or by any means, without permission in writing from the publisher.

14-91 Determine the displacement of point C of the beam made from A-36 steel and having a moment of inertia of $I = 53.8 \text{ in}^4$

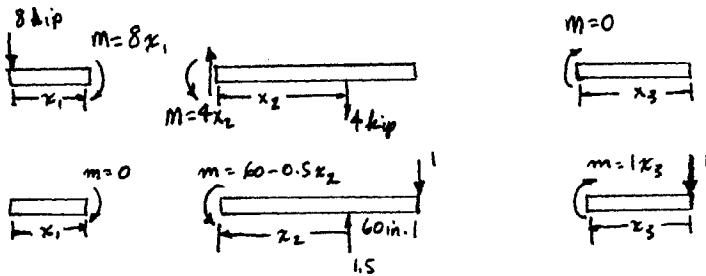
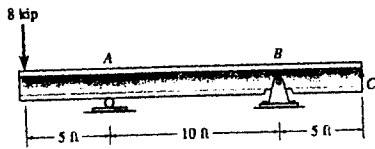

$$1 \cdot \Delta_C = \int_0^L \frac{mM}{EI} dx$$

$$\Delta_C = \frac{1}{EI} \left[0 + \int_0^{120} (60 - 0.5x_2)(4x_2) dx_2 + 0 \right]$$

$$= \frac{576\,000}{EI} = \frac{576\,000}{29(10^3)(53.8)} = 0.369 \text{ in.} \quad \text{Ans}$$

From *Mechanics of Materials*, Sixth Edition by R. C. Hibbeler, ISBN 0-13-191345-X.

© 2005 R. C. Hibbeler. Published by Pearson Prentice Hall,

Pearson Education, Inc., Upper Saddle River, NJ. All rights reserved.

This material is protected under all copyright laws as they currently exist. No portion of this material may be reproduced, in any form or by any means, without permission in writing from the publisher.

***14-92** Determine the slope at *B* of the beam made from A-36 steel and having a moment of inertia of $I = 53.8 \text{ in}^4$.

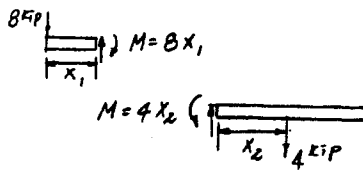
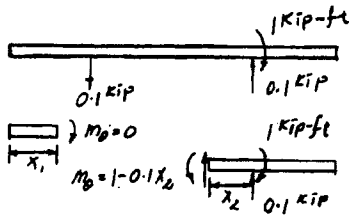
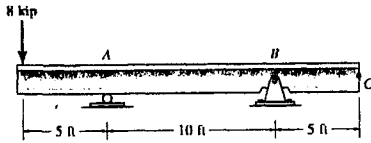

$$1 \cdot \theta_B = \int_0^L \frac{m_\theta M}{EI} dx$$

$$\theta_B = \frac{1}{EI} \left[\int_0^5 (0)(8x_1) dx_1 + \int_0^{10} (1 - 0.1x_2) 4x_2 dx_2 \right]$$

$$= \frac{66.67 \text{ kip} \cdot \text{ft}^2}{EI} = \frac{66.67(12^2)}{29(10^3)(53.8)} = 6.153(10^{-3}) \text{ rad} = 0.353^\circ \quad \text{Ans}$$

From *Mechanics of Materials*, Sixth Edition by R. C. Hibbeler, ISBN 0-13-191345-X.

© 2005 R. C. Hibbeler. Published by Pearson Prentice Hall,

Pearson Education, Inc., Upper Saddle River, NJ. All rights reserved.

This material is protected under all copyright laws as they currently exist. No portion of this material may be reproduced, in any form or by any means, without permission in writing from the publisher.

14-93. Determine the displacement of point C of the W14 × 26 beam made from A-36 steel.

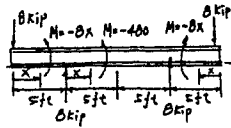
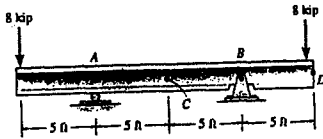

$$1 \cdot \Delta_C = \int_0^L \frac{m M}{EI} dx$$

$$\Delta_C = 0 + 2 \int_0^{60} \frac{(-\frac{x}{2})(-480)}{EI} dx$$

$$= \frac{864\,000}{29(10^3)(245)} = 0.122 \text{ in.} \quad \text{Ans}$$

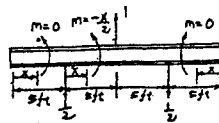

From *Mechanics of Materials*, Sixth Edition by R. C. Hibbeler, ISBN 0-13-191345-X.
 © 2005 R. C. Hibbeler. Published by Pearson Prentice Hall,
 Pearson Education, Inc., Upper Saddle River, NJ. All rights reserved.
 This material is protected under all copyright laws as they currently exist. No portion of this material may be reproduced, in any form or by any means, without permission in writing from the publisher.

14-94. Determine the slope at A of the W14 × 26 beam made from A-36 steel.

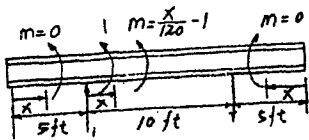
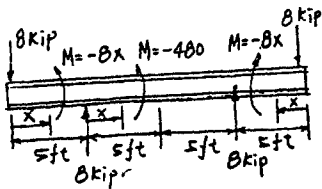
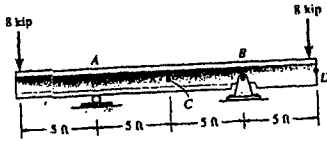

$$1 \cdot \theta_A = \int_0^L \frac{m_\theta M}{EI} dx$$

$$\theta_A = 0 + \int_0^{120} \frac{(\frac{x}{120} - 1)(-480)}{EI} dx$$

$$= \frac{28\,800}{29(10^3)(245)} = 4.05(10^{-3}) \text{ rad} \quad \text{Ans}$$

From *Mechanics of Materials*, Sixth Edition by R. C. Hibbeler, ISBN 0-13-191345-X.

© 2005 R. C. Hibbeler. Published by Pearson Prentice Hall,

Pearson Education, Inc., Upper Saddle River, NJ. All rights reserved.

This material is protected under all copyright laws as they currently exist. No portion of this material may be reproduced, in any form or by any means, without permission in writing from the publisher.

14-95 Determine the displacement at B of the 1.5-in.-diameter A-36 steel shaft.

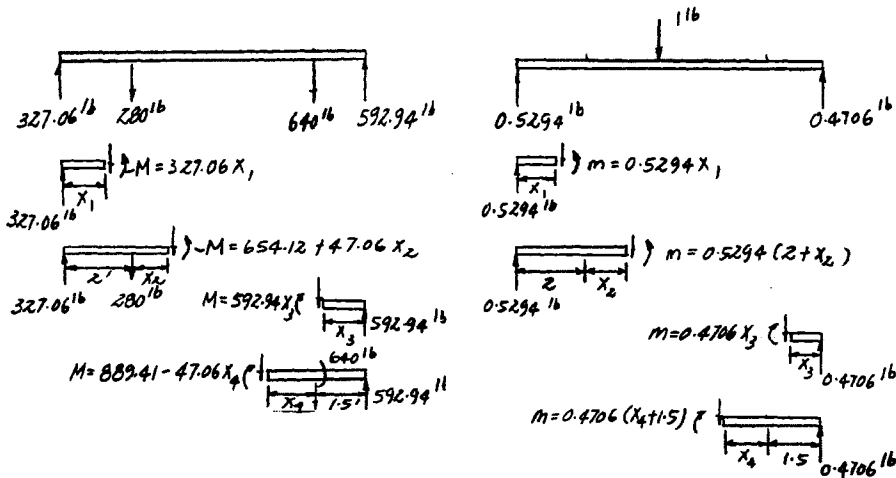
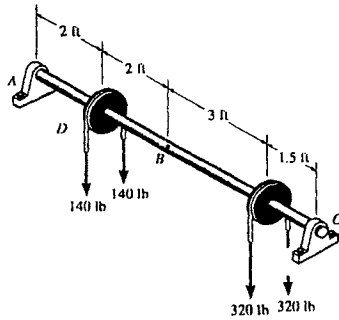

$$1 \cdot \Delta_B = \int_0^L \frac{mM}{EI} dx$$

$$\Delta_B = \frac{1}{EI} \left[\int_0^2 (0.5294x_1)(327.06x_1) dx_1 + \int_0^2 0.5294(2+x_1)(654.12 + 47.06x_2) dx_2 + \int_0^{1.5} (0.4706x_3)(592.94x_3) dx_3 + \int_0^3 0.4706(x_4 + 1.5)(889.41 - 47.06x_4) dx_4 \right]$$

$$= \frac{6437.67 \text{ lb} \cdot \text{ft}^3}{EI} = \frac{6437.67(12^3)}{29(10^6) \frac{\pi}{4} (0.75)^4} = 1.54 \text{ in.} \quad \text{Ans}$$

From *Mechanics of Materials*, Sixth Edition by R. C. Hibbeler, ISBN 0-13-191345-X.

© 2005 R. C. Hibbeler. Published by Pearson Prentice Hall,

Pearson Education, Inc., Upper Saddle River, NJ. All rights reserved.

This material is protected under all copyright laws as they currently exist. No portion of this material may be reproduced, in any form or by any means, without permission in writing from the publisher.

•14-96 Determine the slope of the 1.5-in-diameter A-36 steel shaft at the bearing support A.

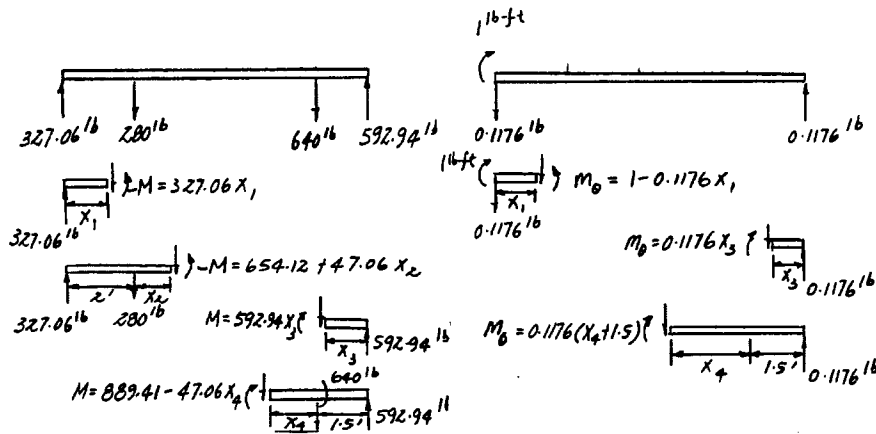
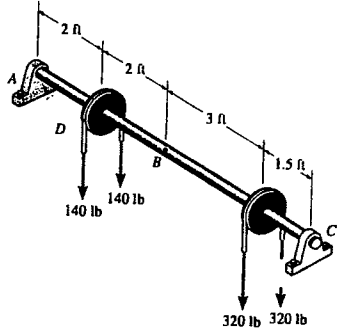

$$\begin{aligned} \theta_A &= \int_0^L \frac{m_\theta M}{EI} dx \\ \theta_A &= \frac{1}{EI} \left[\int_0^2 (1 - 0.1176x_1)(327.06x_1) dx_1 + \int_0^{1.5} (0.1176x_3)(592.94x_3) dx_3 \right. \\ &\quad \left. + \int_0^5 0.1176(x_4 + 1.5)(889.41 - 47.06x_4) dx_4 \right] \\ &= \frac{2387.53 \text{ lb} \cdot \text{ft}^2}{EI} = \frac{2387.53(12^2)}{29(10^6)(\frac{\pi}{4})(0.75^4)} = 0.0477 \text{ rad} = 2.73^\circ \quad \text{Ans} \end{aligned}$$

From *Mechanics of Materials*, Sixth Edition by R. C. Hibbeler, ISBN 0-13-191345-X.

© 2005 R. C. Hibbeler. Published by Pearson Prentice Hall,

Pearson Education, Inc., Upper Saddle River, NJ. All rights reserved.

This material is protected under all copyright laws as they currently exist. No portion of this material may be reproduced, in any form or by any means, without permission in writing from the publisher.

14-97 Determine the displacement at pulley *B*. The A-36 steel shaft has a diameter of 30 mm.

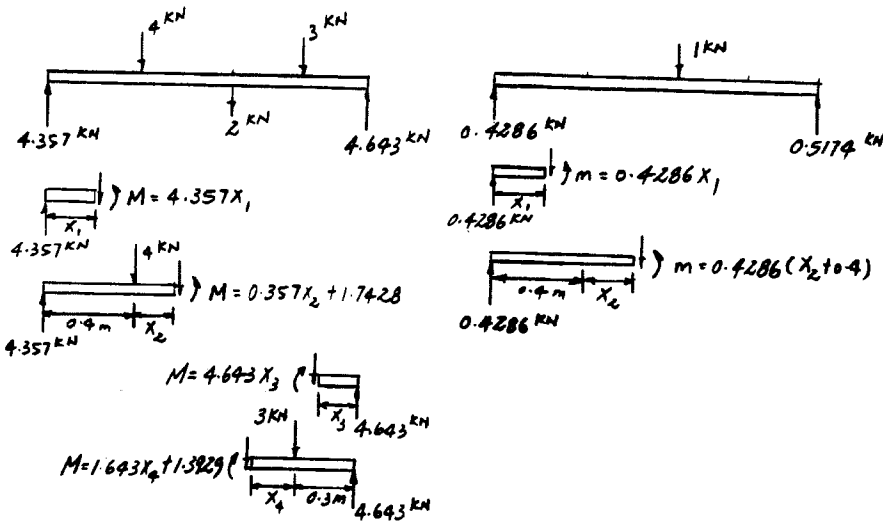
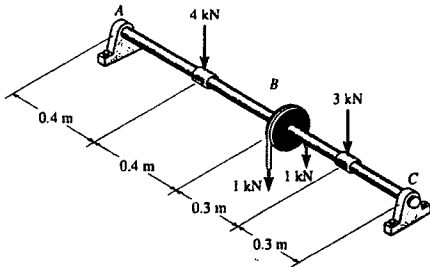

$$1 \cdot \Delta_B = \int_0^L \frac{mM}{EI} dx$$

$$\Delta_B = \frac{1}{EI} \left[\int_0^{0.4} (0.4286x_1)(4.357x_1) dx_1 + \int_0^{0.4} 0.4286(x_2 + 0.4)(0.357x_2 + 1.7428) dx_2 \right. \\ \left. + \int_0^{0.3} (0.5714x_3)(4.643x_3) dx_3 + \int_0^{0.3} 0.5714(x_4 + 0.3)(1.643x_4 + 1.3929) dx_4 \right]$$

$$= \frac{0.37972 \text{ kN} \cdot \text{m}^3}{EI} = \frac{0.37972(10^3)}{200(10^9)(\frac{\pi}{4})(0.015^4)} = 0.0478 \text{ m} = 47.8 \text{ mm} \quad \text{Ans}$$

From *Mechanics of Materials*, Sixth Edition by R. C. Hibbeler, ISBN 0-13-191345-X.

© 2005 R. C. Hibbeler. Published by Pearson Prentice Hall,

Pearson Education, Inc., Upper Saddle River, NJ. All rights reserved.

This material is protected under all copyright laws as they currently exist. No portion of this material may be reproduced, in any form or by any means, without permission in writing from the publisher.

14-98 The simply supported beam having a square cross section is subjected to a uniform load w . Determine the maximum deflection of the beam caused only by bending, and caused by bending and shear. Take $E = 3G$.

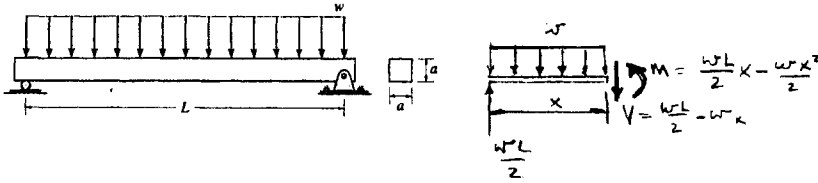

For bending and shear,

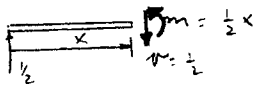

$$1 \cdot \Delta = \int_0^L \frac{mM}{EI} dx + \int_0^L \frac{f_s v V}{GA} dx$$

$$\Delta = 2 \int_0^{L/2} \frac{(\frac{1}{2}x)(\frac{wL}{2}x - \frac{wx^2}{2}) dx}{EI} + 2 \int_0^{L/2} \frac{(\frac{6}{5})(\frac{1}{2})(\frac{wL}{2} - wx) dx}{GA}$$

$$= \frac{1}{EI} \left(\frac{wL}{6} x^3 - \frac{wx^4}{8} \right) \Big|_0^{L/2} + \frac{(\frac{6}{5})}{GA} \left(\frac{wL}{2} x - \frac{wx^2}{2} \right) \Big|_0^{L/2}$$

$$= \frac{5wL^4}{384EI} + \frac{3wL^2}{20GA}$$

$$\Delta = \frac{5wL^4}{384(3G)(\frac{1}{12})a^4} + \frac{3wL^2}{20(G)a^2}$$

$$= \frac{20wL^4}{384Ga^4} + \frac{3wL^2}{20Ga^2}$$

$$= \left(\frac{w}{G} \right) \left(\frac{L}{a} \right)^2 \left[\left(\frac{20}{384} \right) \left(\frac{L}{a} \right)^2 + \frac{3}{20} \right] \quad \text{Ans}$$

For bending only,

$$\Delta = \frac{5w}{96G} \left(\frac{L}{a} \right)^4 \quad \text{Ans.}$$

From *Mechanics of Materials*, Sixth Edition by R. C. Hibbeler, ISBN 0-13-191345-X.

© 2005 R. C. Hibbeler. Published by Pearson Prentice Hall,

Pearson Education, Inc., Upper Saddle River, NJ. All rights reserved.

This material is protected under all copyright laws as they currently exist. No portion of this material may be reproduced, in any form or by any means, without permission in writing from the publisher.

14-99. Determine the displacement at point C. EI is constant.

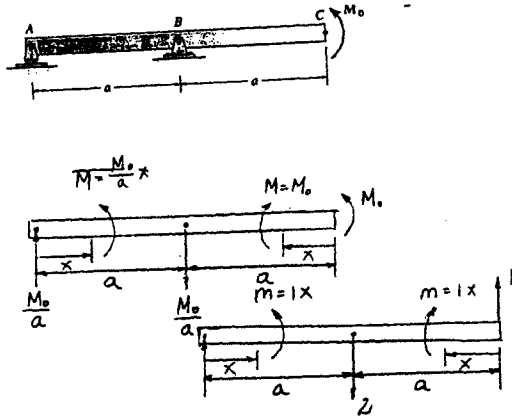

$$1 \cdot \Delta_C = \int_0^L \frac{mM}{EI} dx$$

$$\Delta_C = \int_0^a \frac{(1x)\left(\frac{M_0}{a}x\right)}{EI} dx + \int_0^a \frac{(1x)M_0}{EI} dx$$

$$= \frac{5M_0 a^2}{6EI} \quad \text{Ans}$$

From *Mechanics of Materials*, Sixth Edition by R. C. Hibbeler, ISBN 0-13-191345-X.

© 2005 R. C. Hibbeler. Published by Pearson Prentice Hall,

Pearson Education, Inc., Upper Saddle River, NJ. All rights reserved.

This material is protected under all copyright laws as they currently exist. No portion of this material may be reproduced, in any form or by any means, without permission in writing from the publisher.

*14-100. Determine the slope at B . EI is constant.

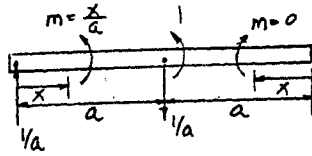
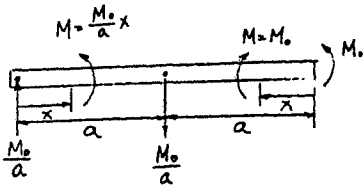
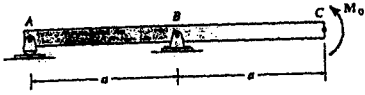

$$\begin{aligned}
 1 \cdot \theta_B &= \int_0^L \frac{m_\theta M}{EI} dx \\
 \theta_B &= \int_0^a \frac{(\frac{1}{a}) (\frac{M_0}{a} x)}{EI} dx \\
 &= \frac{M_0 a}{3EI} \quad \text{Ans}
 \end{aligned}$$

From *Mechanics of Materials*, Sixth Edition by R. C. Hibbeler, ISBN 0-13-191345-X.

© 2005 R. C. Hibbeler. Published by Pearson Prentice Hall,

Pearson Education, Inc., Upper Saddle River, NJ. All rights reserved.

This material is protected under all copyright laws as they currently exist. No portion of this material may be reproduced, in any form or by any means, without permission in writing from the publisher.

14-101. The A-36 steel beam has a moment of inertia of $I = 125(10^6) \text{ mm}^4$. Determine the displacement at D .

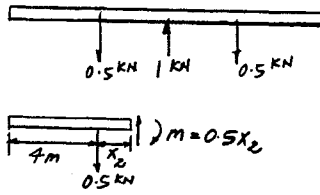
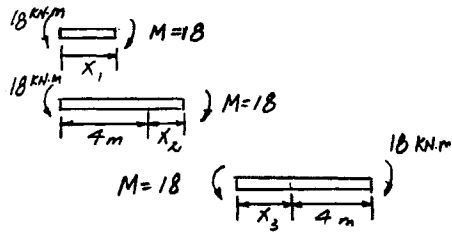
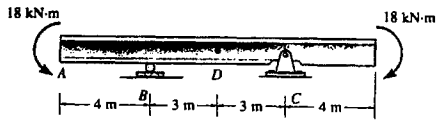

$$1 \cdot \Delta_D = \int_0^L \frac{mM}{EI} dx$$

$$\Delta_D = (2) \frac{1}{EI} \left[\int_0^3 (0.5x_2)(18) dx_2 \right] = \frac{81 \text{ kN} \cdot \text{m}^3}{EI} = \frac{81(10^3)}{200(10^9)(125)(10^{-6})}$$

$$= 3.24(10^{-3}) = 3.24 \text{ mm} \quad \text{Ans}$$

From *Mechanics of Materials*, Sixth Edition by R. C. Hibbeler, ISBN 0-13-191345-X.

© 2005 R. C. Hibbeler. Published by Pearson Prentice Hall,

Pearson Education, Inc., Upper Saddle River, NJ. All rights reserved.

This material is protected under all copyright laws as they currently exist. No portion of this material may be reproduced, in any form or by any means, without permission in writing from the publisher.

14-102 The A-36 steel beam has a moment of inertia of $I = 125(10^6) \text{ mm}^4$. Determine the slope at A.

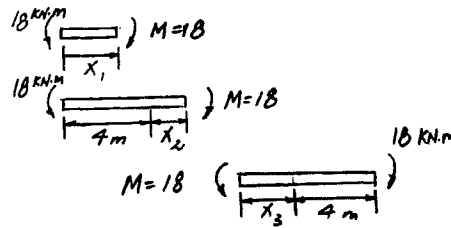
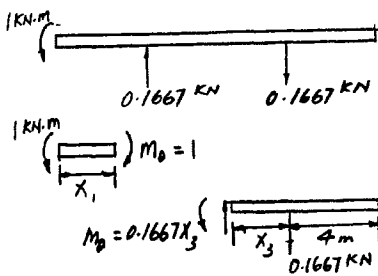
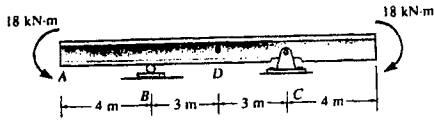

$$1. \theta_A = \int_0^L \frac{m_\theta M}{EI} dx$$

$$\theta_A = \frac{1}{EI} \left[\int_0^4 (1)(18)(dx_1) + \int_0^6 (0.1667x_3)(18)dx_3 \right] = \frac{126 \text{ kN} \cdot \text{m}^2}{EI}$$

$$= \frac{126(10^3)}{200(10^9)(125)(10^{-6})} = 5.04(10^{-3}) \text{ rad} = 0.289^\circ \quad \text{Ans}$$

From *Mechanics of Materials*, Sixth Edition by R. C. Hibbeler, ISBN 0-13-191345-X.

© 2005 R. C. Hibbeler. Published by Pearson Prentice Hall,

Pearson Education, Inc., Upper Saddle River, NJ. All rights reserved.

This material is protected under all copyright laws as they currently exist. No portion of this material may be reproduced, in any form or by any means, without permission in writing from the publisher.

14-103 The A-36 structural steel beam has a moment of inertia of $I = 125(10^6)$ mm⁴. Determine the slope of the beam at B.

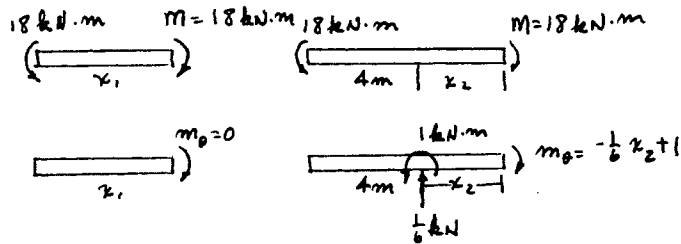
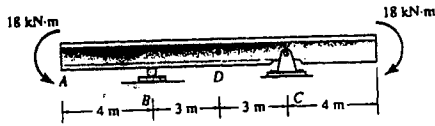

$$\begin{aligned} \theta_B &= \int_0^L \frac{m_\theta M}{EI} dx \\ \theta_B &= 0 + \frac{1}{EI} \int_0^6 \frac{(-\frac{1}{6}x_2 + 1)(18) dx}{EI} \\ &= \frac{54}{EI} = \frac{54(10^3)}{200(10^9)(125(10^{-6}))} = 0.00216 \text{ rad} = 0.124^\circ \quad \text{Ans.} \end{aligned}$$

From *Mechanics of Materials*, Sixth Edition by R. C. Hibbeler, ISBN 0-13-191345-X.

© 2005 R. C. Hibbeler. Published by Pearson Prentice Hall,

Pearson Education, Inc., Upper Saddle River, NJ. All rights reserved.

This material is protected under all copyright laws as they currently exist. No portion of this material may be reproduced, in any form or by any means, without permission in writing from the publisher.

*14-104 Determine the slope at A. EI is constant.

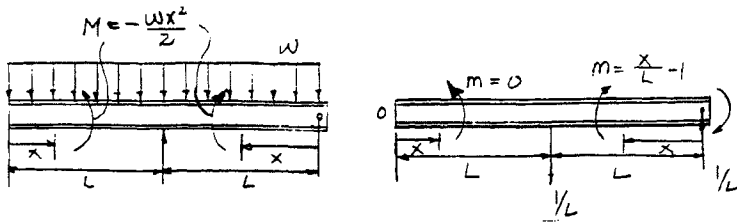
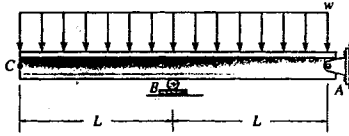

$$\theta_A = \int_0^L \frac{m_\theta M}{EI} dx$$

$$= 0 + \int_0^L \frac{(\frac{x}{L} - 1) (-\frac{wx^2}{2})}{EI} dx$$

$$= \frac{-\frac{wL^4}{8L} + \frac{wL^3}{6}}{EI} = \frac{wL^3}{24EI}$$

Ans

From *Mechanics of Materials*, Sixth Edition by R. C. Hibbeler, ISBN 0-13-191345-X.

© 2005 R. C. Hibbeler. Published by Pearson Prentice Hall,

Pearson Education, Inc., Upper Saddle River, NJ. All rights reserved.

This material is protected under all copyright laws as they currently exist. No portion of this material may be reproduced, in any form or by any means, without permission in writing from the publisher.

14-105 Determine the displacement at C. EI is constant.

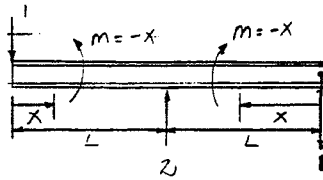
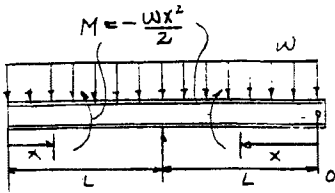
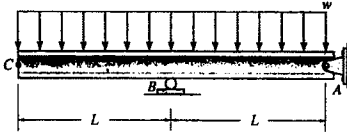

$$\Delta_C = \int_0^L \frac{m M}{EI} dx$$

$$= 2 \int_0^L \frac{(-lx) \left(\frac{-wx^2}{2} \right)}{EI} dx$$

$$= 2 \frac{w}{2EI} \left(\frac{L^4}{4} \right) = \frac{wL^4}{4EI}$$

Ans

From *Mechanics of Materials*, Sixth Edition by R. C. Hibbeler, ISBN 0-13-191345-X.

© 2005 R. C. Hibbeler. Published by Pearson Prentice Hall,

Pearson Education, Inc., Upper Saddle River, NJ. All rights reserved.

This material is protected under all copyright laws as they currently exist. No portion of this material may be reproduced, in any form or by any means, without permission in writing from the publisher.

14-106 Determine the slope at B . EI is constant.

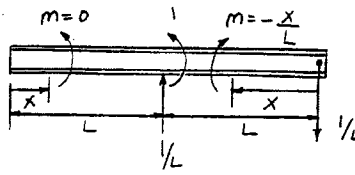
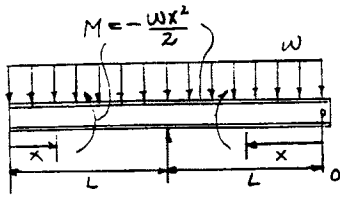
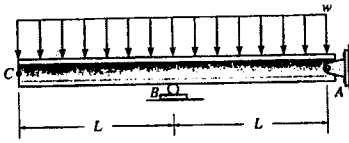

$$\begin{aligned} \theta_B &= \int_0^L \frac{m_\theta M}{EI} dx \\ &= \int_0^L \frac{(\frac{x}{L})(\frac{-wx^2}{2})}{EI} dx \\ &= \frac{wL^4}{8LEI} = \frac{wL^3}{8EI} \end{aligned}$$

Ans

From *Mechanics of Materials*, Sixth Edition by R. C. Hibbeler, ISBN 0-13-191345-X.

© 2005 R. C. Hibbeler. Published by Pearson Prentice Hall,

Pearson Education, Inc., Upper Saddle River, NJ. All rights reserved.

This material is protected under all copyright laws as they currently exist. No portion of this material may be reproduced, in any form or by any means, without permission in writing from the publisher.

14-107 The beam is made of southern pine for which $E_p = 13 \text{ GPa}$. Determine the displacement at A.

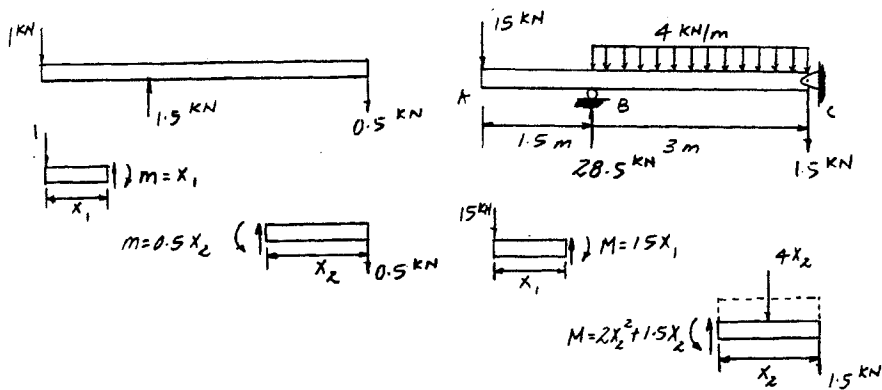
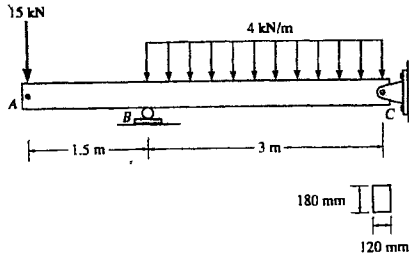

$$1 \cdot \Delta_A = \int_0^L \frac{mM}{EI}$$

$$\Delta_A = \frac{1}{EI} \left[\int_0^{1.5} (x_1)(15x_1) dx_1 + \int_0^3 (0.5x_2)(2x_2^2 + 1.5x_2) dx_2 \right]$$

$$= \frac{43.875 \text{ kN} \cdot \text{m}^3}{EI} = \frac{43.875(10^3)}{13(10^9) \left(\frac{1}{12}\right)(0.12)(0.18)^3} = 0.0579 \text{ m} = 57.9 \text{ mm} \quad \text{Ans}$$

From *Mechanics of Materials*, Sixth Edition by R. C. Hibbeler, ISBN 0-13-191345-X.

© 2005 R. C. Hibbeler. Published by Pearson Prentice Hall,

Pearson Education, Inc., Upper Saddle River, NJ. All rights reserved.

This material is protected under all copyright laws as they currently exist. No portion of this material may be reproduced, in any form or by any means, without permission in writing from the publisher.

*14-108 Determine the displacement at B . EI is constant.

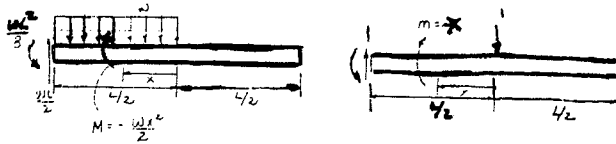
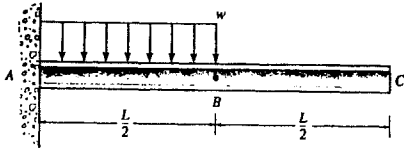

$$1 \cdot \Delta_B = \int_0^L \frac{m M}{EI} dx$$

$$\Delta_B = \int_0^{\frac{L}{2}} \frac{(-1/x)(-w x^2/2)}{EI} dx = \frac{w (\frac{L}{2})^4}{8 EI}$$

$$= \frac{w L^4}{128 EI} \quad \text{Ans}$$

From *Mechanics of Materials*, Sixth Edition by R. C. Hibbeler, ISBN 0-13-191345-X.

© 2005 R. C. Hibbeler. Published by Pearson Prentice Hall,

Pearson Education, Inc., Upper Saddle River, NJ. All rights reserved.

This material is protected under all copyright laws as they currently exist. No portion of this material may be reproduced, in any form or by any means, without permission in writing from the publisher.

14-109 Determine the slope and displacement at point C. EI is constant.

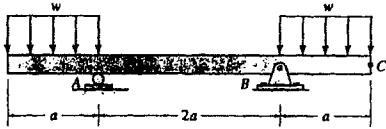

$$\theta_C = \int_0^L \frac{m_\theta M}{EI} dx$$

$$= \frac{1}{EI} \left[\int_0^a (0) \left(\frac{wx_1^2}{2} \right) dx_1 + \int_0^a (1) \left(\frac{wx_2^2}{2} \right) dx_2 \right.$$

$$\left. + \int_0^{2a} \left(1 - \frac{x_3}{2a} \right) \left(\frac{wa^2}{2} \right) dx_3 \right]$$

$$= \frac{2wa^3}{3EI} \quad \text{Ans}$$

$$\Delta_C = \int_0^L \frac{m M}{EI} dx$$

$$= \frac{1}{EI} \left[\int_0^a (0) \left(\frac{wx_1^2}{2} \right) dx_1 + \int_0^a (x_2) \left(\frac{wx_2^2}{2} \right) dx_2 \right.$$

$$\left. + \int_0^{2a} \left(a - \frac{x_3}{2} \right) \left(\frac{wa^2}{2} \right) dx_3 \right]$$

$$= \frac{5wa^4}{8EI} \quad \text{Ans}$$

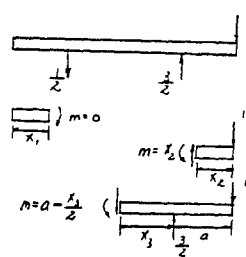
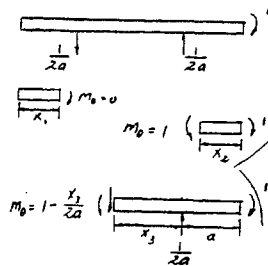
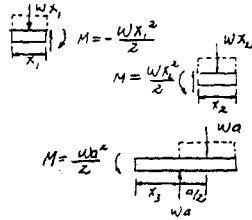

From *Mechanics of Materials*, Sixth Edition by R. C. Hibbeler, ISBN 0-13-191345-X.

© 2005 R. C. Hibbeler. Published by Pearson Prentice Hall,

Pearson Education, Inc., Upper Saddle River, NJ. All rights reserved.

This material is protected under all copyright laws as they currently exist. No portion of this material may be reproduced, in any form or by any means, without permission in writing from the publisher.

14-110 Determine the displacement of the shaft at C. EI is constant.

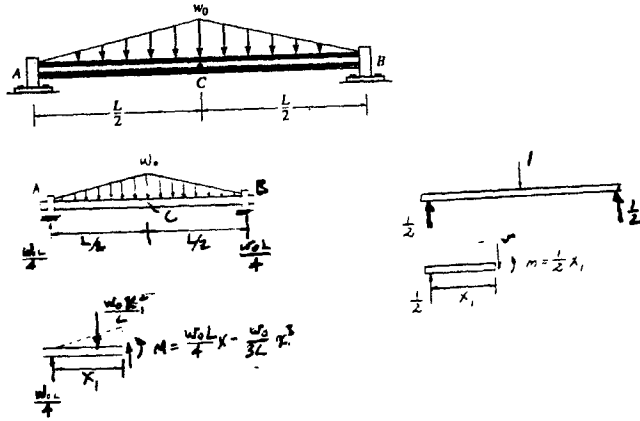

$$1 \cdot \Delta_C = \int_0^L \frac{m M}{EI} dx$$

$$\Delta_C = 2 \left(\frac{1}{EI} \right) \int_0^{L/2} \left(\frac{1}{2} x_1 \right) \left(\frac{w_0 L}{4} x_1 - \frac{w_0}{3L} x_1^3 \right) dx_1$$

$$= \frac{w_0 L^4}{120 EI} \quad \text{Ans}$$

From *Mechanics of Materials*, Sixth Edition by R. C. Hibbeler, ISBN 0-13-191345-X.

© 2005 R. C. Hibbeler. Published by Pearson Prentice Hall,

Pearson Education, Inc., Upper Saddle River, NJ. All rights reserved.

This material is protected under all copyright laws as they currently exist. No portion of this material may be reproduced, in any form or by any means, without permission in writing from the publisher.

14-111 Determine the slope of the shaft at the bearing support A. EI is constant.

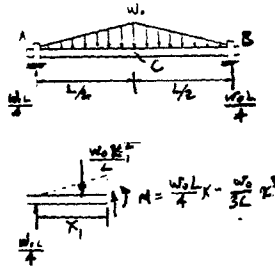
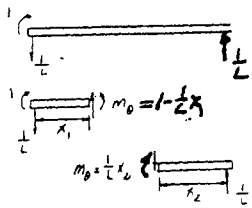
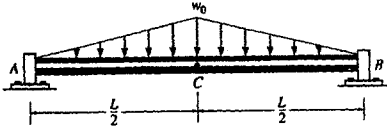

$$1 \cdot \theta_A = \int_0^L \frac{m_\theta M}{EI} dx$$

$$\theta_A = \frac{1}{EI} \left[\int_0^{\frac{L}{2}} \left(1 - \frac{1}{L}x_1\right) \left(\frac{w_0 L}{4}x_1 - \frac{w_0}{3L}x_1^3\right) dx_1 \right.$$

$$\left. + \int_0^{\frac{L}{2}} \left(\frac{1}{L}x_2\right) \left(-\frac{w_0 L}{4}x_2 - \frac{w_0}{3L}x_2^3\right) dx_2 \right]$$

$$= \frac{5 w_0 L^3}{192 EI} \quad \text{Ans}$$

From *Mechanics of Materials*, Sixth Edition by R. C. Hibbeler, ISBN 0-13-191345-X.

© 2005 R. C. Hibbeler. Published by Pearson Prentice Hall,

Pearson Education, Inc., Upper Saddle River, NJ. All rights reserved.

This material is protected under all copyright laws as they currently exist. No portion of this material may be reproduced, in any form or by any means, without permission in writing from the publisher.

*14-112 Determine the vertical displacement of point A on the angle bracket due to the concentrated force P. The bracket is fixed connected to its support. EI is constant. Consider only the effect of bending.

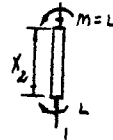
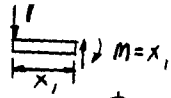
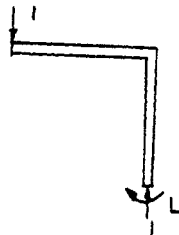
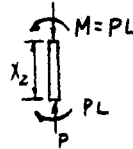
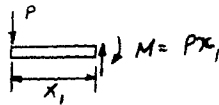
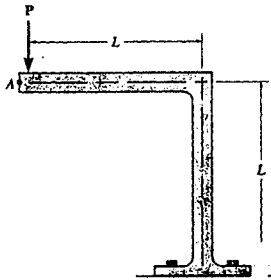

$$\begin{aligned}
 1 \cdot \Delta_{A_v} &= \int_0^L \frac{mM}{EI} dx \\
 \Delta_{A_v} &= \frac{1}{EI} \left[\int_0^L (x_1)(Px_1) dx_1 + \int_0^L (1L)(PL) dx_2 \right] \\
 &= \frac{4PL^3}{3EI} \quad \text{Ans}
 \end{aligned}$$

From *Mechanics of Materials*, Sixth Edition by R. C. Hibbeler, ISBN 0-13-191345-X.

© 2005 R. C. Hibbeler. Published by Pearson Prentice Hall,

Pearson Education, Inc., Upper Saddle River, NJ. All rights reserved.

This material is protected under all copyright laws as they currently exist. No portion of this material may be reproduced, in any form or by any means, without permission in writing from the publisher.

14-113. The L-shaped frame is made from two segments, each of length L and flexural stiffness EI . If it is subjected to the uniform distributed load, determine the horizontal displacement of the end C.

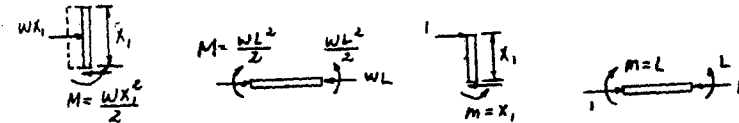
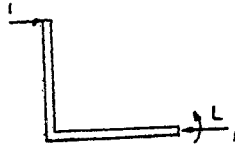
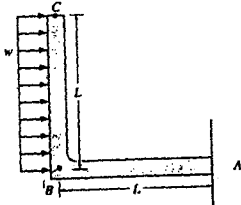

$$1 \cdot \Delta_{c_1} = \int_0^L \frac{mM}{EI} dx$$

$$\Delta_{c_1} = \frac{1}{EI} \left[\int_0^L (1x_1) \left(\frac{wx_1^2}{2} \right) dx_1 + \int_0^L (1L) \left(\frac{wL^2}{2} \right) dx_2 \right]$$

$$= \frac{5wL^4}{8EI} \quad \text{Ans}$$

From *Mechanics of Materials*, Sixth Edition by R. C. Hibbeler, ISBN 0-13-191345-X.

© 2005 R. C. Hibbeler. Published by Pearson Prentice Hall,

Pearson Education, Inc., Upper Saddle River, NJ. All rights reserved.

This material is protected under all copyright laws as they currently exist. No portion of this material may be reproduced, in any form or by any means, without permission in writing from the publisher.

14-114. The L-shaped frame is made from two segments, each of length L and flexural stiffness EI . If it is subjected to the uniform distributed load, determine the vertical displacement of point B .

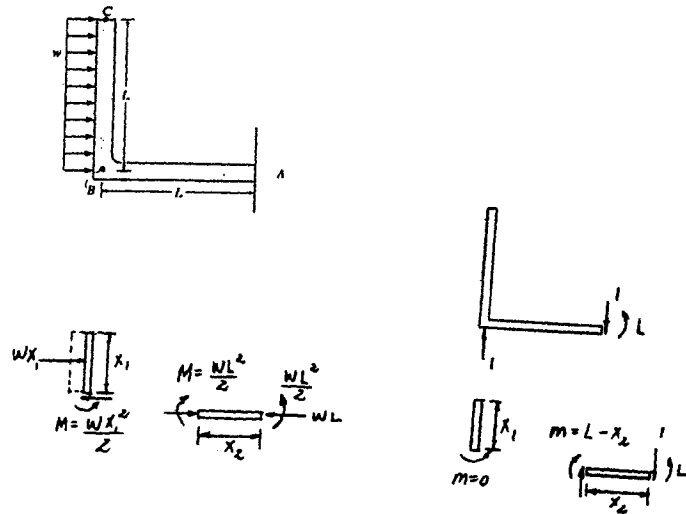

$$\begin{aligned}
 1 \cdot \Delta_{B_v} &= \int_0^L \frac{mM}{EI} dx \\
 \Delta_{B_v} &= \frac{1}{EI} \left[\int_0^L (0) \left(\frac{wx_1^2}{2} \right) dx_1 + \int_0^L (L-x_2) \left(\frac{wL^2}{2} \right) dx_2 \right] \\
 &= \frac{wL^4}{4EI} \quad \text{Ans}
 \end{aligned}$$

From *Mechanics of Materials*, Sixth Edition by R. C. Hibbeler, ISBN 0-13-191345-X.

© 2005 R. C. Hibbeler. Published by Pearson Prentice Hall,

Pearson Education, Inc., Upper Saddle River, NJ. All rights reserved.

This material is protected under all copyright laws as they currently exist. No portion of this material may be reproduced, in any form or by any means, without permission in writing from the publisher.

14-115. Determine the horizontal and vertical displacements of point C. There is a fixed support at A. EI is constant.

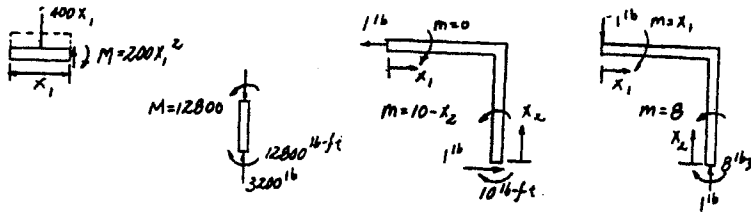
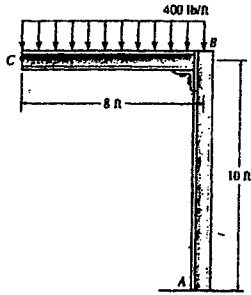

$$1 \cdot \Delta = \int_0^L \frac{mM}{EI} dx$$

$$\Delta_{C_1} = \frac{1}{EI} \left[\int_0^8 (0)(200x_1^2) dx_1 + \int_0^{10} (10-x_2)(12,800) dx_2 \right] = \frac{640,000 \text{ lb} \cdot \text{ft}^3}{EI} \quad \text{Ans}$$

$$\Delta_{C_2} = \frac{1}{EI} \left[\int_0^8 (x_1)(200x_1^2) dx_1 + \int_0^{10} (8)(12,800) dx_2 \right] = \frac{1,228,800 \text{ lb} \cdot \text{ft}^3}{EI} \quad \text{Ans}$$

From *Mechanics of Materials*, Sixth Edition by R. C. Hibbeler, ISBN 0-13-191345-X.

© 2005 R. C. Hibbeler. Published by Pearson Prentice Hall,

Pearson Education, Inc., Upper Saddle River, NJ. All rights reserved.

This material is protected under all copyright laws as they currently exist. No portion of this material may be reproduced, in any form or by any means, without permission in writing from the publisher.

***14-116.** The semi-circular rod has a cross-sectional area A and modulus of elasticity E . Determine the horizontal deflection at the roller due to the loading.

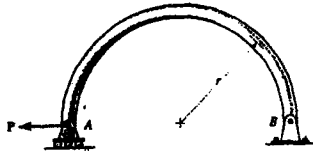

$$\Sigma F_x = 0; \quad N - P \sin \theta = 0$$

$$N = P \sin \theta$$

$$\Sigma M_O = 0; \quad M - P \sin \theta r = 0$$

$$M = Pr \sin \theta$$

$$\Sigma F_x = 0; \quad n - l \sin \theta = 0$$

$$n = l \sin \theta$$

$$\Sigma M_O = 0; \quad m - (l \sin \theta) r = 0$$

$$m = r \sin \theta$$

$$1 \cdot \Delta = \int_0^L \frac{mM}{EI} dx = \frac{Pr^2}{EI} \int_0^\pi \sin^2 \theta (rd\theta) = \frac{Pr^3}{EI} \left(\frac{1}{2} \theta - \frac{1}{4} \sin 2\theta \right) \Big|_0^\pi$$

$$\Delta = \frac{\pi Pr^3}{2EI} \quad \text{Ans}$$

From *Mechanics of Materials*, Sixth Edition by R. C. Hibbeler, ISBN 0-13-191345-X.

© 2005 R. C. Hibbeler. Published by Pearson Prentice Hall,

Pearson Education, Inc., Upper Saddle River, NJ. All rights reserved.

This material is protected under all copyright laws as they currently exist. No portion of this material may be reproduced, in any form or by any means, without permission in writing from the publisher.

14-117 Solve Prob. 14-71 using Castigliano's theorem.

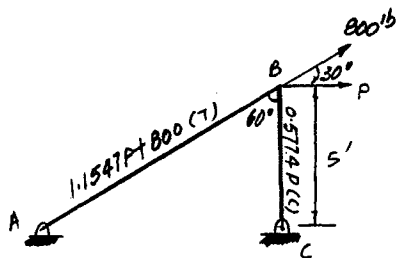
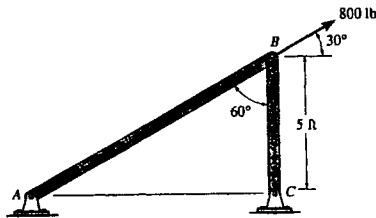

Member	N	$\partial N / \partial P$	$N(P=0)$	L	$N(\partial N / \partial P)L$
AB	$1.1547P + 800$	1.1547	800	120	110 851.25
BC	$-0.5774P$	-0.5774	0	60	0

$$\Sigma = 110\,851.25$$

$$\Delta_{B_v} = \Sigma N \left(\frac{\partial N}{\partial P} \right) \frac{L}{AE} = \frac{110851.25}{AE} = \frac{110851.25}{(2)(29)(10^6)} = 0.00191 \text{ in.} \quad \text{Ans}$$

From *Mechanics of Materials*, Sixth Edition by R. C. Hibbeler, ISBN 0-13-191345-X.

© 2005 R. C. Hibbeler. Published by Pearson Prentice Hall,

Pearson Education, Inc., Upper Saddle River, NJ. All rights reserved.

This material is protected under all copyright laws as they currently exist. No portion of this material may be reproduced, in any form or by any means, without permission in writing from the publisher.

14-118 Solve Prob. 14-73 using Castigliano's theorem.

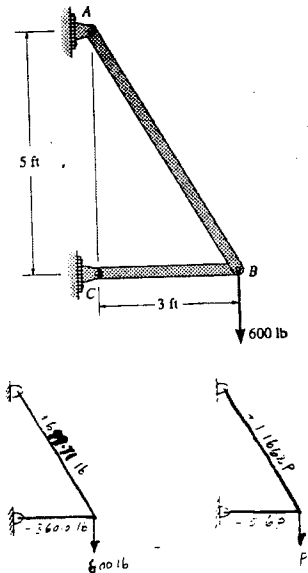

$$\Delta_{Bv} = \sum N \left(\frac{\partial N}{\partial P} \right) \frac{L}{AE} = \frac{699.71 (1.166)(5.831)(12)}{2 (29)(10^6)} + \frac{-360 (-0.6)(3)(12)}{2 (29)(10^6)}$$

$$= 0.00112 \text{ in. } \downarrow \quad \text{Ans}$$

From *Mechanics of Materials*, Sixth Edition by R. C. Hibbeler, ISBN 0-13-191345-X.

© 2005 R. C. Hibbeler. Published by Pearson Prentice Hall,

Pearson Education, Inc., Upper Saddle River, NJ. All rights reserved.

This material is protected under all copyright laws as they currently exist. No portion of this material may be reproduced, in any form or by any means, without permission in writing from the publisher.

14-119 Solve Prob. 14-74 using Castigliano's theorem.

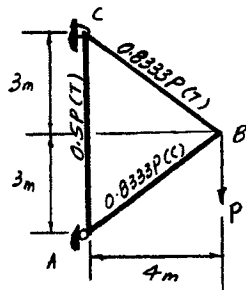
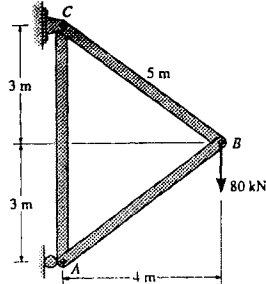

Member	N	$\partial N / \partial P$	$N(P=0)$	L	$N(\partial N / \partial P)L$
AB	$-0.8333P$	-0.8333	-66.67	5	277.78
AC	$-0.5P$	0.5	40	6	120.00
BC	$0.8333P$	0.8333	66.67	5	277.78

$$\Sigma = 675.56$$

$$\Delta_B = \Sigma N \left(\frac{\partial N}{\partial P} \right) \frac{L}{AE} = \frac{675.56}{AE} = \frac{675.56(10^3)}{300(10^{-6})(200)(10^9)} = 0.0113 \text{ m} = 11.3 \text{ mm} \quad \text{Ans}$$

From *Mechanics of Materials*, Sixth Edition by R. C. Hibbeler, ISBN 0-13-191345-X.

© 2005 R. C. Hibbeler. Published by Pearson Prentice Hall,

Pearson Education, Inc., Upper Saddle River, NJ. All rights reserved.

This material is protected under all copyright laws as they currently exist. No portion of this material may be reproduced, in any form or by any means, without permission in writing from the publisher.

*14-120 Solve Prob. 14-72 using Castigliano's theorem.

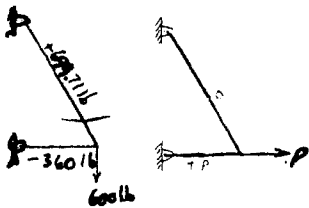
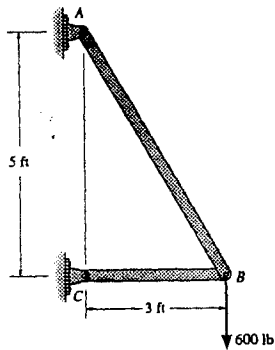

$$\Delta_{Bh} = \sum N \left(\frac{\partial N}{\partial P} \right) \frac{L}{AE} = \frac{-360 (1)(3)(12)}{2 (29)(10^6)} + 0 = -0.223 (10^{-3}) \text{ in.}$$

$$= 0.223 (10^{-3}) \text{ in.} \leftarrow \quad \mathbf{Ans}$$

From *Mechanics of Materials*, Sixth Edition by R. C. Hibbeler, ISBN 0-13-191345-X.

© 2005 R. C. Hibbeler. Published by Pearson Prentice Hall,

Pearson Education, Inc., Upper Saddle River, NJ. All rights reserved.

This material is protected under all copyright laws as they currently exist. No portion of this material may be reproduced, in any form or by any means, without permission in writing from the publisher.

14-121 Solve Prob. 14-75 using Castigliano's theorem.

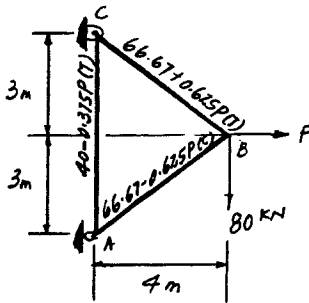
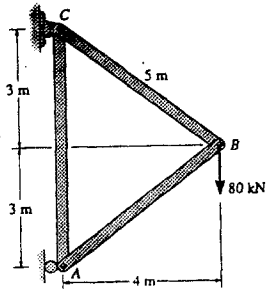

Member	N	$\partial N / \partial P$	$N(P=0)$	L	$N(\partial N / \partial P)L$
AB	$-(66.67 - 0.625P)$	0.625	-66.67	5	-208.33
AC	$40 - 0.375P$	-0.375	40	6	-90.00
BC	$66.67 + 0.625P$	0.625	66.67	5	208.33
					$\Sigma = -90.00$

$$\Delta_{B_A} = \Sigma N \left(\frac{\partial N}{\partial P} \right) \frac{L}{AE} = \frac{-90}{AE} = \frac{-90(10^3)}{300(10^{-6})(200)(10^9)} = -1.50(10^{-3})\text{m}$$

$$= -1.50\text{mm} = 1.50\text{ mm} \leftarrow \text{Ans}$$

From *Mechanics of Materials*, Sixth Edition by R. C. Hibbeler, ISBN 0-13-191345-X.

© 2005 R. C. Hibbeler. Published by Pearson Prentice Hall,

Pearson Education, Inc., Upper Saddle River, NJ. All rights reserved.

This material is protected under all copyright laws as they currently exist. No portion of this material may be reproduced, in any form or by any means, without permission in writing from the publisher.

14-122 Solve Prob. 14-76 using Castigliano's theorem.

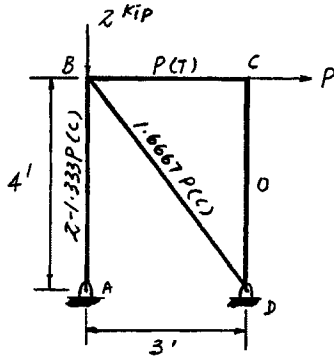
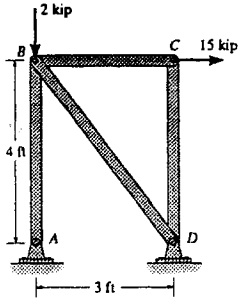

Member	N	$\partial N / \partial P$	$N(P=15)$	L	$N(\partial N / \partial P)L$
AB	$-(2 - 1.333P)$	1.333	18	48	1152
AC	P	1.0	15	36	540
BC	$-1.6667P$	-1.6667	25	60	2500
CD	0	0	0	0	0

$$\Sigma = 4192$$

$$\Delta_{C_x} = \Sigma N \left(\frac{\partial N}{\partial P} \right) \frac{L}{AE} = \frac{4192}{3(29)(10^3)} = 0.0482 \text{ in.} \quad \text{Ans}$$

From *Mechanics of Materials*, Sixth Edition by R. C. Hibbeler, ISBN 0-13-191345-X.

© 2005 R. C. Hibbeler. Published by Pearson Prentice Hall,

Pearson Education, Inc., Upper Saddle River, NJ. All rights reserved.

This material is protected under all copyright laws as they currently exist. No portion of this material may be reproduced, in any form or by any means, without permission in writing from the publisher.

14-123 Solve Prob. 14-77 using Castigliano's theorem.

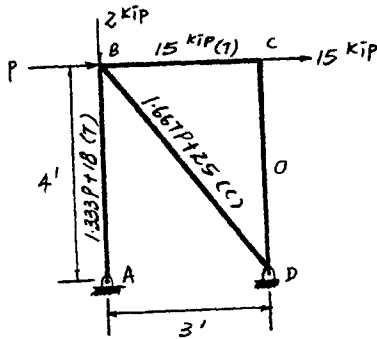
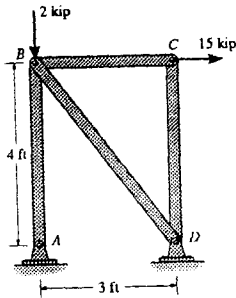

Member	N	$\partial N / \partial P$	$N(P = 15)$	L	$N(\partial N / \partial P)L$
AB	$1.333P + 18$	1.333	18	48	1152
AC	15	1.0	15	36	0
BC	$-(1.667P + 25)$	-1.6667	-25	60	2500
CD	0	0	0	0	0
					$\Sigma = 3652$

$$\Delta_{B_h} = \Sigma N \left(\frac{\partial N}{\partial P} \right) \frac{L}{AE} = \frac{3652}{AE} = \frac{3652}{(3)(29)(10^3)} = 0.0420 \text{ in.} \quad \text{Ans}$$

From *Mechanics of Materials*, Sixth Edition by R. C. Hibbeler, ISBN 0-13-191345-X.

© 2005 R. C. Hibbeler. Published by Pearson Prentice Hall,

Pearson Education, Inc., Upper Saddle River, NJ. All rights reserved.

This material is protected under all copyright laws as they currently exist. No portion of this material may be reproduced, in any form or by any means, without permission in writing from the publisher.

*14-124 Solve Prob. 14-80 using Castigliano's theorem.

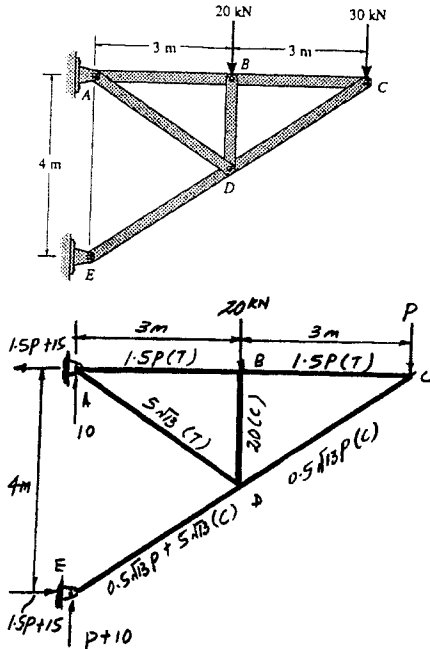

Member	N	$\frac{\partial N}{\partial P}$	$N(P = 30)$	L	$N(\frac{\partial N}{\partial P})L$
AB	$1.50P$	1.50	45.00	3.0	202.50
AD	$5\sqrt{13}$	0	$5\sqrt{13}$	$\sqrt{13}$	0
BD	-20	0	-20	2.0	0
BC	$1.5P$	1.5	45.00	3.0	202.50
CD	$-0.5\sqrt{13}P$	$-0.5\sqrt{13}$	$-15\sqrt{13}$	$\sqrt{13}$	351.54
DE	$-(0.5\sqrt{13}P + 5\sqrt{13})$	$-0.5\sqrt{13}$	$-20\sqrt{13}$	$\sqrt{13}$	468.72

$$\Sigma = 1225.26$$

$$\Delta_{C_v} = \Sigma N \left(\frac{\partial N}{\partial P} \right) \frac{L}{AE} = \frac{1225.26(10^3)}{300(10^{-6})(200)(10^9)}$$

$$= 0.0204 \text{ m} = 20.4 \text{ mm} \quad \text{Ans}$$

From *Mechanics of Materials*, Sixth Edition by R. C. Hibbeler, ISBN 0-13-191345-X.

© 2005 R. C. Hibbeler. Published by Pearson Prentice Hall,

Pearson Education, Inc., Upper Saddle River, NJ. All rights reserved.

This material is protected under all copyright laws as they currently exist. No portion of this material may be reproduced, in any form or by any means, without permission in writing from the publisher.

14-125 Solve Prob. 14-78 using Castigliano's theorem.

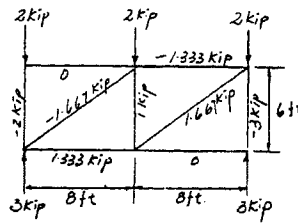
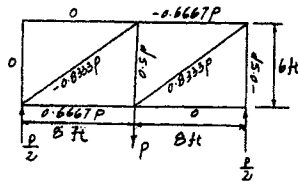
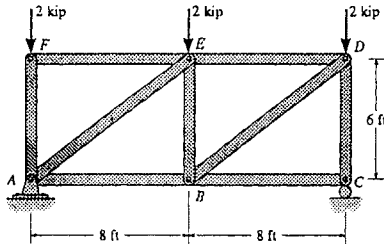

$$\Delta_B = \sum N \left(\frac{\partial N}{\partial P} \right) \frac{L}{AE}$$

$$= [(-1.333)(-0.667)(8) + (1.33)(0.667)(8) + (-1)(0.5)(6) + (-1.667)(-0.833)(10) + (1.667)(0.8333)(10) + (-3)(-0.5)(6)] \frac{12}{AE}$$

$$= \frac{576}{1.5(29)(10^3)} = 0.0132 \text{ in.} \quad \text{Ans}$$

From *Mechanics of Materials*, Sixth Edition by R. C. Hibbeler, ISBN 0-13-191345-X.

© 2005 R. C. Hibbeler. Published by Pearson Prentice Hall,

Pearson Education, Inc., Upper Saddle River, NJ. All rights reserved.

This material is protected under all copyright laws as they currently exist. No portion of this material may be reproduced, in any form or by any means, without permission in writing from the publisher.

14-126 Solve Prob. 14-79 using Castigliano's theorem.

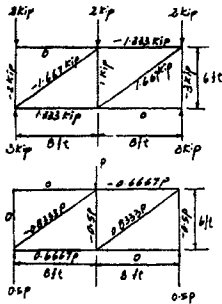
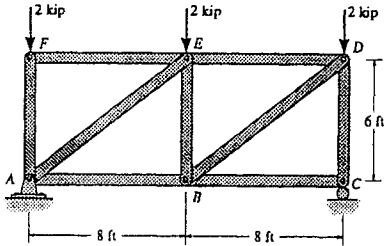

$$\Delta_E = \sum N \left(\frac{\partial N}{\partial P} \right) \frac{L}{AE}$$

$$= \{ (-1.667)(-0.833)(10) + (1.667)(0.833)(10) \\ + (-1)(-0.5)(6) + (-0.5)(-3)(6) \\ + (0.667)(1.33)(8) + (-0.667)(-1.33)(8) \} \frac{12}{AE}$$

$$= \frac{648}{1.5(29)(10^3)} = 0.0149 \text{ in.} \quad \text{Ans}$$

From *Mechanics of Materials*, Sixth Edition by R. C. Hibbeler, ISBN 0-13-191345-X.

© 2005 R. C. Hibbeler. Published by Pearson Prentice Hall,

Pearson Education, Inc., Upper Saddle River, NJ. All rights reserved.

This material is protected under all copyright laws as they currently exist. No portion of this material may be reproduced, in any form or by any means, without permission in writing from the publisher.

14-127 Solve Prob. 14-81 using Castigliano's theorem.

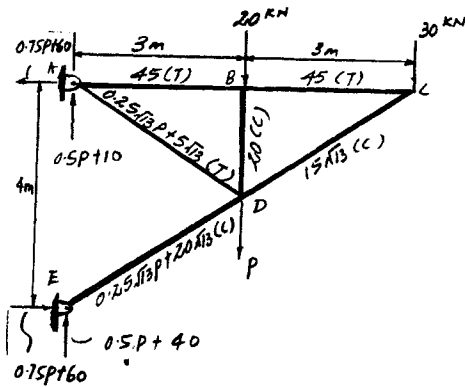
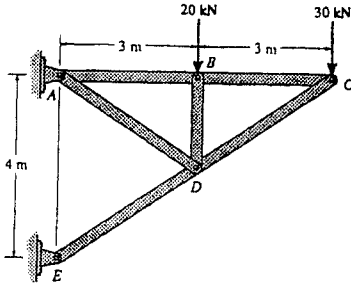

Member	N	$\partial N / \partial P$	$N(P=0)$	L	$N(\partial N / \partial P)L$
AB	45	0	45	3	0
AD	$0.25\sqrt{13}P + 5\sqrt{13}$	$0.25\sqrt{13}$	$5\sqrt{13}$	$\sqrt{13}$	58.59
BC	45	0	45	3	0
BD	-20	0	-20	2	0
CD	$-15\sqrt{13}$	0	$-15\sqrt{13}$	$\sqrt{13}$	0
DE	$-(0.25\sqrt{13}P + 20\sqrt{13})$	$-0.25\sqrt{13}$	$-20\sqrt{13}$	$\sqrt{13}$	234.36
					$\Sigma = 292.95$

$$\Delta_{D_v} = \Sigma N \left(\frac{\partial N}{\partial P} \right) \frac{L}{AE} = \frac{292.95}{AE} = \frac{292.95(10^3)}{300(10^{-6})(200)(10^9)}$$

$$= 4.88(10^{-3}) \text{ m} = 4.88 \text{ mm} \quad \text{Ans}$$

From *Mechanics of Materials*, Sixth Edition by R. C. Hibbeler, ISBN 0-13-191345-X.

© 2005 R. C. Hibbeler. Published by Pearson Prentice Hall,

Pearson Education, Inc., Upper Saddle River, NJ. All rights reserved.

This material is protected under all copyright laws as they currently exist. No portion of this material may be reproduced, in any form or by any means, without permission in writing from the publisher.

*14-128 Solve Prob. 14-84 using Castigliano's theorem.

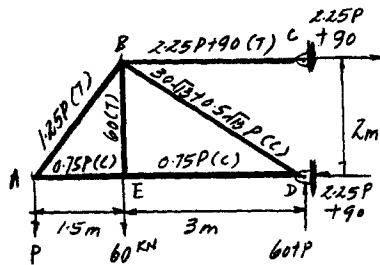
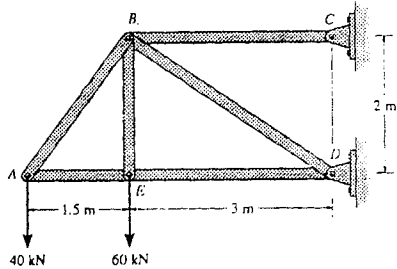

Member	N	$\partial N / \partial P$	$N(P = 40)$	L	$N(\partial N / \partial P)L$
AB	$1.25P$	1.25	50	2.5	156.25
AE	$-0.75P$	-0.75	-30	1.5	33.75
BC	$2.25P + 90$	2.25	180	3.0	1215.00
BD	$-(30\sqrt{13} + 0.5\sqrt{13}P)$	$-0.5\sqrt{13}$	$-50\sqrt{13}$	$\sqrt{13}$	1171.80
BE	60	0	60	2.0	0
DE	$-0.75P$	-0.75	-30	3.0	67.5

$$\Sigma = 2644.30$$

$$\Delta_A = \Sigma N \left(\frac{\partial N}{\partial P} \right) \frac{L}{AE} = \frac{2644.30(10^3)}{400(10^{-6})(200)(10^9)} = 0.0331 \text{ m} = 33.1 \text{ mm} \quad \text{Ans}$$

From *Mechanics of Materials*, Sixth Edition by R. C. Hibbeler, ISBN 0-13-191345-X.

© 2005 R. C. Hibbeler. Published by Pearson Prentice Hall,

Pearson Education, Inc., Upper Saddle River, NJ. All rights reserved.

This material is protected under all copyright laws as they currently exist. No portion of this material may be reproduced, in any form or by any means, without permission in writing from the publisher.

14-129 Solve Prob. 14-82 using Castigliano's theorem.

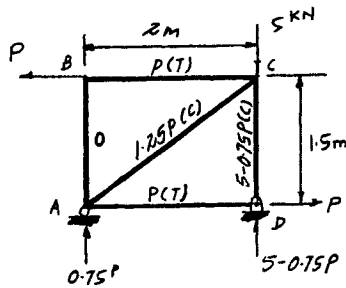
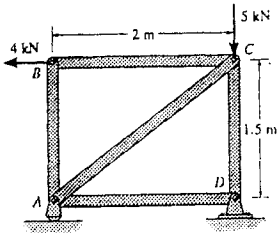

Member	N	$\partial N / \partial P$	$N(P=0)$	L	$N(\partial N / \partial P)L$
AB	0	0	0	1.5	0
AC	$-1.25P$	-1.25	-5	2.5	$15.625P$
AD	P	1	4	2.0	8.00
BC	P	1	4	2.0	8.00
CD	$-(5 - 0.75P)$	0.75	-2	1.5	-2.25

$$\Sigma = 29.375$$

$$\Delta_{B_h} = \Sigma N \left(\frac{\partial N}{\partial P} \right) \left(\frac{L}{AE} \right) = \frac{29.375(10^3)}{400(10^{-6})(200)(10^9)} = 0.367(10^{-3}) \text{ m}$$

$$= 0.367 \text{ mm} \quad \text{Ans}$$

From *Mechanics of Materials*, Sixth Edition by R. C. Hibbeler, ISBN 0-13-191345-X.

© 2005 R. C. Hibbeler. Published by Pearson Prentice Hall,

Pearson Education, Inc., Upper Saddle River, NJ. All rights reserved.

This material is protected under all copyright laws as they currently exist. No portion of this material may be reproduced, in any form or by any means, without permission in writing from the publisher.

14-130 Solve Prob. 14-83 using Castigliano's theorem.

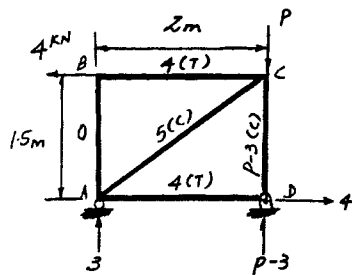
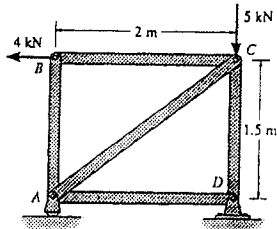

Member	N	$\partial N / \partial P$	$N(P = 5)$	L	$N(\partial N / \partial P)L$
AB	0	0	0	1.5	0
AC	-5	0	-5	2.5	0
AD	4	0	4	2.0	0
BC	4	0	4	2.0	0
CD	$-(P-3)$	-1	-2	1.5	3

$$\Sigma = 3$$

$$\Delta_{C_v} = \Sigma N \left(\frac{\partial N}{\partial P} \right) \frac{L}{AE} = \frac{3}{AE} = \frac{3(10^3)}{400(10^{-6})(200)(10^9)} = 37.5(10^{-6}) \text{ m} = 0.0375 \text{ mm} \quad \text{Ans}$$

From *Mechanics of Materials*, Sixth Edition by R. C. Hibbeler, ISBN 0-13-191345-X.

© 2005 R. C. Hibbeler. Published by Pearson Prentice Hall,

Pearson Education, Inc., Upper Saddle River, NJ. All rights reserved.

This material is protected under all copyright laws as they currently exist. No portion of this material may be reproduced, in any form or by any means, without permission in writing from the publisher.

14-131 Solve Prob. 14-85 using Castigliano's theorem.

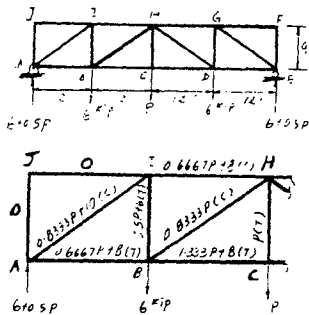
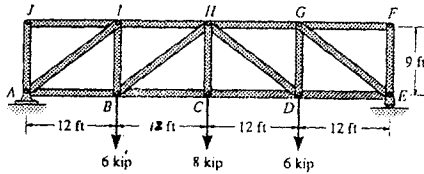

$$\Delta_{Cv} = \sum N \left(\frac{\partial N}{\partial P} \right) \frac{L}{AE} = \frac{21232}{AE} = \frac{21232}{4.5 (29)(10^3)} = 0.163 \text{ in.} \quad \text{Ans}$$

From *Mechanics of Materials*, Sixth Edition by R. C. Hibbeler, ISBN 0-13-191345-X.

© 2005 R. C. Hibbeler. Published by Pearson Prentice Hall,

Pearson Education, Inc., Upper Saddle River, NJ. All rights reserved.

This material is protected under all copyright laws as they currently exist. No portion of this material may be reproduced, in any form or by any means, without permission in writing from the publisher.

•14-132 Solve Prob. 14-86 using Castigliano's theorem.

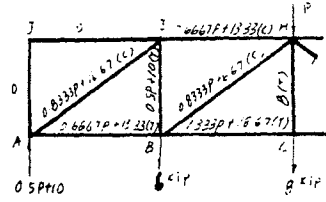
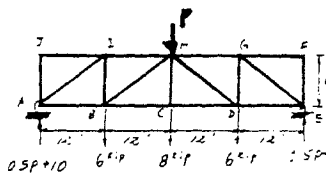
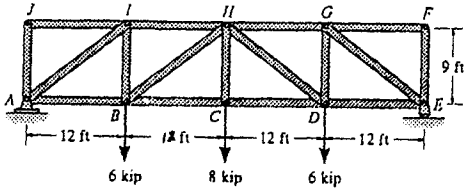

$$\Delta_{Hv} = \sum N \left(\frac{\partial N}{\partial P} \right) \frac{L}{AE} = \frac{20368}{AE} = \frac{20368}{4.5(29)(10^3)}$$

$$= 0.156 \text{ in.} \quad \text{Ans}$$

From *Mechanics of Materials*, Sixth Edition by R. C. Hibbeler, ISBN 0-13-191345-X.
 © 2005 R. C. Hibbeler. Published by Pearson Prentice Hall,
 Pearson Education, Inc., Upper Saddle River, NJ. All rights reserved.
 This material is protected under all copyright laws as they currently exist. No portion of this material may be reproduced, in any form or by any means, without permission in writing from the publisher.

14-133 Solve Prob. 14-87 using Castigliano's theorem.

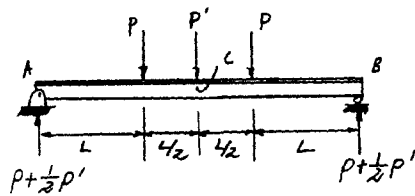
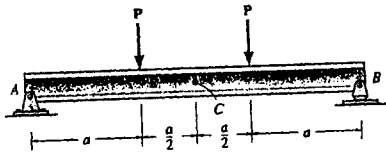

$$M_1 = Px_1 + \frac{P'}{2}x_1$$

$$M_2 = PL + \frac{P'L}{2} + \frac{P'}{2}x_2$$

$$\frac{\partial M_1}{\partial P'} = \frac{x_1}{2} \quad \frac{\partial M_2}{\partial P'} = \frac{L}{2} + \frac{x_2}{2}$$

Set $P' = 0$

$$\begin{aligned} M_1 &= Px_1 & M_2 &= PL \\ \Delta_C &= \int_0^L M \left(\frac{\partial M}{\partial P'} \right) \frac{dx}{EI} = (2) \frac{1}{EI} \left[\int_0^L (Px_1) \left(\frac{1}{2}x_1 \right) dx + \int_0^{L/2} (PL) \left(\frac{L}{2} + \frac{1}{2}x_2 \right) dx_2 \right] \\ &= \frac{23PL^3}{24EI} \quad \text{Ans} \end{aligned}$$

From *Mechanics of Materials*, Sixth Edition by R. C. Hibbeler, ISBN 0-13-191345-X.

© 2005 R. C. Hibbeler. Published by Pearson Prentice Hall,

Pearson Education, Inc., Upper Saddle River, NJ. All rights reserved.

This material is protected under all copyright laws as they currently exist. No portion of this material may be reproduced, in any form or by any means, without permission in writing from the publisher.

14-134 Solve Prob. 14-89 using Castigliano's theorem.

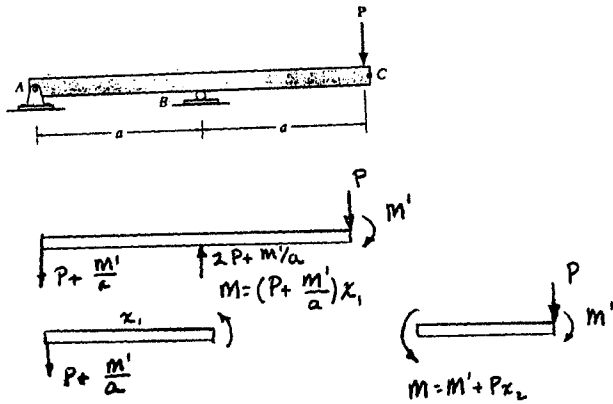

Set $M' = 0$

$$\theta_C = \int_0^L M \left(\frac{\partial M}{\partial M'} \right) \frac{dx}{EI}$$

$$= \int_0^a \frac{(Px_1) \left(\frac{1}{a} x_1 \right) dx_1}{EI} + \int_0^a \frac{(Px_2)(1) dx_2}{EI}$$

$$= \frac{Pa^2}{3EI} + \frac{Pa^2}{2EI} = \frac{5Pa^2}{6EI} \quad \text{Ans}$$

From *Mechanics of Materials*, Sixth Edition by R. C. Hibbeler, ISBN 0-13-191345-X.

© 2005 R. C. Hibbeler. Published by Pearson Prentice Hall,

Pearson Education, Inc., Upper Saddle River, NJ. All rights reserved.

This material is protected under all copyright laws as they currently exist. No portion of this material may be reproduced, in any form or by any means, without permission in writing from the publisher.

14-135 Solve Prob. 14-90 using Castigliano's theorem.

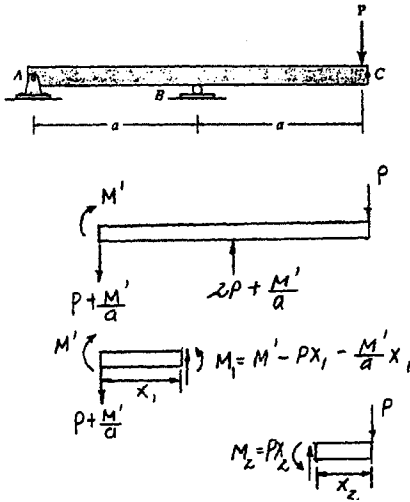

$$\frac{\partial M_1}{\partial M'} = 1 - \frac{x_1}{a} \quad \frac{\partial M_2}{\partial M'} = 0$$

Set $M' = 0$

$$M_1 = -Px_1 \quad M_2 = Px_2$$

$$\theta_A = \int_0^L M \left(\frac{\partial M}{\partial M'} \right) \frac{dx}{EI} = \frac{1}{EI} \left[\int_0^a (-Px_1) \left(1 - \frac{x_1}{a} \right) dx_1 + \int_0^a (Px_2)(0) dx_2 \right] = \frac{-Pa^2}{6EI}$$

$= \frac{Pa^2}{6EI} \quad \text{Ans.}$

From *Mechanics of Materials*, Sixth Edition by R. C. Hibbeler, ISBN 0-13-191345-X.

© 2005 R. C. Hibbeler. Published by Pearson Prentice Hall,

Pearson Education, Inc., Upper Saddle River, NJ. All rights reserved.

This material is protected under all copyright laws as they currently exist. No portion of this material may be reproduced, in any form or by any means, without permission in writing from the publisher.

*14-136 Solve Prob. 14-88 using Castigliano's theorem.

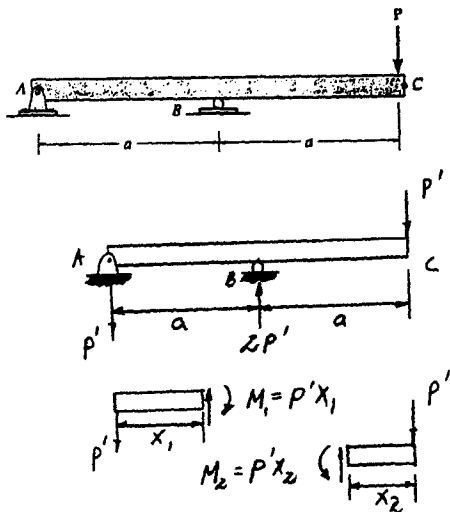

$$\frac{\partial M_1}{\partial P'} = x_1 \quad \frac{\partial M_2}{\partial P'} = x_2$$

Set $P = P'$

$$M_1 = Px_1 \quad M_2 = Px_2$$

$$\begin{aligned} \Delta_C &= \int_0^L M \left(\frac{\partial M}{\partial P'} \right) dx = \frac{1}{EI} \left[\int_0^a (Px_1)(x_1) dx_1 + \int_0^a (Px_2)(x_2) dx_2 \right] \\ &= \frac{2Pa^3}{3EI} \quad \text{Ans} \end{aligned}$$

From *Mechanics of Materials*, Sixth Edition by R. C. Hibbeler, ISBN 0-13-191345-X.

© 2005 R. C. Hibbeler. Published by Pearson Prentice Hall,

Pearson Education, Inc., Upper Saddle River, NJ. All rights reserved.

This material is protected under all copyright laws as they currently exist. No portion of this material may be reproduced, in any form or by any means, without permission in writing from the publisher.

14-137 Solve Prob. 14-91 using Castigliano's theorem.

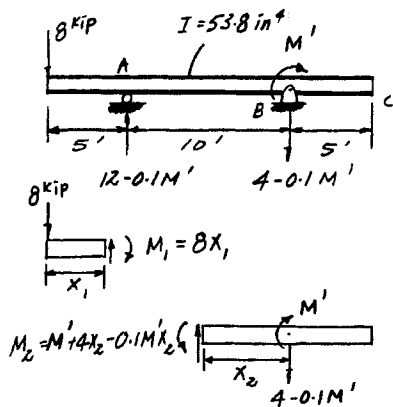
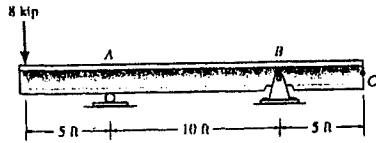

$$\frac{\partial M_1}{\partial M'} = 0 \quad \frac{\partial M_2}{\partial M'} = 1 - 0.1x_2$$

Set $M' = 0$

$$M_1 = 8x_1 \quad M_2 = 4x_2$$

$$\theta_B = \int_0^L M \left(\frac{\partial M}{\partial M'} \right) \frac{dx}{EI}$$

$$= \frac{1}{EI} \left[\int_0^5 (8x_1)(0) dx_1 + \int_0^{10} (4x_2)(1 - 0.1x_2) dx_2 \right]$$

$$= \frac{66.67 \text{ kip} \cdot \text{ft}^2}{EI} = \frac{66.67(12^2)}{29(10^3)(53.8)} = 6.15(10^{-3}) \text{ rad} = 0.353^\circ \quad \text{Ans}$$

$$\Delta_C = \theta_B(5)(12) = 6.15(10^{-3})(60) = 0.369 \text{ in.} \quad \text{Ans}$$

From *Mechanics of Materials*, Sixth Edition by R. C. Hibbeler, ISBN 0-13-191345-X.

© 2005 R. C. Hibbeler. Published by Pearson Prentice Hall,

Pearson Education, Inc., Upper Saddle River, NJ. All rights reserved.

This material is protected under all copyright laws as they currently exist. No portion of this material may be reproduced, in any form or by any means, without permission in writing from the publisher.

14-138 Solve Prob. 14-93 using Castigliano's theorem.

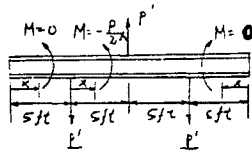
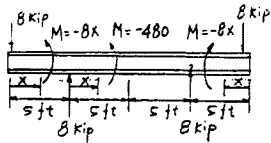
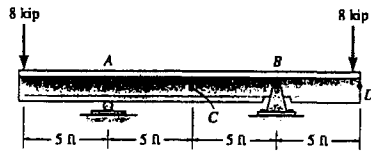

$$\Delta_C = \int_0^L M \left(\frac{\partial M}{\partial P} \right) \frac{dx}{EI} = 0 + 2 \int_0^{60} \frac{-480 \left(-\frac{x}{2} \right)}{EI} dx$$

$$= \frac{2 \left(\frac{480}{2} \right) \left(\frac{60^2}{2} \right)}{EI} = \frac{864\,000}{29(10^3)(245)} = 0.122 \text{ in.} \quad \text{Ans}$$

From *Mechanics of Materials*, Sixth Edition by R. C. Hibbeler, ISBN 0-13-191345-X.

© 2005 R. C. Hibbeler. Published by Pearson Prentice Hall,

Pearson Education, Inc., Upper Saddle River, NJ. All rights reserved.

This material is protected under all copyright laws as they currently exist. No portion of this material may be reproduced, in any form or by any means, without permission in writing from the publisher.

14-139 Solve Prob. 14-94 using Castigliano's theorem.

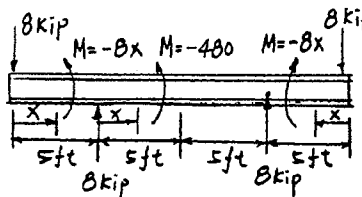
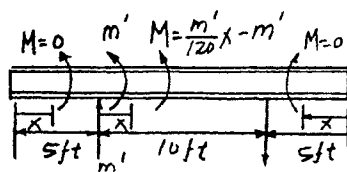
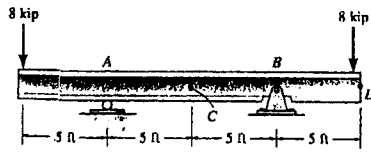

$$\theta_A = \int_0^L M \left(\frac{\partial M}{\partial m'} \right) \frac{dx}{EI}$$

$$= 0 + \int_0^{120} \frac{-480 \left(\frac{x}{120} - 1 \right)}{EI} dx = 0 + \frac{-480 \left[\frac{1}{2} \left(\frac{120^2}{120} \right) - 120 \right]}{EI}$$

$$= \frac{28\,800}{29(10^3)(245)} = 4.05(10^{-3}) \text{ rad} \quad \text{Ans}$$

From *Mechanics of Materials*, Sixth Edition by R. C. Hibbeler, ISBN 0-13-191345-X.

© 2005 R. C. Hibbeler. Published by Pearson Prentice Hall,

Pearson Education, Inc., Upper Saddle River, NJ. All rights reserved.

This material is protected under all copyright laws as they currently exist. No portion of this material may be reproduced, in any form or by any means, without permission in writing from the publisher.

14-140 Solve Prob. 14-92 using Castigliano's theorem.

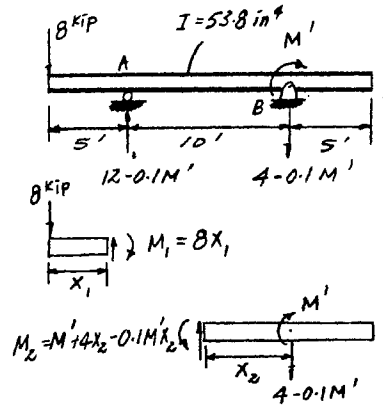
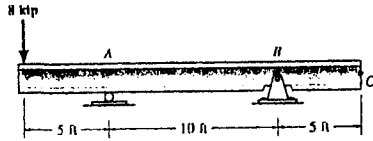

$$\frac{\partial M_1}{\partial M'} = 0 \quad \frac{\partial M_2}{\partial M'} = 1 - 0.1x_2$$

Set $M' = 0$

$$M_1 = 8x_1 \quad M_2 = 4x_2$$

$$\begin{aligned} \theta_B &= \int_0^L M \left(\frac{\partial M}{\partial M'} \right) \frac{dx}{EI} \\ &= \frac{1}{EI} \left[\int_0^5 (8x_1)(0) dx_1 + \int_0^{10} (4x_2)(1 - 0.1x_2) dx_2 \right] = \frac{66.67 \text{ kip} \cdot \text{ft}^2}{EI} \\ &= \frac{66.67(12)^2}{(29)(10^3)(53.8)} = 6.15(10^{-3}) \text{ rad} = 0.353^\circ \quad \text{Ans} \end{aligned}$$

From *Mechanics of Materials*, Sixth Edition by R. C. Hibbeler, ISBN 0-13-191345-X.

© 2005 R. C. Hibbeler. Published by Pearson Prentice Hall,

Pearson Education, Inc., Upper Saddle River, NJ. All rights reserved.

This material is protected under all copyright laws as they currently exist. No portion of this material may be reproduced, in any form or by any means, without permission in writing from the publisher.

14-141 Solve Prob. 14-95 using Castigliano's theorem.

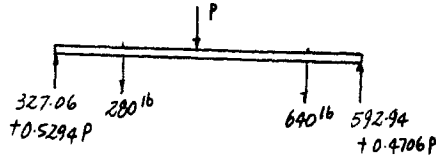
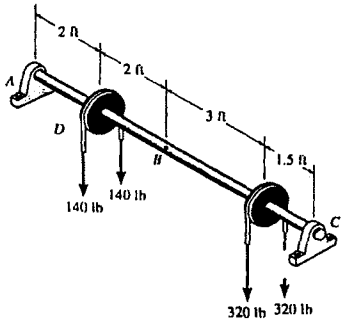

$$M_1 = 327.06x_1 + 0.5294Px_1$$

$$M_2 = 47.06x_2 + 0.5294Px_2 + 1.0588P + 654.12$$

$$M_3 = 592.94x_3 + 0.4706Px_3$$

$$M_4 = 0.4706Px_4 - 47.06x_4 + 0.7059P + 889.41$$

$$\frac{\partial M_1}{\partial P} = 0.5294x_1 \quad \frac{\partial M_2}{\partial P} = 0.5294x_2 + 1.0588$$

$$\frac{\partial M_3}{\partial P} = 0.4706x_3 \quad \frac{\partial M_4}{\partial P} = 0.4706x_4 + 0.7059$$

Set $P = 0$

$$M_1 = 327.06x_1 \quad M_2 = 47.06x_2 + 654.12$$

$$M_3 = 592.94x_3 \quad M_4 = 889.41 - 47.06x_4$$

$$\begin{aligned} \Delta_B &= \int_0^L M \left(\frac{\partial M}{\partial P} \right) \frac{dx}{EI} \\ &= \frac{1}{EI} \left[\int_0^2 (327.06x_1)(0.5294x_1) dx_1 + \int_0^2 (47.06x_2 + 654.12)(0.5294x_2 + 1.0588) dx_2 + \right. \\ &\quad \left. \int_0^{1.5} (592.94x_3)(0.4706x_3) dx_3 + \int_0^3 (889.41 - 47.06x_4)(0.4706x_4 + 0.7059) dx_4 \right] \\ &= \frac{6437.69 \text{ lb} \cdot \text{ft}^3}{EI} = \frac{6437.69(12^3)}{29(10^6)(\frac{\pi}{4})(0.75^4)} = 1.54 \text{ in.} \quad \text{Ans} \end{aligned}$$

From *Mechanics of Materials*, Sixth Edition by R. C. Hibbeler, ISBN 0-13-191345-X.

© 2005 R. C. Hibbeler. Published by Pearson Prentice Hall,

Pearson Education, Inc., Upper Saddle River, NJ. All rights reserved.

This material is protected under all copyright laws as they currently exist. No portion of this material may be reproduced, in any form or by any means, without permission in writing from the publisher.

14-142 Solve Prob. 14-97 using Castigliano's theorem.

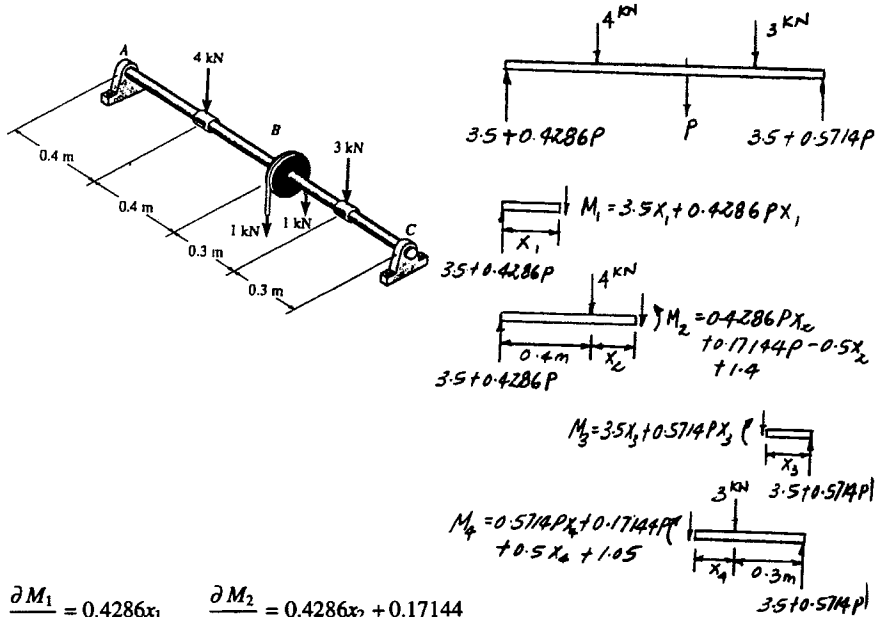

$$\frac{\partial M_1}{\partial P} = 0.4286x_1 \quad \frac{\partial M_2}{\partial P} = 0.4286x_2 + 0.17144$$

$$\frac{\partial M_3}{\partial P} = 0.5714x_3 \quad \frac{\partial M_4}{\partial P} = 0.5714x_4 + 0.17144$$

Set $P = 2 \text{ kN}$

$$M_1 = 4.3572x_1 \quad M_2 = 0.3572x_2 + 1.7429$$

$$M_3 = 4.6428x_3 \quad M_4 = 1.6428x_4 + 1.3929$$

$$\Delta_B = \int_0^L M \left(\frac{\partial M}{\partial P} \right) \frac{dx}{EI}$$

$$= \frac{1}{EI} \left[\int_0^{0.4} (4.3572x_1)(0.4286x_1) dx_1 + \int_0^{0.4} (0.3572x_2 + 1.7429)(0.4286x_2 + 0.17144) dx_2 + \int_0^{0.3} (4.6428x_3)(0.5714x_3) dx_3 + \int_0^{0.3} (1.6428x_4 + 1.3929)(0.5714x_4 + 0.17144) dx_4 \right]$$

$$= \frac{0.37944 \text{ kN} \cdot \text{m}^3}{EI} = \frac{0.37944(10^3)}{200(10^9) \frac{\pi}{4} (0.015)^4} = 0.0478 \text{ m} = 47.8 \text{ mm} \quad \text{Ans}$$

From *Mechanics of Materials*, Sixth Edition by R. C. Hibbeler, ISBN 0-13-191345-X.

© 2005 R. C. Hibbeler. Published by Pearson Prentice Hall,

Pearson Education, Inc., Upper Saddle River, NJ. All rights reserved.

This material is protected under all copyright laws as they currently exist. No portion of this material may be reproduced, in any form or by any means, without permission in writing from the publisher.

14-143 Solve Prob. 14-99 using Castigliano's theorem.

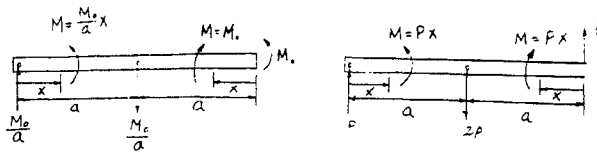
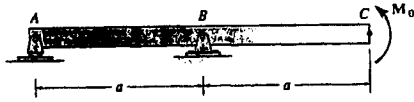

$$\begin{aligned} \Delta_C &= \int_0^L M \left(\frac{\partial M}{\partial P} \right) \frac{dx}{EI} = \int_0^a \frac{\left(\frac{M_0}{a} x \right) (1x)}{EI} dx + \int_0^a \frac{M_0 (1x)}{EI} dx \\ &= \frac{5 M_0 a^2}{6 EI} \quad \text{Ans} \end{aligned}$$

From *Mechanics of Materials*, Sixth Edition by R. C. Hibbeler, ISBN 0-13-191345-X.

© 2005 R. C. Hibbeler. Published by Pearson Prentice Hall,

Pearson Education, Inc., Upper Saddle River, NJ. All rights reserved.

This material is protected under all copyright laws as they currently exist. No portion of this material may be reproduced, in any form or by any means, without permission in writing from the publisher.

*14-144 Solve Prob. 14-96 using Castigliano's theorem.

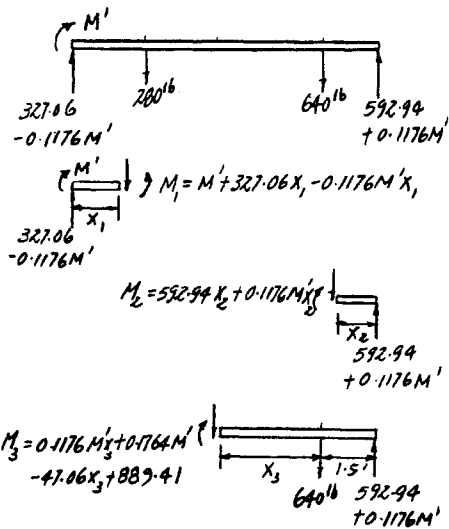
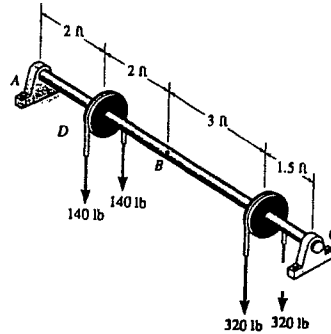

$$\frac{\partial M_1}{\partial M'} = 1 - 0.1176x_1 \quad \frac{\partial M_2}{\partial M'} = 0.1176x_2 \quad \frac{\partial M_3}{\partial M'} = 0.1176x_3 + 0.1764$$

Set $M' = 0$

$$M_1 = 327.06x_1 \quad M_2 = 592.94x_2 \quad M_3 = 889.41 - 47.06x_3$$

$$\begin{aligned} \theta_A &= \int M \left(\frac{\partial M}{\partial M'} \right) \frac{dx}{EI} = \frac{1}{EI} \left[\int_0^2 (327.06x_1)(1 - 0.1176x_1) dx_1 + \int_0^{1.5} (592.94x_2)(0.1176x_2) dx_2 + \int_0^3 (889.41 - 47.06x_3)(0.1176x_3 + 0.1764) dx_3 \right] \\ &= \frac{2387.54 \text{ lb} \cdot \text{ft}^2}{EI} = \frac{2387.54(12^2)}{29(10^6)(\frac{\pi}{4})(0.75^4)} = 0.0477 \text{ rad} = 2.73^\circ \quad \text{Ans} \end{aligned}$$

From *Mechanics of Materials*, Sixth Edition by R. C. Hibbeler, ISBN 0-13-191345-X.

© 2005 R. C. Hibbeler. Published by Pearson Prentice Hall,

Pearson Education, Inc., Upper Saddle River, NJ. All rights reserved.

This material is protected under all copyright laws as they currently exist. No portion of this material may be reproduced, in any form or by any means, without permission in writing from the publisher.

14-145 Solve Prob. 14-101 using Castigliano's theorem.

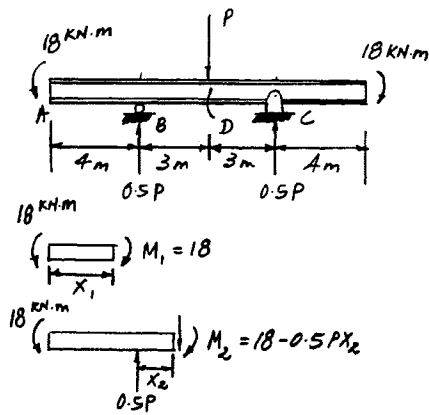
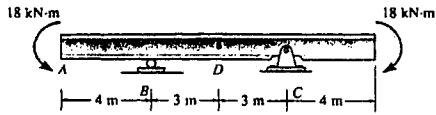

$$\frac{\partial M_1}{\partial P} = 0 \quad \frac{\partial M_2}{\partial P} = -0.5x_2$$

Set $P = 0$

$$M_1 = 18 \quad M_2 = 18$$

$$\Delta_D = \int_0^L M \left(\frac{\partial M}{\partial P} \right) \frac{dx}{EI}$$

$$= (2) \frac{1}{EI} \left[\int_0^4 (18)(0) dx_1 + \int_0^3 (18)(-0.5x_2) dx_2 \right]$$

$$= \frac{81 \text{ kN} \cdot \text{m}^3}{EI} = \frac{81(10^3)}{200(10^9)(125)(10^{-6})} = 3.24(10^{-3}) \text{ m} = 3.24 \text{ mm} \quad \mathbf{Ans}$$

From *Mechanics of Materials*, Sixth Edition by R. C. Hibbeler, ISBN 0-13-191345-X.

© 2005 R. C. Hibbeler. Published by Pearson Prentice Hall,

Pearson Education, Inc., Upper Saddle River, NJ. All rights reserved.

This material is protected under all copyright laws as they currently exist. No portion of this material may be reproduced, in any form or by any means, without permission in writing from the publisher.

14-146 Solve Prob. 14-102 using Castigliano's theorem.

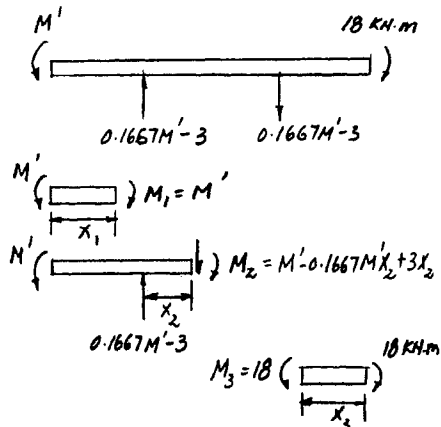
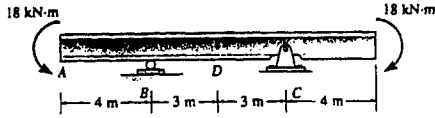

$$\frac{\partial M_1}{\partial M'} = 1 \quad \frac{\partial M_2}{\partial M'} = 1 - 0.1667x_2 \quad \frac{\partial M_3}{\partial M'} = 0$$

Set $M' = 18 \text{ kN} \cdot \text{m}$

$$M_1 = 18 \text{ kN} \cdot \text{m} \quad M_2 = 18 \text{ kN} \cdot \text{m} \quad M_3 = 18 \text{ kN} \cdot \text{m}$$

$$\begin{aligned} \theta_A &= \int_0^L M \left(\frac{\partial M}{\partial M'} \right) \frac{dx}{EI} = \frac{1}{EI} \left[\int_0^4 (18)(1) dx_1 + \int_0^6 18(1 - 0.1667x_2) dx_2 + \int_0^4 (18)(0) dx_3 \right] \\ &= \frac{126 \text{ kN} \cdot \text{m}^2}{EI} = \frac{126(10^3)}{200(10^9)(125)(10^{-6})} = 5.04(10^{-3}) \text{ rad} = 0.289^\circ \quad \text{Ans} \end{aligned}$$

From *Mechanics of Materials*, Sixth Edition by R. C. Hibbeler, ISBN 0-13-191345-X.

© 2005 R. C. Hibbeler. Published by Pearson Prentice Hall,

Pearson Education, Inc., Upper Saddle River, NJ. All rights reserved.

This material is protected under all copyright laws as they currently exist. No portion of this material may be reproduced, in any form or by any means, without permission in writing from the publisher.

14-147 Solve Prob. 14-103 using Castigliano's theorem.

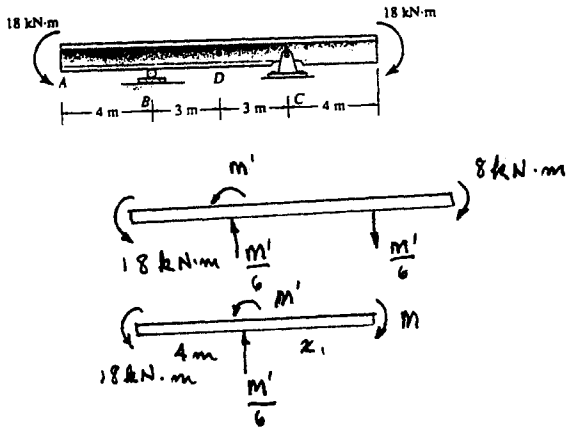

$$\theta_B = \int_0^L M \left(\frac{\partial M}{\partial M'} \right) \frac{dx}{EI} = \int_0^6 \frac{(-18) \left(-\frac{1}{6}x \right) dx (10^3)}{EI}$$

$$= \frac{18 (6^2) (10^3)}{6 (2) (200) (10^9) (125) (10^{-6})} = 0.00216 \text{ rad} \quad \text{Ans}$$

From *Mechanics of Materials*, Sixth Edition by R. C. Hibbeler, ISBN 0-13-191345-X.

© 2005 R. C. Hibbeler. Published by Pearson Prentice Hall,

Pearson Education, Inc., Upper Saddle River, NJ. All rights reserved.

This material is protected under all copyright laws as they currently exist. No portion of this material may be reproduced, in any form or by any means, without permission in writing from the publisher.

*14-148 Solve Prob. 14-100 using Castigliano's theorem.

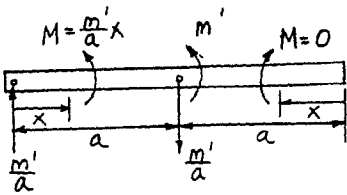
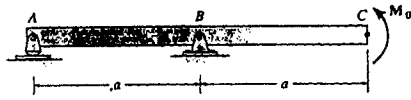

$$\theta_B = \int_0^L M \left(\frac{\partial M}{\partial M'} \right) \frac{dx}{EI} = \int_0^a \left(\frac{M_0}{a} x \right) \left(\frac{x}{a} \right) \frac{dx}{EI}$$

$$= \frac{M_0 a}{3EI} \quad \text{Ans}$$

From *Mechanics of Materials*, Sixth Edition by R. C. Hibbeler, ISBN 0-13-191345-X.

© 2005 R. C. Hibbeler. Published by Pearson Prentice Hall,

Pearson Education, Inc., Upper Saddle River, NJ. All rights reserved.

This material is protected under all copyright laws as they currently exist. No portion of this material may be reproduced, in any form or by any means, without permission in writing from the publisher.

14-149 Solve Prob. 14-105 using Castigliano's theorem.

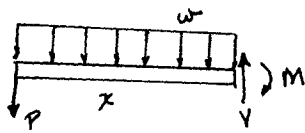
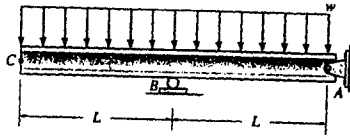

$$M = -Px - \frac{wx^2}{2}$$

$$\frac{\partial M}{\partial P} = -x$$

$$\text{Set } P = 0$$

$$\Delta_C = \int_0^L M \frac{\partial M}{\partial P} \frac{dx}{EI} = 2 \int_0^L \frac{(-\frac{wx^2}{2})(-x)}{EI} dx$$

$$= 2 \frac{w}{2EI} \left(\frac{L^4}{4} \right) = \frac{wL^4}{4EI} \quad \text{Ans}$$

From *Mechanics of Materials*, Sixth Edition by R. C. Hibbeler, ISBN 0-13-191345-X.

© 2005 R. C. Hibbeler. Published by Pearson Prentice Hall,

Pearson Education, Inc., Upper Saddle River, NJ. All rights reserved.

This material is protected under all copyright laws as they currently exist. No portion of this material may be reproduced, in any form or by any means, without permission in writing from the publisher.

14-150 Solve Prob. 14-106 using Castigliano's theorem.

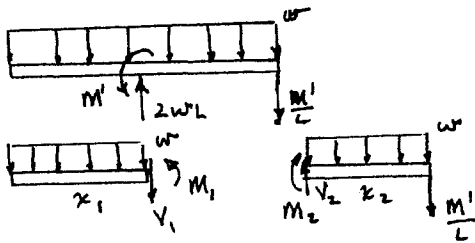
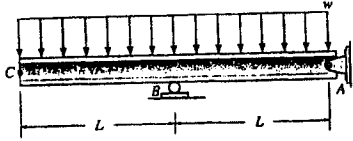

$$M_1 = -\frac{wx_1^2}{2}$$

$$\frac{\partial M_1}{\partial M'} = 0$$

$$M_2 = -\frac{M'}{L}x_2 - \frac{wx_2^2}{2}$$

$$\frac{\partial M_2}{\partial M'} = -\frac{x_2}{L}$$

$$\text{Set } M' = 0$$

$$\theta_B = \int_0^L M \left(\frac{\partial M}{\partial M'} \right) \frac{dx}{EI} = 0 + \int_0^L \left(-\frac{wx_2^2}{2} \right) \left(-\frac{x_2}{L} \right) \frac{dx}{EI} = \frac{wL^3}{8EI} \quad \text{Ans}$$

From *Mechanics of Materials*, Sixth Edition by R. C. Hibbeler, ISBN 0-13-191345-X.

© 2005 R. C. Hibbeler. Published by Pearson Prentice Hall,

Pearson Education, Inc., Upper Saddle River, NJ. All rights reserved.

This material is protected under all copyright laws as they currently exist. No portion of this material may be reproduced, in any form or by any means, without permission in writing from the publisher.

14-151 Solve Prob. 14-107 using Castigliano's theorem.

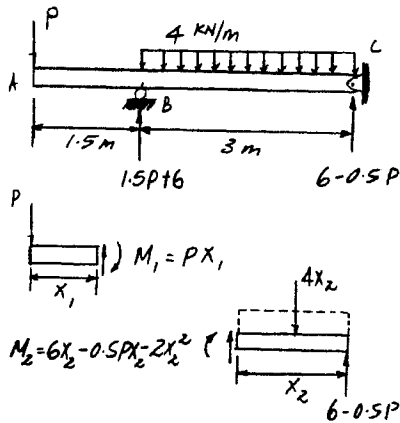
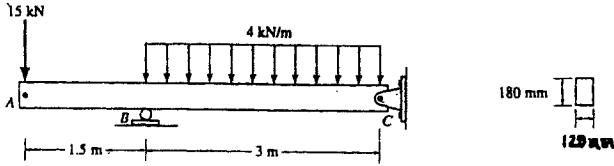

$$\frac{\partial M_1}{\partial P} = x_1 \quad \frac{\partial M_2}{\partial P} = -0.5x_2$$

Set $P = 15 \text{ kN}$

$$M_1 = 15x_1 \quad M_2 = -1.5x_2 - 2x_2^2$$

$$\Delta_A = \int_0^L M \left(\frac{\partial M}{\partial P} \right) \frac{dx}{EI} = \frac{1}{EI} \left[\int_0^{1.5} (15x_1)(x_1) dx + \int_0^3 (-1.5x_2 - 2x_2^2)(-0.5x_2) dx_2 \right]$$

$$= \frac{43.875 \text{ kN} \cdot \text{m}^3}{EI} = \frac{43.875(10^3)}{13(10^9) \frac{1}{12} (0.12)(0.18)^3} = 0.0579 \text{ m}$$

$$= 57.9 \text{ mm} \quad \text{Ans}$$

From *Mechanics of Materials*, Sixth Edition by R. C. Hibbeler, ISBN 0-13-191345-X.

© 2005 R. C. Hibbeler. Published by Pearson Prentice Hall,

Pearson Education, Inc., Upper Saddle River, NJ. All rights reserved.

This material is protected under all copyright laws as they currently exist. No portion of this material may be reproduced, in any form or by any means, without permission in writing from the publisher.

*14-152 Solve Probs. 14-104 using Castigliano's theorem.

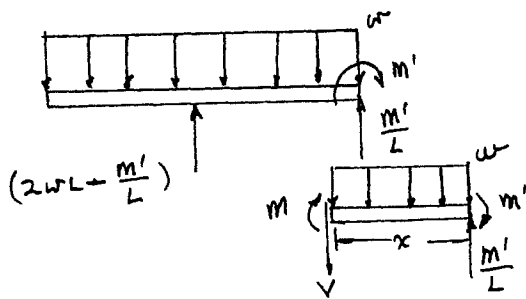
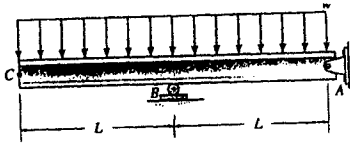

M' does not influence the moment within the overhang.

$$M = \frac{M'}{L}x - M' - \frac{wx^2}{2}$$

$$\frac{\partial M}{\partial M'} = \frac{x}{L} - 1$$

Setting $M' = 0$,

$$\begin{aligned} \theta_A &= \int_0^L M \left(\frac{\partial M}{\partial M'} \right) \frac{dx}{EI} = \frac{1}{EI} \int_0^L \left(-\frac{wx^2}{2} \right) \left(\frac{x}{L} - 1 \right) dx = \frac{-w}{2EI} \left[\frac{L^3}{4} - \frac{L^3}{3} \right] \\ &= \frac{wL^3}{24EI} \quad \text{Ans} \end{aligned}$$

From *Mechanics of Materials*, Sixth Edition by R. C. Hibbeler, ISBN 0-13-191345-X.

© 2005 R. C. Hibbeler. Published by Pearson Prentice Hall,

Pearson Education, Inc., Upper Saddle River, NJ. All rights reserved.

This material is protected under all copyright laws as they currently exist. No portion of this material may be reproduced, in any form or by any means, without permission in writing from the publisher.

14-153 Solve Prob. 14-109 using Castigliano's theorem.

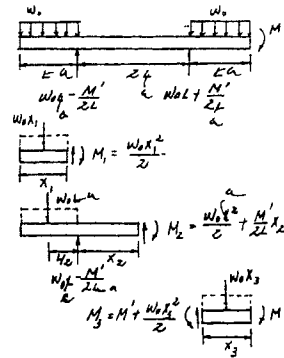
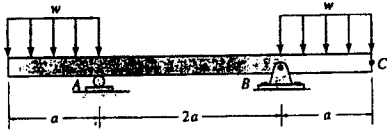

$$\frac{\partial M_1}{\partial M'} = 0 \quad \frac{\partial M_2}{\partial M'} = \frac{x_2}{2a} \quad \frac{\partial M_3}{\partial M'} = 1$$

Setting $M' = 0$;

$$M_1 = \frac{wx_1^2}{2}; \quad M_2 = \frac{wa^2}{2}; \quad M_3 = \frac{wx_3^2}{2}$$

$$\theta_C = \int_0^a M \left(\frac{\partial M}{\partial M'} \right) \frac{dx}{EI}$$

$$= \frac{1}{EI} \left[\int_0^a \left(\frac{wx_1^2}{2} \right) (0) dx_1 + \int_0^{2a} \left(\frac{wa^2}{2} \right) \left(\frac{x_2}{2a} \right) dx_2 + \int_0^a \left(\frac{wx_3^2}{2} \right) (1) dx_3 \right]$$

$$= \frac{2wa^3}{3EI} \quad \text{Ans}$$

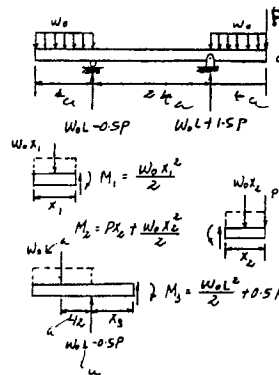

$$\frac{\partial M_1}{\partial P} = 0; \quad \frac{\partial M_2}{\partial P} = x_2; \quad \frac{\partial M_3}{\partial P} = 0.5x_3$$

Setting $P = 0$;

$$M_1 = \frac{wx_1^2}{2} \quad M_2 = \frac{wx_2^2}{2} \quad M_3 = \frac{wa^2}{2}$$

$$\Delta_C = \int_0^a M \left(\frac{\partial M}{\partial P} \right) \frac{dx}{EI}$$

$$= \frac{1}{EI} \left[\int_0^a \left(\frac{wx_1^2}{2} \right) (0) dx_1 + \int_0^{2a} \left(\frac{wx_2^2}{2} \right) (x_2) dx_2 + \int_0^a \left(\frac{wa^2}{2} \right) (0.5x_3) dx_3 \right]$$

$$= \frac{5wa^4}{8EI} \quad \text{Ans}$$

From *Mechanics of Materials*, Sixth Edition by R. C. Hibbeler, ISBN 0-13-191345-X.

© 2005 R. C. Hibbeler. Published by Pearson Prentice Hall,

Pearson Education, Inc., Upper Saddle River, NJ. All rights reserved.

This material is protected under all copyright laws as they currently exist. No portion of this material may be reproduced, in any form or by any means, without permission in writing from the publisher.

14-154 Solve Prob. 14-113 using Castigliano's theorem.

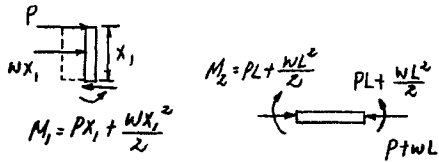
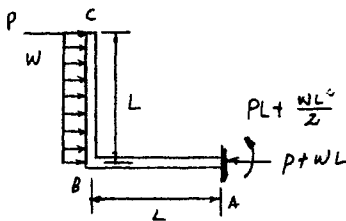
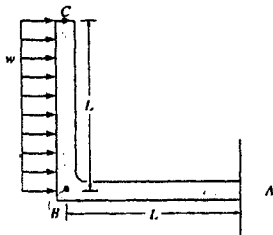

$$M_1 = Px_1 + \frac{wx_1^2}{2}$$

$$\frac{\partial M_1}{\partial P} = x_1 \quad \frac{\partial M_2}{\partial P} = L$$

Setting $P = 0$

$$M_1 = \frac{wx_1^2}{2} \quad M_2 = \frac{wL^2}{2}$$

$$\Delta_C = \int_0^L M \left(\frac{\partial M}{\partial P} \right) \frac{dx}{EI} = \frac{1}{EI} \left[\int_0^L \frac{wx_1^2}{2} (x_1) dx_1 + \int_0^L \frac{wL^2}{2} L dx_2 \right] = \frac{5wL^4}{8EI} \quad \text{Ans}$$

From *Mechanics of Materials*, Sixth Edition by R. C. Hibbeler, ISBN 0-13-191345-X.

© 2005 R. C. Hibbeler. Published by Pearson Prentice Hall,

Pearson Education, Inc., Upper Saddle River, NJ. All rights reserved.

This material is protected under all copyright laws as they currently exist. No portion of this material may be reproduced, in any form or by any means, without permission in writing from the publisher.

14-155 Solve Prob. 14-114 using Castigliano's theorem.

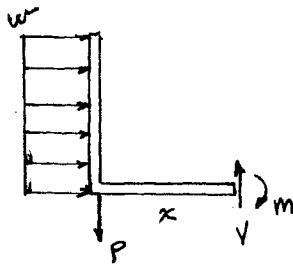
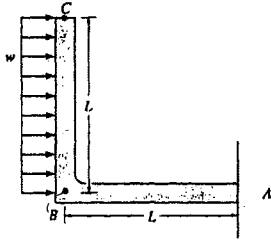

P does not influence moment within segment.

$$M = Px = \frac{wL^2}{2}x$$

$$\frac{\partial M}{\partial P} = x$$

Set $P = 0$

$$\Delta_B = \int_0^L M \left(\frac{\partial M}{\partial P} \right) \frac{dx}{EI} = \int_0^L \left(\frac{wL^2}{2} \right) (x) \frac{dx}{EI} = \frac{wL^4}{4EI} \quad \text{Ans}$$

From *Mechanics of Materials*, Sixth Edition by R. C. Hibbeler, ISBN 0-13-191345-X.

© 2005 R. C. Hibbeler. Published by Pearson Prentice Hall,

Pearson Education, Inc., Upper Saddle River, NJ. All rights reserved.

This material is protected under all copyright laws as they currently exist. No portion of this material may be reproduced, in any form or by any means, without permission in writing from the publisher.

*14-156 Solve Prob. 14-108 using Castigliano's theorem.

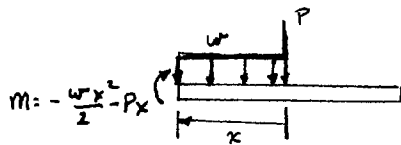
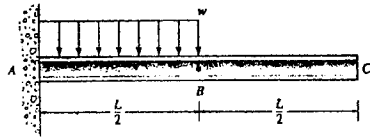

$$M = \frac{-wx^2}{2} - Px$$

$$\frac{\partial M}{\partial P} = -x$$

$$\Delta_B = \int_0^L \left(\frac{\partial M}{\partial P} \right) \frac{dx}{EI} = \int_0^{\frac{L}{2}} \frac{\left(\frac{-wx^2}{2} \right) (-1)}{EI} dx = \frac{w \left(\frac{L}{2} \right)^4}{8EI}$$

$$= \frac{wL^4}{128EI} \quad \text{Ans}$$

From *Mechanics of Materials*, Sixth Edition by R. C. Hibbeler, ISBN 0-13-191345-X.

© 2005 R. C. Hibbeler. Published by Pearson Prentice Hall,

Pearson Education, Inc., Upper Saddle River, NJ. All rights reserved.

This material is protected under all copyright laws as they currently exist. No portion of this material may be reproduced, in any form or by any means, without permission in writing from the publisher.

14-157 Solve Prob. 14-116 using Castigliano's theorem.

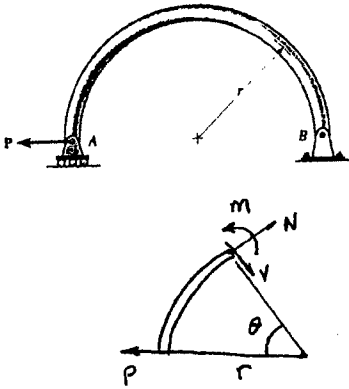

$$M = Pr \sin \theta$$

$$\frac{\partial M}{\partial P} = r \sin \theta$$

$$\begin{aligned} \Delta_A &= \int_0^L M \left(\frac{\partial M}{\partial P} \right) \frac{dx}{EI} = \int_0^\pi Pr^2 \sin^2 \theta \frac{(rd\theta)}{EI} \\ &= \frac{Pr^3}{EI} \left[\frac{1}{2} \theta - \frac{1}{4} \sin 2\theta \right] \Big|_0^\pi = \frac{\pi Pr^3}{2EI} \quad \text{Ans} \end{aligned}$$

From *Mechanics of Materials*, Sixth Edition by R. C. Hibbeler, ISBN 0-13-191345-X.

© 2005 R. C. Hibbeler. Published by Pearson Prentice Hall,

Pearson Education, Inc., Upper Saddle River, NJ. All rights reserved.

This material is protected under all copyright laws as they currently exist. No portion of this material may be reproduced, in any form or by any means, without permission in writing from the publisher.

14-158 Solve Prob. 14-115 using Castigliano's theorem.

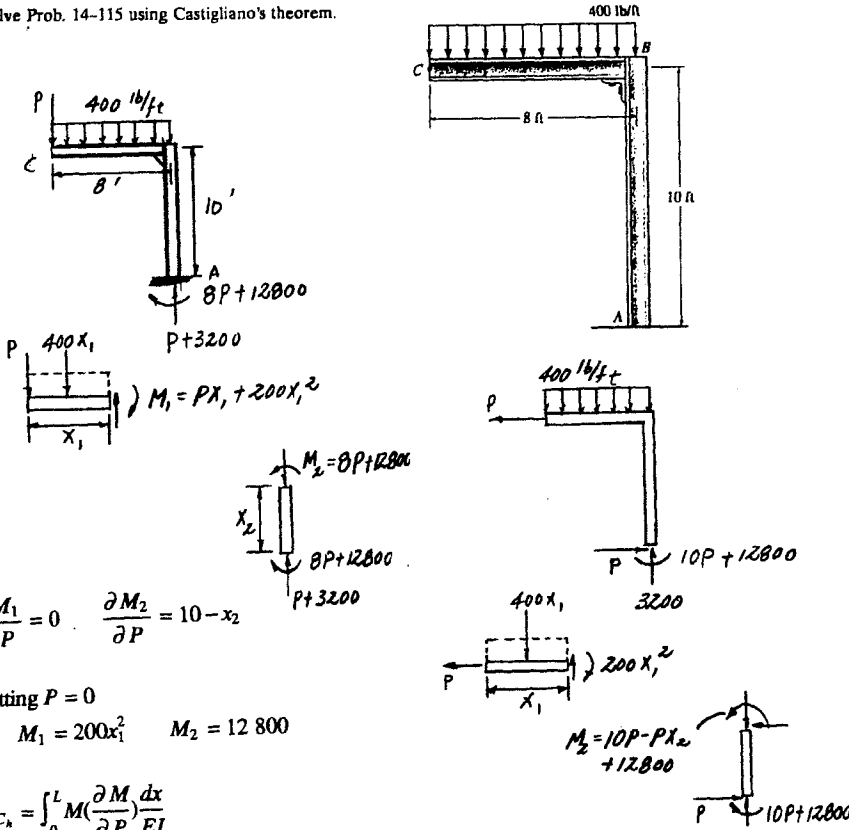

$$\frac{\partial M_1}{\partial P} = 0 \quad \frac{\partial M_2}{\partial P} = 10 - x_2$$

Setting $P = 0$

$$M_1 = 200x_1^2 \quad M_2 = 12800$$

$$\Delta C_h = \int_0^L M \left(\frac{\partial M}{\partial P} \right) \frac{dx}{EI}$$

$$= \frac{1}{EI} \left[\int_0^8 (200x_1^2)(0) dx_1 + \int_0^{10} 12800(10 - x_2) dx_2 \right] = \frac{640000 \text{ lb} \cdot \text{ft}^3}{EI} \quad \text{Ans}$$

$$\frac{\partial M_1}{\partial P} = x_1 \quad \frac{\partial M_2}{\partial P} = 8$$

Setting $P = 0$

$$M_1 = 200x_1^2 \quad M_2 = 12800$$

$$\Delta C_v = \int_0^L M \left(\frac{\partial M}{\partial P} \right) \frac{dx}{EI}$$

$$= \frac{1}{EI} \left[\int_0^8 (200x_1^2)(x_1) dx_1 + \int_0^{10} (12800)(8) dx_2 \right] = \frac{1228800 \text{ lb} \cdot \text{ft}^3}{EI} \quad \text{Ans}$$

From *Mechanics of Materials*, Sixth Edition by R. C. Hibbeler, ISBN 0-13-191345-X.

© 2005 R. C. Hibbeler. Published by Pearson Prentice Hall,

Pearson Education, Inc., Upper Saddle River, NJ. All rights reserved.

This material is protected under all copyright laws as they currently exist. No portion of this material may be reproduced, in any form or by any means, without permission in writing from the publisher.

14-159 Determine the bending strain energy in the beam due to the loading shown. EI is constant.

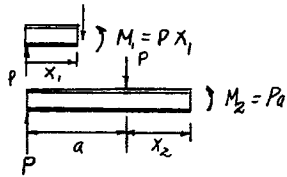
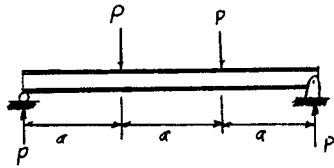
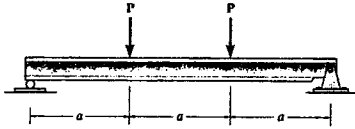

$$\begin{aligned}
 U_i &= \int_0^L \frac{M^2 dx}{2EI} = \frac{1}{2EI} \left[2 \int_0^a (Px_1)^2 dx_1 + \int_0^a (Pa)^2 dx_2 \right] \\
 &= \frac{5P^2 a^3}{6EI} \quad \text{Ans}
 \end{aligned}$$

From *Mechanics of Materials*, Sixth Edition by R. C. Hibbeler, ISBN 0-13-191345-X.

© 2005 R. C. Hibbeler. Published by Pearson Prentice Hall,

Pearson Education, Inc., Upper Saddle River, NJ. All rights reserved.

This material is protected under all copyright laws as they currently exist. No portion of this material may be reproduced, in any form or by any means, without permission in writing from the publisher.

*14-160 The L2 steel bolt has a diameter of 0.25 in., and the link AB has a rectangular cross section that is 0.5 in. wide by 0.2 in. thick. Determine the strain energy in the link AB due to bending, and in the bolt due to axial force. The bolt is tightened so that it has a tension of 350 lb. Neglect the hole in the link.

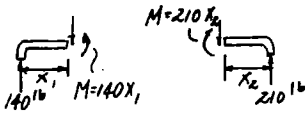
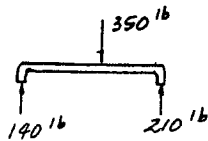
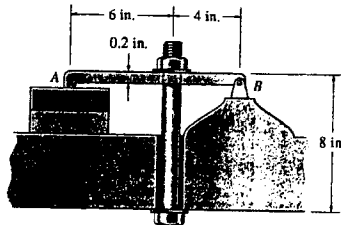

Bending strain energy :

$$(U_b)_i = \int_0^L \frac{M^2 dx}{2EI} = \frac{1}{2EI} \left[\int_0^6 (140x_1)^2 dx_1 + \int_0^4 (210x_2)^2 dx_2 \right]$$

$$= \frac{1.176(10^6)}{EI} = \frac{1.176(10^6)}{29(10^6)(\frac{1}{12})(0.5)(0.2^3)} = 122 \text{ in} \cdot \text{lb} = 10.1 \text{ ft} \cdot \text{lb} \quad \text{Ans}$$

Axial force strain energy :

$$(U_a)_i = \int_0^L \frac{N^2 dx}{2EA} = \frac{N^2 L}{2AE} = \frac{(350)^2 (8)}{2(29)(10^6)(\frac{\pi}{4})(0.25^2)} = 0.344 \text{ in} \cdot \text{lb} \quad \text{Ans}$$

From *Mechanics of Materials*, Sixth Edition by R. C. Hibbeler, ISBN 0-13-191345-X.

© 2005 R. C. Hibbeler. Published by Pearson Prentice Hall,

Pearson Education, Inc., Upper Saddle River, NJ. All rights reserved.

This material is protected under all copyright laws as they currently exist. No portion of this material may be reproduced, in any form or by any means, without permission in writing from the publisher.

14-161 The cantilevered beam is subjected to a couple moment M_0 applied at its end. Determine the slope of the beam at B . EI is constant. Use the method of virtual work.

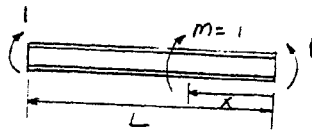
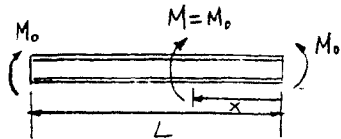

$$\theta_B = \int_0^L \frac{m_\theta M}{EI} dx = \int_0^L \frac{(1) M_0}{EI} dx$$

$$= \frac{M_0 L}{EI} \quad \text{Ans}$$

From *Mechanics of Materials*, Sixth Edition by R. C. Hibbeler, ISBN 0-13-191345-X.

© 2005 R. C. Hibbeler. Published by Pearson Prentice Hall,

Pearson Education, Inc., Upper Saddle River, NJ. All rights reserved.

This material is protected under all copyright laws as they currently exist. No portion of this material may be reproduced, in any form or by any means, without permission in writing from the publisher.

14-162 Solve Prob. 14-161 using Castigliano's theorem.

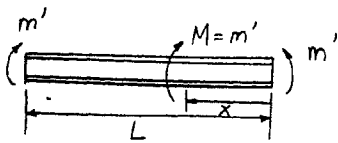
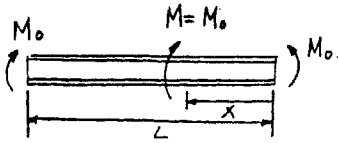
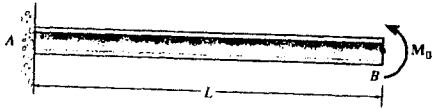

$$\begin{aligned} \theta_B &= \int_0^L M \left(\frac{\partial M}{\partial M'} \right) \frac{dx}{EI} = \int_0^L \frac{M_0 (1)}{EI} dx \\ &= \frac{M_0 L}{EI} \quad \text{Ans} \end{aligned}$$

From *Mechanics of Materials*, Sixth Edition by R. C. Hibbeler, ISBN 0-13-191345-X.

© 2005 R. C. Hibbeler. Published by Pearson Prentice Hall,

Pearson Education, Inc., Upper Saddle River, NJ. All rights reserved.

This material is protected under all copyright laws as they currently exist. No portion of this material may be reproduced, in any form or by any means, without permission in writing from the publisher.

14-163. The cantilevered beam is subjected to a couple moment M_0 applied at its end. Determine the displacement of the beam at B . EI is constant. Use the method of virtual work.

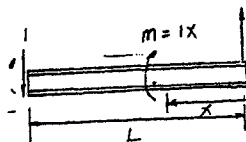
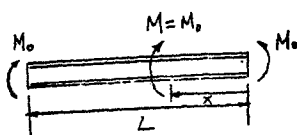
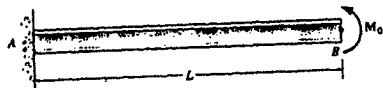

$$\begin{aligned} \Delta_B &= \int_0^L \frac{mM}{EI} dx = \int_0^L \frac{(1x)M_0}{EI} dx \\ &= \frac{M_0 L^2}{2EI} \quad \text{Ans} \end{aligned}$$

From *Mechanics of Materials*, Sixth Edition by R. C. Hibbeler, ISBN 0-13-191345-X.

© 2005 R. C. Hibbeler. Published by Pearson Prentice Hall,

Pearson Education, Inc., Upper Saddle River, NJ. All rights reserved.

This material is protected under all copyright laws as they currently exist. No portion of this material may be reproduced, in any form or by any means, without permission in writing from the publisher.

*14-164. Solve Prob. 14-163 using Castigliano's theorem.

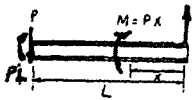
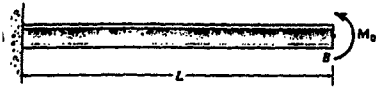

$$\begin{aligned}\Delta_B &= \int_0^L M \left(\frac{\partial M}{\partial P} \right) \frac{dx}{EI} = \int_0^L \frac{M_0 (Lx)}{EI} dx \\ &= \frac{M_0 L^2}{2EI} \quad \text{Ans}\end{aligned}$$

From *Mechanics of Materials*, Sixth Edition by R. C. Hibbeler, ISBN 0-13-191345-X.

© 2005 R. C. Hibbeler. Published by Pearson Prentice Hall,

Pearson Education, Inc., Upper Saddle River, NJ. All rights reserved.

This material is protected under all copyright laws as they currently exist. No portion of this material may be reproduced, in any form or by any means, without permission in writing from the publisher.

14-165 Determine the vertical displacement of joint A. Each bar is made of A-36 steel and has a cross-sectional area of 600 mm². Use the conservation of energy.

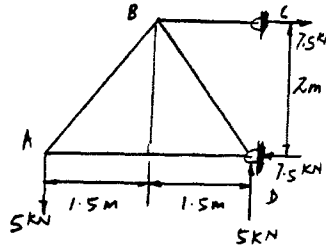
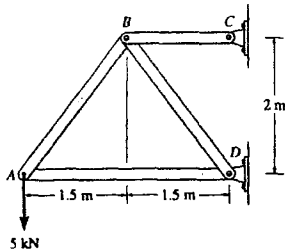

Joint A :

$$+\uparrow \Sigma F_y = 0; \quad \frac{4}{5}F_{AB} - 5 = 0 \quad F_{AB} = 6.25 \text{ kN}$$

$$\leftarrow \Sigma F_x = 0; \quad F_{AD} - \frac{3}{5}(6.25) = 0 \quad F_{AD} = 3.75 \text{ kN}$$

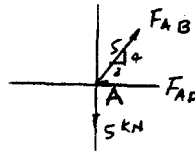

Joint B :

$$+\uparrow \Sigma F_y = 0; \quad \frac{4}{5}F_{BD} - \frac{4}{5}(6.25) = 0 \quad F_{BD} = 6.25 \text{ kN}$$

$$\rightarrow \Sigma F_x = 0; \quad F_{BC} - 2\left(\frac{3}{5}\right)(6.25) = 0 \quad F_{BC} = 7.5 \text{ kN}$$

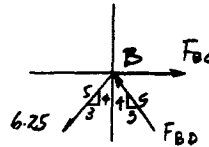

Conservation of energy :

$$U_e = U_i$$

$$\frac{1}{2}P\Delta = \Sigma \frac{N^2L}{2AE}$$

$$\frac{1}{2}(5)(10^3)\Delta_A = \frac{1}{2AE} = [(6.25(10^3))^2(2.5) + (3.75(10^3))^2(3) + (6.25(10^3))^2(2.5) + (7.5(10^3))^2(1.5)]$$

$$\Delta_A = \frac{64\,375}{AE} = \frac{64\,375}{600(10^{-6})(200)(10^9)} = 0.5364(10^{-3}) \text{ m} = 0.536 \text{ mm} \quad \text{Ans}$$

From *Mechanics of Materials*, Sixth Edition by R. C. Hibbeler, ISBN 0-13-191345-X.

© 2005 R. C. Hibbeler. Published by Pearson Prentice Hall,

Pearson Education, Inc., Upper Saddle River, NJ. All rights reserved.

This material is protected under all copyright laws as they currently exist. No portion of this material may be reproduced, in any form or by any means, without permission in writing from the publisher.

14-166 Determine the displacement of point B on the aluminum beam. $E_{al} = 10.6(10^3)$ ksi. Use the conservation of energy.

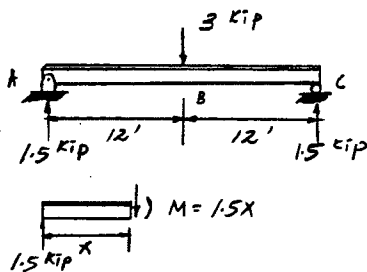
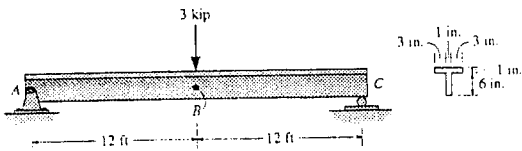

$$U_i = \int_0^L \frac{M^2 dx}{2EI} = (2) \frac{1}{2EI} \int_0^{12(12)} (1.5x)^2 dx = \frac{2239488}{EI}$$

$$U_e = \frac{1}{2} P \Delta = \frac{1}{2} (3) \Delta_B = 1.5 \Delta_B$$

Conservation of energy :

$$U_e = U_i$$

$$1.5 \Delta_B = \frac{2239488}{EI}$$

$$\Delta_B = \frac{1492992}{EI}$$

$$\bar{y} = \frac{0.5(7)(1) + (4)(6)(1)}{7(1) + 6(1)} = 2.1154 \text{ in.}$$

$$I = \frac{1}{12} (7)(1^3) + (7)(1)(2.1154 - 0.5)^2 + \frac{1}{12} (1)(6^3) + (1)(6)(4 - 2.1154)^2 = 58.16 \text{ in}^4$$

$$\Delta_B = \frac{1492992}{(10.6)(10^3)(58.16)} = 2.42 \text{ in.} \quad \text{Ans}$$

From *Mechanics of Materials*, Sixth Edition by R. C. Hibbeler, ISBN 0-13-191345-X.

© 2005 R. C. Hibbeler. Published by Pearson Prentice Hall,

Pearson Education, Inc., Upper Saddle River, NJ. All rights reserved.

This material is protected under all copyright laws as they currently exist. No portion of this material may be reproduced, in any form or by any means, without permission in writing from the publisher.

*14-167 A 20-lb weight is dropped from a height of 4 ft onto the end of a cantilevered A-36 steel beam. If the beam is a W 12 × 50, determine the maximum stress developed in the beam.

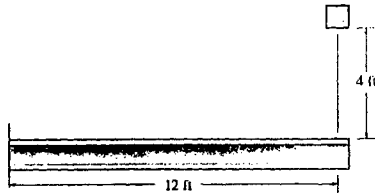

From Appendix C :

$$\Delta_{st} = \frac{PL^3}{3EI} = \frac{20(12(12))^3}{3(29)(10^6)(394)} = 1.742216(10^{-3}) \text{ in.}$$

$$n = 1 + \sqrt{1 + 2\left(\frac{h}{\Delta_{st}}\right)} = 1 + \sqrt{1 + 2\left(\frac{4(12)}{1.742216(10^{-3})}\right)} = 235.74$$

$$\sigma_{max} = n\sigma_{st} = 235.74\left(\frac{20(12)(12)\left(\frac{12.19}{2}\right)}{394}\right) = 10503 \text{ psi} = 10.5 \text{ ksi} < \sigma_y \quad \text{OK} \quad \text{Ans}$$

From *Mechanics of Materials*, Sixth Edition by R. C. Hibbeler, ISBN 0-13-191345-X.

© 2005 R. C. Hibbeler. Published by Pearson Prentice Hall,

Pearson Education, Inc., Upper Saddle River, NJ. All rights reserved.

This material is protected under all copyright laws as they currently exist. No portion of this material may be reproduced, in any form or by any means, without permission in writing from the publisher.

14-168 Determine the vertical displacement of joint B. For each member $A = 400 \text{ mm}^2$, $E = 200 \text{ GPa}$. Use the method of virtual work.

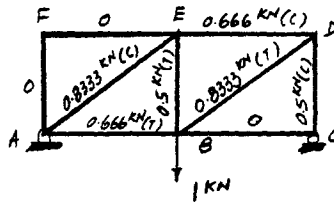
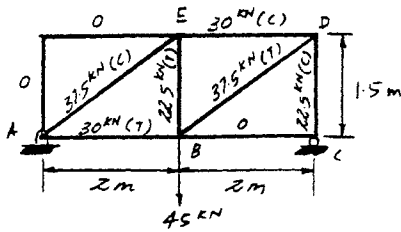
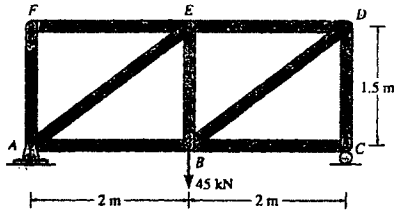

Member	n	N	L	nNL
AF	0	0	1.5	0
AE	-0.8333	-37.5	2.5	78.125
AB	0.6667	30.0	2.0	40.00
EF	0	0	2.0	0
EB	0.50	22.5	1.5	16.875
ED	-0.6667	-30.0	2.0	40.00
BC	0	0	2.0	0
BD	0.8333	37.5	2.5	78.125
CD	-0.5	-22.5	1.5	16.875

$$\Sigma = 270$$

$$1 \cdot \Delta_B = \Sigma \frac{nNL}{AE}$$

$$\Delta_B = \frac{270(10^3)}{400(10^{-6})(200)(10^9)} = 3.375(10^{-3})\text{m} = 3.38 \text{ mm} \quad \text{Ans}$$

From *Mechanics of Materials*, Sixth Edition by R. C. Hibbeler, ISBN 0-13-191345-X.

© 2005 R. C. Hibbeler. Published by Pearson Prentice Hall,

Pearson Education, Inc., Upper Saddle River, NJ. All rights reserved.

This material is protected under all copyright laws as they currently exist. No portion of this material may be reproduced, in any form or by any means, without permission in writing from the publisher.

14-169 Solve Prob. 14-168 using Castigliano's theorem.

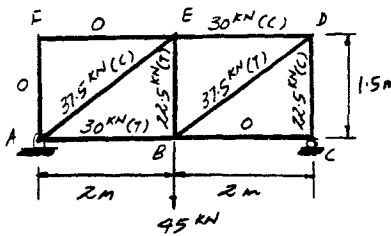
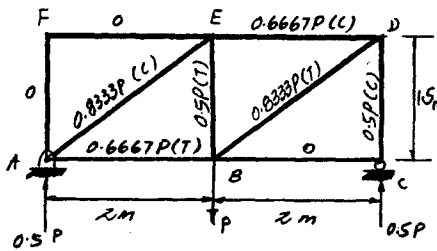
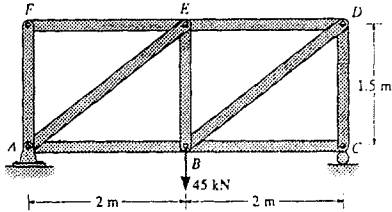

Member	N	$\partial N / \partial P$	N (P = 45)	L	N($\partial N / \partial P$)L
AF	0	0	0	1.5	0
AE	-0.8333P	-0.8333	-37.5	2.5	78.125
AB	0.6667P	0.6667	30.0	2.0	40.00
BE	0.5P	0.5	22.5	1.5	16.875
BD	0.8333P	0.8333	37.5	2.5	78.125
BC	0	0	0	2.0	0
CD	-0.5P	-0.5	-22.5	1.5	16.875
DE	-0.6667P	-0.6667	-30.0	2.0	40.00
EF	0	0	0	2.0	0

$\Sigma = 270$

$$\Delta_B = \Sigma N \left(\frac{\partial N}{\partial P} \right) \frac{L}{AE} = \frac{270}{AE}$$

$$= \frac{270(10^3)}{400(10^{-6})(200)(10^9)} = 3.375(10^{-3}) \text{ m} = 3.38 \text{ mm} \quad \text{Ans}$$

From *Mechanics of Materials*, Sixth Edition by R. C. Hibbeler, ISBN 0-13-191345-X.
 © 2005 R. C. Hibbeler. Published by Pearson Prentice Hall,
 Pearson Education, Inc., Upper Saddle River, NJ. All rights reserved.
 This material is protected under all copyright laws as they currently exist. No portion of this material may be reproduced, in any form or by any means, without permission in writing from the publisher.

14-170. Determine the vertical displacement of joint E. For each member $A = 400 \text{ mm}^2$, $E = 200 \text{ GPa}$. Use the method of virtual work.

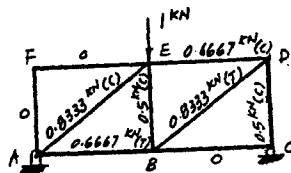
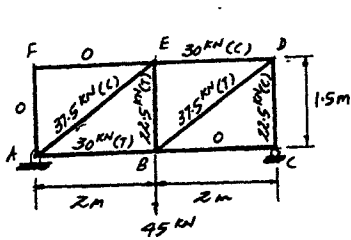
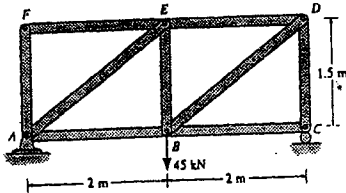

Member	n	N	L	nNL
AF	0	0	1.5	0
AE	-0.8333	-37.5	2.5	78.125
AB	0.6667	30.0	2.0	40.00
EF	0	0	2.0	0
EB	-0.50	30.0	1.5	-16.875
ED	-0.6667	30.0	2.0	40.00
BC	0	0	2.0	0
BD	0.8333	37.5	2.5	78.125
CD	-0.5	-22.5	1.5	16.875

$$\Sigma = 236.25$$

$$1 \cdot \Delta_E = \Sigma \frac{nNL}{AE}$$

$$\Delta_E = \frac{236.25(10^3)}{400(10^{-6})(200)(10^9)} = 2.95(10^{-3}) = 2.95 \text{ mm} \quad \text{Ans}$$

From *Mechanics of Materials*, Sixth Edition by R. C. Hibbeler, ISBN 0-13-191345-X.

© 2005 R. C. Hibbeler. Published by Pearson Prentice Hall,

Pearson Education, Inc., Upper Saddle River, NJ. All rights reserved.

This material is protected under all copyright laws as they currently exist. No portion of this material may be reproduced, in any form or by any means, without permission in writing from the publisher.

14-17L. Solve Prob. 14–170 using Castigliano’s theorem.

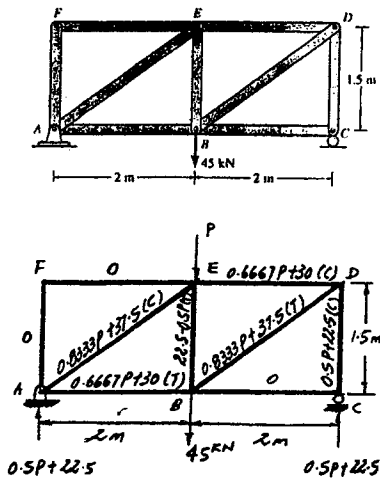

Member	N	$\partial N / \partial P$	$N(P = 45)$	L	$N(\partial N / \partial P)L$
AF	0	0	0	1.5	0
AE	$-(0.8333P + 37.5)$	-0.8333	-37.5	2.5	78.125
AB	$0.6667P + 30$	0.6667	30.0	2.0	40.00
BE	$22.5 - 0.5P$	-0.5	22.5	1.5	-16.875
BD	$0.8333P + 37.5$	0.8333	37.5	2.5	78.125
BC	0	0	0	2.0	0
CD	$-(0.5P + 22.5)$	-0.5	-22.5	1.5	16.875
DE	$-(0.6667P + 30)$	-0.6667	-30.0	2.0	40.00
EF	0	0	0	2.0	0

$$\Sigma = 236.25$$

$$\begin{aligned} \Delta_E &= \Sigma N \left(\frac{\partial N}{\partial P} \right) \frac{L}{AE} = \frac{236.25}{AE} \\ &= \frac{236.25(10^3)}{400(10^{-6})(200)(10^9)} = 2.95(10^{-3})\text{m} = 2.95 \text{ mm} \quad \text{Ans} \end{aligned}$$

From *Mechanics of Materials*, Sixth Edition by R. C. Hibbeler, ISBN 0-13-191345-X.

© 2005 R. C. Hibbeler. Published by Pearson Prentice Hall,

Pearson Education, Inc., Upper Saddle River, NJ. All rights reserved.

This material is protected under all copyright laws as they currently exist. No portion of this material may be reproduced, in any form or by any means, without permission in writing from the publisher.

A-1 Determine the location \bar{y} of the centroid C for the beam's cross-sectional area. The beam is symmetric with respect to the y axis.

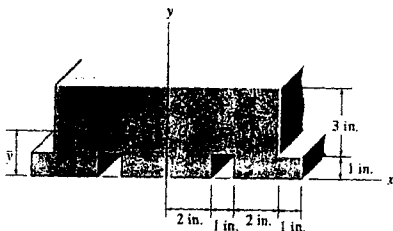

$$\Sigma \bar{y}A = (2)(6)(4) - (0.5)(1)(1) - (2.5)(3)(1) = 40 \text{ in}^3$$

$$\Sigma A = 6(4) - 1(1) - 3(1) = 20 \text{ in}^2$$

$$\bar{y} = \frac{\Sigma \bar{y}A}{\Sigma A} = \frac{40}{20} = 2.0 \text{ in.} \quad \text{Ans}$$

From *Mechanics of Materials*, Sixth Edition by R. C. Hibbeler, ISBN 0-13-191345-X.

© 2005 R. C. Hibbeler. Published by Pearson Prentice Hall,

Pearson Education, Inc., Upper Saddle River, NJ. All rights reserved.

This material is protected under all copyright laws as they currently exist. No portion of this material may be reproduced, in any form or by any means, without permission in writing from the publisher.

A-2 Determine \bar{y} , which locates the centroid, and then find the moments of inertia I_x and I_y for the T-beam.

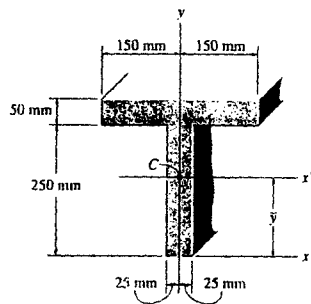

$$\Sigma \bar{y}A = 125(50)(250) + 275(300)(50) = 5687500 \text{ mm}^3$$

$$\Sigma A = 50(250) + 300(50) = 27500 \text{ mm}^2$$

$$\bar{y} = \frac{\Sigma \bar{y}A}{\Sigma A} = \frac{5687500}{27500} = 206.82 \text{ mm} = 207 \text{ mm} \quad \text{Ans}$$

$$\begin{aligned} \bar{I}_x &= \frac{1}{12}(50)(250)^3 + 50(250)(206.82 - 125)^2 + \\ &\quad \frac{1}{12}(300)((50)^3 + 300(50)(275 - 206.82)^2 = 222(10^6) \text{ mm}^4 \quad \text{Ans} \end{aligned}$$

$$\bar{I}_y = \frac{1}{12}(250)(50^3) + \frac{1}{12}(50)(300^3) = 115(10^6) \text{ mm}^4 \quad \text{Ans}$$

From *Mechanics of Materials*, Sixth Edition by R. C. Hibbeler, ISBN 0-13-191345-X.

© 2005 R. C. Hibbeler. Published by Pearson Prentice Hall,

Pearson Education, Inc., Upper Saddle River, NJ. All rights reserved.

This material is protected under all copyright laws as they currently exist. No portion of this material may be reproduced, in any form or by any means, without permission in writing from the publisher.

A-3 Determine the location (\bar{x}, \bar{y}) of the centroid C then find the moments of inertia $I_{x'}$ and $I_{y'}$.

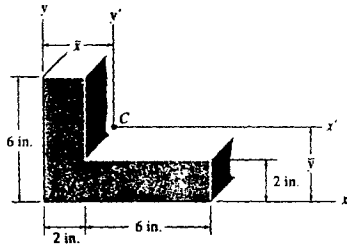

$$\bar{x} = \frac{\Sigma \bar{x}A}{\Sigma A} = \frac{(1)(2)(4) + (4)(2)(8)}{2(4) + (2)(8)} = 3 \text{ in.} \quad \text{Ans}$$

$$\bar{y} = \frac{\Sigma \bar{y}A}{\Sigma A} = \frac{(1)(6)(2) + (3)(2)(6)}{(6)(2) + (2)(6)} = 2 \text{ in.} \quad \text{Ans}$$

$$\bar{I}_{x'} = \frac{1}{12}(6)(2^3) + (6)(2)(2-1)^2 + \frac{1}{12}(2)(6^3) + 2(6)(3-2)^2 = 64 \text{ in}^4 \quad \text{Ans}$$

$$\bar{I}_{y'} = \frac{1}{12}(4)(2^3) + (4)(2)(3-1)^2 + \frac{1}{12}(2)(8^3) + (2)(8)(4-3)^2 = 136 \text{ in}^4 \quad \text{Ans}$$

*A-4 Determine the centroid \bar{y} for the beam's cross-sectional area, then find $\bar{I}_{x'}$.

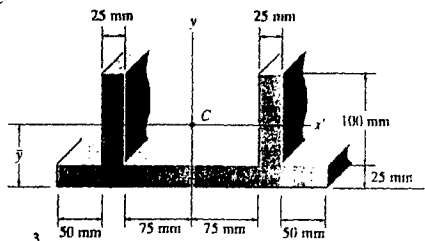

$$\Sigma \bar{y}A = 12.5(150)(25) + (75)(100)(25) = 234\,375 \text{ mm}^3$$

$$\Sigma A = 150(25) + 100(25) = 6250 \text{ mm}^2$$

$$\bar{y} = \frac{\Sigma \bar{y}A}{\Sigma A} = \frac{234\,375}{6250} = 37.5 \text{ mm} \quad \text{Ans}$$

$$\bar{I}_{x'} = \frac{1}{12}(300)(25^3) + 300(25)(37.5 - 12.5)^2 + 2\left[\frac{1}{12}(25)(100^3) + 25(100)(75 - 37.5)^2\right]$$

$$= 16.3(10^6) \text{ mm}^4 \quad \text{Ans}$$

From *Mechanics of Materials*, Sixth Edition by R. C. Hibbeler, ISBN 0-13-191345-X.

© 2005 R. C. Hibbeler. Published by Pearson Prentice Hall,

Pearson Education, Inc., Upper Saddle River, NJ. All rights reserved.

This material is protected under all copyright laws as they currently exist. No portion of this material may be reproduced, in any form or by any means, without permission in writing from the publisher.

*A-4 Determine the centroid \bar{y} for the beam's cross-sectional area, then find \bar{I}_x' .

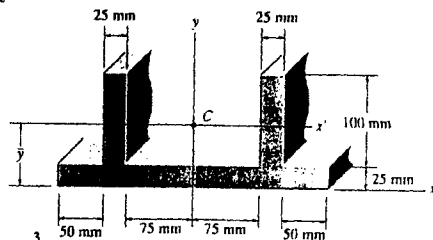

$$\Sigma \bar{y}A = 12.5(150)(25) + (75)(100)(25) = 234\,375 \text{ mm}^3$$

$$\Sigma A = 150(25) + 100(25) = 6250 \text{ mm}^2$$

$$\bar{y} = \frac{\Sigma \bar{y}A}{\Sigma A} = \frac{234\,375}{6250} = 37.5 \text{ mm} \quad \text{Ans}$$

$$\bar{I}_x' = \frac{1}{12}(300)(25^3) + 300(25)(37.5 - 12.5)^2 + 2\left[\frac{1}{12}(25)(100^3) + 25(100)(75 - 37.5)^2\right]$$

$$= 16.3(10^6) \text{ mm}^4 \quad \text{Ans}$$

From *Mechanics of Materials*, Sixth Edition by R. C. Hibbeler, ISBN 0-13-191345-X.

© 2005 R. C. Hibbeler. Published by Pearson Prentice Hall,

Pearson Education, Inc., Upper Saddle River, NJ. All rights reserved.

This material is protected under all copyright laws as they currently exist. No portion of this material may be reproduced, in any form or by any means, without permission in writing from the publisher.

A-5 Determine I_y for the beam having the cross-sectional area shown.

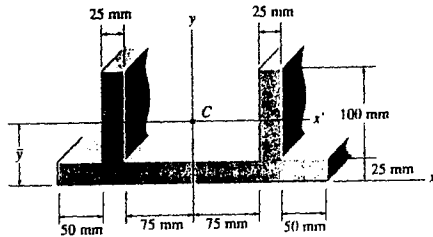

$$I_y = \frac{1}{12}(25)(300^3) + 2\left[\frac{1}{12}(100)(25^3) + 100(25)(87.5^2)\right] = 94.8(10^6) \text{ mm}^4 \quad \text{Ans}$$

From *Mechanics of Materials*, Sixth Edition by R. C. Hibbeler, ISBN 0-13-191345-X.

© 2005 R. C. Hibbeler. Published by Pearson Prentice Hall,

Pearson Education, Inc., Upper Saddle River, NJ. All rights reserved.

This material is protected under all copyright laws as they currently exist. No portion of this material may be reproduced, in any form or by any means, without permission in writing from the publisher.

A-6 Determine \bar{x} which locates the centroid C , and then find the moments of inertia \bar{I}_x and \bar{I}_y for the shaded area.

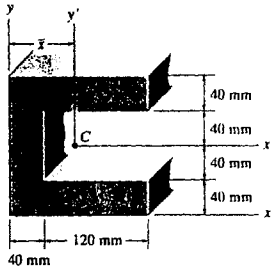

$$\bar{x} = \frac{\Sigma \bar{x}A}{\Sigma A} = \frac{(20)(160)(40) + 2[100(120)(40)]}{160(40) + 2[120(40)]} = 68.0 \text{ mm} \quad \text{Ans}$$

$$\bar{I}_x = \frac{1}{12}(160)(160)^3 - \frac{1}{12}(120)(80)^3 = 49.5(10^6) \text{ mm}^4 \quad \text{Ans}$$

$$\begin{aligned} \bar{I}_y &= \left[\frac{1}{12}(160)(160)^3 + (160)(160)(80 - 68.0)^2 \right] - \left[\frac{1}{12}(80)(120)^3 + 80(120)(100 - 68.0)^2 \right] \\ &= 36.9(10^6) \text{ mm}^4 \quad \text{Ans} \end{aligned}$$

From *Mechanics of Materials*, Sixth Edition by R. C. Hibbeler, ISBN 0-13-191345-X.

© 2005 R. C. Hibbeler. Published by Pearson Prentice Hall,

Pearson Education, Inc., Upper Saddle River, NJ. All rights reserved.

This material is protected under all copyright laws as they currently exist. No portion of this material may be reproduced, in any form or by any means, without permission in writing from the publisher.

A-7 Determine the moments of inertia I_x and I_y of the Z-section. The origin of coordinates is at the centroid C .

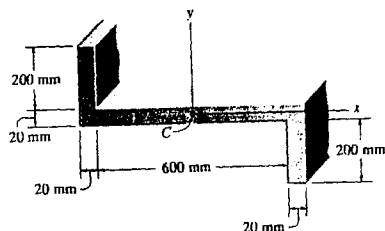

$$I_x = \frac{1}{12}(600)(20)^3 + 2\left[\frac{1}{12}(20)(220)^3 + 20(220)(100)^2\right]$$

$$= 123.89(10^6) \text{ mm}^4 = 124(10^6) \text{ mm}^4 \quad \text{Ans}$$

$$I_y = \frac{1}{12}(20)(600^3) + 2\left[\frac{1}{12}(220)(20)^3 + 220(20)(310)^2\right]$$

$$= 1205.97(10^6) \text{ mm}^4 = 1.21(10^9) \text{ mm}^4 \quad \text{Ans}$$

From *Mechanics of Materials*, Sixth Edition by R. C. Hibbeler, ISBN 0-13-191345-X.

© 2005 R. C. Hibbeler. Published by Pearson Prentice Hall,

Pearson Education, Inc., Upper Saddle River, NJ. All rights reserved.

This material is protected under all copyright laws as they currently exist. No portion of this material may be reproduced, in any form or by any means, without permission in writing from the publisher.

*A-8 Determine the location (\bar{x}, \bar{y}) of the centroid C of the cross-sectional area for the angle, then find the product of inertia with respect to the x and y axes and with respect to the x' and y' axes.

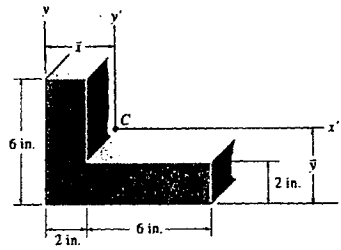

$$\bar{x} = \frac{\Sigma \bar{x}A}{\Sigma A} = \frac{(1)(2)(4) + (4)(2)(8)}{2(4) + (2)(8)} = 3 \text{ in.} \quad \text{Ans}$$

$$\bar{y} = \frac{\Sigma \bar{y}A}{\Sigma A} = \frac{(1)(6)(2) + (3)(2)(6)}{(6)(2) + (2)(6)} = 2 \text{ in.} \quad \text{Ans}$$

$$I_{xy'} = \Sigma \bar{x}\bar{y}'A = (-2)(1)(6)(2) + (2)(-1)(6)(2) = -48 \text{ in}^4 \quad \text{Ans}$$

From *Mechanics of Materials*, Sixth Edition by R. C. Hibbeler, ISBN 0-13-191345-X.

© 2005 R. C. Hibbeler. Published by Pearson Prentice Hall,

Pearson Education, Inc., Upper Saddle River, NJ. All rights reserved.

This material is protected under all copyright laws as they currently exist. No portion of this material may be reproduced, in any form or by any means, without permission in writing from the publisher.

A-9 Determine the product of inertia of the cross-sectional area with respect to the x and y axes that have their origin located at the centroid C .

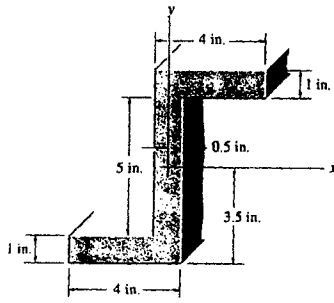

$$I_{xy} = \sum \bar{x}\bar{y}A = (1.5)(3)(4)(1) + (0)(0)(5)(1) + (-1.5)(-3)(4)(1) = 36 \text{ in.}^4 \quad \mathbf{Ans}$$

From *Mechanics of Materials*, Sixth Edition by R. C. Hibbeler, ISBN 0-13-191345-X.

© 2005 R. C. Hibbeler. Published by Pearson Prentice Hall,

Pearson Education, Inc., Upper Saddle River, NJ. All rights reserved.

This material is protected under all copyright laws as they currently exist. No portion of this material may be reproduced, in any form or by any means, without permission in writing from the publisher.

A-10 Locate the centroid (\bar{x}, \bar{y}) of the channel section and then determine the moments of inertia \bar{I}_x and \bar{I}_y .

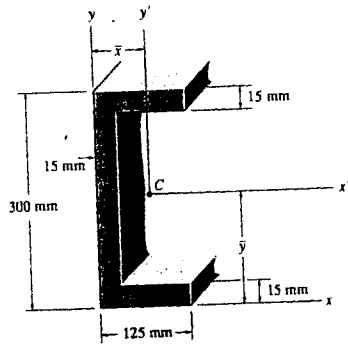

$$\bar{x} = \frac{\sum \bar{x}A}{\sum A} = \frac{(62.5)(2)(125)(15) + (7.5)(270)(15)}{2(125)(15) + 270(15)} = 33.942 \text{ mm} = 33.9 \text{ mm} \quad \text{Ans}$$

Due to symmetry $\bar{y} = 150 \text{ mm} \quad \text{Ans}$

$$\bar{I}_x = \frac{1}{12}(125)(300^3) - \frac{1}{12}(110)(270^3) = 101(10^6) \text{ mm}^4 \quad \text{Ans}$$

$$\begin{aligned} \bar{I}_y &= 2\left[\frac{1}{12}(15)(125^3) + 15(125)(62.5 - 33.942)^2\right] + \frac{1}{12}(270)(15^3) \\ &\quad + 270(15)(33.942 - 7.5)^2 = 10.8(10^6) \text{ mm}^4 \quad \text{Ans} \end{aligned}$$

From *Mechanics of Materials*, Sixth Edition by R. C. Hibbeler, ISBN 0-13-191345-X.

© 2005 R. C. Hibbeler. Published by Pearson Prentice Hall,

Pearson Education, Inc., Upper Saddle River, NJ. All rights reserved.

This material is protected under all copyright laws as they currently exist. No portion of this material may be reproduced, in any form or by any means, without permission in writing from the publisher.

A-11 Locate the centroid (\bar{x}, \bar{y}) of the channel section and then determine the product of inertia $I_{x'y'}$ with respect to the y' axes.

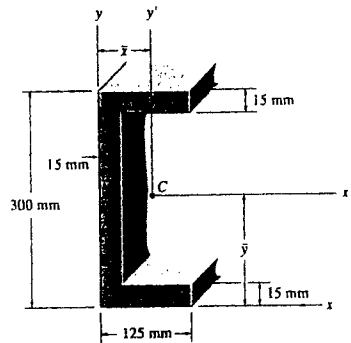

$$\bar{x} = \frac{\sum \bar{x}A}{\sum A} = \frac{(62.5)(2)(125)(15) + (7.5)(270)(15)}{2(125)(15) + 270(15)} = 33.942 \text{ mm} = 33.9 \text{ mm} \quad \text{Ans}$$

Due to symmetry $\bar{y} = 150 \text{ mm}$ **Ans**

$$\begin{aligned} I_{x'y'} &= \sum \bar{x}\bar{y}A = (62.5 - 33.942)(150 - 7.5)(15)(125) \\ &\quad + (7.5 - 33.942)(0)(270)(15) \\ &\quad + (62.5 - 33.942)(7.5 - 150)(15)(125) = 0 \quad \text{Ans} \end{aligned}$$

From *Mechanics of Materials*, Sixth Edition by R. C. Hibbeler, ISBN 0-13-191345-X.

© 2005 R. C. Hibbeler. Published by Pearson Prentice Hall,

Pearson Education, Inc., Upper Saddle River, NJ. All rights reserved.

This material is protected under all copyright laws as they currently exist. No portion of this material may be reproduced, in any form or by any means, without permission in writing from the publisher.

*A-12 Locate the position (\bar{x}, \bar{y}) for the centroid C of the cross sectional area and then determine the product of inertia with respect to the x' and y' axes.

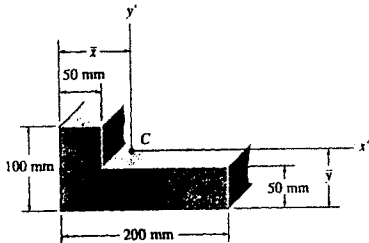

$$\bar{x} = \frac{\sum \bar{x}A}{\sum A} = \frac{25(50)(50) + 100(50)(200)}{50(50) + (50)(200)} = 85 \text{ mm} \quad \text{Ans}$$

$$\bar{y} = \frac{\sum \bar{y}A}{\sum A} = \frac{(50)(100)(50) + 25(150)(50)}{100(50) + 150(50)} = 35 \text{ mm} \quad \text{Ans}$$

$$I_{x'y'} = \sum \bar{x}\bar{y}A = (-85 + 25)(75 - 35)(50)(50) + (100 - 85)(-35 + 25)(200)(50) = -7.50(10^6) \text{ mm}^4 \quad \text{Ans}$$

From *Mechanics of Materials*, Sixth Edition by R. C. Hibbeler, ISBN 0-13-191345-X.

© 2005 R. C. Hibbeler. Published by Pearson Prentice Hall,

Pearson Education, Inc., Upper Saddle River, NJ. All rights reserved.

This material is protected under all copyright laws as they currently exist. No portion of this material may be reproduced, in any form or by any means, without permission in writing from the publisher.

A-13 Determine the product of inertia of the area with respect to the x and y axes.

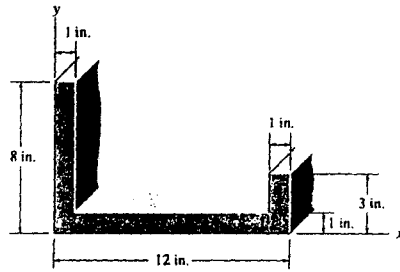

$$I_{xy} = \sum \bar{x}\bar{y}A = (0.5)(4)(8)(1) + (6)(0.5)(10)(1) + (11.5)(1.5)(3)(1) = 97.75 \text{ in}^4 \quad \mathbf{Ans}$$

From *Mechanics of Materials*, Sixth Edition by R. C. Hibbeler, ISBN 0-13-191345-X.

© 2005 R. C. Hibbeler. Published by Pearson Prentice Hall,

Pearson Education, Inc., Upper Saddle River, NJ. All rights reserved.

This material is protected under all copyright laws as they currently exist. No portion of this material may be reproduced, in any form or by any means, without permission in writing from the publisher.

A-14 Determine the moments of inertia $I_{x'}$ and $I_{y'}$ of the shaded area.

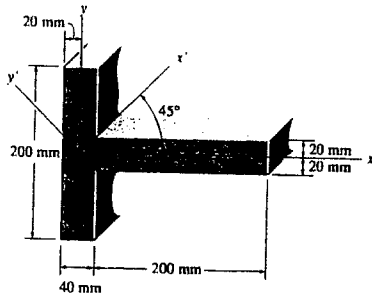

$$I_x = \frac{1}{12}(40)(200^3) + \frac{1}{12}(200)(40^3) = 27.733(10^6) \text{ mm}^4$$

$$I_y = \frac{1}{12}(200)(40^3) + \frac{1}{12}(40)(200^3) + (40)(200)(120^2) = 142.933(10^6) \text{ mm}^4$$

$$I_{xy} = 0 \quad (\text{Symmetry about } x \text{ axis})$$

$$I_{x'} = \frac{I_x + I_y}{2} + \frac{I_x - I_y}{2} \cos 2\theta - I_{xy} \sin 2\theta$$

$$= \left[\frac{27.733 + 142.933}{2} + \frac{27.733 - 142.933}{2} \cos 90^\circ + 0 \right] (10^6) = 85.3(10^6) \text{ mm}^4 \quad \text{Ans}$$

$$I_{y'} = \frac{I_x + I_y}{2} - \frac{I_x - I_y}{2} \cos 2\theta + I_{xy} \sin 2\theta$$

$$= \left[\frac{27.733 + 142.933}{2} - \frac{27.733 - 142.933}{2} \cos 90^\circ + 0 \right] (10^6) = 85.3(10^6) \text{ mm}^4 \quad \text{Ans}$$

From *Mechanics of Materials*, Sixth Edition by R. C. Hibbeler, ISBN 0-13-191345-X.

© 2005 R. C. Hibbeler. Published by Pearson Prentice Hall,

Pearson Education, Inc., Upper Saddle River, NJ. All rights reserved.

This material is protected under all copyright laws as they currently exist. No portion of this material may be reproduced, in any form or by any means, without permission in writing from the publisher.

A-15 Determine the moments of inertia $I_{x'}$ and $I_{y'}$ and the product of inertia $I_{x'y'}$ for the semicircular area.

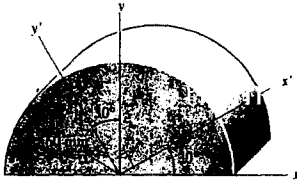

$$I_x = I_y = \frac{1}{8}(\pi)(60^4) = 5.0894(10^6) \text{ mm}^4$$

$$I_{xy} = 0 \quad (\text{symmetry about } y \text{ axis})$$

$$I_{x'} = \frac{I_x + I_y}{2} + \frac{I_x - I_y}{2} \cos 2\theta - I_{xy} \sin 2\theta$$

$$= \left[\frac{5.0894 + 5.0894}{2} + \frac{5.0894 - 5.0894}{2} \cos 60^\circ - 0 \right] (10^6) = 5.09(10^6) \text{ mm}^4 \quad \text{Ans}$$

$$I_{y'} = \frac{I_x + I_y}{2} - \frac{I_x - I_y}{2} \cos 2\theta + I_{xy} \sin 2\theta$$

$$= \left[\frac{5.0894 + 5.0894}{2} - \frac{5.0894 - 5.0894}{2} \cos 60^\circ + 0 \right] (10^6) = 5.09(10^6) \text{ mm}^4 \quad \text{Ans}$$

$$I_{x'y'} = \frac{I_x - I_y}{2} \sin 2\theta + I_{xy} \cos 2\theta$$

$$= \left[\frac{5.0894 - 5.0894}{2} \sin 60^\circ + 0 \right] (10^6) = 0 \quad \text{Ans}$$

From *Mechanics of Materials*, Sixth Edition by R. C. Hibbeler, ISBN 0-13-191345-X.

© 2005 R. C. Hibbeler. Published by Pearson Prentice Hall,

Pearson Education, Inc., Upper Saddle River, NJ. All rights reserved.

This material is protected under all copyright laws as they currently exist. No portion of this material may be reproduced, in any form or by any means, without permission in writing from the publisher.

*A-16 Determine the moments of inertia $I_{x'}$ and $I_{y'}$ and the product of inertia $I_{x'y'}$ for the rectangular area. The x' and y' axes pass through the centroid C .

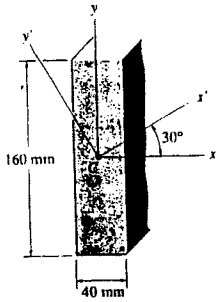

$$I_x = \frac{1}{12}(40)(160^3) = 13.653(10^6) \text{ mm}^4$$

$$I_y = \frac{1}{12}(160)(40^3) = 0.853(10^6) \text{ mm}^4$$

$$I_{xy} = 0 \quad (\text{symmetry})$$

$$I_{x'} = \frac{I_x + I_y}{2} + \frac{I_x - I_y}{2} \cos 2\theta - I_{xy} \sin 2\theta$$

$$= \left[\frac{13.653 + 0.853}{2} + \frac{13.653 - 0.853}{2} \cos 60^\circ - 0 \right] (10^6) = 10.5(10^6) \text{ mm}^4 \quad \text{Ans}$$

$$I_{y'} = \frac{I_x + I_y}{2} - \frac{I_x - I_y}{2} \cos 2\theta + I_{xy} \sin 2\theta$$

$$= \left[\frac{13.653 + 0.853}{2} - \frac{13.653 - 0.853}{2} \cos 60^\circ + 0 \right] (10^6) = 4.05(10^6) \text{ mm}^4 \quad \text{Ans}$$

$$I_{x'y'} = \frac{I_x - I_y}{2} \sin 2\theta + I_{xy} \cos 2\theta$$

$$= \left[\frac{13.653 - 0.853}{2} \sin 60^\circ + 0 \right] = 5.54(10^6) \text{ mm}^4 \quad \text{Ans}$$

From *Mechanics of Materials*, Sixth Edition by R. C. Hibbeler, ISBN 0-13-191345-X.

© 2005 R. C. Hibbeler. Published by Pearson Prentice Hall,

Pearson Education, Inc., Upper Saddle River, NJ. All rights reserved.

This material is protected under all copyright laws as they currently exist. No portion of this material may be reproduced, in any form or by any means, without permission in writing from the publisher.

A-17 Determine the principal moments of inertia of the cross-sectional area about the principal axes that have their origin located at the centroid *C*. Use the equations developed in Sec. A.4. For the calculation, assume all corners to be square.

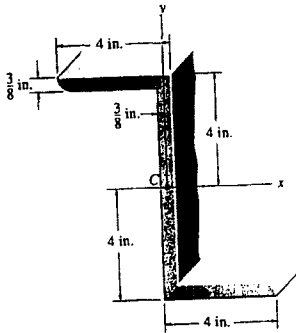

$$I_x = 2\left[\frac{1}{12}(4)(0.375)^3 + (4)(0.375)(4 - 0.1875)^2\right] + \frac{1}{12}(0.375)(7.25)^3 = 55.55 \text{ in}^4$$

$$I_y = 2\left[\frac{1}{12}(0.375)(4)^3 + (0.375)(4)(2 - 0.1875)^2\right] + \frac{1}{12}(7.25)(0.375)^3 = 13.89 \text{ in}^4$$

$$I_{xy} = \Sigma \bar{x}\bar{y}A = (-2 + 0.1875)(4 - 0.1875)(4)(0.375) + (0)(0)(7.25)(0.375) + (1.8125)(-3.1825)(4)(0.375) = -20.73 \text{ in}^4$$

$$I_{\max/\min} = \frac{I_x + I_y}{2} \pm \sqrt{\left(\frac{I_x - I_y}{2}\right)^2 + I_{xy}^2}$$

$$= \frac{55.55 + 13.89}{2} \pm \sqrt{\left(\frac{55.55 - 13.89}{2}\right)^2 + (-20.73)^2}$$

$$I_{\max} = 64.1 \text{ in}^4 \quad \text{Ans}$$

$$I_{\min} = 5.33 \text{ in}^4 \quad \text{Ans}$$

From *Mechanics of Materials*, Sixth Edition by R. C. Hibbeler, ISBN 0-13-191345-X.

© 2005 R. C. Hibbeler. Published by Pearson Prentice Hall,

Pearson Education, Inc., Upper Saddle River, NJ. All rights reserved.

This material is protected under all copyright laws as they currently exist. No portion of this material may be reproduced, in any form or by any means, without permission in writing from the publisher.

A-18 Solve Prob. A-17 using Mohr's circle.

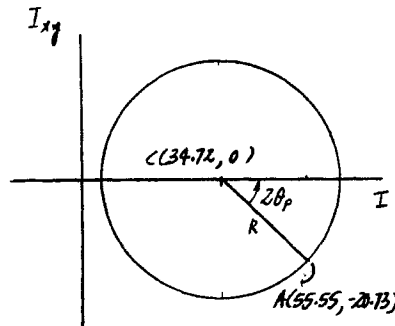
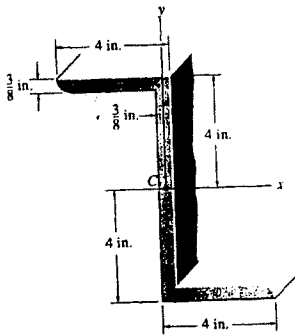

$$I_x = 2\left[\frac{1}{12}(4)(0.375)^3 + (4)(0.375)(4 - 0.1875)^2\right] + \frac{1}{12}(0.375)(7.25)^3 = 55.55 \text{ in}^4$$

$$I_y = 2\left[\frac{1}{12}(0.375)(4)^3 + (0.375)(4)(2 - 0.1875)^2\right] + \frac{1}{12}(7.25)(0.375)^3 = 13.89 \text{ in}^4$$

$$I_{xy} = \sum \bar{x}\bar{y}A = (-2 + 0.1875)(4 - 0.1875)(4)(0.375) + (0)(0)(7.25)(0.375) + (1.8125)(-3.1825)(4)(0.375) = -20.73 \text{ in}^4$$

$$\frac{I_x + I_y}{2} = \frac{55.55 + 13.89}{2} = 34.72$$

$$A(55.55, -20.73)$$

$$C(34.72, 0)$$

$$R = \sqrt{(55.55 - 34.72)^2 + (20.73)^2} = 29.387$$

$$I_{\max} = 34.72 + 29.387 = 64.1 \text{ in}^4 \quad \mathbf{Ans}$$

$$I_{\min} = 34.72 - 29.387 = 5.33 \text{ in}^4 \quad \mathbf{Ans}$$

From *Mechanics of Materials*, Sixth Edition by R. C. Hibbeler, ISBN 0-13-191345-X.

© 2005 R. C. Hibbeler. Published by Pearson Prentice Hall,

Pearson Education, Inc., Upper Saddle River, NJ. All rights reserved.

This material is protected under all copyright laws as they currently exist. No portion of this material may be reproduced, in any form or by any means, without permission in writing from the publisher.

A-19 Determine the principal moments of inertia for the angle's cross-sectional area with respect to a set of principal axes that have their origin located at the centroid *C*. Use the equations developed in Sec. A.4. For the calculation, assume all corners to be square.

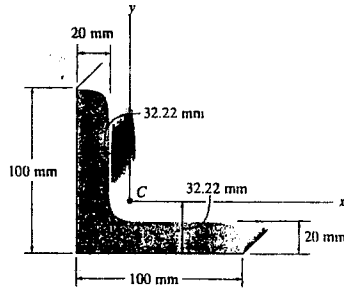

$$I_x = I_y = \frac{1}{12}(80)(20^3) + 80(20)(32.22 - 10)^2 + \frac{1}{12}(20)(100^3) + 20(100)(50 - 32.22)^2$$

$$I_x = I_y = 3.1422(10^6) \text{ mm}^4$$

$$I_{xy} = \sum \bar{x}\bar{y}A = (-32.22 + 10)(50 - 32.22)(100)(20) + (60 - 32.22)(-32.22 + 10)(80)(20) = 1.7778(10^6) \text{ mm}^4$$

$$I_{\max/\min} = \frac{I_x + I_y}{2} \pm \sqrt{\left(\frac{I_x - I_y}{2}\right)^2 + I_{xy}^2}$$

$$= \left[\frac{3.1422 + 3.1422}{2} \pm \sqrt{\left(\frac{3.1422 - 3.1422}{2}\right)^2 + (1.7778)^2} \right] (10^6)$$

$$I_{\max} = 4.92(10^6) \text{ mm}^4 \quad \text{Ans}$$

$$I_{\min} = 1.36(10^6) \text{ mm}^4 \quad \text{Ans}$$

From *Mechanics of Materials*, Sixth Edition by R. C. Hibbeler, ISBN 0-13-191345-X.

© 2005 R. C. Hibbeler. Published by Pearson Prentice Hall,

Pearson Education, Inc., Upper Saddle River, NJ. All rights reserved.

This material is protected under all copyright laws as they currently exist. No portion of this material may be reproduced, in any form or by any means, without permission in writing from the publisher.

*A-20 Solve Prob. A-19 using Mohr's circle.

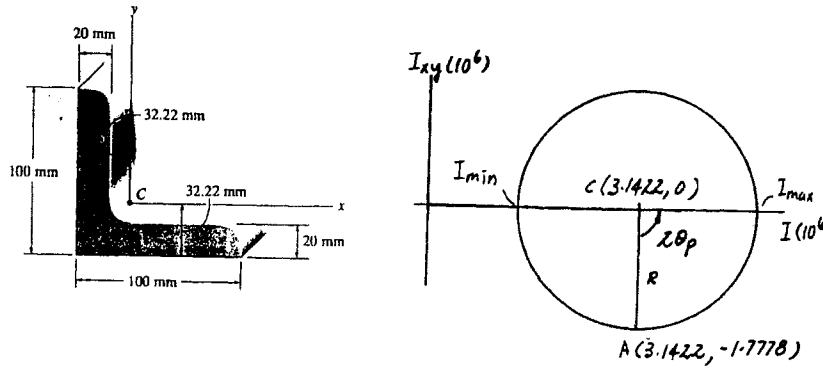

$$I_x = I_y = \frac{1}{12}(80)(20^3) + 80(20)(32.22 - 10)^2 + \frac{1}{12}(20)(100^3) + 20(100)(50 - 32.22)^2$$

$$I_x = I_y = 3.1422(10^6) \text{ mm}^4$$

$$I_{xy} = \sum \bar{x}\bar{y}A = (-32.22 + 10)(50 - 32.22)(100)(20) + (60 - 32.22)(-32.22 + 10)(80)(20) = 1.7778(10^6) \text{ mm}^4$$

$$A(3.1422, -1.7778)(10^6)$$

$$C(3.1422, 0)$$

$$R = 1.7778$$

$$I_{\max} = (3.1422 + 1.7778)(10^6) = 4.92(10^6) \text{ mm}^4 \quad \text{Ans}$$

$$I_{\min} = (3.1422 - 1.7778)(10^6) = 1.36(10^6) \text{ mm}^4 \quad \text{Ans}$$

From *Mechanics of Materials*, Sixth Edition by R. C. Hibbeler, ISBN 0-13-191345-X.

© 2005 R. C. Hibbeler. Published by Pearson Prentice Hall,

Pearson Education, Inc., Upper Saddle River, NJ. All rights reserved.

This material is protected under all copyright laws as they currently exist. No portion of this material may be reproduced, in any form or by any means, without permission in writing from the publisher.