



Horticultural Reviews

VOLUME 31

HORTICULTURAL REVIEWS

Volume 31

Horticultural Reviews is sponsored by:
American Society for Horticultural Science
International Society for Horticultural Science

Editorial Board, Volume 31

Rebecca Darnell
Ian B. Ferguson
Stan C. Hokanson

HORTICULTURAL REVIEWS

Volume 31

edited by
Jules Janick
Purdue University



WILEY

John Wiley & Sons, Inc.

This book is printed on acid-free paper. ∞

Copyright © 2005 by John Wiley & Sons. All rights reserved.

Published by John Wiley & Sons, Inc., Hoboken, New Jersey
Published simultaneously in Canada

No part of this publication may be reproduced, stored in a retrieval system, or transmitted in any form or by any means, electronic, mechanical, photocopying, recording, scanning, or otherwise, except as permitted under Section 107 or 108 of the 1976 United States Copyright Act, without either the prior written permission of the Publisher, or authorization through payment of the appropriate per-copy fee to the Copyright Clearance Center, Inc., 222 Rosewood Drive, Danvers, MA 01923, (978) 750-8400, fax (978) 750-4470, or on the web at www.copyright.com. Requests to the Publisher for permission should be addressed to the Permissions Department, John Wiley & Sons, Inc., 111 River Street, Hoboken, NJ 07030, (201) 748-6011, fax (201) 748-6008, e-mail: permcoordinator@wiley.com.

Limit of Liability/Disclaimer of Warranty: While the publisher and author have used their best efforts in preparing this book, they make no representations or warranties with respect to the accuracy or completeness of the contents of this book and specifically disclaim any implied warranties of merchantability or fitness for a particular purpose. No warranty may be created or extended by sales representatives or written sales materials. The advice and strategies contained herein may not be suitable for your situation. You should consult with a professional where appropriate. Neither the publisher nor author shall be liable for any loss of profit or any other commercial damages, including but not limited to special, incidental, consequential, or other damages.

For general information on our other products and services or for technical support, please contact our Customer Care Department within the United States at (800) 762-2974, outside the United States at (317) 572-3993 or fax (317) 572-4002.

Wiley also publishes its books in a variety of electronic formats. Some content that appears in print may not be available in electronic books. For more information about Wiley products, visit our web site at www.wiley.com.

Library of Congress Cataloging-in-Publication Data:

ISBN: 0-471-66694-7

ISSN: 0163-7851

Printed in the United States of America

10 9 8 7 6 5 4 3 2 1

Contents

Contributors	viii
Dedication: Ian J. Warrington <i>David C. Ferree</i>	xi
1. Particle Films: A New Technology for Agriculture <i>D. Michael Glenn and Gary J. Puterka</i>	1
I. Introduction	2
II. Particle Film Technology for Arthropod Pest Control	3
III. Physiological and Horticultural Uses of Particle Films	19
IV. Disease Control with Mineral and Particle Film Materials	32
V. Future Uses of Particle Film Technology in Agriculture	34
Literature Cited	36
2. The Foliage Plant Industry <i>Jianjun Chen, Dennis B. McConnell, Richard J. Henny, and David J. Norman</i>	45
I. Introduction	46
II. Production Conditions and Environments	59
III. Foliage Plant Propagation	74
IV. Foliage Plant Production	78
V. Postproduction	97
VI. The Future	100
Literature Cited	101

3. Fruit Drop in Mango	111
<i>Zora Singh, Aman Ullah Malik, and Thomas L. Davenport</i>	
I. Introduction	112
II. Intensity and Patterns of Fruit Drop	113
III. Biotic and Abiotic Factors Influencing Fruit Drop	125
IV. Endogenous Factors Affecting Fruit Drop	136
V. Management Practices Affecting Fruit Drop	138
VI. Conclusion	139
Literature Cited	140
4. The Physiology of Adaptation and Yield Expression in Olive	155
<i>D. J. Connor and E. Fereres</i>	
I. Introduction	157
II. Growth and Development	159
III. Water Relations	169
IV. Mineral Nutrition	179
V. Carbon Accumulation	183
VI. Biomass Partitioning and Realization of Yield	195
VII. Stress Physiology	205
VIII. Integration of Responses	215
IX. Recommendations for Future Research	217
X. Conclusion	218
Literature Cited	219
5. Crop Load Interactions in Apple	231
<i>Jens N. Wünsche and Ian B. Ferguson</i>	
I. Introduction	233
II. Definition	234
III. Factors Determining Crop Load	235
IV. Factors Affected by Crop Load	241
V. Physiological and Biochemical Response	253
VI. Concluding Remarks	269
Literature Cited	273

6. Chestnut: Botany, Horticulture, and Utilization	291
<i>Giancarlo Bounous and Daniela Torello Marinoni</i>	
I. Introduction	292
II. Botany	296
III. Horticulture	310
IV. Nut Utilization	327
V. The Future of the Chestnut Industry	340
Literature Cited	341
7. The North American Pawpaw: Botany and Horticulture	349
<i>Kirk W. Pomper and Desmond R. Layne</i>	
I. Introduction	350
II. History	351
III. Botany	352
IV. Horticulture	363
V. Future Prospects	377
Literature Cited	377
Subject Index	383
Cumulative Subject Index	385
Cumulative Contributor Index	409

Contributors

Giancarlo Bounous, Department of Colture Arboree, Università degli Studi di Torino, Italy, giancarlo.bounous@unito.it

Jianjun Chen, Mid-Florida Research and Education Center and Environmental Horticulture Department, IFAS, University of Florida, 2725 Binion Road, Apopka, Florida 32703, jjchen@mail.ifas.ufl.edu

D. J. Connor, Instituto de Agricultura Sostenible (CSIC) and Universidad de Córdoba, Apartado de Correos 4084, 14080 Córdoba, Spain, and The Institute of Land and Food Resources, The University of Melbourne, Victoria 3010, Australia, djconnor@uco.ecs

Thomas L. Davenport, University of Florida, IFAS, Tropical Research and Education Center, 18905 SW 280 St., Homestead, Florida 33031, tldav@mail.ifas.ufl.edu

E. Fereres, Instituto de Agricultura Sostenible (CSIC) and Universidad de Córdoba, Apartado de Correos 4084, 14080 Córdoba, Spain, ag1fecae@uco.ecs

Ian B. Ferguson, The Horticulture and Food Research Institute of New Zealand, Mt Albert Research Centre, Private Bag 92 169, Auckland, New Zealand, ferguson@hortresearch.co.nz

David C. Ferree, Department of Horticulture and Crop Science, The Ohio State University, 1680 Madison Avenue, Wooster, OH, 44691, ferree.1@osu.edu

D. Michael Glenn, United States Department of Agriculture, Agricultural Research Service, Appalachian Fruit Research Station, 2217 Wiltshire Road, Kearneysville, West Virginia 25430, mglenn@afrs.ars.usda.gov

Richard J. Henny, University of Florida, IFAS, Mid-Florida Research and Education Center and Environmental Horticulture Department, 2725 Binion Road, Apopka, Florida 32703

Desmond R. Layne, Clemson University, Department of Horticulture, Clemson, South Carolina 29634-0319, dlayne@clemson.edu

- Aman Ullah Malik**, Horticulture, Muresk Institute, Division of Resources and Environment, Curtin University of Technology, GPO Box U 1987, Perth 6845 WA, Australia
- Daniela Torello Marinoni**, Department of Colture Arboree, Università degli Studi di Torino, Italy
- Dennis B. McConnell**, Environmental Horticulture Department, IFAS, University of Florida, P.O. Box 110670, Gainesville, Florida 32611
- David J. Norman**, University of Florida, IFAS, Plant Pathology Department, 2725 Binion Road, Apopka, Florida 32703
- Kirk W. Pomper**, Kentucky State University, Land Grant Program, 129 Atwood Research Facility, Frankfort, Kentucky 40601-2355, kpomper@gwmail.kysu.edu
- Gary J. Puterka**, United States Department of Agriculture, Agricultural Research Service, Appalachian Fruit Research Station, 2217 Wiltshire Road, Kearneysville, West Virginia 25430
- Zora Singh**, Horticulture, Muresk Institute, Division of Resources and Environment, Curtin University of Technology, GPO Box U 1987, Perth 6845 WA, Australia, zora@muresk.curtin.edu.au.
- Jens N. Wünsche**, The Horticulture and Food Research Institute of New Zealand, Hawke's Bay Research Centre, Private Bag 1401, Havelock North, New Zealand, jwunsche@hortresearch.co.nz



Ian J. Warrington

Dedication: Ian J. Warrington

Probably no horticulturist has made more in-depth research contributions to such a wide range of crops as Ian J. Warrington. His broad knowledge of horticulture and plant physiology and unique abilities with people have resulted in international recognition of his research as well as the administration of researchers and their programs. Ian has been a true pioneer and provided an example to worldwide horticulturists in managing horticultural research as it becomes privatized and is required to pay its way.

For over 20 years, beginning in 1969, Ian was the Biological Coordinator of the state-of-the-art controlled environment laboratory at the Department of Scientific and Industrial Research (DSIR) in Palmerston North, New Zealand. He was instrumental in contributing strongly to the design of this facility that provides a very wide range of precisely controlled environments in a large number of sophisticated walk-in growth rooms. In-depth research conducted alone or in cooperation with other scientists resulted in publications on vegetable crops, agronomic or grass crops, ornamental or floriculture crops, forest tree species and fruit crops. The capabilities of the facility are so unique that scientists from several countries, including many from the United States, traveled to New Zealand and were graciously hosted by Ian while conducting their research. The facilities he designed and studies conducted have set the standard for controlled environment research around the world.

Beginning in 1989, Ian's responsibilities were expanded to a broader research management role in a wide range of horticultural crops for DSIR and subsequently for HortResearch. With Ian's nurturing, the research groups on apples and kiwifruit became the strongest and most comprehensive in the world. In New Zealand this was a period of transition from government-supported research to competitive government and commercial contracts. Ian's considerable people skills were instrumental in a smooth transition and significant increase in funding for the groups under his guidance. Ian's hallmark as an administrator was to encourage all who worked with him, no matter what their level of training, to extend themselves and achieve as much as possible. In 1995, he was selected as the Chief Executive Officer for the Horticulture and Food Research Institute of New Zealand, with responsibility for 530 staff

located at 12 sites around New Zealand and for a budget of \$NZ 57 million. Through visionary goal-oriented leadership and aggressive marketing of their research capabilities, Ian was able to demonstrate revenue growth and profit each year for the Institute. Ian has been instrumental in forming partnerships with business inside New Zealand and in other countries as the research programs became increasingly privatized. Under Ian's guidance, research has focused on developing new cultivars and crops marketable for premium prices in other countries, as New Zealand's economy depends on exports for success.

During his very productive research career, Ian has published over a hundred refereed papers and the high quality of his research has been recognized by five best paper awards by the New Zealand Society for Horticulture Science. The American Society for Horticultural Science awarded him the best "Cross Commodity" paper in 1992 and best fruit paper in 2000. He was co-editor of a comprehensive book on kiwifruit and another on apple. He has been elected a Fellow in the New Zealand Society for Horticultural Science (also Honorary Fellow in 1997), American Society for Horticultural Science, and The Royal Society of New Zealand. In recognition of the quality of his research and the outstanding leadership he has provided horticulture in New Zealand, he was awarded an honorary Doctorate of Literature (D.Lit.) from Massey University in 2001.

Ian has given generously of his time and talents not only to his community, institutions and professional societies in New Zealand, but also internationally. He has served on numerous committees in the American Society for Horticultural Science and was elected vice president for International Affairs in 1993–94. For many years he has served on the Council of the International Society for Horticultural Science and was elected vice president in 2002.

Ian and Gwendolyn ("Blondie") Warrington were blessed with a son and three daughters, who have embarked on varied and successful careers. Ian's productive professional career continues with his return to academic life at Massey University where he received his advanced training. All who have the good fortune to know Ian appreciate his love of life and all the challenges it offers. His stellar career and enthusiasm has inspired a generation of young scientists both in New Zealand and throughout the world. We take pride in dedicating this volume to Ian Warrington.

David C. Ferree
Ohio Agricultural Research &
Development Center
Wooster, Ohio

Particle Films: A New Technology for Agriculture

D. Michael Glenn

Soil Scientist

United States Department of Agriculture

Agricultural Research Service

Appalachian Fruit Research Station

2217 Wiltshire Road

Kearneysville, West Virginia 25430

Gary J. Puterka

Entomologist

United States Department of Agriculture

Agricultural Research Service

Appalachian Fruit Research Station

2217 Wiltshire Road

Kearneysville, West Virginia 25430

- I. INTRODUCTION
- II. PARTICLE FILM TECHNOLOGY FOR ARTHROPOD PEST CONTROL
 - A. Historical Review of Mineral Use in Agriculture for Pest Control
 - B. Development of Particle Film Technology for Pest Control
 - C. Efficacy of Particle Films to Control Arthropod Pests
 - D. Action of Particle Films on Arthropod Biology and Behavior
 - E. Examples of Successful Particle Film Use to Control Arthropod Pests
- III. PHYSIOLOGICAL AND HORTICULTURAL USES OF PARTICLE FILMS
 - A. Effects on Net Gas Exchange and Productivity
 - B. Reduction of UV Damage
 - C. Reduction of Solar Injury
- IV. DISEASE CONTROL WITH MINERAL AND PARTICLE FILM MATERIALS
- V. FUTURE USES OF PARTICLE FILM TECHNOLOGY IN AGRICULTURE
 - A. Pest Control
 - B. Freeze Prevention

Horticultural Reviews, Volume 31, Edited by Jules Janick
ISBN 0-471-66694-7 © 2005 John Wiley & Sons, Inc.

C. Improved Fruit Finish

D. Conclusions

LITERATURE CITED

I. INTRODUCTION

Scientific evidence that chemically active pesticides are residually present on food, in water supplies, in the soil, and that these chemicals may interfere with animal growth and development, together with the public demand for reduced-risk pesticides, resulted in a Congressional mandate for USDA-ARS to develop reduced risk alternatives to chemical pesticides in 1985 as part of the Low Input Sustainable Agriculture (LISA) program (Jawson and Bull 2002). In the 1980s and 1990s it was clear that new paradigms were needed to control plant pests in an economically sustainable and environmentally safe manner. Particle film technology is a combined synthesis of knowledge on mineral technology, insect behavior, and light physics as they apply to pest control and plant physiology.

Feldspar and quartz are naturally occurring inorganic substances that are referred to as primary minerals. Upon weathering, primary minerals such as feldspar give rise to secondary minerals such as aluminosilicate clays. Current particle film technology is based on kaolin, a white, non-porous, non-swelling, low-abrasive, fine-grained, plate-shaped, aluminosilicate mineral $[Al_4Si_4O_{10}(OH)_8]$ that easily disperses in water and is chemically inert over a wide pH range. Water-processed kaolin is >99% pure and has a brightness of >85%. Mined, crude kaolin has traces of Fe_2O_3 and TiO_2 that are removed during processing to increase brightness. In addition, crystalline silica, SiO_2 , a respirable human carcinogen, must be removed to insure human safety (Harben 1995). Technical advances in kaolin processing within the past decades have made it possible to produce kaolin particles with specific sizes, shapes, and light reflective properties. Kaolin particles can be engineered with specific properties in paper, paint, cosmetic, and plastic applications. Potential uses of kaolin, however, have been largely ignored by the agricultural industry except for use as carriers for wettable powder formulations of pesticides. Recent advances in kaolin processing, formulating, and plant surface deposition properties have opened new opportunities for its use in agriculture.

An effective particle film on plant tissues has certain characteristics: (1) chemically inert mineral particle, (2) particle diameter $< 2 \mu\text{m}$, (3) formulated to spread and create a uniform film, (4) porous film that does not interfere with gas exchange from the leaf, (5) transmits photosynthetically active radiation (PAR) but excludes ultraviolet (UV) and infrared (IR) radiation to some degree, (6) alters insect/pathogen behavior on the plant, and (7) can be removed from harvested commodities. Many of these characteristics are similar to natural plant defenses consisting of increasing cuticle thickness and pubescence to reduce water and heat stress (Levitt 1980) and to interfere with disease and insect damage (Barthlott and Neinhuis 1997; Neinhuis and Barthlott 1997). An effective particle film can be applied to a plant surface in such a way that a nearly uniform layer is deposited over the entire plant without blocking stomates (Fig. 1.1A, B, C and Plate I, Top). At the present time, a commercial particle film material, Surround[®] crop protectant, is being used in about 90% of the Pacific Northwest pear market for the early season control of pear psylla and approximately 20% of the Washington State apple market to reduce sunburn damage. The pears and apples are sold in the fresh food market after being washed in a standard grading line. An effective fruit washing line will utilize a dump tank, often with surfactants added, a minimum of a 10 m bed of brushes, and overhead high-pressure sprayers. Waxing the fruit obscures trace amounts of kaolin residue that did not wash off (pers. observ.). Residue removal from the stem and calyx end of fruit is not easy because it is in a difficult area to clean, but brush and sprayer criteria as described above are effective (Werblow 1999; Heacox 2001).

The purpose of this paper is to bring together the historical and current literature related to the use of particle films in agriculture and to discuss their present and future use in crop protection and production.

II. PARTICLE FILM TECHNOLOGY FOR ARTHROPOD PEST CONTROL

A. Historical Review of Mineral Use in Agriculture for Pest Control

Soil dusts have long been used as insect repellents by primitive people, mammals, and birds that took “dust baths” regularly to ward off biting insects (Ebling 1971). However, recent efforts to control insects mainly

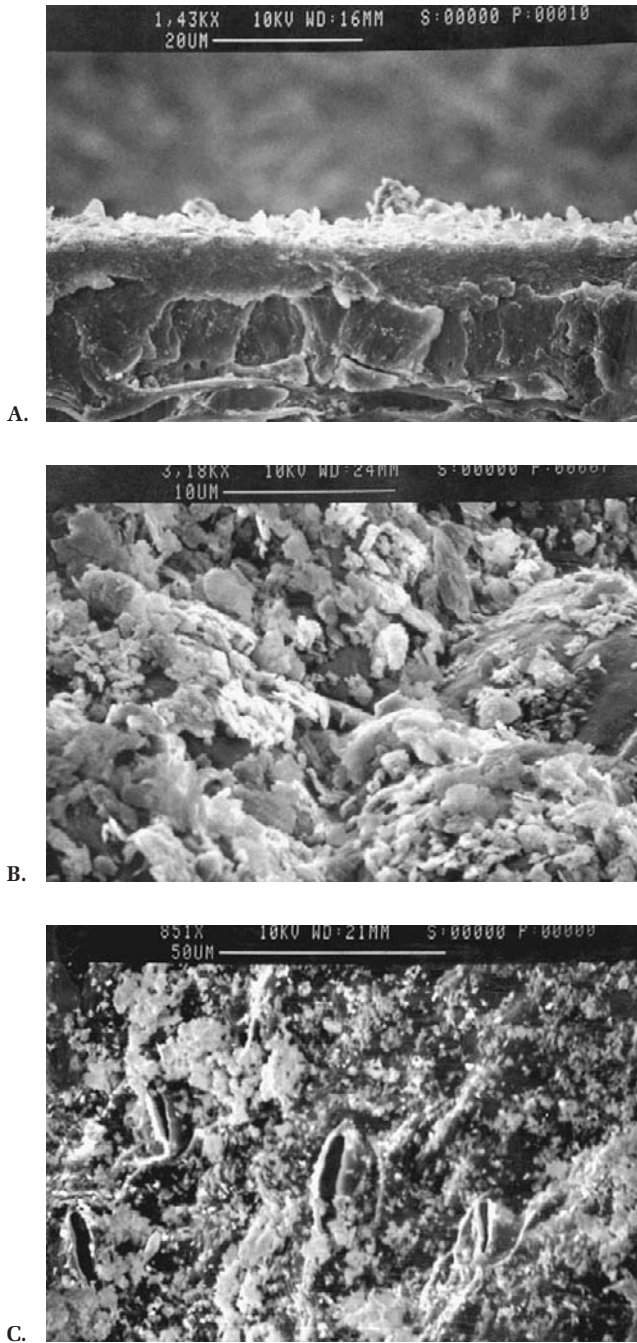

Fig. 1.1.
 A. Scanning Electron Micrograph (SEM) of Surround® on a leaf cross-section of apple.
 B. SEM of a particle film, Surround, on the upper surface of an apple leaf.
 C. SEM of a particle film, Surround, on the lower surface of an apple leaf.

focused on toxic minerals or chemical compounds rather than inert mineral particles. In antiquity, elemental sulfur or sulfur compounds mixed with bitumen were heated to produce fumes that repelled insects from vines and trees (Smith and Secoy 1975, 1976). Diatomaceous earth (diatomite), which originates from fossilized sedimentary deposits of phytoplankton (diatoms), was applied to plants and structures for pest control in China as early as 2000 B.C.E. (Allen 1972). Toxic preparations of arsenic and arsenic salts were used around 900 C.E. in China and incorporated into ant baits in Europe in 1699 (Casida and Quistad 1998). Powdered limestone (calcium carbonate) was added to grain to deter insects in the 1st century. One of the primary insecticides and fungicides of early agriculture, dating to the Hellenistic Era, was the mixture of hydrated lime [$\text{Ca}(\text{OH})_2$] with sulfur (S) (Secoy and Smith 1983). Chemically reactive hydrated lime and sulfur were applied independently or together in mixtures with a range of other materials such as tobacco, wood ash, linseed oil, soap, and cow dung. These concoctions were applied as paints or washes to fruit trees and grape vines to protect them from insect and disease damage. From the late 1500s to the 1800s, slaked lime (calcium hydroxide) and burned lime (calcium oxide) were used against household, stored grain, and crop insect pests. Sulfur mixed with limestone was also burned for use as a fumigant for trees in the late 1500s, while lime-sulfur preparations became popular in the latter part of the 18th century. In the 1800s a lime-sulfur combination was developed and replaced the application of the individual minerals. Lime-sulfur, slaked lime, and sulfur were the primary materials used as pesticides in the 1800s because these materials were readily available and easily prepared.

The discovery of the insecticidal properties of the pigment Paris green in 1897 marked the beginning of the modern use of insecticides (Little 1972). The bright green powder, prepared by combining copper acetate and arsenic trioxide to form copper acetoarsenite, was extremely poisonous and had to be made and used with caution. The mineral schultenite (lead arsenate) was first prepared as an insecticide and used against the gypsy moth in 1892 and was a widely used general insecticide for crops up to 1940, when it was replaced with the synthetic insecticide, diclorodiphenyltrichloroethane (DDT) (Peryea 1998).

Inorganic chemists were unknowingly synthesizing chemical compounds such as hexachlorocyclohexane during the early 1800s that were later found to be insecticidal in 1942 (Casida and Quistad 1998). The discovery of this and other insecticidal compounds such as tetraethylthiuram disulfide (Guy 1936) and DDT in 1939 (Casida and Quistad 1998) spurred a major exploration into inert mineral carriers. Lead arsenate,

sulfur, nicotine, and hydrated lime, alone or in mixtures, were still the predominant insecticidal materials used in agriculture in the early 1900s. During the first quarter of the 20th century few other insecticidal materials were used and pesticide delivery was also in its infancy. Pesticidal materials were applied as spray solutions using steam- or gas-driven spray gun systems that became available around 1900 (Fronk 1971). The labor involved in spraying orchards and other crops by hand-gun and using large volumes of water required for acceptable coverage motivated researchers to investigate particle dusts as insecticidal carriers in the early 1900s (Table 1.1).

Dust applications gained favor over liquid sprays in the 1920s because of the speed of dusting operations, economy in labor, good plant coverage, and comparable insect control with liquid sprays (Giddings 1921; Headly 1921; Parrot 1921). Other research that increased interest in using dusts to deliver insecticides proposed that chemically active particles of sodium fluoride and borax (Shafer 1915) and toxin impregnated minerals (Marcovitch 1925; Mote et al. 1926) reacted with the insect cuticle and caused a “self-cleaning” response due to the irritation, and, in the process, insects ingested particles and died. Particle ingestion led to a more rapid killing action by insecticide-laced dusts than by the insecticide (lead arsenate) alone (Mote et al. 1926).

Table 1.1. Examples of minerals used either as insecticide dust carriers or insecticides.

Class of mineral	Subclass	Group	Hardness	Reference
Elemental		Sulfur	2.0	Watkins and Norton 1947
Oxide	Silicon	Quartz	7.0	Alexander et al. 1944b
Carbonate	Calcium	Calcite	3.0	Alexander et al. 1944b
Sulfate	Calcium	Gypsum	2.0	Alexander et al. 1944b
Silicate	Mica	Muscovite, biotite	2.5	Alexander et al. 1944b
	Clays	Talc	1.0	Alexander et al. 1944b
		Pyrophyllite	1.0–1.5	Watkins and Norton 1947
		Montmorillonite	1.2	Watkins and Norton 1947
		Kaolinite	1.5–2.0	Watkins and Norton 1947
		Attapulgitite	1.5	Watkins and Norton 1947
		Palygorskite	1.5	Watkins and Norton 1947
Phosphate	Calcium	Apatite	5.0	Watkins and Norton 1947
Organic mineral	Silicone oxide	Diatomite, diatomaceous earth	7.0	Watkins and Norton 1947

Research in the 1930s established that certain “inert dusts” alone had toxic activity against insects when ingested during the process of self-cleaning (Boyce 1932; Richardson and Glover 1932). Suffocation by inhalation was not an important factor, and it was found that the inert dust itself had a desiccating action (Hockenyos 1933). This highly significant observation would later become regarded as one of the major mechanisms of how dusts kill insects. Research on inert mineral dusts (e.g., lime, kaolin) continued to demonstrate that dust had contact toxicity to insects (Maxwell 1937). A number of “so-called inert materials” caused high mortalities of stored grain weevils by desiccation (Chiu 1939a,b). Chiu (1939a,b) summarized the modes-of-action of inert materials as: (1) ingestion of the dust into the digestive system (Boyce 1932; Richardson and Glover 1932), (2) desiccation (Zacker and Kunike 1931; Hockenyos 1933), (3) chemical reaction with the body wall of the insect (Shafer 1915; Makie 1930), and (4) direct mechanical action (Germar 1936). Another important discovery related to mechanisms was that as particle size decreased from 37.0 to 2.9 μm in diameter, insect mortality increased (Chiu 1939a,b). Research in the 1930s brought about the realization that fine mineral dusts were misclassified by insect physiologists and that inert dusts had many unexpected properties in relation to insects (Briscoe 1943). Briscoe (1943) established that mortalities by dust ingestion and suffocation were negligible in grain weevils and that dusts increased water transmission through the insect’s cuticle causing desiccation. Alexander et al. (1944a,b) established that the desiccating action of dusts was due to their absorbance of or penetration into the insect epicuticle and that this action was independent of their chemical reactive properties. Insect mortalities increased as particle size decreased and as intrinsic hardness of the materials increased. The mechanisms of how particles caused desiccation of insects was finally attributed to either their adsorption of the epicuticular waxes of the cuticle or abrasion of the cuticle (Kalmus 1944; Wigglesworth 1944). However, if absorption was a factor, many researchers believed it must be augmented by cuticular abrasion in order to cause desiccation in most insects (Beament 1945; Wigglesworth 1944; Hurst 1948).

While many researchers had focused efforts on determining the mechanisms of how “inert” dusts killed pest insects (Beament 1945; Kalmus 1944; Wigglesworth 1944; Hunt 1947; Hurst 1948), others had noticed that inert dusts affected insects in different ways and could actually cause increases in pest infestations (Callenbach 1940; Flanders 1941; Halloway et al. 1942; Halloway and Young 1943). Crops coated with dusts from dirt roads or intentional dust applications exhibited increased levels of codling moth, *Cydia pomonella* (L.) (Callenbach

1940), Citrus red mite, *Panonychus citri* (McGreggor) (Halloway et al. 1942), and purple scale, *Lepidosaphes beckii* (Newman) (Halloway and Young 1943). Flanders (1941) proposed that the pest increases were a result of dusts interfering with the efficacy of natural enemies. The efficacy of natural enemies was influenced by dusts via at least four mechanisms: (1) dusts impeded movement of legs and mouthparts (Germar 1936), (2) dusts invoked the "self-cleaning" response (Marcovitch 1925; Mote et al. 1926), (3) the mineral film presented a physical barrier to natural enemy attack (Driggers 1928), and (4) dusts caused direct mortality of natural enemies (Zacker and Kunike 1931).

Insecticidal dusts were the primary means of delivering insecticides in the 1940s and interest in the toxicity of mineral dust diluents established the need to better classify these diluents. Watkins and Norton (1947) found diluents and carriers fell into two basic categories, botanical flours (e.g., walnut shell flour) and minerals (e.g., attapulgite). A cornerstone study by David and Gardiner (1950) on the physical properties of dust carriers for insecticides summarized that particle size, shape, specific gravity, bulk density, surface area, hardness, and moisture relations were all factors that affected the toxicity of dusts alone or in combination with DDT. These results were confirmed by Alexander et al. (1944a), who established that abrasive dusts with sharp angular structure caused insects to die from desiccation most rapidly and that low mortalities were associated with high humidities. Watkins and Norton (1947) also found that abrasive dusts like alumina-aluminum oxide (Al_2O_3) or silica oxide (SiO_2) were the best carriers for DDT. Surprisingly, soft nonabrasive minerals like talc and slate dust, alone or in combination with DDT, attached to insects as well as Al_2O_3 , but these minerals were not as lethal to insects as DDT or Al_2O_3 . After World War II, the development of synthetic pesticides superceded the use of minerals in the control of plant pests. Despite the common usage of synthetic pesticides, diatomaceous earth (Celite®), wettable sulfur, and hydrated lime are still used as insecticides in some crops.

The ability of finely divided particles to adsorb and remove the cuticular waxes of insects was proven by Ebling and Wagner (1959), who developed several techniques to quantify this phenomenon. They found that nonabrasive sorptive dusts like montmorillonite and attapulgite removed the thin lipid layer covering the epicuticle of dry wood termites, *Incisstermes minor* (Hagan). Sorptive-dust treated termites died from desiccation more rapidly than through contact with insecticides like parathion. Certain silica aerogels (synthetic oxides of silicon), especially those impregnated with fluoride, were more lethal than mineral dusts at high humidities (Ebling and Wagner 1959). Further, they

believed silica gels had less health issues for humans than crystalline silica because crystallized silicates in natural mineral dusts could cause the lung disease silicosis. Ebling (1961) later established that particle pore size of $\geq 20 \text{ \AA}$ strongly correlated with insect mortalities, regardless of the particle's size, or abrasiveness. Pore sizes of 20 \AA or larger were required in order to adsorb the larger wax molecules (ca. C_{30} chain length) that are characteristic of most insect waxes. Synthetic silica gels were far better than sorptive minerals like attapulgite. Ebling (1971) later modified his statement on 20 \AA pore size in mineral particles as being most critical for sorptive action and included particle surface area (particle size) as also being equally important. He also found that stored grain pests such as the rice weevil, *Sitophilus oryzae* (L.), household pests such as the western drywood termite, or American cockroach, *Periplanta americana* (L.), and ectoparasites affecting livestock such as the northern fowl mite, *Ornithonyssus sylvarium* (Can. and Fan.), were ideally suited for control by sorptive dusts. In particular, silica aerogel dusts were effective against this wide range of pests. Although not mineral-based, Ghate and Marshall (1962) suppressed eggs and mobile forms of European red mite and two-spotted spider mites with a combination of buttermilk and wheat flour.

Interest in the control of insects with inert dusts transitioned from minerals to synthetic compounds like silica aerogels and fumed silicas by 1970. Although dusts for insect control may have had the greatest potential for the pest control needs of the grain industry, inexpensive fumigants became widely used instead. Much of the research on mineral particles after 1970 was limited to pesticide formulations where mineral particles were used as carriers for synthetic insecticides (Kirkpatrick and Gillenwater 1981; Margulies et al. 1992) or microbial agents (Studdert et al. 1990; Tapp and Stotzky 1995) and in the use of minerals as whitewash sprays for preventing plant virus diseases that were vectored by aphids (Moore et al. 1965; Johnson et al. 1967; Adlerz and Everett 1968; Bar-Joseph and Frenkel 1983) and thrips (Smith et al. 1972).

Moericke (1952) was first to demonstrate that aphid alight on plants in response to color (phototaxis). This discovery opened up a new field of entomological study, and provided a means of monitoring aphid movement and protecting plants from aphid transmitted diseases. Aphids respond strongly to yellow and alight on this color; they respond less so to green and orange, and few respond to white, red, blue, black or violet (Moericke 1955). Thrips, another important plant disease vectoring insect, did not respond to the same colors as aphids, except for blue, which was attractive (Wilde 1962). Within this time period,

horticulturalists investigated aluminum foil mulches and also found vegetable yields markedly increased, possibly due to water conservation (Pearson et al. 1959). Further study into aphid response to color and light revealed that light reflected by foil and other surfaces repelled aphids (Kring 1962). This discovery led to a proposal by Kring (1964) that reflective mulches could prevent aphid infestation and the diseases that they vector. Aphids (Moore et al. 1965; Johnson et al. 1967; Adlerz and Everett 1968) and thrips (Smith et al. 1972) were repelled and the diseases they vectored were reduced by aluminum foil, white polyethylene, and other light-reflecting mulches. However, not all aphids respond to colors similarly. White mulches increased aphid levels (Brown et al. 1989) and thrips in tomato (Csizinszky et al. 1999). The drawbacks of using mulches included the high cost for material and labor and disposal problems (Greer and Dole 2003). Solutions to this problem include degradable mulches that include sprayable forms. It was not until the 1980s that a kaolin-based sprayable mulch was demonstrated to be effective against the spirea aphid, *Aphis spiraeicola* Patch, in citrus (Bar-Joseph and Frenkel 1983). Spraying whitewashes for insect control, however, did not become popular and was of little scientific interest until the recent development of particle film technology. Particle film technology is partially based on the concept that reflective mulches and whitewashes repel certain arthropod pests and prevent pest vectored plant diseases.

B. Development of Particle Film Technology for Pest Control

Particle film technology for arthropod pest control represents a combined knowledge of the benefits of reflected light, mineral barriers, and toxic properties of minerals. Key to this technology was the recognition that mineral particles can have significant effects on insect behavior that were not previously recognized (Glenn et al. 1999; Puterka 2000a). Although previous researchers (Moericke 1952, 1955; Kring 1962, 1964) established that aphids were repelled from highly reflective surfaces, Puterka et al. (2000a) demonstrated that mineral particle films on plants repelled insects that were not known to be repelled by reflective light. Insects were agitated by particle film treated plants through contact with the film where particles attached to insects as well as having other effects on insect biology and behavior (Glenn et al. 1999; Puterka et al. 2000a,b, Puterka and Glenn, in press). Just as important were the effects of particle films on plant photosynthesis where, as described in this chapter, it was crucial that these mineral particle films did not have adverse effects on the plant. Particle film research began in 1994 origi-

nally in an attempt to control fruit diseases with hydrophobic kaolin films. In field trials, it was quickly realized that hydrophobic films reduced insect damage, marking the beginning of the entomological research on particle film technology.

Particle film technology was originally based on a kaolin [$\text{Al}_4\text{Si}_4\text{O}_{10}(\text{OH})_8$] made hydrophobic by a silicone coating that was originally developed for disease control in tree fruits. Hydrophobic kaolin (M96-018, Engelhard Corp.) was initially applied as a dust using various hand-operated dusters or modified sand-blasters for large-scale studies because the hydrophobic material could not be mixed and delivered in water. Plants coated with hydrophobic particle films exhibited repellence, ovipositional deterrence, and reduced survival of insects and mites on apple and pear (Glenn et al. 1999). However, the drift associated with dusting operations, plus lack of adhesion to the plant, made M96-018 dust applications impractical. Within a year, a methanol (MEOH)–water system was developed where M96-018 could be pre-slurried with 99% MEOH (11.3 kg M96-018 + 15.1 L MEOH premixed then added to 363.4 L water) and delivered as a spray to trees (Puterka et al. 2000). Yet, this formulation was difficult to pre-slurry, too expensive for practical use, and handling and transportation of 99% MEOH was restrictive because MEOH was listed as a hazardous material by the U.S. Department of Transportation. The need for an easier formulation brought the development of a two-package hydrophilic kaolin formulation, M97-009, that required a non-ionic spreader sticker, M03 (Engelhard Corp., Iselin, New Jersey). M97-009 contains the same kaolin material of M96-018 but without the silicone coating; both have particle sizes of about 1.0 μm in diameter. Laboratory (Puterka et al. 2000a) and field studies (Puterka et al. 2000b) determined that formulations based on M97-009 plus M03 spreader sticker were just as effective as M96-018 hydrophobic kaolin dusts or aqueous sprays in controlling insects and diseases. Advantages to using hydrophilic kaolin formulations were: (1) ease of mixing, (2) economical features, (3) compatibility with other materials for tank-mixes, and (4) formulation flexibility to alter spreading and rainfastness. M97-009 + M03 became commercially available in 1999 under the name Surround[®] crop protectant (Engelhard Corp., Iselin, New Jersey). Although this formulation worked well against pear psylla in pear, shipping and handling a two-package system (particles plus spreader sticker) had logistical problems that pushed research efforts to develop a single-package system. In 2001, Surround[®] was replaced by Surround[®] WP crop protectant, a single-package system that uses the same kaolin-base particle as M96-018 and M97-009, but has the sticking and spreading agents incorporated. Surround[®] WP

is now the primary commercial formulation used for insect protection as well as for sunburn and heat stress control. Another single package particle film formulation that became commercially available in 2002 was Surround[®] CF, which is similar to Surround[®] WP but has a different spreader-sticker system to speed tank-mixing under cold weather conditions (4 to 10°C). Surround[®] WP is listed for use in organic food production by the Organic Materials Review Institute (OMRI). Surround[®] CF is listed for use in organic production by the Washington Department of Agriculture.

C. Efficacy of Particle Films to Control Arthropod Pests

Particle films are effective against many key orders of arthropod pests affecting crops, including homopterans, coleopterans, lepidopterans, dipterans, and rust mites, as well as the family Eriophyidae (Table 1.2). Most research trials using particle films were conducted with applications of 3–6% solids in water and were applied to trees or other crops until the leaves became thoroughly wetted. The exception is M96-018, which was usually applied at 3% solids because particle to particle repulsion of the silicone-coated particles produced very thick fluffy films in comparison to hydrophilic particle formulations. Applications are typically made to “near-drip” and are considered to be almost a “dilute application” where 3700 L/ha is applied to mature fruit trees 8 m in height. The popularity of dwarfing rootstocks results in smaller trees where particle film applications are often applied at 935 L/ha. Studies that compared 3 and 6% solids application rates showed no significant rate differences in the lab or field, indicating that rates of 3% solids for hydrophilic particle films were adequate for insect control in season-long programs where numerous (7–13) applications are made. However, we have observed that sprays of 6% solids produce films on leaves that are more rainfast and weather far better than two 3% solids sprays on apple and pear trees in the eastern United States where frequent rains are encountered in the spring.

Laboratory bioassays on the effectiveness of kaolin particle films against pests often correspond closely to results obtained in the field (Glenn et al. 1999; Puterka et al. 2000a,b; Knight et al. 2000; Unruh et al. 2000). Exceptions to this correlation are results using the silverleaf whitefly, *Bemisia argentifolii* Bellows and Perring, and two-spotted spider mite, *Tetranychus urticae* Koch. Liang and Liu (2002) report that Surround[®] WP sprays of 6% solids repelled adults by 50% in melons compared to untreated controls, yet Poprawski and Puterka (2002a,b) observed no control of this pest in the field. Particle film materials

Table 1.2. Efficacy (%) of particle film formulations against key insect pests of various crops.

Formulation ^z	Crop	Pests	% Efficacy	Mechanisms	Comments (rate)	Reference
M96-018 dust	Apple	<i>Aphis spiraecola</i> Potch	50%	Mortality	Lab (dust@100 ug/cm ²)	Glenn et al. 1999
		<i>Tetranychus urticae</i> Koch	50%	Mortality	Lab (dust@100 ug/cm ²)	
	Pear	<i>Empoasca fabae</i> (Harris)	50%	<Damage	Field (dust@100 ug/cm ²)	
<i>Cacopsylla pyricola</i> (L.)		>75%	Repellence, < oviposition	Field (dust@100 ug/cm ²)		
M96-018 dust and MEOH, Surround+M03	Pear	<i>Cacopsylla pyricola</i> Foerster	>90%	Repellence, < infestations	Field (dust@100 ug/cm ² liquid @ 3% solids)	Puterka et al. 2000b
		<i>Epitrimerus pyri</i> (Nalepa)	60%	< Damage	Field (same as above)	
		<i>Conotrachelus nenuphar</i> (Herbst)	100%	< Oviposition suppression	Field (same as above)	
		<i>Cydia pomonella</i> (L.)	50–80%	< feeding damage	Field (same as above) M96-018 best	
M96-018+MEOH	Apple	<i>Choristoneura rosaceana</i> (Harris)	75%	Mortality, reduced mating success, repellence	Lab and Field (3% solids)	Knight et al. 2000
M96-018+MEOH, Surround+M03	Pear	<i>Cydia pomonella</i> (L.)	90–99%	< feeding damage, repellence, < oviposition	Field (1.5, 3 and 6% solids) No rate effect	Unruh et al. 2000
	Apple	<i>Cydia pomonella</i> (L.)	53–87%	< Damage, < oviposition, and repellence	Lab and Field (1.5 and 3% solids) No rate effect	
Surround+M03	Citrus	<i>Diaprepes abbreviatus</i> (L.)	68–84%	< feeding damage	Lab (3% solids)	Liang and
Surround [®] WP	Melon	<i>Bemesia argentifolii</i> Bellows and Perring	50%	Repellence, < oviposition	Lab (6% solids)	Liu 2002
Surround [®] WP	Cotton	<i>Anthonomus grandis</i>	75%	Repellence, < oviposition	Lab and Field (6% solids)	Showler 2002a
Surround+M03	Pecan	<i>Aphis spiraecola</i> Potch	70–90%	Repellence	Lab (6% solids)	Cottrell et al. 2002

(continued)

Table 1.2. (continued)

Formulation ^z	Crop	Pests	% Efficacy	Mechanisms	Comments (rate)	Reference
M96-018+MEOH, Surround®+M03	Collards	<i>Bemesia argentifolii</i> Bellows and Perring	No control	—	Field (3% solids)	Poprawski and Puterka 2002a
	Pepper	<i>Bemesia argentifolii</i> Bellows and Perring	No control	—	Field (3% solids)	Poprawski and Puterka 2002b
Surround® WP	Citrus	<i>Diaphorina citri</i> Kuwayama	75%	Repellence	Field (3 and 6% solids) No rate effect	McKenzie et al. 2002
M96-018 and Surround® dust	Stored grain	<i>Atribolium confusum</i> (du Val), <i>T. castaneum</i> (Herbst)	0–55% depending on RH	Mortality, dessionation	Lab bioassays (0.5 mg/cm ²)	Arthur and Puterka 2002
Surround® WP	Grape	<i>Homalodisca coagulata</i> (Say)	>95%	Repellence, host camouflaging, < oviposition	Lab and Field (4–6% solids)	Puterka et al. 2003a
Surround® WP	Olive	<i>Bactrocera oleae</i>	>90%	< oviposition	Field (6% solids)	Saour, in press
M96-018 dust and MEOH, Surround+M03	Pear	<i>Cacopsylla pyricola</i> (L.)	>90%	Repellence, ovi- position deterrence, fall-off, < nymphal survival, host camouflaging	Lab (3 and 6% solids) No rate effect, formulation	Puterka and Glenn, in press

^zFormulation and rate: M96-018 dust (hydrophobic film)—100 g/tree; M96-018/MEOH (hydrophobic film)—3% solids, 4% MEOH, 100 gpa; Surround/M03 (hydrophilic film)—also called M97-009/M03—3% solids, 1 pt. M03 spreader/100 gal water, 100 gpa; Surround® WP—3% solids, 100 gpa.

coated peppers and collards well but the lack of coverage on the undersides of the leaves was likely the reason for its failure in whitefly control. Other insects that were controlled at least 50% in laboratory bioassays but were not controlled in the field were two-spotted spider mite and aphids. Again, when leaves are completely coated on both surfaces with particle films, the two-spotted spider mites are controlled under laboratory conditions (G. J. Puterka, unpubl. data), however, thorough coverage, particularly on the adaxil sides of leaves, is difficult to achieve and maintain adequately under field conditions. In contrast, we have observed that aphids escape the effects of films by moving progressively onto untreated newly emerging terminal leaf growth. San Jose scale [*Quadraspidotur perniciosus* (Comstock)] was not controlled in apple with particle film treatments. This pest is generally controlled by natural predators and parasites in orchards, which indicated that the particle film reduced the efficacy of these beneficial organisms. Yet, from the trials we have conducted or observed, particle films have the potential to suppress to some degree nearly any arthropod pest species if adequate coverage can be maintained on the target plant parts.

D. Action of Particle Films on Arthropod Biology and Behavior

Arthropods use the senses of touch, taste, sight, and smell in the processes of locating and accepting plants as a host for feeding and reproduction (Miller and Strickler 1984). During the process of locating and accepting hosts, the four senses interact in such a manner that insects sense positive and negative cues, the sum of which provokes a positive or negative behavior in insects. For example, when the accumulation of positive cues outweighs negative cues, an acceptance behavior (e.g., feeding, oviposition) will occur. Plant tissues coated with particle films are obviously altered visually and tactilely to insects. Particle films also could alter the taste or smell of the host plant (Puterka and Glenn, in press). Choice and no-choice laboratory bioassays with various insects revealed that the primary mechanism of action was repellence of adults from treated foliage that results in reduced feeding and oviposition (Table 1.2). Repellency is only used tentatively as a mechanism since it has not yet been demonstrated whether insects orient away from particle films before film contact (repellence) versus after film contact, which is more appropriately termed a deterrent (Puterka and Glenn, in press). These mechanisms will be dependent on the insect species. Other mechanisms include: (1) reduced survival of adults or immature insects (larvae) when born into the particle film coated leaf

environment (Knight et al. 2000; Unruh et al. 2000; Cottrell et al. 2002; Puterka and Glenn, in press), (2) reduced mating success of adult lepidoptera exposed to particle films (Knight et al. 2000; Puterka and Glenn, in press), (3) impeded movement/host finding ability within plant canopies (Unruh et al. 2000), (4) camouflage of the host by turning the plant foliage white with the particle film (Puterka et al. 2003a; Puterka and Glenn, in press), and (5) impeding the insect's ability to grasp the plant (Table 1.2). In impeding an insect's ability to grasp the plant, insects simply "fall-off" the host plant (Puterka and Glenn, in press). Most of the effects particle films have on insects result from particle attachment to the insect's various body parts (Plate I, bottom).

The lethal effects of particle attachment to insects have been well documented (Alexander et al. 1944a,b; David and Gardiner 1950; Ebling 1971). Yet, one should not underestimate the effects particle films have on altering the insect's visual and tactile perception of the host as key aspects in host finding and acceptance (Miller and Strickler 1984). Although repellence of aphids (Kennedy et al. 1961; Kring 1962, 1965; Nawrocka et al. 1975) and thrips (Wilde 1962; Ota et al. 1968; Smith et al. 1972) by reflective mulches has been demonstrated, the effect of reflected light on other arthropod species has not been well studied. Many other arthropod species besides aphids are attracted to specific colors, such as yellow for glassy-winged sharpshooter [*Homalodisca coagulata* (Say)] (Puterka et al. 2003a), pear psylla (*Cacopsylla pyricola* Foerster) (Puterka and Glenn, in press), and red for apple maggot [*Ragoletis pomonella* (Walsh)] (Prokopy and Hauschild 1979). Many arthropods have been shown to be attracted to specific colors that are believed to represent a "super-normal" colored host, where, for example, yellow represents super-normal foliage mimics (Prokopy and Owens 1978). Masking host plant color with reflective white particle films could conceivably have major effects on arthropod pest behavior.

E. Examples of Successful Particle Film Use to Control Arthropod Pests

Particle film technology became commercially available to growers in 2000. Surround® WP is registered for control of a broad range of arthropod pests on nearly all major groups of agricultural crops and has been successfully used against many more pests than summarized in Table 1.2. Particle film technology has had a major impact on two arthropod pests in particular, pear psylla (*C. pyricola*) in pear, and the glassy-winged sharpshooter (GWSS) (*H. coagulata*). These two successes will be reviewed in more detail.

The pear psylla is a key pest of pear whose feeding causes leaf necrosis, defoliation, and reduced yields (Hibino et al. 1971). This pest rapidly develops resistance to insecticides (Follett et al. 1985; Pree et al. 1990). Much of the original entomological research on particle films used this organism as a model pest species (Glenn et al. 1999; Puterka et al. 2000a,b; Puterka and Glenn, in press). Processed kaolin repelled adult pear psylla and reduced oviposition greater than minimally processed, air floated kaolin (Puterka et al. 2000a). Both hydrophobic M96-018 and hydrophilic M97-009 + M03 (Surround[®]) particle films were based on the same purified and processed kaolin, and both have demonstrated comparable efficacy against pear psylla. This efficacy operated through at least six mechanisms: repellence, ovipositional deterrence, reduced feeding efficacy, impeded grasping of the host (fall-off), host camouflaging, and direct mortality (Puterka et al. 2000a,b; Puterka and Glenn, in press). Repellence is the most obvious effect that particle films have on psylla adults and several factors are thought to influence repellence. Hydrophobic particle films cause greater particle attachment to pear psylla than hydrophilic particles, thus, hydrophobic particles have greater effects on pear psylla biology and behavior (Puterka and Glenn, in press). Despite such differences in particle attachment between formulations, those formulations that show lower particle attachment compared to M96-018 remain repellent to pear psylla adults. Repeated summer applications of Surround[®] can produce a white staining effect on tree bark that remains through the winter and effectively prevents oviposition on dormant twigs the following spring (March) (Puterka et al. 2000). This observation of carryover effect suggested that particle attachment may not be necessary to prevent oviposition of winter-form adults, and alterations in bark color or surface structure could deter oviposition. Psylla adults show no preference for color during March and become attracted to yellow only after pear begins to break dormancy and produce foliage (Puterka and Glenn, in press), which argues against white staining of the bark as a possibility in deterring oviposition. Thus, the alteration of the twig surfaces by the incorporation of kaolin particles may have been a key factor in reducing pear psylla oviposition. Horton (1990) noted that psylla adults prefer to oviposit in the grooves, lenticels or other areas of relief in the leaves or bark. Thus, it is possible that these areas of relief in the bark could be altered by the particle film treatments (Puterka and Glenn, in press). Once green foliage became available, the carryover effect on overwintering psylla adults was lost and eggs were deposited on untreated foliage (Puterka et al. 2000).

Initially, control of pear psylla with particle films was conducted on a season-long basis where up to 13 applications were used (Puterka et

al. 2000b). However, commercial usage in conventional pear orchards in northern Washington State soon focused on early-season control where two to three applications of particle films were applied at 6% solids to dormant trees prior to bloom (Plate II, top left). Timing applications prior to bloom often resulted in greatly reducing pear psylla oviposition to the extent that applications after petal-fall were rarely needed. Usage of Surround® WP on U.S. pear crop area grew from 2% in 1999 to 14% in 2001, and its usage in 2002 and 2003 increased to nearly 50% of U.S. pear growers. The remarkable efficacy of particle film technology against pear psylla inspired the Washington State Research and Extension Service to organize an area-wide approach for psylla control called the Peshastin Creek Pear Growers Area-Wide Organic Project that was instituted in 2002. In this program, psylla is predominately controlled by Surround® WP, while other insects not controlled by Surround® WP, such as mites, are controlled using spray applications of light summer oils. This program has effectively reduced insecticide usage in pear by directly replacing conventional chemical insecticides.

The second successful example of particle film use is against the glassy-winged sharpshooter (GWSS) (Plate II, top right). The GWSS is a serious pest of grape that was recently introduced before 1990 in southern California via eggs on nursery stock (Sorensen and Gill 1996). By 1999, the GWSS had spread throughout coastal southern California and northward into the southern San Joaquin Valley where it utilized citrus as a primary host. GWSS is considered a minor pest in citrus and is generally not controlled. The GWSS has become a significant problem to California agriculture because it feeds readily on grape vines and, in doing so, transmits *Xylella astidiosa*, the causal agent of Pierce's disease (PD). PD causes leaf scorching, vine dieback, and eventually kills the vine within a few years (Phillips 1999). There is currently no cure for PD (Krewer et al. 2002).

This sharpshooter species was considered a significant threat to California's \$40 billion grape industry because there were no known low-toxicity control measures available for preventing GWSS from feeding on grape vines and vectoring PD. Contact insecticides only offer short-term protection against infestations but the continual influx of immigrating sharpshooter adults from nearby citrus soon re-infests grape vines. Systemic treatment of grape vines with imidacloprid, Admire 2E (Bayer Co., Kansas City, Missouri), was found to slow the rate of disease incidence but only extended vineyard life by one year under high GWSS infestations (Krewer et al. 2002). GWSS is a particular problem in California where citrus borders grape vineyards and citrus trees are the pri-

mary reproductive host. GWSS reproduces in citrus orchards during the summer months and over-winters in citrus. When air temperatures begin to rise in the spring, GWSS migrates into grape vineyards where it feeds and reproduces. GWSS spreads PD during the feeding process. Research in Kern County, California established that when grape vines were treated with Surround® WP in a 247.5 m barrier where grape vines bordered citrus (Fig. 1.2, top), migration of GWSS was suppressed and oviposition was prevented (Puterka et al. 2003a). Furthermore, the Surround® WP barrier on grape vines had a sufficient depth to prevent GWSS from flying over the barrier and invading vineyards. In that study, three bi-weekly applications of Surround® WP outperformed six weekly applications of contact insecticides in reducing GWSS infestations, and Surround® WP nearly eliminated oviposition (Fig 1.2, bottom). The modes of action of particle films on GWSS include repellence, ovipositional deterrence, and host camouflaging (Puterka et al. 2003a). GWSS were found to be attracted to yellow, and to a lesser degree orange, while white was non-attractive during the grape growing season, making host camouflaging a possibility. A large-scale pilot study called the General Beale GWSS Management Program was initiated in 2001 in Kern County; it utilized Surround® WP as part of the IPM strategy. Surround® WP was used in this program as a 247.5 m barrier in grape vines that bordered citrus where treatments began in March prior to GWSS migration into vineyards. The strategy was to keep GWSS contained in citrus until temperatures increased to about 18°C, the minimum temperature needed for satisfactory levels of control with pyrethroid insecticides in citrus. This program decreased the GWSS number from up to a thousand per trap to undetectable levels in vineyards and citrus groves within a year. The success of the program resulted in its expansion to include most of Kern County the following year. Research is ongoing to determine whether reduced adult GWSS activity in Surround® treated plots resulted in PD reductions in vines.

III. PHYSIOLOGICAL AND HORTICULTURAL USES OF PARTICLE FILMS

A. Effects on Net Gas Exchange and Productivity

Practitioners learned that the application of mineral particles could greatly reduce disease and insect damage but this benefit was overshadowed by negative effects of light reduction and reduced photosynthesis.

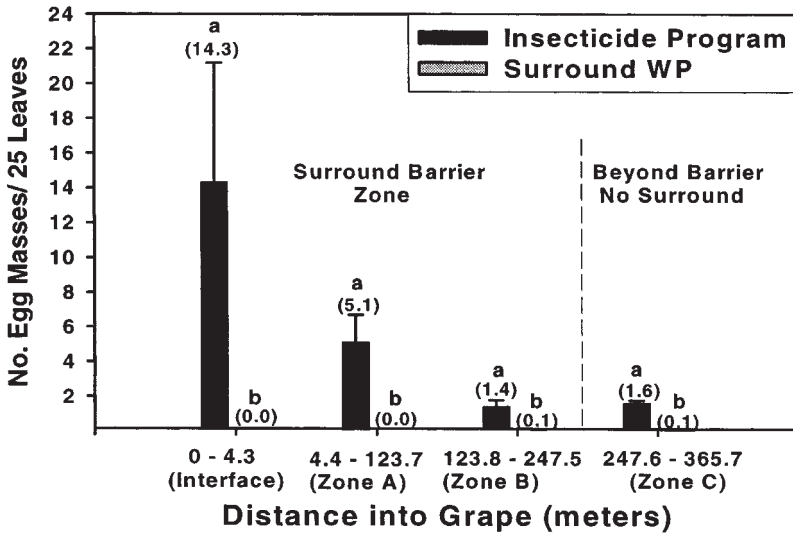
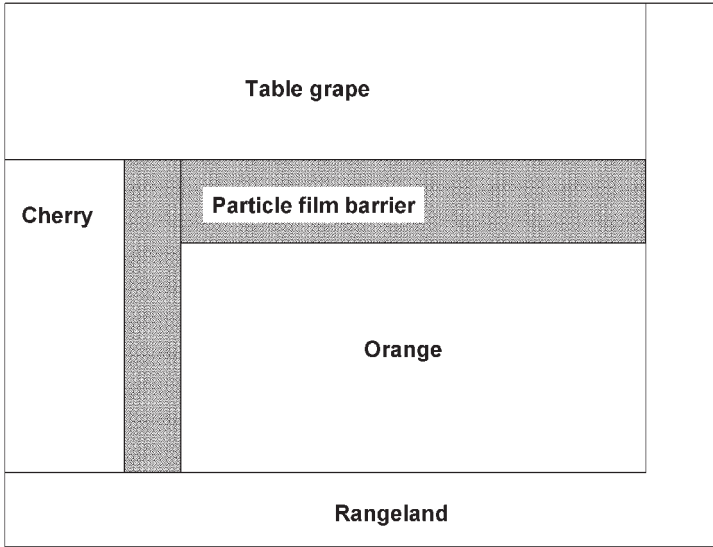

Fig. 1.2. (Top) Typical cropping system in Kern Co., California where citrus borders grape. A 247.5 m buffer zone of Surround® WP particle film as a barrier was applied in grape to prevent glassy-winged sharpshooter (GWSS) from migrating out of citrus orchards into grape vineyards during the spring. GWSS infestations were contained by the barrier until insecticides were applied in citrus to eliminate GWSS. (Bottom) Effect of biweekly Surround® WP and weekly contact insecticide applications on GWSS oviposition three weeks after the last insecticide application, Kern Co., CA. Contact insecticides were also applied beyond the Surround® WP barrier.

Lime sulfur applications reduced photosynthesis for several days following application (Hoffman 1934). Bordeaux mix, particularly the copper sulfate portion, physiologically reduced photosynthesis by chemical interference, and not by blocking light (Southwick and Childers 1941). Lime sulfur reduced photosynthesis more than a “dry mix (wetable sulfur)” which had little or no effect on leaf photosynthesis. Mills (1937) demonstrated improved vigor and long-term yield using wettable sulfur agents for disease control compared to lime sulfur. Heinicke (1937) confirmed the reduction of photosynthesis by lime-sulfur and advocated the use of milder agents such as wettable sulfur that would have “cumulative benefits resulting from the greater photosynthetic activity of the leaf surface.” Heinicke (1937) noted “improvement in color and size of fruit where the leaf surface is not handicapped by the application of materials that tend to inhibit photosynthesis.” Current agrichemicals such as surfactants and foliar urea (Orbovic et al. 2001), fungicides (Wood et al. 1984), and insecticides (Wood and Payne 1984) can also reduce photosynthesis on a short-term basis. Yet, the temporary reduction in photosynthesis apparently is acceptable because the value of the pest control outweighs the transient reduction in photosynthesis. Particle film technology builds on this idea of using mineral particles that are chemically inert in order to reduce any deleterious effects on leaf physiology and to safeguard human health.

The deposition of fine particles on plant surfaces from natural and human activities, such as mining and road traffic, generally decreased plant productivity due to light blockage that reduced photosynthesis and interference with stomatal activity that increased leaf temperature when sufficient residue develops (1 to 10 g/m²) (Thompson et al. 1984; Armbrust 1986; Farmer 1993; Hirano et al. 1995). Yet reflective antitranspirants, historically termed whitewashes, have been used in agriculture to reduce heat stress. Reflective antitranspirants, unlike polymer film antitranspirants that physically block the stomates, have antitranspirant properties because they can lower leaf temperature (Gale and Hagan 1966) by increasing reflection of infrared radiation (IR). Lowered leaf temperature reduces the vapor pressure gradient between the leaf and the bulk air which is the driving force behind transpiration (Pennman and Schofield 1951) and reducing the vapor pressure gradient reduces transpiration. Abou-Khaled et al. (1970) conducted the first systematic evaluation of reflective minerals as antitranspirants by applying a minimally processed kaolin mineral whitewash to bean, citrus, and rubber plants. They observed that most of the radiation reflected was in the visible region rather than the infrared (IR), transpiration was reduced 20–25%, and leaf temperature was reduced up to 5°C over a wide range of photosynthetically active radiation (PAR). In addition, photosynthesis (P_n)

was reduced by the kaolin coating at low light intensities but Pn was equivalent or higher at high light intensities. Carbon dioxide assimilation/transpiration ratios or water use efficiency (WUE) increased with the kaolin treatment, indicating improved WUE under high light intensity. These reflective antitranspirants would be beneficial under conditions of high light intensity where the Pn rate was light saturated. Abou-Khaled et al. (1970) stimulated considerable research in the following three decades. In a series of five publications [Doraiswamy and Rosenberg (1974); Lemeur and Rosenberg (1974, 1975); Baradas et al. (1976a,b)] a group headed by Rosenberg examined the energy balance components of soybean coated with kaolin mixed with guar gum plus a surfactant and demonstrated that net radiation was reduced because reflection of short wave and long wave radiation was increased. The reduced net radiation could potentially reduce transpiration but there were conditions in which leaf temperature could increase or decrease with the application of kaolin depending on how much transpiration and the vapor pressure deficit (VPD) were affected. Basnizki and Evenari (1975) applied a commercial reflectant to globe artichoke and reduced leaf temperature, increased water use efficiency, and increased plant survival. Stanhill et al. (1976) increased sorghum yield 11% over a 3-year period with kaolin formulations similar to Doraiswamy and Rosenberg (1974), yet they measured a long-term reduction in CO₂ assimilation and early leaf senescence. Moreshet et al. (1979) used a gum binder with kaolin applied to cotton and measured an 11% lint yield increase in one year and no effect in a second year; however, total biomass was unaffected in either year. Their kaolin treatment of 25% (w/w) did reduce ¹⁴CO₂ uptake due to both a reduction in light absorption and partial blockage of stomata, yet these presumably negative effects did reduce water stress. Mungse and Bhapkar (1979) applied three reflectants (kaolin, calcium silicate, and a commercial whitewash) to both the plants and soil in dryland sunflower and found that all three reflectants increased grain and oil yield. Seasonal water use of the three reflectants was slightly higher than the untreated control, but yield increases were proportionally larger, resulting in improved water use efficiency with the use of the reflectants. Souondara Rajan et al. (1981) applied 3% and 6% kaolin to peanuts and increased yield with both concentrations, yet the 6% kaolin treatment had yield less than the 3% kaolin treatment (732 vs 1755 vs 1010 kg/ha for control, 3%, and 6% kaolin, respectively). These data suggest that 6% kaolin residues were excessive and were in some manner limiting photosynthesis. Rao (1985) applied 5% kaolin with a surfactant to non-irrigated tomato and increased yield compared to untreated controls. In subsequent work, Rao (1986) suggested that the yield increase and improved water status

was due to decreased transpiration caused by reduced stomatal opening (4.1 vs 3.5 μm for control and kaolin treatments, respectively). In contrast to previous work, Nakano and Uehara (1996) found that kaolin applied to leaves and fruit increased cuticular transpiration and they suggested that the kaolin particles may combine with the waxy components of the cuticle to facilitate water movement through cuticular layers. Anandacoomaraswamy et al. (2000) applied kaolin to tea and slightly reduced transpiration from 10:00 to 15:00 hr; however, yield was unaffected.

It is critical that any product applied to a plant not interfere with the exchange of carbon dioxide through the stomates, otherwise primary productivity will be reduced. Antitranspirants increase stomatal closure to maintain high plant turgor by reducing transpiration, but obstructing stomates will also reduce photosynthesis when stomatal conductance is the limiting factor for carbon assimilation (Weller and Ferree 1978; Gu et al. 1996). Moreshet et al. (1979) applied hydrous kaolin to cotton and reduced $^{14}\text{CO}_2$ uptake within 2 days by more than 20% and they attributed the reduced carbon assimilation to reduced stomatal conductance since transpiration was reduced more than photosynthesis. However, not all formulations of kaolin applied to leaves will reduce stomatal conductance. Glenn et al. (2001c, 2003) demonstrated that stomatal conductance, transpiration, and photosynthesis are increased with the application of both hydrophobic and hydrophilic particle films based on heat activated and purified kaolin. While there are mineralogical differences in the kaolin used by Moreshet et al. (1979) and Glenn et al. (2001c, 2003), a key difference was the formulation. The formulation of Glenn et al. (2001, 2003) was friable (loosely bound), porous, and allowed the opening and closing of the stomates to dislodge particle fragments from the stomatal opening (Fig. 1.3). The formulation of Moreshet et al. (1979) utilized a gum agent as a binder that blocked stomatal openings.

Photosynthetically active radiation from 400 to 700 nm (PAR) is captured in the chemical pathway of photosynthesis and it is critical that PAR reach the chloroplasts in the mesophyll instead of being reflected or absorbed by a particle film on the leaf surface. Early research with reflectants attempted to reduce net radiation on the plant canopy under conditions of high PAR. Doraiswamy and Rosenberg (1974) applied a kaolin mixture to soybean and reduced net radiation about 8%, primarily by increasing reflection of PAR with little reflection of longwave radiation (IR). In contrast, Abou-khaled et al. (1970) found both high reflectivity in the PAR and near IR wavelengths by kaolin on orange, lemon, and rubber trees. The physical and optical properties of kaolin can be altered by processing to achieve specific particle size distributions and heating (calcination) to alter light transmission properties.

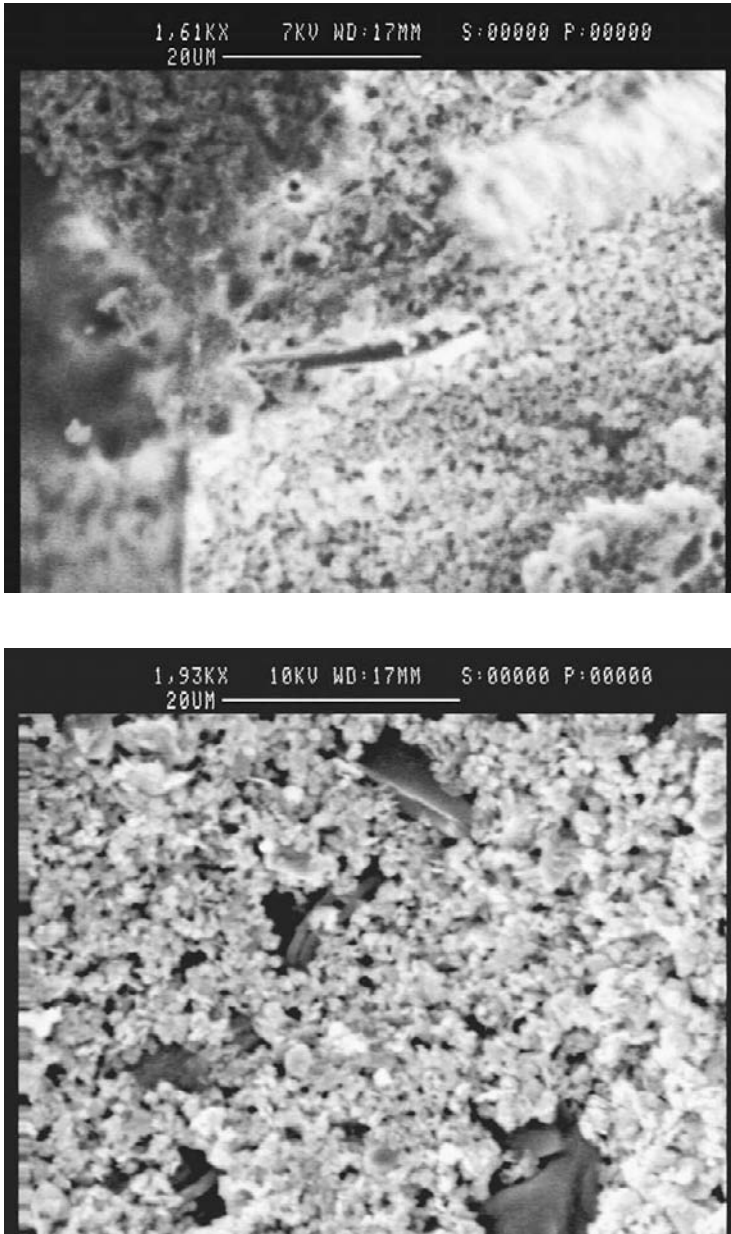

Fig. 1.3. SEM of stomata in apple. (Top) After initial application of Surround® WP Crop protectant. (Bottom) After 3 days. The particle bridges over the openings have been broken away by the opening and closing action of the guard cells.

The formulation of processed kaolin used by Glenn et al. (1999) and Jifon and Syvertsen (2003b) transmitted more PAR than the unprocessed kaolin of Abou-khaled et al. (1976) (Fig. 1.4). While the formulation used by Glenn et al. (1999) was hydrophobic and that used by Jifon and Syvertsen (2003a,b) was hydrophilic, both formulations are based on the same processed kaolin particles and have very similar optical properties. Both formulations deposit films similar in thickness and weatherability (Puterka et al. 2000).

Rosenberg (1974) stated that *“If reflectants can be developed that are more effective in the near IR, greater reduction in the energy load on the crop can result with less direct interference in photosynthesis. Although these advances await research and development, reflectant materials in use thus far already offer one very important advantage over most of the chemical antitranspirants. They are inert materials that pose no danger to the health of man or of domestic and wild animals.”* The current state-of-the-art in particle film technology has achieved some of these predictions by reducing direct interference with photosynthesis through formulation and structural changes to kaolin.

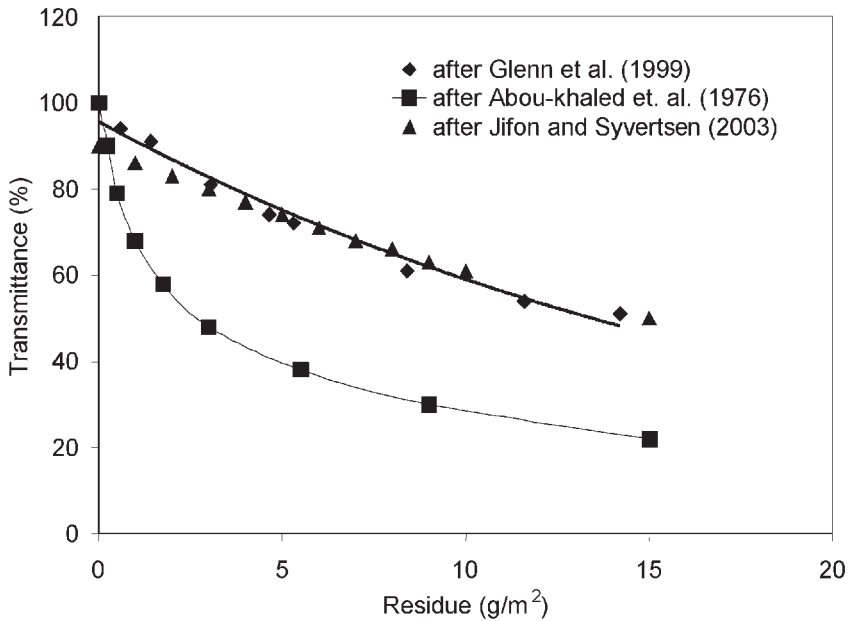

Fig. 1.4. Transmission of PAR through particle films of various kaolin sources.

Glenn et al. (1999) demonstrated that tree canopy temperature was reduced and peach yield and shoot growth were unaffected by dusting with hydrophobic particles (M96-018, Engelhard Corp., Iselin, New Jersey). Single-leaf studies did not indicate any reduction in photosynthesis with the application of M96-018 > 10 g/m² leaf area. Puterka et al. (2000b) compared hydrophobic and hydrophilic kaolin formulations in pear production and both formulations increased pear yield nearly 100% (Table 1.3).

Glenn et al. (2001c) used an aqueous formulation of hydrophobic kaolin (Glenn et al. 1999) to examine its effect on apple physiology in a number of locations. Single-leaf carbon assimilation was increased and canopy temperatures were reduced by particle sprays in seven of the eight trials. The trial that did not demonstrate an increase in single-leaf photosynthesis was conducted in Washington State when air temperature was less than 25°C, while all the other trials had air temperature greater than 30°C. Thus, it appears that when air temperatures are near the photosynthetic optimum (25°C), an increase in P_n should not be expected. Yet, in this trial there was an increase in yield when particle sprays were applied early in the growing season, when high air temperatures occurred. Yield and/or fruit weight were increased by the particle treatment in seven of the eight trials. There was no yield increase when fruit were severely hand-thinned to limit the size of the fruit sink despite an increase in single-leaf photosynthesis. Red fruit color was increased, but not consistently. Elkins et al. (2001) improved 'Red Sensation Barlett' pear color at harvest and after 1 and 3 months storage. The mechanisms of particle treatments affecting fruit color are not clear at this time and will require further study.

Surround[®] WP application to cotton reduced free amino acid content, specifically, alanine, arginine, isoleucine, phenylalanine, and threonine, compared to untreated plants (Showler 2002b). The reduction of arginine in the absence of a change in proline suggested heightened

Table 1.3. Effect of hydrophobic and hydrophilic kaolin applications on 'Seckle' pear productivity and quality (after Puterka et al. 2000).

Treatment	Yield (kg/tree)	No. fruit/tree	Fruit size (g)	Red color (%)
Hydrophilic kaolin	54.8 a ²	1392 a	39.4 ab	56.5 a
Hydrophobic kaolin	54.0 a	1237 a	43.7 a	45.5 a
Conventional	28.3 b	793 b	35.7 b	27.5 b

²Mean separation in columns by Duncan's Multiple Range Test (P ≤ 0.05).

light reception or photosynthetic activity but did not indicate typical shade responses in the free amino acid profiles. In conjunction, Makus (2000) and Makus and Zibilske (2001) measured increased leaf transpiration, reduced canopy temperature, and increased biomass and lint yield in cotton with Surround[®] applications. Citrus leaves are light saturated at relatively low PAR levels and are vulnerable to overexcitation of the photochemical systems (Jifon and Syvertsen 2003b). High PAR levels can elevate leaf temperature and increase the VPD. Kaolin treatments increased citrus leaf reflectance, lowered leaf temperature and reduced the VPD (Jifon and Syvertsen 2003a) and similar responses were observed with shading (Jifon and Syvertsen 2003b). In single leaf studies, carbon assimilation, stomatal conductance, and water use efficiency were increased, particularly during midday hours, by 3 applications of Surround. They speculated that in warm climates with high PAR levels and high VPDs, where these conditions likely limit photosynthetic capacity, kaolin applications could improve carbon assimilation in young and small trees where most of the leaves are exposed to direct sunlight. In two of three years in California, citrus yield was increased by the application of 3 monthly applications of 3% Surround[®] beginning in April (Table 1.4, unpubl. data). Yield was increased due to an increase in fruit number from less fruit drop in 2001 and 2002 with no change in fruit size. Reducing heat stress with Surround[®] applications in 2001 and 2002 reduced fruit drop. Fruit drop, however, was not a limiting factor in 2003.

Glenn et al. (2003) measured whole-tree carbon assimilation, water use efficiency, yield, and quality of apple treated with processed kaolin and calcium carbonate particle films. Whole-tree carbon assimilation was increased by processed kaolin applications only under conditions of excessive air temperature. Carbon assimilation was increased by the processed kaolin treatment but water use efficiency was reduced likely due to increased stomatal conductance associated with reduced leaf

Table 1.4. Effect of kaolin (Surround[®] WP) application in citrus production (D. M. Glenn, unpubl. data).^z

Treatment	Yield (metric tons/ha)		
	2001	2002	2003
Conventional production	36.1 b	17.8 b	54.1
Surround [®] treatment	39.3 a	27.3 a	52.5 ns

^zN=4. Plots were arranged in a randomized block design. Each plot was approximately 1 ha. (P=0.05).

temperature that increased transpiration more than photosynthesis. Calcium carbonate produced none of these effects and reflected more PAR from the tree canopy than processed kaolin.

In summary, many key horticultural characteristics such as fruit size, fruit color, and yield have been improved by the application of reflective kaolin particle film materials. The proper environment, plant species, and time of application interactions need to be refined on a regional or seasonal basis in order to assure that the predicted horticultural response will occur and be of economic value.

B. Reduction of UV Damage

Ultraviolet radiation is categorized in 3 bandwidths: UVa (315 to 400 nm); UVb (280–315 nm); UVc (195–280 nm). Deleterious ultraviolet radiation (UV) effects on plants include formation of DNA dimers, and inhibition of photosystem II and Rubisco activity. At plant temperatures >35°C, both UV damage and photoinhibition of photosystem II can be additive. However, under high PAR, photoreactivation can repair much of the DNA damage and UV damage is less than under low PAR conditions (Tevini 1999). Kaolin is reflective of UV radiation (Plate II, center) but the formulation and particle size distribution significantly influence the degree of its UV reflection. The formulation of the highly processed Surround[®] WP has greater UV reflection than unprocessed kaolin or calcium carbonate (Fig. 1.5).

UV reflection was increased by increasing amounts of Surround[®] residues on the fruit and leaf surfaces (Fig. 1.6 and Plate II, center) (Glenn et al. 2002). In 50% of the recent studies, ambient solar UVb imposed significant constraints on biomass accumulation for terrestrial plants, yet these reductions in productivity typically occurred without a reduction in photosynthetic rates per unit leaf area (Day and Neale 2002). In addition, UVb effects can be chronically deleterious to perennial crops by reducing leaf area. Plants generally respond to UVb by increasing leaf thickness through thickening of the cuticle in addition to synthesizing UVb absorbing compounds (Tevini 1999). The application of a particle film artificially increases leaf thickness so the path length of radiation to target cells within the leaf (Fig. 1.1 A) is increased, as well as reducing the UV radiation load at the cuticle level of the leaf.

Sunburn or solar injury (SI) is defined as damage to fruit exposed to direct solar radiation (Jones and Aldwinckle 1990). The biological value of reflecting UV to reduce SI is not established, because the role of UV in SI is not clear. Lipton (1977) demonstrated that UVa directly induced SI in cantaloupes and Renquist et al. (1989) found that SI in raspberry

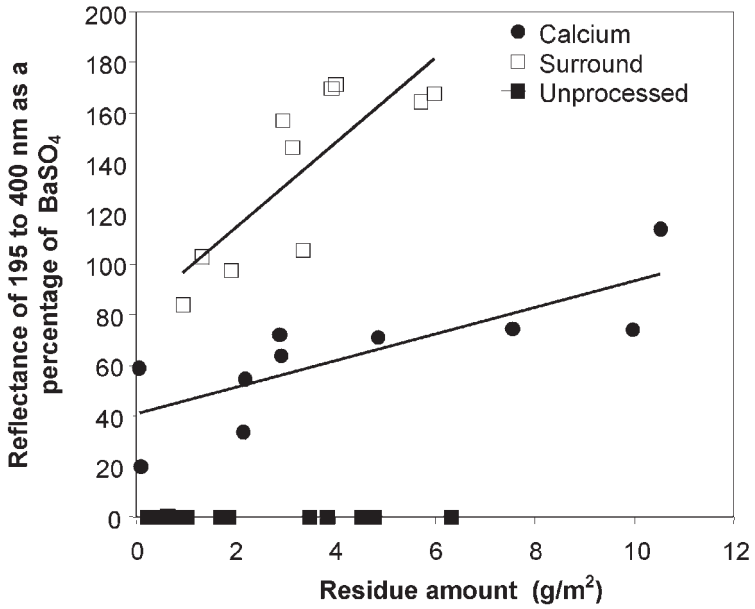

Fig. 1.5. Reflectance of ultraviolet radiation by Surround WP®, a highly processed kaolin, unprocessed kaolin and calcium carbonate.

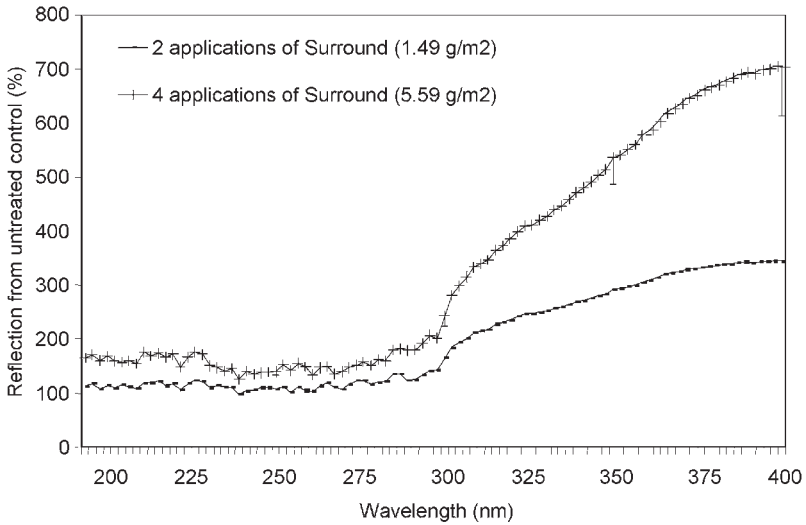

Fig. 1.6. Reflection of ultraviolet radiation from the surface of 'Fuji' apple.

was directly proportional to UVb dosage when exposed to air temperature of 42°C. In contrast, Lipton et al. (1987) found that UV radiation had minimal effect on SI in 'Honey Dew' melons, and Adegoroye and Jolliffe (1983) suggested that SI in tomatoes was due primarily to IR and that visible and UV radiation did not have an essential role. Both a critical temperature and solar radiation were necessary for SI in apple, but Schrader et al. (2001) did not distinguish the roles of UV and visible radiation. Wunsche et al. (2000) used mylar bags to exclude UVa and UVb from fruit surfaces and found no effect on SI development, although there was low SI severity in general. Yet, particle film application reduced SI in apple (Glenn et al. 2002) by mechanisms that include reflection of UV radiation. New uses of kaolin particle film under specific environmental conditions will likely be developed to exploit the mitigation of UV injury to plant tissue.

C. Reduction of Solar Injury

Whitewash and other materials formulated to have paint-like properties have been successfully used to reduce SI for decades. Serr and Foott (1963) applied a 6% mixture of $ZnSO_4$ and $Ca(OH)_2$ and a commercial whitewash of undisclosed composition to Persian walnut trees with no apparent injury to the trees. The temperature of the nut centers was reduced approximately 3°C by the treatments and sunburn damage of nuts, leaves, and twigs was reduced. Lipton and Matoba (1971) reduced sunburn of 'Crenshaw' melons with a 12% concentration of finely ground aluminum silicate by reducing surface temperature 8°C. This technology was incorporated by the California tomato industry in the early 1970s (Elam 1971). If there were reductions in fruit number or size, they were not measured and the benefit of increased yield of non-SI-damaged fruit outweighed any reduction in plant productivity.

The conditions that cause solar injury include high air temperature and solar radiation (UV 195–400 nm; PAR 400–700 nm; IR >700 nm). Serr and Foott (1963) felt that 38°C was a critical air temperature for walnut sunburn. Critical fruit surface temperatures include: 50°C for muskmelons (Lipton and O'Grady 1980); 42°C for raspberry fruit (Renquist et al. 1989); 40°C for tomatoes (Rabinowitch et al. 1974); 46–49°C for browning and 52°C for necrosis of apple skin (Schrader et al. 2001). Only Adegoroye and Jolliffe (1983) present data that solar radiation, either visible or UV, did not have a role in tomato sunscald. Schrader et al. (2001) present a strong argument that solar radiation is a key component of sunburn in apple and that sunburn can occur at air tempera-

tures as low as 30°C under conditions of strong solar illumination. The VPD may also be a component of SI but it has not been documented. A secondary condition that exacerbates SI is the lack of foliar shade on a plant or the movement of fruit from shade to sunlight as the fruit increases in weight and changes position (Rabinowitch et al. 1986; Drake et al. 1991; Parchomchuk and Meheriuk 1996; Khemira et al. 1993).

Evaporative cooling is an effective means of reducing fruit temperature but there are concerns over expense, water quality, and the need to reduce agricultural water use (Parchomchuk and Meheriuk 1996; Unrath and Sneed 1974). The application of a Surround® particle film approached the effectiveness of evaporative cooling with intermittent water sprays in reducing fruit temperature (Table 1.5).

Reductions in fruit surface temperature can be correlated to the amount of Surround® residue on the fruit surface (Glenn et al. 2002). Midday fruit surface temperatures were reduced as much as 5–10°C by a Surround® WP particle film (Plate II, bottom). Solar injury was reduced almost 100% in some studies and had no effect in others, while the general trend was approximately a 50% reduction in SI fruit damage. The incidence of SI varied by location and cultivar. Schupp et al. (2002a,b) reduced sunburn in ‘Fuji’ apple in Idaho using Surround® but reduced fruit size and color at that location and also in ‘Honeycrisp’ apple at a New York location. They concluded that light in New York was more limiting to fruit growth and development than reduced temperature. Under New York conditions, the increased reflectance from the Surround® treatment may have reduced photosynthesis to the point that it

Table 1.5. Maximum daily fruit surface temperature (°C) of two apple cultivars treated with Surround® WP reflective particle film at Finley, Washington, 1999. (modified from Glenn et al. 2002)

Treatment	Scarlet Delicious			Fuji	
	21 Aug. ^z	22 Aug.	24 Aug.	25 Aug.	26 Aug.
Non-treated	40.9 a ^y	41.8 a	40.4 a	37.2 a	42.3 a
Surround®	36.9 b	37.5 b	38.1 b	35.8 b	38.8 c
Evaporatively cooled ± CI	32.8 ± 2.1 ^x	36.9 ± 2.4	35.4 ± 1.2	36.3 ± 1.1	38.1 ± 1.2
Air temp. (C)	30.0	31.1	34.8	32.8	28.1

^zSampling date.

^yMean separation using Duncan’s Multiple Range Test, $P < 0.05$.

^x95% confidence interval from a non-replicated, evaporatively cooled area adjacent to the study site.

diminished fruit growth and color development, especially when applied late season. In contrast, Garcia et al. (2003) increased fruit size and percentage red color in Vermont in a two-year study. R. Byers (pers. commun.) delayed fruit color development in 'Fuji' and 'Gala' but full color did develop, indicating that harvest dates may be changed by Surround usage. E. Fallahi (pers. commun.) has not found reductions in fruit size or color for a number of apple cultivars in subsequent years in Idaho but has observed reduced SI.

Chlorophyll fluorescence of apple fruit can indicate heat stress and solar injury (Song et al. 2001; Wunsche et al. 2000). Flesh browning was negatively correlated with chlorophyll fluorescence in both studies. Shaha (unpubl. data, 2000) observed that photoinhibition in apple fruit surfaces was significantly reduced on 'Jonagold' apples when treated with Surround[®] WP (16 vs 30% inhibition for Surround[®] WP treated vs untreated control). This demonstrated the effectiveness of the particle film to reduce the heat and light load on the fruit surface that caused photoinhibition.

There are significant differences in heat flux between minimally processed kaolin that has had only coarse sand particles removed and highly processed kaolin used in Surround[®] WP that is purified and structurally altered by heat-treatment (calcination), thus the processing of kaolin is a key component in the reflection of heat (Fig. 1.7). The processing of kaolin increased both IR (Fig. 1.7) and UV (Fig. 1.5) reflection, which are key aspects of reducing solar injury in horticultural crops.

The demand for water in agriculture is in competition with urban, industrial, and recreational water demands. New tools are needed to reduce agriculture's consumption of water without jeopardizing yield stability or quality. We have demonstrated that kaolin particles can be engineered and formulated to reflect more heat and UV radiation than minimally processed kaolin so that SI can be effectively reduced. Particle film technology applied the knowledge of particle processing to the problem of SI and provided a tool to reduce or eliminate evaporative cooling of horticultural crops.

IV. DISEASE CONTROL WITH MINERAL AND PARTICLE FILM MATERIALS

Lime, sulfur, and lime-sulfur affect plant pathogens through chemical mechanisms (Secoy and Smith 1983). There are numerous citations of pH-altering minerals that are effective fungicides and include the common water-soluble minerals: hydrated lime, monopotassium phosphate,

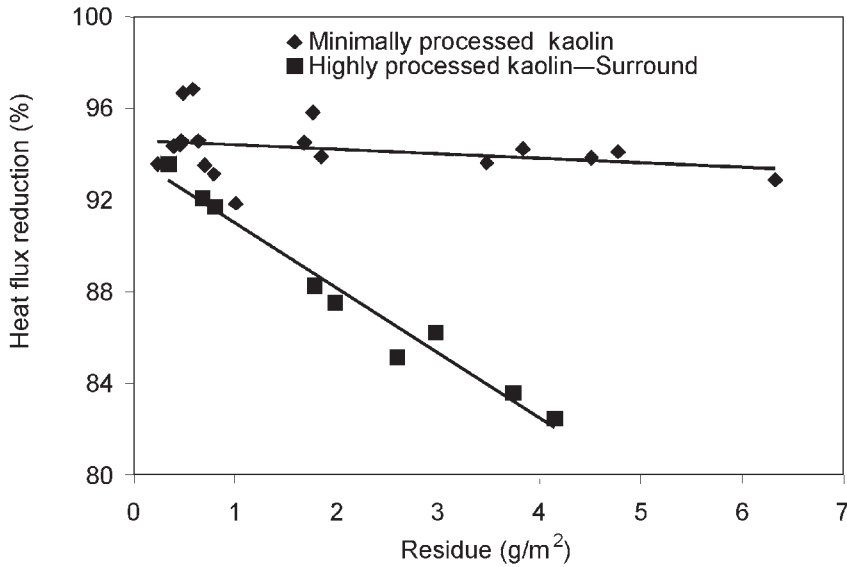

Fig. 1.7. Heat flux of highly processed kaolin, Surround® WP, and a minimally processed kaolin.

and various silicates, carbonates, and bicarbonates (Horst et al. 1992; Ziv and Zitter 1992; McAvoy and Bible 1996; Spotts et al. 1997; Reuveni et al. 1998a,b; Washington et al. 1998; Olivier et al. 1998; and citations included therein). Neinhuis and Barthlott (1997) examined over 200 plant species and found that a common plant adaptation that appears to suppress disease infection is production of water-repellent plant surfaces. Water-repellent surfaces facilitate the removal of particulate depositions (spores, conidia, hyphae) through the deposition and subsequent runoff of rain, fog, or dew. A cleansing action occurs when particulate depositions adhere to water droplets and are carried off the plant surface. Glenn et al. (1999) mimicked this mechanism by applying hydrophobic kaolin (M96-018) to plants in order to develop an artificially hydrophobic plant surface that would repel water. In single-leaf laboratory studies, fungal infection could be completely eliminated; however, on the whole plant and field plot scale, studies found complete coverage by the hydrophobic kaolin was impossible and so failed to control apple scab (*Venturia inaequalis*) (Puterka et al. 2000). Fabrea leaf spot (*Fabreae maculata* Atkinson) of pear was suppressed by both hydrophobic and hydrophilic kaolin particles, presumably through both a physical interference in the infection process and a lack of adherence

of inoculum to the plant surface (Puterka et al. 2000). Powdery mildew in squash was suppressed by whitewash (Marco et al. 1994), in cucumber and grape by a chlorite-mica clay (Ehret et al. 2001), and in apple by processed kaolin (Glenn et al. 2001b). The bacterial disease, Fireblight (*Erwinia amylovora*), has been suppressed by both hydrophobic (Glenn et al. 1999) and hydrophilic kaolin particles (Glenn et al. 2001b) applied to flowers under conditions of artificial inoculation in greenhouse and field studies. Surround[®] also suppressed fireblight blossom infection under natural infection conditions. Surround[®] applications (3%) to 10-year-old 'Jonathan' apple trees 3 days prior to an infection event, the day of the infection, and 3 days following infection, reduced blossom blight from 28% in the untreated treatment to 5% in the Surround[®] treatment (N=21, $P \leq 0.05$). The mechanism of action is probably a physical interference of the initial infection of the hypanthium. Based on these results (Glenn et al. 1999, 2001b; Puterka et al. 2000), particle film technology has the potential to suppress some bacterial and fungal diseases; however, the environmental conditions and treatment timing have not been thoroughly documented.

V. FUTURE USES OF PARTICLE FILM TECHNOLOGY IN AGRICULTURE

A. Pest Control

The concept of manipulating inert mineral particles to alter plant surfaces for pest control and to improve the physiological properties of the crop has been expanded to address other problems in agriculture. Pesticide concentrations can be reduced by 50% when combined with particle films as a pesticide delivery system that provides the efficacy of a full rate of that pesticide (Puterka et al. 2003b). The delivery system utilizes the combined effects of improved plant coverage, attachment of pesticide coated particles to insects, combined action of quick knock-down with insecticides, and a durable physical barrier to insects.

B. Freeze Prevention

In another application, growth chamber and field studies have established that M96-018 hydrophobic particle films can prevent plant freezing by physically separating dew or frost from the plant surface and thus allowing the plant to supercool and not suffer freeze damage (Glenn et al. 2001). A hydrophobic particle film has effectively prevented ice nucle-

ation and freeze damage (Wisniewski et al. 2002; Fuller et al. 2003) in whole tomato plants. The mechanism of action was the physical separation of water from the plant surface. When water freezes on the surface of a plant, it initiates ice nucleation within the plant by the physical growth of ice crystals into the internal portion of the plant. Growth of an ice crystal from outside the plant occurs through stomates, cracks in the cuticle, wounds, broken epidermal hairs, or other lesions. Blocking the activity of extrinsic nucleators and the subsequent growth of ice crystals into the plant allows the plant to supercool and provides some freeze protection. Further development will be required, but the potential to protect crops from spring frosts has tremendous potential in agriculture.

C. Improved Fruit Finish

Fruit finish has been improved by the application of both hydrophobic and hydrophilic kaolin. Glenn et al. (2001c) reduced russet in 'Golden Delicious' apple with a hydrophobic formulation and Fallahi (2003, unpubl. data) documented significant reduction of 'Fuji' russetting by Surround® in Idaho. In a 3-year study, russet in 'Comice' pear was reduced by both Mancozeb and Surround® WP applications with greater russet reduction when the two were combined. Applications were made at petal fall, 2 and 4 weeks after petal fall (unpublished data, David Sugar, Oregon State University, Medford, Oregon). The mechanism of action has not been identified at this time but suggests an interference with microbial activity on the fruit surface since apple russetting has been linked to epiphytic microbial populations (Matteson Heidenreich et al. 1997).

D. Conclusion

Particle film technology is based on the mineral kaolin, which has a long history of human safety from uses in pottery, paper, paints, and food processing and it is also used as a food additive. In principle, the inert particle film coating a plant creates a hostile environment for insects and a physical barrier to infestation, impeding insect movement, feeding, and egg-laying. The underlying mechanisms of this technology, which we have reviewed in this article, make it unlikely that insects will develop resistance. This particle film also acts as a physical barrier to prevent disease by separating the inoculum from the plant surface. The particle film allows the exchange of gases from the leaf during photosynthesis and transpiration, while its reflective properties reduce heat stress and increase photosynthesis, and fruit size and yield. Sunburn control of

fruits currently relies on shade cloth materials or the extensive use of irrigation water for evaporative cooling of sensitive fruit. 'Surround® Crop protectant' is the first spray-on material to provide effective suppression of high heat damage and sunburn without the use of shade screens or evaporative cooling. In this way, particle film technology reduces the dependence of agriculture on expensive screens or irrigation water sources to mitigate heat stress.

Particle film technology has already displaced a significant percentage of the organophosphate and carbamate insecticides in pear and grape and has the potential to greatly reduce conventional insecticide usage in agriculture as mandated by the Food Quality Protection Act of 1996. In organic agriculture, particle film technology represents the first environmentally friendly, multi-functional material that provides effective insect control, mitigates stress, and produces high-quality organic fruits and vegetables. Its adoption by organic growers will further increase the growth of this expanding industry in the United States and globally. Commercialization of this concept has met with rapid acceptance in the agricultural industry. The broad effectiveness of particle film technology in controlling a large variety of insect pests will result in a global impact on agricultural production and reduced pesticide usage. As research and development on the various aspects of particle film technology continues, the mechanisms of how particle films affect pests and plants will become better understood. Based on the impact that this technology has had in only a few years, particle film technology could have a significant impact on crop production practices in the future, which could lead to reduced pesticide usage and improved yields.

LITERATURE CITED

- Abou-khaled, A., R. M. Hagan, and D. C. Davenport. 1970. Effects of kaolinite as a reflective antitranspirant on leaf temperature, transpiration, photosynthesis, and water use efficiency. *Water Resource Res.* 6:280–289.
- Adegoroye, A. S., and P. A. Jolliffe. 1983. Initiation and control of sunscald injury of tomato fruit. *J. Am. Soc. Hort. Sci.* 108:23–28.
- Adlerz, W. C., and P. H. Everett. 1968. Aluminum foil and white polyethylene mulches to repel aphids and control water melon mosaic. *J. Econ. Entomol.* 61:1276–1279.
- Alexander, P., J. A. Kitchener, and H. V. A. Briscoe. 1944a. Inert dust insecticides. Part I. Mechanism of action. *Ann. Appl. Biol.* 31:143–149.
- Alexander, P., J. A. Kitchener, and H. V. A. Briscoe. 1944b. Inert dust insecticides. Part II. Mechanism of action: The nature of effective dusts. *Ann. Appl. Biol.* 31:150–156.
- Allen, F. 1972. A natural earth that controls insects. *Org. Gardening & Farming* 19:50–56.
- Anandacoomaraswamy, A., W. A. J. M. De Costa, H. W. Shyamalie, and G. S. Campbell. 2000. Factors controlling transpiration of mature field-grown tea and its relationship with yield. *Agr. Forest Meteor.* 103:375–386.

- Armbrust, D. V. 1986. Effect of particulates (dust) on cotton growth, photosynthesis, and respiration. *Agron. J.* 76:1078–1081.
- Arthur, F. H., and G. J. Puterka. 2002. Evaluation of kaolinite-based particle films to control *Tribolium* species (Coleoptera: Tenebrionidae). *J. Stored Prod. Res.* 38:341–348.
- Bardas, M. W., B. L. Blad, and N. J. Rosenberg. 1976a. Reflectant induced modification of soybean canopy radiation balance. IV. Leaf and canopy temperature. *Agron. J.* 68: 843–848.
- Bardas, M. W., B. L. Blad, and N. J. Rosenberg. 1976b. Reflectant induced modification of soybean canopy radiation balance. V. Longwave radiation balance. *Agron. J.* 68:848–852.
- Bar-Joseph, M., and H. Frenkel. 1983. Spraying citrus plants with kaolin suspensions reduces colonization by spiraea aphid (*Aphis citricola* van der Goot). *Crop Protect.* 2:371–374.
- Barthlott, W., and C. Neinhuis. 1997. Purity of the sacred lotus, or escape from contamination in biological surfaces. *Planta* 202:1–8.
- Basnizki, J., and M. Evenari. 1975. The influence of a reflectant on leaf temperature and development of the globe artichoke (*Cynara scolymus* L.). *J. Am. Soc. Hort. Sci.* 100: 109–112.
- Beament, J. W. L. 1945. The cuticular lipoids of insects. *J. Expt. Biol.* 21:115–131.
- Boyce, A. M. 1932. Mortality of *Rhagoletis completa* (Cress.) through the ingestion of certain solid materials. *J. Econ. Entomol.* 25:1053–1059.
- Briscoe, H. V. A. 1943. Some new properties of inorganic dusts. *J. Roy. Soc. of Arts.* 41: 583–607.
- Brown, S. L., J. E. Brown, and M. C. Osborn. 1989. The influence of plastic mulch color on thrips populations in tomato. *Natl. Agr. Plastics Congr. Proc.* 20:198–201.
- Callenbach, J. A. 1940. Influence of road dust upon codling moth control. *J. Econ. Entomol.* 33:803–807.
- Cassida, J. E., and G. B. Quistad. 1998. Golden age of insecticide research: past, present or future? *Annu. Rev. Entomol.* 43:1–16.
- Chiu, S. F. 1939a. Toxicity studies of so-called “inert” materials with the bean weevil, *Acanthoscelidies obtectus* (Say). *J. Econ. Entomol.* 32:240–248.
- Chiu, S. F. 1939b. Toxicity studies of so-called “inert” materials with the Rice weevil and the granary weevil. *J. Econ. Entomol.* 32:810–821.
- Cottrell, T. E., B. W. Wood, and C. C. Reilly. 2002. Particle film affects black pecan aphid (Homoptera: aphidae) on pecan. *J. Econ. Entomol.* 95:782–788.
- Csizinszky, A. A., D. J. Schuster, and J. E. Poolston. 1999. Effect of ultraviolet-reflective mulches on tomato yields and on silverleaf whitefly. *HortScience* 34:911–914.
- David, W. A. L., and B. O. C. Gardiner. 1950. Factors influencing the action of dust insecticides. *Bul. Entomol. Res.* 41:1–61.
- Day, T. A., and P. J. Neale. 2002. Effects of UV-B radiation on terrestrial and aquatic primary producers. *Annu. Rev. Ecol. Syst.* 2002 33:371–396.
- Doraiswamy, P. C., and N. J. Rosenberg. 1974. Reflectant induced modification of soybean canopy radiation balance. I. Preliminary tests with a kaolinite reflectant. *Agron. J.* 66:224–228.
- Drake, S. R., F. E. Larsen, and S. S. Higgins. 1991. Quality and storage of ‘Granny Smith’ and ‘Greenspur’ apples on seedling, M.26, and MM.111 rootstocks. *J. Am. Soc. Hort. Sci.* 116:261–264.
- Driggers, B. F. 1928. Talc and mica dusts as a control for lepidopterous larvae. *J. Econ. Entomol.* 21:938–939.
- Ebling, W. 1961. Physiochemical mechanisms for the removal of insect wax by means of finely divided powders. *J. Agr. Sci.* 30:531–564.

- Ebling, W. 1971. Sorptive dusts for pest control. *Ann. Rev. Entomol.* 16:123–158.
- Ebling, W., and R. E. Wagner. 1959. Rapid desiccation of drywood termites with inert sorptive dusts and other substances. *J. Econ. Entomol.* 52:190–207.
- Ehret, D. L., C. Koch, J. Menzies, P. Sholberg, and T. Garland. 2001. Foliar sprays of clay reduce the severity of powdery mildew on Long English cucumber and wine grapes. *HortScience* 36:934–936.
- Elam, F. L. 1971. Snow job for tomatoes. *Farm J.* (July):24.
- Elkins, R., E. Mitcham, D. Blakely, and B. Biasi. 2001. Use of kaolinic clay to enhance on-tree color retention of Red Sensation Barlett pear fruit. *HortScience* 36:498.
- Farmer, A. M. 1993. The effects of dust on vegetation—A review. *Environ. Pollut.* 79:63–75.
- Flanders, S. E. 1941. Dust as an inhibiting factor in the reproduction of insects. *J. Econ. Entomol.* 34:470–471.
- Follett, P. A., B. A. Croft, and P. H. Westigard. 1985. Regional resistance to insecticides in *Psylla pyricola* from pear orchards in Oregon. *Can. Entomol.* 117:565–573.
- Fronk, W. D. 1971. Insecticide application equipment. p. 219–241. In: R. E. Phadt (ed.), *Fundamentals of applied entomology*. Macmillan, New York.
- Fuller, M. P., F. Hamed, M. Wisniewski, and D. M. Glenn. 2003. Protection of crops from frost using a hydrophobic particle film and an acrylic polymer. *Ann. Appl. Biol.* 143: 93–97.
- Gale, J., and R. M. Hagan. 1966. Plant antitranspirants. *Ann. Rev. Plant Physiol.* 17: 269–282.
- Garcia, M. E., L. P. Berkett, and T. Bradshaw. 2003. Does Surround have non-target impacts on New England orchards? *Proc. New England Fruit Meetings* 108–109:35–39.
- Germar, B. 1936. Versuche zur Bekämpfung des Kornkafers mit Staubmittel. *Z. Angew. Ent.* 22:603–630.
- Ghate, A. V., and G. E. Marshall. 1962. Preliminary studies on the ovicidal effects of wheat flour-buttermilk combination on the eggs of *Panonychus ulmi* (Kock) in southern Indiana. *Indiana Acad. Sci.* 72:140–141.
- Giddings, N. J. 1921. Orchard dusting versus spraying. *J. Econ. Entomol.* 14:225–234.
- Glenn, D. M., M. Wisniewski, G. J. Puterka, and D. Sekutowski. 2001a. Method for enhanced supercooling of plants to provide frost protection. U.S. Patent No. US06235683.
- Glenn, D. M., T. van der Zwet, G. Puterka, P. Gundrum, and E. Brown. 2001b. Efficacy of kaolin-based particle films to control apple diseases. Online. *Plant Health Progress* doi:10.1094/PHP-2001-0823-01-RS. <http://www.plantmanagementnetwork.org>
- Glenn, D. M., G. J. Puterka, S. R. Drake, T. R. Unruh, P. Baherele, E. Prado, and T. Baugher. 2001c. Particle film application influences apple leaf physiology, fruit yield, and fruit quality. *J. Am. Soc. Hort. Sci.* 126:175–181.
- Glenn, D. M., A. Erez, G. J. Puterka, and P. Gundrum. 2003. Particle films affect carbon assimilation and yield in 'Empire' apple. *J. Am. Soc. Hort. Sci.* 128:356–362.
- Glenn, D. M., E. Prado, A. Erez, J. McFerson, and G. J. Puterka. 2002. A reflective, processed-kaolin particle film affects fruit temperature, radiation reflection, and solar injury in apple. *J. Am. Soc. Hort. Sci.* 127:188–193.
- Glenn, D. M., G. J. Puterka, T. Van der Zwet, R. E. Byers, and C. Feldhake. 1999. Hydrophobic particle films: A new paradigm for suppression of arthropod pests and plant diseases. *J. Econ. Entomol.* 92:759–771.
- Greer, L., and J. M. Dole. 2003. Aluminum foil, aluminum-painted plastic, and degradable mulches increase yields and decrease insect vectored viral diseases of vegetables. *Hort-Technology* 13:276–284.
- Gu, S., L. H. Fuchigami, S. H. Guak, and C. Shin. 1996. Effects of short-term water stress, hydrophilic polymer amendment, and antitranspirant on stomatal status, transpiration,

- water loss, and growth in 'Better Boy' tomato plants. *J. Am. Soc. Hort. Sci.* 121: 831–837.
- Guy, H. G. 1936. Thiuram disulfides as repellents to leaf feeding insects. *J. Econ. Entomol.* 29:467.
- Halloway, J. K., C. F. Henderson, and H. V. McBurnie. 1942. Population increases of citrus red mite associated with the use of sprays containing inert granular residues. *J. Econ. Entomol.* 34:348–350.
- Halloway, J. K., and T. R. Young. 1943. The influence of fungicidal sprays on entomogenous fungi and on the purple scale in Florida. *J. Econ. Entomol.* 36:453–457.
- Harben, P. W. 1995. *The industrial minerals handbook II: A guide to markets, specifications, and prices.* Arby Industrial Minerals Division Metal Bulletin, PLC, London.
- Heacox, L. 2001. Particle film: Proving its worth. *Fruit Grower (May)*:26.
- Headly, T. J. 1921. Dusting as a means of controlling injurious insects. *J. Econ. Entomol.* 14:214–220.
- Henicke, A. J. 1937. How lime sulphur spray affects the photosynthesis of an entire ten year old apple tree. *Proc. Am. Soc. Hort. Sci.* 35:256–259.
- Hibino, H., G. H. Kaloostian, and H. Schneider. 1971. Mycoplasma-like bodies in the pear psylla vector of pear decline. *Virology* 43:34–40.
- Hirano, T., M. Kiyota, and I. Aiga. 1995. Physical effects of dust on leaf physiology of cucumber and kidney bean plants. *Environ. Pollution* 89:255–261.
- Hockenyo, G. L. 1933. Effect of dusts on the oriental roach. *J. Econ. Entomol.* 26:792.
- Hoffman, M. B. 1934. Carbon dioxide assimilation by apple leaves as affected by lime-sulphur sprays. II: Field experiments. *Proc. Am. Soc. Hort. Sci.* 30:169–175.
- Horst, R. K., S. O. Kawamoto, and L. L. Porter. 1992. Effect of sodium bicarbonate and oils on the control of powdery mildew and black spot of roses. *Plant Dis.* 76:247–251.
- Horton, D. R. 1990. Oviposition by overwintering morph of pear psylla, (Homoptera: Psyllidae) with information on conditioning. *Environ. Entomol.* 19:357–361.
- Hunt, C. R. 1947. Toxicity of insecticide dust diluents and carriers to larvae of the Mexican bean beetle. *J. Econ. Entomol.* 40:215–219.
- Hurst, H. 1948. Principles of insecticidal action as a guide to drug reactivity-phase distribution relationships. *Trans. Faraday Soc.* 39:390–411.
- Jawson, M. D., and C. T. Bull. 2002. USDA Research into organic farming. *Amer. J. Alter. Agr.* 17:201–202.
- Jifon, J. L., and J. P. Syvertsen. 2003a. Kaolin particle film applications can increase photosynthesis and water use efficiency of 'Ruby Red' grapefruit leaves. *J. Am. Soc. Hort. Sci.* 128:107–112.
- Jifon, J. L., and J. P. Syvertsen. 2003b. Moderate shade can increase net heat exchange and reduce photoinhibition in citrus leaves. *Tree Physiol.* 23:119–127.
- Johnson, G. V., A. Bing, and F. F. Smith. 1967. Reflective surfaces used to repel dispersing aphids and reduce the spread of aphid-borne cucumber mosaic virus in gladiolus plantings. *J. Econ. Entomol.* 60:16–18.
- Jones, A. L., and H. S. Aldwinckle (eds.). 1990. *Compendium of apple and pear diseases.* Am. Phytopath. Soc., St. Paul, MN.
- Kalmus, H. 1944. Action of inert dusts on insects. *Nature* 153:714–715.
- Kennedy, J. S., C. O. Booth, and W. J. S. Kershaw. 1961. Host finding by aphids in the field. III. Visual attraction. *Ann. Appl. Biol.* 49:1–21.
- Khemira, H. P., B. Lombard, D. Sugar, and A. N. Azarenko. 1993. Hedgerow orientation affects canopy exposure, flowering, and fruiting of 'Anjou' pear trees. *HortScience* 28:984–987.

- Kirkpatrick, R. L., and H. B. Gillenwater. 1981. Toxicity of selected insecticidal aerosols, dusts and sprays to two species of stored-product insects. *J. Georgia Entomol. Soc.* 16:175–180.
- Knight, A. L., T. R. Unruh, B. A. Christianson, G. J. Puterka, and D. M. Glenn. 2000. Effects of a kaolin-based particle film on oblique banded leafroller (Lepidoptera: Tortricidae). *J. Econ. Entomol.* 93:744–749.
- Krewer, G., J. D. Dutcher, and C. J. Chang. 2002. Imadicloprid insecticide slows development of Pierce's disease in bunch grapes. *J. Entomol. Sci.* 37:101–112.
- Kring, J. B. 1962. Reaction of aphids to reflected light. *Bul. Entomol. Soc. Am.* 8:159.
- Kring, J. B. 1964. New ways to repel aphids. *Frontiers Sci.* 17:6–7.
- Lapointe, S. L. 2000. Particle film deters oviposition by *Diaprepes abbreviatus* (Coleoptera: Curculionidae). *J. Econ. Entomol.* 93: 1459–1463.
- Lemur, R., and N. J. Rosenberg. 1974. Reflectant induced modification of soybean canopy radiation balance. II. A quantitative and qualitative analysis of radiation reflected from a green soybean canopy. *Agron. J.* 67:301–306.
- Lemur, R., and N. J. Rosenberg. 1975. Reflectant induced modification of soybean canopy radiation balance. III. A comparison of the effectiveness of Celite and kaolinite reflectants. *Agron. J.* 68:30–35.
- Levitt, J. 1980. Responses of plants to environmental stresses, 2nd ed. Vol. 1 & 2. Academic Press, New York.
- Liang, G., and T-X. Liu. 2002. Repellency of a kaolin particle film, Surround, and a mineral oil, sunspray oil, to silverleaf whitefly (Homoptera: Aleyrodidae) on melon in the laboratory. *J. Econ. Entomol.* 317–324.
- Lipton, W. J. 1977. Ultraviolet radiation as a factor in solar injury and vein tract browning of cantaloupes. *J. Am. Soc. Hort. Sci.* 102:32–36.
- Lipton, W. J., and F. Matoba. 1971. Whitewashing to prevent sunburn of 'Crenshaw' melons. *HortScience* 6:343–345.
- Lipton, W. J., and J. J. O'Grady. 1980. Solar injury of "Crenshaw" muskmelons: The influence of ultraviolet radiation and of high tissue temperatures. *Agr. Meteor.* 22: 235–247.
- Lipton, W. J., S. J. Peterson, and C. Y. Wang. 1987. Solar radiation influences solar yellowing, chilling injury, and ACC accumulation in 'Honey Dew' melons. *J. Am. Soc. Hort. Sci.* 112:503–505.
- Little, V. A. 1972. General and applied entomology. 3rd ed. Harper and Row, New York.
- Lowery, D. T., M. K. Sears, and C. S. Harmer. 1990. Control of turnip mosaic virus of rutabaga with applications of oil, whitewash, and insecticides. *J. Econ. Entomol.* 83: 2352–2356.
- Makus, D. J. 2000. Cotton performance as affected by particle film and mycorrhizae treatments. *Proc. Beltwide Cotton Conf.* 1:703–705.
- Makus, D. J., and L. Zibilske. 2001. Cotton plant canopy response to particle film application. *Proc. Cotton Beltwide Conf.* I:557–561.
- Marco, S., O. Ziv, and R. Cohen. 1994. Suppression of powdery mildew in squash by applications of whitewash, clay and antitranspirant materials. *Phytoparasitica* 22:19–29.
- Marcovitch, S. 1925. Non-arsenicals for chewing insects. *J. Econ. Entomol.* 18:122–128.
- Margulies, L., T. Stern, B. Rubin and L. O. Ruzo. 1992. Photostabilization of trifluralin adsorbed on a clay matrix. *J. Agr. & Food Chem.* 40:152–155.
- Matteson Heidenreich, M. C., M. R. Corral-Garcia, E. A. Momol, and T. J. Burr. 1997. Russet of apple fruit caused by *Aureobasidium pullulans* and *Rhodotorula glutinis*. *Plant Dis.* 81:337–342.
- Maxwell, K. E. 1937. The biology and control of the hairy chinch bug, *Blissus hirtus* Montd., infesting turf in Long Island. Ph.D. Thesis, Cornell Univ., Ithaca, NY.

- McAvoy, R. J., and B. B. Bible. 1996. Silica sprays reduce the incidence and severity of bract necrosis in poinsettia. *HortScience* 31:1146–1149.
- McKenzie, C. L., S. L. Lapointe, W. B. Hunter, and G. J. Puterka. 2002. Efficacy of Surround® for control of Asian citrus psyllid on citrus, 2000. *Arthropod Management Tests*. Vol. 27:D8.
- Miller, J. R., and K. L. Strickler. 1984. Finding and accepting host plants. p. 130–157. In: W. J. Bell and R. T. Carde (eds.), *Chemical ecology of insects*. Chapman and Hall, London.
- Mills, W. D. 1937. Leaf growth as affected by spray materials. *Proc. New York State Hort. Soc.* 82:211–214.
- Moericke, V. 1952. Fareben als landereize fur geflugelte Blattlaus (Aphidina). *Z. Naturf.* 7b:304.
- Moericke, V. 1955. Uber die lebensgewohnheiten der geflugeleten Blattlaus unter besonderer berucksichtigung des verhaltens beim landen. *Z. Angew. Ent.* 37:29.
- Moore, W. D., F. F. Smith, G. V. Johnson and D. O. Wolfenbarger. 1965. Reduction of aphid populations and delayed incidence of virus infection on yellow straight neck yellow squash. *Proc. Fla. State Hort. Soc.* 78:187–191.
- Moreshet, S., Y. Cohen, and M. Fuchs. 1979. Effect of increasing foliage reflectance on yield, growth, and physiological behavior of a dryland cotton crop. *Crop Sci.* 19: 863–868.
- Mote, D. C., J. Wilcox, and E. G. Davis. 1926. The natural cleaning up habit of insects. *J. Econ. Entomol.* 19:745–748.
- Mungse, H. B., and D. G. Bhapkar. 1979. Effect of reflectants on yield, water-use efficiency, content of leaf water and albedo of rainfed sunflower. *Indian J. Agr. Sci.* 49: 378–381.
- Nakano, A., and Y. Uehara. 1996. The effects of kaolin clay on cuticle transpiration in tomato. *Acta Hort.* 440:233–238.
- Nawrocka, B. Z., C. J. Eckenrode, J. K. Uyemoto, and D. H. Young. 1975. Reflective mulches and foliar sprays for suppression of aphid-borne viruses in lettuce. *J. Econ. Entomol.* 68:694–698.
- Neinhuis, C., and W. Barthlott. 1997. Characterization and distribution of water-repellent, self-cleaning plant surfaces. *Ann. Bot.* 79:667–677.
- Olivier, C., D. E. Halseh, E. S. G. Mizubuti, and R. Loria. 1998. Postharvest application of organic and inorganic salts for suppression of silver scurf on potato tubers. *Plant Dis.* 82:213–217.
- Orbovic, V., J. L. Jifon, and J. P. Syvertsen. 2001. Foliar-applied surfactants and urea temporarily reduce carbon assimilation of grapefruit leaves. *J. Am. Soc. Hort. Sci.* 126:486–490.
- Ota, A. K., and F. F. Smith. 1968. Aluminum foil-thrips repellent. *Am. Rose Ann.* 54:135–138.
- Parchomchuk, P., and M. Meheriuk. 1996. Orchard cooling with pulsed overtree irrigation to prevent solar injury and improve fruit quality of 'Jonagold' apples. *HortScience* 31:802–804.
- Parrott, P. J. 1921. Control of sucking insects with dust mixtures. *J. Econ. Entomol.* 14:206–214.
- Pearson, R. K., M. L. Odland, and C. J. Noll. 1959. Effect of aluminum mulch on vegetable crop yields. *Pennsylvania State Univ. College Agr. Prog. Report*. 205. Univ. Park.
- Pennman, H. L., and R. K. Schofield. 1951. Some physical aspects of assimilation and transpiration. *Symp. Soc. Expt. Biol.* 5:115–129.
- Peryea, F. J. 1998. Historical use of lead arsenate insecticides, resulting soil contamination and implications for soil remediation. *Proc. 16th World Cong. Soil Sci., Montpellier, France, 20–26 Aug., 1998.*

- Phillips, P. A. 1999. Glassy-winged sharpshooter, a serious new Pierce's disease vector in California vineyards. *Grape Grower Magazine* 31(1): 16, 18, 19, 34. Jan. 1999.
- Pliny. 1971. *Natural history*. Books 17–19. Translated by H. Rackman. Loeb Classical Library. Wm. Heinemann Ltd., London.
- Poprawski, T. J. and G. J. Puterka. 2002a. Particle film applications to collards for whitefly control, 1998. *Arthropod Mgnt. Tests* 27:E58.
- Poprawski, T. J., and G. J. Puterka. 2002b. Particle film applications to bell pepper for whitefly control, 1997. *Arthropod Mgnt. Tests* 27:E29.
- Pree, D. J., D. R. Archibald, K. W. Ker, and K. J. Cole. 1990. Occurrence of pyrethroid resistance in pear psylla (Homoptera: Psyllidae) populations from southern Ontario. *J. Econ. Entomol.* 83:2159–2163.
- Prokopy, R. J., and E. D. Owens. 1978. Visual monitoring trap for European apple sawfly (*Hoplocampa testudinea*), major apple pest in Massachusetts. *J. Econ. Entomol.* 71:576–578.
- Prokopy, R. J., and K. I. Hauschild. 1979. Comparative effectiveness of sticky red spheres and Pherocon AM standard traps for monitoring apple maggot flies in commercial orchards. *Environ. Entomol.* 8:696–700.
- Puterka, G. J., and D. Michael Glenn. 2003. Action of kaolin-based particle films on pear psylla biology and behavior. *J. Econ. Entomol.* (in press).
- Puterka, G. J., D. M. Glenn, and D. G. Sekutowski. 2000a. Method for protecting surfaces from arthropod infestation. U.S. Patent No. 6,027,740.
- Puterka, G. J., D. M. Glenn, D. G. Sekutowski, T. R. Unruh, and S. K. Jones. 2000b. Progress toward liquid formulations of particle films for insect and disease control in pear. *Environ. Entomol.* 29:329–339.
- Puterka, G. J., M. Reinke, D. Luvisi, M. A. Ciomperik, D. Bartels, L. Wendel, and D. M. Glenn. 2003a. Particle film, Surround® WP, effects on glassy-winged sharpshooter behavior and its utility as a barrier to sharpshooter infestations in grape. Online. *Plant Health Progress* doi:10.1094/PHP-2003-0321-01-RS.
- Puterka, G. J., D. M. Glenn, and D. G. Sekutowski. 2003b. Pesticide delivery system. U.S. Patent No. 6,514,512.
- Rabinowitch, H. D., N. Kedar, and P. Budowski. 1974. Induction of sunscald damage in tomatoes under natural and controlled conditions. *Scientia Hort.* 2:265–272.
- Rabinowitch, H. D., B. Ben-David, and M. Friedmann. 1986. Light is essential for sunscald induction in cucumber and pepper fruits, whereas heat conditioning provides protection. *Scientia Hort.* 29:21–29.
- Rao, N. K. Srinivasa. 1985. The effects of antitranspirants on leaf water status, stomatal resistance and yield in tomato. *J. Hort. Sci.* 60:89–92.
- Rao, N. K. Srinivasa. 1986. The effects of antitranspirants on stomatal opening, and the proline and relative water contents in the tomato. *J. Hort. Sci.* 61:369–372.
- Renquist, A. R., H. G. Hughes, and M. K. Rogoyski. 1989. Combined high temperature and ultraviolet radiation injury of red raspberry fruit. *HortScience* 24:597–599.
- Reuveni, M., D. Oppenheim, and R. Reuveni. 1998a. Integrated control of powdery mildew on apple trees by foliar sprays of mono-potassium phosphate fertilizer and sterol inhibiting fungicides. *Crop Protect.* 17:563–568.
- Reuveni, R., G. Dor, and M. Reuveni. 1998b. Local and systemic control of powdery mildew (*Leveillula taurica*) on pepper plants by foliar spray of mono-potassium phosphate. *Crop Protect.* 17:703–709.
- Richardson, C. H., and L. H. Glover. 1932. Some effects of certain "inert" and toxic substances upon the 12-spotted cucumber beetle, *D. Duodecempunctata* (Fab.). *J. Econ. Entomol.* 25:1176–1181.
- Rosenberg, N. J. 1974. *Microclimate: The biological environment*. Wiley, New York.

- Saour, G. 2003. A kaolin-based particle film for suppression of the olive fruit fly, *Bactrocera oleae* Gmelin. J. Applied Entomol. (in press).
- Schrader, L. E., J. Zhang, and W. K. Duplaga. 2001. Two types of sunburn in apple caused by high fruit surface (peel) temperature. Online. Plant Health Progress doi:10.1094/PHP-2001-1004-01-RS.
- Schupp, J. R., E. Fallahi, and I. Chun. 2002a. Effect of particle film on fruit sunburn, maturity and quality of 'Fuji' and 'Honeycrisp' apples. HortTechnology 12:87–90.
- Secoy, D. M., and A. E. Smith. 1983. Lineage of lime sulfur as an insecticide and fungicide. Bul. Entomol. Summer 1983, 18–23.
- Serr, E. F., and J. H. Foott. 1963. Effects of whitewash cover sprays on Persian walnuts in California. Proc. Am. Soc. Hort. Sci. 82:243–249.
- Shafer, G. D. 1915. III. How contact insecticides kill. Michigan Agr. Expt. Sta. Tech. Bul. 21, p. 51–55.
- Showler, A. T. 2002a. Effects of a kaolin-based particle film application on boll weevil (Coleoptera: Curculionidae) injury to cotton. J. Econ. Entomol. 95:754–762.
- Showler, A. T. 2002b. Effects of water deficit stress, shade, weed competition, and kaolin particle film on selected foliar free amino acid accumulations in cotton *Gossypium hirsutum* (L). J. Chem. Ecol. 28:615–635.
- Smith, A. E., and D. M. Secoy. 1975. Forerunners of pesticides in classical Greece and Rome. Agr. Food Chem. 23:1050–1055.
- Smith, A. E., and D. M. Secoy. 1976. A compendium of inorganic substances used in Europe pest control before 1850. J. Agr. Food Chem. 24:1180–1186.
- Smith, F. F., A. L. Boswell, and R. E. Webb. 1972. Repellent mulches for control of gladliolus thrips. Environ. Entomol. 1:672–678.
- Song, J., L. Gan, C. G. Forney, and J. A. Jordan. 2001. Using volatile emissions and chlorophyll fluorescence as indicators of heat injury in apples. J. Am. Soc. Hort. Sci. 126:771–777.
- Sorensen, S. J., and R. J. Gill. 1996. A range extension of *Homalodisca coagulata* (Say) (Hemiptera: Clypeorrhyncha: Cicadellidae) to southern California. Pan-Pac. Entomol. 72:160–161.
- Soundara Rajan, M. S., K. Ramkumar Reddy, R. Sudhakar Rao, and G. H. Sankara Reddi. 1981. Effect of antitranspirants and reflectants on pod yield of rainfed groundnut. Agr. Sci. Dig. 1:205–206.
- Southwick, F. W., and N. F. Childers. 1941. Influence of Bordeaux mixture and its component parts on transpiration and apparent photosynthesis of apple leaves. Plant Physiol. 16:721–754.
- Spotts, R. A., L. A. Cervantes, and F. J. A. Niederholzer. 1997. Effect of dolomitic lime on production of asci and pseudothecia of *Ventruia inaequalis* and *V. pirina*. Plant Dis. 81:96–98.
- Stanhill, G., S. Moreshet, and M. Fuchs. 1976. Effect of increasing foliage and soil reflectivity on the yield and water use efficiency of grain sorghum. Agron. J. 68:329–332.
- Studdert, J. P., H. K. Kaya, and J. M. Duniway. 1990. Effect of water potential, temperature, and clay-coating on survival of *Beauveria bassiana* conidia in a loam and peat soil. J. Invert. Path. 55:417–427.
- Tapp, H., and G. Stotzky. 1995. Insecticidal activity of the toxins from *Bacillus thuringiensis* subspecies *kurstaki* and *tenebrionis* adsorbed and bound on pure and soil clays. Applied Environ. Microbiol. 61:1786–1790.
- Tevini, M. 1999. UV-effects on plants. p. 588–613. In: G. S. Singhal, G. Renger, S. K. Sopory, K-D. Irgang, and Govindjee (eds.), Concepts in photobiology. Photosynthesis and photomorphogenesis. Kluwer Academic Publ., Boston, MA.
- Thompson, J. R., P. W. Mueller, W. Fluckiger, and A. J. Rutter. 1984. The effect of dust on photosynthesis and its significance for roadside plants. Environ. Pollution 34:171–190.

- Unrath, C. R., and R. E. Sneed. 1974. Evaporative cooling of 'Delicious' apples: The economic feasibility of reducing environmental heat stress. *J. Am. Soc. Hort. Sci.* 99: 372–375.
- Unruh, T. R., A. L. Knight, J. Upton, D. M. Glenn, and G. J. Puterka. 2000. Particle films for suppression of codling moth (Lepidoptera: Tortricidae) in apple and pear orchards. *J. Econ. Entomol.* 93:737–743.
- Wagner, R. E., and W. Ebling. 1959. Lethality of inert dust materials to *Kaloterms minor* Hagen and their role as preventatives in structural pest control. *J. Econ. Entomol.* 52:207–212.
- Washington, W. S., O. Villata, and M. Appleby. 1998. Control of pear scab with hydrated lime alone or in schedules with other fungicide sprays. *Crop Protect.* 17:569–580.
- Watkins, T. C., and L. B. Norton. 1947. A classification of insecticide dust diluents and carriers. *J. Econ. Entomol.* 40:211–214.
- Weller, S. C., and D. C. Ferree. 1978. Effect of a pinolene-based antitranspirant on fruit growth, net photosynthesis, transpiration, and shoot growth of 'Golden Delicious' apple trees. *J. Am. Soc. Hort. Sci.* 103:17–19.
- Werblow, S. 1999. Favorable film. *Farmer-Stockman* (April):8–10.
- Wigglesworth, V. B. 1944. Action of inert dusts on insects. *Nature* 153:493–494.
- Wilde, W. H. A. 1962. A note on color preferences of some Homoptera and Thysanoptera in British Columbia. *Can. Entomol.* 94:107–117.
- Wisniewski, M., D. M. Glenn, and M. P. Fuller. 2002. Use of a hydrophobic particle film as a barrier to extrinsic ice nucleation in tomato plants. *J. Am. Soc. Hort. Sci.* 127: 358–364.
- Wood, B., T. Gottwask, and J. Payne. 1984. Influence of single applications of fungicides on net photosynthesis of pecan. *Plant Dis.* 68:427–428.
- Wood, B., and J. Payne. 1984. Influence of single applications of insecticides on net photosynthesis of pecan. *HortScience* 19:265–266.
- Wunsche, J. N., D. H. Greer, S. Lang, and J. W. Palmer. 2000. Visual fruit skin disorder of apple—Sunburn. *HortResearch Client Report* 2000/126.
- Zacker, F., and G. Kunike. 1931. Untersuchungen über die insektizide Wirkung von Oxyden und Karbonaten. *Arb. Aus Biol. Reichsans.* 18:201–231.
- Ziv, O., and T. A. Zitter. 1992. Effects of bicarbonates and film-forming polymers on cucurbit foliar diseases. *Plant Dis.* 76:513–517.

The Foliage Plant Industry*

Jianjun Chen

Mid-Florida Research and Education Center and Environmental Horticulture Department, IFAS, University of Florida, 2725 Binion Road, Apopka, Florida 32703

Dennis B. McConnell

Environmental Horticulture Department, IFAS, University of Florida, P.O. Box 110670, Gainesville, Florida 32611

Richard J. Henny¹ and David J. Norman²

Mid-Florida Research and Education Center, ¹Environmental Horticulture Department and ²Plant Pathology Department, IFAS, University of Florida, 2725 Binion Road, Apopka, Florida 32703

- I. INTRODUCTION
 - A. Foliage Plants and Their Origin
 - B. History of Foliage Plant Production
 - C. Utilization
- II. PRODUCTION CONDITIONS AND ENVIRONMENTS
 - A. Shaded Greenhouse and Shadehouse
 - B. Light
 - C. Temperature
 - D. Air Humidity
 - E. Environmental Control
- III. FOLIAGE PLANT PROPAGATION
 - A. Vegetative Propagation
 - B. Seed or Spore Propagation

*This research was supported by the Florida Agricultural Experiment Station and approved for publication as journal series no. R-09915. The authors thank Kelly Everitt, Terri Mellich, and Edmund Thralls for their critical reading of the manuscript.

Horticultural Reviews, Volume 31, Edited by Jules Janick
 ISBN 0-471-66694-7 © 2005 John Wiley & Sons, Inc.

- IV. FOLIAGE PLANT PRODUCTION
 - A. Containers and Container Substrates
 - B. Water and Irrigation
 - C. Nutrient Management
 - D. Environmental Concerns over Water and Nutrient Management
 - E. Growth Regulator Application
 - F. Pest Management
 - G. Acclimatization
- V. POSTPRODUCTION
 - A. Grading, Packaging, and Shipping
 - B. Interiorscapes
- VI. THE FUTURE
- LITERATURE CITED

I. INTRODUCTION

A. Foliage Plants and Their Origin

Foliage plants, defined literally, would include all plants grown for their attractive leaves rather than for flowers or fruits. In general horticultural terms, however, foliage plants are those with attractive foliage and/or flowers that are able to survive and grow indoors (Chen et al. 2002b). Thus, they are used as living specimens for interior decoration or interior plantscaping. Foliage plants, in common terminology, are called houseplants. However, in the tropics they may also be grown under shade as landscape plants.

Most foliage plants are indigenous to tropical and subtropical regions. Warm temperatures and abundant water in the tropics nurture wildly diverse vegetation. Most foliage plants grow as understory plants shaded by a canopy of giant trees. As a result, foliage plants native to this environment are tolerant to low light, sensitive to chilling temperatures, and day-neutral to photoperiod (Henny and Chen 2003). In subtropical climates, both temperatures and humidity may vary with the seasons; foliage plants originating in this climate tolerate limited degrees of heat, drought, and chilling temperatures and may also show dormancy in winter. However, some plants used indoors are native to climatically extreme conditions such as deserts and have evolved mechanisms to adapt to heat and drought stresses. These plants, predominately succulents and cacti, often have unique foliage or shapes. Only a few foliage plants are native to temperate zones. The most common temperate foliage plant species are a tree, Japanese Aralia (*Fatsia japonica*), and a vine, English ivy (*Hedera helix*); both have been widely used for interiorscaping.

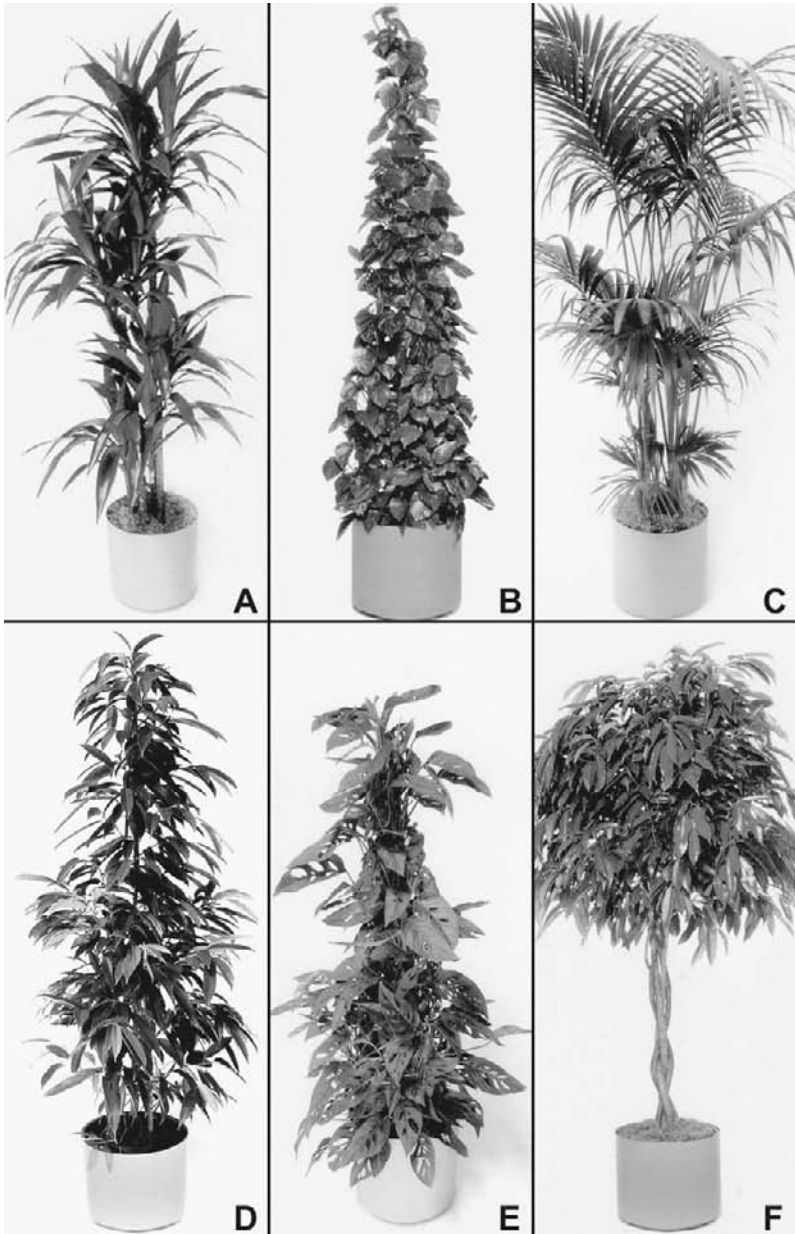

Fig. 2.1. Examples of upright foliage plants: (A) *Dracaena*, (B) pothos vine on a totem pole, (C) Kentia palm, (D) Amstel King fig, (E) Swiss cheese vine on totem pole, and (F) braided *Ficus*.

Plants from more than 100 genera and probably 1,000 species with different forms, colors, textures, and styles have been produced as foliage plants (Fig. 2.1 and 2.2). Their origination can be categorized according to the following six geographical regions (Bailey and Bailey 1976; Huxley 1994; Manaker 1997; Chen et al. 2003c).

Asia: *Aeschynathus*, *Aglaonema*, *Aglaomorpha*, *Alocasia*, *Alpinia*, *Ardisia*, *Aspidistra*, *Asplenium*, *Aucuba*, *Begonia*, *Blechnum*, *Buddleia*, *Ceropegia*, *Chlorophytum*, *Cibotium*, *Codiaeum*, *Coleus*, *Cordyline*, *Curcuma*, *Cyanotis*, *Cyrtomium*, *Davallia*, *Epipremnum*, *Elettaria*, *Fatsia*, *Ficus*, *Gardenia*, *Globba*, *Gynura*, *Haemaria*, *Hedychium*, *Hemigraphis*, *Homalomena*, *Hoya*, *Kaempferia*, *Leea*, *Liriope*, *Musa*, *Pandanus*, *Pellionia*, *Perilepta*, *Phalaenopsis*, *Phoenix*, *Pittosporum*, *Plectranthus*, *Podocarpus*, *Polyscias*, *Pteris*, *Radermachera*, *Rhapis*, *Sansevieria*, *Saxifraga*, *Schefflera*, *Scindapsus*, *Sedum*, *Senecio*, *Spathiphyllum*, *Sonerila*, and *Veitchia*.

Australia and Oceania: *Araucaria*, *Asplenium*, *Blechnum*, *Cissus*, *Cordyline*, *Dizygotheca*, *Howea*, *Platynerium*, *Polyscias*, *Schefflera*, and *Senecio*.

South and Central America: *Adiantum*, *Aechmea*, *Anthurium*, *Ananas*, *Aphelandra*, *Blechnum*, *Billbergia*, *Buddleia*, *Caladium*, *Calathea*, *Callisia*, *Cereus*, *Chamaedorea*, *Cibotium*, *Coccoloba*, *Columnnea*, *Cryptanthus*, *Dieffenbachia*, *Dyakia*, *Episcia*, *Fittonia*, *Eucharis*, *Geogenanthus*, *Guzmania*, *Heliconia*, *Maranta*, *Mikania*, *Monstera*, *Neoregelia*, *Nephrolepis*, *Nidularium*, *Nolina*, *Peperomia*, *Philodendron*, *Pilea*, *Polypodium*, *Ruellia*, *Sanchezia*, *Saxifraga*, *Schlumbergera*, *Sedum*, *Senecio*, *Siderasis*, *Spathiphyllum*, *Stromanthe*, *Syngonium*, *Tillandsia*, *Tradescantia*, *Vriesea*, *Yucca*, and *Zebrina*.

Tropical Africa: *Aloe*, *Asparagus*, *Buddleia*, *Ceropegia*, *Chlorophytum*, *Chrysalidocarpus*, *Coffea*, *Crassula*, *Cyanotis*, *Dracaena*, *Haworthia*, *Hypoestes*, *Kalanchoe*, *Leea*, *Pandanus*, *Saintpaulia*, *Sansevieria*, *Senecio*, *Strelitzia*, and *Zamioculcas*.

North America: *Agave*, *Buddleia*, *Coccoloba*, *Mikania*, *Pellaea*, *Peperomia*, *Polypodium*, *Polystichum*, *Saxifraga*, *Sedum*, *Senecio*, *Tolmiea*, *Yucca*, and some genera of the Bromeliaceae and Cactaceae.

Europe: *Chamaerops*, *Hedera*, *Nerium*, *Saxifraga*, *Sedum*, *Senecio*, and *Solierolia*.

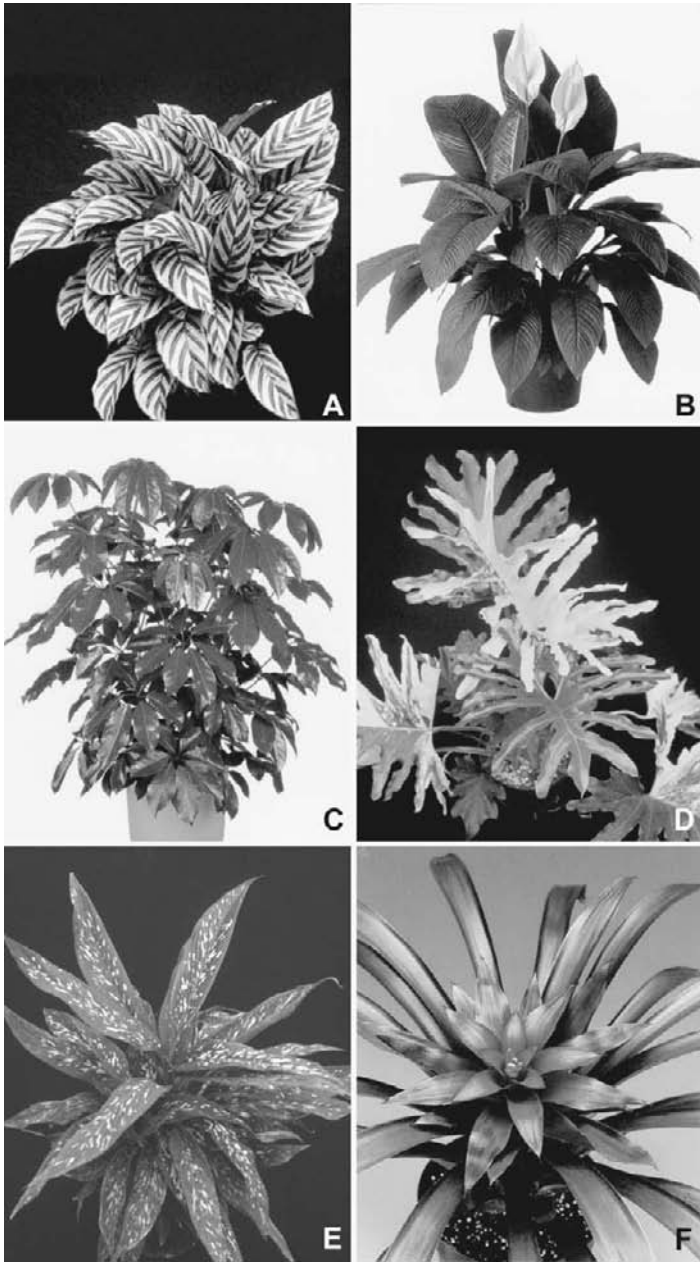

Fig. 2.2. Examples of typical potted foliage plants: (A) *Calathea*, (B) *Spathiphyllum*, (C) *Schefflera*, (D) *Philodendron*, (E) *Dieffenbachia*, and (F) *Guzmania*.

Designating origins of foliage plant genera in Asia and Australia-Oceania is not always precise because some regions, such as Indonesia and Australia, are rather close geographically. *Senecio* is distributed in all six regions. Other genera are indigenous to several regions, such as: *Asplenium* [Asia, Africa, and Australia (Bailey and Bailey 1976; Huxley 1994)], and *Spathiphyllum* [South and Central America and Southeast Asia (Philippines) (Nicolson 1968)].

B. History of Foliage Plant Production

Collections from the tropical and subtropical regions and subsequent domestication have led to the current diverse array of ornamental foliage plant species. The Sumerians and ancient Egyptians started growing small trees in containers about 4,000 years ago (Smith and Scarborough 1981). Writings on ornamental cultivation are found in ancient Chinese classics such as *The Book of Songs* 2,500 and 3,000 years ago (Chen and Tang 1982). Archeological records show that container gardening of ornamentals was commonly practiced by the Greeks and Romans during their classical period. Plants were imported from the far reaches of their empires and frequently grown in very decorative containers. During the Middle Ages in Europe, container gardening of ornamentals was confined primarily to monasteries.

The Renaissance stimulated a renewed interest in plants, and plant collectors in Holland and Belgium imported plants from Asia Minor and the East Indies, while wealthy merchants of Florence, Genoa, and Venice introduced plants from the East into Europe in the late 15th century. A desire for exotic plants developed among the aristocracy of France and England by the middle of the 16th century, and orangeries and conservatories became commonplace on the estates of the nobility and the wealthy class by the 17th century. Sir Hugh Platt, in the *Garden of Eden*, which was printed in 1660, referred to the possibilities of growing plants in homes (Free 1979). By the following century, an estimated 5,000 species of exotic plants had been brought into Europe (Smith and Scarborough 1981).

In the early 19th century, books began to appear on the cultivation of houseplants in England and France. In 1824, *The Greenhouse Companion—also the Proper Treatment of Flowers in Rooms*, by John Claudium Loudon, was published. Eighteen years later, Nathaniel Ward brought out his book *On the Growth of Plants in Closely Glazed Cases*—the beginning of terrarium culture (Free 1979). The protected environ-

ment of the Wardian case allowed plant collectors to bring living specimens of tropical plants from around the world back to Europe. The availability of diverse and exotic plants that could tolerate the environment typical of Victorian homes promoted the use of living plants indoors and gave birth to the modern foliage plant industry. During the second half of the 19th century, foliage plants became a symbol of social status, and the grand drawing rooms of Victorian houses all had their fill of palms and ferns (Lowe 1861). In the late 1800s, foliage plants from conservatories, botanical gardens, and private estates were brought into commercial production, and these plants were sold for use in middle- and upper-class households (Smith and Scarborough 1981). At the same time, shiploads of foliage plants from Europe were sold to greenhouse growers in the Northeast United States for either immediate resale or for “growing on” and subsequent resale.

In less than two decades, large-scale production of foliage plants moved to California and Florida because of favorable climatic conditions. Predominant plants grown in California during the 1920s include Kentia palm (*Howea forsterana*) and pothos (*Epipremnum aureum*), followed by *Philodendron* and *Araucaria* in the 1940s. Production in Central Florida was confined to Boston fern (*Nephrolepis exaltata*) from 1912 to 1928 until heart-leaf philodendron (*Philodendron scandens oxycardium*) was introduced. The primary foliage plants grown in South Florida during the same time period were snake plant (*Sansevieria trifasciata*) and screw pine (*Pandanus veitchii*). During the 1930s, Chinese evergreen (*Aglaonema modestum*), rubber plant (*Ficus elastica*), and oval-leaf peperomia (*Peperomia obtusifolia*) became widely grown in Florida (Smith and Scarborough 1981). Florida produced about \$2 million of the national foliage plant wholesale value of \$13 million in 1949. However, 10 years later, Florida supplanted California as the leading state in the nation in production of foliage plants and has accounted for more than 55% of the national wholesale value since the 1960s.

C. Utilization

Foliage plants are valued for their foliar variegation in different combinations of colors, patterns, and textures, and their plant forms, as well as flower shape and colors. Table 2.1 presents ornamental values of 120 foliage plant genera. Because of their tolerance to low light, foliage plants have been widely used for decorating building interiors to bring

Table 2.1. Important foliage plants and their ornamental value.

Family	Genus	Common name	Ornamental value
Acanthaceae	<i>Aphelandra</i>	Zebra Plant	Silver-veined foliage, yellow flowers
	<i>Fittonia</i>	Net Leaf	Pink or white-veined foliage
	<i>Hemigraphis</i>	Waffle Plant	Reddish variegated foliage
	<i>Hypoestes</i>	Polka Dot Plant	Pink spotted foliage
	<i>Ruellia</i>	Monkey Plant	Flower and/or foliage
	<i>Sanchezia</i>	Sanchezia	Prominently-veined foliage, yellow flowers
Agavaceae	<i>Agave</i>	Agave	Variegated or green foliage
	<i>Cordyline</i>	Ti Plant	Purple or fuchsia foliage
	<i>Dracaena</i>	Dracaena	Variegated or solid green foliage
	<i>Nolina</i>	Pony Tail	Swollen base, plume of long strap leaves
	<i>Sansevieria</i>	Snake Plant	Sturdy, variegated foliage
	<i>Yucca</i>	Yucca	Tall, spiky foliage
Amaryllidaceae	<i>Eucharis</i>	Amazon Lily	Snow white flowers and dark green foliage
Araceae	<i>Aglaonema</i>	Chinese Evergreen	Variegated foliage
	<i>Alocasia</i>	Kris Plant	Variegated or green, large or small foliage
	<i>Anthurium</i>	Flamingo Flower	Pink, purple, white, or red flowers
	<i>Dieffenbachia</i>	Dumb Cane	Variegated foliage
	<i>Epipremnum</i>	Pothos	Vine, variegated or green foliage
	<i>Homalomena</i>	Homalomena	Variegated foliage
	<i>Monstera</i>	Swiss Cheese Plant	Perforated and deep cut foliage
	<i>Philodendron</i>	Philodendron	Vine, self-heading, various shaped foliage
	<i>Spathiphyllum</i>	Peace Lily	White flowers, dark green foliage
	<i>Syngonium</i>	Arrowhead Vine	Variegated, or varied colored foliage
	<i>Zamioculcas</i>	ZZ Plant	Green foliage with palm look appearance

Araliaceae	<i>Dizygotheca</i>	False Aralia	Finger-like serrated leaflets
	<i>Fatsia</i>	Fatsia	Green leaves with five to nine deep lobes
	<i>Hedera</i>	English Ivy	Vine, green or variegated foliage
	<i>Polyscias</i>	Aralia	Twisted stems and attractive foliage
	<i>Schefflera</i>	Umbrella Tree	Green or variegated, palmate foliage
Araucariaceae	<i>Araucaria</i>	Norfolk Island Pine	Stiff branches covered with prickly needles
Asclepiadaceae	<i>Ceropegia</i>	Rosary Vine	Silver blotched leaves on wiry stem
	<i>Hoya</i>	Wax Plant	Foliage and colored flowers
Begoniaceae	<i>Begonia</i>	Foliage Begonia	Variegated foliage in multiple colors
Bignoniaceae	<i>Radermachera</i>	China Doll	Dark green or variegated compound leaves
Bromeliaceae	<i>Aechmea</i>	Silver Vase	Variegated foliage and colored flowers
	<i>Ananas</i>	Pineapple	Variegated leaves with colored flowers
	<i>Billbergia</i>	Queen's Tears	Grass-like leaves, drooping flower bracts
	<i>Cryptanthus</i>	Earth Star	Variegated, wavy-edged leaves
	<i>Dyckia</i>	Dyckias	Clustered rosettes of tough, succulent leaves
	<i>Guzmania</i>	Guzmania	Showy flower heads and colored foliage
	<i>Neoregelia</i>	Blushing Bromeliad	Blushes at center, tricolors, or red at leaf tip
	<i>Nidularium</i>	Bird's Nest Bromeliad	Blushed center or purpled underside leaves
	<i>Tillandsia</i>	Blue-flowered torch	Grassy leaves with compact flower heads
Cactaceae	<i>Vriesea</i>	Flaming Sword	Yellow, red, and orange flower heads
	<i>Cereus</i>	Column Cactus	Columnar stem, flowers
	<i>Opuntia</i>	Opuntia	Flattened or round stems
	<i>Schlumbergera</i>	Christmas Cactus	Branching and arching stems, flowers
	Commelinaceae	<i>Callisia</i>	Striped Inch Plant
<i>Cyanotis</i>		Teddy Bear Vine	Hairy foliage
<i>Geogenanthus</i>		Seersucker Plant	Dark green foliage with silvery stripes
<i>Siderasis</i>		Brown Spiderwort	Brown hairy foliage and purple flowers
<i>Tradescantia</i>		Spiderwort	Variegated foliage
<i>Zebrina</i>		Wandering Jew	Multicolored foliage

Table 2.1. (continued)

Family	Genus	Common name	Ornamental value
Compositae	<i>Gynura</i>	Purple Passion	Trailing plant with purpled pubescence
	<i>Mikania</i>	Plush Vine	Palmate green leaves with a purplish sheen
	<i>Senecio</i>	String of Beads	Pendant stems bearing bead-like leaves
Cornaceae	<i>Aucuba</i>	Spotted Laurel	Yellowish spots on foliage
Crassulaceae	<i>Crassula</i>	Crassula	Various leaf types and growth forms
	<i>Kalanchoe</i>	Kalanchoe	Leaves and flowers
	<i>Sedum</i>	Sedum	Boat-shaped or cylindrical leaves
Euphorbiaceae	<i>Codiaeum</i>	Croton	Variiegated foliage
Gesneriaceae	<i>Aeschynanthus</i>	Lipstick Plant	Trailing stems, leathery leaves, red flowers
	<i>Columnnea</i>	Goldfish Plant	Tubular flowers, reddish haired foliage
	<i>Episcia</i>	Carpet Plant	Variiegated foliage, colored flowers
	<i>Saintpaulia</i>	African Violet	Various colored flowers
Heliconiaceae	<i>Heliconia</i>	Lobster Claw	Large leaves, colorful flowers
Leeaceae	<i>Leea</i>	Leea	A shrubby plant with reddish foliage
Liliaceae	<i>Aloe</i>	Aloes	Compact rosette formed by succulent leaves
	<i>Asparagus</i>	Asparagus Fern	Graceful feathery foliage
	<i>Aspidistra</i>	Cast Iron Plant	Green or variegated foliage
	<i>Chlorophytum</i>	Spider Plant	Draping, green or variegated foliage
	<i>Haworthia</i>	Zebra Haworthia	Succulent white-banded green leaves
	<i>Buddleia</i>	Indoor Oak	Dark green, oak-like leaves
Loganiaceae	<i>Calathea</i>	Calathea	Multi-colored foliage
Marantaceae	<i>Ctenanthe</i>	Never-never Plant	Variiegated foliage
	<i>Maranta</i>	Prayer Plant	Variiegated foliage with red or white veins
	<i>Stromanthe</i>	Stromanthe	Variiegated foliage
Melastomataceae	<i>Bertolonia</i>	Jewel Plant	Furry foliage either green or variegated
	<i>Sonerila</i>	Frosted Sonerila	Foliage lined and spotted with silver color
Moraceae	<i>Ficus</i>	Fig	Green or variegated foliage trees

Musaceae	<i>Musa</i>	Banana Plant	Large leaves and yellow flowers
Myrsinaceae	<i>Ardisia</i>	Coral Berry	A tree with fragrant flowers, red berries
Orchidaceae	<i>Haemaria</i>	Gold-lance Orchid	Variegated leaves
Palmae	<i>Chamaedorea</i>	Neanthe Bella	Small feathery palm
	<i>Chrysalidocarpus</i>	Areca Palm	Gracefully arching fronds
	<i>Howea</i>	Kentia	Large indoor palm
	<i>Phoenix</i>	Canary Date Palm	Stiff straight or arching leaflets
	<i>Ravenea</i>	Majesty Palm	A crown of arching, bright green fronds
	<i>Rhapis</i>	Lady Palm	Mid-sized palmate palm
Pandanaceae	<i>Pandanus</i>	Screw Pine	Leaves arranged spirally around the stem
Piperaceae	<i>Peperomia</i>	Peperomia	Succulent vine
Pittosporaceae	<i>Pittosporum</i>	Pittosporum	Glossy-leafed tree
Polygonaceae	<i>Coccoloba</i>	Sea Grape	Large, leathery foliage
Polypodiaceae	<i>Adiantum</i>	Maiden Hair Fern	Tiny, delicate foliage
	<i>Aglaomorpha</i>	Bear's Paw Fern	Fronds with both broad and narrow leaflets
	<i>Asplenium</i>	Bird's Nest Fern	Wide or feathery foliage
	<i>Blechnum</i>	Hard Fern	Large palm-like crown of stiff fronds
	<i>Cibotium</i>	Mexican Tree Fern	Pale green lacy fronds
	<i>Cyrtomium</i>	Holly Fern	Holly-shaped leaflets, glossy dark green
	<i>Davallia</i>	Rabbit-foot Fern	Thick hairy rhizomes outside of container
	<i>Nephrolepis</i>	Boston fern	Large or compact with wavy leaflets
	<i>Pellaea</i>	Button Fern	Round, leathery leaflets
	<i>Phyllitis</i>	Hart's Tongue Fern	Strap-shaped fronds
	<i>Platynerium</i>	Staghorn Fern	Large fronds divided into antler-like lobes
	<i>Polypodium</i>	Hare's Foot Fern	Deeply cut leaves on thin stalks
	<i>Polystichum</i>	Prickly Shield Fern	Upright pointed fronds
	<i>Pteris</i>	Table Fern	Spacey fronds
Rubiaceae	<i>Coffea</i>	Coffee	Wide, wavy, and shiny foliage

Table 2.1. (continued)

Family	Genus	Common name	Ornamental value
Saxifragaceae	<i>Saxifraga</i>	Mother of Thousand	Runners bear plantlets, silver veined foliage
	<i>Tolmiea</i>	Piggyback Plant	Plantlets born on leaves
Strelitziaceae	<i>Strelitzia</i>	Bird-Of-Paradise	Green leaves with multi-colored flowers
Urticaceae	<i>Pellionia</i>	Pellionia	Foliage with either pale center or dark veins
	<i>Pilea</i>	Aluminum Plant	Silver-patched, quilted surface leaves
	<i>Soleirolia</i>	Baby's Tears	Round leaves on pinkish stems
Vitaceae	<i>Cissus</i>	Grape Ivy	Vine, green or variegated leaves
Zingiberaceae	<i>Alpinia</i>	Shell Ginger	Inflorescence with white and pink bracts
	<i>Curcuma</i>	Curcuma Ginger	Colorful, long-lasting flowers
	<i>Globba</i>	Globba Ginger	Colorful flowers or variegated foliage
	<i>Hedychium</i>	Butterfly Ginger	Large white butterfly shaped flowers
	<i>Kaempferia</i>	Peacock Ginger	Variegated foliage

beauty and comfort to our surroundings and remind us of nature (Fig. 2.3). Thus, foliage plants fulfil a psychological need, enhance our interior environment, and are also a satisfying hobby (Lohr et al. 1996; Lohr



Fig. 2.3. Foliage plants used for interior decoration: (A) Norfolk Island pine and (B) False Aralia in homes; (C) bamboo palm in an office; (D) a mixture of different foliage plants including *Dracaena*, palm, *Schefflera*, and *Spathiphyllum*, and (E) *Philodendron*, *Dracaena*, and *Ficus* in a shopping mall, and (F) pothos on office desks.

and Pearson-Mims 1996; Manaker 1997). In addition, plants in building interiors reduce dust, act as natural humidifiers, and purify indoor air. A NASA-funded project concluded that foliage plants can remove nearly 87% of air pollutants from sealed chambers within 24 hr. For example, each Peace lily (*Spathiphyllum* 'Mauna Loa') plant removed 16, 27, and 41 mg formaldehyde, trichloroethylene, and benzene, respectively, from sealed chambers after a 24-hr exposure to the respective chemical (Wolverton et al. 1984, 1989). Later, Giese et al. (1994) exposed shoots of *Chlorophytum comosum* to 8.5 mg m⁻³ gaseous [¹⁴C]-formaldehyde over 24 hr and found that about 88% of the recovered radioactivity was plant associated and had been incorporated into organic acids, amino acids, free sugars, and lipids as well as cell wall components.

The esthetic and psychological enhancement of interior environments and purification of indoor air have become catalysts in promoting foliage plant production and increasing their wholesale value. Fig. 2.4 presents the wholesale value of foliage plants from 1949 to 2002. The national wholesale value of foliage plants in 2002 was \$663 million, with Florida accounting for \$460 million (USDA 2003). The steady increase in wholesale value may also be attributed to technological advances in production and increased introduction of new plants and new cultivars. Chen

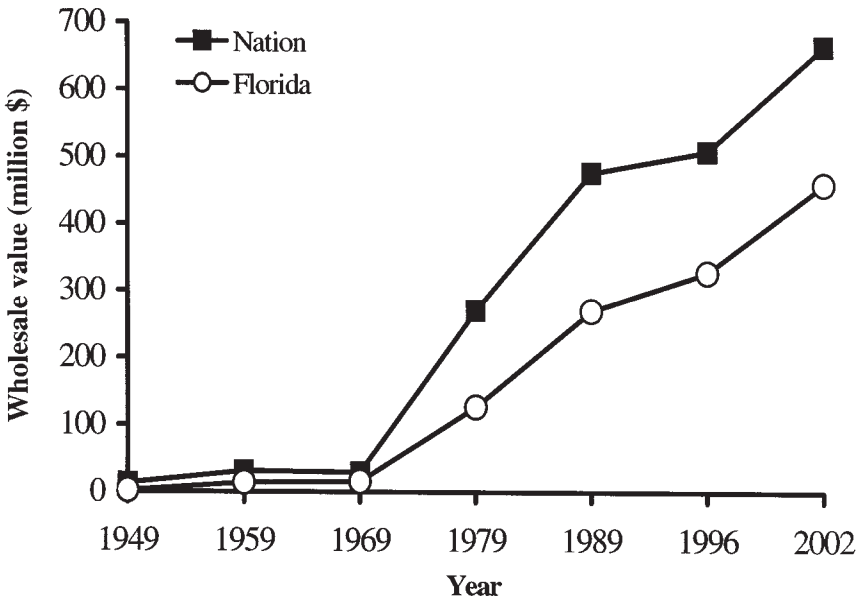

Fig. 2.4. The wholesale value of foliage plants in the nation and Florida at selected years.

et al. (2002b) and Henny and Chen (2003) have reviewed new plant introductions and cultivar development. This chapter reviews current developments in production and interior use of foliage plants.

II. PRODUCTION CONDITIONS AND ENVIRONMENTS

A rule of commercial foliage plant production is to provide plants with environmental conditions that are similar to those found in their natural environments. Since most foliage plants are indigenous to tropical rainforest floors, shade, high relative humidity, and warm temperatures typify most foliage plant production environments.

A. Shaded Greenhouse and Shadehouse

Greenhouses are structures covered with a transparent material for the purpose of admitting natural light for plant growth (Nelson 2003). They are built in many styles, including even-span or A-frame, uneven-span and sawtooth, Quonset, gutter-connect, and retractable roof, and usually equipped with heating and cooling systems (Waters and Conover 1981; Hanan 1998). The transparent covers include glass, film plastics, fiberglass-reinforced plastics, acrylic panels, and polycarbonate panels (Aldrich and Bartok 1994; Hanan 1998; Dole and Wilkins 1999; Nelson 2003).

Greenhouses may be shaded to reduce light intensities (Fig. 2.5A). There are two common ways for light intensity reduction: (1) spraying a shading compound on the greenhouse roof and walls and (2) installing a screen fabric over the greenhouse or inside the greenhouse above head height. The spray method is inexpensive because shading compounds such as white latex paint can be mixed with water at appropriate dilutions to produce desired shade levels. Long-lasting synthetic fabrics are made from polypropylene, polyester, or saran in different densities of weave so that shade values from 20 to 90% can be achieved (Nelson 2003).

Shadehouses are open structures supported with treated hardwood, steel, galvanized pipe, or galvanized weldmesh as posts (Fig. 2.5B). The roof is supported by galvanized cable or heavy galvanized wire mounted to the posts from 2 to 3.6 m above the ground. The covering usually consists of polypropylene or saran shade cloth fastened to stringers by metal S hooks or nylon cord (Waters and Conover 1981). Shadehouses are generally used in warm climates and are built without heating or cooling systems. They may be covered with perforated polyethylene for winter



Fig. 2.5. Foliage plant production facilities: (A) *Dieffenbachia* grown on bench and pothos in hanging baskets in a shaded greenhouse and (B) *Anthurium* grown in a shadehouse.

protection and space heaters may be used during temporary cold periods. Shadehouses are relatively inexpensive and easy to construct.

Containerized foliage plants are produced in either ground beds or on raised benches of shaded greenhouses or shadehouses. Raised benches are most frequently used and may be stationary or movable. Growing containerized foliage plants on raised benches increases air circulation and reduces disease incidence. A large percentage of foliage plants are produced as hanging basket crops in the open space above the benches. Detachable saucers are used with baskets to minimize drip from irrigation water.

B. Light

Plants sense the quantity, quality, direction, duration (photoperiod), and polarization (via different photoreceptor arrangements) of light in regulating their growth and development (Smith 1994). Light quantity or intensity is the most important factor influencing foliage plant production, and its effects on plant growth have been studied more extensively than other properties of light.

1. Light Intensity. The photosynthetic reaction is driven by light in the spectral region between 400 and 700 nm, thus, irradiance impinging on leaves in this wavelength range is referred to as photosynthetically active radiation (PAR). When PAR is expressed on a quantum basis, it is given the special term *photosynthetic photon flux density* (PPFD), with units expressed as $\mu\text{mol m}^{-2} \text{s}^{-1}$. Light intensities reported in literature, however, have been expressed in foot candles (fc), lux, $\mu\text{E m}^{-2} \text{s}^{-1}$ (or $\mu\text{mol m}^{-2} \text{s}^{-1}$), and percent shade. The first three units may be interconverted using the following formula: $(1.0 \text{ fc} = 10.8 \text{ lux} = 0.13 \mu\text{mol m}^{-2} \text{s}^{-1})$ if the light source is the sun. If artificial light sources are involved, correction factors may be required (Thimijan and Heins 1983). Expression of light units as percent of shade, without accompanying quantification, is difficult to interpret due to effects of geographic location and season on actual light intensity. Commercial foliage plant production recommendations were frequently expressed as foot candles and/or percent shade. In this review, light intensity is stated as PPFD ($\mu\text{mol m}^{-2} \text{s}^{-1}$); original results presented using units other than PPFD are converted.

Foliage plants differ in three aspects from other crops in response to light intensity: low light-saturation points, low light-compensation

points, and a pronounced capability of responding to acclimatization. Foliage plants do not need maximum irradiance; rather, they require a reduced irradiance for optimum quality. The irradiance at which photosynthesis starts to level off and reaches saturation is called the light saturation point. Light saturation points for *Cissus rhombifolia*, *Fatsia japonica*, and *Philodendron scandens* were 154, 175, and 118 $\mu\text{mol m}^{-2} \text{s}^{-1}$, respectively, when initially grown under a light intensity of 470 $\mu\text{mol m}^{-2} \text{s}^{-1}$ (Araus et al. 1986). The light saturation point of *Aglaonema commutatum* was 125 $\mu\text{mol m}^{-2} \text{s}^{-1}$ if initially grown under a light intensity of 20 $\mu\text{mol m}^{-2} \text{s}^{-1}$ (Di Benedetto and Cogliatti 1990). Fails et al. (1982) reported that light saturation points for *Ficus benjamina* was 200 $\mu\text{mol m}^{-2} \text{s}^{-1}$ when grown under 75% shade (approximate PPF of 450) but 350 $\mu\text{mol m}^{-2} \text{s}^{-1}$ when initially grown under full sun (approximate PPF of 1,400). Many factors such as initial light levels during plant growth, fertilization rates, and CO_2 concentrations may affect light saturation points. In general, light saturation points of most foliage plants range from 100 to 400 $\mu\text{mol m}^{-2} \text{s}^{-1}$, while light saturation points of full sun plants usually exceed 1,000 $\mu\text{mol m}^{-2} \text{s}^{-1}$. Exposure of plants to strong light can cause reduction of photosynthesis, a phenomenon referred to as photoinhibition (Demming-Admas and Adams 1992). This is because reactive oxygen species (ROS) produced upon illumination oxidize molecules in chloroplasts to partially inhibit reaction of photosynthesis, eventually leading to photoinhibition (Asada 1999). Conover and Poole (1982) reported that quality of *Spathiphyllum* 'Mauna Loa' grown under a light intensity of 700 $\mu\text{mol m}^{-2} \text{s}^{-1}$ was less than that grown under 400 $\mu\text{mol m}^{-2} \text{s}^{-1}$. Foliage plants grown under a light intensity higher than required generally have pale-colored foliage and reduced growth rates, which can be misidentified as nitrogen deficiency. Table 2.2 lists the appropriate range of PPF for the production of 57 genera. Although different species or cultivars may vary in irradiance requirements; generally the lower irradiance levels indicated in Table 2.2 produce quality plants that are better suited to interiorscapes. Comparing flower numbers of nine cultivars of *Anthurium* grown under 230 $\mu\text{mol m}^{-2} \text{s}^{-1}$ with those grown under 102 $\mu\text{mol m}^{-2} \text{s}^{-1}$, it is found that plants grown under the lower irradiance had darker green foliage but fewer flowers than those grown under the higher irradiance. Plants produced under the lower light intensity, however, performed better under interior conditions (J. Chen, unpubl. data).

Foliage plants possess low light-compensation points. The irradiance at which CO_2 uptake exactly balances CO_2 release is called the light-compensation point. Light-compensation points of *Cissus rhombifolia*, *Fatsia japonica*, and *Philodendron scandens* were 15, 14, and 5 μmol

Table 2.2. Appropriate light intensity range for producing and interiorscaping foliage plants and temperature for foliage plant production and transportation.^z

Family	Genus	Light intensity ($\mu\text{mol m}^{-2} \text{s}^{-1}$)		Temperature ($^{\circ}\text{C}$)	
		Production	Interiorscape ^y	Production	Transportation ^x
Acanthaceae	<i>Aphelandra</i>	180–280	25–50	18–28	13–16
	<i>Fittonia</i>	200–450	15–30	20–28	16–18
	<i>Hemigraphis</i>	300–500	25–50	18–28	16–18
	<i>Hypoestes</i>	200–500	20–50	18–28	16–18
Agavaceae	<i>Cordyline</i>	500–800	15–25	18–30	16–18
	<i>Dracaena</i>	300–800	10–25	20–28	16–18
	<i>Sansevieria</i>	200–800	8–16	18–28	10–13
	<i>Yucca</i>	500–800	15–45	18–30	10–13
Araceae	<i>Aglaonema</i>	150–250	8–20	20–28	15–18
	<i>Alocasia</i>	250–800	15–40	18–28	15–18
	<i>Anthurium</i>	150–350	15–35	18–28	15–18
	<i>Dieffenbachia</i>	250–450	15–40	20–28	16–18
	<i>Epipremnum</i>	250–600	8–25	20–32	13–16
	<i>Homalomena</i>	250–500	15–40	20–28	16–18
	<i>Monstera</i>	350–650	15–30	18–28	16–18
	<i>Philodendron</i>	250–850	8–30	18–28	16–18
	<i>Spathiphyllum</i>	250–500	15–30	18–28	10–13
	<i>Syngonium</i>	280–550	15–30	20–28	13–16
	<i>Zamioculcas</i>	150–250	4–15	18–28	10–16

Table 2.2. (continued)

Family	Genus	Light intensity ($\mu\text{mol m}^{-2} \text{s}^{-1}$)		Temperature (°C)	
		Production	Interiorscape ^y	Production	Transportation ^x
Araliaceae	<i>Dizygotheca</i>	300–750	25–45	18–28	13–16
	<i>Fatsia</i>	250–450	20–50	18–28	13–16
	<i>Hedera</i>	250–500	15–30	18–28	13–16
	<i>Polyscias</i>	250–750	20–50	18–28	13–16
	<i>Schefflera</i>	400–850	15–50	16–30	10–13
Araucariaceae	<i>Araucaria</i>	750–950	25–50	20–30	10–18
Begoniaceae	<i>Begonia</i>	350–550	25–50	18–28	16–18
Bromeliaceae	<i>Aechmea</i>	350–600	25–50	15–29	16–18
	<i>Guzmania</i>	350–550	25–50	15–29	13–16
	<i>Neoregelia</i>	350–550	25–50	15–29	13–16
	<i>Vriesea</i>	350–550	25–50	15–29	13–16
Compositae	<i>Gynura</i>	280–500	20–40	20–28	13–16
Euphorbiaceae	<i>Codiaeum</i>	500–900	15–50	18–30	13–16
Gesneriaceae	<i>Aeschynanthus</i>	400–800	20–40	20–27	16–18
	<i>Saintpaulia</i>	200–400	25–50	18–29	16–18
Liliaceae	<i>Asparagus</i>	350–550	20–30	18–28	16–18
	<i>Aspidistra</i>	300–500	8–25	18–28	10–13
	<i>Chlorophytum</i>	200–450	15–40	18–30	13–16
	<i>Haworthia</i>	400–800	30–50	18–30	15–18
Marantaceae	<i>Calathea</i>	180–350	8–25	20–28	16–18
	<i>Maranta</i>	180–350	10–25	21–27	13–16

Moraceae	<i>Ficus</i>	200–900	15–30	20–28	13–16
Palmae	<i>Chamaedorea</i>	250–500	8–25	24–32	13–16
	<i>Chrysalidocarpus</i>	300–600	15–25	20–28	16–18
	<i>Howea</i>	450–900	15–30	16–29	10–18
	<i>Phoenix</i>	500–900	15–40	18–30	10–13
	<i>Ravenea</i>	400–800	30–50	16–30	10–13
	<i>Rhapis</i>	400–900	12–40	15–26	10–13
Piperaceae	<i>Peperomia</i>	250–450	10–20	18–28	16–18
Pittosporaceae	<i>Pittosporum</i>	450–900	25–50	18–28	10–18
Polypodiaceae	<i>Adiantum</i>	200–350	20–40	20–28	16–18
	<i>Asplenium</i>	250–400	15–30	18–30	10–18
	<i>Davallia</i>	250–500	20–35	18–28	13–16
	<i>Nephrolepis</i>	250–550	15–30	20–30	16–18
	<i>Platynerium</i>	250–550	20–40	18–28	13–16
	<i>Pteris</i>	250–500	20–50	18–28	13–16
Rubiaceae	<i>Coffea</i>	200–550	30–50	20–28	13–16
Strelitziaceae	<i>Strelitzia</i>	400–800	25–50	18–28	13–16
Urticaceae	<i>Pilea</i>	200–350	25–50	18–28	13–16
Vitaceae	<i>Cissus</i>	225–350	15–30	20–28	13–16

²Data are compiled from Joiner et al. (1983), Conover and Poole (1984), Blessington and Collins (1993), and J. Chen (unpubl. data) with modification.

³Acclimatized plants can tolerate indicated light levels under appropriate interior conditions.

⁴Data are for plants in containers in the dark for a shipment duration of 1–15 days.

$\text{m}^{-2} \text{s}^{-1}$, respectively when initially grown under a light intensity of $470 \mu\text{mol m}^{-2} \text{s}^{-1}$ (Araus et al. 1986). The light-compensation point can be shifted by production light intensities. Fonteno and McWilliams (1978) found that light-compensation points of *Epipremnum aureum*, *Dracaena sanderana*, *Philodendron scandens* Subsp. *oxycardium*, and *Schefflera actinophylla* were 38, 119, 33, and $14 \mu\text{mol m}^{-2} \text{s}^{-1}$, respectively, when grown in a shaded greenhouse under a light intensity of $1,200 \mu\text{mol m}^{-2} \text{s}^{-1}$. However, after these plants were moved to light intensities of $27 \mu\text{mol m}^{-2} \text{s}^{-1}$ for 15 weeks, the light-compensation points for *E. aureum*, *D. sanderana*, *P. scandens*, and *S. actinophylla* dropped to 6, 15, 6, and $4 \mu\text{mol m}^{-2} \text{s}^{-1}$, respectively. The decreased light-compensation points after placement in low light conditions are remarkable and have been documented in other foliage plants such as *Ficus benjamina* and *Nephrolepis exaltata* (Conover and Poole 1984). The process is referred to as light acclimatization and will be discussed in Section IV. The ability of most foliage plants to adjust their photosynthetic activity based on changes in light intensity probably developed in their indigenous environments where sunflecks vary widely in the understory rainforests. It is also possible that some foliage plants may have different light response systems for adaptation to different light intensities. Bailey et al. (2001) used *Arabidopsis thaliana* as a model system and found that there were distinct and separate light response systems for low and high light intensities.

Adaptation of foliage plants to varied irradiance levels entails anatomical, morphological, and physiological changes. Chow et al. (1988) found that palisade cell chloroplasts of *Alocasia macrorrhiza* were preferentially located adjacent to the distal periclinal cell walls and had large grana stacks, and a very low surface charge density on the destacked thylakoids when grown under a low irradiance of $10 \mu\text{mol m}^{-2} \text{s}^{-1}$. In contrast, palisade cell chloroplasts were preferentially located adjacent to the anticlinal cell walls, had small grana stacks, large stromal spaces, and a high surface charge density on the destacked thylakoids when grown under an irradiance of $780 \mu\text{mol m}^{-2} \text{s}^{-1}$. Chloroplast numbers per unit section length increased with irradiance. Ribulosebiphosphate carboxylase activity per unit leaf area increased markedly with irradiance. Chen et al. (2004c) found that *Ficus benjamina* 'Common', grown indoors under $16 \mu\text{mol m}^{-2} \text{s}^{-1}$, exhibited increased specific leaf areas, internode lengths, and chlorophyll b content compared to plants grown in a shaded greenhouse under $300 \mu\text{mol m}^{-2} \text{s}^{-1}$. The degree of foliar variegation in *Codiaeum variegatum* and *Dieffenbachia maculata* 'Camille'

decreased as production light intensities decreased (Bequette et al. 1985; Chen et al. 2004c). In contrast, a study of irradiance on foliar variegation of *Dracaena sanderana* 'Ribbon' by Vladimirova et al. (1997) showed that less leaf variegation occurred in plants grown under 47% ($1,250 \mu\text{mol m}^{-2} \text{s}^{-1}$) and 63% ($870 \mu\text{mol m}^{-2} \text{s}^{-1}$) shade than those of 80% ($470 \mu\text{mol m}^{-2} \text{s}^{-1}$) and 91% ($200 \mu\text{mol m}^{-2} \text{s}^{-1}$) shade.

2. Light Quality. Changes in light quantity affect plant growth and biomass production, while shifts in the spectral composition of light alter plant morphogenesis (Stuefer and Huber 1998). It is unclear if the morphological changes in foliage plants (canopy architecture, leaf area, leaf variegation, internode length) resulted from changes in light quantity or quality, or the interaction of both. Oren-Shamir et al. (2001) studied the effects of colored shade nets on the growth of *Pittosporum variegatum*. Blue net transmitted a broad peak around 470 nm and far red and near infrared light beyond 750 nm. The green net had a broad peak around 520 nm and a gradual transmittance in the far red. The red net had major transmittance beyond 590 nm and a minor peak around 400 nm. Three neutral nets (black, grey, and aluminet) did not modify the spectrum in the visible ranges. Results showed that pronounced stimulation of branch elongation of *P. variegatum* occurred under the red net; dwarfing under the blue net; enhanced branching under the grey net resulting in bushy, dense plants with short side shoots and small leaves; and enhanced long branches developed under the aluminet. The use of colored nets may have potential for enhancing foliage plant quality. Colored nets offer shade required by foliage plants, and the changed spectra may help produce foliage of desired appearance. No information is available on light quality influencing interior performance of foliage plants. Investigation on how light quality affects architecture, branching, internode length, pattern of leaf variegation, and color is needed to develop technologies for improving production and interior performance of foliage plants.

3. Other Light Components. Due to their tropical and subtropical origin, most foliage plants are assumed to be photoperiodically day neutral (Halevy 1990). However, a few foliage plants respond to photoperiod. Hammer (1976) reported that a daylength less than 12 hr greatly reduced the time for stolon formation of *Chlorophytum comosum* cv. Vittatum (variegated spider plant). Heins and Wilkins (1978) found that long day treatments increased stolon formation of solid green *Chlorophytum comosum*.

C. Temperature

Because temperature has direct effects on enzymatic reactions and membrane processes of plants, temperature effects on foliage plants have been closely related to photosynthesis and respiration. For example, maximum photosynthetic rates of *Zantedeschia* 'Best Gold' grown at day temperatures of 16, 22, and 28°C under a saturated PPF (694 $\mu\text{mol m}^{-2} \text{s}^{-1}$) were 7.8, 9.8, and 11.0 $\mu\text{mol m}^{-2} \text{s}^{-1}$, respectively (Funnell et al. 2002). Using the portable chlorophyll fluorometer (PAM 2000), Koniger et al. (1998) measured the quantum yield of photosystem II (Φ_{PSII}) of *Alocasia macrorrhiza* and found that leaf discs exposed to 30°C under an irradiance of 1,600 $\mu\text{mol m}^{-2} \text{s}^{-1}$ recovered completely but no recovery of Φ_{PSII} was seen after exposure to 45°C. The parameter Φ_{PSII} measures the proportion of the light absorbed by chlorophyll in association with PSII that is used in photochemistry. As such, it provides a measure of the linear rate of electron transport and thus is an indication of overall photosynthesis (Maxwell and Johnson 2000). In general, a temperature rendering the maximum net photosynthesis rate is the optimum temperature for foliage plant growth. Recommended day and night temperatures for foliage plants are presented in Table 2.2. Depending on genera, species, or cultivars, optimal night temperatures may vary. Poole and Conover (1981a) studied effects of minimum night temperatures of 15, 18, or 21°C on the growth of *Epipremnum aureum*, *Aglaonema* 'Fransher', and *Dieffenbachia* 'Marianne'. The growth of *A.* 'Fransher' was unaffected by different night temperatures while *D.* 'Marianne' grew only slightly better with each 3°C increase. However, *E. aureum* vines were 50% larger when grown at 21°C nights vs. 15°C.

Air temperatures may not always be maintained within the desired ranges. Freeze, chilling, and heat stresses occur during production and can significantly affect foliage plant growth. Freeze stress refers to a temperature at or below the freezing point. Since most foliage plants are native to tropical and subtropical regions, almost all foliage plants are unable to tolerate temperature of 0°C without severe damage. Consequently, temperatures during production or shipping should never be allowed to approach freezing. Chilling in foliage plants is defined as a temperature that is cold enough to cause injury but not cold enough to freeze, usually ranging from just above 0°C to 15°C. Due to unexpected weather events and malfunctioning heating systems in shaded greenhouses, chilling injury frequently occurs in foliage plants (McWilliams and Smith 1978). Symptoms can be visible, ranging from water-soaked patches, necrotic lesions on leaves, or plant death, or may be invisible and expressed as a reduced plant growth rate. Chilling injury on some

Spathiphyllum cultivars appears at 7°C, with injured leaves becoming necrotic and dry. There is no visible injury immediately following exposure to 10°C, but as a delayed expression, the plant growth index can be reduced by 50%, depending on cultivars (Qu et al. 2000). Injury to some *Aglaonema* cultivars occurs at 13°C and is characterized by dark and greasy-appearing patches on the surface of leaves (Chen et al. 2001a). Tissue collapse in older leaves is a typical symptom in *Dieffenbachia* cultivars (Conover and Poole 1974c).

Temperature at or above 35°C may be considered as heat stress. Heat stress symptoms are often not detectable except as a reduction in plant growth; but if plants are sensitive or temperatures high enough, leaf necrotic lesions develop and plant death may follow. Heat stress is closely related to leaf temperature of foliage plants. When the production environment is warm and has high humidity and little air movement, the leaf temperature will be higher than the air temperature. Leaf temperatures as high as 40°C were detected on *Agave americana* and *Codiaeum variegatum* grown in a shadehouse during a humid central Florida summer day (J. Chen et al., unpubl. data). Factors contributing to elevated leaf temperatures also include drought stress caused by water deficits or high soluble salts. Increasing irrigation frequency may lessen high temperature effects on foliage plant growth (Poole and Conover 1981). At elevated temperatures, the oxygenating reaction of Rubisco (ribulose biphosphate carboxylase-oxygenase) increases more than the carboxylating one so that photorespiration becomes proportionally more important (Lambers et al. 1998). This is partly because the solubility of CO₂ declines more rapidly with increasing temperature than does O₂. McConnell et al. (2003) monitored the growth of two *Spathiphyllum* cultivars, 'Petite' and 'Tasson', under three different temperature regimes (29°, 35°, or 41°C) for 12 hours daily with a night temperature of 21°C for 12 weeks. Narrower leaves developed in the two cultivars at temperatures above 29°C, and growth rates decreased with each 6°C rise in temperature.

In addition to air and leaf temperatures, substrate temperature (i.e., actual temperature around roots) also affects foliage plant growth. Foliage plants are grown in soilless substrates confined by different sizes of containers, and substrate temperatures fluctuate more in smaller containers than in larger containers. Bodnaruk et al. (1981) reported that air temperature in a shaded greenhouse without heat in February dropped from 14°C at 5:00 P.M. to 7°C at 6:00 A.M. in central Florida, while substrate temperatures of 7-cm diameter containers decreased from 20.5°C to 12°C. Henley (1991) showed that changes in air temperature of a shaded greenhouse and substrate temperature of 20-cm

diameter containers were almost identical, decreasing from 25°C at 4:00 P.M. to 18°C at 4:00 A.M. in February in central Florida. In the same experiment, root-zone heated containers maintained temperatures between 22 and 27°C. *Aglaonema* 'Silver Queen' grown in the root-zone heated containers had five times more lateral shoots and 50% more dry weight than plants grown in unheated containers. Root zone heating or bottom heating is often accomplished by using steam or hot water pipes beneath benches and skirting the benches to retain heat. Hot air may be forced through convection tubes under the benches or commercial heating systems may be utilized. A study of the interactions between irradiance and root-zone heating on rooting of *Codiaeum variegatum* 'Gold Dust' and *Ficus benjamina* by Wang (1988) found that the number of roots in *C. variegatum* was unaffected by either irradiance or medium heating, but both factors enhanced root elongation. However, rooting of *F. benjamina* was improved in a heated substrate and was unaffected by irradiance. Seeds of *Syngonium podophyllum* germinated and grew faster at 24 or 30°C than in unheated media (Henny 1988).

Genetic variation in chilling or heat tolerance exists among cultivars (Henny and Chen 2003). Use of chilling or heat tolerant cultivars in production could be a solution for reducing temperature-related injury. *Aglaonema* hybrids 'Emerald Star', 'Star', and 'Jewel of India' tolerated a temperature of 2°C, whereas a popular cultivar, *Aglaonema* 'Silver Queen', exhibited chilling injury at 13°C (Chen et al. 2001a). Qu et al. (2000) evaluated chilling responses of 15 *Spathiphyllum* cultivars and found that leaf area injury after five days of exposure at 3.3°C ranged from 5% to 100%. When eight of the 15 *Spathiphyllum* cultivars were evaluated for heat stress (45°C for 1.5 hr), the chilling tolerant cultivars were not the heat tolerant ones (McConnell et al. 2003). Thus, mechanisms underlying chilling and heat tolerance are different among *Spathiphyllum* cultivars.

Other parameters or concepts related to temperature include average daily temperature, the difference between day and night temperatures (day – night = DIF), stratification, and vernalization. Average daily temperature, calculated as an average of temperatures measured hourly or more frequently, has been frequently used to predict plant growth rate. Utilization of DIF does affect stem elongation of some plants. The greater positive differences are, the greater the stem elongation, while negative differences reduce stem elongation (Berghage and Heins 1991). Stratification is a cold treatment of seeds to enhance germination. Little documentation is available on DIF and stratification application to foliage plants, but vernalization may play a role in flower induction. Halevy et

al. (1976) reported that flower production was 30 to 50% higher in *Strelitzia reginae* grown at a minimum temperature of 13°C than when grown at 21°C. Some *Spathiphyllum* cultivars chilled at 12°C flowered earlier than unchilled controls (J. Chen et al. unpubl. data).

D. Air Humidity

Air humidity can be expressed using different terms such as absolute humidity (grams of water vapor per m³), relative humidity (humidity as % of the maximum humidity at a given temperature), vapor pressure (pressure caused by a gas or a vapor ranging from 1 to 5 kPa), and vapor pressure deficit (difference between actual and maximum vapor pressure, ranging from 0.1 to 3 kPa). Relative humidity (RH) has been widely used, but the use of term vapor pressure deficit (VPD) is increasing. A higher VPD means that air has a higher capacity to hold water, or the air has a low RH. A lower VPD indicates air is at or near saturation, or the air has a high RH. However expressed, the amount of water in the air varies according to temperature, thus its effects on foliage plant growth interact with temperature.

Humidity can directly affect plant growth (Lange et al. 1971; Monteith 1995). Clifton-Brown and Jones (1999) evaluated the response of hydroponic-growing *Miscanthus × giganteus* to variable VPD at a constant temperature and observed that leaf extension rate transiently decreased as VPD increased. This decrease was attributed to changes in transpiration rate and hence leaf water status. Serpe and Matthews (2000) reported that a decrease of RH from 70 to 5% caused a decrease of epidermal cell turgor by 0.05 MPa in *Begonia argenteo-guttata*. This small turgor decrease resulted in cessation of leaf growth. Krizek et al. (1971) reported that 40% RH severely limited the seedling growth of *Petunia hybrida* 'Pink Cascade', but raising the RH to 65% resulted in increased fresh weight, dry weight, and leaf area. Information regarding humidity affecting foliage plant growth is limited. After reviewing a wide range of literature, Grange and Hand (1987) concluded that RH in the range of 60 to 90% had little influence on the growth and development of plants normally grown in greenhouses. Mortensen and Gislerod (1990) concluded that growth of foliage plants was generally unaffected when VPD decreased from 1.0 to 0.4 kPa (correspondingly RH from 68% to 88% at 25°C). However, foliage plants with CAM (crassulacean acid metabolism), such as bromeliads and succulents, may be injured by high RH (Poole and Conover 1992). Since stomata of this group of plants are closed during the daytime, high humidity accompanied by elevated

temperature may cause cell bursting as the result of excessive leaf turgor pressure. This may account for the leaf necrotic lesions that occurred during production and shipping of CAM plants. Another possible effect of high humidity on plant growth is calcium deficiency. Calcium deficiency symptoms include distorted new leaves, meristems, or even the death of the meristem. Calcium is transported by the transpiration stream, and as transpiration decreases, calcium transport decreases.

Humidity can indirectly affect plant growth by promoting disease development. Botrytis blight caused by *Botrytis cinerea* is a prevalent greenhouse disease and is a problem on *Aeschynathus radicans*, *Cissus rhombifolia*, *Codiaeum variegatum*, *Dracaena surculosa*, *Hedera helix*, *Ficus benjamina*, and *Philodendron scanden* (Chase 1997). This fungus survives best below 0.43 kPa (about 87% RH at 25°C), and infection is most damaging below 0.2 kPa (about 93% RH at 25°C). In contrast to *Botrytis* and other fungal pathogens that are closely associated with high humidity, there are a few fungal pathogens that thrive under dry conditions. A renowned one is powdery mildew (*Podosphaera*), whose spores contain 70% water, so water is not needed for germination. Powdery mildew can even establish and grow at a RH as low as 30%. Water and high RH can be used to control powdery mildew as spores soaked in water for 3 hr are less viable, and one or two days of high RH has the same effect. However, powdery mildew is an exception, and most fungi can be controlled by keeping RH low.

E. Environmental Control

A shaded greenhouse or shadehouse environment is a complex and dynamic environment. The primary goals of environmental control systems are to create an environment that has desired irradiance, temperature, and humidity levels for optimum growth and development of foliage plants. Environmental control systems used for foliage plant production include: (1) thermostats and timers, (2) analogue step controllers, (3) dedicated microprocessor controls, (4) integrated computer controls, and (5) model-based computer controls (Kamp and Timmerman 1996; Nelson 2003).

Thermostats and timers are low-cost systems and provide limited control. Thermostats are simple temperature-sensing devices that turn a switch on at one temperature and off at another. A greenhouse zone may need three or more individual thermostats to control heating and cooling functions. Timers are used for other functions such as turning irrigation systems on and off and activating mechanical fabric movers.

Additional relays are often necessary to interconnect fans and louvers and other devices that must work together. Analogue step controllers divide greenhouse heating and cooling equipment into steps, or stages, called a sequence of operation. They are generally most appropriate for simple greenhouse zones limited to 6 to 8 total stages of heating and cooling, and in smaller operations not anticipating expansion. Step controllers have low initial cost and provide better control of the greenhouse environment than either single or multiple stage thermostats. Dedicated microprocessors are devices that bring the benefits of computerization to the step controller concept. They have more output connections than the step controller and a full range of optional sensors to control irrigation, lighting, and temperature. Using the built-in keypad and the menu-driven on-screen interface, growers can customize the system based on their needs. With proper programming, microprocessor controls provide improved accuracy and better equipment coordination. Integrated computer controls (ICC) are advanced from microprocessor controls by combining the capability of step or microprocessor and other individual control devices into an integrated computer system. Integrated computer controls can coordinate virtually all greenhouse environment functions, including ventilation, heating, cooling, air circulation, irrigation, fertilization, boiler control, lighting, and CO₂ dosing based on multiple settings entered by the growers. The benefits of the ICC include more stable and accurate environmental control, energy conservation, improved crop production, and lower labor costs. Finally, model-based controllers have more sophisticated software available that allows more precise and real-time control of plant growth. The problem with model-based systems is that optimal levels of environmental and cultural parameters must be determined for the crop and correctly entered into the program to achieve optimal growth. Thus, current limitations to model development are our knowledge of the relationship between balances of environmental and cultural inputs and crop physiological responses and the relationship between crop yield and profit (Nelson 2003). The realm of model-based systems can spread to encompass automated pesticide and fertilizer applications. The installation of a control system in foliage plant production largely depends on labor availability and costs, energy consumption, market demands, and profitability. Based on past changes and present trends in the ever-increasing degree of substitution of capital for labor, it is highly probable that the cultural and environmental requirements for producing quality foliage plants in greenhouses of the future will rely primarily on computerized control systems.

III. FOLIAGE PLANT PROPAGATION

Foliage plants are propagated mainly through vegetative means, although some genera can be propagated by seeds or spores (Henny and Chen 2003). Methods of vegetative propagation include cutting, division, layering, offsets, suckers, runners, and micropropagation.

A. Vegetative Propagation

1. Cuttings. Cuttings include tip, single- or double-eye, leaf, or cane derived from healthy, turgid, pest-free stock plants. Tip cuttings have been commonly used for propagation of *Aglaonema*, *Codiaeum*, *Cordyline*, *Dracaena*, *Ficus*, *Hedera*, *Peperomia*, and *Schefflera*. Single- or double-eye cuttings refer to cuttings possessing single or double buds with an attached leaf or leaves, also known as leaf bud cuttings and single- or double-node cuttings. These cuttings have been widely used for propagation of *Cissus rhombifolia*, *Epipremnum aureum*, *Philodendron scandens oxycardium*, and *Syngonium podophyllum*. Leaf cuttings are used to propagate *Saintpaulia ionantha*, *Sansevieria trifasciata*, and *Zamioculcas zamiifolia*. Cane propagation is the predominant method used for *Dracaena fragrans* 'Massangeana'. Mature stems are harvested from stock plants, cut into sections of varying length (30 to 120 cm), and inserted into container substrate. Canes should be sealed with chemical to avoid water loss and must be rooted upright. In general, canes root and sprout in three to six weeks. Commercially, cuttings are often imported from Caribbean and Central American countries where stock plantings can be maintained inexpensively.

2. Division. The separation or splitting of plants through the root system is known as division. The term also applies to separation of bulbs (*Eucharis grandifolia*) and rhizomes (*Alocasia*, *Colocasia*, *Strelitzia reginae*, *Zamioculcas zamifolia*, some orchids, ornamental ferns and ginger, and tuberous begonia). Propagation is carried out by separating bulbs or cutting rhizomes into sections, being sure that each piece has at least one lateral bud.

3. Layering. The development of adventitious roots on stems that are still attached to the stock plants is called layering (Hartmann et al. 1997). The rooted or layered stems are then detached as propagules for transplanting. Layering was commonly used for *Ficus*, *Monstera*, and *Codiaeum* propagation before the advent of micropropagation laboratories. Now, it

is only used when large propagules are desired. *Ficus binnendijkii* 'Amstel King' is still propagated by air layering because protocols for rooting of its cuttings and tissue culture have not been well established.

4. Offsets and Suckers. An offset is a characteristic type of lateral shoot or branch that develops from the base of the main stem. Foliage plants that produce offsets include *Anthurium*, *Dieffenbachia*, *Spathiphyllum*, and many bromeliads. Offsets are removed by cutting them close to the main stem of a stock plant with a sharp knife and transplanting them into a container substrate. A sucker is a shoot that arises on a plant from below ground. The most precise use of this term is to designate a shoot that arises from an adventitious bud on a root. Suckers are produced by several foliage plants including *Aglaonema*, *Aspidistra*, *Calathea*, *Maranta*, and *Sansevieria* and transplanted in the same manner as offshoots.

5. Runners and Stolons. Specialized stems that arise from leaf axils are known as runners. Runners grow horizontally above and along the ground, and produce plantlets at their nodes or apex. Boston fern (*Nephrolepis*) produces runner-like branches that form small plants known as "keikies." Mother of thousand (*Saxifraga sarmentosa*) produces long, slender red runners that bear miniature plants at their ends. The keikies and miniature plants can be used as propagules. Spider plant (*Chlorophytum comosum*) produces plantlets from the apex of stolons; the plantlets are the primary propagules used for commercial production.

6. Micropropagation. The multiplication of new plants on artificial media under aseptic conditions from very small pieces of plants, such as embryos, seeds, stems, shoot tips, root tips, calli, single cells, and pollen grains, is termed micropropagation. Micropropagation has made a major impact on foliage plant propagation. At least 50% of foliage plant genera can be propagated via tissue culture, and major foliage plant genera or groups commercially micropropagated include *Alocasia*, *Anthurium*, *Calathea*, *Colocasia*, *Dieffenbachia*, *Ficus*, *Musa*, *Philodendron*, *Syngonium*, *Spathiphyllum*, ferns, and bromeliads. These plants account for about 70% of the foliage plant wholesale value in the United States. Commercial tissue culture laboratories are able to produce millions of plantlets that are grown in substrate-filled plug trays (Fig. 2.6). The plants are commonly called liners, which are uniform, well rooted, and pathogen free. Since plantlets are continuously transferred from laboratories to greenhouses, liners provide a year-round source of plant propagules (Debergh and Maene 1981; Henny et al. 1981). Tissue culture



Fig. 2.6. Typical commercial foliage plant tissue culture production facilities: (A) culture room, (B) tissue culture generated plantlets being transplanted into plug trays, (C) transplanted plantlets grown in a shaded greenhouse, and (D) mature liners ready for sale.

plantlets also have desirable growth habits when compared to plants propagated by standard methods. *Anthurium*, *Dieffenbachia*, *Spathiphyllum*, and *Syngonium* often develop multiple basal shoots when grown from tissue culture and produce finished plants that are fuller and more compact than plants produced by other methods (Conover 1985). Use of liners has also given producers the option of converting space formerly used to grow stock plants into production areas for marketable plants.

B. Seed or Spore Propagation

1. Seeds. Some foliage plant species, such as *Araucaria heterophylla*, *Chamaedorea elegans*, *Chrysalidocarpus lutescens*, *Coffea arabica*, *Howea forsterana*, *Hypoestes phyllostachya*, *Phoenix roebelenii*, *Ravenea rivularis*, and *Schefflera actinophylla*, are exclusively grown from seeds. *Aglaonema*, *Anthurium*, *Chlorophytum amaniense*, *Dieffenbachia*, *Philodendron*, *Spathiphyllum*, and bromeliads are seed propagated primarily for evaluating progeny from breeding programs.

Seed propagation requires knowledge of seed physiology and environmental conditions for germination (Joiner et al. 1981). Foliage plant seeds generally have no dormancy. Mature, fresh seeds should be immediately cleaned after harvest and sown directly. For example, after harvesting the red berry-like fruit of *Dieffenbachia* and *Aglaonema*, the pulp of the fleshy fruit should be removed and the seed planted. *Spathiphyllum*, however, has a large quantity of small seeds. The entire spadix is harvested when mature (indicated by a change in color from green to yellow and a softening of the tissue) and placed in a plastic bag with a little water. The spadix tissue decays in a few days and the seeds can be removed by gently washing on a screen small enough to catch the seeds but letting the rotted spadix tissue rinse through (Henny and Chen 2003). Longevity of seed extracted from pulpy fruit is often short, ranging from 3 to 10 days. Thus, cleaned seeds should be planted before they dry. Perry (1981) reported that storing *Syngonium* 'Variegata' seeds for 14 days at 22°C and 25–50% relative humidity reduced germination from 89% (fresh) to 7%. Good germination is achieved if the seeds are sown on the top of a moist substrate and covered with plastic or other material to prevent drying. Soil temperature should be kept at a minimum of 21°C. Germinated seedlings can be removed from the germination chambers and repotted once the first true leaves are produced. Depending on genera or species, up to two to five months are needed for germination, and germination rates vary from 15 to 80% (Joiner 1981; Henny 2000). Most aroid seedlings require at least 1–2 years before they are large enough to be evaluated for their ornamental value.

2. Spores. Spores are used to propagate many fern cultivars. Germinating spores produce a prothallium, then archegonium (female reproductive organ producing eggs) and antheridium (male reproductive organ producing male gametes) are formed on the prothallium. The antheridium produces mobile antherozoids, which swim to the archegonium and fertilize the eggs when the prothallium is covered with a film of water. In the past, spores were germinated in a peat substrate in a shaded greenhouse (Joiner et al. 1981), but they are now predominantly germinated in nutrient agar under aseptic conditions (Lane 1980; Henny et al. 1981). Spores of various ferns can be sterilized and sown on nutrient agar. Spore germination per se is favored by using a nutrient-free medium, but growth of the prothallus is improved by the addition of inorganic salts and sucrose. Germination occurs in two to three weeks, and the developing ferns can be transplanted into appropriate substrates in two to three months (Hartmann et al. 1997).

IV. FOLIAGE PLANT PRODUCTION

Foliage plant production refers to producing marketable containerized plants, or finished plants in commercial terminology, from seedlings, tissue cultured liners, or rooted cuttings in either shadehouses or shaded greenhouses.

A. Containers and Container Substrates

1. Containers. Plastic plug trays, pots, and hanging baskets have been used in foliage plant propagation or production. Plug flats are a temporary intermediate container used mainly for germinating seeds, propagating cuttings, or growing plantlets from tissue culture. The North American standard plug tray for ornamentals is 28 × 56 cm and can hold 18 to 800 cells (Styer and Koranski 1997). Pots are identified by diameters ranging from 4.4 to 40 cm. Larger containers for interiorscape trees are designated on a volume basis and are available in sizes in excess of 100 L. Round pots are more popular than square ones. Hanging baskets are designated by diameter as well, which varies from 15 to 30 cm. The baskets usually have saucers or other devices to collect drainage. However, saucers are usually removed in production and reattached prior to marketing.

2. Container Substrates. Most commercially grown foliage plants are produced in soilless substrates. The vital substrate component is organic matter such as pine bark, peat, coir dust, or compost. Additional ingredients, including perlite, vermiculite, sand, and styrofoam are used in various combinations with the organic materials to formulate container substrates. Container substrate companies usually prepare and sell their own formulations and may also mix a specific substrate formulation per grower request. For example, Vergo Container Mix A (Verlite Co., Tampa, Florida), a widely used premixed packaged substrate for foliage plant production, is comprised of 60% Canadian peat, 20% vermiculite, and 20% perlite based on volume and supplemented with 4 kg m³ dolomite. Large nurseries have their own formulas and prepare their container substrate from component ingredients on site. Commonly used substrates are listed in Table 2.3. The substrates should hold and provide water and nutrients, permit gas exchange to and from roots, and physically support plants. Various physical and chemical parameters have been taken into account for determining the quality of container

Table 2.3. Components of common substrates used for foliage plant propagation and production.

Substrate name	Components
² Cornell Foliage Plant Mix	50% sphagnum peat, 25% vermiculite, and 25% perlite, supplemented with 4.9 kg of ground limestone, 1.2 kg of superphosphate, 0.6 kg of potassium nitrate, 0.07 kg of fritted trace elements, and 1.6 kg of granular fertilizer (10-10-10) per cubic meter.
Cornell Epiphytic Mix	33% sphagnum peat, 33% perlite, and 33% Douglas fir bark supplemented with 4.2 kg of ground limestone, 2.4 kg of superphosphate, 0.6 kg of potassium nitrate, 0.07 kg of fritted trace elements, 0.3 kg of iron sulfate, and 1.6 kg of granular fertilizer (10-10-10) per cubic meter.
³ Coir Dust Mix 1	50% coconut coir dust, 25% vermiculate, 25% perlite, supplemented with dolomite at 4.2 kg m ⁻³ .
Coir Dust Mix 2	40% coconut coir dust, 30% vermiculate, 30% pine bark, supplemented with dolomite at 4.2 kg m ⁻³ .
⁴ Fafard Mix	50% sphagnum peat, 30% pine bark, 10% perlite, and 10% vermiculate, supplemented with dolomite and gypsum at 6 and 1.2 kg m ⁻³ , respectively, and liquid wetting agent at 160 mL m ⁻³ .
⁵ UF Foliage Plants Mix 1	50% sphagnum peat, 25% pine bark, and 25% shavings, dolomite and fertilizers may be supplemented.
UF Foliage Plants Mix 2	50% sphagnum peat and 50% pine bark, dolomite and fertilizers may be supplemented.
UF Foliage Plants Mix 3	75% sphagnum peat and 25% sand, dolomite and fertilizer may be supplemented.
⁶ Vergo Container Mix A	60% Canadian peat, 20% vermiculite, and 20% perlite supplemented with 4 kg m ⁻³ dolomite.

²Boodley and Scheldrake 1977.

³Stamps and Evans 1997.

⁴Fafard Inc., Apopka, Florida.

⁵Poole et al. 1981.

⁶Verlite Co., Tampa, Florida.

substrates (De Boodt and Verdonck 1972; Poole et al. 1981; Maronek et al. 1985; Bunt 1988; Bailey 1996; Fonteno 1996; Chen et al. 2002c). In general, substrates with the following physical properties should be suitable for both propagation and production of quality foliage plants: bulk density ranging from 0.15 to 0.8 g cm⁻³ (dry weight), total porosity

of 50 to 75%, container capacity between 20 to 60% by volume, moisture content of 50 to 75%, and air space 10 to 20% (5 to 10% for cell plugs). Desired chemical properties of container substrates include: carbon to nitrogen ratio less than 25, pH 5.5 to 7, soluble salts of root-zone solution 1.0 to 3.0 dS m⁻¹ extracted using the pour-through method, cation exchange capacity 5 to 50 meq 100 g⁻¹, and sodium, boron, and fluorine concentrations less than 80, 4, and 1 mg kg⁻¹, respectively. Some foliage plant genera such as *Chlorophytum*, *Cordyline*, and *Dracaena* are particularly sensitive to fluoride. Tipburn followed by leaf necrosis are typical symptoms (Joiner et al. 1983). Superphosphate, which used to be a common container substrate amendment, was shown to be a fluoride carrier (Poole and Conover 1975). Potting machines have been widely used for putting substrates into containers; 900 to 3,500 containers can be filled in one hour depending on the capacity of machines.

3. Container Effects. Container geometry and volumes have profound effects on some physical properties of substrates and the growth and development of foliage plants. In general, as container height to width decreases, the substrate air space decreases. This phenomenon occurs due to an interaction between gravity and the adhesive and cohesive forces of water. Filling five containers (15-cm and 10-cm round plastic pots, 48 cells, 288 cells, and 648 cells) with a peat and vermiculite (1:1 by volume) substrate, Fonteno (1996) demonstrated that container air space decreased from 20% in a 15-cm pot to 0.5% in a 648-cell plug tray, while water content increased from 67% in the 15-cm pot to 86.5% in the 648-cell plug. The selection of correct cell plug size and substrates is important in order to attain the best seed germination and rooting of cuttings. Poole and Conover (1978) produced *Schefflera actinophylla* in four containers with volumes of 2.0, 3.8, 9.0, and 14 L, respectively. Each container volume received three rates of nitrogen (100, 200, and 300 kg ha⁻¹). Fertilizer levels had no effect on *Schefflera* growth, but plant size and quality increased with each increase in container volume. As root and shoot growth are interdependent, restriction of root growth limits water and nutrient absorption and hormone synthesis, thus reducing plant growth. Plant size is also influenced by genetics. Correspondingly, small foliage plants are usually grown in 10-cm or 15-cm diameter containers, medium plants in 20-cm or 25-cm containers, and large plants in 30-cm diameter or larger containers. For those medium to large plants, such as *Ficus* and some cultivars of *Anthurium* and *Spathiphyllum*, progressively increasing container sizes during production is recommended.

B. Water and Irrigation

Shoots of foliage plants are largely water by weight: *Aglaonema* (80%), *Anthurium* (84%), *Dracaena fragrans* (86%), *Syngonium* (91%), *Diefenbachia* (92%), *Schefflera* (96%), and *Spathiphyllum* (98%). Since foliage plants are grown in container substrates, the availability of water to plants depends primarily on the quantity of water stored in the container substrate and its relationship to the substrate's water potential. Verdonck et al. (1983) proposed that a substrate should contain about 20 to 30% volume of easily available water for optimal growth. The lowest water potential at which a plant can access water from soil is the permanent wilting percentage (Kramer and Boyer 1995). Richards and Waldleigh (1952) found that the soil water potential ranged from -1.5 to -2.0 MPa at permanent wilting. Permanent wilting percentages of foliage plants, however, are largely unknown and may vary with container substrates and plant species. Water loss in foliage plant production not only includes transpiration but also evaporation from the surface of substrates. The total loss of water through evaporation from substrate and transpiration is called evapotranspiration (ET). Constantly maintaining an appropriate water potential of the substrate is critical in foliage plant production. DaMatta et al. (2002) reported that net photosynthetic rate of containerized *Coffea canephora* grown under water stress [substrate water potential at -2.14 MPa] decreased 68% compared to the control plants grown under no water stress (water potential at -0.07 MPa). Klock-Moore and Broschat (2001) reported that shoot dry weights of areca palm (*Chrysalidocarpus lutescens*) and *Philodendron* 'Hope' grown in a subirrigation system and watered every two days were 57% and 32% less, respectively, than those watered daily. Water use efficiency of *Spathiphyllum* varies among cultivars and may change with developmental stages (Wang and Chen 2003). *Ananas comosus* and *Peperomia obtusifolia* under conditions of water stress shift from C_3 (Calvin cycle) to CAM and back to C_3 when the stress is removed (Kluge and Ting 1978). These have been denominated facultative CAM plants; CAM is a metabolic sequence related to adaptation to arid environment.

A great amount of information is available about plant-water relations (Kramer and Boyer 1995; Javot and Maurel 2002; Medrano et al. 2002; Sperry et al. 2002). Both chemical and hydraulic signals are currently proposed in regulation of stomatal conductance and leaf growth of field-grown crops. At mild soil water deficit, chemical signals, primarily abscisic acid (ABA), are produced in roots and transported via xylem to the shoot; ABA perceived at the guard cell is considered an essential regulating factor in stomatal closure under the mild water

stress (Comstock 2002). When soil water deficits become more severe, hydraulic signals for the change of hydraulic pressure become significant. This triggers de novo synthesis of ABA in the leaves and may add to control of the plant physiological response to drought by reducing leaf growth (Liu et al. 2003). However, little is known about biochemical and physiological responses of foliage plants to water stress, even though some foliage plants such as bromeliads, succulent plants, and plants with underground structures such as *Calathea*, *Chlorophytum*, and *Zamioculcas* have unique characteristics for water relationship research. One reason for this information deficiency may be because research efforts have largely been focused on the development of irrigation systems for proper watering.

Irrigation systems used for foliage plant production can be generally divided into surface irrigation and subirrigation (Chen et al. 2001c). Surface irrigation includes overhead and microirrigation. Overhead irrigation sprays water over the entire bed area from nozzles that are located above the crop canopy. Microirrigation is a class of irrigation nozzles that drip, spray, or sprinkle water directly into pots. Subirrigation includes ebb-and-flow and capillary mat irrigation. In ebb-and-flow systems, plants are grown on grooved ebb-and-flow trays, flooded to about 2.5 cm in depth, and allowed to absorb the solution by capillarity for a few minutes. Then, the solution is drained back to storage tanks. In the capillary system, plants are placed on benches covered with an absorbent mat. The mat is kept moist with water or fertilizer solution, and containers on the mat absorb water or nutrient solution by capillary action. Surface irrigation can lead to water leaching through containers or becoming runoff between containers or both. Subirrigation recycles irrigation water and ensures zero runoff in a well-maintained system.

Groundwater is the primary source for irrigating foliage plants. In general, a water source with the following chemical properties is considered to be of acceptable quality for foliage plant production: alkalinity ($\leq 100 \text{ mg L}^{-1}$), electrical conductivity ($< 0.5 \text{ dS m}^{-1}$), pH (5 to 7), turbidity less than 1.5 ntu, $\text{NH}_4^+\text{-N}$, $\text{NO}_3\text{-N}$, P, and SO_4 ($< 5 \text{ mg L}^{-1}$), Cl ($< 140 \text{ mg L}^{-1}$), Ca ($< 120 \text{ mg L}^{-1}$), Mg ($< 24 \text{ mg L}^{-1}$), fluoride (0.5 mg L^{-1}), and sodium (50 mg L^{-1}) (Argo et al. 1997; Chen et al. 2003a; Nelson 2003). However, if plants are irrigated via an overhead system, hard (containing calcium and magnesium greater than 50 mg L^{-1}) or alkaline (pH above 7) water can leave residue deposits on the leaves, which reduces plant aesthetics. In addition, hard water is not suitable for irrigating tank bromeliads such as *Aechmea*, *Guzmania*, and *Neoregelia*, because residue build up in the cup or vase reduces their market value. Artifi-

cially softened water cannot be used for tank bromeliads, as sodium concentrations may become toxic.

Several approaches exist in making irrigation decisions for foliage plants: (1) look-and-feel, (2) timer-based method, (3) sensor-based irrigation, and (4) model-based methods (Heinrich 1996; Nelson 2003). The look-and-feel method is based on the experience of the greenhouse manager who inspects each bench daily and makes decisions on the irrigation frequency, volume, and time for individual benches or crops. The timer-based irrigation involves using analog or digital timers to program when to irrigate, how long to irrigate, or both. The sensor-based irrigation involves the use of a sensor such as the tensiometer, which is inserted into the container substrate with the low- and high-tension set points usually at 1 to 5 kPa. The high-tension set point represents the tension at which irrigation is initiated until it reaches the low-tension set point, then the irrigation stops. The model-based control includes the use of the vapor pressure deficit (VPD) principle. The VPD system calculates VPD values every 10 seconds and adds these values to determine the cumulative VPD. The cumulative VPD at which irrigation should occur differs with stage of plant growth.

C. Nutrient Management

Growth and development of plants require 17 elements: C, H, O, N, P, K, Ca, Mg, S, Fe, Cu, Zn, Mn, Mo, Ni, B, and Cl; C, H, and O are obtained from either air or water, and the remainder are absorbed mainly by plant roots from container substrates. Based on the quantity of the elements in plant tissue, N, P, K, Ca, Mg, and S are considered as macroelements or macronutrients, whereas the rest, except for C, H, and O, are referred to as microelements or micronutrients. Other elements that may be beneficial to some foliage plant species include Si and Na. Chen et al. (2000) reported that 32 of 39 evaluated foliage plant species were able to absorb Si, with large quantities transported to shoots. Of the 32 Si-responsive species, 17 showed significant dry weight increases with the addition of Si, whereas the other 15 absorbed and translocated Si but exhibited no apparent growth responses. The seven non-responsive plant species showed no significant increase in Si absorption, and translocation, or dry weight. In a hydroponic culture study of pothos (*Epipremnum aureum* 'Golden Pothos'), Chen et al. (2001e) found that dry weights of the pothos grown in a solution containing K and Na, both at 0.5 mM, were comparable to those grown in solutions containing 1.0 mM K only. Na concentration reached up to 1% in leaf tissue, as Na partly substitutes

for K in old leaves. This substitution allowed more K to move to the young and expanding leaves.

Two types of fertilizer have been widely used in foliage plant production: water-soluble fertilizers (WSF) and controlled-release fertilizers (CRF). These fertilizers have different ratios of N, P, and K supplemented with other elements (Nelson 2003; Trenkel 1997). The WSF is applied through fertigation, i.e., fertilizer is added to irrigation water and applied via overhead, microirrigation, or subirrigation. Water-soluble fertilizers can also be incorporated into the container substrate before transplanting. Methods of CRF applications include the incorporation of granular fertilizers into container substrates or the broadcast onto the surface of container substrates. It is a common practice to supplement CRF application with WSF. Additionally, individual chemicals, such as calcium nitrate, potassium nitrate, Epsom salts, or mixtures of micronutrients, such as Pro-Max (ProSol, Inc., Ozark, Alabama) and MicroMax (The Scotts Co., Marysville, Ohio), are often applied to substrates to prevent nutrient deficiencies. Extensive research on different rates of WSF and CRF and their effect on both quality and dry weights of foliage plants has been conducted (Conover and Poole 1972, 1974a,b, 1986; Poole and Conover 1977, 1981b; Joiner et al. 1983; Henny 1988). These studies determined that fertilizers with an $N:P_2O_5:K_2O$ ratio of approximately 3:1:2 (N:P:K ratio of 3:0.44:1.66) produce the best foliage plants when peat-based substrates are used (Conover 1992). The reader is referred to Joiner et al. (1983) and Conover (1992) for recommended N, P, and K rates for the production of major foliage plant genera.

Nutrition-related growth disorders sometimes occur when different genera, species, and cultivars are cropped under the same fertilization program. Additionally, improper irrigation practices, spray applications of pesticides and other chemicals, and abrupt environmental changes may induce or exacerbate these nutrient disorders. Three methods have been used for monitoring the nutrient status of foliage plants.

1. Visual Diagnosis. All plants share general nutrient deficiency and toxicity symptoms as indicated by Marschner (1995) and Mengel et al. (2001). Commonly encountered nutritional disorders in foliage plants have been documented by Chase (1997), Griffith (2002), and Henley (1983). Visual diagnosis is a method of dealing with disorders that have occurred; only early detection followed by effective measures can stop symptom development and/or potentially correct the disorders. Plant

nitrogen levels can also be estimated using a SPAD-502 chlorophyll meter (Minolta Co., Japan), which provides an immediate nondestructive detection of leaf nitrogen status, thus providing a tool for early detection of potential nitrogen deficiency problems (Wang et al. 2004).

2. Substrate Testing. Nursery substrate testing involves extracting root-zone solutions and analyzing concentration of available nutrient elements, pH, and soluble salts. The results are then compared to recommended ranges (Nelson 2003) to determine if the levels of nutrient elements, pH, and total salts are appropriate. Four procedures have been used for root-zone solution extraction of containerized plants: the 1:2 dilution, the 1:5 dilution, the pour through, and the saturated-paste methods (Yeager et al. 1983; Lang 1996; Huang et al. 2000). Two methods were developed for extracting root-zone solution of plug trays: press extraction (Scoggins et al. 2000) and multi-cavity collection method (MCC) (Huang et al. 2001). Substrate pH was found to be independent of extraction methods (Huang et al. 2000, 2001). However, soluble salts and mineral element concentrations vary with the method used for solution extraction (Huang et al. 2000; Yeager et al. 1983). Thus, interpretation of substrate testing should specify which extraction method is used for the root-zone solution extraction.

3. Foliar Analysis. Representative leaves are sampled and analyzed to determine the concentration of those elements of greatest interest to the grower. The analytical results are then compared to established concentration ranges of optimally fertilized plants (Table 2.4).

Over-fertilization with N-P-K commonly occurs during foliage plant production and the escalating soluble salt levels may create deficiencies of other required nutrients, particularly minor elements. Leaching or runoff of nutrients, particularly nitrate nitrogen, may create environmental problems (see Section D for detail). High soluble salts can also lead to physiological drought and reduce the plant growth rate or in extreme cases cause both root and leaf injury or death. Magnesium deficiency frequently occurs in *Aglaonema*, *Anthurium*, *Spathiphyllum*, and *Philodendron*; iron deficiency in *Aglaonema*, *Dracaena*, and *Spathiphyllum*; and copper deficiency in *Aglaonema* (Poole and Conover 1979). Common toxicities include boron and fluoride in *Dracaena* and *Chlorophytum* (Poole and Conover 1975) and sodium in *Anthurium*, *Maranta*, *Monstera*, and *Philodendron*.

Table 2.4. Concentration ranges of mineral elements in shoots of high quality foliage plants. Data are compiled from Poole et al. (1976), Joiner et al. (1983), Mills and Jones (1996), and J. Chen (unpubl. data) with modification.

Family	Genus	Concentration ranges (%)						Concentration ranges mg L ⁻¹			
		N	P	K	Ca	Mg	S	Cu	Mn	Zn	B
Acanthaceae	<i>Aphelandra</i>	2.0–3.0	0.2–0.4	1.0–2.0	0.4–2.0	0.5–1.0	0.2–0.3	15–50	50–300	20–200	35–50
	<i>Fittonia</i>	2.0–4.0	0.2–0.8	2.5–5.0	1.5–2.5	1.0–2.0	0.2–0.5	10–50	80–150	30–60	15–40
Agavaceae	<i>Cordyline</i>	2.0–3.5	0.4–0.9	2.0–4.0	1.0–2.5	0.5–1.0	0.3–0.5	5–12	20–110	44–131	15–50
	<i>Dracaena</i>	2.0–5.0	0.2–0.8	2.5–4.5	1.0–2.5	0.5–1.0	0.2–0.7	5–50	40–300	15–250	15–55
	<i>Sansevieria</i>	2.0–4.5	0.2–0.6	2.0–4.5	1.0–2.5	0.5–1.5	0.2–0.5	4–40	11–440	25–200	7.0–50
	<i>Yucca</i>	1.5–2.5	0.2–0.8	1.0–3.0	1.0–2.5	0.2–1.0	0.2–0.8	6–25	40–325	20–200	12–60
Araceae	<i>Aglaonema</i>	2.5–4.0	0.2–0.8	1.5–6.5	1.0–2.0	0.5–1.0	0.2–0.5	7–25	50–300	20–200	20–75
	<i>Alocasia</i>	2.5–3.5	0.2–0.5	1.5–3.0	1.5–2.5	0.5–1.0	0.2–0.5	6–15	50–200	30–100	20–50
	<i>Anthurium</i>	2.0–4.5	0.2–0.5	2.0–5.0	1.5–2.5	0.5–1.0	0.2–0.8	6–40	50–500	20–200	25–125
	<i>Dieffenbachia</i>	2.5–4.0	0.2–0.8	2.5–5.0	1.0–2.5	0.5–1.0	0.2–0.5	6–30	50–300	40–200	15–45
	<i>Epipremnum</i>	2.5–4.0	0.2–0.5	2.5–7.0	1.0–2.0	0.5–1.0	0.2–0.4	6–25	50–300	20–150	20–60
	<i>Monstera</i>	2.5–5.0	0.2–0.4	2.5–4.5	0.5–2.5	0.2–0.6	0.2–0.5	7–40	40–450	25–200	15–60
	<i>Philodendron</i>	2.0–5.0	0.2–0.6	2.0–6.0	0.5–2.5	0.5–1.0	0.2–0.6	6–50	40–300	20–200	10–75
	<i>Spathiphyllum</i>	3.3–5.0	0.2–1.0	2.5–6.0	0.8–2.0	0.2–1.0	0.2–0.5	6–40	40–300	25–200	20–70
	<i>Syngonium</i>	2.5–4.0	0.2–0.8	3.0–6.5	0.5–1.5	0.3–0.7	0.2–0.5	10–50	50–300	25–150	25–50
Araliaceae	<i>Hedera</i>	2.5–4.5	0.2–1.0	1.5–4.5	1.0–2.0	0.2–0.7	0.2–0.5	5–25	50–200	20–100	20–50
	<i>Schefflera</i>	2.5–4.0	0.2–0.5	2.5–4.0	1.0–2.0	0.5–1.0	0.2–0.8	5–40	40–300	25–200	20–75
Begoniaceae	<i>Begonia</i>	2.7–5.0	0.3–1.0	1.5–6.0	1.0–2.5	0.6–1.5	0.3–0.6	5–33	43–99	27–76	31–55
Bromeliaceae	<i>Aechmea</i>	1.5–2.0	0.4–0.7	1.5–2.5	0.5–1.0	0.4–0.8	0.2–0.3	6–25	50–300	25–200	25–60
	<i>Guzmania</i>	1.0–2.0	0.2–0.5	2.0–3.5	0.5–1.0	0.2–0.5	0.2–0.4	5–15	45–85	35–250	10–20

Compositae	<i>Gynura</i>	3.0–4.0	0.5–0.8	4.0–5.0	1.0–2.0	0.5–1.0	0.3–0.5	8–14	192–239	34–48	41–62
Euphorbiaceae	<i>Codiaeum</i>	2.0–5.0	0.2–0.5	2.5–5.5	1.0–2.5	0.4–1.0	0.1–0.5	5–50	25–315	20–150	16–75
	<i>Saintpaulia</i>	2.5–6.0	0.3–1.5	3.0–6.5	1.0–2.0	0.4–0.8	0.3–0.7	6–40	25–200	25–250	25–100
Liliaceae	<i>Chlorophytum</i>	1.5–3.0	0.2–0.5	2.5–5.0	1.0–2.0	0.5–1.5	0.2–0.5	4–25	50–80	25–200	25–45
Marantaceae	<i>Calathea</i>	2.0–4.0	0.2–0.7	2.0–5.0	0.2–1.5	0.3–0.8	0.2–0.4	6–50	30–200	20–200	18–50
	<i>Maranta</i>	2.0–3.0	0.2–0.5	2.0–5.5	0.5–1.5	0.2–1.0	0.2–0.5	7–40	50–200	20–200	25–50
Moraceae	<i>Ficus</i>	1.3–3.5	0.1–0.5	1.0–3.5	1.0–2.5	0.5–1.0	0.1–0.5	4–25	20–200	15–200	20–75
Palmae	<i>Chamaedorea</i>	2.5–3.5	0.2–0.4	1.0–3.0	1.0–1.5	0.4–0.8	0.2–0.4	6–50	50–250	25–200	25–60
	<i>Chrysalidocarpus</i>	2.0–3.0	0.2–0.4	1.5–2.5	1.0–1.5	0.2–0.5	0.2–0.7	1–10	27–165	20–200	19–54
	<i>Howea</i>	2.1–2.8	0.2–0.4	1.3–2.5	0.4–1.5	0.2–0.4	0.2–0.8	1–10	27–165	20–200	19–54
	<i>Phoenix</i>	1.8–2.8	0.2–0.4	1.2–2.5	0.3–1.5	0.2–0.4	0.2–0.5	4–20	25–200	15–125	10–30
	<i>Rhapis</i>	1.8–2.8	0.2–0.8	1.5–2.5	0.4–1.0	0.2–0.4	0.2–0.8	7–25	50–250	20–200	16–75
Piperaceae	<i>Peperomia</i>	1.5–4.5	0.2–1.0	2.0–8.0	0.5–4.0	0.2–1.5	0.2–0.8	4–40	47–310	14–200	23–50
Polypodiaceae	<i>Adiantum</i>	1.5–2.5	0.4–0.8	2.0–3.0	0.2–0.5	0.2–0.4	0.2–0.4	5–20	25–100	15–100	20–50
	<i>Asparagus</i>	1.5–2.5	0.3–0.5	2.0–3.0	0.5–1.0	0.2–0.5	0.2–0.3	5–30	40–30	25–200	30–150
	<i>Asplenium</i>	1.5–3.5	0.3–0.5	2.5–4.5	0.5–1.0	0.3–0.5	0.2–0.4	3–20	27–300	20–100	15–50
	<i>Nephrolepis</i>	2.0–3.0	0.3–0.7	1.5–3.5	0.4–2.5	0.2–1.0	0.2–0.5	6–30	30–200	30–65	20–70
	<i>Pteris</i>	2.0–3.0	0.2–0.3	1.0–2.0	1.0–2.0	0.2–0.5	0.2–0.4	5–30	70–300	25–150	20–30
Rubiaceae	<i>Coffea</i>	2.5–3.5	0.2–0.5	2.0–3.0	0.5–1.5	0.3–0.5	0.3–0.5	10–50	50–300	15–200	25–75

D. Environmental Concerns over Water and Nutrient Management

Foliage plant production, like other containerized plant production, is intensive agriculture. Typically, 100,000 to 800,000 containerized plants are produced per hectare, with 1,500 to 2,500 kg ha⁻¹ of nitrogen and 1,883 to 6,276 mm ha⁻¹ of potable water being applied annually (Harrison 1976; Lang and Pannkuk 1998). Depending on irrigation methods and volume applied, only 15% to 85% of surfaced-applied irrigation water enters or is retained in containers (Beeson and Knox 1991). Weatherspoon and Harrell (1980) reported that 74% of the water applied through overhead irrigation fell outside the containers, missing the containers completely. Neal and Henley (1992) showed that 50% of overhead irrigation in a greenhouse either leached through containers or missed the containers. The combination of excessive irrigation, over fertilization, and highly permeable container substrates leads to leaching and/or runoff of up to 50% of applied fertilizers, predominantly nitrate-nitrogen (Broschat 1995; Ku and Hershey 1997). Conover et al. (1994) reported that a total of 304 and 589 mg of nitrate-N were leached per 1.6-liter container during a 13-week production of *Dieffenbachia* 'Camille' watered three times a week when CRF Osmocote (19N-2.6P-10K) was applied at 4 and 8 g per container, respectively. One hectare of foliage plant production area may have up to 107,487 1.6-liter containers in a continuous production cycle. This means 130 to 253 kg of nitrate-N could be leached from each hectare yearly, which may potentially cause surface and ground water contamination. Consequently, efficient use of potable water and fertilizers to preserve freshwater resources is a major concern of containerized nursery firms (Lea-Cox and Ross 2001).

A draft for national measures to control non-point source pollution from agriculture was published in the Federal Register in October 2000 by the Environmental Protection Agency (EPA) (Lea-Cox and Ross 2001). This EPA proposal broadens the focus of the law on the overall quality of a body of water and actually requires each state to set a limit, called "total maximum daily load," for each body of water. States would be forced to reduce "non-source" pollution such as NO₃-N from more diffuse sources, including agricultural and urban runoff. Consequently, containerized plant growers should be aware of the trend toward increasingly stringent pollution prevention ordinances. Chen et al. (2001c) proposed an integrated approach to the nutrient and irrigation problems for the containerized plant industry, which includes applying fertilizers

based on plant species need, improving container substrates' nutrient- and water-holding capacity, using controlled-release fertilizers, and implementing zero runoff irrigation or fertigation delivery systems.

Research on N requirements of individual foliage plant genera has showed that application of N based on their optimal N rates can reduce N use by at least 20% of previously recommended rates (Chen et al. 2001c). Zeolite-amended container substrates were shown to reduce nutrient leaching (Broschat 2001; Chen et al. 2001c). Chen et al. (2001c) reported that zeolite amendments to container substrates reduced nutrient leaching including N and P, buffered pH, and increased water-holding capacity. Plants grown in zeolite-amended substrates were equal or superior to controls. Container substrates fertilized with CRF typically have less nitrate-N leaching than those fertilized with WSF. Broschat (1995) compared total $\text{NO}_3\text{-N}$ leached per container over a six-month period and found that substrates fertilized with CRF leached 28% to 40% less $\text{NO}_3\text{-N}$ than those fertilized with WSF. As water and fertilizer are interrelated in containerized plant production, one promising way to avoid N runoff or leaching into surface or ground water is to use zero runoff subirrigation. Newly constructed foliage nurseries are adopting either ebb-and-flow or capillary mat irrigation. These systems can reduce fertilizer use by 20% and water use up to 75% and eliminate nutrient leaching and runoff during production. Another irrigation system that can achieve minimal runoff and reduce salt buildup in substrates is a surface irrigation system that captures, retains, and recycles the runoff and stormwater within the boundaries of the production facility. This whole greenhouse-nursery recycling system is called the total nursery recycling system (Skimina 1986), which includes: (1) stormwater and/or irrigation runoff collection; (2) sedimentation, flocculation, filtration, and disinfection treatments, if necessary; and (3) an irrigation system. Chen et al. (2003a) evaluated a total of 30 container-grown plant species (22 foliage plants and 8 bedding plants) using water collected from rain and/or irrigation runoff against well water under ebb-and-flow and overhead-irrigation systems. All plants at the time of harvest were of marketable sizes and salable quality independent of water sources. No disease incidences or growth disorders related to water sources were observed. Results indicated that rain and/or irrigation runoff can be an alternative source of water for irrigation of greenhouse containerized plants (Chen and Beeson 2004). The total nursery recycling system has the advantages of (1) being simple and affordable, (2) having zero runoff, (3) water conservation, (4) nutrient recycling, and (5) the production of high-quality plants.

E. Growth Regulator Application

The use of plant growth regulators (PGR) is focused on four aspects of foliage plant growth and development: (1) plant size control (i.e., height or vine length), (2) induction of additional lateral or basal shoots, (3) induction of flowering, and (4) improvement of interior performance. Most early research focused on growth retardants (McConnell and Poole 1981), but, more recently, there is a significant body of information regarding use of growth regulators to stimulate branching, especially in conjunction with tissue culture liner production, and chemical induction of flowering for foliage plant breeding work (Henny 2001).

Dieffenbachia, *Epipremnum*, *Ficus*, *Hoya*, *Hypoestes*, *Nephrolepis*, *Peperomia*, *Plectranthus*, *Schefflera*, *Syngonium*, and *Zebrina* are often treated with paclobutrazol (Bonzi[®]) or uniconazole (Sumagic[®]) to shorten internodes and darken the leaves (Wang and Blessington 1990; Foley and Keever 1992; Hagiladi and Watad 1992; Wang and Gregg, 1994; Conover and Satterthwaite 1996). Potential users of these chemicals should be aware that they are active at very low rates. Little margin for error exists when selecting chemical concentration or method of application. It is imperative to apply the correct amount of chemical in the appropriate location at the right time or few benefits will be realized. A small number of test plants should be treated and evaluated before treating an entire crop.

Chemicals that promote lateral or basal branching are of most interest to foliage growers since well-branched propagules allow use of fewer plants per container, thus reducing costs. Tissue culture laboratories often treat newly rooted cuttings with the synthetic cytokinin N⁶-benzyladenine (BA) to stimulate better branching. Treating small material allows more uniform coverage and less cost per treated plant. BA is usually limited to liners in cell trays or plants in 5-, 8-, or 10-cm containers. BA treatment of *Anthurium*, *Dieffenbachia*, *Peperomia*, *Spathiphyllum*, and *Syngonium* results in better-branched and shorter plants.

Two chemicals frequently studied for their effect on flowering of foliage plants are gibberellic acid (GA₃) (Henny 1995; Chen et al. 2003b) and ethephon (Florel[®]). Research on flowering of foliage plants is primarily useful to breeding programs since the flowers of tropical plants, such as *Aglaonema*, *Caladium*, and *Dieffenbachia*, have little or no ornamental value. However, *Spathiphyllum* and bromeliads, which are induced to flower with GA₃ and ethephon treatments, respectively, produce attractive inflorescences that improve year-round marketability.

Established *Spathiphyllum* plants sprayed with a 250 mg L⁻¹ solution of GA₃ routinely flower within 11 to 15 weeks after treatment depending on season of the year. However, floral distortion, consisting of distorted spathes and spadices and crooked peduncles, has been reported in some GA₃-treated *Spathiphyllum*, and percentage of distorted flowers differed significantly among cultivars (Henny et al. 1981). The amount of distortion appears to be dependent on the chemical concentration applied, as more recent studies have shown that a lower GA₃ rate of 100 mg L⁻¹ is equally effective in inducing flowering of *Spathiphyllum* with less floral distortion than the 250 mg L⁻¹ rate (Henny and Chen 2000).

Bromeliads can be induced to flower by treating them with compounds that emit ethylene such as Florel®. Crops can be sprayed at different times of the year to ensure salable plants in spike or in color at desired seasons or to produce flowers for breeding. Ethylene compounds can be applied at a rate of approximately 2,500 ppm. Treated plants should flower about two months after treatment (Griffith 1998). Recent research has uncovered an alternative use for ethephon. Chen et al. (2002a) demonstrated that application of ethephon at 250 to 1,000 mg L⁻¹ twice in March at a two-week interval inhibited flowering of *Gynura aurantiaca*. *Gynura aurantiaca*, commonly known as Purple Passion Plant, produces seasonal yellow flowers with an unpleasant blossom odor. Ethephon prevented inflorescence development and promoted branching, thus the marketability of this plant was greatly enhanced.

Ancymidol (A-Rest™) has been shown to improve the interior performance of *Ficus*, *Peperomia*, *Pilea*, and *Sedum*, and BA improved the long-term dark storage of *Dieffenbachia* (Davis et al. 1988; Poole and Conover 1993). Application of PGR to foliage plants before placement in interior conditions may reduce plant growth indoors and maintain aesthetic appearance. For example, many *Dieffenbachia* cultivars become “leggy” indoors due to extended internode elongation. Pennisi et al. (2003) found that application of paclobutrazol at the end of the production cycle of *Dieffenbachia* ‘Panther’ and ‘Camouflage’ suppressed internode elongation and maintained compact appearance under an interior light level of 16 μmol m⁻² s⁻¹ for seven months. More research on PGR application and their effects on shipping and interior performance is needed as PGR could induce a prolonged dormant period that would maintain plants’ aesthetic appearance in low light interior locations and increase the time interval between plant replacement. Environmental Protection Agency (EPA) clearance and product label information should be checked before applying any of the chemicals mentioned above.

F. Pest Management

The term *pests* here refers to plant pathogens, insects, mites, and nematodes that damage foliage plants. Although there are no statistical data available on total economic losses attributed to pests, pest damage has been an important problem in foliage plant production.

1. Diseases. Commonly occurring bacterial, fungal, and virus diseases in foliage plants were first summarized by Knause et al. (1981). Later, Chase (1997) contributed a more complete treatise *Foliage Plant Diseases: Diagnosis and Control*, which documented foliage plant diseases with special emphasis on symptoms recognition via color photographs and also provided the cause of each disease accompanied with methods of control. Among the pathogens listed, four fungi (*Rhizoctonia*, *Phytophthora*, *Pythium*, and *Cylindrocladium*) and one bacterium (*Xanthomonas*) cause the most common diseases in the foliage plant industry. Norman (2003) and Norman and Henny (1999) covered disease symptoms and corresponding control methods of these pathogens.

2. Insects. Major foliage plant insects are aphids, mealybugs, scale, and thrips (Hamlen et al. 1981; Baker 1994). Aphids are small, soft-bodied insects that suck plant juices, causing growth reduction, leaf chlorosis, curl, or drop. Green peach aphid (*Myzus persicae*) and melon (or cotton) aphid (*Aphis gossypii*) are two common species infesting foliage plants including *Aphelandra*, *Schefflera*, *Dieffenbachia*, *Gynura*, and *Hoya* (Hamlen et al. 1981). Reduced-risk pesticides such as azadirachtin, fenoxycarb, imidacloprid, kinoprene, and pyridaben can be used for aphid control (Dreistadt 2001; Osborne et al. 2001). Reduced-risk pesticides are a group of pesticides that the EPA has deemed to pose significantly less risk than many of the pesticides that are in common use. Characteristics of this group of pesticides include low toxicity to non-target organisms, low application rates, better worker safety, and less potential for development of pest resistance. Reduced-risk pesticides have received accelerated registration approval by the EPA (Dreistadt 2001).

Mealybugs are slow-moving insects and feed by piercing-sucking mouthparts. Feeding can distort new growth, and infested foliage may turn yellow and then drop. Common species are long-tailed mealybugs (*Pseudococcus longispinus*), solanum mealybugs (*Phenacoccus solani*), and citrus mealybugs (*Planococcus citri*). Mealybugs can infest *Aphelandra*, *Ardisia*, *Asparagus*, *Codiaeum*, *Dieffenbachia*, *Dracaena*, *Epipremnum*, *Ficus*, *Gynura*, *Maranta*, *Nephrolepis*, and *Syngonium*

(Hamlen et al. 1981). Reduced-risk pesticides used for mealybug control include imidacloprid, kinoprene, oil, and soap (Osborne et al. 2001), with sprays at the crawler stage most effective.

Scales, characterized by small size and immobility during most of the life cycle, are easily overlooked. Scales feed by sucking plant juices, resulting in distorted new growth, leaf yellowing, and leaf drop. There are two principal groups of scales: the armored (hard-bodied) and the unarmored (soft-bodied). Fern scale (*Pseudaulacaspis cockerlli*) is an armored one, damaging *Adiantum*, *Asparagus*, and *Nephrolepis exaltata*. Japanese wax scale (*Ceroplastes ceriferus*) is an unarmored one and can infest *Ficus* and *Podocarpus*. Reduced-risk pesticides including buprofezin, imidacloprid, kinoprene, and pyridaben can be used to control scales (Dreistadt 2001). Since the crawler stage has the greatest susceptibility to insecticides, monitoring developmental stages and spraying at the crawler stage with thorough coverage is the most effective treatment.

Thrips include western flower thrips (*Frankliniella occidentalis*) and banded greenhouse thrips (*Hercinothrips femoralis*). Thrips feed on flower buds and unfurled leaves, and the damage does not become visible until flowers open or leaves expand (Chen et al. 2001d). Damaged tissue becomes stippled, blotched, streaked, or deformed. Western flower thrips spread impatiens necrotic spot virus and several strains of tomato spotted wilt virus, and both viruses can infect foliage plants. Banded greenhouse thrips can infest *Aglaonema*, *Anthurium*, *Aphelandra*, *Ardisia*, *Schefflera*, *Dieffenbachia*, *Philodendron*, and *Syngonium*. Chemical control of thrips is difficult, as eggs are imbedded in tissue, larvae live in developing terminal leaves or buds, and pupae are found in container substrates protected from sprays. Drenching the substrate with systemic insecticides can reduce the thrips populations.

3. Mites. Mites are arachnids, belonging to the same class as spiders and ticks. Mites puncture plant cells with their mouthparts and suck the exuding fluid, which causes plant tissue to discolor or distort. Twospotted spider mites (*Tetranychus urticae*) are among the most common and destructive mites that infest *Calathea*, *Chamaedorea*, *Chrysalidocarpus*, *Cissus*, *Codiaeum*, *Cordyline*, *Dieffenbachia*, *Dracaena*, *Hedera*, and *Maranta*. The broad mite (*Polyphagotarsonemus latus*) and cyclamen mite (*Steneotarsonemus pallidus*) are microscopic mites. The broad mite often infests *Aphelandra*, *Episcia*, *Fatsia*, and *Hedera*, and the cyclamen mite infests *Begonia*, *Crassula*, *Gynura*, *Pilea*, and *Saintpaulia*. False spider mites include *Brevipalpus californicus*, *B. obovatus*, *B. phoenicis*, and *B. russulus*. Infestation of false spider mites can be severe

on *Aphelandra*, *Columnea*, *Hedera*, *Peperomia*, and various ornamental cacti (Hamlen et al. 1981). Abamectin, cinnamaldehyde, and pyridaben are botanicals or insect growth regulators that function as reduced-risk pesticides and are effective in controlling mites (Dreistadt 2001; Osborne et al. 2001).

4. Parasitic Nematodes. Information about parasitic nematodes is limited. Hamlen et al. (1981) summarized nematodes of major importance to foliage plants. These include root knot nematodes (*Meloidogyne javanica*, *M. incognita*, *M. arenaria*), cactus cyst nematode (*Heterodera cacti*), root lesion nematodes (*Pratylenchus penetrans*, *P. brachyurus*, *P. coffeae*, and *P. zaeae*), and burrowing nematode (*Radopholus similis*). Foliage plants susceptible to infection by root knot nematodes include *Ardisia*, *Asparagus*, *Schefflera*, *Calathea*, *Chamaedorea*, *Dieffenbachia*, *Maranta*, and *Sansevieria*. Species of the Cactaceae are susceptible to cactus cyst nematodes. *Aglaonema*, *Ananas comosus*, *Begonia*, and *Chamaedorea* are often damaged by root lesion nematodes. Burrowing nematode can infect *Anthurium*, *Calathea*, *Chamaedorea*, *Dieffenbachia*, *Monstera*, and *Philodendron* (Wang et al. 1997). Chemical control with nematicides is not favored, as most of the chemicals are relatively toxic and potentially hazardous to people, pets, and other animals if handled carelessly.

5. Integrated Pest Management (IPM). During the 1970s and early 1980s, plants in commercial production facilities were routinely sprayed or drenched with pesticides as a preventive measure regardless of the pest presence in greenhouses. Environmental concerns over pesticide use, increasing chemical costs, and applicator and consumer safety issues gave rise to the IPM concept, a strategy that avoids or prevents pest damage with minimum adverse impact on human health, the environment, and nontarget organisms (Pedigo 1999; Dreistadt 2001). The axiom of IPM is that prevention is better than a cure. Prevention includes the use of pest-resistant cultivars, good sanitation, regulation of environmental conditions such as temperature and humidity to levels not favored for pest development, and sound cultural practices, such as fertilization and irrigation, based on plant needs. Understanding the biology of pests is crucially important for an IPM program. For example, the crawler is the stage of mealybugs and scales most susceptible to insecticides; sprays used at this time are most effective. Scouting or careful monitoring is another IPM principle. Timely detection of pests and accurate assessment of population densities of pests and their natural enemies are fundamental to IPM decision-making. Yellow sticky cards placed near

plants will quickly indicate the presence of pests, such as whiteflies, aphids, or thrips. Low pest populations are easier to control, and detection should be followed closely with an appropriate management tactic when necessary to prevent pest outbreaks. If pesticide use is necessary, pest-specific and reduced-risk pesticides should be used whenever possible and broad-spectrum pesticides should be avoided. Lack of pest monitoring, and poorly timed or regularly scheduled treatments may be ineffective at controlling the target pest or may kill natural enemies. Growers are increasingly adopting the IPM principles and practices in foliage plant production, which not only reduce the use of broad-spectrum pesticides but also provide to consumers environmental friendly products.

G. Acclimatization

Acclimatization refers to the physiological adaptation of plants to changes in climate or environment such as light, temperature, and altitude, which, to some extent, is similar to acclimation. The two terms, however, differ in two aspects: (1) acclimation is the homeostatic response to a single well-defined stress (e.g., low temperature), while acclimatization is the homeostatic response to complex changes in multiple environmental parameters (Lambers et al. 1998) and (2) acclimation emphasizes plant response in situ, while acclimatization emphasizes adaption to a changed environment with active involvement of humans (Conover and Poole 1984). Therefore, acclimatization has been widely used in the foliage plant industry. Foliage plant acclimatization is a seriate procedure in which light intensity, nutrient supply, and irrigation frequency may be reduced and/or other factors, such as temperature, relative humidity, container substrate components, and the use of growth regulators, pesticides, and fungicides, may be altered to allow plants to become conditioned before being placed in interior environments (Conover and Poole 1984; Chen et al. 2001b). Among these factors, light plays the most important role, followed by nutrition, irrigation, temperature, and others. There are two general methods for acclimatizing foliage plants in production. One is to grow liners or rooted cuttings under optimum light, nutrient, water, and temperature levels to near-finished sizes, then shift plants to reduced light levels with decreased nutrient and water supplies for at least a month before the postproduction phase. The other is to initially grow liners under reduced light levels and correspondingly reduced nutrient and water supplies until marketable sizes are reached. The latter method has not been widely used by commercial growers due to increased production time,

reduced profit, and the appearance of some finished plants, particularly interior trees, which produce thin trunks.

Better interior performance of foliage plants is associated with low light-compensation points, efficiency in net CO₂ uptake, and a reduction in dark respiration (Fonteno and McWilliams 1978; Pass and Hartley 1979; Collins and Blessington 1982; Fails et al. 1982). Fails et al. (1982) found that leaves of *Ficus benjamina* grown under shade were larger, thinner, and darker green than those grown under sun. Shade-grown leaves had a single, poorly developed palisade layer with larger chloroplasts dispersed throughout the palisade cells, while sun-grown leaves had one or two layers of well-developed palisade cells with the chloroplasts aligned primarily along the radial walls. Stomatal density was greater in sun-grown leaves, but shade-grown leaves had more stomata per leaf. *Ficus benjamina* is still considered a major interior plant, but leaf yellowing and drop under interior environments remains a primary concern of customers. Lance and Guys (1992) found that chlorophyll, carotenoid, and soluble protein content increased in *Ficus benjamina* as irradiance level decreased, while Rubisco increased on a fresh weight basis but decreased on a protein basis. When transferred to an interior low light (18 $\mu\text{mol m}^{-2} \text{s}^{-1}$) environment, mature leaves exhibited increased chlorophyll and carotenoid levels regardless of previous irradiance treatment, and a large increase in enolase and pyruvate kinase activities occurred under low light conditions. Chen et al. (2004c) analyzed responses of *Ficus benjamina* 'Common', *Dieffenbachia maculata* 'Camille', and *Anthurium* \times 'Red Hot' to interior low light. The net photosynthetic rate (P_n) was established in three days after *Ficus benjamina*, initially grown under 50 $\mu\text{mol m}^{-2} \text{s}^{-1}$, was placed into an interior room under a light intensity of 16 $\mu\text{mol m}^{-2} \text{s}^{-1}$. However, it took 10 days for *Ficus* initially grown under light levels of 100 or 300 $\mu\text{mol m}^{-2} \text{s}^{-1}$ to establish a P_n . Variegated *Dieffenbachia* responded by decreasing leaf area, degree of variegation, and increasing chlorophyll contents in the yellow-white areas of leaves. Individual leaves of a flowering foliage plant, *Anthurium* \times 'Red Hot', sustained net photosynthesis rates (P_n) under interior conditions and delayed leaf senescence, thus, new leaves and new flowers were produced indoors. Changes in canopy configuration of both *Anthurium* and *Dieffenbachia* increased light interception. The varied reactions exhibited by these plants indicate that different plant types maximize their net photosynthesis rates via distinctively different anatomical and physiological responses to low light environments.

Nutrient acclimatization, i.e., reduction in fertilizer application at the end of the production cycle, is mainly aimed at the reduction of solu-

ble salt levels in the container substrate. In general, after light acclimatization, high-quality plants will perform better in interior conditions than non-acclimated plants. However, if container substrates have high soluble salt levels, even light acclimatized plants may develop necrotic lesions on leaves due to the reduced growth under interior low light conditions. Braswell et al. (1982) compared interior performance of *Schefflera actinophylla* produced with a weekly fertilization of 400 mg L⁻¹ versus 200 mg L⁻¹ N, and found that plants fertilized with higher N dropped leaves and had reduced aesthetic value after placement indoors.

V. POSTPRODUCTION

A. Grading, Packaging, and Shipping

The quality of shipped products at their destinations and their subsequent performance depends on the production quality of the plants, acclimatization treatments before shipping, proper handling during the transportation process, and appropriate control of shipping environments and duration. Acclimatized mature foliage plants are moved to a grading and packaging site where plants are groomed and graded; marketable plants are labeled and packaged. Packaging includes inserting individual containerized plants into sleeves and placement of the sleeved plants in appropriate boxes. Poole and Conover (1983) compared the quality of packaged (sleeved or sleeved and boxed) with unpackaged *Chamaedorea elegans*, *Dieffenbachia maculata*, and *Dracaena marginata* after two weeks in simulated transportation conditions and found that the packaging method had little effect on the plant quality. However, the packaging of foliage plants for shipping aids in handling plants and protects against loss of plant quality from mechanical damage. Packaged propagules and marketable plants are shipped to customers by either reefers or by air carrier. Transportable racks with shelves are used, especially for smaller pot sizes, which can be preloaded with plants in a nursery and pushed onto and off of trucks without physically handling the plants. Extra racks are left at both the pickup and delivery locations. Tissue cultured liners that grow in plug trays are shipped by placing trays in specially designed racks that can be stacked. Unrooted cuttings are usually shipped in waxed boxes with moist paper to keep humidity high.

Factors influencing shipment quality include temperature, light, humidity, ethylene levels, and shipping duration. Foliage plants are commonly shipped in the dark and under a relative humidity of 80 to 90%. Temperature and transportation duration are key factors affecting

plant quality after shipping. Recommended temperature ranges and duration for shipping are listed in Table 2.2. Additional information on shipping of foliage plants was reviewed by Blessington and Collins (1993). Temperatures below the recommended range may result in chilling injury, whereas temperatures above the recommended range may elicit ethylene buildup and provide a favorable environment for pathogen development, such as *Botrytis*. Maintaining plants within the recommended temperature range reduces the respiration rate which, in turn, conserves carbohydrates and reduces the senescence process. The quality of *Chrysalidocarpus lutescens* and *Dracaena marginata* was maintained after 21 days of simulated shipping at 13, 16, or 19°C, while *Ficus benjamina* should be shipped at 10 or 13°C and *Schefflera* at 10°C to maintain the highest level of plant quality (Conover and Poole 1984). Information regarding foliage plant sensitivity to ethylene is limited. Marousky and Harbaugh (1978) exposed a wide variety of foliage plants to 5 $\mu\text{L L}^{-1}$ ethylene for three days and observed that leaf abscission occurred in *Schefflera actinophylla*, *Crassula argentea*, *Fittonia verschaffeltii*, *Philodendron scandens oxycardium*, and *Pilea involucrata*. Foliage plants should never be shipped with fruit and vegetables that have the potential to generate large amounts of ethylene that could be detrimental to foliage plants.

B. Interiorscapes

The final destination of acclimatized foliage plants is indoor environments where they are installed as living specimens for interiorscaping or interior decoration (Fig. 2.3). The interior location could be in commercial public spaces such as airports, convention centers, hospitals, hotel lobbies, libraries, offices, and shopping malls or conservatories and residential private homes. Depending on the location of these interior environments, light intensity varies widely. For example, the light level of typical offices is 16 $\mu\text{mol m}^{-2} \text{s}^{-1}$, whereas many locations in airports have light levels approaching 95 $\mu\text{mol m}^{-2} \text{s}^{-1}$. Light intensity in living rooms may range from 2 to 150 $\mu\text{mol m}^{-2} \text{s}^{-1}$, whereas in bathrooms it may be only 2 $\mu\text{mol m}^{-2} \text{s}^{-1}$. Temperatures in most building interiors range from 20 to 24°C, and relative humidity varies from 15 to 50%. Foliage plants have to adapt to the new environmental conditions and are expected to maintain their aesthetic appearance for a prolonged time, several months to several years.

This expectation can be met by placing the right plants in the right locations and providing the plants with appropriate care. In order to know a plant's adaptability to interior conditions, foliage plant species

and cultivars are evaluated. Criteria designed for evaluating a plant's interior performance include a light intensity of 8 or 16 $\mu\text{mol m}^{-2} \text{s}^{-1}$ for 12 hr a day, a temperature from 20 to 24°C, relative humidity of 30 to 50%, and a CO_2 concentration of about 600 $\mu\text{l L}^{-1}$ (Chen et al. 2001b). Interior performance is evaluated using several traits, including leaf yellowing, leaf drop, loss or reduction in foliar variegation, elongation of internodes (i.e., stretching), changes in overall plant configuration or form, change in leaf or flower color, flower longevity, loss of flowering or development of physiological disorders, diseases or pests, as well as chlorophyll concentrations and photosynthetic activities. Good interior plants should be able to maintain their aesthetic appearance for at least six months after installation in an interior environment. Plant species and even cultivars vary significantly in interior performance and light-acclimated plants differ from non-acclimated plants in adaptation to low light conditions (Table 2.2). For example, *Aglaonema*, *Aspidistra elatior*, *Calathea*, *Sansevieria trifasciata*, and *Zamioculcas zamiifolia* can adapt to an interior under a light intensity of 8 $\mu\text{mol m}^{-2} \text{s}^{-1}$. This group of plants should be used in locations where light intensity is low. *Zamioculcas zamiifolia* (ZZ plant) can grow indoors under light levels as low as 4 $\mu\text{mol m}^{-2} \text{s}^{-1}$ (Chen and Henny 2002). Morphological differences between ZZ plants grown indoors under 16 $\mu\text{mol m}^{-2} \text{s}^{-1}$ or higher and 4 $\mu\text{mol m}^{-2} \text{s}^{-1}$ were that those under 4 $\mu\text{mol m}^{-2} \text{s}^{-1}$ grew slower and had smaller leaflets. However, the overall form and appearance remained aesthetically pleasing. *Ficus benjamina*, *Cordyline*, *Codiaeum*, *Dieffenbachia*, *Schefflera actinophylla*, and *Schefflera arboricola* should be installed where light intensities are no less than 15 $\mu\text{mol m}^{-2} \text{s}^{-1}$, as they require more light than the preceding plant group.

Appropriate care for interior-installed plants refers to proper nutrition, irrigation, and pest management under interior conditions. General information with regard to interior installation and maintenance is available (Blessington and Collins 1993; Snyder 1995; Manaker 1997). Interiorscape firms usually maintain foliage plants installed in commercial buildings, and plants in homes and offices may be maintained by their owners. Regardless of professional or hobbyists' care of the plants, container substrates of interior-installed plants should have a pH from 5.5 to 6.5 and soluble salts between 1.0 to 2.0 dS m^{-1} if the root-zone solution is extracted by the pour-through method (Chen et al. 2002d). Low pH should be adjusted to the correct range using basic chemicals and elevated soluble salts should be leached with water. Plant growth would not be promoted under interior low light conditions by increasing fertilizer application (Conover and Poole 1981b), rather leaf tip or margin necrotic lesions may occur due to over-fertilization. Fertilizers

can be applied only when soluble salt readings of container substrates are below 0.8 dS m^{-1} . Substrates should be kept moist with a tension of 2–5 kPa but not excessively wet with a tension of 0–1 kPa.

VI. THE FUTURE

The foliage plant industry has been enjoying its steady growth, with a wholesale value of \$663 million in 2002, an all-time high (Fig. 2.4). Commercial production of foliage plants has become truly global as rooted and unrooted cuttings, seedlings, and tissue cultured liners from the Caribbean, Central America, China, India, Korea, Thailand, the Netherlands, and elsewhere are grown in the United States and sold nationally and internationally, primarily in Canada and Europe. The future of the industry is bright, as interiorscaping with foliage plants has become an integral part of contemporary life. With increasing worldwide urbanization, interior decoration with foliage plants will continue to grow, and the foliage plant industry will face increased demand for diverse and high-quality plants.

The foliage plant industry should continuously search for new plants and accelerate the pace of new cultivar development since consumers constantly look for novel plants and new cultivars with unique characteristics. Foliage plant germplasm should be institutionally conserved and systematically evaluated in terms of their taxonomy, cytology, genetic relatedness using both classic and molecular techniques (Chen et al. 2004a,b), and potential use for interiorscaping. Attention should also be paid to those under-utilized or obscure foliage plant genera or species. Among the 120 genera listed in Table 2.1, some may have ideal characteristics to be suitable interiorscape plants. In addition to traditional breeding, transgene technology could be particularly useful to foliage plant improvement (Kuehnle et al. 2001). Transgenic foliage plants might not generate consumer reluctance for interior use since they are not a food source and would not cause genetic contamination of other crops, because most foliage plants are vegetatively propagated and do not disseminate wind-blown pollen.

Investigation of water and nutrient requirements of individual plant genera or species and determination of light, temperature, humidity, nutrient, water, and container substrates influencing photosynthesis and subsequent plant growth are critical for designing model-based environmental control systems and developing the best management practices for foliage plant production. Using genetic and molecular approaches to study interactions of pests with hosts will improve our

current integrated pest management. In addition, foliage plants are indeed unique materials for some fundamental research. Our understanding of foliage plant plasticity to light acclimatization is limited. A better understanding of how foliage plants can grow under such low interior light levels would benefit not only the foliage plant industry but also food crop production under reduced light conditions. We have no complete answers to why some *Anthurium* cultivars continue to grow and flower indoors (Chen et al. 1999) or how *Zamioculcas zamiifolia* can tolerate continuous drought for four months without watering. A better understanding of these phenomena will provide the necessary tools to increase foliage plant productivity as well as ways to improve water and nutrient management and pest control practices.

Tissue-culture propagation plays a dual role in promoting the growth of the foliage plant industry. Tissue culture has been proven to be labor and space saving, as well as an efficient propagation method for foliage plants. Using tissue culture methods, new cultivars can be increased rapidly enough to reach commercial production levels within 1–2 years instead of the 5–7 years previously required using traditional cutting or division techniques. Continuous liner production from tissue culture provides nurseries with uniform, healthy, and well-rooted liners year-round, thus increasing production. Furthermore, tissue culture has been established as a method of generating somaclonal variants. Somaclonal variants are identified, evaluated, selected, and released, providing the foliage plant industry with new cultivars (Chen et al. 2004d). In vitro methods are available for 60 of the 120 foliage plant genera mentioned in Table 2.1. Future research will undoubtedly develop methods of micropropagation for the remaining 60 genera (Qu et al. 2002) and also refine methods of producing better liners from genera that are tissue culture propagated. Emphasis should be placed on establishing reliable protocols for generating true-to-type liners to maintain the fidelity of popular cultivars in production and at the same time establishing procedures for better selection of somaclonal variants for new cultivar development.

LITERATURE CITED

- Aldrich, R. A., and J. W. Bartok. 1994. Greenhouse engineering. 3rd rev. Pub. NRAES-33. Northeast Reg. Agr. Eng. Ser., Cornell Univ., 152 Riley-Robb Hall, Ithaca, NY.
- Araus, J. L., L. Alegre, L. Tapia, R. Calafell, and M. D. Serret. 1986. Relationships between photosynthetic capacity and leaf structure in several shade plants. *Am. J. Bot.* 73:1760–1770.

- Argo, W. R., J. A. Biernbaum, and D. D. Warncke. 1997. Geographical characterization of greenhouse irrigation water. *HortTechnology* 7:49–55.
- Asada, K. 1999. The water-water cycle in chloroplasts: scavenging of active oxygen and dissipation of excess protons. *Annu. Rev. Plant Physiol. Plant Mol. Biol.* 50:601–639.
- Bailey, D. A. 1996. Alkalinity, pH, and acidification. p. 69–91. In: D. W. Reed (ed.), *Water, media, and nutrition for greenhouse crops*. Ball Pub., Batavia, IL.
- Bailey, L. H., and E. Z. Bailey. 1976. *Hortus III*. Macmillan, New York.
- Bailey, S., R. G. Walters, S. Jansson, and P. Horton. 2001. Acclimation of *Arabidopsis thaliana* to the light environment: the existence of separate low light and high light responses. *Planta* 23:794–801.
- Baker, J. R. 1994. *Insect and related pests of flowers and foliage plants*. North Carolina Cooperation Extension Service. North Carolina State Univ., Raleigh.
- Beeson, R. C. Jr., and G. W. Knox, 1991. Analysis of efficiency of overhead irrigation in container production. *HortScience* 26:848–850.
- Bequette, B. L., T. M. Blessington, and J. A. Price. 1985. Influence of lighting systematics on the interior performance of two croton cultivars. *HortScience* 20:927–931.
- Berghage, R. D., and R. D. Heins. 1991. Quantification of temperature effects on stem elongation in poinsettia. *J. Am. Soc. Hort. Sci.* 116:14–18.
- Blessington, T. M., and P. C. Collins. 1993. *Foliage plants: prolonging quality, postproduction care and handling*. Ball Pub., Batavia, IL.
- Bodnaruk, W. H. Jr., T. W. Mills, and D. L. Ingram. 1981. Response of four foliage plants to heated soil and reduced air temperatures. *Proc. Fla. State Hort. Soc.* 94:104–107.
- Boodley, J. W., and R. S. Sheldrake. 1977. *Cornell peat-lite mixes for commercial plant growing*. Cornell Plant Sci. Infor. Bul. 43.
- Braswell, J. H., T. M. Blessington, and J. A. Price. 1982. Influence of cultural practices on postharvest interior performance of two species of *Schefflera*. *HortScience* 17:345–347.
- Broschat, T. K. 1995. Nitrate, phosphate, and potassium leaching from container-grown plants fertilized by several methods. *HortScience* 30:74–77.
- Broschat, T. K. 2001. Substrate nutrient retention and growth of container-grown plants in clinoptilolitic zeolite-amended substrate. *HortTechnology* 11:75–78.
- Bunt, A. C. 1988. *Media and mixes for container-grown plants*. 2nd ed. Unwin Hyman Ltd, London, UK.
- Chase, A. R. 1997. *Foliage plant diseases: diagnosis and control*. APS Press, St. Paul, MN.
- Chen, J., and R. C. Beeson, Jr. 2004. Production of quality aroid foliage plants using collected stormwater and irrigation runoff as an irrigation source. *Acta Hort.* (in press).
- Chen, J., R. C. Beeson, Jr., T. H. Yeager, R. H. Stamps, and L. A. Felter. 2003a. Evaluation of captured rainwater and irrigation runoff for greenhouse foliage and bedding plant production. *HortScience* 38:228–233.
- Chen, J., R. D. Caldwell, C. A. Robinson, and R. Steinkamp. 2000. Differential responses of container-grown ornamental foliage plants to silicon application. *HortScience* 35:458 (Abstr.).
- Chen, J., P. S. Devenand, D. J. Norman, R. J. Henny, and C. T. Chao. 2004a. Analysis of genetic relatedness of *Dieffenbachia* cultivars using AFLP markers. *J. Am. Soc. Hort. Sci.* 129:81–87.
- Chen, J., P. S. Devenand, D. J. Norman, R. J. Henny, and C. T. Chao. 2004b. Genetic relationships of *Aglaonema* species and cultivars inferred from AFLP markers. *Ann. Bot.* 93:157–166.
- Chen, J., R. W. Henley, R. J. Henny, R. D. Caldwell, and C. A. Robinson. 2001a. *Aglaonema* cultivar differences in resistance to chilling temperatures. *J. Environ. Hort.* 19:198–202.

- Chen, J., and R. J. Henny. 2002. ZZ: A unique tropical ornamental foliage plant. *HortTechnology* 13:458–462.
- Chen, J., R. J. Henny, and R. D. Caldwell. 2002a. Ethephon suppresses flowering of purple passion (*Gynura aurantiaca*). *J. Environ. Hort.* 20:228–231.
- Chen, J., R. J. Henny, and C. T. Chao. 2004d. Somaclonal variation as a source for cultivar development of ornamental aroids. *Recent Res. Devel. Plant Sci.* 1:31–43.
- Chen, J., R. J. Henny, and D. B. McConnell. 2002b. Development of new foliage plant cultivars. p. 446–452. In: J. Janick and A. Whipkey (eds.), *Trends in new crops and new uses*. ASHS Press, Alexandria, VA.
- Chen, J., R. J. Henny, D. B. McConnell, and R. D. Caldwell. 2003b. Gibberellic acid affects growth and flowering of *Philodendron* 'Black Cardinal'. *Plant Growth Regul.* 41:1–6.
- Chen, J., R. J. Henny, D. B. McConnell, and T. A. Nell. 2001b. Cultivar differences in interior performances of acclimatized foliage plants. *Acta Hort.* 543:135–140.
- Chen, J., R. J. Henny, C. A. Robinson, T. Mellich, and R. D. Caldwell. 1999. Potted *Anthurium*: An interior-flowering foliage plant. *Proc. Fla. State Hort. Soc.* 112:280–281.
- Chen, J., Y. Huang, and R. D. Caldwell. 2001c. Best management practices for minimizing nitrate leaching from container-grown nurseries. p. 96–102. In: J. Galloway, E. Cowling, J. W. Erisman, J. Wisniewski, and C. Jordan (eds.), *Optimizing nitrogen management in food and energy production and environmental protection*. A.A. Balkema Publishers, Lisse, The Netherlands.
- Chen, J., D. B. McConnell, and R. J. Henny. 2003c. The Importance of Asian-originated plants to the growth of the foliage plant industry. *Acta Hort.* 620:377–382.
- Chen, J., D. B. McConnell, C. A. Robinson, R. D. Caldwell, and Y. Huang. 2002c. Rooting foliage plant cuttings in compost-formulated substrates. *HortTechnology* 13:5–9.
- Chen, J., D. B. McConnell, C. A. Robinson, R. D. Caldwell, and Y. Huang. 2002d. Production and interior performances of tropical ornamental foliage plants grown in container substrates amended with composts. *Compost Sci. Utilization* 10:217–225.
- Chen, J., L. S. Osborne, R. J. Henny, R. D. Caldwell, and C. A. Robinson. 2001d. Evaluating *Anthurium* cultivar resistance to mites and thrips. *Greenhouse Product News* 11(2):16–17.
- Chen, J., C. A. Robinson, Y. Huang, R. W. Henley, R. Steinkamp, and R. D. Caldwell. 2001e. Absorption and translocation of sodium by pothos (*Epipremnum aureum*). *HortScience* 35:540 (Abstr.).
- Chen, J., Q. Wang, R. J. Henny, and D. B. McConnell. 2004c. Responses of tropical foliage plants to interior low light conditions. *Acta Hort.* (in press).
- Chen, S. C., and T. Tang. 1982. A general review of the orchid flora of China. pp. 39–81. In: J. Arditti (ed.), *Orchid biology: reviews and perspectives 2*. Cornell Univ. Press, Ithaca.
- Chow, W. S., L. Qian, D. J. Goodchild, and J. M. Anderson. 1988. Photosynthetic acclimation of *Alocasia macrorrhiza* (L.) G. Don to growth irradiance: structure, function, and composition of chloroplasts. p. 107–122. In: J. R. Evans, S. von Caemmerer, and W. W. Adams III (eds.), *Ecology of photosynthesis in sun and shade*. CSIRO Australia.
- Clifton-Brown, J. C., and M. B. Jones. 1999. Alteration of transpiration rate, by changing air vapor pressure deficit, influences leaf extension rate transiently in *Miscanthus*. *J. Expt. Bot.* 50:1393–1401.
- Collins, P. C., and T. M. Blessington. 1982. Postharvest effects of various light sources and duration on keeping quality of *Ficus benjamina* L. *HortScience* 17:908–909.
- Comstock, J. P. 2002. Hydraulic and chemical signaling in the control of stomatal conductance and transpiration. *J. Expt. Bot.* 367:195–200.

- Conover, C. A. 1985. Foliage plants. p. 465–482. In: V. Ball (ed.), Ball redbook. Reston Publ. Co., Reston, VA.
- Conover, C. A. 1992. Foliage plants. p. 569–601. In: R. A. Larson (ed.), Introduction to Floriculture. Academic Press, New York.
- Conover, C. A., and R. T. Poole. 1972. Influence of shade and nutritional levels on growth and yield of *Scindapsus aureus*, *Cordyline terminalis* 'Baby Doll' and *Dieffenbachia exotica*. Proc. Trop. Reg. Am. Soc. Hort. Sci. 16:277–281.
- Conover, C. A., and R. T. Poole. 1974a. Influence of media and fertilization rates on *Aglaonema* 'Fransher'. Proc. Fla. State Hort. Soc. 87:431–435.
- Conover, C. A., and R. T. Poole. 1974b. Influence of shade and fertilization source and level on growth, quality and foliar content of *Philodendron oxycardium* Schott. J. Am. Soc. Hort. Sci. 99:150–152.
- Conover, C. A., and R. T. Poole. 1974c. Foliage collapse of *Dieffenbachia picta* 'Perfection' during propagation. SNA Nursery Res. 1:1–6.
- Conover, C. A., and R. T. Poole. 1981a. Environmental factors. p. 269–283. In: J. N. Joiner (ed.), Foliage plant production. Prentice-Hall, Englewood Cliffs, NJ.
- Conover, C. A., and R. T. Poole. 1981b. Influence of light and fertilizer levels and fertilizer sources on foliage plants maintained under interior environments for one year. J. Am. Soc. Hort. Sci. 106:571–574.
- Conover, C. A., and R. T. Poole. 1982. Slow-release fertilizers and light level influence growth of *Araucaria heterophylla* and *Spathiphyllum* × Mauna Loa. Proc. Trop. Reg. Am. Soc. Hort. Sci. 25:73–76.
- Conover, C. A., and R. T. Poole. 1984. Acclimatization of indoor foliage plants. Hort. Rev. 6:119–154.
- Conover, C. A., and R. T. Poole. 1986. Nitrogen source effects on growth and tissue content of selected foliage plants. HortScience 21:1008–1009.
- Conover, C. A., and L. N. Satterthwaite. 1996. Paclobutrazol optimize leaf size, vine length and plant grade of golden pothos (*Epipremnum aureum*) on totems. J. Environ. Hort. 14:44–46.
- Conover, C. A., L. N. Satterthwaite, and R. T. Poole. 1994. Plant growth and NO_x-N in leachate from *Dieffenbachia maculata* 'Camille'. J. Environ. Hort. 12:119–123.
- DaMatta, F. M., R. A. Loos, E. A. Silva, M. E. Loureiro, and C. Ducatti. 2002. Effects of soil water deficit and nitrogen nutrition on water relations and photosynthesis of pot-grown *Coffea canephora* Pierre. Trees 16:555–558.
- Davis, T. D., G. L. Steffens, and N. Sankhla. 1988. Triazole plant growth regulators. Hort. Rev. 10:219–229.
- Debergh, P. C., and L. J. Maene. 1981. A scheme for commercial propagation of ornamental plants by tissue culture. Scientia Hort. 14:335–345.
- De Boodt, M., and O. Verdonck. 1972. The physical properties of the substrates in horticulture. Acta Hort. 26:37–44.
- Demming-Adams, B., and W. W. Adams. 1992. Photoprotection and other responses of plants to high light stress. Annu. Rev. Plant Physiol. Plant Mol. Biol. 43:599–626.
- Di Benedetto, A. H., and D. H. Cogliatti. 1990. Effects of light intensity and light quality on the obligate shade plant *Aglaonema commutatum*. II. Photosynthesis and dry-matter partitioning. J. Hort. Sci. 65:699–705.
- Dole, J. M., and H. F. Wilkins. 1999. Floriculture: Principles and species. Prentice Hall, Upper Saddle River, NJ.
- Dreistadt, S. H. 2001. Integrated pest management for floriculture and nurseries. University of California statewide IPM project, ANR publication-3402. Oakland, CA.

- Fails, B. S., A. J. Lewis, and J. A. Barden. 1982. Net photosynthesis and transpiration of sun- and shade-grown *Ficus benjamina* leaves. *J. Am. Soc. Hort. Sci.* 107:758–761.
- Foley, J. T., and G. J. Keever. 1992. Pink polka-dot plant *Hyposesters phyllostachya* response to growth retardants. *J. Environ. Hort.* 10:87–90.
- Fonteno, W. C. 1996. Growing media: types and physical/chemical properties. p. 93–139. In: D. W. Reed. (ed.), *Water, media, and nutrition for greenhouse crops*. Ball Pub., Batavia, IL.
- Fonteno, W. C., and E. L. McWilliams. 1978. Light compensation points and acclimatization of four tropical foliage plants. *J. Am. Soc. Hort. Sci.* 103:52–56.
- Free, M. 1979. *All about house plants*. Doubleday, Garden City, New York.
- Funnell, K. A., E. W. Hewett, J. A. Plummer, and I. J. Warrington. 2002. Acclimation of photosynthetic activity of *Zantedeschia* 'Best Gold' in response to temperature and photosynthetic photon flux. *J. Am. Soc. Hort. Sci.* 127:290–296.
- Giese, M., U. Bauer-Doranth, C. Langebarthels, and H. Sandermann. 1994. Detoxification of formaldehyde by spider plant (*Chlorophytum comosum* L.) and soybean (*Glycine max* L.) cell suspension cultures. *Plant Physiol.* 104:1301–1309.
- Grange, R. I., and D. W. Hand. 1987. A review of the effects of atmospheric humidity on the growth of horticultural crops. *J. Hort. Sci.* 52:125–134.
- Griffith, L. P. 1998. *Tropical foliage plants: A grower's guide*. Ball Pub., Batavia, IL.
- Griffith, L. P. 2002. *Tropical foliage disorders: A Ball guide*. Ball Pub., Batavia, IL.
- Hagiladi, A., and A. A. Watad. 1992. *Cordyline terminalis* plants respond to foliar sprays and medium drenches of paclobutrazol. *HortScience* 27:128–130.
- Halevy, A. H. 1990. Recent advances in control of flowering in horticultural crops. p. 39–43. In: XXIII Int. Hort. Congress. Plenary Lectures. Firenze, Italy, Aug. 27–Sept. 1.
- Halevy, A. H., A. M. Kofranek, and J. Kubota. 1976. Effect of environmental conditions on flowering of *Strelitzia reginae* Ait. *HortScience* 11:584.
- Hamlen, R. A., D. W. Dickson, D. E. Short, and D. E. Stokes. 1981. Insects, mites, nematodes, and other pests. p. 428–479. In: J. N. Joiner (ed.), *Foliage plant production*. Prentice-Hall, Englewood Cliffs, NJ.
- Hammer, P. A. 1976. Stolon formation in *Chlorophytum*. *HortScience* 11:570–572.
- Hanan, J. J. 1998. *Greenhouses: Advanced technology for protected horticulture*. CRC Press, Boca Raton, FL.
- Harrison, D. S. 1976. Irrigation water applied to three commercial ornamental container nurseries. *Proc. Fla. State Hort. Soc.* 90:306–308.
- Hartmann, H. T., D. E. Kester, F. T. Davies, Jr., and R. L. Geneve. 1997. *Plant propagation: principles and practices*. 6th edition. Prentice-Hall, Upper Saddle River, NJ.
- Heinrich, J. L. 1996. Irrigation systems. p. 1–29. In: D. W. Reed (ed.), *Water, media, and nutrition for greenhouse crops*. Ball Pub., Batavia, IL.
- Heins, R. D., and H. F. Wilkins. 1978. Influence of photoperiod and light quality on stolon formation and flowering of *Chlorophytum comosum* (Thunb.) Jacques. *J. Am. Soc. Hort. Sci.* 103:687–689.
- Henley, R. W. 1983. *A pictorial atlas of foliage plant problems*. Florida Foliage Association, Apopka, FL.
- Henley, R. W. 1991. Heating the root zone of isolated eight-inch pots of *Aglaonema* during propagation and production: the winter jacket techniques. University of Florida, IFAS, CFREC-Apopka Res. Rep. RH-91-20.
- Henny, R. J. 1981. Promotion of flowering in *Spathiphyllum* 'Mauna Loa' with gibberellic acid. *HortScience* 16:554–555.
- Henny, R. J. 1988. Ornamental aroids: culture and breeding. *Hort. Rev.* 10:1–33.

- Henny, R. J. 1995. Stimulating flowering of ornamental aroid genera with gibberellic acid: a review. *Proc. Fla. State Hort. Soc.* 108:23–24.
- Henny, R. J. 2000. Breeding ornamental aroids. p. 121–132. In: D. J. Callaway and M. B. Callaway (eds.), *Breeding ornamental plants*. Timber Press, Portland, OR.
- Henny, R. J. 2001. Foliage plants. p. 83–87. In M. L. Gaston (ed.), *Tips on regulating growth of floriculture crops*. Ohio Florists' Assoc. Servi., Inc., Columbus, OH.
- Henny, R. J., and J. Chen. 2000. Flowering response of three *Spathiphyllum* cultivars to treatment with three levels of gibberellic acid. *Proc. Fla. State Hort. Soc.* 113:169–170.
- Henny, R. J., and J. Chen. 2003. Cultivar development of ornamental foliage plants. *Plant Breed. Rev.* 23:245–290.
- Henny, R. J., J. F. Knauss, and A. Donnan, Jr. 1981. Foliage plant tissue culture. p. 137–178. In: J. N. Joiner (ed.), *Foliage plant production*. Prentice-Hall, Englewood Cliffs, NJ.
- Huang, Y., J. Chen, L. Qu, R. D. Russell, and C. A. Robinson. 2000. Interpretation of soluble salts and pH of bulk solutions extracted by different methods. *Proc. Fla. State Hort. Soc.* 113:154–157.
- Huang, Y., J. Chen, C. A. Robinson, and R. D. Caldwell. 2001. Introducing a multi-cavity collection method for extracting plug root-zone solutions. *Proc. Fla. State Hort. Soc.* 114:243–245.
- Huxley, A. 1994. *The new Royal Horticultural Society dictionary of gardening*. Macmillan, London.
- Javot, H., and C. Maurel. 2002. The role of aquaporins in root water uptake. *Ann. Bot.* 90:301–313.
- Joiner, J. N. 1981. *Foliage plant production*. Prentice-Hall, Englewood Cliffs, NJ.
- Joiner, J. N., R. T. Poole, and C. A. Conover. 1981. Propagation. p. 284–306. In: J. N. Joiner (ed.), *Foliage plant production*. Prentice-Hall, Englewood Cliffs, NJ.
- Joiner, J. N., R. T. Poole, and C. A. Conover. 1983. Nutrition and fertilization of greenhouse crops. *Hort. Rev.* 5:317–403.
- Kamp, P. G. H., and G. J. Timmerman. 1996. *Computerized environmental control in greenhouses*. IPC-Plant, Ede, The Netherlands.
- Klock-Moore, K. A., and T. K. Broschat. 2001. Effect of four growing substrates on growth of ornamental plants in two irrigation systems. *HortTechnology* 11:456–460.
- Kluge, M., and I. P. Ting. 1978. *Crassulacean acid metabolism*. Springer-Verlag, New York.
- Knauss, J. F., S. A. Alfieri, Jr., R. B. Marlatt, and F. W. Zettler. 1981. Foliage plant disease. p. 351–427. In J. N. Joiner (ed.), *Foliage plant production*. Prentice-Hall, Englewood Cliffs, NJ.
- Koniger, M., G. C. Harris, and R. W. Pearcy. 1998. Interaction between photo flux density and elevated temperatures on photoinhibition in *Alocasia macrorrhiza*. *Planta* 205:214–222.
- Kramer, P. L., and J. S. Boyer. 1995. *Water relations of plants and soils*. Academic Press, New York.
- Krizek, D. T., W. A. Bailey, and H. H. Klueter. 1971. Effects of relative humidity and type of container on the growth of F_1 hybrid annuals in controlled environments. *Am. J. Bot.* 58:544–551.
- Ku, C. S. M., and D. R. Hershey. 1997. Growth response, nutrient leaching and mass balance for potted poinsettia. I. Nitrogen. *J. Am. Soc. Hort. Sci.* 122:452–458.
- Kuehnle, A. R., F. C. Chen, and N. C. Sugii. 2001. Transgenic *Anthurium*. p. 4–15. In: Y. P. S. Bajaj (ed.), *Biotechnology in agriculture and forestry*. Vol. 48. *Transgenic crop III*. Springer-Verlag, Berlin-Heidelberg.
- Lambers, H., F. S. Chapin, III, and T. L. Pons. 1998. *Plant physiological ecology*. Springer, New York.

- Lance, C. J., and C. L. Guys. 1992. Changes in pigment levels, Rubisco and respiratory enzyme activity of *Ficus benjamina* during acclimation to low irradiance. *Physiol. Plant.* 86:630–638.
- Lane, B. C. 1980. A procedure for propagating ferns from spores using a nutrient-agar solution. *Proc. Int. Plant Prop. Soc.* 30:94–97.
- Lang, H. J. 1996. Growing media testing and interpretation. p. 123–139. In: D. W. Reed (ed.), *A grower's guide to water, media, and nutrition for greenhouse crops*. Ball Pub., Batavia, IL.
- Lang, H. J., and T. R. Pannkuk. 1998. Effects of fertilizer concentration and minimum-leach drip irrigation on the growth of new guinea impatiens. *HortScience* 33:683–688.
- Lange, O. L., R. Losch, E. D. Schulze, and L. Kappen. 1971. Responses of stomata to changes in humidity. *Planta* 100:76–86.
- Lea-Cox, J. D., and D. S. Ross. 2001. A review of the Federal Clean Water Act and the Maryland Water Quality Improvement Act: The rationale for developing a water and nutrient management planning process for container nursery and greenhouse operations. *J. Environ. Hort.* 19:226–229.
- Liu, F., C. R. Jensen, and M. N. Andersen. 2003. Hydraulic and chemical signals in the control of leaf expansion and stomatal conductance in soybean exposed to drought stress. *Funct. Plant Biol.* 30:65–73.
- Lohr, V. I., C. H. Pearson-Mims, and G. K. Goodwin. 1996. Interior plants may improve worker productivity and reduce stress in a windowless environment. *J. Environ. Hort.* 14:97–100.
- Lohr, V. I., and C. H. Pearson-Mims. 1996. Particulate matter accumulation on horizontal surfaces in interior: influence of foliage plants. *Atmos. Environ.* 30:2565–2568.
- Lowe, E. J. 1861. *Beautiful leaved plants*. Groombridge and Sons, London.
- Manaker, G. H. 1997. *Interior plantscapes: Installation, maintenance, and management*. 3rd ed. Prentice-Hall, Upper Saddle River, NJ.
- Maronek, D. M., D. Studebaker, and B. Oberly. 1985. Improving media aeration in liner and container production. *Proc. Int. Plant Prop. Soc.* 35:591–597.
- Marousky, F. J., and B. K. Harbaugh. 1978. Deterioration of foliage plants during transit. p. 33–39. *Proc. 1978. Natl. tropical foliage short course*. Univ. of Florida, IFAS Coop. Ext. Serv., Orlando, FL.
- Marschner, H. 1995. *Mineral nutrition of higher plants*. 2nd ed. Academic Press, London.
- Maxwell, K., and G. N. Johnson. 2000. Chlorophyll fluorescence—a practical guide. *J. Expt. Bot.* 51:659–668.
- McConnell, D. B., J. Chen, R. J. Henny, S. V. Pennisi, and M. E. Kane. 2003. Growth responses of *Spathiphyllum* cultivars to elevated production temperatures. *Acta Hort.* 620:273–279.
- McConnell, D. B., and R. T. Poole. 1981. Growth regulators. p. 307–325. In: J. N. Joiner (ed.), *Foliage plant production*. Prentice-Hall, Englewood Cliffs, NJ.
- McWilliams, E. L., and C. W. Smith. 1978. Chilling injury in *Scindapsus pictus*, *Aphelandra squarrosa* and *Maranta leuconeura*. *HortScience* 13:179–180.
- Medrano, H., J. M. Escalona, J. Bota, J. Gulias, and J. Flexas. 2002. Regulation of photosynthesis of C3 plants in response to progressive drought: stomatal conductance as a reference parameter. *Ann. Bot.* 89:895–905.
- Mengel, K., E. A. Kirkby, H. Kosegarten, and T. Appel. 2001. *Principles of plant nutrition*. 5th ed. Kluwer Academic Publishers, Dordrecht, The Netherlands.
- Mills, H. A., and J. B. Jones, Jr. 1996. *Plant analysis handbook II*. Micro-Macro Publishing, Athens, GA.

- Monteith, J. L. 1995. A reinterpretation of stomatal response to humidity. *Plant, Cell, Environ.* 18:357–364.
- Mortensen, L. M., and H. R. Gislerod. 1990. Effects of air humidity and supplementary lighting on foliage plants. *Scientia Hort.* 44:301–308.
- Neal, C. A., and R. W. Henley. 1992. Water use and runoff comparison of greenhouse irrigation systems. *Proc. Fla. State Hort. Soc.* 105:191–194.
- Nelson, P. V. 2003. *Greenhouse operation and management*. 6th ed. Prentice Hall, Upper Saddle River, NJ.
- Nicolson, D. H. 1968. The genus *Spathiphyllum* in the east Malaysia and west pacific islands (Araceae). *Blumea* 16:119–121.
- Norman, D. J. 2003. Fungicide trends in the ornamental industry. p. 71–83. In: J. Chamberlin (ed.), *Proceedings for the nineteenth conference on insect and disease management on ornamentals*. Soc. Am. Florists.
- Norman, D. J., and R. J. Henny. 1999. Conquering diseases of tropical ornamentals. p. 71–83. In: K. M. Heinz (ed.), *Proc. Fifteenth Conference on Insect and Disease Management on Ornamentals*. Soc. Am. Florists.
- Oren-Shamir, M., E. E. Gussakovsky, E. Shpiegel, A. Nissim-Levi, K. Ratner, R. Ovidia, Y. E. Giller, and Y. Shahak. 2001. Colored shade nets can improve the yield and quality of green decorative branches of *Pittosporum variegatum*. *J. Hort. Sci. Biotech.* 76:353–361.
- Osborne, L. S., E. A. Buss, C. M. Mannion, and J. F. Price. 2001. Commercial foliage and woody ornamental arthropod pest management. University of Florida, IFAS Extension, EDIS Publ. ENY-311.
- Pass, R. G., and D. E. Hartley. 1979. Net photosynthesis of three foliage plants under low irradiation levels. *J. Am. Soc. Hort. Sci.* 104:745–748.
- Pedigo, L. P. 1999. *Entomology and pest management*. 3rd ed. Prentice Hall, Upper Saddle River, NJ.
- Pennisi, S., J. Chen, and D. B. McConnell. 2003. Plant growth regulator application improve the interior performance of three Dieffenbachia cultivars. *HortScience* 38:714 (Abstr.).
- Perry, L. 1981. Storage and physiological preconditioning of selected tropical foliage plant seeds. Ph.D. Thesis, Cornell Univ., Ithaca, NY.
- Poole, R. T., and C. A. Conover. 1975. Fluoride-induced necrosis of *Dracaena deremensis* Engler cv. Janet Craig. *HortScience* 10:376–377.
- Poole, R. T., and C. A. Conover. 1977. Nitrogen and potassium fertilization of *Aglaonema commutatum* Schott cvs. Fransher and Pseudobracteatum. *HortScience* 12:570–571.
- Poole, R. T., and C. A. Conover. 1978. Influence of container size, fertilizer level, and area or volume rate basis on *Schefflera* growth. *Soil Crop Sci. Soc. Fla.* 38:12–14.
- Poole, R. T., and C. A. Conover. 1979. Identification and correction of copper deficiency of *Aglaonema commutatum* 'Fransher'. *HortScience* 14:187–188.
- Poole, R. T., and C. A. Conover. 1981a. Influence of maximum air temperatures and irrigation frequencies during high temperature periods on growth of four foliage plants. *HortScience* 16:556–557.
- Poole, R. T., and C. A. Conover. 1981b. Influence of N-P-K factorial fertilization on growth characteristics and foliar content of four foliage plants. *HortScience* 16:771–772.
- Poole, R. T., and C. A. Conover. 1983. Influence of simulated shipping environments on foliage plant quality. *HortScience* 18:191–193.
- Poole, R. T., and C. A. Conover. 1992. Reaction of three bromeliads to high humidity during storage. University of Florida, IFAS, CFREC-Apopka Res. Rep. RH-92-26.
- Poole, R. T., and C. A. Conover. 1993. Paclobutrazol and indoor light intensity influence water use of some foliage plants. *Proc. Fla. State Hort. Soc.* 105:178–180.

- Poole, R. T., C. A. Conover, and J. N. Joiner. 1976. Chemical composition of good quality tropical foliage plants. *Proc. Fla. State Hort. Soc.* 89:307–308.
- Poole, R. T., C. A. Conover, and J. N. Joiner. 1981. Soils and potting mixtures. p. 179–202. In: J. Joiner (ed.), *Foliage plant production*. Prentice-Hall, Englewood Cliffs, NJ.
- Qu, L., J. Chen, R. J. Henny, R. D. Caldwell, and C. A. Robinson. 2000. Response of *Spathiphyllum* cultivars to chilling temperatures. *Proc. Fla. State Hort. Soc.* 113:165–169.
- Qu, L., J. Chen, R. J. Henny, Y. Huang, R. D. Caldwell, and C. A. Robinson. 2002. Thidiazuron promotes adventitious shoot regeneration from pothos (*Epipremnum aureum*) leaf and petiole explants. *In Vitro Cell. Dev. Biol. Plant* 38:268–271.
- Richards, L. A., and C. H. Wadleigh. 1952. Soil water and plant growth. p. 73–251. In: B. T. Shaw (ed.), *Soil physical conditions and plant growth*. Academic Press, New York.
- Scoggins, H. L., P. V. Nelson, and D. A. Bailey. 2000. Development of the press extraction method for plug substrate analysis: effects of variable extraction force on pH, electrical conductivity, and nutrient analysis. *HortTechnology* 10:367–369.
- Serpe, M. D., and M. A. Matthews. 2000. Turgor and cell wall yielding in dicot leaf growth in response to changes in relative humidity. *Australia J. Plant Physiol.* 27:1131–1140.
- Skimina, C. 1986. Recycling irrigation runoff on container ornamentals. *HortScience* 21:31–34.
- Smith, C. N., and E. F. Scarborough. 1981. Status and development of foliage plant industries. p. 1–39. In: J. Joiner (ed.), *Foliage plant production*. Prentice-Hall, Englewood Cliffs, NJ.
- Smith, H. 1994. Sensing the light environment: the functions of the phytochrome family. p. 374–416. In: R. E. Kendrick and G. H. M. Kronenberg (eds.), *Photomorphogenesis*. Kluwer Academic Publ., The Hague.
- Snyder, S. D. 1995. *Environmental interiorscapes: a designer's guide to interior landscaping and automated irrigation systems*. Watson-Guptill Publ., New York.
- Sperry, J. S., U. G. Hacke, R. Oren, and J. P. Comstock. 2002. Water deficits and hydraulic limits to leaf water supply. *Plant, Cell Environ.* 25:251–263.
- Stamps, R. H., and M. R. Evans. 1997. Growth of *Dieffenbachia maculata* 'Camille' in growing media containing sphagnum peat or coconut coir dust. *HortScience* 32:844–847.
- Stuefer, J. F., and H. Huber. 1998. Differential effects of light quantity and spectral light quality on growth, morphology and development of two stoloniferous *Potentilla* species. *Oecologia* 117:1–8.
- Styer, R. C., and D. S. Koranski. 1997. *Plug and transplant production*. Ball Pub., Batavia, IL.
- Thimijan, R. W., and R. D. Heins. 1983. Photometric, radiometric, and quantum light units of measure: A review of procedures for interconversion. *HortScience* 18:818–822.
- Trenkel, M. E. 1997. *Controlled-release and stabilized fertilizers in agriculture*. IFA, Paris.
- USDA (United States Department of Agriculture). 2003. *Floriculture crops 2002 Summary*. Washington, DC.
- Verdonck, O., R. Peninck, and M. De Boodt. 1983. Physical properties of different horticultural substrates. *Acta Hort.* 150:155–160.
- Vladimirova, S. V., D. B. McConnell, M. E. Kane and R. W. Henley. 1997. Morphological plasticity of *Dracaena sanderana* 'Ribbon' in response to four light intensities. *HortScience* 32:1049–1052.
- Wang, K. H., B. Sipes, and A. R. Kuehnle. 1997. Effect of soilless media on the growth of *Anthurium andraeanum* infected by *Radopholus similis*. *Nematropica* 27:77–84.
- Wang, Q., and J. Chen. 2003. Variation in photosynthetic characteristics and leaf area contributes to *Spathiphyllum* cultivar differences in biomass production. *Photosynthetica* 41:443–447.

- Wang, Q., J. Chen, and Y. Li. 2004. Nondestructive and rapid estimation of leaf chlorophyll and nitrogen status of peace lily using a chlorophyll meter. *J. Plant Nutr.* 27:555–567.
- Wang, Y. T. 1988. Influence of light and heated medium on rooting and shoot growth of two foliage plant species. *HortScience* 23:346–347.
- Wang, Y. T., and T. M. Blessington. 1990. Growth of four tropical foliage species treated with paclobutrazol or uniconazole. *HortScience* 25:202–204.
- Wang, Y. T., and L. L. Gregg. 1994. Chemical regulators affect growth, postproduction performance, and propagation of golden pothos. *HortScience* 29:183–185.
- Waters, W. E., and C. A. Conover. 1981. Greenhouses, related structures, and environmental control. p. 40–72. In: J. N. Joiner (ed.), *Foliage plant production*. Prentice-Hall, Englewood Cliffs, NJ.
- Weatherspoon, D. M., and C. C. Harrell. 1980. Evaluation of drip irrigation for container production of woody landscape plants. *HortScience* 15:488–489.
- Wolverton, B. C., A. Johnson, and K. Bounds. 1989. Interior landscape plants for indoor air pollution abatement. Final Report. National Aeronautics and Space Administration. John C. Stennis Space Center, MO.
- Wolverton, B. C., R. C. McDonald, and E. A. Watkins, Jr. 1984. Foliage plants for removing indoor air pollutants from energy efficient homes. *Econ. Bot.* 38:224–229.
- Yeager, T. H., R. D. Wright, and S. J. Donohue. 1983. Comparison of pour-through and saturated pine bark extract N, P, K, and pH levels. *J. Am. Soc. Hort. Sci.* 108:112–114.

Fruit Drop in Mango*

Zora Singh and Aman Ullah Malik

Horticulture, Muresk Institute

Division of Resources and Environment, Curtin University of
Technology

GPO Box U 1987, Perth 6845 WA, Australia

Thomas L. Davenport

University of Florida, IFAS

Tropical Research and Education Center

18905 SW 280 St.

Homestead, Florida 33031

- I. INTRODUCTION
- II. INTENSITY AND PATTERNS OF FRUIT DROP
 - A. Abscission
 - B. Phytohormone Control of Abscission
 - 1. Auxin
 - 2. Ethylene
 - 3. Gibberellins
 - 4. Cytokinins
 - 5. Abscisic Acid
 - 6. Polyamines
 - 7. Enzymes
- III. BIOTIC AND ABIOTIC FACTORS INFLUENCING FRUIT DROP
 - A. Pollination and Fertilization
 - B. Embryo Abortion

*This review is dedicated to Professor John Janes for his 33 years of service in the field of Agriculture and Horticulture to Muresk Institute, Curtin University of Technology, Perth, Western Australia. We thank Dr. M. I. S Gill, Punjab Agricultural University, Ludhiana, India for constructive review and comments on the manuscript.

This research was supported in part by the Florida Agriculture Experiments Stations, and approved for publication as Journal Series no. R-10004.

Horticultural Reviews, Volume 31, Edited by Jules Janick
ISBN 0-471-66694-7 © 2005 John Wiley & Sons, Inc.

- C. Insect Pests
- D. Diseases
- E. Temperature and Wind
- F. Water Relations
- G. Nutrition
- IV. ENDOGENOUS FACTORS AFFECTING FRUIT DROP
 - A. Genotype
 - B. Competition for Photoassimilates
- V. MANAGEMENT PRACTICES AFFECTING FRUIT DROP
 - A. Fruit Thinning
 - B. Girdling
 - C. Intercropping
- VI. CONCLUSION
- LITERATURE CITED

I. INTRODUCTION

Mango (*Mangifera indica* L., Anacardaceae) is esteemed as one of the world's most popular tropical fruits due to its delicate, sweet flavor and nutritive value. It is grown on 2.9 million hectares in at least 87 countries of the world with an estimated production of 23 million tonnes (FAO 2002). Primary production is concentrated in the tropical lowlands of the Indian subcontinent, Southeast Asia, and Central and South America. Mango is also grown outside the tropical belt between 23°N and S latitudes in subtropical climates such as Israel, Florida, South Africa, and Australia (Crane et al. 1997).

Despite adequate flowering and initial fruit set, severe fruit drop contributes to low fruit yields in mango orchards and causes great economic losses in various mango-growing countries of the world. Individual panicles produce hundreds of ovule-bearing flowers, only a small proportion of which set fruit and reach maturity. A high magnitude of young fruit abscission in mango is also one of the major bottlenecks in mango breeding programs. Abscission of immature fruit occurs in all mango cultivars at all stages of fruit development, but it is especially high during the first three to four weeks after pollination.

Causes of early fruit abscission are numerous. They include lack of pollination, self-incompatibility, failure of fertilization, embryo abortion, competition among developing fruit, insect pests, and diseases resulting in internal nutritional and hormonal imbalances. Various attempts have been made to improve set and retention with exogenous application of plant growth regulators, nutrients, and pesticides. This article expands and complements previous reviews related to the causes and control of fruit drop (Singh 1960a; Randhawa and Chadha 1982; Chadha

1993; Davenport and Nuñez-Elisía 1997) with new information on fundamental and applied aspects of mango abscission.

II. INTENSITY AND PATTERNS OF FRUIT DROP

Mango production is usually low compared to its potential. Yield depends on the number of fruit that progress through various growth and developmental stages from initial fruit set until maturity. Although trees may produce panicles bearing thousands of flowers, only a fraction of those flowers are hermaphroditic containing ovules capable of fruit development (Davenport and Nuñez-Elisía 1997). Of those, perhaps an average of ten to 50 initially set fruit within individual panicles, and depending on cultivar, only a fraction of a percent of the originally set fruit reach maturity (Bijhouwer 1937; Sen 1939; Naik and Rao 1943; Musahib-ud-Din and Dinsha 1946; Mukherjee 1949; Singh 1960a; Randhawa and Damodaran 1961a, 1961b; Gunjate et al. 1983; Prakash and Ram 1984; Desai et al. 1994; Singh and Janes 2000; Malik 2003). Some cultivars have been observed to develop only one fruit to maturity out of 150 apparently fertilized flowers, particularly those cultivars with a heavy initial fruit set (Mukherjee 1949).

Abscission occurs during three distinct phases of fruit development: post-setting drop (during the first two months of fruit age), mid-season drop (when fruit are 60–75 days old), and pre-harvest drop (just before fruit maturity) (Dahsham and Habib 1985). The abscission pattern of initially set fruit is asymptotic, with the greatest losses occurring during the first 3 to 4 weeks following completion of floral anthesis followed by gradual reduction as fruit attain substantial size (Mukherjee 1949; Singh 1960b; Jawanda and Singh 1961; Sturrock 1961; Gill 1966; Van Lelyveld 1978; Sirichai 1980; El-Nabawy et al. 1983; Lam et al. 1985; Bhuyan and Irabagon 1993; Searle et al. 1995). This intensity and pattern of abscission is consistent in all cultivars grown throughout the tropics and subtropics. Chen et al. (1995) observed that most mango fruit abscise in China within five weeks after flower shedding, the main wave occurring in the first two weeks. A study of five mango cultivars ('Manila', 'Tommy Atkins', 'Haden', 'Kent', and 'Keitt') in Mexico showed that most of the fruit drop occurred 25–50 days after fruit set (Guzman Estrada 1996). Initial fruit drop accounted for up to 90% of the total by the seventh week after initial set in 'Carabao' mango in the Philippines (Mendoza 1981). More than 90% of total 'Tommy Atkins' fruit drop occurred within the first four weeks, resulting in 0.6% final fruit set (Nuñez-Elisía and Davenport 1983). Percentage of fruited panicles remained constant for the

first three weeks, and decreased sharply up to 40% by the sixth week, ending at 11.7% at harvest. Fruit retention of 'Golek' mango was only 2% of its initial number one week after fruit set in Malaysia (Lam et al. 1985). Yields of 10-year-old trees of 'Bombay Green', 'Yellow', 'Golap-khas', 'Himsagar', 'Langra' and 'Safderpasand' was only 0.3 to 3.1% of initially set fruit in India (Sanyal and Maity 1989). Other studies have demonstrated similarly high losses during development, with the total percentage of fruit drop ranging from 75.7% in 'Himsagar' to 100% in 'Mallika' in 1995, and from 89.5% ('Mallika') to 98.3% ('Bombay Yellow') in 1996 (Jana and Sharangi 1998). Total fruit drop in 'Kensington Pride' grown under Western Australian conditions accounted for up to 98.3% annually (Singh and Janes 2000; Singh and Agrez 2002). The overwhelming conclusion to be drawn from these studies is that the initial three to four weeks following anthesis is a critical period in which to focus efforts to minimize young fruit abscission. Retaining as little as 2% of the fruit lost early in fruit development could result in a doubling of yield.

A. Abscission

Plants shed organs that are diseased, stressed, or at the terminal stage of their development. Separation takes place at a previously formed abscission zone, a morphologically distinct site at the base of leaf petioles and fruit pedicels, as has been described for all higher plants (Sexton and Roberts 1982; Osborne 1989; Roberts et al. 2002). Abscission zones form early in the development of plant organs. The first stage of the abscission process is the differentiation of the abscission-zone cells in response to one or more morphogenic signals (Gonzalez-Carranza et al. 1998). The genes thought to be responsible for abscission zone formation have been described for mutant tomato. They include the *lateral suppressor* and *jointless* genes, the latter of which encodes MADS-box transcription factors including a protein resulting in flower and fruit pedicels lacking abscission zones (Mao et al. 2000; Roberts et al. 2002). The resulting abscission zones are generally comprised of a layer or layers of isodiametrically flattened cells in a plane across the structure that are primed to respond to specific signaling events that stimulate cell separation within the zone (Brown 1997; Gonzalez-Carranza et al. 1998; Roberts et al. 2000; Taylor and Whitelaw 2001). An abscission zone forms at the attachment point of floral pedicels to terminal peduncles of mango panicles. It is composed of irregular rows of small cells that are rich in organelles and differ from those of the upper and lower part of the pedicel (Singh 1961b). They are typically smaller and less vacuolated, and

the stele passing through the zone is not lignified. The middle lamellae between cells of the abscission layer within the zone are arranged in a somewhat zigzag fashion. This abscission zone is maintained in each fruit until it is stimulated to separate from the peduncle either during development or ultimately at fruit ripening and senescence.

The process of flower and fruit abscission in mango is accomplished by rapid formation of a separation layer located in the abscission zone at the pedicel-peduncle junction (Barnell 1939). Induction of cell separation occurs in response to various physical and biochemical stimuli causing expression of cell-wall degrading enzymes that dissolve the middle lamella and peptides that may have a role in protecting the exposed surface from pathogenic attack (Gonzalez-Carranza et al. 1998). Abscission of flowers, fruit, and leaves takes place in 24 to 48 hours, whereas the corolla of flowers may abscise in only a few hours (Nuñez-Elisía and Davenport 1986; Brown 1997). The earliest visible changes in abscission zone cells are increases in amounts of rough endoplasmic reticulum and ribosomes providing evidence of increased protein synthesis (van Doorn and Stead 1997). Cell wall degradation at the middle lamella occurs next followed by, in some species, complete autolysis of cell contents (Sexton and Roberts 1982; Osborne 1989; Roberts et al. 2002). Extensive swelling and disorganization of microfibrils in the primary wall and almost complete disappearance of middle lamella follows. This process involves the synthesis and activation of cell wall hydrolases that weaken the cell walls of cells in the abscission layer. The cells in the cortex separate by wall degradation, whereas xylem vessels seem to be ruptured mechanically (Sexton and Roberts 1982). Cell swelling appears to be necessary to impart shearing forces to facilitate cell separation, at least in some species (Sexton and Redshaw 1981), presumably including mango.

The most commonly up-regulated genes associated with cell separation in the abscission zone are those expressing a family of β -1, 4-endoglucanase enzymes (cellulases) and polygalacturonase (pectinases), which hydrolyze cell wall constituents resulting in weakening of the cell wall and several other defense related genes expressing chitinase and β -1, 3-glucanase (Sexton et al. 1985). Genes of several cellulase isozymes, *Cel 1* to *Cel 7* (Lashbrook et al. 1994; Brummell et al. 1997a,b; Catala et al. 1997; del Campillo and Bennett 1996) and a polygalacturonase gene (*TAPG 1*) (Kalaitzis et al. 1995) have been cloned from tomato. Two additional polygalacturonase cDNAs (*TAPG2* and *TAPG4*) associated with abscission zones have also been cloned (Kalaitzis et al. 1997). No specific information is available on gene expression in mango fruit abscission, but some work in citrus (Burns et al. 1998; Kazokas and Burns

1998; Zhong et al. 1998) and other fruit crops (Bonghi et al. 1998, 2000; Ramina et al. 1998; Ruperti et al. 1998) have been reported.

Other enzymes up-regulated in the abscission zone during separation include peroxidases, uronic acid oxidases, chitinases, and β -1, 3-glucanase. These may not be directly involved in cell separation, but may be involved in biosynthesis of products to provide protection of exposed surfaces from the pathogens (Sexton and Roberts 1982).

B. Phytohormone Control of Abscission

The signals thought to govern abscission are hormonal in nature. They function at relatively low concentrations in fruits to regulate the formation of abscission zones and activation of the separation layer. Each class of phytohormone plays a specific role in maintenance of abscission zones or induction of the separation process. Numerous investigations on the efficacy of various phytohormones, their synthetic analogs, or metabolic inhibitors of phytohormone biosynthesis or action in reducing fruit drop of mango, collectively called plant growth regulators (PGRs), have been conducted. These PGRs are discussed in the same classes below as the phytohormones they mimic or regulate.

1. Auxin. The primary native auxin in plants is indole-3-acetic acid (IAA). It and a variety of its conjugates play a central role in the regulation of plant growth and development primarily through control of cell division and elongation (Thimann 1977). It is also involved in other developmental phenomena including abscission to facilitate separation of organs from plants (Sexton and Roberts 1982; Osborne 1989). Young leaves and seeds of fruit are rich sources of auxins. Activation of the abscission zones of leaves, flowers, and fruit appear to be governed by the interaction of auxin and ethylene produced by the individual organ (Gonzalez-Carranza et al. 1998). A continuous supply of auxin from the subtending organ is conducive to maintenance of the abscission zone such that separation is discouraged (Roberts and Osborne 1981). It appears to interact with ethylene, which stimulates abscission through up-regulation of genes expressing cellulases and pectinases (Brown 1997). There appears to be a balance in auxin and ethylene action such that higher auxin levels offer greater protection against ethylene induced abscission, but higher than background levels of ethylene can ultimately overwhelm otherwise adequate auxin levels. As levels of auxin decrease due to senescence or ethylene increases as a result of organ tissue damage, the abscission layer is formed in the abscission zone at the base of the petiole or fruit pedicel and the organ separates from the plant.

Reasons for reduced auxin biosynthesis or transport to abscission zones are numerous. Low concentrations of auxin-like substances have been reported in developing fruit of mango (Chacko et al. 1970; Prakash and Ram 1984). The low auxin levels at the early fruit developmental stage may be attributed to resting embryos. The zygote and endosperm nuclei of 'Dashehari' are known to rest for about two weeks after fertilization (Singh 1961b; Sharma and Singh 1972). Chen (1981) found lower concentrations of auxin-like substances in the mesocarp and calyx (pedicel) tissues of abscised fruit when compared with intact fruit. Higher rates of fruit drop were generally associated with periods of lower auxin concentrations in 'Ewais' fruit, especially seed. At any given stage of fruit development, auxin content was generally higher in intact than in abscising mango fruit, in seed than in fruit flesh, and in the off than in the on year (Dahsham and Habib 1985). The first and larger peak of IAA concentration (70–80 ng/g fresh weight) at 15–30 days after fruit set in 'Alphonso' mango fruit possibly contributed to the cell enlargement phase (Murti and Upreti 1995). Abscising fruit as well as their pedicels of 'Dashehari' mango exhibited a decrease in mean concentration of IAA when compared with intact developing fruit at pinhead, pea, and marble stages (Bains et al. 1997b). The lower concentrations of IAA in small fruit about to abscise and their pedicels may be attributed to its lower rate of production and higher oxidation rate. Lower concentration of endogenous auxin in about-to-abscise fruit and their pedicels as well as a reduction in fruit drop with exogenous application of auxins support the concept that auxin plays an important role in protection of mango abscission zones.

This point is further supported by numerous reports of improved fruit set and retention when auxins are applied. Gokhale and Kanitkar (1951) first reported the use of the synthetic auxins, naphthaleneacetic acid (NAA) and 2,4-dichlorophenoxyacetic acid (2,4-D) to reduce mango fruit drop. They found that foliar applications of 20 mg L⁻¹ NAA or 2,4-D were marginally effective in reducing fruit drop in 'Alphonso' mango. The same concentration of NAA applied to immature fruit at pea size stage (5–6 mm) and two weeks after at marble stage (10–15 mm) significantly increased fruit retention in 'Sindhri', 'Langra', and 'Dashehari' mangos in Pakistan (Naqvi et al. 1990; Haidry et al. 1997). Maximum fruit retention was achieved with two sprays of 40 mg L⁻¹ NAA at pea stage and one month later in 'Langra' (Maurya and Singh 1979), and similar results were obtained using similar concentrations of either NAA or 2,4-D in other cultivars (Jagirdar and Choudhry 1967; Aravindakshan et al. 1979; Rawash et al. 1983; Khan et al. 1993; Oosthuysse 1995). Three foliar applications of 5 mg L⁻¹ NAA at full bloom, pea, and marble stage

provided significantly improved fruit retention over controls (Singh et al. 1986).

2. Ethylene. Many studies have demonstrated that the signals that promote abscission involve ethylene, produced either by tissues in the abscising organ or from the external atmosphere as a result of pollution, or synthesis by neighboring plant tissues, or a microorganism (Sexton and Roberts 1982). The event(s) leading to induction of *in vivo* ethylene biosynthesis in developing mango fruits remains unknown, but the subsequent burst of ethylene is the factor initiating separation activity of the abscission zone (Nuñez-Elisía and Davenport 1986). Ethylene is recognized as the trigger of abscission in various plant organs across all species (Abeles et al. 1992). Expression of ethylene-regulated cellulase genes, *Cel 1* and *Cel 5* (del Campillo and Bennett 1996), and the polygalacturonase gene (*TAPG 1*) (Kalaitzis et al. 1995) have been found in abscission zones of tomato. It may be responsible for induction of pre-abscission changes as well as for accelerating the process of abscission (Burg 1968; Olien and Bukovac 1982); however, its exogenous application accelerates abscission in many, but not in all, abscising plant systems (Brown 1997).

Van Lelyveld and Nel (1982) implicated involvement of ethylene in mango fruit abscission. Increased ethylene production was found in young abscised fruit of mango cultivar 'Haden' but not in 'Sensation', which is less prone to abscission. Nuñez-Elisía and Davenport (1983) noted that increased ethylene production accompanied abscission of young seeded 'Tommy Atkins' and 'Keitt' fruit, whereas young stenopermocarpic fruit abscised with virtually no increase in ethylene production. They found that explants composed of fruits borne on panicles or peduncles were stimulated to produce ethylene within 24 hr after harvest, resulting in initiation of abscission. Increased ethylene production in developing fruit explants initiated approximately 48 hr prior to abscission and continued to increase until abscission. The seed produced the highest amount of ethylene on fresh weight basis; however, the main source was pericarp tissue on an absolute basis, as it represented 85% of the total fresh weight of developing fruit. Pedicels containing the abscission zone produced no detectable ethylene. Diffusion of ethylene from fruit tissues to the abscission zone triggers the events leading to separation of fruit from the tree. The intensity of ethylene production was cultivar-dependent, with 'Keitt' producing more than 3 times that of 'Tommy Atkins', and occurred only in fruit soon destined to abscise from the stems (Nuñez-Elisía and Davenport 1986). Non-abscising fruit continue to produce background levels of the hormone.

Higher concentrations of ethylene in the initial stages of fruit growth were observed in 'Alphonso', which may have been involved in the fruit drop that occurred during this phase (Murthi and Upreti 1995). These types of observations, however, simply reflect the presence of a larger proportion of developing fruit starting to abscise and contributing to the levels of ethylene measured in an enclosed sample group. Malik et al. (2003) recently reported that about-to-abscise fruit and pedicels at pinhead, pea, and marble stages of mango had higher endogenous concentrations of ethylene than intact tissues in 'Kensington Pride' and 'Glenn' (191% and 66% more mean ethylene in 'Kensington Pride' in 2001, 53.5% and 101% in 'Glenn' in 2000, and 135% and 93% in 2001, respectively). Mean endogenous ethylene was high at pinhead stage compared to later stages coinciding with the period of maximum fruitlet abscission during the earlier stage.

Ethylene or ethephon application promotes abscission, a response exploited for manipulating fruit load and assisting harvest (Brady and Speirs 1991). A two-year field trial showed that exogenous application of ethephon at final fruit set stage accelerated fruitlet abscission compared with control in 'Kensington Pride' mango (Malik et al. 2003). Fruitlet abscission increased exponentially with increasing concentrations (0, 10, 20, 40, 80 mg L⁻¹) of ethephon. In contrast, ethephon application at 50, 100, or 200 mg L⁻¹ significantly increased later fruit retention in 'Caraboa' mango when it was applied 40 days after bloom, but not at 54 or 68 days after flowering (Andam 1983). These apparently conflicting results may be explained on the basis that the effect of ethephon may depend upon the concentration and stage of application or the sensitivity of tissues. Higher concentrations of ethephon applied at or after final fruit set stage induce abscission in developing fruit on one hand, whereas lower concentrations applied at full bloom or at initial fruit setting stage acts as a thinning agent by inducing abscission in less competitive flowers and fruit. This, in turn, results in saving of carbohydrate reserves to be used by the remaining fruit, which were less prone to abscise during the initial 3–4 weeks of fruit set. Such an assumption is supported by the reduced fruit drop observed in response to thinning of 'Sensation' mango at or soon after fruit set (Davie and Stassen 1997). Chemical thinning options need to be tested in the future and may provide an alternate and cost-effective means of improving final fruitlet retention and fruit size, especially in cvs with excessively high initial fruit set.

Ethylene biosynthesis inhibitors, such as aminoethoxyvinylglycine (AVG) and aminoxyacetic acid (AOA), block the conversion of S-adenosylmethionine (SAM) to 1-aminocyclopropane-1-carboxylic acid

(ACC) in the ethylene biosynthetic pathway (Yang 1980; Yang and Hoffman 1984). Inhibitors of ethylene action include silver ions, applied as silver thiosulphate (STS) and the more phytotoxic silver nitrate (Beyer 1976; Yang 1980; Yang and Hoffman 1984; Naqvi et al. 1990) and the comparatively less effective Co ion (Taiz and Zeiger 1991). Substantial reductions in young fruit abscission with exogenous application of ethylene biosynthesis and action inhibitors have been reported in mango. Cobalt and silver ion sprays significantly reduced fruit drop and increased mango yield (Naqvi et al. 1990, 1998). It was reported that CoSO_4 , STS, and $\text{Co}(\text{NO}_3)_2$ improved fruit set and retention when applied 15–20 days after fruit set and then two weeks later (Singh 1994). Recently, while comparing ethylene biosynthesis (AVG, AOA and CoSO_4) and action inhibitors (STS), Singh and Agrez (2002) reported that AVG (150 to 200 mg L⁻¹) was the most effective in improving final fruit retention; however, both CoSO_4 and STS (200 mg L⁻¹) applied to fully-grown panicles prior to anthesis resulted in significantly better retention than control during fruit development period in 'Kensington Pride'. Results suggested that ethylene biosynthesis inhibition is a comparatively better approach to improve mango fruit retention than inhibition of ethylene action. From a commercial application perspective, STS and cobalt are known heavy metals, which limits their use. The application of AVG and AOA have been known to inhibit ethylene biosynthesis and reduce fruit drop; however, the high cost of chemicals and the huge size of mango trees limits their use in reducing fruit loss.

Despite the importance of ethylene in mango fruit abscission during development, no studies have been reported on activities of its precursors or key enzymes in the ethylene biosynthetic pathway such as ACC synthase and ACC oxidase, in the pedicel or fruit (McKeon et al. 1995). Investigations on the dynamics of activities of ACC synthase and ACC oxidase as well as expression of genes involved in encoding for ACC synthase and ACC oxidase during various phases of fruit and pedicel abscission and their regulation hold much promise for future research.

3. Gibberellins. More than 126 gibberellins have been identified and characterized from plants and fungus (MacMillan 2001), but only a few of these are physiologically active in higher plants (Sponsel 1995). A direct role for gibberellins in mango fruit abscission has not been elucidated, and the studies involving them are still inconclusive (Davenport and Nuñez-Elisía 1997). Several investigations have not supported direct involvement (Chacko et al. 1970, 1972; Ram and Pal 1979; Chen 1981; Ram 1983); however, some reports have claimed a correlative relationship of reduced endogenous levels of GA_3 with fruit abscission.

An investigation of 'Dashehari', 'Chausa', and 'Langra' demonstrated that a depletion in gibberellins resulted in fruit drop in all three cultivars (Ram 1992). Another two-year study on intact and about-to-abscise 'Dushehari' fruit, characterized by yellowing of sinus portion and dropped with a single shake of the panicle, at three developmental stages (e.g., pinhead, pea, and marble), revealed that about-to-abscise fruit as well as their pedicels exhibited a decrease in mean concentration of GA_3 (Bains et al. 1997b).

The efficacy of exogenously applied gibberellins (usually GA_3) on reducing abscission has also been variable. Increased mango fruit set and retention with application of GA_3 was reported by Singh and Ram (1983), Singh et al. (1986), and Rajput and Singh (1989), whereas others have reported non-significant effects (Chacko and Singh 1969; Kulkarni and Rameshwar 1978; Oosthuysen 1995).

Plant growth retardants inhibit biosynthesis of gibberellins and affect the various plant functions that are dependent upon gibberellins. Several classes of plant growth retardants have been characterized as to effective sites of enzyme inhibition early and late in the gibberellin biosynthetic pathway (Rademacher 2000a,b), and they have been investigated for efficacy to improve mango fruit set. Again, the responses are so varied that little can be concluded with regards to their efficacy in improving fruit set and retention or to the role of gibberellins in fruit abscission. The efficacies of paclobutrazol (Cultar, PBZ) soil drenched at concentration of 2.5, 5.0, or 10.0 g/tree; chlormequat (Cycocel, CCC) foliar sprayed at concentrations of 4000 or 8000 mg L⁻¹; or daminozide (Alar, B-9) sprayed at 1500 or 3000 mg L⁻¹ on nine-year-old 'Alphonso' mango trees were assessed for two successive years in Bangalore, India (Kurian and Iyer 1993). Treatments were applied either once in November (postharvest) or twice (November and March) about a fortnight prior to the expected date of vegetative flushing. Early flowering was a striking response to paclobutrazol treatments but no effect on fruit retention was noted from any treatment. PBZ, applied as a soil drench at 4 g (ai)/tree suspended in five liters of water to 25-year-old 'Alphonso' trees during the rainy season, resulted in the lowest fruit drop (17%) among several plant growth regulators tested (Bhatt et al. 1997). Paclobutrazol was applied as Cultar (25% ai) at one to 10 ml in an aqueous drench to the soil in a 60-cm ring around the trunk to two-year-old 'Sensation' and 'Tommy Atkins' trees prior to initiating postharvest flushing. There was no effect on fruit retention in 'Sensation', whereas in 'Tommy Atkins' retention decreased with increasing dose (Oosthuysen and Jacobs 1997a). Abou Rawash et al. (1998) reported reduced percentage of fruit drop at pea stage and increased final fruit retention after application of NAA

(200 mg L⁻¹) + ethephon (500 mg L⁻¹) once per season in November as well as uniconazole (500 mg L⁻¹) + ethephon (500 mg L⁻¹) twice in December.

4. Cytokinins. The early period of rapid growth of mango fruit has been described as one of intense cell division and cell enlargement stage (Saini et al. 1972). Cytokinins play a key role in cell division and cell enlargement (Hall 1973). They have been found in both pericarp and seed of mango. Lowered cytokinin concentrations in developing fruit have been correlated with fruit drop and cessation of fruit growth (Ram et al. 1983). This period of low cytokinin concentration 28–35 days after pollination coincided with increased fruit drop. Chen (1981) also observed a correlation between low cytokinin levels in stenospermo-carpic fruit and abscission at the marble stage. Since there has been no deficiency of auxins or gibberellins observed at this stage (Chacko et al. 1970; Ram and Pal 1979), it can be inferred that cytokinin deficiency promoted abscission of the developing fruit. A later study in ‘Dashehari’, ‘Chausa’, and ‘Langra’ mango also supported the possibility that cytokinin deficiency resulted in fruit drop (Ram 1992). Endogenous levels of cytokinin at pinhead and pea stages were found to be higher in intact ‘Alphonso’ fruit than in abscised ones (Murti and Upreti 1999).

Application of synthetic cytokinin has also demonstrated improved fruit set and retention, suggesting a potential role for cytokinin in maintenance of fruit abscission zones. Studies in East Java showed that exogenous application of 10 mg L⁻¹ of the synthetic cytokinin CPPU [N-(2-chloro-4-pyridyl)-N-phenylurea] 14 days after bloom resulted in an increased number of fruit per cluster and number of fruit retained per tree in the Thai cultivar ‘Arumanis’ (Notodimedjo and Subhadrabandhu 2000). Post-bloom treatments of CPPU plus GA₃ also significantly increased fruit retention in ‘Tommy Atkins’ (Oosthuysse 1995). The role of cytokinin in abscission still remains inconclusive, although cytokinin is certainly required for fruit development (Davenport and Nuñez-Elisía 1997). To define a clear role of cytokinins in mango fruit abscission warrants further investigations.

5. Absciscic Acid. The phytohormone, other than ethylene, most commonly linked to abscission is absciscic acid (ABA) (Addicott 1983). Observation of higher “inhibitor” (ABA-like) activity, as determined by bioassay of fruit tissues sampled in early development stages, suggested to the author that it might counteract the activity of auxins and gibberellins (Ram 1992). Contrarily, the heaviest fruit drop in ‘Nang Klangwan’ mango was during the first three weeks after anthesis, whereas

ABA-like activity did not correlate with fruit abscission during the same period (Somporn 1981). Higher concentrations of abscisic acid in developing fruit were found to be associated with fruit drop in 'Dashehari' mango (Prakash and Ram 1984). An ABA-like inhibitor has been found in 'Dashehari', 'Chausa', and 'Langra' during the first 21 days after pollination, corresponding to the period of slow growth and heavy fruit drop. As the fruit growth rate increased, the "inhibitor" levels were reduced (Ram 1992). Murti and Upreti (1995) found higher concentrations of ABA during initial stages of fruit growth in 'Alphonso', which may have been involved in the fruit drop that occurred during that phase. In a two-year study of intact and abscised fruit of 'Dashehari' at three developmental stages (e.g., pinhead, pea, and marble), an increase in mean concentration of ABA was found in about-to-abscise fruit and their pedicels as compared to intact developing fruit, contributing to the process of abscission (Bains et al. 1997b). The endogenous content of ABA at pinhead and pea size stage was found to be higher in abscised fruit than in intact ones in 'Alphonso' (Murti and Upreti 1999). A higher level of ABA in fruit and pedicels may stimulate ethylene production, which, in turn, causes abscission. It may also be argued that after the biosynthesis of ABA in fruit it may be translocated into pedicels and abscission zones to accelerate biosynthesis of hydrolytic enzymes that initiate formation of the abscission layer (Sexton and Roberts 1982). Such a relationship between ABA synthesis, metabolism, and translocation in intact and about-to-abscise fruit and pedicels is yet to be investigated.

6. Polyamines. Polyamines are a class of aliphatic amines that are ubiquitous in nearly all plant cells and have been implicated in a wide range of biological processes including plant growth and development (Faust and Wang 1992; Kumar et al. 1997; Bouchereau et al. 1999). The major polyamines affecting plant development are putrescine (butane-1, 4-diamine), spermidine [N-(3-amino propyl) butane-1, 4-diamine] and spermine [NN'-bis-(3-aminopropyl) butane-1, 4-diamine]. Being positively charged, they interact with anionic macromolecules like DNA, RNA, phospholipids, and some proteins, and they promote many functions of nucleic acids such as transcription and translation (Kumar et al. 1997). One effect of polyamines may be to direct binding with the cell membrane, maintaining membrane integrity through prevention of lipid peroxidation, and inhibition of ethylene synthesis by inhibiting ACC synthase and the terminal step of conversion to ethylene (Phillip and Malmberg 1989). The significance of polyamines in the process of abscission is evident from various research studies in olive (Lui et al. 1999),

mango (Singh and Singh 1995; Singh and Janes 2000; Malik and Singh 2003), and grape (Aziz et al. 2001).

Investigations into the interaction of polyamines in mango abscission are limited. Tissue concentrations were found to be higher in intact fruit compared to abscised fruit both at pinhead and pea stages in 'Alphonso'. Putrescine was found in abundance, followed by spermine at pinhead stage. At pea stage, however, spermidine followed by putrescine was present in higher concentration in intact as well as abscised fruit. There was greater variation in polyamine levels between the two categories of fruit at pinhead stage than at pea stage. A hormonal imbalance marked with lower levels of growth promoters including IAA, dihydrozeatin riboside (DHZR), t-zeatin riboside (t-ZR) and polyamines coupled with increased ABA levels coincided with the high incidence of fruit drop during early fruit development in 'Alphonso' (Murti and Upreti 1999). A recent study showed that intact fruit and their pedicels at pinhead, pea, and marble stages exhibited 276% and 341% higher mean total endogenous free polyamines than about-to-abscise ones in 'Kensington Pride', whilst in 'Glenn' the increase was 137% and 63%, respectively (Malik and Singh 2003). Putrescine, spermine, and spermidine individually were also significantly higher in intact fruit and their pedicels compared with about-to-abscise ones. The role of spermine seems to be critical in mango fruit abscission, as the about-to-abscise fruitlets had low levels of this compound (10.4% and 19% of intact fruitlets) in 'Kensington Pride' and 'Glenn', respectively.

Exogenous application of polyamines has also been reported to reduce fruitlet abscission; however, the response is significantly influenced by type, concentration, and time of application (Malik and Singh 2003). Aqueous solutions containing putrescine, spermine, and spermidine applied to panicles at full bloom stage resulted in high fruit retention in 'Dashehari' (Singh and Singh 1995). Application of spermine at 10^{-3} M prior to anthesis in 'Dashehari' and 10^{-4} M putrescine at full bloom in 'Langra' were most effective in increasing fruit retention. Singh and Janes (2000) reported that among spray application of various polyamines (putrescine, spermine, and spermidine) tested on mango, 10^{-4} M spermine applied to fully-grown panicles prior to anthesis was the most effective in increasing fruit retention in 'Kensington Pride', 'Haden', 'Kent' and 'Glenn'. A recent study showed that exogenous applications of putrescine, spermidine, and spermine at post-bloom fruit set stage reduced young fruit abscission, whereas inhibitors of polyamine biosynthesis, methylgloxal-bisguanyl hydrazone (MGBG), and alpha-difluoromethylornithine (DFMO) increased abscission compared with control in 'Kensington Pride' (Malik 2003; Malik and Singh

2003). Comparing four floral stages of application, i.e., at bud differentiation, 5–8 cm grown panicle, full bloom, and initial fruit set stage (when flowers abscised but still attached to panicles), 0.01 and 0.1 mM spermine were most effective in increasing final fruit retention when applied at full bloom or at 5–8 cm grown panicle stage (Malik 2003). Besides their known anti-ethylene properties, polyamines also have growth regulator effects (Rugni et al. 1986) that may improve floral organ development, pollination, fertilization, and subsequent embryo development, resulting in increased retention. Polyamines have been implicated in the reproductive process (Zhong and Zhong 2000) and delaying in senescence of flower parts (Crisosto et al. 1986) of plants. In general, lower levels of endogenous polyamines in abscised fruit and reduction of fruit drop with the exogenous application of polyamines support their possible role in fruit abscission.

7. Enzymes. Oxidases and peroxidases have received attention because of their involvement in the oxidation of IAA (Poovaiah and Rasmussen 1973). Enzymatic oxidation of IAA by these enzymes leads to reduced levels of IAA in developing fruit and is considered to be an important factor contributing to the process of abscission (Bains et al. 1997a). Abscission in mango fruit was associated with a higher peroxidase enzyme activity as compared to normal fruit (Van Lelyveld 1978). The higher activity was observed in ‘Haden’, which has a higher rate of fruit drop than that of ‘Sensation’. Increase in polyphenol oxidase activity, similar to the response of peroxidase activity, for both ‘Haden’ and ‘Sensation’ were also associated with abscission. ‘Haden’ had a higher activity of both enzymes than did ‘Sensation’ (Van Lelyveld 1978). In a two-year study on intact and about-to-abscise fruit at three developmental stages (pin-head, pea, and marble) in ‘Dashehari’, peroxidase and IAA-oxidase activities were significantly higher in about-to-abscise fruit (Bains et al. 1997a).

III. BIOTIC AND ABIOTIC FACTORS INFLUENCING FRUIT DROP

A. Pollination and Fertilization

In nature, initial fruit set in mango is low due to the predominance of staminate flowers, lack of pollination, failure of pollen to germinate or poor pollen tube growth due to self-incompatibility, and unfavorable weather conditions prevailing at anthesis (Quintana et al. 1984). The percentages of perfect or hermaphroditic flowers within panicles range

from less than 1 to over 75% in different mango cultivars growing in similar environments (Naik and Rao 1943; Cobin 1950, 1951; Singh 1954). Cultivars with the highest percentages of perfect flowers are usually the most prolific bearers in India. 'Haden' is well known for its unfruitfulness and erratic bearing habit in Florida and deeper in the tropics because only a small fraction of perfect flowers normally set fruit (Young 1942). The amount of fruit set depended upon flower sex ratio and the number of fruit set in 'Nam-Doc-Mai' (off season type) for every month varied significantly (Sirichai 1980).

Pollen viability has been considered to be a major factor limiting yields of mango (Davenport and Nuñez-Elisía 1997). 'Arumanis 143', a recently released mango cultivar in Indonesia, has low productivity mainly due to poor initial fruit set but produces well when interplanted with 'Lalijiwa' as a source of pollen (Kusumo 1995). Self-incompatibility has also been reported in other mango cultivars (Singh 1990). Studies in India revealed that some commercial cultivars such as 'Dashehari', 'Langra', 'Chausa', and 'Bombay Green' (Sharma and Singh 1970) and 'Alphonso', 'Goamankur', and 'Kesar' were self-incompatible and self-unfruitful, whereas cross-pollination increased fruit set and retention (Desai et al. 1985). Initial fruit set following self-pollination was negligible and the majority of self-fertilized fruit dropped within four weeks after pollination. Other studies support the use of 'Himayuddin' as a pollen donor, resulting in 50% more fruit set (Reddy and Ramayya 1976). Other cultivars such as 'Tommy Atkins', 'Kesar', 'Goa Mankur', and 'Ratna' have also been shown to be potent pollinizers through demonstrations of increased fruit set and retention (Shinde et al. 2001).

Staminate flowers lack an ovule and are therefore soon committed to separation from panicles. Unsuccessful union of the egg and sperm in hermaphroditic flowers results in no formation of an embryo. It is plausible that, in the absence of embryo formation in both flower types, those organs lack the ability to produce the hormone(s), such as auxin and possibly other classes of hormones, that are necessary for maintenance of the abscission zone and prevention of elevated ethylene formation. Each flower can, thus, be viewed as programmed to abscise unless saved by fertilization giving rise to production of protective factors before the onset of increased ethylene subsequent to separation layer formation.

B. Embryo Abortion

Although flower and early fruit abscission is likely caused by unsuccessful pollination events, fruit abscission from pea stage onward is most often associated with embryo abortion (Chandler 1958; Singh

1961b). Young (1942) reported that the high percentages of 'Haden' fruit drop early in the season are due to abortion of the ovule. Generally, degeneration of the ovule or embryo abortion, which hinders normal fruit development, seems to play an important role in induction of the abscission process at early stages of fruit development (Mukherjee 1953; Singh 1960b; Singh 1961b; Young and Sauls 1979) as evidenced by shriveling and blackening of the ovule sometimes observed in young abscised mango fruit (Singh 1954; Chandler 1958; Singh 1961b; Nuñez-Elisía and Davenport 1983, 1986). Degeneration of the egg synergids, polar nuclei, and antipodal cells in one or more ovules, shrinkage of ovule cells at an early stage, and embryo disintegration after anthesis resulted in early seed abortion in 'Gonzhen Hongmang' (Dong et al. 1997). Field observations also suggest, however, that abscission of both seeded and parthenocarpic (stenospermocarpic) fruit continues until harvest, indicating that environmental stresses or hormonal factors unrelated to the original reproductive degeneration may be involved in the induction of fruit abscission of 'Tommy Atkins' (Nuñez-Elisía and Davenport 1983). Embryo abortion appears to be one of the key factors in mango fruit abscission (Nuñez-Elisía and Davenport 1983, 1986); however, in some cases fruit with aborted embryos continue to grow, albeit small in size, until normal fruit maturity resulting in seedless fruit known as "nubbins."

Samples of seeded and seedless fruit of 'Tommy Atkins', collected during the high fruit drop period (first four weeks after fruit set), showed different abscission patterns in *in vitro* conditions (Nuñez-Elisía and Davenport 1983). Removal from trees of fruit explants that included the peduncles stimulated synchronous changes in the fruits that resulted in synchronous stimulation of ethylene production in all seeded fruits within 24 hr. Seedless fruits, however, did not display any increase in ethylene production over background. Consequently, all seeded fruit abscised within 72 hr after harvest, whereas 22% of seedless fruit were still attached 96 hr after harvest. Hormonal components produced by embryos may be essential for maintenance of the abscission zone, but the presence of the embryo also appears to be instrumental in triggering ethylene production in both the embryo and mesocarp that is responsible for forming the separation at the pedicel-peduncle abscission zone.

C. Insect Pests

Infestation of insect pests is one of the more important factors contributing to mango fruit drop. Among these, midges, caterpillars, hoppers, thrips, mites, fruit fly, and seed weevil are major contributors (Subramanian 1925; Peña and Mohyuddin 1997; Peña et al. 1997). Lists

of fruit-feeding pests affecting mango and their primary areas of influence are included in several publications (de Laroussilhe 1980; Tandom and Verghese 1985; Veerish 1989; Peña and Mohyuddin 1997). The mango gall midge or mango blister midge (*Erosoma mangiferae* Felt.) can cause drop of up to 70% of originally set fruit (Whitewell 1993), and the mango hopper (*Amritodus (=Iriocerus) atkinson*) is a major pest causing 25–60% fruit loss in India (Datar 1985). The coreid, *Pseudotherpatus wayi* (coconut bug), damages mango fruit by piercing it and causing necrotic spots, leading to early abscission in South Africa (Neethling and Joubert 1994). The red-banded mango caterpillar or seed borer (*Nozorda albizonalis* Hampson) has been reported to be a serious pest in some areas, spoiling fruit and sometimes causing heavy crop losses (Peña et al. 1997). Mango mealy bug has also been a serious pest causing great losses to immature fruit in India and Pakistan (Prasad and Singh 1976; Mohyuddin and Mahmood 1993). The mango weevil causes seed infestation and premature fruit drop in Hawaii (Follett and Gabbard 2000).

The mechanisms by which insect damage induce fruit abscission is probably as varied as the damage they incur. It is likely, however, that generation of ethylene is involved either through wound effects directly in affected tissues (Gutierrez Martinez et al. 2001) or through ethylene-producing pathogens associated with specific insect species (Duffy and Powell 1976). Effective control of all such pests is the only reasonable approach to reduce fruit losses due to insect damage.

An extensive amount of research has been conducted to control these pests with consequential reductions in fruit drop and increases in fruit yield. Among various insecticides tested, fenvalerate (sumicidin) at 0.01% performed well in controlling mango hopper populations and reducing fruit drop in 'Neelum' (Datar 1985). Endosulphan and Monitor have also provided good control (Nachiappan and Baskaran 1986; Mohyuddin and Mahmood 1993). Investigations in Bangladesh on chemical control of mango hopper revealed that cypermethrins and fenvalerate, when applied within 10 days after flowering and again after one month, were most effective and gave a higher percentage of pest reduction and increased fruit retention (Alam et al. 1996). Weekly applications of malathion during fruit development can provide effective control of fruit flies generally belonging to the genera *Anastrepha*, *Bactrocera*, and *Ceratitis* (Yee 1987; Peña and Mohyuddin 1997). Effective control of mango seed weevil was obtained with organophosphate (fenthion), pyrethroid (deltamethrin), and the carbamate (carbaryl) (Balock and Kozuma 1964; Shukla and Tandom 1985). Cyfluthrin and deltamethrin was successful in controlling red-banded mango caterpillar (Golez 1991). Control of mango mealy bugs has been achieved by wrapping burlap

around tree trunks to stop the climbing mealy bug nymphs, hoeing and plowing the soil around the tree trunks to expose and destroy eggs and nymphs, conserving predators such as *Sumnius renardi* Weise (Mohyuddin and Mahmood 1993), and by dusting chlorinated hydrocarbons on the soil (Srivastava 1981). Biological control of mango mealy bug holds great potential for reducing mango fruit drop losses and improving fruit yield. A significant reduction in mango mealybug in African countries with its natural enemies has an accrued estimated benefit of \$(US)531 million over 20 years, with a cost-benefit ratio of 145:1 resulting from savings in the cost of the pesticide Bennis alone (Bokonon-Ganta et al. 2002). There were no significant differences between synthetic (combinations of 0.003% cypermethrin, 0.7% endosulphan, and 0.04% monocrotophos) and various botanical insecticide treatments, i.e., three applications of 2.5% aqueous extracts of dried leaves of *Azadirachta indica*, *Gliricidia mutica*, and *Ipomoea carnea*, four commercial neem products (0.5% Achook, 0.5% Neemark, 1% Indiarara, and 2% Azadex), and three plant oils (0.1% mint oil, 2% atso tree oil, 2% savo spray oil) on control of mango hopper and thrips (*Scirtothrips mangiferae*) (Kumar and Bhatt 1999). All insecticide treatments, synthetic or botanical, significantly reduced the pest populations. The botanical insecticides also reduced fruit drop. Although pest management in the mango industry is currently dependent on the use of pesticides, increasing pest resistance to common pesticides, negative consumer attitudes toward pesticide use, and the desire for a safer environment are directing research toward integrated approaches to pest management involving pesticides when necessary but with increasing reliance on biological control measures using natural predators (Peña and Mohyuddin 1997).

D. Diseases

Infection by several mango blossom diseases results in poor fruit set and retention (Shiridhar and Sohi 1973; Palti et al. 1974; Fitzell 1981; Prior and Ryder 1987; Jefferies et al. 1990; Darvas 1992; Lonsdale and Kotze 1993; Ploetz and Prakash 1997). Four main blossom diseases, i.e., blossom blight (anthracnose), powdery mildew, blossom malformation, and blossom spot, are common whenever trees flower during wet or humid conditions. Anthracnose (*Colletotrichum gloesporioides*), a major pre-harvest disease in all mango-producing countries, is always associated with high rainfall and humidity (Fitzell and Peak 1984; Jefferies et al. 1990; Dalangin et al. 1994; Dodd et al. 1997; Ploetz and Prakash 1997). Powdery mildew (*Oidium mangiferae*) has been reported to be a sporadic disease occurring in panicles during especially moist conditions

that can cause up to 80–90% crop loss (Schoeman et al. 1995). *Alternaria* rot (*Alternaria alternata*), a blossom disease, is also known to cause reduced fruit set consequently resulting in poor yield (Cronje et al. 1990). Most of the diseases that affect flowers on panicles such as powdery mildew and blossom blight increase the incidence of heavy abscission in developing fruit. No information is available on the mechanisms of abscission induction in infected fruit.

Applications of contact and systemic fungicides during wet or humid weather are the most effective way of controlling anthracnose and blossom blight. Control is best achieved if fungicides are applied before flowering (Jeffries et al. 1990). Fungicides like benomyl and copper oxychloride (Thompson 1987) and mancozeb at 2 g L^{-1} applied weekly during bloom and then monthly until harvest (Johnson and Muirhead 1988) were effective in disease control. Blossom sprays at 20%, 60%, and 100% flowering, with systemic fungicides fludioxonil (2 g (ai) L^{-1}) or pyrazophos ($11.5 \text{ g (ai) L}^{-1}$) resulted in significantly better blossom disease control and consistently higher fruit set and yield (Lonsdale and Kotze 1993). Schoeman et al. (1995) recommended that the first application of fungicides be made when panicles change color, followed by repeated applications every three weeks. A combination of phosphate salt with “bio-compatible” fungicides such as diniconazole (Marit 12.5%), myclobutanil (Sisthane 12E), or penconazole (Ophir) have been reported to be successful for effective control of powdery mildew (Reuveni and Reuveni 1995). Powdery mildew can also be controlled by applying sulphur spray or copper oxychloride (Dodd et al. 1997). The prevalence and severity of powdery mildew was effectively reduced by two foliar sprays of sulphur (as Kumulus DF) at 2000 mg L^{-1} followed by propiconazole (as Tilt 250 EC) at 500 mg L^{-1} in Bangladesh (Reza and Mortuza 1997). Best fruit retention was recorded from sulfur-treated plants. Spray application of Maneb at $2.5 \text{ g (ai) L}^{-1}$ starting two to three weeks after fruit set was suggested for effective control of *Alternaria* (Dodd et al. 1997). The control of pests and diseases, particularly during flowering and fruit set, clearly result in significant reduction in fruit drop and improved yields. The emerging strobilurin class of systemic fungicides promises to make control even more effective (Goodwin and Clough 1997).

E. Temperature and Wind

Temperature extremes and high winds are known to negatively affect pollination, fruit set, and retention. In general, low temperatures during flowering adversely affect the development of male and female organs, pollination, and fertilization, resulting in low fruit set, high embryo

abortion, and fruit abscission. Pollination and poor fruit set problems due to unfavorably cool temperatures during floral anthesis are common wherever mangoes are grown in the sub-tropics (Whiley et al. 1988; Issarakraisila et al. 1992, 1994; Schaffer et al. 1994; Tsai et al. 1996; Dag et al. 2000). Tsai et al. (1996) concluded that early flowering in January/early February resulted in a higher incidence of seed abortion and consequently reduction of yields of 'Irwin' mango in Yuching, Taiwan. Temperature and precipitation during the 30 days after anthesis were more important than 10 days before flowering. Exposure to temperatures below 12°C during flowering interferes with pollen tube growth and/or fertilization of several polyembryonic and monoembryonic cultivars (Whiley et al. 1988; Dag et al. 2000). Mean daily temperatures below 15°C result in development of flowers with short styles, smaller-sized ovaries, and blackened anthers in 'Kensington Pride' (Issarakraisila et al. 1992). Cool temperatures (15° day/5°C night) also caused morphological changes in styles, stigmas, ovaries, and anther size in 'Nom Dok Mai', 'Kensington Pride', 'Irwin', and 'Sensation', and the changes were especially pronounced in 'Kensington Pride' (Sukhvibul et al. 1999). Exposure to temperatures below 15°C for as little as 12 hr also reduces pollen viability (Issarakraisila et al. 1994). Chilling injury has also been implicated in damage to stamens (Roizman 1984; Issarakraisila and Considine 1994), and pistils (Young and Sauls 1979) of other cultivars. High temperatures during flowering and the first few days of fruit set have also been correlated with embryo abortion (Nuñez-Eliséa and Davenport 1983). Fruit that set during periods of high temperature did not develop to maturity when compared with those set during lower temperature periods (Sirichai 1980).

Winds have also been implicated in fruit losses in certain areas. Chadha and Singh (1964) made observations on diurnal variation in fruit drop in three-mango cultivars and found that fruit drop during daytime was double that at night. It is unlikely that wind per se stimulated abscission in such conditions unless it was so strong that it contributed to fruit damage or evapotranspiration sufficient to cause water stress. It is more likely that wind provides sufficient force to remove partially abscised fruit. Because fruit abscission proceeds over a period of about 48 hr after induction (Nuñez-Eliséa and Davenport 1983, 1986), cell separation in the abscission zone advances over the period, thus reducing the force required to fully separate from the tree over time. It is plausible that fruit separate more during the day due to the general prevalence of higher wind forces during daylight hours over those at night. Randhawa and Chadha (1982) also reported that high temperatures and wind in certain areas contribute to shedding of fruit. Protection of mango trees during

summer from southeasterly winds by using artificial windbreaks resulted in a 600% increase in marketable fruit in the first year (Mayers et al. 1984). Contrarily, another study revealed that higher wind speed did not cause fruit drop, but that a tree beyond its maximum crop load may shed surplus fruit (Catchpoole and Bally 1991). Fruit retention per panicle was higher in the medium to late emerging panicles than the earlier emerging ones, and there seems to be a close relationship between warmer temperature and increased percentage of perfect flowers (Singh 1990).

F. Water Relations

In general, mango is adapted to withstand considerable periods of water stress (Whiley and Schaffer 1997), but reduced plant water potentials during the first four to six weeks of fruit set can affect fruit retention and yield. Water stress may be associated with ABA accumulation (Jia and Zhang 2000) and/or ethylene biosynthesis (Nakano et al. 2002) that can result in heavy fruit abscission.

Limited and sometimes conflicting information is available on the interaction of water stress, fruit abscission, and yield, and most of these studies have been conducted in relatively uncontrolled field conditions. Early investigations demonstrated that irrigation in the dry season from fruit set to monsoon reduced fruit drop (Hayes 1953). A degree of water stress during flower bud development has been reported to be advantageous for increasing yield (Singh 1967; Cull 1989; Larson and Schaffer 1989; Mostert and Hoffman 1997). Although mango can withstand moderate drought conditions for more than eight months, deficiency of water during bloom can severely reduce fruit retention (Gandhi 1955); however, Singh (1961a) was unable to establish a causal relationship between soil moisture and fruit drop. Rameshwar and Rao (1980) suggested that although fruit drop and final fruit retention are mostly varietal characters, water and nutritional stress increase fruit drop in susceptible trees. Other field evidence suggesting an influence of water availability on fruit retention comes from the report of a five-fold greater yield in a lowland 'Khiew Sawauy' mango orchard with 1–2% higher soil moisture than that of an upland orchard of the same cultivar (Sumrit 1992). Other unknown factors, however, could also contribute to the yield differences attributed to soil moisture. Pongsomboon (1991) conducted drought stress studies on three-year-old, fruit-bearing, containerized 'Irwin' plants. They were maintained at pre-dawn water potentials of -1.2 MPa and -0.3 MPa for the first two months after fruit

set. No initial differences in fruit drop between stressed and non-stressed plants were detected, but abscission increased in the stressed plants. Final fruit retention, however, was unaffected by this level of water stress, but fruit size was reduced. Singh and Arora (1965) reported similar results in a field study in which irrigation at weekly intervals during the first six weeks of fruit growth increased 'Dashehari' fruit retention as compared to irrigation at a three-week interval, but fruit drop increased in the weekly-irrigated trees at later stages of fruit development.

Optimum irrigation technologies and frequencies to maximize mango yields have been extensively examined in a variety of environmental conditions throughout the tropics. In a comprehensive three-year irrigation trial on 'Fascell' in South Africa, the highest average annual yield (127 kg/tree) was obtained from irrigation when soil water potential reached -30 kPa from spring to fall as compared to all other irrigation treatments evaluated. Lowest yield was obtained in control (no irrigation, rain only), but the water use efficiency (4 kg/fruit per m^3) was maximized (Wittwer 1991). In contrast, withholding irrigation during winter (May to August) increased annual production of mango by 9% and irrigation decreased it by 20% (Mostert and Hoffman 1997). Among various irrigation methods, drip irrigation significantly increased fruit retention in 'Carabao' in the Philippines (Covacha 1986). Fortnightly irrigation from full bloom onwards along with fertilizer treatments increased fruit retention when compared to controls in 'Carabao' (Bhuyan and Irabagon 1993). An Indian study, on the other hand, determined that irrigation at fortnightly intervals from October to January adversely affected fruiting in 'Dashehari' mango (Singh and Ram 1997).

Withholding irrigation during winter and irrigation at 20–40% depletion of soil moisture level during the rest of the period not only economizes water usage but also results in increased fruit yield. Chandel et al. (1992) reported that 15-year-old 'Dashehari' trees receiving irrigation at 20 or 40% soil moisture deficit showed higher fruit set and yield than non-irrigated trees or trees receiving other irrigation treatments. In a similar study in Himachal Pradesh, India by Ranbir et al. (1998), fruit retention was significantly higher in trees irrigated at 20% and 40% depletion of available soil moisture than those irrigated at 60% depletion and non-irrigated controls. There was 87% and 79% greater yield when irrigation was applied at 20 and 40% depletion of available moisture respectively over control. Trees required about 21–23 irrigation amounting to 124 cm of irrigation water per year at 40% available soil-moisture depletion level.

G. Nutrition

Sufficient availability of major and minor nutritional elements is a prerequisite for trees to carry normal fruit loads to maturity, and a good annual plan of plant nutrition is an important input for sustainable fruit production. The information available on nutritional aspects of mango fruit retention, however, is scanty, inconclusive, and difficult to interpret. Developing fruit require a continuous supply of all essential nutrients for proper growth and development (Samra and Arora 1997). Deficiency of any element can result in shedding of fruit since all are essential for growth and development. Elemental content per unit mass appears to be greatest during cell division in developing mango fruit as evidenced by maximum N, P, and K concentrations at pea stage and greatest Ca and Mg concentrations at post-bloom stage in 'Dashehari' (Pathak and Pandey 1977). The concentrations of all elements declined thereafter during cell expansion toward fruit maturity. Rameshwar and Rao (1980) reported that nutritional deficiencies can increase fruit drop in mango cultivars prone to fruit drop. Analyses of low- and high-yielding trees of 'Fazli', 'Himsaggar', 'Langra', 'Gopalbhog' ('Bombai'), and 'Aswina', at three times (January, July, and September) in West Bengal showed positive correlations between yield and levels of leaf and soil N and P (Rao and Mukherjee 1989). Leaf N concentrations in low-bearing trees were in the deficient (<1%) and severely deficient range (<0.68%).

Plant nutrient application either through soil or, in limited cases, foliar applications has yielded good results in fruit retention. Nutritional experiments on Langra showed that 1kg N + 2kg P + 1kg K application per tree in mid-September significantly increased fruit retention (Syamal and Mishra 1989).

Several N-containing compounds or combinations of compounds have proved beneficial in improving fruit set and retention. Urea has proved beneficial at various spray concentrations in a number of cultivars (Singh 1961b; Samra et al. 1977; Chandra 1988). Urea in combination with other nutrients has also improved retention. The number of fruit per panicle was increased with urea and double superphosphate at 2% and 4%, sprayed alone or in combination during December, April, and August (Singh 1972). Increased fruit retention was achieved in 'Bombay' using spray application of 1% urea + 1.35% KCl at a monthly interval from September to December (Hoda and Kumar 1975); however, fruit drop increased with higher concentrations of urea from 4 to 6% in 'Totapuri' and 'Langra' (Rajput and Tiwari 1975). An 88% increase in yield was reported with

foliar application of 0.5% ortho phosphoric acid and 2% urea in September, November, and March (Reddy and Majumdar 1983). Soil application of gypsum and a spray of calcium chloride and 0.75% calcium nitrate and 1.75% magnesium sulphate had no significant effects on fruit drop (Arora 1961). Foliar application of 4% KNO_3 at full bloom increased fruit retention of 'Tommy Atkins', whereas double application of the same dose in 'Heidi' or two applications at 2% increased fruit retention to a greater extent in 'Kent' (Oosthuysen 1997). Other reports of 2% KNO_3 on 'Carabao' also confirm its efficacy in increasing fruit retention (Bhuyan and Irabagan 1993). Based on a seven-year study, Covacha (1996) found that foliar application of Nutraphos super K, during flowering and fruiting, increased fruit retention significantly in 'Carabao' in the Philippines.

Combined application of nutrients and growth regulators have also been reported to increase fruit retention in different cultivars of mango. Urea (4%) + 40 mg L^{-1} NAA (Singh 1977a); urea (6%) + 30 mg L^{-1} GA_3 (Rajput and Singh 1983); urea (2–4%), KNO_3 (1.5–3%) and 400 mg L^{-1} NAA (Sharma et al. 1990) all demonstrated improved fruit set. Care must be taken in all such studies to insure differentiation between hormonal and nutritional effects. This also applies to foliar spray nutritional studies. It is useful to know the background nitrogen content of leaf tissues in order to determine whether the increased fruit retention response is due to the influx of additional nitrogen via the foliage or simply correction of a nitrogen deficiency in the plants.

Micronutrients affect fruit retention as well as yield (Mallik and Singh 1959; Anon. 1976; Nijjar et al. 1976). Positive responses to micronutrient applications confirm their indispensable role in mango fruit retention, thereby increasing yield (Nijjar et al. 1976; Rameshwar and Kulkarni 1979). Boron (Vasil 1963; de Wet et al. 1989) and zinc (Jiron and Hedstrom 1985) are of special significance to fruit retention. Samra and Arora (1997) suggested that considerable losses in mango yield could occur without obvious visual signs of deficiency symptoms necessitating a pro-active and more scientific approach to remedial measures. Spraying mango during January with 0.2–0.8% ZnSO_4 resulted in increased perfect flower per panicle and yield in India (Singh and Rajput 1977). Fruit drop in 'Banganapalli' was reduced by application of a micronutrient mixture, consisting of zinc, boron, manganese, and molybdenum (Rameshwar and Kulkarni 1979). Maximum fruit retention was observed following 0.8% ZnSO_4 spray application during January (Daulta et al. 1981). Foliar application of 3 g L^{-1} boric acid to 'Dasehri' mango at late bud swelling stage also resulted in higher fruit retention than that of control (Singh and Dhillon 1987).

In general, both the macro- and micronutrients play an important part in plant growth, fruit set, fruit development, fruit retention, and yield. The major contributor to high yields is N (Samra and Arora 1997). P is required in maintaining good fruit set, whereas K is thought to alleviate stress responses brought on by drought, frost, pest, and disease organisms (Samra and Arora 1997), which are known to cause fruit drop. Zn appears to be effective in increasing the proportion of perfect flowers and subsequent yield (Singh and Rajput 1977). Boron alone or in combination with Zn increased panicle size, fruit size, and weight as well as improved quality (Singh 1977b; Rath et al. 1980). In order to control fruit drop, maintaining a balanced nutritional program with each element optimized is essential.

IV. ENDOGENOUS FACTORS AFFECTING FRUIT DROP

A. Genotype

Cultivars with the highest percentage of perfect flowers are usually the most prolific (Naik and Rao 1943; Singh 1954), and the percentage of fruit drop and final retention is mostly a cultivar characteristic (Rameshwar and Rao 1980). Sanyal and Maity (1989), however, found no significant differences in fruit retention among five cultivars. The fruit-drop count from 20 days after fruit set showed maximum drop in 'Tommy Atkins' (12,133 fruit/tree) followed by 'Manila' (4,293 fruit/tree), 'Haden' (3,194 fruit/tree), 'Kent' (2,817 fruit/tree), and 'Keitt' (2,258 fruit/tree) when compared in a three-year trial in Mexico (Guzman Estrada 1996). Such results, however, are difficult to assess without normalization to the original average number of fruit set in each cultivar. 'Tommy Atkins', 'Kent', and 'Heidi' retained few fruit when compared with 'Sensation', 'Irwin', and 'Keitt' in South Africa (Oosthuysen 1997). Comparison of 16 cultivars in West Bengal revealed that the total percentage fruit drop was high in all cultivars, varying from 75.7% in 'Himsagar' to 100% in 'Mallika' in 1995, and from 89.5% ('Mallika') to 98.3% ('Bombay Yellow') in 1996. A study on three commercial mango cultivars in Faisalabad, Pakistan revealed that fruit drop percentage was high during the initial two weeks after fruit set, with maximum drop in 'Anwar Rataul' (96.3%), followed by 'Langra' (90.3%), whereas 'Dashehari' exhibited the highest final fruit retention and was regarded as the best-performing cultivar (Asif et al. 2002). Thus, variation in fruit drop percentage may be ascribed to both cultivar and environmental factors (Jana and Sharangi 1998). The variation in fruit drop among different mango cultivars,

however, provides circumstantial evidence that fruit drop is strongly influenced by genotype.

B. Competition for Photoassimilates

Krisanapook et al. (1999) found that fruit growth of 'Khiew Sawoey' mango was almost unnoticeable during weeks one to four after bloom, and growth later increased remarkably. Most of the small-sized fruit (about 0.5 g), as compared to larger size fruits (about 7 g), that were observed at four weeks later dropped. Most fruit abscission occurred during the first to third week after full bloom, decreased thereafter, and was no longer observed in week six. Increase in fruit growth coincided with maximum peaks of endogenous GA₃ and cytokinin-like substances in week five. The author concluded that the slower-growing fruit (smaller size) were more prone to abscission possibly due to competition for photoassimilates and lower production of endogenous growth hormones.

Purnomo (1986) suggested that competition between developing vegetative shoots and fruit for photoassimilates causes fruit drop and that vegetative flushing on non-bearing stems that coincides with fruit development should be depressed to provide better availability of carbon resources for developing fruit. Kulkarni (1989) studied the effect of post-bloom vegetative flushing on fruit retention in 'Alphonso' and recorded heavy flower and fruit drop on stems with flushing lateral shoots compared to non-flushing stems. Not a single fruit carried beyond pea stage. Fruit set and retention on non-flushing stems was high in comparison. Senescence and wilting of immature fruit on stems with flushing shoots were observed soon after shoot initiation. Generally, as vegetative shoots started growing rapidly, the entire panicle wilted and dropped. Adjacent, non-flushing shoots were not affected. Removal of post-bloom vegetative shoots resulted in fruit retention, almost equaling the non-flushing stem performance. A possible explanation of this effect was competition between vegetative growth and developing fruit. Post-bloom flushing tends to occur more in young trees and in biennial bearing cultivars like 'Alphonso' and 'Langra' than in old and regular-bearing cultivars such as 'Survernareka', 'Cherukurasam', and 'Royal Special'. An extensive screening study of 68 Indian mango cvs revealed a 'recurring flowering' disorder in 28 mango cvs causing severe fruit drop at initial stages of fruit growth. The new flowering panicles emerge from the base of the existing panicles and this recurring flowering occurs 45–60 days after the emergence of the main panicle. The incidences were most common in 'Alphonso' (19%), causing fruit loss of 63% at peanut, 29% at

marble, and 8% at egg stage. Spray application of GA₃ (150 ppm) significantly reduced the incidence (1.25%) compared with control (Burondkar et al. 2000).

Although it is logical to associate fruit loss during post-bloom vegetative growth with photoassimilate partitioning and competition between the fruit and vegetative shoot growth in mango, there is no scientific evidence to support such a conclusion. Evidence of fruit set and retention in avocado stems during which vegetative growth occurs distal to fruiting structures provides reason to reject such a conclusion (Finazzo et al. 1994). Interaction of phytohormones or their spatial distribution in stems could be an equally compelling explanation for the phenomenon.

V. MANAGEMENT PRACTICES AFFECTING FRUIT DROP

A. Fruit Thinning

Post-flowering fruit drop in 'Sensation' mango has been associated with flowering intensity (Oosthuysen and Jacobs 1997b). High initial fruit set can likewise lead to excessive abscission in some mango cultivars. A preliminary study in South Africa demonstrated that fruit thinning during November reduced further fruit drop in 'Sensation' (Davie and Stassen 1997). Moreover, fruit thinning in November combined with the removal of half of the inflorescences per tree reduced further fruit drop and increased the size of the remaining fruit. Pruning back half of the branches was more advantageous than hand thinning to reduce fruit drop. Fruit thinning at earlier stages of fruit development has been suggested to reduce the depletion of carbohydrate reserve and may be used as a tool to improve fruit retention of remaining fruit. It may be used in cultivars with high initial fruit set provided this practice is cost effective. Chemical fruit thinning could be useful in this regard.

B. Girdling

Girdling of branches after fruit set has been reported to reduce fruit drop in 'Dashehari' mango, through accumulation of carbohydrates (Arora 1961). Studies showed that bagging mango fruit with blue plastic bags with a hole in the bottom in the period of 60 days after anthesis reduced fruit drop to 28% as compared to control (70%) in 'Nam Dok Mai Twai No. 4'; however, fruit splitting occurred more in bagged fruits (Yuenyong 1986). Girdling and fruit bagging seems to be helpful in

reducing fruit drop, but on a commercial scale their application is not cost effective.

C. Intercropping

One report on the impact of plants growing adjacent to mango on fruit drop has revealed the potential adverse effects of intercropping on fruit drop (Sharma 1999). The intensity of fruit drop appears to vary with the nature of intercrop species and the management practices being adopted. A two-year study on intercropping of other crops with six-year and older mango trees revealed that intercrops such as okra in Kharif (summer season), gram in Rabi (winter season), and then okra in summer stimulated high fruit drop. Similarly, intercropping with chili as a long-duration annual crop or soybeans in Kharif and chili in Rabi, also resulted in more fruit drop than in non-interplanted trees; however, intercrops enhanced profit by generating additional monetary returns. Beyond a possible competition for soil nutrients, an explanation for this phenomenon is lacking.

VI. CONCLUSION

Fruit abscission is a complex phenomenon strongly influenced by genetics, physiological, cultural, and environmental factors. It occurs at any time during fruit development and is excessively high during the initial four weeks after fruit set. Inadequate pollination, fertilization, and self-incompatibility lead to early loss of flowers and fruit, and embryo degeneration precipitates consequent fruit drop. The abscission zone forms at the pedicel-peduncle junction during flower development and is the site of activation of the separation layer. It continues to develop and enlarge with the pedicel as fruit develop. This layer of cells is oriented in a plane perpendicular to the axis of the pedicel. When activated, it forms hydrolytic enzymes responsible for cell wall dissolution in the cortex, separation of those cells within 48 hrs, and protection of the newly exposed stem lesion.

The primary phytohormones regulating the activity of this layer are auxin, acting as the suppressor of abscission, and ethylene, acting as the inducer. The fertilization process and preservation of the embryo during fruit development are essential to fruit set and retention to maturity. Formation and continued development of the embryo appears to be essential to furnish a continuous supply of auxin for maintaining the integrity of the abscission zone. Abortion of the embryo in individual

fruit is also coincident with increased ethylene production that induces separation from the tree. The roles of other classes of phytohormones, such as cytokinins, gibberellins, abscisic acid, and polyamines are not clear, but they may involve regulation of auxin and ethylene biosynthesis, metabolism, or action. The effectiveness of the various growth regulators that mimic or regulate the biosynthesis, metabolism, or action of the several classes of phytohormones in reducing fruit abscission is influenced by genotype, concentration, and time of application. Their use, however, promises to provide the highest likelihood of establishing recommended protocols for consistently high mango yields.

Environmental impacts on fruit set and retention are likely mediated through alterations in phytohormone levels or action. Low or high temperature during fruit set leads to excessive early fruit drop. Breeding and introduction of self-compatible traits that are tolerant to low and high temperatures during pollination and fertilization could provide commercial growers with cultivars capable of substantially increased yields. Studies have been recently reported on differential gene expression during abscission of fruit and other plant organs. The expression of genes, particularly those involved in ethylene biosynthesis encoding for ACC synthase and/or ACC oxidase in fruit and pedicels, during various phases of development and their regulation possibly holds promise for future research on mango fruit abscission (Cruz-Hernandez et al. 1997; Hamilton et al. 1990)

Information on the role of post-bloom vegetative flushes and crop load on fruit abscission is scanty and inconclusive. Although the impacts of management of mineral nutrition, diseases, and insect pests have been reported, an integrated approach involving each of these components to reduce fruit losses is yet to be exploited. Some research has also been reported on improved yields and quality through scheduling of irrigation to minimize fruit drop and water usage. Future investigations should address the use of irrigation tools such as regulated deficit irrigation and partial root zone drying to reduce fruit abscission since activities of endogenous phytohormones such as abscisic acid, ethylene, and gibberellins are closely related to plant water relations.

LITERATURE CITED

- Abeles, F. B., P. W. Morgan, and M. E. Saltveit. 1992. Ethylene in plant biology. 2nd ed. Academic Press, San Diego.
- Abou Rawash, M., N. Abou El Nasr, H. El Masry, and S. Ebeed. 1998. Effect of spraying some chemical substances on flowering, fruit set, fruit drop, yield and fruit quality of Taimour [Egyptian] mango trees. *Egypt. J. Hort.* 25:83-99.

- Addicott, F. T. 1983. Abscisic acid. Praeger Press, New York.
- Alam, S. N., D. Sarker, M. A. Karim, and M. J. Uddin. 1996. Field evaluation of some insecticides for the control of mango leafhoppers (*Idioscopus* spp.). Bangladesh J. Entomol. 6:95–102.
- Andam, C. J. 1983. Response of maturing “Carabao” mango fruits to pre-harvest ethephon application. NSTA-Technol. J. 8:4–13.
- Anon. 1961. Annual report (1958–61) of the coordinated scheme to study the application of growth regulating substances in horticulture in the Punjab. Fruit section, Punjab, Patiala, India.
- Anon. 1976. Report of Fruit Research Workshop, All India Coordinated Research Project. Indian Council of Agr. Res., Hyderabad. p. 335–336.
- Aravindakshan, K., C. Ramachandran, and I. S. Pynadath. 1979. Effect of planofix on fruit set in mango var. Neelum. Agri. Res. J. Kerala 17:105–107.
- Arora, K. S. 1961. Study on fruit drop in mango (*Mangifera indica* L.), IARI, Ph.D. Thesis, New Delhi, India.
- Arora, K. S., and R. Singh. 1964. Effect of plant growth regulators on fruit drop, fruit quality and seed germination in mango. Indian J. Agr. Sci. 34:46–55.
- Asif, M., M. Usman, B. Fatima, M. J. Jaskani, and M. M. Khan. 2002. Fruit set and drop behaviour of three commercial cultivars of mango. Pakistan J. Agr. Sci. 39:129–131.
- Aziz, A., O. Brun, and J. C. Audran. 2001. Involvement of polyamines in the control of fruitlet physiological abscission in grapevine (*Vitis vinifera*). Physiol. Plant. 113:50–58.
- Bains, K. S., G. S. Bajwa, and Z. Singh. 1997a. Abscission of mango fruitlets. II. In relation to the activity of indole-3-acetic acid oxidase and peroxidase in fruitlets. Fruits 52:307–312.
- Bains, K. S., G. S. Bajwa, and Z. Singh. 1997b. Abscission of mango fruitlets. I. In relation to endogenous concentrations of IAA, GA₃ and abscisic acid in pedicels and fruitlets. Fruits 52:159–165.
- Balock, J. W., and T. Kozuma. 1964. Notes on the biology and economic importance of the mango weevil *Stenochetus mangiferae* (Fabricius) (Coleoptera: cruculionidae), in Hawaii. Proc. Hawaii. Entomol. Soc. 18:353–364.
- Barnell, E. 1939. Studies in tropical fruits. Some anatomical aspects of fruit fall in two tropical arboreal plants. Ann. Bot. 21:257–271.
- Beyer, E. M. J. 1976. A potent inhibitor of ethylene action in plants. Plant Physiol. 58:268–271.
- Bhatt, R. I., K. Sushil, and S. Kumar. 1997. Response of plant growth regulators on flowering and fruiting in Alphonso mango trees. Gujarat Agr. Univ. Res. J. 22:88–95.
- Bhuyan, M. A. J., and J. A. Irabagon. 1993. Effect of fertilizer, potassium nitrate and irrigation on fruit drop of ‘Carabao’ mango. S. Indian Hort. 41:315–321.
- Bijhouwer, A. P. C. 1937. Een Bijdrage tot de Kennis Omtrent het Bloein en het Vrucht-dragende, Vermogen van den Mangga (*Mangifera indica* L.) [A contribution to the knowledge of the flowering and fruiting habits of the mango tree (*Mangifera indica* L.)]. H. Veenman and Zonen, Wageningen.
- Bokonon-Ganta, A., A. H. de-Groote, and P. Neuenschwander. 2002. Socio-economic impact of biological control of mango mealybug in Benin. Agr., Ecosyst. Environ. 93:367–378.
- Bonghi, C., P. Tonutti, and A. Ramina. 2000. Biochemical and molecular aspects of fruitlet abscission. Plant Growth Regul. 31:35–42.
- Bonghi, C., B. Ruperti, A. Rasori, P. Tonutti, and A. Ramina. 1998. Biology and biotechnology of the plant hormone ethylene II. p. 31–32. In: Proc. EU-TMR-Euroconference Symp., Thira (Santorini), Greece. Kluwer Academic Publ., Dordrecht, Netherland.

- Bouchereau, A., A. Aziz, F. Larher, and J. Martin-Tanguy. 1999. Review: polyamines and environmental changes: recent developments. *Plant Sci.* 140:103–125.
- Brady, C. J., and J. Speirs. 1991. Ethylene in fruit ontogeny and abscission, p. 235–258. In: A. K. Matoo and J. C. Suttle (eds.), *The plant hormone ethylene*. CRC Press, Boca Raton, FL.
- Brown, K. M. 1997. Ethylene and abscission. *Physiol. Plant.* 100:567–576.
- Brummell, D. A., C. R. Bird, W. Schuch, and A. B. Bennett. 1997a. An endo-1,4- β -glucanase expressed at high levels in rapidly expanding tissues. *Plant Mol. Biol.* 33:87–95.
- Brummell, D. A., C. Catala, C. C. Lashbrook, and A. B. Bennett. 1997b. A membrane-anchored E-type endo-1,4- β -glucanase is localized on Golgi and plasma membranes of higher plants. *Proc. Natl. Acad. Sci. (USA)* 94:4794–4799.
- Burg, S. P. 1968. Ethylene, plant senescence and abscission. *Plant Physiol.* 43:1503–1511.
- Burns, J. K., D. J. Lewandowski, C. J. Nairn, and G. E. Brown. 1998. Endo-1,4-beta-glucanase gene expression and cell wall hydrolase activities during abscission in Valencia orange. *Physiol. Plant.* 102:217–225.
- Burondkar, M. M., J. C. Rajput, G. M. Waghmare, B. M. Jamadagni, and S. A. Chavan. 2000. Recurrent flowering: a new physiological disorder in Alphonso mango. *Acta Hort.* 509:669–673.
- Catala, C., J. K. C. Rose, and A. B. Bennett. 1997. Auxin regulation and spatial localization of an endo-1,4- β -D-glucanase and a xyloglucan endotransglycosylase in expanding tomato hypocotyls. *Plant J.* 12:417–426.
- Catchpoole, D., and I. Bally. 1991. Do “Mango Winds” cause fruit drop? *Queensland Fruit Veg. News* 24 Oct.
- Chacko, E. K., and R. N. Singh. 1969. Induction of parthenocarpy in mango (*Mangifera indica* L.). *HortScience* 4:121–123.
- Chacko, E. K., R. B. Kachur, and R. N. Singh. 1970. Changes in levels of acidic and neutral growth promoters during fruit development in Dashehari mango (*Mangifera indica* L.). *J. Hort. Sci.* 45:341–349.
- Chacko, E. K., R. R. Kohli, and G. S. Randhawa. 1972. Studies on the effect of 2-chloroethyl phosphonic acid (Ethrel) on mango. I. Flower induction in an ‘off’ year by Langra trees. *Indian J. Hort.* 29:1–4.
- Chadha, K. L. 1993. Fruit drop in mango. p. 1131–1166. In: K. L. Chadha and O. P. Pareek (eds.), *Adv. Hort.*, Vol. 3. Malhotra Publishing House, New Delhi.
- Chadha, K. L., and K. K. Singh. 1963. Effect of NAA, 2, 4-D and 2, 4, 5 T-P on fruit drop, size and quality of Langra mango. *Indian J. Hort.* 20:30–33.
- Chadha, K. L., and K. K. Singh. 1964. Fruit drop in mango. I. Fruit set and its retention and factors affecting it. *Indian J. Hort.* 20:172–185.
- Chandel, J. S., S. Ranbir, R. Singh, and S. Subhadrabandhu. 1992. Effect of different irrigation levels on growth, cropping and mineral composition of mango (*Mangifera indica* Linn.). *Acta Hort.* 321:561–565.
- Chandler, W. H. 1958. *Evergreen orchards*. 2nd ed. Lea and Febiger, Philadelphia.
- Chandra, A. 1988. Note on control of pre-harvest fruit drop in mango. *Curr. Agr.* 12:91–92.
- Chen, H., M. Huang, H. B. Chen, and M. Y. Huang. 1995. Fruit growth and abscission of the mango (*Mangifera indica* L.) Zihua. *J. South China Agr. Univ.* 16:73–77.
- Chen, W. S. 1981. Physiological studies of fruiting in mango trees. II. Effect of endogenous growth substances on fruiting. In: *Proceedings National Science Council Part B, Life Sciences*, Taipei, Republic of China.
- Cobin, M. 1950. Mango selection, propagation and culture. *Fla. Agr. Expt. Sta. Annu. Rep.* 1950:243–246.

- Cobin, M. 1951. Mango selection, propagation and culture. Fla. Agr. Expt. Sta. Annu. Rep. 1951:257–259.
- Covacha, S. A. 1986. Response of carabao mango (*Mangifera indica* L.) to methods of irrigation. Philippines Univ., Los Baños, College, Laguna, Philippines. p. 83.
- Covacha, S. A. 1996. Foliar fertilization for Guimaras-grown ‘Carabao’ mango. p. 59–60. In: Regional R & D Symposia, Los Baños, Laguna, Philippines. 27 June–12 Sept. PCARD, Philippines.
- Crane, J. H., I. S. E. Baley, R. V. Mosqueda-Vazquez, and E. Tomer. 1997. Crop Production. p. 203–256. In: R. E. Litz (ed.), The mango: Botany, production and use. CAB Int., Wallingford, UK.
- Crisosto, C. H., M. D. Vasilakakis, P. B. Lomard, D. Richardson, R. Tetley. 1986. Effects of ethylene inhibitors on fruit set, ovule longevity, and polyamine levels in ‘Comice’ pear. Acta Hort. 179:229–236.
- Cronje, C., F. C. Wehner, and J. M. Kotze. 1990. *Alternaria alternarata* as a lesion pathogen of mango inflorescences in South Africa. Phytophylactica 22:117–118.
- Cruz-Hernandez, A., M. Gomez-Lim. and R. E. Litz. 1997. Transformation of mango somatic embryos. Acta Hort. 455:292–298.
- Cull, B. W. 1989. Mango crop management. Acta Hort. 291:154–173.
- Dag, A., D. Eisentein, and S. Gazit. 2000. Effect of temperature regimes on pollen and the effective pollination of ‘Kent’ mango in Israel. Scientia Hort. 86:1–11.
- Dahsham, D. I., and S. Habib. 1985. Seasonal changes in endogenous auxin like substances in relation to fruit drop in mango. Suez Canal Univ., Ismaileyah 2:769–780.
- Dalangin, L., F. B. Javier, R. D. Bugante, Jr., and C. Oliveros. 1994. Mango production: effect of bagging, monitoring and intervention. Philippines J. Crop Sci. 19:13.
- Darvas, J. M. 1992. *Dothiorella dominicana*, a new mango pathogen in South Africa. Phytophylactica 23:295–298.
- Datar, V. V. 1985. Synthetic pyrethroids in the control of mango hoppers (*Amritodus atkinsoni* Leth.). Pesticides 19:13–14.
- Daulta, B. S., H. K. Singh, and K. S. Chuhan. 1981. Effect of zinc and CCC sprays on flowering, fruiting and physio-chemical composition of fruit in mango (*Mangifera indica* L.) cv. Dashehari. Haryana J. Hort. Sci 10:161–165.
- Davenport, T. L., and R. Nuñez-Eliséa. 1997. Reproductive physiology. p. 69–146. In: R. E. Litz (ed.), The mango: Botany, production and uses. CAB Int., Wallingford, UK.
- Davie, S. J., and P. J. C. Stassen. 1997. The effect of fruit thinning and tree pruning on tree starch reserves and on fruit retention of ‘Sensation’ mango trees. Acta Hort. 455:160–166.
- de Laroussilhe, F. 1980. Le Manguier. GP Maisonneuve and Larose, Paris.
- del Campillo, E., and A. B. Bennett. 1996. Pedicel breakstrength and cellulase genes expression during tomato flower abscission. Plant Physiol. 111:813–820.
- Desai, A. G., V. P. Limaye, and R. T. Gunjate. 1985. Floral biology of Alphonso, Goamankur and Kesar varieties of mango. J. Maharashtra Agr. Univ. (India) 10:193–195.
- Desai, U. T., S. D. Masalkar, S. M. Choudhari, P. N. Kale, and P. K. Nagre. 1994. Floral biology of mango hybrid Sai-Sugandh (RHR-M-1). Recent Hort. 1:11–13.
- de Wet, E., P. G. Robertse, and H. T. Groeneveld. 1989. The influence of temperature and boron on pollen germination in *Mangifera indica* L. South. Afr. J. Plant Soil 6:230–234.
- Dodd, J. C., D. Prusky, and P. Jeffries. 1997. Fruit Diseases. p. 257–280. In: R. E. Litz (ed.), The mango: Botany, production and uses. CAB International, Wallingford, Oxon, UK.
- Dong, J., D. C. Chen, G. B. Hu, B. P. Zhou, and S. X. Lin. 1997. Study on the mechanism of seedlessness in mango. J. South China Agr. Univ. 18:42–46.

- Duffy, J. E., and R. D. Powell. 1976. Ethylene production in cotton induced by an infestation of fleahoppers, *Pseudatomoselis seriatus*. *Plant Physiol.* 57 S: 97.
- El-Nabawy, S. M., A. A. M. El Hammady, A. S. Khalifa, M. A. Rawash, and H. M. El Masry. 1983. Studies on floral induction, sex expression and fruit drop in relation to alternate bearing habit of 'Langra' and 'Ewais' mango cultivars. *Ann. Agr. Sci. Univ. A'in Shams* 28:213–225.
- FAO. 2002. FAO STAT 2002 [Online] www.fao.org.
- Faunt, M., and S. Y. Wang. 1992. Polyamines in horticulturally important plants. *Hort. Rev.* 14:333–356.
- Finazzo, S. F., T. L. Davenport, and B. Schaffer. 1994. Partitioning of photoassimilates in avocado (*Persea americana* Mill.) during flowering and fruit set. *Tree Physiol.* 14:153–164.
- Fitzell, R. D. 1981. Effect of regular application of benomyl on the population of *colletotrichum* in mango leaves. *Trans. Brit. Mycol. Soc.* 77:529–533.
- Fitzell, R. D., and C. M. Peak. 1984. The epidemiology of anthracnose disease of mango; Inoculum sources, spore production and dispersal. *Ann. Appl. Biol.* 104:53–59.
- Follett, P. A. and Z. Gabbard. 2000. Effect of mango weevil (Coleoptera: Curculionidae) damage on mango seed viability in Hawaii. *J. Econ. Entomol.* 93:1237–1240.
- Gandhi, S. R. 1955. The mango in India. Indian Council of Agri. Res., New Delhi Farm Bull. 6.
- Gill, A. P. S., and S. K. Mukherjee. 1967. Control of fruit drop in mango. p. 454–467. In: *Proc. Int. Symp. Trop. Sub-trop. Hort.*, New Delhi, India.
- Gill, A. P. S. 1966. Studies on fruit set and drop in mango (*Mangifera indica* L.). Ph.D. Thesis, Delhi Univ. Postgraduate School, New Delhi.
- Gokhale, A. V., and U. K. Kanitkar. 1951. Fruit drop in Alphonso mango and its control. *Proc. Indian Sci. Congr.* 38:151.
- Golez, H. G. 1991. Bionomics and control of the mango seed borer, *Noorda albizonalis* hampton (Pyrilidae: Lepidoptera). *Acta Hort.* 291:418–424.
- Gonzalez-Carranza, Z. H., E. Lozoya-Gloria, and J. A. Roberts. 1998. Recent developments in abscission: Shedding light on the shedding process. *Trends Plant Sci.* 3:10–14.
- Goodwin, J. R., and J. M. Clough. 1997. Azoxystrobin: a novel agricultural fungicide inspired by the naturally occurring strobilurins and oudemansins. *Proc. 24th Annu. Meet. Plant Growth Reg. Soc. Am.*, Atlanta. p. 74.
- Gunjate, R. T., D. P. Jorwekar, and B. L. Lad. 1983. Pollination, fruit set and fruit drop in Alphonso mango India. *J. Maharashtra Agr. Univ.* 8:168–170.
- Gutierrez Martinez, P., R. Lopez Gomez, and M. A. Gomez-Lim. 2001. Identification of an ETR 1-homologue from mango fruit expressing during fruit ripening and wounding. *J. Plant Physiol.* 158:101–108.
- Guzman Estrada, C. 1996. Fruit drop and yield of five mango cultivars in Southern Sinaloa. *Acta Hort.* 455:459–464.
- Haidry, G. A., B. Jala Ud Din, A. Ghaffoor, and M. Munir. 1997. Effect of naphthalene acetic acid (NAA) on the fruit drop, yield and quality of mango (*Mangifera indica* L.) cultivar Langra. *Scientific Khyber*:13–20.
- Hall, D. S. 1973. Cytokinin from Zea mays. *Phytochemistry* 12:2445–2455.
- Hamilton, A., G. Lycett, and D. Grierson. 1990. Antisense gene that inhibits synthesis of the hormone ethylene in transgenic plants. *Nature* 346:284–287.
- Hayes, W. B. 1953. Fruit growing in India. Kitabistan, Allahabad, India.
- Hoda, M. N., and R. Kumar. 1975. Nutritional studies on mango. *Proc. Bihar Acad. Agr. Sci.* 22/23:49–52.
- Issarakraisila, M., and J. A. Considine. 1994. Effect of temperature on microsporogenesis and pollen viability in mango cv 'Kensington'. *Ann. Bot.* 73:231–234.

- Issarakraisila, M., J. A. Considine, and D. W. Turner. 1992. Seasonal effects on floral biology and fruit set of mangoes in a warm temperate region of Western Australia. *Acta Hort.* 321:626–635.
- Issarakraisila, M., J. A. Considine, and D. W. Turner. 1994. Effect of temperature on pollen viability in mango cv. Kensington Pride. *Ann. Bot.* 72:231–240.
- Jagirdar, S. A. P., and M. R. Choudhry. 1967. Fruit drop control in mango by hormonal spray. *W. Pakistan J. Agr. Res.*:33–42.
- Jana, A., and A. B. Sharangi. 1998. Fruit drop in different varieties of mango (*Mangifera indica* L.). *Environ. Ecol.* 16:127–131.
- Jawanda, J. S., and K. K. Singh. 1961. Floral biology and fruit drop in some mango varieties of Punjab. *Indian J. Agr. Sci.* 31:81–91.
- Jeffries, P., J. C. Dodd, M. J. Jeger, and R. A. Plumbley. 1990. The biology and control of *Colletotrichum* species on tropical fruit crops. *Plant Pathol.* 39:343–366.
- Jia, W., and J. Zhang. 2000. Water stress-induced abscisic acid accumulation in relation to reducing agents and sulfhydryl modifiers in maize plant. *Plant Cell Environ.* 23:1389–1395.
- Jiron, L. F., and I. Hedstrom. 1985. Pollination ecology of mango (*Mangifera indica* L.) (Anacardiaceae) in a neotropic region. *Turrialba* 35:269–277.
- Johnson, G., and I. Muirhead. 1988. Post harvest disease control of mangoes. *Queensland Fruit Veg. News* 59:16–17.
- Kalaitzis, P., S. M. Koehler, and M. L. Tucker. 1995. Cloning of a tomato polygalacturonase expressed in abscission. *Plant Mol. Biol.* 28:647–656.
- Kalaitzis, P., T. Solomos, and M. L. Tucker. 1997. Three different polygalacturonases are expressed in tomato leaf and flower abscission, each with a different expression pattern. *Plant Physiol.* 113:1303–1308.
- Kazokas, W. C., and J. K. Burns. 1998. Cellulase activity and gene expression in citrus fruit abscission zones during and after ethylene treatment. *J. Am. Soc. Hort. Sci.* 123:781–786.
- Kennard, W. C., and H. W. Wintes. 1956. The effect of 2, 4, 5-TP application on the size, maturation and quality of Amini mango (*Mangifera indica* L.). *Proc. Am. Soc. Hort. Sci.* 67:290–297.
- Khan, M. A., A. B. Malik, M. I. Makhdoom, and Abdul-Haq. 1993. Investigation on the efficiency of exogenous synthetic growth regulators on fruit drop in mango (*Mangifera indica* L.). *Egypt. J. Hort.* 20:1–14.
- Krisanapook, L., L. Phavaphutanon, and V. Kaewladdakorn. 1999. Studies on fruit growth, levels of GA-like substances and CK-like substances in fruits of mango cv. Khiew Sawoey. *Acta Hort.* 509:697–704.
- Kulkarni, V., and A. Rameshwar. 1978. Natural and gibberellic acid induced parthenocarpy in mango: cv. Thambva. *Curr. Sci.* 47:354–355.
- Kulkarni, V. J. 1989. Effect of post-bloom vegetative flush on fruit retention in mango. *Acta Hort.* 231:500–502.
- Kumar, A., T. Altabella, M. A. Taylor, and A. F. Tiburcio. 1997. Recent advances in polyamine research. *Trends Plant Sci.* 2:124–130.
- Kumar, P., and S. Singh. 1995. Effect of GA₃ and Ethrel on ripening and quality of mango cv. Amrapali. *Orissa J. Hort.* 23:112–118.
- Kumar, S., and R. I. Bhatt. 1999. Field evaluation of plant leaf extracts, oil and neem products against mango hopper (*Amritodus atkinsoni* Lethierry) and thrips (*Scirtothrips mangiferae* Hood). *Allelopathy J.* 6:271–276.
- Kurian, R. M., and C. P. A. Iyer. 1993. Chemical regulation of tree size in mango (*Mangifera indica* L.) cv. Alphonso. II. Effects of growth retardants on flowering and fruit set. *J. Hort. Sci.* 68:355–360.

- Kusumo, S. 1995. Efforts to overcome problems of fruit set and fruit drop in delicious Arumanis mango. Indonesian Agr. Res. Dev. J. 17:77–81.
- Lakra, R. K., W. Kharub, and Z. Singh. 1980. Pest management system of mango mealybug *Drosicha mangifera* Green—A polyphagous pest of fruit trees in Haryana. Indian J. Entomol. 42:153–165.
- Lam, P. F., K. H. Ng, D. Omar, and Y. Talib. 1985. Fruit drop and growth, respiration and chemical changes in Golek mango. MADI-Res. Bul., Malaysia 13:8–14.
- Larson, K. D., and B. Schaffer. 1989. Effect of irrigation on leaf water potential, growth and yield of mango trees. Proc. Fla. State Hort. Soc. 102:226–228.
- Lashbrook, C. C., C. Gonzalez-Boch, and A. B. Bennett. 1994. Two divergent endo- β -1,4-glucanase genes exhibit overlapping expression in ripening fruit and abscising flowers. Plant Cell 6:1485–1493.
- Lonsdale, J. H., and J. M. Kotze. 1993. Chemical control of mango blossom diseases and the effect on fruit set and yield. Plant Dis. 77:558–562.
- Lui, J., Y. Guo, F. Hu, C. Zhou, J. J. Lui, Y. Guo, F. M. Hu, and C. J. Zhou. 1999. Changes in superoxide radical and polyamine levels during the leaf abscission phase in olive. Scientia Silvae Sinicae 35:113–115.
- MacMillan, J. 2001. Occurrence of gibberellins in vascular plants, fungi, and bacteria. J. Plant Growth Regul. 20:387–442.
- Malik, A. U. 2003. Fruitlet abscission and fruit ripening in relation to polyamines. Curtin University of Technology, Ph.D. Thesis, Perth, Western Australia.
- Malik, A. U., and Z. Singh. 2003. Abscission of mango fruitlets as influenced by biosynthesis of polyamines. J. Hort. Sci. Biotechnol. 78, 721–727.
- Malik, A. U., V. Agrez, and Z. Singh. 2003. Fruitlet abscission of mango in relation to ethylene. J. Hort. Sci. Biotechnol. 78, 458–462.
- Mallik, M. N., and D. L. Singh. 1959. Deficiency symptoms in mango due to absence of trace elements. Indian J. Hort. 16:228–232.
- Mao, L., D. Begum, H. Chuang, M. A. Budiman, E. J. Szymkowiak, E. E. Irish, and R. A. Wing. 2000. JOINTLESS is a MADS-box gene controlling tomato flower abscission zone development. Nature 406:910–913.
- Maurya, A. N., and J. N. Singh. 1979. Effect of three growth regulants on fruit retention and quality of mango (*Mangifera indica* L.) cv. Langra. J. Nat. Agr. Soc. Ceylon 16:53–56.
- Mayers, P. E., D. G. Hutton, and J. Saranah. 1984. Integrated control of bacterial black spot of mangoes in Southeast Queensland. p. 258–260. In: Proc. First Austral. Mango Res. Workshop, CSIRO, Melbourne, Australia.
- McKeon, T. A., J. C. Fernandez-Maculet, and S. F. Yang. 1995. Biosynthesis and metabolism of ethylene. p. 118–139. In: P. J. Davies (ed.), Plant hormones physiology, biochemistry and molecular biology. Kluwer Academic Publ., Boston.
- Mendoza, D. B. 1981. Development physiology of Carabao mango (*Mangifera indica* L.) fruit. Ph.D. Thesis, Univ. Philippines, Laguna.
- Mohyuddin, A. I., and R. Mahmood. 1993. Integrated control of mango pest in Pakistan. Acta Hort. 341:467–83.
- Mostert, P. G., and J. E. Hoffman. 1997. Water requirements and irrigation of mature mango trees. Acta Hort. 455:331–338.
- Mukherjee, S. K. 1949. A monograph on the genus *Mangifera* L. Lloydia 12:73–136.
- Mukherjee, S. K. 1953. The mango: its botany, cultivation, uses and future improvement. Econ. Bot. 7:130–162.
- Murti, G. S. R., and K. K. Upreti. 1995. Changes in some endogenous growth substances during fruit development in mango. Plant Physiol. Biochem. 22:44–47.
- Murti, G. S. R., and K. K. Upreti. 1999. Endogenous hormones and polyamines in relation to fruitlet retention in mango cv. Alphonso. J. Plant Biol. 26:149–154.

- Musahib-ud-Din, and H. S. Dinsha. 1946. The floral count and fruit set studies in some of the North Indian mangoes. *Punjab Fruit J.* 10:35–42.
- Nachiappan, R. M., and P. Baskaran. 1986. Field evaluation of certain insecticidal sprays against mango leaf-hoppers. *Pesticides* 20:41–44.
- Naik, K. C., and M. M. Rao. 1943. Studies on blossom biology and pollination in mangoes (*Mangifera indica* L.). *Ind. J. Hort.* 1:107–119.
- Nakano, R., S. Inoue, Y. Kubo, and A. Inaba. 2002. Water stress-induced ethylene in the calyx triggers autocatalytic ethylene production and fruit softening in 'Tonewase' persimmon grown in a heated plastic-house. *Postharvest Biol. Technol.* 25:293–300.
- Naqvi, S. S. M., M. A. Khan, S. M. Alam, S. Mumtaz, and A. Shereen. 1998. Enhancement of harvestable mango (*Mangifera indica* L.) fruit yield by salicylic and methyl-2,6 dichloroisonicotinic acids. *Pak. J. Bot.* 30:239–243.
- Naqvi, S. S. M., S. M. Alam, and S. Mumtaz. 1990. Effect of cobalt and silver ions and naphthaleneacetic acid on fruit retention in mango (*Mangifera indica* L.). *Austral. J. Expt. Agr.* 30:433–435.
- Neethling, C., and P. Joubert. 1994. Damage to mango fruit by the coconut bug. *Inligtingsbulletin Instituut vir Tropiese en Subtropiese Gewasse* 264:11–12.
- Nijjar, G. S., J. S. Arora, G. Singh, and R. S. Dwivedi. 1976. Symptoms of zinc deficiency in mango. *Punjab Hort. J.* 16:113–114.
- Notodimedjo, S., and S. Subhadrabandhu. 2000. Effect of GA₃, NAA and CPPU on fruit retention, yield and quality of mango (cv. Arumanis) in East Java. *Acta Hort.* 509:587–600.
- Núñez-Elisía, R., and T. L. Davenport. 1983. Abscission and ethylene production in mango (*Mangifera indica* L.) fruit cv. Tommy Atkins. *Proc. Fla. State. Hort. Soc.* 96:186–188.
- Núñez-Elisía, R., and T. L. Davenport. 1986. Abscission of mango fruitlets as influenced by enhanced ethylene biosynthesis. *Plant Physiol.* 82:991–994.
- Olien, W. C., and M. J. Bukovac. 1982. Ethylene generation, temperature responses and relative biological activities of several compounds with a potential for promoting abscission of sour cherry fruit. *J. Am. Soc. Hort. Sci.* 107:1085–1089.
- Oosthuysen, S. A. 1995. Effect of post-bloom aqueous spray application of GA₃, NAA, and CPPU on fruit retention, fruit size, and yield in Tommy Atkins and Heidi mango. *Yearb. S. Afr. Mango Growers' Assoc.* 15:31–33.
- Oosthuysen, S. A. 1997. Effect of KNO₃ sprays to flowering mango trees on fruit retention, fruit size, tree yield, and fruit quality. *Acta Hort.* 455:359–366.
- Oosthuysen, S. A., and G. Jacobs. 1997a. Effect of soil applied paclobutrazol on fruit retention, fruit size, tree yield and tree revenue in Sensation and Tommy Atkins mango. *Yearb. S. Afr. Mango Growers' Assoc.* 17:57–62.
- Oosthuysen, S. A., and G. Jacobs. 1997b. Flowering synchronization of Sensation mango trees by chemical inflorescence removal. *Yearb. S. Afr. Mango Growers' Assoc.* 17:53–56.
- Osborne, J. D. 1989. Abscission. *Crit. Rev. Plant Sci.* 8:103–129.
- Palti, J., Y. Pinkas, and M. Chorin. 1974. Powdery mildew on mango. *Plant Dis. Rep.* 58:45–49.
- Pathak, R. A., and R. M. Pandey. 1977. A note on the status of mineral content of inflorescence and fruits at different stages of their growth in mango cv. Dusehri. *Indian J. Plant Physiol.* 20:41–43.
- Peña, J. E., and A. I. Mohyuddin. 1997. Insect pests. p. 327–362. In: R. E. Litz (ed.), *The mango: Botany, production and uses*. CAB Int., Wallingford, UK.
- Peña, J. E., A. I. Mohyuddin, and M. Wysoki. 1997. The current mango pest management in tropics and subtropics. *Acta Hort.* 455.

- Phillip, T. E., and R. L. Malmberg. 1989. Do polyamines have a role in plant development. *Annu. Rev. Plant Physiol. Plant Mol. Biol.* 40:235–269.
- Ploetz, R. C., and O. Prakash. 1997. Foliar, floral and soilborne diseases. p. 281–325. In: R. L. Litz (ed.). *The mango: Botany, production and uses*. CAB Int., Wallingford, UK.
- Pongsomboon, W. 1991. Effects of temperature and water stress on tree growth, flowering, fruit growth and retention of mango (*Mangifera indica* L.). Ph.D. Thesis, Kasetsart Univ., Bangkok, Thailand.
- Poovaiah, B. W., and H. P. Rasmussen. 1973. Peroxidase activity in the abscission zone of bean leaves during abscission. *Plant Physiol.* 52:263.
- Prakash, S., and S. Ram. 1984. Naturally occurring auxins and inhibitors and their role in fruit growth and drop of mango Dashehari. *Scientia Hort.* 22:241–248.
- Prakash, S., and S. Ram. 1985. Effect of various growth regulators and chemicals on fruit retention in mango cv. Chousa (Abstract). In: *Int. Mango Symp.* (20–24 May), Bangalore, India. p. 54.
- Prasad, V., and R. K. Singh. 1976. Prevalence and control of mango mealy bug *Drosicha stebbingi* (green) in Bihar. *Indian J. Entomol.* 38:214–224.
- Prior, C., and K. Ryder. 1987. Effect of low volume of copper sprays with polyisobutene sticker on mango blossom blight (*Glomerella cingulata*) in Dominica. *Trop. Pest. Mgmt.* 33:350–352.
- Purnomo, S. 1986. Possible agronomics technical manipulation for mango of Golek, Gadung and Manalagi cultivar. *Penelitian Hortikultura* 1:22–36.
- Quintana, E. G., P. Nanthachai, D. B. Hiranpradit, J. Mendoza, and S. Kesta. 1984. Growth and development of mango. p. 21–39. In: D. B. Mendoza and R. B. H. Wills (eds.), *Mango: fruit development, postharvest physiology and marketing in ASEAN*. ASEAN Food Handling Bureau.
- Rademacher, W. 2000a. Growth retardants in agriculture and horticulture. *Proc. 27th Annu. Meet. Plant Growth Reg. Soc. Am.* p. 87–92.
- Rademacher, W. 2000b. Growth retardants: Effects on gibberellin biosynthesis and other metabolic pathways. *Annu. Rev. Plant Physiol. Plant Mol. Biol.* 51:501–531.
- Rajput, C. B. S., and J. P. Tiwari. 1975. Effect of foliar spray of urea on flowering and fruiting characters of mango. *Bangladesh Hort.* 3:1–5.
- Rajput, C. B. S., and J. N. Singh. 1983. Effect of urea and GA₃ sprays on the growth, flowering and fruiting characters of mango. *Progr. Hort.* 15:174–177.
- Rajput, C. B. S., and J. N. Singh. 1989. Effects of urea and GA₃ sprays on the growth, flowering and fruiting characters of mango. *Acta Hort.* 231:301–305.
- Ram, S. 1983. Hormonal control of fruit growth and fruit drop in mango cv. Dashehari yields, India. *Acta Hort.* 134:169–178.
- Ram, S. 1992. Naturally occurring hormones of mango and their role in growth and drop of the fruit. *Acta Hort.* 321:400–411.
- Ram, S., and S. Pal. 1979. Studies on the naturally occurring gibberellins in mango (*Mangifera indica* L.) fruit. *J. Hort. Sci.* 54:209–215.
- Ram, S., S. C. Sirohi, and V. S. Rathore. 1983. Naturally occurring cytokinins in mango (*Mangifera indica* L.) fruit. *Austral. J. Plant Physiol.* 10:65–73.
- Rameshwar, A., and B. Kulkarni. 1979. Effect of micronutrient spray on mango. p. 177–178. In: *Proc. of Mango workers meeting*, Panaji, Goa. Hort. Soc. India, Bangalore.
- Rameshwar, A., and S. N. Rao. 1980. Why fruit drop in mango. *Intensive Agr.* 18:17–18.
- Ramina, A., C. Bonghi, J. Giovannoni, B. Ruperti, and P. Tonutti. 1998. Biology and biotechnology of the plant hormone ethylene II. p. 249–254. In: *Proc. EU-TMR-Euroconf. Symp.*, Thira (Santorini), Greece. Kluwer Academic Publ., Dordrecht, Netherlands.

- Ranbir, S., J. S. Chandel, and A. R. Bhandari. 1998. Effect of soil-moisture regime on plant growth, fruiting, fruit quality and nutrient uptake of mango (*Mangifera indica*). Indian J. Agr. Sci. 68:135–138.
- Randhawa, G. S., and K. L. Chadha. 1982. Fruit drop and its control in mango and citrus. Indian Council Agr. Res. 25:1–64.
- Randhawa, G. S., and V. K. Damodaran. 1961a. Studies on flora biology and sex ratio in mango (*Mangifera indica* L.). I. A review. Indian J. Hort. 18:9–35.
- Randhawa, G. S., and V. K. Damodaran. 1961b. Studies on flora biology and sex ratio in mango (*Mangifera indica* L.) var. Chausa, Dasherri and Krishanbhog. II. Flowering habit, flowering season, panicle development and sex ratio. Indian J. Hort. 18:36–45.
- Rao, D. P., and S. K. Mukherjee. 1989. Nutrient status in leaf and soil of some cultivars of mango in relation to yield. Acta Hort. 231:286–289.
- Rao, S. N. 1961. Studies on the effect of GA and other plant growth regulators on fruit set, fruit drop and total yield of citrus, guava, mango and other fruit crops. Fourth Hort. Res. Workers Conf., Pune, India.
- Rao, S. N., and C. H. Suba Rao. 1963. Effect of some growth plant regulators on fruit drop in Neelum mango. Punjab Hort. J. 3:205–208.
- Rath, S., L. R. Singh, B. P. Singh, and D. B. Singh. 1980. Effect of boron and zinc on physico-chemical composition of mango fruits. Punjab Hort. J. 20:30–35.
- Rawash, M. A., A. El Hammady, S. El Nabawy, A. S. Khalifa, and H. El Masry. 1983. Regulation of flowering and fruiting in mango trees by using some growth regulators. Ann. Agr. Sci. (Cairo) 28:227–240.
- Reddy, K. S., and B. Ramayya. 1976. Himauddin variety of mango in Rumani Groves may help in getting better sized fruits. Cur. Res 5:60–61.
- Reddy, S. E., and A. M. Majumdar. 1983. Response of mango (*Mangifera indica* L.) to foliar application of phosphorus. Fert. Res. 4:281–285.
- Reuveni, M., and R. Reuveni. 1995. Efficacy of foliar sprays of phosphates in controlling powdery mildews in field grown nectarine, mango tree and grapevines. Crop Prot. 14:311–314.
- Reza, M. M. A., and M. G. Mortuza. 1997. Incidence of powdery mildew in mango varieties and its control. Bangladesh J. Plant Pathol. 13:37–38.
- Roberts, J. A., K. A. Elliott, and Z. H. Gonzalez-Carranza. 2002. Abscission, dehiscence, and other cell separation processes. Annu. Rev. of Plant Biol. 53:131–158.
- Roberts, J. A., C. A. Whitelaw, Z. H. Gonzalez-Carranza, and M. McManus. 2000. Cell separation processes in plants—models, mechanisms and manipulation. Ann. Bot. 86:223–235.
- Roberts, J. A., and D. J. Osborne. 1981. Auxin and the control of ethylene production during the development and senescence of leaves and fruits. J. Expt. Bot. 32:875–889.
- Roizman, Y. 1984. The involvement of different factors in the process of pollination, fruit set and embryo development of monoembryonic and polyembryonic mango varieties. M.S. Thesis, Hebrew Univ., Jerusalem.
- Roy, R. S., V. S. Chhonkar, and S. N. Prasad. 1963. Effect of some plant growth regulators on fruit drop in mango. Punjab Hort. J. 3:209–213.
- Rugini, E., G. Bonghi, and M. Mencuccini. 1986. Effect of putrescine, L. Arginine and cobalt on fruit set, ethylene content and apparent parthenocarp in olives (*Olea europea* L.). Acta Hort. 179:365–368.
- Ruperti, B., C. Bonghi, P. Tonutti, and A. Ramina. 1998. Ethylene biosynthesis in peach fruitlet abscission. Plant Cell Environ. 21:731–737.

- Saini, S. S., R. N. Singh, and G. S. Paliwal. 1972. Growth and development of mango (*Mangifera indica* L.) fruit II. Indian J. Hort. 29:5–18.
- Samra, J. S., and Y. K. Arora. 1997. Mineral nutrition. p. 175–201. In: R. E. Litz (ed.), The mango: Botany, production and uses. CAB Int., Wallingford, UK.
- Samra, J. S., R. S. Thakur, and K. L. Chadha. 1977. Effect of foliar application of urea on yield and yield parameters of mango. Indian J. Hort. 34:26–29.
- Samra, K. N., B. V. Rao Rama, and S. N. Rao. 1981. Effect of 2,4-D on fruit drop in mango. p. 107. In: Natl. Symp. Sub-Trop. Fruit Crops (Abstr.), Bangalore, India.
- Sanyal, D., and S. C. Maity. 1989. Studies on nature of fruit drop and its relation with fruit growth in some mango varieties. Prog. Hort. 21:300–304.
- Schaffer, B., A. W. Whiley, and J. H. Crane. 1994. Mango. In: B. Schaffer and P. Andersen, (eds.), Handbook of environmental physiology of fruit crops, Vol. 2. CRC Press, Boca Raton, FL.
- Schoeman, M. H., B. Q. Manicom, and M. J. Wingfield. 1995. Epidemiology of powdery mildew in mango blossoms. Plant Dis. 79:524–528.
- Scholefield, B. P., D. R. Oag, and M. Sedgley. 1986. The relationship between vegetative and reproductive development in mango in northern Australia. Austral. J. Agr. Res. 37:425–433.
- Searle, C., A. W. Whiley, D. R. Simpson, and J. B. Saranah. 1995. A preliminary phenophysiological model for 'Kensington' mango in subtropical Australia. Mango 2000—Marketing Seminar and Production Workshop. p. 127–135.
- Sen, P. K. 1939. Annual Report (1938–39), Fruit Research Station, Sabour, India. p. 12–18.
- Sexton, R., and A. J. Redshaw. 1981. The role of cell expansion in the abscission of *Impatiens* leaves. Ann. Bot. 48:745–757.
- Sexton, R., and J. A. Roberts. 1982. Cell biology of abscission. Annu. Rev. Plant Physiol. 33:133–162.
- Sexton, R., L. N. Lewis, A. J. Trewavas, and P. Kelly. 1985. Ethylene and abscission. p. 173–196. In: J. A. Roberts and G. A. Tucker (eds.), Ethylene and plant development. Butterworth, London.
- Sharma, D. K., and R. N. Singh. 1970. Studies on some pollination problems in mango (*Mangifera indica* L.). Indian J. Hort. 27:1.
- Sharma, D. K., and R. N. Singh. 1972. Investigation in self-incompatibility in *Mangifera indica* L. Acta Hort. 24:126–130.
- Sharma, D. P. 1999. Effect of intercropping and cultural practices on yield and economics of newly planted mango. Adv. Plant Sci. 12:337–340.
- Sharma, T. R., P. K. Niar, and M. K. Nema. 1990. Effect of foliar spray of urea, KNO₃ and NAA on fruiting behaviour of mango cv. Langra. Orissa J. Hort. 18:42–47.
- Shinde, A. K., G. M. Waghmare, and B. P. Patil. 2001. Exploring pollinizers for enhancing productivity in 'Alphonso' mango (*Mangifera indica*). Indian J. Agr. Sci. 71:592–594.
- Shiridhar, T. S., and H. S. Sohi. 1973. Powdery mildew of mango and its control. Indian Phytopathol. 26:262–263.
- Shukla, R. P., and P. L. Tandom. 1985. Bio-ecology and management of mango weevil, *Stenochetus mangiferae* (Fabricius) (Coleoptera: curculionidae). Int. J. Trop. Agr. 3:293–303.
- Singh, A. R. 1977a. Effect of foliar spray of nitrogen and growth regulators on the flowering and fruiting of mango (*Mangifera indica* L.). Punjab Hort. J. 17:34–40.
- Singh, C. P., and S. Ram. 1997. Effect of irrigation on flowering, fruiting and malformation in mango. Acta Hort. 455:543–545.
- Singh, K. K. 1967. The mango, a handbook. P. S. Harishan, Calcutta.
- Singh, L. B. 1960a. The mango: Botany, cultivation and utilization. Leonard Hill, London.

- Singh, M., A. S. Chaudhary, and M. Prasad. 1986. A note on the effect of some plant regulators on fruit retention in mango (*Mangifera indica* L.). Haryana J. Hort. Sci. 15:221–223.
- Singh, R., and K. S. Arora. 1965. Some factors affecting fruit drop in mango (*Mangifera indica* L.). Indian J. Agr. Sci. 35:196–205.
- Singh, R. N. 1954. Studies in floral biology and subsequent development of fruits in the mango (*Mangifera indica* L.) varieties Dasherri and Langra. Ind. J. Hort. 11:69–88.
- Singh, R. N. 1990. Mango. Indian Council Agricultural Research, New Delhi. p. 39–55.
- Singh, R. R. 1972. Effect of foliar spray of nitrogen and phosphorus on flowering and fruiting of mango (*Mangifera indica* L.) cultivar Chausa. Hort. Adv. 9:21–24.
- Singh, R. R. 1977b. Effect of various concentrations of boron on growth characters and chemical composition of leaves of mango (*Mangifera indica* L.) cv. Langra. Bangladesh Hort. 5:30–34.
- Singh, R. R., and C. B. S. Rajput. 1977. Effect of various concentrations of zinc on vegetative growth characters, flowering, fruiting and physio-chemical composition of fruits in mango (*Mangifera indica* L.) cultivar Chausa. Haryana J. Hort. Sci. 6:10–14.
- Singh, R. S., and S. Ram. 1983. Studies on the use of plant growth substances for fruit retention in mango cv Dashehari. Indian J. Hort. 40:194–199.
- Singh, S. 1994. Efficacy of ethylene inhibitors and free radical scavengers in alleviation of fruit drop in *Mangifera indica* L. cv. Langra. M.S. Thesis, Punjab Agr. Univ., Ludhiana, India.
- Singh, U. R. 1960b. Studies in the fruit drop of mango (*Mangifera indica* L.) I. Nature and extent of fruit drop. Hort. Adv. 4:142–154.
- Singh, U. R. 1961a. Studies in the fruit drop of mango (*Mangifera indica* L.) II. Factors affecting fruit drop. Ann. Rep. Hort. Res Inst., Saharanpur, India:123–125.
- Singh, U. R. 1961b. Studies in the fruit drop of mango (*Mangifera indica* L.) IV. Embryo development, its degeneration and studies on fruit, pedicel and abscission zone. Hort. Adv. 5:218–227.
- Singh, Z., and V. Agrez. 2002. Fruit set, retention and yield of mango in relation to ethylene. Acta Hort. 575:805–811.
- Singh, Z., and B. S. Dhillon. 1987. Effect of foliar application of boron on vegetative and panicle growth, sex expression, fruit retention and physico-chemical characters of fruits of mango (*Mangifera indica* L.) cv. Dusehri. Trop. Agr. 64:305–308.
- Singh, Z., and J. Janes. 2000. Regulation of fruit set and retention in mango with exogenous application of polyamines and their biosynthesis inhibitors. Acta Hort. 509:675–680.
- Singh, Z., and L. Singh. 1995. Increased fruit set and retention in mango with exogenous application of polyamines. J. Hort. Sci. 70:271–277.
- Sirichai, K. 1980. Studies on flower sex ratio, fruit set and fruit drop of mango (*Mangifera indica* L.) var. Nam-Doc-Mai (off season type). Graduate School, Kasetsart Univ., Bangkok, Thailand.
- Somporn, K. 1981. Fruit growth, natural inhibitor and total nonstructural carbohydrate levels during fruit development in mango (*Mangifera indica* L.) cultivar Nang Klangwan. M.S. Thesis, Kasetsart Univ., Bangkok, Thailand.
- Sponsel, V. M. 1995. Gibberellin biosynthesis and metabolism. p. 66–97. In: P. J. Davies (ed.), Plant hormones: Physiology, biochemistry, and molecular biology. Martinus Nijhoff, Dordrecht.
- Srivastava, R. P. 1962. Studies in the flowering season, sex distribution, fruit development and the influence of L. naphthaleneacetic acid spray on the fruit drop of Dashehari mango. Banaras Hindu Univ. J. Sci. Res. 12:104–115.

- Srivastava, R. P. 1981. Comparative efficacy of various insecticidal dusts against mango mealybug eggs. *Indian J. Entomol.* 43:225–229.
- Sturrock, T. T. 1961. A study of growth substances on fruit setting of mango. Ph.D. Diss., Univ. Florida, Gainesville.
- Subramanian, C. K. 1925. A note on the life history of *Cryptorhynchus mangiferae* Fab. *Madras Agr. Dept. Yearb.* p. 29–36.
- Sukhvibul, N., A. W. Whiley, M. K. Smith, S. E. Hetherington, and V. Vithange. 1999. Effect of temperature on inflorescence and floral development in four mango (*Mangifera indica* L.) cultivars. *Scientia Hort.* 82:67–84.
- Sumrit, F. 1992. Influence of soil moisture content on fruit retention of mango cv. Khiew Sawaay. *Khon Kaen Agr. J.* 20:140–143.
- Syamal, M. M., and K. A. Mishra. 1989. Effect of NPK on growth, flowering, fruiting and quality of mango. *Acta Hort.* 231:276–281.
- Taiz, L., and E. Zeiger. 1991. *Plant physiology*. Benjamin/Cummings Publ. Co. Inc., Redwood, CA.
- Tandom, P. L., and A. Verghese. 1985. World list of insect, mite and other pests of mango. Technical Document. *Indian Inst. Hort. Res.* 5.
- Taylor, J. E., and C. A. Whitelaw. 2001. Signals in abscission. *New Phytol.* 151:323–339.
- Teotia, S. S., R. N. Singh, S. K. Upadhyay, and V. S. Srivastava. 1967. Effect of growth substances on fruit retention in mango (*Mangifera indica* L.) variety Langra and Dashehari. p. 225–229. In: *Proc. Int. Sym. Trop. Sub-trop. Hort.*, New Delhi.
- Thimann, K. V. 1977. *Hormone action in the whole life of plants*. Univ. Massachusetts Press, Amherst.
- Thompson, A. K. 1987. The development and adoption of methods of control of anthracnose. In: R. T. Prinsley and G. Tucker (eds.), *Mangoes: A review*. Commonwealth Sci. Council, London.
- Tsai, J., M. Yao, K. Chi, L. Liang, J. C. Tsai, M. H. Yao, K. S. Chi, and L. S. Liang. 1996. Studies on the relationships between climatic elements and the yield of mango in Yuching area. *J. Agr. Res. China* 45:186–194.
- van Doorn, W. G., and A. D. Stead. 1997. Abscission of flowers and floral parts. *J. Expt. Bot.* 48:821–837.
- Van Lelyveld, L. J. 1978. Peroxidase activity and isoenzymes in abscised and normal mango (*Mangifera indica* L.) fruits. *Z. Pflanzenphysiol.* 89:453–456.
- Van Lelyveld, L. J., and E. Nel. 1982. Ethylene concentration and polyphenol oxidase activity in mango (*Mangifera indica* L.) fruit abscission. *Z. Pflanzenphysiol.* 107:179–182.
- Vasil, I. K. 1963. Effect of boron on pollen germination and pollen tube growth. p. 107–119. In: H. F. Linskens (ed.), *Pollen physiology and fertilization*. North Holland, Amsterdam.
- Veerish, G. K. 1989. Pest problems in mango—world situation. *Acta Hort.* 231:551–565.
- Whiley, A. W., and B. Schaffer. 1997. *Stress physiology*. In: R. E. Litz (ed.), *The mango: Botany, production and uses*. CAB Int., Cambridge, UK.
- Whiley, A. W., J. B. Saranah, T. S. Rasmussen, E. C. Winston, and B. N. Wolstenholme. 1988. Effect of temperature on growth of 10 mango cultivars with relevance to production in Australia. In: *Proc. 4th Aust. Conf. Tree and Nut Crops*. ACOTANC, Lismore.
- Whitwell, A. C. 1993. The pest/predator/parasitoid complex on mango inflorescences in Dominica. *Acta Hort.* 341:421–432.
- Winston, E. C. 1992. Evaluation of paclobutrazol on growth, flowering and yield of mango cv. Kensington Pride. *Austral. J. Expt. Agr.* 32:97–104.
- Wittwer, A. N. 1991. Research strategies applied to scheduling of mangoes irrigation. *Yearb. S. Afr. Mango Growers' Assoc.* 11:6–8.

- Yang, S. F. 1980. Regulation of ethylene biosynthesis. *HortScience* 15:238–242.
- Yang, S. F., and N. E. Hoffman. 1984. Ethylene biosynthesis and its regulation in higher plants. *Annu. Rev. Plant Physiol.* 35:155–189.
- Yee, W. 1987. The mango in Hawaii. *Coop. Ext. Serv. Circ., Univ. of Hawaii* 33:19–22.
- Young, T. W. 1942. Investigation on the unfruitfulness of the Haden mango in Florida. Ph.D. Diss., Cornell Univ., Ithaca, NY.
- Young, T. W., and J. W. Sauls. 1979. The mango industry in Florida. *Fla. Coop. Ext. Serv., Univ. Florida, IFAS Bul.* 189.
- Yuenyong, P. 1986. Effect of bagging materials on fruit qualities of mango (*Mangifera indica* L.) cv. Nam Dok Mai Tawai No. 4. Dept. Hort., Kasetsart Univ., Bangkok.
- Zhong, G. Y., J. Riov, R. Goren, D. Holland, and J. L. Guardiola. 1998. Isolation of ethylene induced map kinase from citrus fruit abscission zone. *Acta Hort.* 463:69–73.
- Zhong, X., and X. H. Zhong. 2000. Physiological function of three polyamines in ‘Shatian’ pummelo during blossom and fruit setting. *J. Hunan Agric. Univ.* 26:453–456.

The Physiology of Adaptation and Yield Expression in Olive

*D. J. Connor**

Instituto de Agricultura Sostenible (CSIC) and Universidad de Córdoba

Apartado de Correos 4084

14080 Córdoba, Spain

and

The Institute of Land and Food Resources

The University of Melbourne

Victoria 3010, Australia

*E. Fereres**

Instituto de Agricultura Sostenible (CSIC) and Universidad de Córdoba

Apartado de Correos 4084

14080 Córdoba, Spain

- I. INTRODUCTION
- II. GROWTH AND DEVELOPMENT
 - A. Vegetative Growth
 - B. Floral Induction, Initiation, and Differentiation
 - C. Response of Flowering to Temperature
 - D. Flowering, Pollination, and Fertilization
 - E. Self-Compatibility
 - F. Fruit Set, Filling, and Maturation
 - G. Efficiency of Reproductive Strategy

*We thank Antonio Hall, Bob Loomis, María-Inés Mínguez, Hava Rapoport, David Smith and four reviewers for comments and suggestions on the manuscript and also Joan Girona, Miguel Pastor, Francisco Villalobos, and Francisco Orgaz for valued discussion. David Connor's study in Spain was funded by the Ministerio de Educación y Cultura, Spain.

Horticultural Reviews, Volume 31, Edited by Jules Janick
ISBN 0-471-66694-7 © 2005 John Wiley & Sons, Inc.

- III. WATER RELATIONS
 - A. Collection of Water by Root Systems
 - B. Leaf Anatomy and Water Relations
 - C. The Olive Tree as a Hydraulic System
 - D. Control of Transpiration
 - IV. MINERAL NUTRITION
 - A. Deficiencies and Toxicities
 - B. Extraction and Cycling of Nutrients in Orchards
 - V. CARBON ACCUMULATION
 - A. Leaf Photosynthesis
 - B. Interception of Radiation
 - C. Tree and Canopy Photosynthesis
 - VI. BIOMASS PARTITIONING AND REALIZATION OF YIELD
 - A. Movement of Assimilates from Leaves
 - B. Above- and Below-Ground Biomass
 - C. Shoots and Fruits
 - D. Assimilate Supply and Oil Formation
 - VII. STRESS PHYSIOLOGY
 - A. Drought
 - B. Low Temperature
 - C. Salinity
 - D. Waterlogging
 - VIII. INTEGRATION OF RESPONSES
 - IX. RECOMMENDATIONS FOR FUTURE RESEARCH
 - A. Phenological Development
 - B. Carbon Accumulation and Partitioning
 - C. Water Relations
 - D. Nutrient Balance
 - X. CONCLUSION
- LITERATURE CITED

LIST OF ABBREVIATIONS

A	leaf photosynthetic rate
A_{\max}	maximum rate of leaf photosynthesis
ATP	adenosine triphosphate
CAM	crassulacean acid metabolism
CC	canopy (vertical) cover
CoA	coenzyme A
CR	constructional respiration
EC	electrical conductivity
ET	evapotranspiration
ET_0	reference crop evapotranspiration
FAS	fatty acid synthase
FRF	fruit retention force
GR	glucose requirement for growth or maintenance

LAI	leaf area index
LSC	leaf specific hydraulic conductivity
MPK	monopotassium phosphate
MR	maintenance respiration
NADH	nicotinamide-adenine dinucleotide phosphate
NUE	nitrogen-use efficiency
PAR	photosynthetically active radiation
PRD	partial root zone drying
PS	phenological stage
Q	capacitance
RDI	reduced deficit irrigation
RLD	root length density
RUE	radiation-use efficiency
SLM	specific leaf mass
T	transpiration rate
TAG	triacylglycerol
TE	transpiration efficiency
VPD	vapor pressure deficit
WUE	water-use efficiency

I. INTRODUCTION

Olive (*Olea europaea* L., *Oleaceae*) has probably been in cultivation longer than any other tree species. It was domesticated around 3000 to 4000 B.C.E. in the eastern Mediterranean and from there was spread widely in northern Africa, the Iberian Peninsula, and the rest of southern Europe by civilizations that successively occupied the region. Whereas olive is now renowned for high-quality food oil and for fruit for direct consumption, it was originally harvested for oil used as medicine, lamp fuel, and lubricant. During the last 500 years, olive has been taken to the Americas, South Africa, Australia, China, and Japan, but remains principally a crop of the Mediterranean Basin, which accounted for 95% of world mean annual production of 2.5 Mt oil during three years to 2002. Of the five major producers, Spain, with 42% of world production, was ahead of Italy, Greece, Turkey, and Tunisia (FAOSTAT 2003).

All cultivated olive belongs to a single species (*O. europaea*) along with the wild ancestors from which it was selected. As a result of the general use of vegetative propagation and the longevity of individual trees, many olive cultivars are probably within several generations of the wild types from which they were selected (Lavee 1990). Many trees are

hundreds of years old and some may be thousands. Based on local knowledge, Miranovic (1994) reports 1000-year-old olive orchards of 'Zutica' on the Montenegrin Coast, with one tree being over 2000 years old. As a consequence, most traditional olive-growing regions depend on only a few of the more than 2000 recognized cultivars and clones. Similarly, small numbers of cultivars dominate production in each of the major, intensive areas of Spain, Greece, and Tunisia. In Spain, for example, of 262 recognized cultivars, just four, 'Picual', 'Cornicabra', 'Hojiblanca', and 'Lechin de Sevilla', occupy 68% of the olive area (Barranco and Rallo 2000). In Italy, however, there is no similar dominance of few cultivars. Rather, there is much variation from locality to locality.

In the Mediterranean region, with its characteristic hot, low-rainfall summers, olive was developed as the crop of marginal land that was unsuitable for more intensive cultivation by reason of soil type, topography, or lack of water for irrigation. The traditional orchards are consequently of widely spaced trees, maintained with small canopy cover, and hence water demand, to ensure survival through the driest summers. The cultivation of olive is, however, changing. Large areas of widely spaced olives are being irrigated and the trees reshaped for mechanical harvesting. At the same time, most new orchards in the Mediterranean, and almost exclusively elsewhere, are being planted at high density, irrigated and fertilized for high yield, and shaped from the outset for mechanical harvesting. These changes are occurring rapidly and, in the absence of complete knowledge specific to olive, technology is being adapted from other crops, e.g., mechanical harvesting from wine grapes and reduced deficit irrigation (RDI) from stone and pome fruits (Mitchell and Chalmers 1982; Mitchell et al. 1989).

Despite its long history of cultivation, scientific understanding of olive is limited compared with that of other long-standing crops such as wheat and barley, or even new crops such as sunflower (Connor and Hall 1997). Traditional management of olive was established by trial and error without physiological understanding of responses to environment and management. A relatively recent treatise on olive (Rojo 1840), for example, commenced by acknowledging the major contribution to knowledge by Columella, one of the first agriculturalists from ancient Rome. Traditional techniques of olive production that have persisted for thousands of years may be optimal for local cultivars in local areas but they cannot be confidently extended to new locations or new forms of cultivation. One key to progress is to understand the physiological basis of those responses within a sound scientific framework.

The recent expansion of scientific research in olive justifies this new comprehensive review. New cultural techniques, with greater tree den-

sity, more water, improved nutrition, and mechanical harvesting, are both the cause and effect of new research that is expanding. This review will consider individual components of physiological response, leading to an integrated view of their interactions that determine growth, survival, resource-use efficiencies, and productivity under field conditions. It will supplement and update two previously published reviews (Bongi and Palliotti 1994; Lavee 1996), and the more restricted reviews of fruit set (Lavee 1986), salt tolerance (Gucci and Tattini 1997), water relations (Fernández and Moreno 1999), and flower induction and differentiation (Fabbri and Benelli 2000). It will evaluate the existing literature on olive within the established framework of plant and crop physiological science (Taiz and Zeiger 1991; Loomis and Connor 1992) so that the consolidated knowledge can be applied to olive production, in whatever form, in all appropriate environments. A consequent important outcome will be the identification of areas where knowledge is inadequate and so the review will also contribute to setting priorities for future research.

II. GROWTH AND DEVELOPMENT

The size and activity of the foliage canopy determine the carbon gain and growth of olive trees. It is, however, the pattern of appearance of new organs that determines how that growth is progressively partitioned to buds, leaves and roots, and in consequence, how yield is determined annually and how trees change morphologically in the longer term.

Olive is widely reported as a day-neutral plant in which the rate of development through its biennial vegetative-reproductive cycle is governed climatologically by temperature and sunlight (assimilate supply). Since the only experimental evidence for this day neutrality resides in work with a single cultivar, 'Rubra' (Hackett and Hartmann 1964), this response of olive does merit wider investigation. The biennial cycle (Rallo 1998), one in which individual trees bear in alternate years, arises because olive flowers on 1-year-old shoots and the induction of buds during summer is affected by the presence, at that time, of the current year's fruit. The interaction between external environment and the internal physiological responses that operate over the extended period from induction in summer to flowering in spring is, however, poorly understood. Sanz-Cortés et al. (2002) developed a numerical scale for the vegetative and floral phenological stages (PS) that is consistent with scales used widely in other tree crops. This standardized scale should facilitate description of developmental patterns and research directed to understand controls of phenological development in olive.

A. Vegetative Growth

The production of nodes, the expansion of leaves, and the thickening of stems can occur at any time during the year depending upon temperature, water supply, and solar radiation. Vegetative growth is, however, commonly constrained by low temperature in winter, and in rain-fed systems, by water supply during summer. While irrigated orchards may maintain shoot growth and leaf expansion from spring through autumn, rain-fed orchards typically display two flushes of vegetative growth, in spring and autumn, respectively.

Moriana et al. (2003) made detailed records of trunk growth over an annual cycle and showed that fruit load affected trunk growth patterns of mature trees. Growth in an irrigated tree, following harvest of a heavy fruit load (and thus very small load in the current year), was very slow in spring and increased more or less linearly, exhibiting maximum growth rates at the end of summer and in early autumn. In contrast, a tree with a heavy crop grew faster during spring but slowed markedly in summer and autumn. Trunks of mature trees under severe water deficits did not grow at all and even shrunk during the driest periods.

Little is known of the dynamics of root growth of olive trees in the field. Although olive root systems can be extensive and deep, measurements of root length density (RLD, cm cm^{-3}) suggest that values usually range between 0.1 and 1.0 cm cm^{-3} (E. Fereres, unpubl.), less than in herbaceous crops and some deciduous orchards (Fereres and Goldhamer 1990). The seasonal distribution of root growth has been studied by Fernández et al. (1991) for 'Manzanillo' (southern Spain) and Palese et al. (2000) for 'Coratina' (southern Italy). Both studies used mini-rhizotrons to compare rain-fed with irrigated orchards planted at 6×6 m. Irrigation in the Spanish study was by drip and in Italy by a single micro-jet per tree spanning 1 m^2 . Observations from mini-rhizotrons are considered to overestimate actual RLD but they can provide reliable estimates of comparative activity and, given that caution, the overall conclusions of the two studies are similar. Under localized irrigation, RLD increased in the wetted zones and while roots in rain-fed orchards extended widely, those in drip- and micro-spray-irrigated orchards tended to be concentrated within the wetted volume. Maximum RLD occurred in winter-spring in rain-fed systems but in summer in irrigated systems. The studies have thus provided evidence of the plasticity of olive root systems to adjust to the localized wetting patterns, now common in many new plantings under micro-irrigation. The evergreen nature of the olive, and the usual wetting of the whole profile in winter in Mediter-

ranean climates, usually ensures that roots proliferate within the potential root zone, regardless of the irrigation method.

Root morphology is also affected by water supply. Lo Gullo et al. (1998) observed that roots responded to drought stress by forming a multi-layered and more suberized endodermis, while Fernández et al. (1994) reported that the transition to secondary growth occurs closer to the apex for roots that extend into dry rather than wet soil.

B. Floral Induction, Initiation, and Differentiation

Flowering in olive occurs on buds formed in the leaf axils on shoots produced in the previous year. The sequence of development passes through **induction**, when changes in gene expression commit the future development of buds to floral structures, to **initiation**, when the floral structures are evident by microscopic examination, and finally to **differentiation** as the buds grow to form mature flowers.

Floral induction occurs in mid-summer (7 to 8 weeks after full bloom) around the time of pit hardening (endocarp sclerification) of the current season's fruit, i.e., stage PS75 (Sanz-Cortés et al. 2002). Floral induction is apparently influenced by compounds released by the developing fruit and seed that are translocated to the buds (Stutte and Martin 1986; Rallo and Martin 1991; Fernández-Escobar et al. 1992; Lavee 1996; Fabbri and Benelli 2000). Induction cannot be observed visually, but associated changes have been detected by histochemical techniques. Thus, Pinney and Polito (1990) and Navarro et al. (1990), both working with 'Manzanillo', recorded changes in the ribulose nucleic acid content of buds in autumn that are linked to morphological changes that precede floral initiation.

The recognition of induction as a separate phase that is established before winter is important to understanding the complexities of flowering in olive. Vernalization (exposure to cool temperatures, <7°C) controls the second phase of the reproductive process, i.e., the initiation of induced buds, sometimes described as their "release from dormancy" (Rallo and Martin 1991; Fabbri and Benelli 2000). After bud burst in Spring the entire tree enters a period of growth with a dominant response to increasing temperature. This changed response to temperature explains why early analyses of thermal response of flowering in olive emphasized the importance of alternating temperatures and the conflicting requirements between low temperatures required for vernalization and warm temperatures required for growth and subsequent flowering (Denney and McEachern 1983).

Although some morphological signs may be evident earlier, floral initiation can be unequivocally recognized soon after bud burst (PS53) about two months prior to flowering (PS60) in late Spring (Rapoport 1998; de la Rosa et al. 2000). Some buds are initiated and some of those differentiate to produce inflorescences. It is unknown if this results from incomplete induction or if the process is reversible. In addition to internal controls, environmental conditions following bud burst are important determinants of floral morphology, including number of flowers per inflorescence and the proportion of staminate flowers (Rallo et al. 1981; Rapoport and Rallo 1991b).

The inhibition of floral induction by fruit and seed growth also contributes to alternate bearing that is characteristic of olive. Years of intense fruiting ("on") tend to be followed by years of restricted flowering ("off" years). This pattern of biennial flowering and yield, common in fruit trees, is well expressed in olive (Rallo 1998).

C. Response of Flowering to Temperature

Hartmann's group in California (Hartmann 1953; Hartmann and Porlingis 1958; Hackett and Hartmann 1967; Hartmann and Whisler 1975) studied the role of temperature, including chilling, in the flowering response of olive. Based on this work, Denney and McEachern (1983) proposed an optimum temperature regime for flowering of 2 to 4°C (minima) and 15.5 to 19°C (maximum). Plants grown at a constant temperature of 7°C produced few if any flowers, so this fluctuating temperature regime was interpreted as providing the optimum balance between the chilling signal (vernalization) that released induced buds for further development and the warm conditions that supported the associated growth, without high temperature that could reverse the chilling effect (devernalization). It is unknown how widely this model can be applied, or if optimum temperatures or durations vary among cultivars. It is known, however, that a chilling requirement is not absolute because olives flower and produce fruit in various subtropical locations where vernalization requirements, as defined above, are not met.

A temperature-based model for predicting flowering in olive is urgently needed to specify individual responses of vernalization and devernalization during the successive stages from induction through initiation and differentiation to full bloom. Hopefully this advance would make it possible to evaluate the actual adaptive range of cultivars and untangle the internal non-temperature effects on flowering. Ayerza and

Sibbett (2001) evaluated the suitability of new sites for olive production in the Chaco Region of Argentina by comparing the probabilities of minimum and maximum temperatures in the ranges 0.0 to 12.5 and 12.5 to 21.1°C, respectively, and the probabilities of extreme cold (<0°C) and heat (>37.8°C) during flowering periods, with those of established sites in Argentina, Italy, Mexico, Spain, and the United States. By these criteria, all Italian and Spanish sites had at least 150 vernalizing days per year, while no existing Argentine site—San Juan (31° 34' S, 598 m), Mendoza (32° 50' S, 704 m), or San Rafael (34° 35', 748 m)—exceeded 110. All proposed new Chaco sites had less than 60 vernalizing days and also recorded the greatest daily probabilities of heat damage during flowering. On this basis, caution is warranted in expanding olive areas in Argentina and comparable environments and should be based on evaluations of the potential damage of high temperature at flowering rather than on low probability of vernalization. This is evident because olives flower and bear fruit in a number of subtropical regions in the world. The same study (Ayerza and Sibbett 2001) reported that 'Criollo' can bear good crops at a coastal site at Ica, Peru (14° 05' S, 398 m) without, according to the above definition, any exposure to vernalizing temperatures.

The flowering of 'Criollo', without evident vernalization, on the coastal lowlands of Peru, is not a matter of cultivar difference only, because other cultivars are grown there and they also flower. It is common practice in that region to suspend irrigation during the dry winter months. This is not simply a copy of traditional management practices in Spain where winters are cool and rainy; rather, the practice has developed because water stress promotes flowering once irrigation is resumed in spring (F. Castillo, pers. commun.). It seems that water stress at that time plays a role in the flowering of olive similar to that of low winter temperatures in the Mediterranean. This proposed similarity may offer an important physiological lead to be pursued in untangling the nature of internal controls of flowering in olive.

The beginnings of a multistage model of flowering response can be found in Alcalá and Barranco (1992). Working with flowering dates recorded for a collection of 170 cultivars at Córdoba, Spain, they established the period during which heat accumulation above a threshold temperature best explained the variation in flowering times over a ten-year period. They established that a common mean daily threshold temperature of 12.5°C was appropriate for all cultivars but that the best fit to commencement of the heat accumulation period varied among cultivars from 1 January to 1 March.

D. Flowering, Pollination, and Fertilization

Flowers are produced in great numbers in panicle inflorescences of up to 40 flowers each, depending on cultivar and growing conditions. One report (Tous and Ferguson 1997), reports up to 500,000 flowers per tree under Californian conditions but the number clearly depends upon tree size and growing conditions. The individual branches of inflorescences contain from 1 to 4 flowers on short peduncles (Martin 1990; Rapoport 1998). Flowers can be bisexual (perfect) or male (staminate), the proportions depending upon cultivar, growing conditions, "on" or "off" condition, and position on tree. In individual studies, the percentage of perfect flowers has ranged from 20 to 96 (Rapoport and Rallo 1991b; Cuevas et al. 1994; Dimassi et al. 1999; Ferrara et al. 1999; Ghrisi et al. 1999). Dimassi et al. (1999) recorded a greater proportion of perfect flowers in the middle of inflorescences located in the middle of flowering shoots on the southern (sunny) side of trees, the most favorable location for the growth of individual shoots on trees in the northern hemisphere. Perfect flowers contain four ovules, two in each of two locules (Rapoport 1998) and are short lived. Pollen is produced in abundance over ca. 5 days and individual stigmas remain receptive for ca. 2 days. Flowering in individual trees lasts for ca. 10 days and in orchards for ca. 20 to 30 days.

Pollination is by wind and is hindered by strong winds and rain, and may also suffer from high temperature or hot winds that desiccate pollen and stigmas. For individual trees, the success of such a haphazard process increases with flower number and pollen production. Subsequent fertilization comprises a number of steps. It involves recognition of pollen by the stigma, and in response, the growth of pollen tubes each carrying two gametes downwards within the style towards the ovules in the embryo sac. Usually a single pollen tube enters the embryo sac (Rapoport 1998). This process must be complete while the ovule remains receptive and hence pollen vigor is important, especially when plant and environmental conditions are suboptimal for ovule fertility and pollination. Staminate flowers desiccate first, quickly followed by perfect flowers after successful fertilization (Rapoport and Rallo 1991b).

It has been observed that pollen tubes grow more vigorously following cross-pollination between cultivars (Fernández-Escobar et al. 1983; Ghrisi et al. 1999; Cuevas et al. 2001).

E. Self-Compatibility

Olive is partially self-incompatible, so cross-pollination increases fruit set and yield. There is good evidence that cross-pollination leads to more vigorous growth of pollen tubes (Ghrisi et al. 1999; Cuevas et al. 2001) that can be advantageous in adverse environmental conditions when pollen is in short supply or stigma receptivity or ovule fertility is low (Fernández-Escobar et al. 1983). Under those conditions, high pollen-tube vigor may improve fruit set and yield. Recent work with crosses among 'Picual', 'Hojiblanca', 'Manzanilla', and 'Arbequina' revealed that improved fertilization was not, however, the only advantage of cross-pollination (Cuevas et al. 2001). Those experiments report increases in both the proportion of fruit retained and the number of fruit set. This identifies the existence of additional recognition-acceptance-rejection mechanisms operating between embryo and maternal tissue that are clearly important given the considerable experience that greater fruit set need not translate to greater fruit retention.

The benefit of cross-pollination is well recognized in many production zones in the form of specific recommendations for pollinizer-receptor pairs and maximum distances (e.g., 30 m) between pollinizer trees in orchard design (Griggs et al. 1975; Rallo 1998; Dimassi et al. 1999; Ferrara et al. 1999). In other regions, where little attention has been previously paid to cross-pollination, benefits are now being detected. An example is found in Jaen Province, Andalusia, Spain, where 200,000 ha have been planted to 'Picual' without concern to the provision of pollinizers. Recent work in that region has detected advantages to fruit set and yield by cross-pollination among the cultivars 'Picual', 'Hojiblanca', and 'Arbequina'. This has led to recommendations for associative plantings of those cultivars, considered to be especially valuable in years of poor flowering (Cuevas et al. 2001). There is ample evidence, however, that some major cultivars have a relatively high self-compatibility that provides adequate pollination under most seasonal conditions. Examples include the extensive plantings of 'Picual' in Andalusia, 'Chemlali' in central Tunisia, and 'Arbequina' in Catalonia, each grown widely without pollinizers (Anon. 2000). The causes and consequences of this behavior need to be investigated. Note that detection of the degree of self-compatibility is potentially underestimated by the routine method of bagging inflorescences on individual trees. Quite apart from the danger of unsuitable environmental conditions within the bags, this technique evaluates within-tree and not within-cultivar compatibility.

The inclusion of pollinizers is easily satisfied in commercial practice because there are good reasons to design orchards with more than one cultivar, including diversification of oil quality, spreading harvest requirements, minimizing risk from environmental variability, and changing market preferences. Further work is urgently needed, however, because uncertainties remain on the necessity of receptor-pollinizer pairs, and their optimum combinations, especially in new olive-producing regions.

F. Fruit Set, Filling, and Maturation

In most cultivars, a single fertilized ovary develops per inflorescence, but there are exceptions, particularly in cultivars with small fruits such as 'Arbequina' and 'Koroneiki' that usually produce more on most inflorescences. Most ovaries, fertilized or not, soon abort. Fruit set at 2 to 3 weeks after flowering (PS71) may account for 10 to 15% of total flowers, but it continues to decrease, to 7 to 10%, in the following 4 to 5 weeks (i.e., 6 to 7 weeks after full bloom, PS75). Thus, in 'Manzanillo de Sevilla', just 25% of ovaries were retained at the end of flowering (marked by petal drop, PS68) (Troncoso et al. 1978), and only 5% survived to fruit filling (Rapoport and Rallo 1991a). Analysis of growth patterns of ovaries following fertilization indicates a possible role of substrate competition (Rallo and Suarez 1989; Rapoport and Rallo 1991a). Some ovaries develop parthenocarpically, i.e., without fertilization. Those fruits (zofairones) are smaller and commercially unimportant because most abort quickly and few persist until harvest (Rapoport 1998). Their formation may, however, be indicative of environmental conditions or physiological defects during flower formation, pollination, or fertilization. The characteristic of many olive cultivars to set a single fruit per inflorescence establishes the inflorescence as the effective reproductive unit (Rallo and Fernández-Escobar 1985) which is more appropriately, as well as more easily, used than flower number to calculate an index of fruit set.

Despite the usual large losses of flowers and fruits, partial fruit removal (fruit thinning) is often used to increase fruit size. This can be achieved by mechanical (beating with sticks) and chemical methods (e.g., naphthaleneacetic acid) during early stages of fruit growth (PS71) (Kreuger et al. 2002). For table cultivars, where fruit size determines quality, as many as 70% of fruitlets may be removed in years of heavy fruit set. Fruit thinning is also undertaken in an attempt to minimize alternate bearing but it may be an ineffective practice because it appears

that complete flower removal is required to ensure return to bloom (Rallo et al. 1994).

Growth of the olive fruit (botanically a drupe) lasts for 4 to 5 months (PS71 to PS89) and involves cell division, cell expansion, and storage of metabolites, dominantly, but not exclusively, in that order. After 1 to 2 months of intense cellular division, during which 80% of final cell number is formed (Manrique et al. 1999), the three component tissues (exocarp, mesocarp, and endocarp) can be identified visually. The first, comprising a layer of epidermal cells rich in chloroplasts, is covered by a thin cuticle and contains rudimentary stomata that are lost in the following month (Proietti et al. 1999a). The mesocarp tissue is rich in protoplasm and surrounds the endocarp that is increasingly sclerified. Then, about 2 to 3 months after fruit set and about halfway through the fruit-growth period, the fruit is covered by a waxy layer, mesocarp cells have developed vacuoles, and the endocarp has completely sclerified (pit hardening, PS75) and ceases enlargement. Then follows the major period of oil deposition that continues until maturity. This sequential pattern of tissue growth determines the response of the major fruit characteristics such as size, weight, pulp/pit ratio, and oil content to weather, fruit load, and orchard management practices (*see also* Section VI D).

An issue of considerable commercial importance is the intrinsic seasonal pattern of fruit growth. Initial reports indicated that the pattern of olive fruit growth (Lavee 1986, 1996) followed a double sigmoid that is characteristic of deciduous stone fruits (Mitchell and Chalmers 1982). However, while periods of suspended fruit growth commonly coincide with pit hardening in rain-fed olive orchards subject to summer water shortage, fruit growth continues under irrigation. Fruit dry weight increases linearly during the first part of fruit growth (Fig. 4.1) in the absence of water deficits, slowing when oil accumulation processes (Section VI D) increase the energy content of dry matter (Tombesi 1994).

At fruit maturity, three abscission zones develop: one where the peduncle joins the branch, and two more where the pedicel joins the peduncle and fruit, respectively (Barranco et al. 2002). In consequence, the physical force required to remove fruit decreases during maturation. The process of abscission is under the control of ethylene released by the maturing fruit, and there is considerable variation between cultivars (Hartmann et al. 1970; Rallo 1998). Controlled and synchronized fruit fall benefits fruit quality, especially with the advent of mechanical harvesting when the objective is to remove all fruit in a single operation without physical damage to the tree. Various treatments are available to decrease retention force, including the application by spray of ethylene

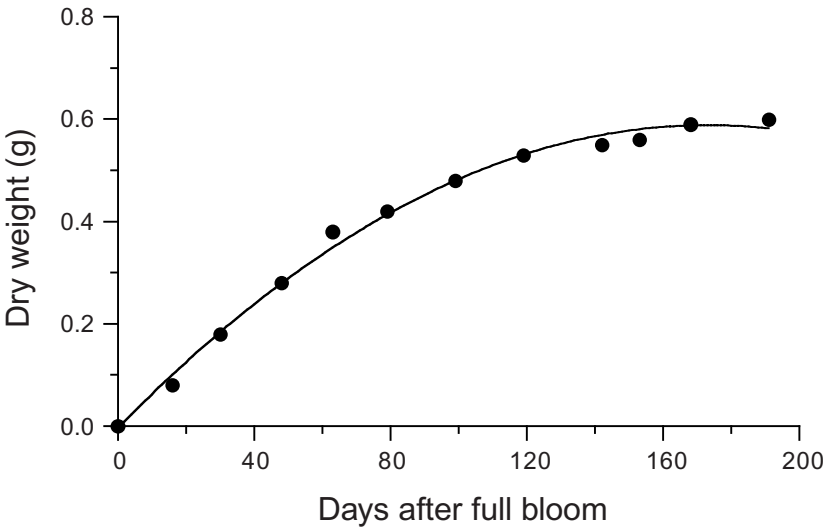

Fig. 4.1. Pattern of dry matter accumulation in olive fruit from flowering to maturity under irrigated conditions (Tombesi 1994).

compounds and monopotassium phosphate (MKP). The latter appears to stimulate release of ethylene compounds (Yamada and Martin 1994). Fruit retention force (FRF) of ‘Arbequina’ and ‘Picual’ decreased within 2 weeks of application of 3% MKP (with surfactants) and remained less than the naturally declining FRF (control) for up to 10 weeks (Barranco et al. 2002). Harvest efficiency, the proportion of fruits harvested, increased from 45 to 60%, with best results obtained 4 weeks after treatment. Treatment did not change the distribution of separation zones; most fruit were released at the peduncle and least at the fruit itself.

G. Efficiency of Reproductive Strategy

In years of heavy flowering, a fruit set of 1 to 2% of flowers can be adequate for a good commercial yield and as many as 50% of flowers can be removed without affecting final fruit number (Lavee et al. 1999). The energetic and nutrient efficiencies of the massive flowering and fruit loss of olive appear small, but there is little quantitative information on these aspects. Bouranis et al. (1999) presented biomass and nutrient content of olive inflorescences at flowering. Assuming 2 million inflorescences ha^{-1} (200 trees ha^{-1} with an average of 10,000 inflorescences of 70 mg dry weight each), the total dry weight at full flowering would

amount to 140 kg ha^{-1} , containing around 300 g N, 150 g P, 850 g K, 500 g Ca, 40 g Mg, 18 g Fe, and around 2 g each of Cu, Zn, and Mn (Table 4.2). This biomass could be easily produced by normal olive canopies with growth rates that would approach $65 \text{ kg ha}^{-1} \text{ day}^{-1}$ in the month up to flowering, without the necessity to draw on reserves. That growth rate was calculated using a daily incoming photosynthetically active radiation (PAR) of 8 MJ m^{-2} with 60% intercepted by the canopy and a radiation-use efficiency (RUE) of 1.35 g MJ^{-1} intercepted PAR measured by Mariscal et al. (2000b) on young plantations of 'Picual' growing at high density. The nutrient requirements of this growth are not substantial and there is also the possibility of substantial mobilization of nutrients into surviving fruitlets during the flower- and fruit-abscission period.

Overall, we identify three features that minimize energy and nutrient costs of reproductive strategy in the olive. First, the large proportion of male flowers increases pollen production at lower cost per flower or pollen grain than for perfect flowers. Second, the rapid abortion of flowers following successful fertilization on individual inflorescences further reduces wasteful tissue growth. Third, the rapid abortion of many fertilized ovaries occurs before they become significant sinks for assimilate. On balance, olive may have an effective strategy when compared to the alternative of producing nectar, which was adopted to secure pollination in many species.

III. WATER RELATIONS

The metabolism of all terrestrial plants operates in an aqueous phase, placing them in the hostile interface between a transiently wet soil and a relatively dry atmosphere. In this sense, plant growth can be considered as resulting from an interchange of internal water for carbon dioxide from the atmosphere required for photosynthesis. The loss of water from plant leaves (transpiration, T) establishes internal flows that eventually draw replacement water from the soil via roots. Rates of water flow into and within the tree depend upon gradients of water potential ($\partial\psi/\partial z$) and hydraulic conductance to transport, with the xylem providing a high-conductance, direct, internal pathway between roots and canopy. The internal water status of plants thus varies dynamically in response to the balance between loss and uptake. The important short-term dynamic is diurnal. Evaporative demand increases as the day advances and plant water content falls to a minimum around midday provided soil water content is high. It recovers in the evening so that plants may then approach equilibrium with the water potential of the soil (ψ_s). As the root

zone dries, however, leaf water potential (ψ_l) falls further each day and, despite gradual control of water loss by stomatal closure, recovery slows until the soil is re-wetted by rainfall or irrigation. After a prolonged dry period, ψ_l is much lower than ψ_s , even by dawn the following day. If serious internal water deficit persists, metabolism is disrupted and plants eventually die from desiccation.

Growth and survival, therefore, require adaptations to the uptake and conservation of internal water status that are appropriate to the environmental patterns of water supply and demand. The special features by which the evergreen olive is able to maintain an adequate internal water status during severe summer drought derive from its ability to restrict loss of water to the atmosphere and withstand the substantial internal water deficit that is required to maximize extraction of water from the soil. In practice, orchard management greatly assists this balance between uptake and loss by adjusting the size of the transpiring canopy that intercepts radiation by controlling the ground cover that minimizes or prevents non-tree transpiration, and in some situations by full or deficit irrigation. Canopy volume and cover are managed through planting density and pruning (Pastor Munoz Cobo and Humanes Guillen 1996; Gucci and Cantini 2000), while ground cover is controlled either by tillage or herbicides (Pastor et al. 1998).

A. Collection of Water by Root Systems

Root systems are possibly the least explored area in crop physiology even though their roles in the uptake of water and nutrients are central to crop adaptation and management. Whereas we have relatively good information on the production, distribution, activity, and lifespan of leaves, comparable information is not available for roots. Without information on the seasonal and spatial distribution of length, surface area, and activity we cannot expect to properly understand the capacity of root systems to absorb water and nutrients. Newly formed roots probably provide the uptake capacity while older roots, which survive harsh conditions and predation to undergo secondary thickening, provide the framework for exploration, the conduit for transport to foliage via trunk, and anchorage to the soil. There are, however, few data to help us quantify the processes and understand their dynamics in olive.

Most olive trees are produced vegetatively and do not have root systems dominated, at the outset, by a principal axis as occurs in trees grown from seedlings. Rather, many adventitious roots are produced from the base of either woody or semi-woody cuttings. The lateral spread of these root branches and the depth they achieve depend upon tree

vigor, soil depth, mechanical resistance, aeration, moisture content, fertility, pruning, and perhaps cultivar (Navarro and Parra 1998). There is folklore that olive tree roots extend laterally only to the width of the canopy and this may be true of surface roots in orchards that are frequently tilled. It can be more reasonably concluded, however, that the successful tree spacings of traditional orchards are those that explore the soil volume completely, at least in the driest times. The success of olive cultivation in marginal soils must be attributed, at least in part, to its root system, not only in extent but also in its plasticity and capacity to react quickly to changes in soil water content. Unfortunately, we can only infer some of these properties indirectly, from shoot behavior.

A number of papers refer to aspects of root distribution and performance in olive (Rieger 1995; Moreno et al. 1996; Palese et al. 2000) but there is little systematic information about root distributions and dynamics. In one study, Fernández et al. (1991) made extensive observations by trench excavation and auger sampling to 2 m depth within 7×7 m orchards of 20-year-old 'Manzanillo' (table olive) growing on a deep sandy loam soil at Sevilla, Spain. The observations, made in summer, revealed that irrigation increased root length density (RLD) but decreased the spread of roots, largely confining them to the wetted area. It is probable that roots, developed outside the wetted area during the rainy periods in that treatment, either died or were not detected by the sampling technique. In a 12-year-old rain-fed treatment, roots were well distributed to 2 m depth and to a distance of 2 m from the tree but nowhere with densities exceeding 0.5 cm cm^{-3} . Except under the canopy, roots were less frequent in the surface than in lower layers. In contrast, drip irrigation to $0.4E_{\text{pan}}$ for 8 years had dramatic effects, with roots largely confined to the dripper line and RLD up to 6 cm cm^{-3} in the surface layer adjacent to the trees. Such values are extremely high and suggest either extreme confinement or contamination of samples by roots of weeds. In another plot of finer surface soil texture, but where root penetration was restricted to 80 cm depth by an impervious layer, RLD in similar locations never exceeded 1 cm cm^{-3} and roots were more evenly distributed in the wetted volume. Away from the canopy, there were few roots in the surface along the dripper line, or at depth on transects running at right angles to it. Tillage, undertaken routinely three times per year to 20 cm, could explain the low surface densities in both treatments, but there is no explanation for absence of roots at depth under irrigation.

Analysis of the two treatments of Fernández et al. (1991) can be extended to estimate total root length as an important parameter of the water-collecting capacity of root systems. Here, RLD profiles to 1.5 m

and spatial distributions within 4×4 m centred on the tree reveal mean RLD for roots <0.5 mm diameter of 0.177 and 0.224 cm cm^{-3} for rain-fed and irrigated treatments, respectively. If this soil volume (24 m^3) sampled most of the root system, then the corresponding root lengths were 42.4 and 53.6 km per tree. Even allowing for the smaller tree density and estimation of RLD from root weight that possibly underestimates the total length of fine roots, these estimates greatly exceed those reported for 6-year-old 'Coratina' at 6×3 m spacing (Dichio et al. 2002). There, RLD in irrigated and rain-fed trees of 0.022 and 0.018 cm cm^{-3} within explored volumes of 16.8 and 13.4 m^3 , estimate total length per tree at 3.7 and 2.5 km, respectively.

In terms of tree water balance, the importance of root length resides in the capacity of the root system to obtain water to support the transpiring leaf area (see Section III D). In sunflower, Connor and Jones (1985) recorded root lengths of 7.8 and 5.2 km m^{-2} ground area, corresponding to root length/leaf area ratios of 2.5 and 4.8 km m^{-2} leaf area, for rain-fed and irrigated crops, respectively. If the LAI of the rain-fed olive orchard (Fernández et al. 1991) was 0.4, a small but typical value of a good orchard subjected to the severe pruning practices in that area, then at 7×7 m spacing, the root length/leaf area ratio would vary from 2.2 to 2.7 km m^{-2} , a comparable value to that of sunflower. The contrast between RLD reported in the two studies, in Spain and Italy respectively, is an illustration of the uncertainties, assumptions, and differences found in the literature on this subject.

In many species, colonization of roots by mycorrhizae is known to affect root morphology and assist the uptake of water and nutrients, especially under conditions of low fertility and water supply. Arbuscular mycorrhizae have been recorded in olive (Hayman et al. 1976) and while there is no information on the impact on tree performance in the field, growth advantages have been reported in rooted cuttings. Citernes et al. (1998) recorded more extensive and more branched root systems in 'Frantoio', 'Moraiolo', and 'Leccino' and greater shoot growth in 'Frantoio' and 'Moraiolo' following inoculation by *Glomus mosseae*.

B. Leaf Anatomy and Water Relations

Olive leaves are well adapted to conditions of water shortage. They are small (5–6 cm long and 1–1.5 cm at widest point), sclerophyllous, and have stomata on the lower (abaxial) surface only. The specific leaf mass (SLM) was in the range 190 to 220 g m^{-2} for field-grown plants of 'Picual' (Mariscal et al. 2000b), although smaller values are reported for plants grown under controlled conditions (e.g., 130 g m^{-2} for 'Frantoio' and

'Leccino') (Gucci et al. 1997). Leaf surfaces, especially the abaxial ones, are covered with wax sheets and peltate trichomes. The latter are characteristic scales supported above the epidermis on single cells (Fahn 1986). Olive invests a considerable amount of biomass in trichomes, estimated at 2.6% of leaf dry matter for 'Koroneiki' (Karabourniotis et al. 1992). These trichomes confer a less green color to the abaxial surface of leaves, which is especially noticeable in some cultivars, e.g., the appropriately named 'Hojiblanca'. Mariscal et al. (2000a) measured the reflectivities of adaxial and abaxial surfaces of three cultivars. 'Hojiblanca' (0.063, 0.13), was the most reflective, followed by 'Picual' (0.06, 0.12), and then 'Arbequina' (0.06, 0.10). High reflectivity, combined with small leaf size, assists with dissipation of sensible heat, thus minimizing differences between leaf and air temperatures, a feature particularly important when stomata close under conditions of water shortage.

The internal structure of the leaf is comprised of two layers of elongated palisade cells, one associated with each epidermis, that enclose the mesophyll with characteristically thick cell walls (Bongi et al. 1987a), dispersed vascular bundles, and lignified strengthening tissues. The upper and lower palisade layers are usually three and one cell deep, respectively (Chartzoulakis et al. 1999; Bosabalidis and Kofidis 2002). The compactness of the internal structures explains the large SLM, the low transmissivity to PAR (<0.0002) (Mariscal et al. 2000a), and the small area of mesophyll cells exposed to air within the leaf, estimated in the range 6 to 15 $\text{m}^2 \text{m}^{-2}$ leaf area for 'Ascolana' and 'Koroneiki', respectively (Bongi et al. 1987b; Chartzoulakis et al. 1999). The consequence is a small internal conductance to water vapor transport of around 0.4 $\text{mmol m}^{-2} \text{s}^{-1}$ (Chartzoulakis et al. 1999) for 'Mastoidis' and 'Koroneiki'. Stomata are small (length by breadth = ca. 25 by 20 μm) with apertures ca. 11 by 5 μm and are embedded in the abaxial epidermis at densities of 400 to 800 mm^{-2} for 'Mastoidis' and 'Koroneiki' (Bosabalidis and Kofidis 2002). The stomatal characteristics, combined with the waxy cuticle and trichomes afford good control over water loss by transpiration. The conductance of the waxy cuticle is negligible so that leaf conductance to water vapor transfer from sub-stomatal cavities to the boundary layer (g_l) is essentially equal to the stomatal conductance (g_s). Many papers cited in this review use g_s synonymously with g_l .

Leaf size and structure vary among cultivars. Chartzoulakis et al. (1999) and Bosabalidis and Kofidis (2002) provide comparisons of leaf anatomy of the two major cultivars, 'Mastoidis' and 'Koroneiki', grown on the island of Crete, including their responses to water shortage. Under water stress, leaves were smaller and thinner and were composed of more, smaller, and more densely packed cells in each tissue type.

Trichomes and stomata were more numerous. The net result was higher reflectivity, less-conductive cuticles, improved stomatal control, and a smaller cell area exposed for evaporation within the mesophyll tissue, i.e., smaller g_w (Bongi et al. 1987b). Bosabalidis and Kofidis (2002) also established differences in cultivar response to water shortage. While there were no differences between the cultivars in cell wall elasticity or osmotic adjustment, greater response in stomata and trichome densities in 'Koroneiki' were consistent with its perceived greater drought tolerance.

Cell turgor develops due to inflow of water in response to low osmotic potential (ψ_π). When water loss is excessive, cells lose turgor to the detriment of cell expansion in growing tissues, structural stability, metabolism, and guard cell movement for stomatal control. Loss of water lowers ψ_π and therefore increases ability to absorb water from neighboring cells and tissues, and in the case of roots, to withdraw water from the soil. Many plants, however, have developed the ability to further decrease ψ_π during water shortage and maintain turgor, metabolism, and water uptake, by the accumulation of osmotically active ions and metabolites. This is known as osmotic adjustment and, in olive, the accumulation of mannitol (Flora and Matore 1993; Dichio et al. 2003) plays a major role.

C. The Olive Tree as a Hydraulic System

A tree can be represented hydraulically as a conductor-capacitor model in which the canopy is connected in series to the root system by the xylem, and each of the three components is in turn connected in parallel to internal storage tissues (Fig. 4.2). On a diurnal basis, the active storage tissues are the sapwood, with associated cambium and phloem, and the canopy. The flows in the xylem are determined by gradients of water potential and hydraulic conductance, while movement to/from the storage tissue is explained by storage volume and capacitance (Q), i.e., change in water content per unit change in water potential ($Q = \partial W / \partial \psi$).

Sap flow begins in the morning when the canopy has lost enough water for the concomitant decrease in ψ_1 to provide the required hydraulic lift. At the same time, withdrawal from sapwood storage allows transpiration to further exceed uptake by roots and thus slow the decline in ψ_1 . The greater the storage relative to transpiration, the longer the delay until flow increases in the roots. Late in the day, as ψ gradients reverse, storage can be replenished when water uptake exceeds transpiration. As soil water content decreases from day to day, the time for recharge of storage is delayed, depending on stomatal control, later

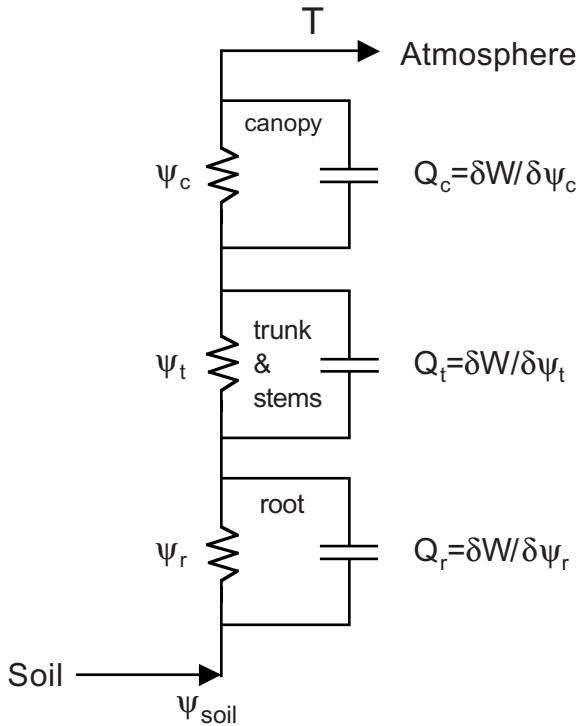

Fig. 4.2. The conductor-capacitor model for tree water relationships. The component organs of canopy, stems, and roots are connected by the xylem. Transpiration from canopy (T) reduces canopy water potential (ψ_c) that draws water from stems and roots, and ultimately from soil. Water flows between components down gradients of water potential ($\Delta\psi$) in proportion to pathway conductivities. Each organ has a capacitance (Q) that releases water (W) according to $Q = \partial W / \partial \psi$ and recovers it when T falls below root uptake.

into the evening or night. Such diurnal dynamics have been measured in many tree species (Wullschleger et al. 1998; Meinzer et al. 2001) and have revealed that storage contributes from 10 to 25% of daily transpiration. Schulze et al. (1985) working with 20–25 m *Larix* estimated a contribution of 16.7 kg from the canopy but only 1.6 kg from the trunk. The contribution of heartwood (old xylem) is less certain and is perhaps restricted to periods of extended drought.

Leaves at the tops of trees are the most exposed and therefore experience the greatest evaporative demand. They are also connected to the root system by the longest pathway and for both reasons are potentially subject to the greatest drop in ψ_l relative to the root (ψ_r). The pattern of conduction in a tree, i.e., the hydraulic architecture, is therefore an

important determinant of the distribution of ψ_1 throughout the canopy. Salleo et al. (1985) measured hydraulic conductivity ($\text{m}^2 \text{s}^{-1} \text{m}^{-2} \text{MPa}^{-1}$) of stem segments of 1-year-old shoots (cultivar not identified) in relation to xylem conducting area, xylem vessel area, and the leaf area supported by each segment. All parameters decreased with distance along the shoot and were highly linearly correlated. Conductivity of xylem vessels was an order of magnitude greater than that of xylem area, reflecting the small vessel diameter (ca. 10 μm) and large proportion of cell-wall tissue. Vessel density varied from 250 to 400 mm^{-2} . There was also a strong linear correlation between the leaf specific hydraulic conductivity (LSC), the rate of water flow per unit leaf area supported per unit pressure gradient and xylem area (and also vessel area) presenting an appealing view of tree hydraulic architecture with coordinated expansion of leaves and conducting capacity of the xylem. Thompson et al. (1983) had previously shown that LSC was related to stem diameter in primary, secondary, and tertiary branches of potted (4-year-old, 1.5 m tall) plants of 'Nocellara' and 'Coratina'.

Sap flow in olive trees has been measured in the trunks (Fernández et al. 2001; Giorio and d'Andria 2002; Giorio and Giorio 2003) and in roots (Fernández et al. 2001) using sap-velocity sensors and estimates of the xylem conducting area. This work has shown that sap flow is variable at depth within the xylem, around the trunk, and from major root to major root. The observation that the root system absorbs water preferentially from moist regions is consistent with the theory of water flow in response to gradients of water potential, as is also the rapid reactivation of parts of the root system following rainfall or irrigation. Favored connections between individual stems and parts of the root system could explain the variations of flow around the trunk. This has yet to be shown in olive, but has been inferred in other species, e.g., *Eucalyptus regnans* (Legge 1985) by following flow patterns of dyes injected into roots. Less clear are the observed profiles of water flow in the xylem. There is a general decrease in flow with depth that is consistent with gradual occlusion of vessels as they age, perhaps caused in part by embolisms. The issues of the formation of embolisms by cavitation, their possible recovery, and their significance to drought tolerance are discussed in Section VII A. The suggestion by Fernández et al. (2001) that the small flow recorded in the periphery of xylem tissues in water-stressed trees reflects stomatal control of transpiration of active leaves, preferentially connected to the youngest xylem vessels, requires further evaluation. Giorio and d'Andria (2002) also reported a similar form of sap-flow profile. Observations of night-time sap flow in roots are of interest to the role of capacitance in the water relations of trees, but addi-

tional associated measurements are required to establish the extent and importance of this, and other hydraulic characteristics, of olive.

One limitation of sap flow sensors in determining actual rates of transpiration is uncertainty in the dimensions of the cross-sectional area of the conducting xylem. Sap velocity probes are usually placed in one or several radial positions and the cross-sectional area of the trunk is assumed to be uniform around the circumference. Observations on olive trees have shown that the apparent area of the conducting xylem varies in thickness across various diameters, casting doubts on the assumption of uniform cross-sectional area (E. Fereres, unpubl.). Giorio and d'Andria (2002) installed sap flow sensors in a 7-year orchard of 'Kalamata' (6×3 m). There were strong linear relationships between tree transpiration (T) and reference crop evapotranspiration (ET_0) in both rain-fed and irrigated orchards. Irrigation was set at $0.36 ET_0$ according to the product of a crop coefficient and a cover factor, both = 0.6. Mean T of individual trees at $ET_0 = 5 \text{ mm day}^{-1}$ was recorded as 9 and 22 L day^{-1} for rainfed and irrigated, respectively, corresponding on an orchard basis to 0.5 and 1.2 mm day^{-1} . The T measured in the irrigated orchard was smaller than that calculated as $0.36 ET_0$ (1.8 mm day^{-1}). Cohen et al. (2001) found that sap flow sensors underestimated tree T by about 50% when compared with lysimeter measurements in peach.

Clearly there is much to be learned about these physiological and anatomical aspects of the water-conducting and water-storage characteristics of olive trees. Work done thus far with potted plants and small branches should be extended into the field. The daunting task of dealing with old trees can await the development of knowledge and techniques on young trees. They will present an easier target, and one that is more aligned with modern production systems. A good start would be to describe the structure of the conducting system—the hydraulic architecture of the tree (Tyree and Ewers 1991). What is the volume of the conduction system relative to canopy area? How does LSC vary from trunk to final branches? How does the capacitance of the sapwood compare with that of the canopy? How do storage and withdrawal contribute to diurnal and seasonal water status of the canopy? And inevitably, because of the potential disruption that it causes, how do these systems respond to pruning?

D. Control of Transpiration

There have been many studies of stomatal response to leaf water status and environment in olive (e.g., Abdel-Rahman and El-Sharkawi 1974; Natali et al. 1985; Xiloyannis et al. 1988; Fernández et al. 1993;

Fernández et al. 1997; Giménez et al. 1997; Chartzoulakis et al. 1999; Moriana et al. 2002). They reveal that stomata respond in ways consistent with their role in controlling transpiration (T) and maintaining leaf water status. Leaf conductance is small, and decreases as ψ_l falls and as vapor pressure deficit (VPD) increases. The observations of Moriana et al. (2002) in an 18-year-old orchard of 'Picual' at Córdoba are especially comprehensive. They reveal the dominant interaction of ψ_l and VPD on g_l at midday (Fig. 4.3). Maximum conductance of $240 \text{ mmol m}^{-2} \text{ s}^{-1}$ at that time was recorded when midday ψ_l exceeded -1.65 MPa and VPD was small (ca. 1 kPa). Conductance fell with decrease in ψ_l . The response to VPD persisted in leaves in which ψ_l exceeded -4.0 MPa , but below this value the small g_l in leaves that were substantially water stressed was unresponsive to VPD. On a diurnal basis, g_l attained maximum levels in the early morning, and then decreased to a minimum during midday hours. In the afternoon, g_l followed stable or declining patterns depending on environmental conditions. Response to VPD is considered to operate through peri-stomatal transpiration and isolation of guard cell water status from the bulk leaf (ψ_l). The observation that stomatal aperture varied from place to place on olive leaves (Loreto and Sharkey 1990) is evidence of independence of guard cells at high ψ_l . When ψ_l

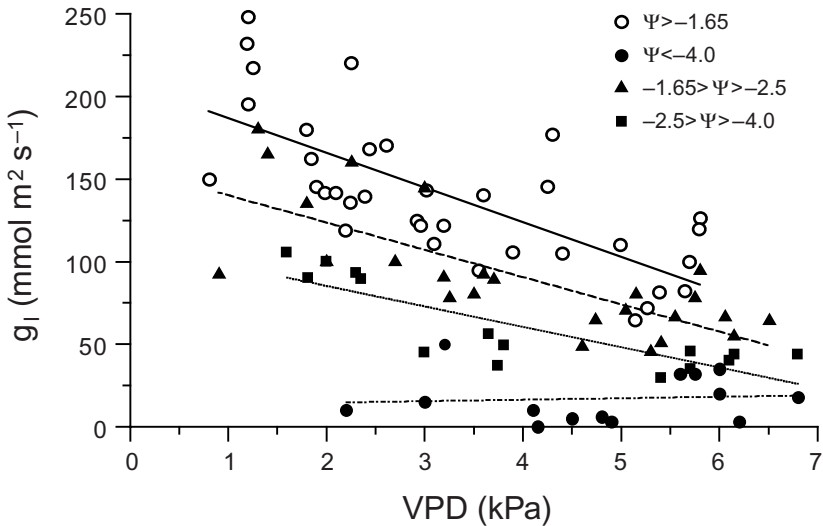

Fig. 4.3. Relationships between midday leaf conductance (g_l , $\text{mmol m}^{-2} \text{ s}^{-1}$) and vapor pressure deficit (VPD, kPa) for olive trees at four levels of leaf water potential (Ψ_l) (Moriana et al. 2002). Reprinted with permission of Blackwell Publishing Ltd.

declines substantially, however, it is increasingly unlikely that guard cells can remain isolated and hence independently responsive to VPD.

The observed stomatal responses of olive are not, however, fully explained by changes in ψ_1 and VPD. For example, Moriana et al. (2002) found that maximum and midday g_1 varied seasonally, even under well-watered conditions, and were also affected by fruit load. Thus olive stomatal responses to water stress cannot be interpreted using simplified physical models of the continuum of water status in trees because it appears that endogenous factors modulate responses in the long term. A similar conclusion first emerged from the analyses of interactions between g_1 and ψ_1 of fruit trees growing in the Negev desert (Schulze and Hall 1982).

In olive, the regulation of g_1 below its maximum during much of the day is the cause of the small canopy conductance (g_c) for the entire orchard (Villalobos et al. 2000). The impact of small canopy conductance on orchard T depends on the degree of coupling of the canopy with the atmosphere (MacNaughton and Jarvis 1983). Smooth, short canopies of field crops are not well coupled with the atmosphere and show only small reduction in transpiration as canopy conductance is reduced. In contrast, sparse, rough tree canopies, such as olive, are well coupled so a reduction in canopy conductance reduces T by a similar magnitude (Villalobos et al. 2000). Small canopy conductance of olive explains the small values of the empirical crop coefficients recommended to estimate ET of olive orchards (Orgaz and Fereres 1998; Pastor et al. 2001). At full cover (CC >0.5), drip-irrigated orchards experience little soil evaporation, and ET is in the range 50 to 65% of reference crop evapotranspiration (ET_0). Such values are less than those proposed for citrus (75%) and for most tree crops (85–110% of ET_0) (Allen et al. 1998).

IV. MINERAL NUTRITION

Olive, as other higher plants, requires macro- (C, H, O, N, S, P, K, Mg, Ca) and micro-nutrients (Fe, Zn, Cu, Mn, B, Cl) in appropriate amounts for continuing growth and yield. With exception of C, H, and O, obtained from air and water, the remainder are absorbed by roots from soil. Nitrogen deserves special attention, not just because it is the nutrient required in the greatest amounts, but also because unlike other soil-borne nutrients, it exists dominantly in the organic phase. In the soil, N exists in continual interaction between living organisms, dead organic matter, and the mineral forms NH_4^+ and NO_3^- . Ammonium (NH_4^+) does not persist in aerobic soils and NO_3^- , a large molecule, exists dominantly in the

soil solution. Three features typify the nutritional relationships of olive. First, as a perennial, it is able to mobilize and store nutrients internally, for example by withdrawal from senescing organs, especially leaves. Second, the mineral content of harvested fruit is small and thus the export of nutrients, especially from low-yielding rain-fed systems, is trivial. Third, pruning together with natural litter fall provides the possibility of significant external cycling of nutrients, including the recovery of nutrients from depth and their concentration in surface layers of the soil.

The nutrition of olive can be discussed in two ways. The first is the detection of nutrient deficiency, or in some cases toxicity, by visual symptoms and soil and/or plant tissue analysis. The application of knowledge here is on tactical fertilizer management to maintain or improve productivity. The second concerns the contribution to the long-term functioning of olive orchards by the cycling of nutrients internally within the trees and externally by litter fall, pruning, and the return of harvest residues. An understanding of nutrient cycling is required for the development of sustainable nutrient management strategies that have special importance to the current expansion of organic production systems.

A. Deficiencies and Toxicities

Catalogues of visual symptoms of nutrient deficiency have been published for many species and while some photographs are available for olive (Sanz Encinas and Montanes Garcia 1997; Fernández-Escobar 1998), no comprehensive catalogue has been published. Analyses of soil nutrient content are also useful in diagnosis. Caution must be expressed here, however, because in addition to substantial spatial variability within orchards, there may also be large differences between amounts and availability of individual nutrients in the soil. Soil analysis is most useful to detect the presence of extremely deficient or toxic levels of nutrients, e.g., deficiencies of N, P, K, Fe, and B or toxic levels of Na, Cl, or B. Soil pH is itself a simple diagnostic test because it can predict availability of some nutrients, e.g., Mn and Fe.

The best means for detecting the nutritional status and thus the fertilizer requirements of olive orchards is by analysis of leaf nutrient concentration (Fernández-Escobar 1998). While there has also been some success using flowers in other crops, only preliminary data are available for olive (Bouranis et al. 1999). For leaf analysis, care is needed in sampling, because leaf nutrient concentration varies depending upon leaf age, position on tree, weather conditions, and fruit load (see, e.g.,

Fernández-Escobar et al. 1999; Sibbett and Ferguson 2002). Consequently, a standardized sampling procedure is required. For olive, this currently requires the collection around PS71 to PS74 of two to three current year's leaves, including petioles, from the base to the middle of non-fruiting shoots at various positions around the canopy. Time of leaf collection is not well defined and some data suggest that nutrient concentrations change during July but are more stable in October (M. Pastor, pers. commun.). To assess an orchard for nutritional requirements, a number of trees should be sampled. Sampling should avoid atypical trees, except for the specific purpose of diagnosis. Comparison with diagnostic data such as presented in Table 4.1 can, together with observations of visual symptoms, soil analysis, and local experience, provide a basis for fertilizer recommendations. Care should be taken in assessing fertilizer N needs based on short-term field trials, because olive, like most perennials that evolved in Mediterranean environments, has the capacity to mobilize N to meet its small needs for several years before leaf deficiency or a response to the addition of N can be detected.

The objective of fertilization is to maintain or improve the nutrient status of the tree, so as to maintain or increase crop productivity. It can be achieved, depending on individual nutrient and cost, by direct application to soil (either broadly or directed to each individual tree) or more efficiently through injection into a drip irrigation system (fertigation), application by spray to canopies (Fe, B, N), or by direct injection (Fe) into tree trunks (Fernández-Escobar et al. 1993). All these methods are appropriate and are used for olive.

Table 4.1. Diagnostic levels for nutrient concentrations in olive leaves.

Nutrient	Deficient	Marginal	Adequate	Toxic
N (%)	< 1.4		1.5–2.0	
P (%)	0.05		0.1–0.3	
K (%)	< 0.4	0.4–0.8	> 0.8	
Ca (%)	0.3		> 1.0	
Mg (%)	0.08		> 0.1	
Na (%)				> 0.2
Cl (%)				> 0.5
Cu (ppm)			> 4	
Zn (ppm)			10–30	
Mn (ppm)			> 20	
Fe (ppm)				
B (ppm)	< 14	14–18	19–150	> 185

Source: Reuter et al. (1997); Fernández-Escobar (1998).

B. Extraction and Cycling of Nutrients in Olive Orchards

The available data on nutrient concentrations in the various organs of olive are variable. There are many data on leaves and fruit, and one study on inflorescences (Bouranis et al. 1999), but nothing, to our knowledge, on branches, trunk, and roots. Data presented in the studies of nutrient uptake of young orchards (Celano et al. 1999; Xiloyannis et al. 2002) are only marginally useful. A compilation of data (Table 4.2), together with information on organ biomass, can be used to evaluate a range of issues in nutrient cycling in relation to orchard function and management. These include what is present in trees, how much is required for each year's growth, how much is cycled internally, what is removed by harvest, and what is cycled externally by litter fall and pruning. As olive production becomes more intensive, the nutrient dynamics and requirements contrast sharply with those of traditional olive culture.

The data in Table 4.2 allow estimates of extraction of nutrients in harvested fruit. It is small for P (1.1 kg t⁻¹), greater for N (7.2), and greatest

Table 4.2. Nutrient concentrations (dry weight basis) in component organs of olive trees.

Nutrient	Leaf ^z		Inflorescence ^y	Fruit	
	Current	Senescent		Pulp ^x	Entire ^w
N (%)	1.53	0.95	0.21		0.72
P (%)	0.15	0.11	0.10	0.125	0.11
K (%)	0.60	0.40	0.60	1.930	1.09
Ca (%)	3.0	4.5	0.35	0.118	0.10
Mg (%)	0.12	0.10	0.03	0.046	0.03
Na (%)				0.082	
Cl (%)					
Fe (ppm)	35	22	125	24.5	30.9
Mn (ppm)	40	32	16	4.3	4.1
Cu (ppm)	60	50	12	9.1	9.3
Zn (ppm)	17	15	12	27.0	7.6
B (ppm)	32	30			7.9

^zFernández-Escobar et al. (1999). Leaves ('Picual', 12-year orchard) are means of age classes, dead leaves are oldest (2+ year) on tree. Note that mean leaf wt of 85 mg was maintained in oldest leaves.

^yBouranis et al. (1999), 'Konservolia', 25 year, "on," at full bloom. Inflorescences of 4 branches from mid-shoot positions reached maximum dry weight of c. 85 mg.

^xMulas et al. (1999). Means of 9 clones of 'Nera' (table olive).

^wJordão and Lietão (1990). Means of 50 cultivars.

for K (10.9). Natural net accretion of N from storms and dust could account for extraction by 1 t ha^{-1} yield, but there is no such replacement for K, which is extracted in greater quantities, pointing to the need for care in developing K fertilization strategies. From a physiological perspective, there is no information on the role of K in fruit growth of olive, but by comparison with other plants K must play many roles in olive physiology, including some critical ones in the water relations through its osmotic activity.

There are few individual studies of the internal cycling of nutrients in olive. Exceptions are the comparisons of nutrient concentrations of mature and senescent leaves of 12-year-old 'Picual' (Fernández-Escobar et al. 1999) and observations of the apparent movement of B from young leaves to flowers during anthesis (Delgado et al. 1994; Perica et al. 2002). The data in Table 4.2 permit an analysis of the internal nutrient cycling from leaves as they senesce, because in this case the authors report that leaf mass (85 mg) did not change from maturity to the senescent condition. Leaves live for 2 to 3 years, so ca. 40% of the canopy is lost (and replaced) each year. The biggest recorded change is for N. For an orchard, N withdrawal will be around 12 kg ha^{-1} per unit loss of leaf area index (LAI) ($\text{SLM} = 200 \text{ g m}^{-2}$), which amounts to 39% of the N supply required for leaf replacement. External cycling of N by leaf fall is around 19 kg LAI^{-1} , but not all of this would be available to the tree after leaf fall. Severe pruning that removes up to 30% of the leaf canopy (with associated branches) is an infrequent intervention, but one that has substantial effects on nutrient and water demand as well as on nutrient cycling. The impact on nutrient cycling would depend on whether the pruned branches are removed from the orchard, burnt in place, or chopped and left on the soil surface, as in recommended organic farming practices. Information on nutrient contents of wood and on external recycling is needed to make complete analyses.

V. CARBON ACCUMULATION

Carbon accumulation is the net result of assimilation of CO_2 from the atmosphere by photosynthesis and subsequent dissimilation of part of that by respiration. The remainder is retained as the major component of biomass. Leaves are the dominant organs of assimilation in olive, while all living tissues respire. Fruit play a minor role in assimilation but have high respiration rates consistent with their intense metabolic activity in lipid synthesis (*see* Section VI D). Respiration provides energy in appropriate forms (e.g., ATP, NADH) for all metabolic processes ranging from

maintaining integrity of membranes, transport and interconversions of nutrients, through to providing the energy for the construction of new organs. While there is no single chemistry of respiration (release of CO_2), it is useful to consider it in two components. The first is maintenance respiration (MR) that provides the energy that sustains existing organs and the second, constructional respiration (CR) that provides the energy to build the complex chemical compounds of new tissues. Maintenance respiration is expressed as CO_2 release per unit tissue mass per unit time and shows a major response to temperature, essentially doubling for each 10°C rise in temperature. In contrast, CR is expressed as CO_2 release per unit of growth, so although the underlying metabolic processes respond to temperature, CR depends upon the amount and nature of the new growth. For example, polymerization of sugar to starch or cellulose requires less energy than the construction of proteins or fats. This gives rise to the notion of glucose requirement of growth ($\text{GR} = \text{g glucose g}^{-1}$ dry matter produced or maintained) that can be calculated from chemical composition (Penning de Vries et al. 1974) or elemental analysis (McDermitt and Loomis 1981). Merino (1987) used these methods to compare the cost of growing and maintaining leaves of a range of Mediterranean species. Olive, with GR for growth = $1.66 \text{ g glucose g}^{-1}$ dry matter (d.m.), was greater than the mean for tree species (1.54), while GR (assessed at 20°C) for maintenance = $0.0136 \text{ g glucose g}^{-1}$ d.m. day^{-1} was very close to the mean (0.0138).

A. Leaf Photosynthesis

Photosynthesis (A) in olive proceeds by the C_3 pathway (Bongi et al. 1987b) and, in common with many other shrub and tree species, achieves a lower maximum rate (A_{max}) at higher saturating photon flux density (800 to $1000 \mu\text{mol m}^{-2} \text{s}^{-1}$) (Bongi and Long 1987; Bongi and Loreto 1989; Bongi and Palliotti 1994; Proietti and Palliotti 1997) with a smaller quantum efficiency (ϕ) and higher internal $[\text{CO}_2]$ under optimal conditions and ambient $[\text{CO}_2]$ (ca. $350 \mu\text{mol mol}^{-1}$) than herbaceous C_3 (crop) species.

The highest A_{max} of $22 \mu\text{mol CO}_2 \text{ m}^{-2} \text{ s}^{-1}$ was recorded for 'Coratina' grown outdoors in pots (Angelopoulos et al. 1996). Other studies also report reasonably high rates, e.g., $19 \mu\text{mol CO}_2 \text{ m}^{-2} \text{ s}^{-1}$ in an 18-year-old orchard of 'Picual' (Moriana et al. 2002), $18 \mu\text{mol CO}_2 \text{ m}^{-2} \text{ s}^{-1}$ in mature 'Picual' (Giménez et al. 1997), 15 to $16 \mu\text{mol CO}_2 \text{ m}^{-2} \text{ s}^{-1}$ for 'Koroneiki' and 'Amphissis' (Chartzoulakis et al. 2002), $14 \mu\text{mol CO}_2 \text{ m}^{-2} \text{ s}^{-1}$ for 'Frantoio' and 'Maurino' (Proietti and Palliotti 1997), 'Kalamon' (Giorio et al. 1999), and 'Mastoidis' (Chartzoulakis et al. 1999). These results

contrast with much smaller A_{\max} recorded in other studies, when plants were grown in artificial environments or at low irradiance. High irradiance is required for complete development of leaf anatomy and carboxylation capacity for photosynthesis. Thus, A_{\max} was $7.7 \mu\text{mol CO}_2 \text{ m}^{-2} \text{ s}^{-1}$ for 'Rajo' (Bongi and Long 1987) and $5.4 \mu\text{mol CO}_2 \text{ m}^{-2} \text{ s}^{-1}$ for 'Manzanilla', 'Dolce Agogia', 'Coratina', and 'Leccino' (Bongi et al. 1987a) in controlled environments. Given the variability in A_{\max} that has been recorded in various published studies, it is only possible to make effective comparisons between cultivars when they are grown together under optimal conditions and measured with the same equipment. One example is that of Chartzoulakis et al. (2002), who established differences in A_{\max} ($p < 0.05$) among five cultivars, viz. 'Koroneiki' 15.6, 'Mastoides' and 'Amphissis' 14.5, 'Kothreiki' and 'Megaritiki' 13.5, and 'Kalamata' $10.4 \mu\text{mol CO}_2 \text{ m}^{-2} \text{ s}^{-1}$, respectively. A second (Loreto et al. 2003), working with 1-year-old potted plants, established extreme differences ranging from $17 \mu\text{mol CO}_2 \text{ m}^{-2} \text{ s}^{-1}$ for 'Kerkiras' to $4 \mu\text{mol CO}_2 \text{ m}^{-2} \text{ s}^{-1}$ for 'Chalkidikis'. Others were intermediate, with 'Valanolia' at 7.5 and 'Throubolia', 'Adramitini' and 'Agouromanaki' at $6 \mu\text{mol CO}_2 \text{ m}^{-2} \text{ s}^{-1}$. Such intraspecific variations in A_{\max} are greater than those found in most crop plants, suggesting the existence of cultivars with low A_{\max} but always with concern over the effect of growing environment. Not surprisingly, all major cultivars have relatively high A_{\max} values.

Quantum efficiency is the ratio (mol mol^{-1}) of photosynthesis to absorbed PAR at low irradiance because under that condition, with other factors optimal, $[\text{CO}_2]$ does not limit photosynthesis. Two papers from Bongi and collaborators offer conflicting estimates of ϕ . The value of 0.026 reported by Bongi and Long (1987) for 'Rajo' seems more consistent with developing views of olive photosynthesis, restricted as it is by substantial inactive absorption of PAR in the sclerophyllous leaves and a possibly inefficient photochemistry. The matter does require further experimental evaluation, however, because the above value conflicts with a value of 0.052 reported for 'Coratina', 'Manzanilla', 'Dolce Agogia', and 'Leccino' (Bongi et al. 1987a) that would make olive comparable with herbaceous C_3 crop species (Ehleringer and Pearcy 1993).

The ratio of CO_2 concentration within the leaf to that outside (C_i/C_a) reflects the relative magnitude of gaseous conductance from atmosphere to leaf spaces relative to the total pathway from atmosphere to the sites of fixation within the chloroplast where $[\text{CO}_2]$ approaches zero. High values of C_i/C_a indicate that low internal (liquid phase) conductance is a significant limitation to photosynthesis. In olive, recorded values of C_i/C_a at high A_{\max} generally exceed 0.75 (Bongi and Long 1987; Bongi et al. 1987a; Bongi and Loreto 1989; Proietti and Palliotti 1997; Minnocci et al.

1999), values common to C_3 species. In physiological experiments, measurements of the relationship between A and C_i are also used to examine the relative limitations imposed by stomata, internal conductance of CO_2 transfer, and carboxylation under various experimental conditions.

The explanation of these photosynthetic characteristics of olive is found in three major features of the anatomy and morphology of the leaf. First, the anatomical basis of the low conductance to gaseous flow across the leaf surface was described earlier. Second, the internal anatomy, with closely packed chlorenchyma, provides little space for gaseous diffusion inside the mesophyll. A stereological analysis that assessed the extent of packing in 'Ascolana' calculated an internal cell wall conductance to CO_2 transport of $0.11 \text{ mol m}^{-2} \text{ s}^{-1}$ that is one quarter of the corresponding value for wheat (Bongi et al. 1987b). The interplay of leaf surface and internal conductances explains the high C_i/C_a ratio that characterizes olive photosynthesis. Whereas low wall conductance is an effective mechanism to reduce loss of internal water under severe stress, it always limits photosynthesis by restricting the supply of CO_2 to the sites of fixation. Third, the tightly packed mesophyll, together with the additional structural tissue that together provide the rigid sclerophyllous leaves characteristic of olive, result in low chlorophyll and N content (see Table 4.2) and therefore more inactive absorption of PAR than occurs in herbaceous (crop) C_3 species. Inactive adsorption and low internal conductance explain the low A_{max} and the high PAR needed to achieve it. Internal PAR absorption also explains why olive leaves have greater photosynthesis when illuminated at low irradiance from both sides. Proietti and Palliotti (1997), working with 'Frantoio', proposed light compensation points of 30 and 50 $\mu\text{mol m}^{-2} \text{ s}^{-1}$ for leaves irradiated on both, or only on the upper surface, respectively. These responses have significance within olive canopies where the proportion of reflected PAR increases with depth. Illumination from both sides decreases the light compensation point, i.e., the threshold irradiance for positive net photosynthesis.

The effect of peltate trichomes, especially common on the lower surfaces of olive leaves, on photosynthesis is controversial. Theory would propose a reduction in photosynthesis resulting from greater reflectivity. Consistent with this, Grammatikopoulos et al. (1994) report an increase of 11% (76 to 84%) in PAR absorptance following trichome removal in an unspecified cultivar, not all of which would be actively absorbed by chlorophyll within the leaf. On this basis, one would expect a small increase in A at low irradiance gradually diminishing as irradiance approaches saturation. This may explain why comparisons of A between

leaves with and without trichomes (Grammatikopoulos et al. 1994; Proietti and Palliotti 1997) have revealed no differences. Those comparisons were mostly made at high irradiance when responses should not be expected. Further, the wide range of measurements, with confidence levels at around 25% of the means, prevented detection of small differences in the few measurements taken at low irradiance (Proietti and Palliotti 1997).

Changes in the external environment, or internal factors that affect the photosynthetic system of the leaf, will reduce A below A_{\max} . Photosynthesis can be reduced by stomatal closure, decreased internal transport of CO_2 to the sites of fixation, and/or by reduced carboxylation. The effects may be transitory, as can be seen in diurnal patterns of photosynthesis that recover from day to day. If they are persistent, however, they may be of great importance because olive leaves usually remain on trees for two years or more and can maintain a stable photosynthetic capacity until the final stages of senescence (Bongi et al. 1987a). The most important factors that affect photosynthesis in the field are irradiance, temperature, and water status. Others of significance are salinity and photo-inhibition, and of increasing interest, atmospheric pollutants, UV-B radiation, and $[\text{CO}_2]$.

1. Effects of Temperature. The optimum temperature for net photosynthesis (A) is around 28°C (Bongi et al. 1987a; Chartzoulakis et al. 2002), with high rates maintained in the range of 20°C to over 30°C . In this temperature range, g_i is maintained high and respiration rates are small relative to assimilation. Bongi et al. (1987a) compared A of four cultivars, chosen to represent distinct thermal zones of olive production in the Mediterranean region ('Manzanilla'—warm Spanish area, 'Dolce Agogia'—cold Italian area, 'Coratina'—medium-warm Italian area, and 'Leccino'—medium-warm area), in response to temperatures of 10, 20, 30 and 40°C . The optimum temperature was around 28°C for all cultivars, but with differences at the extremes. While all cultivars displayed a similar and major reduction of A at 10°C (to 10% of maximum) and significant A at 40°C (>50% of maximum), 'Manzanilla' maintained highest A at 40°C (80% of maximum). While the performance of 'Manzanilla' at high temperature is consistent with its region of origin, the complete characterization of temperature responses must include assessing acclimation to low and high temperatures when grown in the field. The role of acclimation in olive must be critical, given the wide range of temperatures experienced seasonally by this crop within the various environments where it is grown.

2. Effects of Water Deficit. Many papers have dealt with the reduction of A under and following water stress (Xiloyannis et al. 1988; Angelopoulos et al. 1996; Giménez et al. 1997; Giorio et al. 1999; Nogués and Baker 2000; Moriana et al. 2002). Taken together, these studies show that A is significantly reduced by water deficit and that stomatal closure plays a major role. There are, however, non-stomatal effects that may persist after prolonged water shortage.

Moriana et al. (2002) provided a comprehensive analysis of measurements taken on irrigated and droughted trees over the summer-autumn period in an 18-year-old orchard of 'Picual' at Córdoba, Spain. Midday xylem water potential (ψ_x , measured as ψ_1 of covered leaves) in rain-fed trees fell to -8.0 MPa and VPD reached 7 kPa. For all measurements at saturating irradiance and $\psi_x > -4.5$ MPa, A at $350 \mu\text{mol CO}_2 \text{ mol}^{-1}$ was linearly related to g_i . At lower ψ_x , there was clear evidence of non-stomatal limitation. A similar conclusion was drawn by Angelopoulos et al. (1996) whose data, on 2-year-old potted plants of 'Coratina' grown outdoors (Fig. 4.4), display a two-part relationship between maximum A and g_i . Stressed plants had $A < 5 \mu\text{mol CO}_2 \text{ m}^{-2} \text{ s}^{-1}$ and did not conform to the general linear relationship but displayed smaller A than controls at equivalent g_i . The diurnal patterns of A under water deficit also follow closely those reported by Moriana et al. (2002). As stress intensified, maximum A was observed earlier in the morning and the

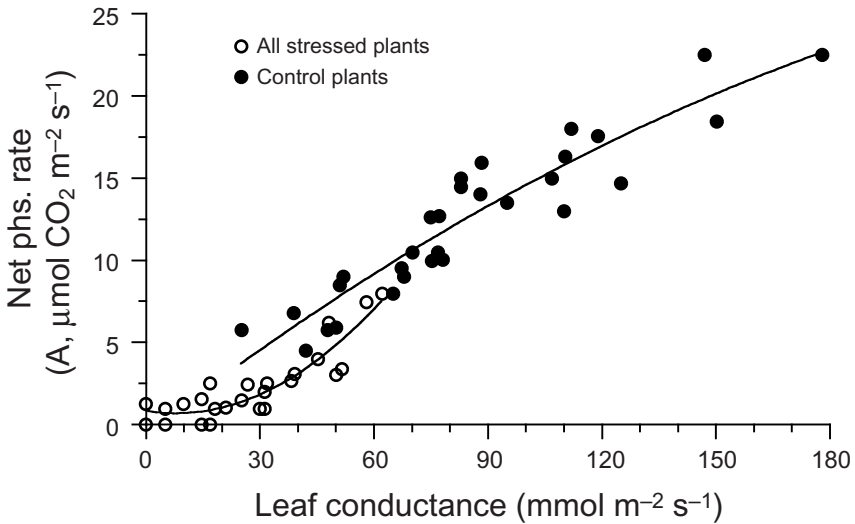

Fig. 4.4. Relationships between net photosynthetic rate (A) and leaf conductance (g_i , $\text{mmol m}^{-2} \text{ s}^{-1}$) for control and water-stressed olive trees (Angelopoulos et al. 1996).

rate at midday gradually decreased. Contrary to the variability in A among cultivars in response to salinity (see below), there is no evidence of intraspecific variation in the response of A to water deficits.

3. Effects of Salinity. Accumulation of salt in leaves reduces A at concentrations below those at which visual symptoms are evident, and well below those that cause leaf drop. Salt is carried from roots to leaves in the transpiration stream so that plants have decreasing salt concentration from old to young leaves. This explains why effects on A and visual symptoms appear first in old leaves. Thus, Bongi and Loreto (1989), in experiments with 3-year-old plants of 'Rajo', exposed to external NaCl concentration of 250 mM in hydroponics for up to 90 days, recorded leaf salt profiles from apex to base of 46 to 90 mM at 25 days and from 75 to 990 mM at 90 days compared with controls exposed to 35 mM salt. Leaf photosynthesis was reduced by 18%, leaf growth ceased, and there was 50% leaf drop when tissue salt exceeded 80 mM. Salt reduced A by decreasing g_i , decreased internal conductance (smaller g_w), and caused effects at the photosynthetic sites (Bongi et al. 1987a; Tattini et al. 1997; Centritto et al. 2003; Loreto et al. 2003). The smaller internal conductance results from leaf thickening and greater water content. Measurements of chlorophyll fluorescence revealed irreversible damage at salt levels exceeding 200 mM.

Differential responses of A between cultivars to external salinity can derive from exclusion/sequestration of salt by the roots as well as by ability to sustain A in response to increasing leaf salt concentration. Both responses have been established in olive. Tattini et al. (1997) concluded that the effect of internal salt (250 mM) was greater in 'Frantoio' than in 'Leccino', with threshold values for 50% reduction of A at 146 and 275 mM, respectively, in the two cultivars. This conclusion is, however, dominated by a couple of data points (their Fig. 5) and the true difference may be much smaller. In contrast, A in young leaves was reduced by 60% by 200 mM salt in 'Koroneiki', 'Mastoides', and 'Amphissis', by 40% in 'Kothreiki' and 'Megaritiki', and by 20% in 'Kalamata' (Chartzoulakis et al. 2002). No difference was detected, however, in the relationship between A and leaf tissue salt concentration, so the differences in tolerance between these cultivars must derive from exclusion/sequestration of salt at the root level. Certainly, 'Kalamata', the least affected cultivar, maintained the lowest leaf salt concentration across the range of external salt and showed no visual symptoms over the 5-month period of treatment. It is significant that cultivars with the smallest A and g_i under control conditions, 'Kalamata' in this study and 'Chalkidikis' in that of Loreto et al. (2003), were also least affected by salt.

The most interesting feature of these experiments is that the response of A does not coincide with current views on the relative salt tolerance of olive cultivars based on growth and performance data as reviewed by Gucci and Tattini (1997) (see Section VII C). 'Frantoio' is considered more salt tolerant than 'Leccino', but A of 'Frantoio' appears the more sensitive to internal salt. Smaller g_1 and transpiration could certainly contribute to restricting salt load but, as with 'Kalamata', the major component of salt tolerance likely resides in the ability of the root system to exclude salt from the xylem flow. 'Kalamata' was not recorded as salt tolerant (Gucci and Tattini 1997) but 'Megakaritiki' that was also showed major reduction in A in the experiments reported above (Chartzoulakis et al. 2002).

4. Photo-inhibition. Any stress that reduces the ability of leaves to dissipate excitation energy through photosynthetic reduction of carbon dioxide increases the excess energy in the leaf and the potential for damage to the light reactions of photosynthesis and the development of reducing power. Photo-inhibition is most likely at high irradiance and may have long-lasting effects on photosynthetic performance. Photo-inhibition is potentially important in olive when photosynthesis is limited by high temperature and water shortage in summer and by low temperature in winter (Pavel and Fereres 1998). Photo-inhibition can be detected when photosynthesis is not maintained at fixed conditions of irradiance, $[\text{CO}_2]$, leaf temperature, and g_1 . It can also be detected by measuring chlorophyll content, quantum efficiency (ϕ), and by evaluating the condition of photo-system II (PSII) in chloroplasts by measuring leaf fluorescence. Two studies reveal aspects of these responses in olive.

Bongi and Long (1987) studied the effect of low and high temperature on non-stomatal responses of photosynthesis of potted plants in controlled environments. Attached leaves of 'Rajo' were exposed to 5°C for up to 12 hr at low ($95 \mu\text{mol m}^{-2} \text{s}^{-1}$) and high ($1850 \mu\text{mol}^{-2} \text{s}^{-1}$) irradiance and VPD = 0.4 kPa and then allowed to recover for 24 hr under low irradiance ($95 \mu\text{mol}^{-2} \text{s}^{-1}$) at 26°C. Treatment in low and high irradiance reduced both ϕ and A_{max} by 10 and 50%, respectively. Non-stomatal effects were responsible for half of the effect on A_{max} . Leaves that had been treated for 12 hr in low irradiance recovered photosynthesis completely within a few hours but those treated at high irradiance did not. Leaves that were recovering from chilling at high irradiance had far more damage when chilled a second time. When entire plants were chilled, the effects on individual leaves were more severe. Treatment of individual leaves at 38°C for up to 7 hr in low irradiance produced no significant effect on ϕ when returned to 26°C. In contrast, leaves sub-

jected to 38°C at high irradiance suffered reductions in ϕ of 25% after 1 hr and 75% after 3 hr. In both cases, however, recovery was complete after 3 to 5 hr in low irradiance at 26°C.

Angelopoulos et al. (1996) studied potted plants ('Coratina') subjected to various watering regimes outdoors during the summer. Analysis of A vs. g_1 revealed the existence of non-stomatal limitations in stressed plants that were confirmed by measurements of chlorophyll fluorescence. Both well-watered and stressed plants had greatest A in the morning. Rates fell during the morning, especially rapidly in stressed plants. All leaves had increasing fluorescence during the day, and while the control plants recovered in the evening, the stressed plants did not. These non-stomatal effects were, therefore, both transient and persistent. Perhaps we find here the reason for low A_{\max} measured in some experiments. For example, Giorio et al. (1999) made measurements at 2000 $\mu\text{mol m}^{-2} \text{s}^{-1}$, well above that (800 to 1000 $\mu\text{mol m}^{-2} \text{s}^{-1}$) required for saturation.

Protection against photo-inhibition caused by excess excitation energy may be achieved directly in the chlorophyll carotenoid-binding antennae complex of photosystem II leading to smaller ϕ . In a comparison with *Eucalyptus globulus*, *Quercus suber* and *Q. ilex*, olive (cultivar not specified), with the smallest A , also displayed the greatest concentration of carotenoid pigments, and these increased during the summer (Faria et al. 1998). The high levels of carotenoids and the seasonal variation are consistent with adaptation in olive to low A , allowing diversion of excess excitation energy into the electron transport chain to match the consumption of its products with supply from the Calvin cycle. In this way, the danger of photo-inhibition may be minimized.

5. Atmospheric Changes. Measurements have also been reported of the effect of increasing levels of CO_2 , UV-B radiation, and industrial pollution (O_3 and SO_2) on photosynthesis in olive.

Carbon Dioxide (CO_2). Increasing $[\text{CO}_2]$ to double current levels of ca. 350 $\mu\text{mol mol}^{-1}$ will increase leaf photosynthesis for the same transpiration rate, and therefore increase transpiration efficiency (TE), unless there is an accompanying reduction in g_1 . Leaf conductance (g_1) responds to changes in stomatal morphology (i.e., density and size) and such responses to increasing $[\text{CO}_2]$ have been measured among a range of species, with differences also established between cultivars. For olive, Tognetti et al. (2001, 2002) have measured leaf photosynthetic characteristics in 'Frantoio' and 'Moraiolo' after 7 months' exposure to 560 and 360 $\mu\text{mol CO}_2 \text{mol}^{-1}$. For both cultivars, A_{\max} increased, stomatal density and g_1 decreased, but C_i/C_a remained constant, all in response to

higher $[CO_2]$. This C_i/C_a ratio reveals that increased carboxylation capacity was offset by reduced gaseous diffusion, but the net effect was a major increase in TE. The two cultivars responded differently. A_{max} increased more in 'Moriaolo' than in 'Frantoio' (44 vs. 31%) but reductions in stomatal density were similar in both cultivars (-11 vs. -9%) and both cultivars had similar decreases in g_1 (-31%). The net result of changes to photosynthesis and transpiration was a greater response in TE by 'Frantoio' than in 'Moriaolo' (94 vs. 73%). Tognetti et al. (2001) also reported that A_{max} of both cultivars increased to $31 \mu\text{mol m}^{-2} \text{s}^{-1}$ at $C_i = 1000 \mu\text{mol CO}_2 \text{ mol}^{-1}$ for plants acclimated at both 360 and 550 $\mu\text{mol mol}^{-1}$. This provides an interesting comparison with the measurements of A_{max} under current ambient conditions reported previously, and also suggests that down regulation of A_{max} , reported for many species following exposure to high CO_2 , either does not occur in olive or would occur only after a longer period of exposure. The long life of olive leaves, 2 to 3 years, is likely critical to such acclimation.

These large differences of A_{max} at the leaf level are not expected to translate to similar differences in growth and productivity because processes at higher levels of organization in the plant play further determining roles.

UV-B Radiation. A number of studies conclude that olive is unlikely to be affected by UV-B radiation that increases with depletion of stratospheric ozone (Karabourniotis et al. 1992; Liakoura et al. 1999; Nogués and Baker 2000). These studies covered a range of cultivars and up to four times the current levels of UV-B radiation ($6 \text{ kJ m}^{-2} \text{ d}^{-1}$) experienced in the Mediterranean Region. Nogués and Baker (2000) recorded reduced A at high UV-B due to stomatal closure, while other observations (Karabourniotis et al. 1992; Liakoura et al. 1999) revealed significant protection from the UV-B absorbing capacity of the peltate layers (60% at 310 nm for 'Koroneiki'). Other work has recorded stomatal effects on A_{max} and, in the case of de-haired leaves, persistent damage to exposed epidermal and guard cells (Grammatikopoulos et al. 1994). That work was, however, performed at a very high UV-B (5.9 W m^{-2}) and although applied only during the measurement of photosynthesis at $PAR = 900 \mu\text{mol m}^{-2} \text{ s}^{-1}$ may not, therefore, be relevant to current concerns about environmental effects of increasing UV-B radiation.

Ozone (O_3) and Sulphur Dioxide (SO_2). Ozone is a major atmospheric pollutant in the Mediterranean Basin where significant concentrations in the range of 70 to 100 vppb have been recorded for several consecutive

months, including large areas away from pollution sources (Vitagliano et al. 1999). These gases are able to enter leaves, be absorbed by the liquid phase, and interfere with metabolism. Photosynthesis can be reduced by both stomatal and non-stomatal effects and can occur before visual symptoms are evident. There is evidence of significant effects on photosynthetic productivity in local areas.

Similar effects have been reported with O_3 by Minnocci et al. (1999) and Sebastiani (2002). Six-year old potted plants of 'Frantoio' and 'Moraiolo' were exposed daily to 3, 50, and 100 vppb O_3 for 5 hr over a period of 18 months. A_{max} of newly developed leaves was reduced in both cultivars but more markedly in 'Frantoio' (reductions to 35 and 24% of control of $16 \mu\text{mol CO}_2 \text{ m}^{-2} \text{ s}^{-1}$ at 50 and 100 vppb, respectively) than in 'Moraiolo' (comparable values 35 and 69% of $13 \mu\text{mol CO}_2 \text{ m}^{-2} \text{ s}^{-1}$). The effect in both cultivars was mediated entirely by reduction in mesophyll photosynthetic capacity, except for 'Moraiolo' at 50 ppb, which also experienced reduced leaf conductance (g_l). The recovery of A_{max} in 'Moraiolo' at 100 ppb was a consequence of greater g_l .

In the case of SO_2 , 'Frantoio' and 'Moraiolo' were subjected to five months exposure to SO_2 at up to 100 ppb (Giorgelli et al. 1994). No visual symptoms were recorded in either cultivar, but they did have different anatomical and physiological responses. In 'Frantoio', A_{max} decreased by 38% at 100 vppb but was unaffected in 'Moraiolo'. Leaf thickness decreased significantly in both cultivars, by a maximum of 15 and 9%, respectively, in 'Frantoio' and 'Moraiolo'. There was also a reduction in stomatal density and size that was slightly greater in 'Frantoio' than in 'Moraiolo'.

B. Interception of Radiation

The extensive results on leaf photosynthesis contrast with the little information available on the photosynthetic performance of tree canopies or entire orchards. Such work, combined with measurements of the efflux of CO_2 from the soil, is critical to understanding the role of physiological responses at leaf and lower levels of organization that underlie the environmental adaptation and productivity of olive. Measurements of the CO_2 balance of individual trees can be made within transparent chambers, and of entire orchards by meteorological techniques that establish the flux of CO_2 into the canopy. Efflux of CO_2 from the soil (respiration of root and soil) can be collected in various ways. Models of canopy photosynthesis then offer the best opportunity to synthesize these data and assess the importance of cultivar, weather, and

management on productivity. The first step in productivity analysis, however, is to assess the interception of radiation.

In olive orchards, individual trees usually have separated canopies, widely in traditional orchards to manage water demand, and more closely in modern high-density orchards to provide space between rows for the entry of machinery for management operations. The important consideration is the balance between the total amount of radiation intercepted that determines growth, and its distribution within the canopy that determines flowering and the formation and filling of fruit. This horizontally non-homogeneous distribution of foliage in olive orchards contrasts with that of most field crops for which simple descriptions of canopy structure (leaf area index, LAI, and extinction coefficient, k) are generally adequate for the analysis and management of radiation and energy exchanges. The canopies of olive orchards are more appropriately defined by combinations of tree spacing (row and inter-row, m), tree height (m), row orientation (degrees N), vertical projection of canopy cover (CC), and canopy volume ($m^3 \text{ ha}^{-1}$). Villalobos et al. (1995) have shown how many of these parameters can be measured non-destructively by analysis of light interception in isolated olive trees and orchards using the gap-inversion method. At low canopy cover, trees intercept more incident radiation per unit leaf area than field crops of lower stature, and consequently shade more of the soil surface than herbaceous crops, except at high solar angles. This behavior is especially pronounced for evergreen trees in the temperate latitudes, where solar angles are low for several months of the year.

The relationship between interception of radiation and canopy structure varies throughout the year depending upon solar position and cloudiness (i.e., the proportions of direct and diffuse radiation). Existing approaches used in interception models for forest and orchard canopies have been recently extended to olive. Mariscal et al. (2000a) have developed a model of the interception of photosynthetically active radiation (PAR) and its distribution within the canopies of olive orchards. The geometrical analysis has separate treatments of the passage of direct and diffuse radiation through tree canopies of defined tree spacing, row orientation, canopy height, canopy volume, leaf area density, leaf angle distributions, and leaf optical properties. The model is appropriate for the calculation of tree or orchard photosynthesis and could also be useful in the analysis of flower survival, fruit survival, fruit filling, and fruit color. On the other hand, for many practical applications, interception is readily measured with linear PAR sensors and, in this, olive orchards have the advantage that canopy structure does not change rapidly.

C. Tree and Canopy Photosynthesis

There are no published data on direct measurement of photosynthesis of olive trees or orchard canopies. Information is required not just on total canopy photosynthesis but also on the distribution of activity throughout the canopy. The latter should contribute significantly to understanding flowering, fruit set, and fruit filling, as well as devising improved strategies and timings of pruning. The lack of such measurements is a major restriction to the development of models of olive productivity. Current attempts at modeling (*see* Section VIII) have been developed using net growth in response to intercepted radiation (RUE). This approach avoids the issue of assimilate balance (photosynthesis and respiration separately) that is central to understanding source-sink activities in the partitioning of biomass—an important part of growth strategy and adaptation of the perennial olive.

With the data available at present, it is only possible to make rough estimates of orchard photosynthesis, in the absence of stress, using quantum efficiency (ϕ) as introduced in Section VA. If one assumes, for example, that the average conversion efficiency of intercepted radiation is one half of ϕ to account for reflection and the relatively high irradiance received by many leaves in the canopy, then the product of PAR \times effective crop cover $\times \phi/2$ will estimate orchard photosynthesis. Thus for an orchard of full cover (CC = 1), daily gross photosynthesis with incoming short wave radiation of 20 MJ m^{-2} would be $20 \text{ MJ m}^{-2} \times 2.06 \text{ (mol quanta MJ}^{-1}) \times 0.026/2 \text{ (mol CO}_2 \text{ mol quanta}^{-1}) = 0.54 \text{ mol CO}_2 \text{ m}^{-2}$, corresponding, with a respiratory loss of 30%, to a net photosynthetic gain of $16.6 \text{ g CO}_2 \text{ m}^{-2}$. This, converted to estimate biomass gain of ca. 13.1 g m^{-2} , including an ash content of 8%, would estimate radiation-use efficiency (RUE) of 1.31 g MJ^{-1} (PAR) comparable with the value of 1.35 that Mariscal et al. (2000b) measured experimentally.

VI. BIOMASS PARTITIONING AND REALIZATION OF YIELD

Plant organs, roots, stems, leaves, and fruits can be considered as a group of connected sources and sinks, whose seasonal patterns of supply and demand determine the partitioning of assimilates among them, and hence the survival, growth, and yield of the entire plant. A simple view sees leaves as the major source of assimilates and all other organs as sinks, but a more complex description of plant assimilate relationships is required because many organs can serve as both sources and

sinks. Sink strength is determined by size and by two components of activity. First, assimilate to support general metabolism (MR) and second, for growth of existing and new organs (CR). The development of new organs, leaf and shoot units, flowers, roots, and fruits that appear in response to external and internal signals are of particular importance here. The flow of assimilates from sources to sinks is determined by proximity and anatomical connectedness. In the event of inadequate supply for all maintenance and growth activities, sinks will compete for assimilate, with variable effects on plant production and survival.

The supply and demand for assimilates in plants also responds to plant hormones, and in this, N plays an important role. Roots export NO_3^- to leaves where it is reduced to the amino level at substantial energetic cost. This growth strategy reduces the energy cost of root systems that receive metabolites by return flow through the phloem. It is known, in many plants, that when NO_3^- levels are high, roots also export cytokinins, plant hormones that stimulate cell division and growth. Alternatively, when NO_3^- levels are low, xylem sap is more concentrated in abscisic acids, hormones that restrict cell division, cause stomatal closure (Zhang and Davis 1990; Peuke et al. 1994), and increase leaf abscission in olive cuttings (Kitsaki et al. 1999). Because NO_3^- moves in the transpiration stream, its quantity and composition signal the shoot of both water supply and fertility available from roots. Herein lays the theory behind partial root zone drying (PRD) that is being applied with variable success to vines (Dry and Loveys 1999; Dry et al. 2000), but has not, as yet, been evaluated in olive. By alternating irrigation on opposite sides of the root zone, the notion is to develop root signals to close stomata, control growth, and reduce overall water demand, without exposing the plant to severe water stress. In practice, the ability to achieve alternate wetting and drying depends upon rainfall patterns and importantly soil water-holding capacity, being more effective in soils of light texture. It now appears, however, that irrigation water deficits imposed in this fashion have the same effects on growth, water relations, and productivity as those produced when the same quantity of water is applied with conventional deficit irrigation practices (Fererres et al. 2003). The advantage of double irrigation lines may reside in a larger wetted zone and a more extensive root system that may be of value in arid areas with marginal soils (*see* Section III A).

Two questions arise from the above description of assimilate relationships within plants. First, how much of this behavior is known for olive? Second, does current knowledge support the validity of this source-sink approach to its assimilate relationships and growth? There is little information to answer the first question, so the second question

cannot be answered. The only structured study is that of Priestley (1977), who studied the monthly growth and assimilate profiles in leaves, stems, and roots of 3-year-old potted plants of 'Ascolana' for one yearly cycle. That study demonstrated aspects of the coordination of growth and also that chemical techniques are available to distinguish the assimilate content of organs from their biomass (Proietti et al. 1999b). Growth was most rapid in summer and took place in all organs concurrently. There were no signs of alternating growth among organs. The data also describe the seasonal variability of assimilate in the various organs, showing, for example, the importance of leaves in storing as well as producing assimilate. Even in these young plants, total non-structural carbohydrates accounted for 50% of dry weight in mature leaves compared with 40% in stems and 10% in roots.

A paucity of information on assimilate relationships is not unusual, even to well-studied annual crops. In the case of olive, we have much information on assimilation by individual leaves and on the productivity of olive fruit (mass and oil), but little else. There are even few static descriptions of the distribution of biomass between organs, let alone on the factors that control partitioning of assimilates among organs. There is evidence of competition for assimilates during flowering and fruit growth (Rallo and Suarez 1989), and the same probably applies to more general interactions between canopy, trunk, and root system.

A. Movement of Assimilates from Leaves

Measurements of phloem exudates reveal that assimilates are translocated from olive leaves mainly as raffinose oligosaccharides (50%, predominantly stachyose) and sucrose (30%), with mannitol comprising a small proportion (<10%) (Flora and Matore 1993; Gucci et al. 1998b). This contrasts with the sugar composition of leaf tissue in which mannitol forms the major component (30%), followed by glucose (18%), sucrose (8%), and various oligosaccharide precursors (galactose, raffinose, verbascose). Pulse chase experiments with C^{14} reveal the location and sequence of the interconversions. Mannitol and sucrose are formed rapidly (2 min) from the primary assimilate, glucose, in the mesophyll close to site of C fixation. Mannitol is synthesized in the cytosol from mannose-6-P and quickly localized in cell vacuoles. In contrast, stachyose (sucrose+galactose+galactose) and raffinose (sucrose+galactose) appear later (10 min), consistent with synthesis closer to the point of phloem loading, probably in the intermediary cells associated with minor vein endings (Flora and Matore 1993). This transport-synthesis sequence for the major translocates may explain why Gucci and Minchin

(2002) reported slow translocation of C^{11} label in their observations of in situ translocation from olive leaves. Mannitol has been shown to increase in concentration in leaves of plants subjected to salinity stress as well as water stress (Gucci et al. 1998a; Gucci et al. 1998b), but the role of mannitol as an intermediate store of assimilate and the adaptive significance, if any, of the dominance of assimilate transport as stachyose in olive remain unclear.

Other important aspects of assimilate relations relate to linkages between organs. There is some information on this from labeling and defoliation experiments. Studies of the movement of isotopically labeled (C^{11}) assimilate from leaves along an actively growing olive shoot, cultivar unspecified (Gucci and Minchin 2002), revealed that assimilate movement depended on leaf age. In this case there was no export within 2 hr from the youngest expanded leaf but assimilate flowed in both directions; the older the leaf position, the more assimilate moved out of the stem. This pattern has been seen in many plants. Other important features, not shown here, and so far not confirmed for olive, are that young expanding leaves may be importers and exporters at the same time, and that once expanded, old leaves do not become importers, even when they enter a period of negative carbon balance due to shading or senescence. In defoliation and shading experiments, Proietti and Tombesi (1996) have further inferred the effective isolation of branches, to the tertiary level, in terms of vegetative growth, and limited transfer from closely associated branches for fruit growth. Sub-units of the tree canopy act more or less independently to support their own growth, including that of fruit, while maintaining active xylem and phloem connections with the root system via the subtending stems and branches. A tree may then be considered, from the standpoint of carbon utilization, as a collection of branches loosely connected and operating individually. The implications of this notion to attempts to extrapolate measurements at the leaf level up to the canopy are obvious. Virtually nothing is known of the long-distance relationships that determine the contribution of assimilate to trunks and roots.

B. Above- and Below-Ground Biomass

Growth and partitioning of biomass were studied during the first two years of two fully irrigated high-density 'Picual' orchards, 5000 and 20,000 trees ha^{-1} , at Córdoba (Mariscal et al. 2000b). There was a large response of total growth to tree density. Competition among trees was evident in summer of the second year (from day 500) as divergences in stem diameter and plant leaf area between the two densities. There was, how-

ever, a strong linear relationship between the biomass of the organs in all cases. The young olive trees partitioned 0.26 of total biomass to roots and of the remainder (0.74) that remained in shoots, 60% was in wood and 40% in leaves. As competition increased in the second year, biomass partitioned to wood (trunk, branches, and stems) increased to 70%. Other data on root-shoot partitioning of olive orchards provide comparable data and also describe the impact of water shortage on partitioning. Dichio et al. (2002) reported measurements on 'Coratina' for 8 years after planting at 6 × 6 m spacing. Up to year 5, shoots retained a steady proportion of total biomass, 0.76 and 0.69 for irrigated and rain-fed treatments, respectively. Towards year 8, partitioning to roots increased, so that shoots then represented a smaller proportion, 0.58 and 0.55, of total biomass. Water shortage reduced overall growth, 33 vs. 19 t ha⁻¹ for irrigated and rain-fed treatments, respectively, but the effect was seen more in the stem and canopy than in the root system. This response is common to most plants and is an advantageous adaptation that establishes a more favorable water balance under drought conditions.

An important issue in considerations of the partition of biomass between organs concerns the energetic cost of dry matter production that was seen earlier (Section V) in the explanation of the glucose requirement (GR) for growth. Leaves, stems, and fruits of olive have markedly different chemical constitution and therefore have different assimilate costs of production. In their study of biomass production and partition in young orchards of 'Picual', Mariscal et al. (2000b) estimated GR = 1.49 (cf. 1.66 by Merino 1987), 1.43, and 1.54 for leaves, fine branches and trunk, respectively. The value for fruit varies depending upon composition, especially oil content for which GR = 3.11. For oil cultivars, GR of fruit is 2.3, for an estimated composition of oil = 50%, sugar = 10%, lignin = 27%, protein = 9%, and minerals = 2% (Hermoso et al. 1998; Jordão and Lietão 1990).

C. Shoots and Fruit

The seasonal distribution of biomass within a fruit-bearing limb ("on" year) of 8-year-old trees of 'Picual', studied by Rallo and Suarez (1989), displayed the growth and interactions of the component organs. The presence of fruit greatly reduced concurrent vegetative growth relative to the "off" condition, by 50 and 40% for new nodes and new leaf area, respectively. The major proportion of new biomass was directed to the fruit. Accounting for a 50% reduction in the biomass of the previous year's leaves, 85% of new biomass from PS65 to PS79 was in fruit, with the rest in new leaves (10%) and shoots (5%). The previously existing

shoot did not increase in biomass. Those data reflect an even greater diversion of current assimilate to fruit.

Competition between shoot and fruit during “on” years is also an important determinant of yield in the following year, because shoot growth provides the sites for flower formation. The role of assimilate supply for floral induction, a process that occurs during fruit growth, is uncertain. Both leaves and fruit are involved in the internal signals that influence the process, but the distinction between assimilate supply and other exports from leaves has not been satisfactorily resolved. The experiments of Proietti and Tombesi (1996), for example, revealed a dramatic effect of defoliation and intense shading on return to flowering as well as on current fruit growth. Given the relative isolation of shoots with regard to assimilate (Proietti and Tombesi 1996), however, it seems highly likely that the treatments imposed on assimilate supply were too severe for a proper conclusion.

The irregular distribution of fruit in the canopy and its importance to tree productivity and management have long been recognized (Ortega Nieto 1945). Fruit are formed preferentially on the more-illuminated parts of canopies, the top and southern sides in the northern hemisphere. Pruning practice, well illustrated in the widely used open-vase form, is directed to improve light penetration to promote more fruiting sites. Surprisingly, though, there has been little research on the role of assimilate in the sequential steps from floral initiation to fruit filling.

Acebedo et al. (2002) studied flower and fruit dynamics in 6×6 m, 16-year-old ca. N-S planted orchards, of two widely planted cultivars at Mengibar, Spain. ‘Picual’ forms a relatively open canopy and usually sets one large fruit per inflorescence, while ‘Arbequina’ is shrubby, more dense, and sets small, multiple fruit. The authors followed the fate of flowers on the previous year’s shoots formed at five positions around the periphery (top, N, S, E, W at 1.5 m height), low (L) on the south side at 0.4 m, and within the canopy (I) adjacent to it. They established differences in behavior between locations that became increasingly pronounced in the sequence, inflorescence number, fruit number, and fruit weight per shoot (Fig. 4.5). Both cultivars showed the dominance of top and exposed locations in fruit yield and oil percentage. The major difference between cultivars was in fruit number, which did not translate into more fruit weight per shoot. This sequence suggests the increasing importance of assimilate supply on fruit filling and oil content. It should now be possible to combine measurements of orchard illumination patterns and models of canopy photosynthesis to the study of this issue, and importantly, extend the analysis to new orchard designs distinct from those developed by traditional practice over centuries.

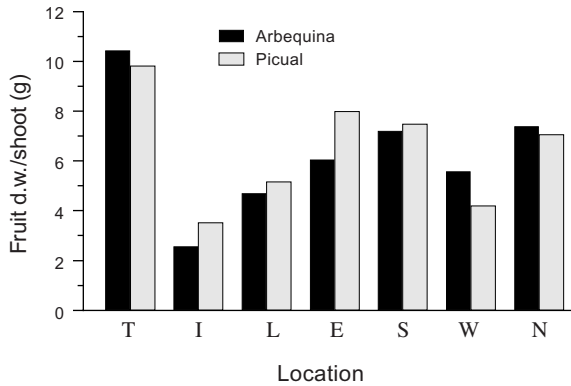

Fig. 4.5. Influence of position in canopy on number of inflorescences, number of fruit, and fruit weight per shoot in 'Picual' and 'Arbequina' (Acebedo et al. 2002). The locations are on the periphery of the canopy at top (T), on east (E), west (W), south (S), and north (N) sides at 1.5 m height, and low (L) at 0.4 m on south side. The location within the canopy (I) is adjacent to L.

D. Assimilate Supply and Oil Formation

There are two sources, relative sizes unknown (and probably variable), of assimilate for fruit growth in olive. The major source is certainly the sugars translocated in the phloem from leaves or sites of storage. These were seen previously to comprise raffinose oligosaccharides (mainly stachyose) and sucrose. The secondary source is sugars formed by photosynthesis in fruit themselves that remain green for a considerable period and retain active chlorophyll even when they change color (PS81) as they approach maturity. While chlorophyll is mostly in the exocarp, the mesocarp has been shown to contain significant amounts of phosphoenol pyruvate carboxylase (Sánchez 1994), the CO_2 -fixation enzyme of the CAM and C_4 photosynthetic pathways. This means that fruit can continuously sequester respiratory CO_2 in the mesocarp and release it to enter the Calvin Cycle (C_3) photosynthesis during the light, along with any free CO_2 in the tissue at that time. This internal CO_2 is generated by the intense metabolism related, initially with the cell division and growth, and later, and for a considerable period, to the synthesis of oil. On this point, it seems that seed and mesocarp behave differently with respect to assimilate supply. Seed growth depends exclusively on assimilate imported by the phloem, while isotopic label was recovered only from the mesocarp when photosynthesizing fruit were exposed to C^{14}O_2 at 21 weeks after full bloom (Sánchez 1994).

Observations confirm that fruit photosynthesis makes a positive contribution to mesocarp growth, even though the CO_2 balance of fruit is apparently negative from the outset. Comparisons of CO_2 exchange in light and dark (Proietti et al. 1999a) reveal that young fruit in full sunlight are able to fix up to 80% of respired CO_2 , the proportion falling gradually to zero towards maturity as chlorophyll is lost. The provision of CO_2 for photosynthesis was considerable, with internal C_i always $>400 \mu\text{mol mol}^{-1}$ and rising to $800 \mu\text{mol mol}^{-1}$ during the second half of the fruit-filling period when the conductance of the exocarp fell as stomata were lost and cuticular wax thickened. The available CO_2 -balance data do not, however, allow an estimate of the overall contribution that re-fixation makes to mesocarp growth over the seasonal cycle. If re-fixation reduces the dependence of fruit growth on current assimilation rate to a significant extent, that may help explain why fruit load had no apparent effect on leaf photosynthetic rate (Proietti 2000), a source-sink feedback that has been observed in many crop plants.

The sugar content of young mesocarp is high, around 20% dry matter, but falls steadily as the mesocarp accumulates oil. The synthesis and formation of these storage lipids (triacylglycerols, TAG) is complex, requiring many steps, essentially common to all plants (Browse and Somerville 1991), that occur in various cellular compartments. Aerobic respiration of sugars provides acetyl CoA and malonyl CoA the primer and building blocks, respectively, for the stepwise elongation of the fatty acid chain. This process involves a multi-enzyme fatty acid synthase (FAS) complex and a low molecular weight acyl-carrier protein that sequentially adds 2-C units up to the saturated 16-C stage (C16:0, palmitic). Further elongation with some desaturation, not controlled by FAS, continues, with the majority terminating at the 18-C stage in olive. The storage triacylglycerols (TAG) are then formed by sequential acylation of glycerol-3-phosphate and desaturation steps that determine the fatty acid profile of the fruit (and cultivar). Oil bodies are formed by accumulation of TAG within leaflets of the endoplasmic reticulum.

Oil formation commences around pit hardening (PS75), about 2 months after full bloom (PS65), and persists for 100+ days. The oil concentration in the seed increases quickly and reaches a maximum well before ripening begins (PS81) but continues in the mesocarp even after this time. The pattern of accumulation varies greatly, including between oil cultivars. Garcia and Mancha (1992) presented a comparison of lipid synthesis capabilities of 'Picual' and 'Gordal', measured by the incorporation of ^{14}C -labelled acetate in slices of mesocarp tissue. The activity in 'Picual', an oil cultivar, was three times greater, peaked later, and persisted longer than in 'Gordal', a table cultivar. A comparison of oil

accumulation in the six cultivars—‘Carolea’, ‘Maurino’, ‘Leccino’, ‘Frantoio’, ‘Moraiolo’ and ‘Dolce Agogia’—was presented by Farinelli et al. (2002) (Table 4.3, Fig. 4.6). Oil formation commenced first in ‘Carolea’ (41 days after full bloom), with the other cultivars following about 20 days later. ‘Leccino’ and ‘Moraiolo’ had the longest oil-filling period of 172 days but the seasonal patterns varied considerably. ‘Carolea’ had the greatest relative rate of 21.5 mg oil (g fruit)⁻¹ day⁻¹ and ‘Maurino’ and ‘Moraiolo’ the least at 9.5 mg oil (g fruit)⁻¹ day⁻¹. Compared to the variability in these production patterns, the data also reveal relative consistency in oil content and composition among cultivars, compared with the variability of polyphenol content, as discussed above.

Table 4.3. Fruit and oil characteristics of six olive cultivars.

Characteristics	Carolea	Dulce Agogia	Frantoio	Leccino	Maurino	Moraiolo
Fruit						
Fruit dry mass (g)	2.0	0.8	1.1	1.3	0.9	1.0
Fruit volume (cm ³)	4.8	1.9	2.2	3.0	1.9	1.9
Pulp/stone ratio (DW)	2.7	1.6	1.5	1.3	1.6	1.9
Final oil content pulp (%DW)	77.3	75.9	77.0	84.6	79.7	78.1
Final oil content fruit (%DW)	56.1	44.7	45.8	47.6	49.2	51.1
Oil						
Palmitic (% of oil)	12.5	11.6	12.2	12.9	14.9	12.2
Stearic (% of oil)	2.0	1.8	1.8	1.7	1.3	1.6
Oleic (% of oil)	75.5	77.3	77.1	76.4	73.4	75.0
Linoleic (% of oil)	5.7	6.0	6.4	5.2	7.0	7.3
Polyphenol (ppm of oil mass)	647	438	874	756	295	501

Source: Farinelli et al. (2002).

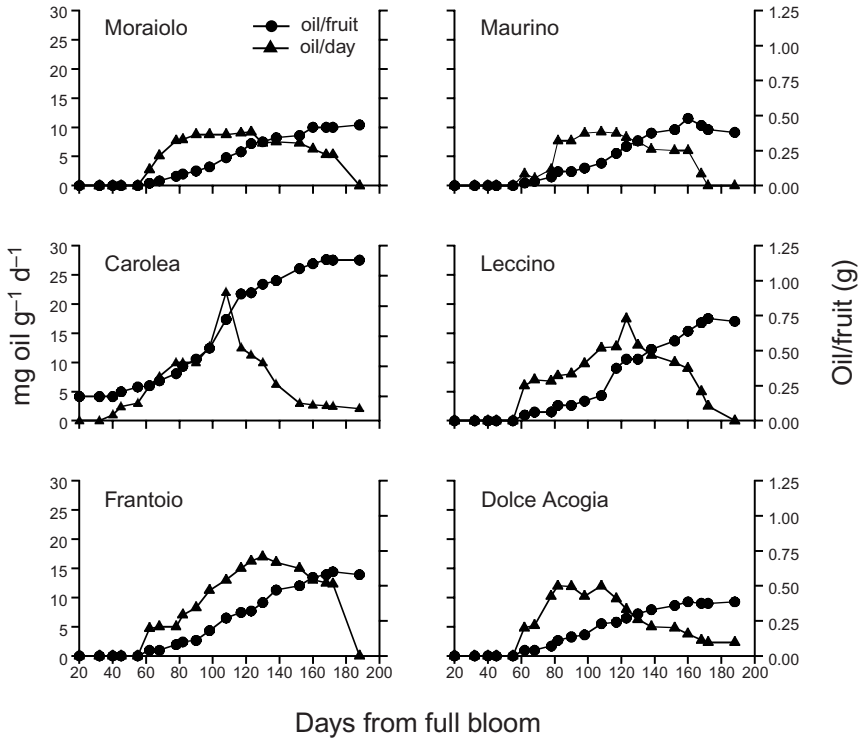

Fig. 4.6. Oil accumulation in the fruit (g) and specific accumulation rate ($\text{mg oil g}^{-1} \text{d}^{-1}$) according to fruit dry weight for six olive cultivars (Farinelli et al. 2002).

Hermoso et al. (1998) provide a general description of the composition of oil cultivars. Total fruit weight comprises 70 to 90% mesocarp, 9 to 27% endocarp, and 2 to 3% seed. At the usual harvest time for oil production, mesocarp has about 60% water, 30% oil, 4% sugars, 3% protein, and the rest primarily fibre and ash. The endocarp has 10% water, 30% cellulose, 40% other carbohydrates, and about 1% oil. The seed has 30% water, 27% oil, 27% carbohydrates, and 10% protein.

Two features endow a human dietary advantage to olive oil. First, the mono-unsaturated oleic acid (C18:1) which exists in high proportions, up to 80%, has strong hypocholesterolemic properties and is considered to reduce the risk of coronary diseases. Other acids, present in smaller amounts, are the saturated palmitic (C16:0, 10 to 15%) and stearic (C18:0, 2 to 3%), and the polyunsaturated linoleic (C18:2, 5 to 10%) (Tombesi 1994). Linoleic acid also has hypocholesterolemic properties and is as an essential fatty acid, i.e., is required but is not synthesized

by human metabolism. Second, a range of antioxidant phenolic compounds, especially in virgin oil, are active in reducing the incidence of bowel and breast cancer (Owen et al. 2000; Visioli et al. 2002). Other constituents important in the marketplace are flavor (organoleptic) compounds that are produced enzymatically in the mesocarp and transferred to the oil during extraction by pressing. The types and amounts of oils and organoleptics have a strong genetic base and are, therefore, characteristic of individual cultivars, but are also under environmental control. Uceda and Hermoso (1998) report a comparison of oil and organoleptic properties of 30 cultivars, harvested over five years. Cultivar explained 78, 71, and 46% of the variation in the contents of oleic acid, tocopherols, and polyphenols, respectively.

VII. STRESS PHYSIOLOGY

The ability of olive to survive and yield in marginal areas is based on resistance to environmental stresses of drought, low temperature, and salinity. Water stress is common in Mediterranean environments and olive has long been considered a tree adapted "*par excellence*" to water deficit. The importance of low temperature has increased as production has moved to higher latitudes and higher altitudes within the present zone of distribution. Salinity is a common problem in soils of arid and coastal environments and is becoming more important in olive production as the search to increase productivity by irrigation is challenged by water of low quality.

Resistance to stress is usefully considered with components of escape, avoidance, and tolerance (Loomis and Connor 1992). The first, escape, derives from development patterns that allow plants to complete life cycles without stress in potentially stressful environments. In contrast, avoidance and tolerance derive from physiological attributes. Avoidance mechanisms maintain high internal water or low salt in the face of stress; when these mechanisms fail or are insufficient, stress resistance depends upon tolerance to adverse internal conditions.

From a strategic viewpoint, it is interesting to compare the success of olive with that of winter cereals, the major productive option for rain-fed agriculture in the Mediterranean environment. For these annual cereals, success in this environment is primarily achieved by rapid phenological development (drought escape) combined with aspects of drought avoidance (Loomis and Connor 1991). For perennial, evergreen olive, in contrast, success depends upon a broad combination of avoidance and tolerance attributes.

A. Drought

Olive culture has prospered under rain-fed conditions in Mediterranean environments because the tree is capable of acceptable yield while subjected to the characteristic prolonged summer water shortage (drought). Olive achieves this result with physiological and morphological responses that reduce water loss and maintain water uptake at high plant water status as drought commences (drought avoidance), with others that maintain turgor and tolerate dehydration at low plant water status as the drought deepens (drought tolerance). In general terms, drought avoidance combines low leaf conductance, low leaf area, minimizing radiation load, deep roots, high root length density, and high hydraulic conductance. Olive maintains turgor by osmotic adjustment of cell contents, small cell size, and changes in cell wall elasticity. Olive also tolerates dehydration by other properties of protoplasm and cell wall. For productivity, rain-fed olive must tolerate summer drought and recover quickly to fill fruit in autumn. The success of this strategy is aided by conservative water use in spring that in turn minimizes the extent and intensity of the ensuing summer drought.

1. Leaf Water Relations. Olive leaf tissue has the ability to tolerate and recover from low ψ_1 (<-8 MPa) (Xiloyannis et al. 1988; Moriana et al. 2003) that would kill most annual and perennial crop plants. Olive leaves reduce radiation load by adopting a more vertical angle (Natali et al. 1999) and also maintain turgor and functionality at low ψ_1 by osmotic adjustment. The latter response is further aided under dehydration by high tissue elasticity (Bosabalidis and Kofidis 2002). A study of the relation between relative water content and ψ_1 (moisture release curves) of leaf tissue of 'Picual' (E. Fereres, unpubl.) revealed significant osmotic adjustment (ca. 1 MPa) when soil water deficit lowered predawn ψ_1 from -1 to -4 MPa. These moisture release curves exhibited a large change in ψ_1 per unit hydration change, indicative of relatively rigid cell walls that confer the advantage of sustaining low ψ_1 with moderate dehydration (Kramer and Boyer 1995). The combination of the capacity of olive to lower ψ_1 below -8 MPa and an extensive root system enhances capacity to withstand drought by increasing the volume of extractable soil water. Moriana et al. (2003) estimated that rain-fed trees with ψ_1 around -8 MPa extracted an additional 40 mm from below the conventional permanent wilting point of -1.5 MPa in a 240-cm deep profile. This is a significant additional contribution that corresponds to 10 to 15% of the seasonal ET of a traditional rain-fed orchard in that area (Orgaz and Fereres 1998).

The diurnal pattern of leaf conductance and photosynthesis of olive follows, contrary to that observed in most crop plants, the optimization theory of stomatal operation in relation to water use proposed by Cowan (1982). When the tree is subjected to water deficit, this behavior becomes even more firmly established. Transpiration efficiency (TE) is maximized, as stress develops, because stomata open (greatest diurnal g_i) earlier each day, when VPD is lowest, and remain open for shorter periods. Transpiration efficiency was four times greater in the early morning than at midday (Moriana et al. 2002). While it is well established that severe water stress decreases TE in many plants due to direct effects on the photosynthetic apparatus (Brodribb 1996), the response of olive is uncertain. For example, there was no effect of water stress on TE of severely stressed olive until ψ_1 fell below -4.4 MPa (Moriana et al. 2002) and Larcher et al. (1981) found that TE increased (relative to control) in potted olive trees when re-hydrated following cycles of water stress. Comparable behavior that would hold great adaptive significance has not been established in the field, although TE that had decreased under severe water deficit returned to normal values immediately after the first autumn rain (Moriana et al. 2002).

Taken together, these observations on stomatal response point to efficient capture of carbon by olive leaves at low water cost, even when trees are subjected to substantial water deficit. It remains to be seen if these leaf-level responses to stress translate to favorable responses to water deficit at tree and orchard levels. If such observations confirm the curvilinear relationship found between yield and ET in olive (Patumi et al. 2002; Moriana et al. 2003) that defines greater water productivity below maximum ET, they would lend theoretical support to the value of deficit irrigation in this crop, a practice already used extensively in areas of limited water supply.

2. Xylem Cavitation and Vulnerability to Embolisms. Water is transported in the xylem under tension and is therefore vulnerable under drought (low ψ_1) to cavitation and the rapid expansion of a gas-filled space (embolism) within individual xylem conduits. Cavitation may be initiated during water stress by the entry of air through conduit pit membranes when xylem tension exceeds a critical level, or by bubbles formed during freezing and thawing of xylem sap. Cavitation has been demonstrated in water-stressed plants by acoustic techniques (Milburn and Johnson 1966; Tyree and Sperry 1989) and measured by changes in hydraulic conductivity of excised stem or root sections before and after pressurization with degassed water to remove embolisms (Sperry et al. 1988; Tyree et al. 1995; Lo Gullo et al. 1998).

Embolisms are important because they reduce the hydraulic conductivity of the xylem, giving rise to the possibility of “runaway” reduction in hydraulic conductance unless transpiration is reduced to relieve tension and prevent further cavitation (Tyree and Ewers 1991). Stems harvested from trees usually have a degree of embolism and Tyree and Sperry (1988) have estimated an ability to accommodate a 5 to 20% loss of hydraulic conductance without danger of approaching an unstable state. Adaptations to minimize the number of cavitations are found in the small diameter of conduits and the ability of pit membranes to prevent expansion of embolisms into neighboring conduits. Adaptations to minimize the effect of embolisms on xylem hydraulic conductivity are found in short conduits and the generally complex pathway of water flow (Sperry 2003). Optimization of xylem structure thus requires a balanced adaptation because the features that reduce vulnerability to cavitation, narrow conduits, and many inter-conduit connections also result in the low hydraulic conductivity that generates the high xylem tensions that trigger cavitation. Of particular importance here is the fourth power relationship (Poiseuille’s Law) between conduit diameter and hydraulic conductance. To maintain equivalent xylem hydraulic conductivity, the aggregate area of vessel conduits must increase dramatically as the diameter of individual conduits decreases.

Until recently, embolisms were thought to be largely irreversible (Sperry 1995) and thus cavitation was considered a serious xylem dysfunction in plants, whose repair in woody species must then generally await the formation of new water-filled xylem vessels around the expanding periphery. That process is undoubtedly important but it now appears that embolisms can be repaired (Salleo et al. 1996; Hacke and Sperry 2003) and that xylem hydraulic conductance may consequently vary from day to day, or even diurnally. There is also the suggestion that the hydraulic shock from individual embolisms may play a role in regulating stomatal conductance (Salleo et al. 2000) and that the release of water may contribute significantly to the capacitance of the xylem tissue (Meinzer et al. 2001).

Some of this work on drought response and adaptation has been undertaken on sclerophylls of the Mediterranean region (Lo Gullo et al. 1998; Martínez-Vilalta et al. 2002). Lo Gullo et al. (1998) measured the response of root hydraulic conductivity of potted seedlings of wild olive (*O. oleaster*) to water stress and subsequent watering. They recorded significant decreases in hydraulic conductivity that were only recoverable following short, mild stress. Observations on root anatomy revealed loss of roots and also changes to root anatomy. A thicker, more suberized

endodermis decreased conductivity from soil into the stele, the least conductive part of the transport pathway in the root. Given these morphological and anatomical changes, complete recovery of root conductivity was achieved only following the growth of new roots. A study of the hydraulic properties and vulnerability to cavitation of nine woody species of an evergreen oak forest in Catalonia, Spain, included *Phillyrea latifoli*, Oleaceae (Martínez-Vilalta et al. 2002). It established a common trade-off across species and their component tissues between hydraulic conductivity and xylem security. The latter, expressing the resistance to cavitation, was parameterized as the water potential causing a 50% decrease in hydraulic conductivity per unit conducting area (specific conductivity). Xylem security increased with decreasing conduit diameter (d) according to relationship $1/d^2$. According to this criterion, roots of the studied species operated closer to their hydraulic limit for cavitation than did stems. This characteristic has also been reported for other species and potentially holds important clues for evolution of xylem tissues, ecological adaptation of species, and the mechanisms by which embolisms can be repaired. As yet, there have been neither observations nor analyses on cavitation responses in olive. This could now be a priority area for research, given the low water potentials that the tree sustains and the unanswered questions concerning stomatal responses.

3. Flowering and Fruit Filling. Compared to the water relations of leaves of droughted plants, there is relatively little information on the drought responses of the reproductive processes from flowering through fruit growth to oil accumulation.

Olive flowers are late compared with winter cereals adapted to the Mediterranean climate. This late-Spring flowering behavior is consistent with the subtropical origin of the plant (Section II) and presents a compromise between the risk of damage by cold and by water deficit. While it significantly decreases the risk of flowering to low temperature, it increases the risk of damage to flowering by water and/or high temperature stress, and also delays fruit growth into an extended period of water shortage. There exists a wide range of flowering responses (Barranco et al. 1994), as yet incompletely understood (Section II C), that is the basis for adaptation of cultivars to individual sites.

Observations in drought years suggest the possible loss of most flowers or fruits when water deficits develop, a response that enhances the alternate bearing habit. Thus, while there is very little doubt that flowering and fruit set are very sensitive to water deficits (Moriana et al. 2003), there is an urgent need for studies to uncover the degree of

sensitivity, the potential for adaptation to stress, and the possibility of differential responses among cultivars, especially as olive cultivation extends into drier environments.

The nature and pattern of fruit growth is important to adaptation to drought and also to the effectiveness of various irrigation strategies. Olive does not follow the classical pattern of cell division and expansion described for drupes (Bollard 1970). Recent work has shown that cell division and cell expansion are both active in the mesocarp at 8 to 10 weeks after full bloom when expansion of the endocarp is virtually complete (PS75) (Rallo and Rapoport 2001). From then until maturity, considerable cell expansion occurs and up to 40% of mesocarp cells may be produced, depending on cultivar (Manrique et al. 1999). The timing as well as the extent of stress, therefore, determine the effect on cell number and cell size. Rapoport et al. (2004) studied the effect of water shortage during the first 4 to 9 weeks after full bloom (PS65) on fruit growth of 3-year-old potted plants of 'Leccino'. Predawn ψ_1 fell to -3.1 MPa in the stress treatment compared to -0.8 MPa in the control. Measurements taken at 6, 8, and 22 weeks after full bloom were taken to assess the impact of water stress and recovery of fruit characteristics. Mesocarp cell size (area) was reduced to 40% of the control by the end of the stress period (week 8) and recovered to 65% by week 22. In contrast, mesocarp cell number was unaffected during the treatment period and division continued comparable with the control during recovery when ca. 15% of final cell number was produced. The major effect of drought was seen in the endocarp. By the end of the stress period (week 8), it had achieved 90% of final growth in the control but only 40% under stress. Thus by week 8, fruit fresh weight (1.13 vs. 2.25 g) and volume (1.6 vs. 2.6 cc) were substantially reduced compared to the control, and recovery remained incomplete to week 22 (PS81). At that time, the dry weight and oil contents of the mesocarp were unaffected by the early stress (mean values 25 and 46%). In general, the reported effects in the literature of drought and irrigation practice on oil proportion and quality have been variable (see Patumi et al. 2002) and this is not surprising considering the range of cultivar, stress level, timing, and duration involved as well as the range of parameters needed to define oil quality.

Olive growers commonly express surprise at the capacity of the tree to recover from prolonged summer drought to produce reasonable yields. It is likely that the ability of olive to recover from water deficit is its most important feature of drought response. Thus, in a 1983 experiment at Cordoba (E. Fereres, unpubl.), trees of 'Picual' re-hydrated within three days from a predawn ψ_1 of -4 MPa to reach normal g_1 in less than two weeks. Further observations at Cordoba in 1995 when an unusual drought low-

ered ψ_l to -8.0 MPa in some trees are summarized in Fig. 4.7. Despite the initial low ψ_l , trees reached control values and were fully re-hydrated within six days of 60 mM of rain received over two days in early November (Fig. 4.7a). The recovery of g_l was much slower, as seen in many species (Hsiao 1973). Leaf conductance increased after the rain but remained below control values for about two weeks. Interestingly, there was much tree-to-tree variation in g_l and those trees that had a heavy fruit load also had high g_l , in some cases as high as in control trees (Fig. 4.7b). It appears that functional recovery, and presumably carbon assimilation, was faster in trees with a heavy fruit load, leading to a recovery in fruit

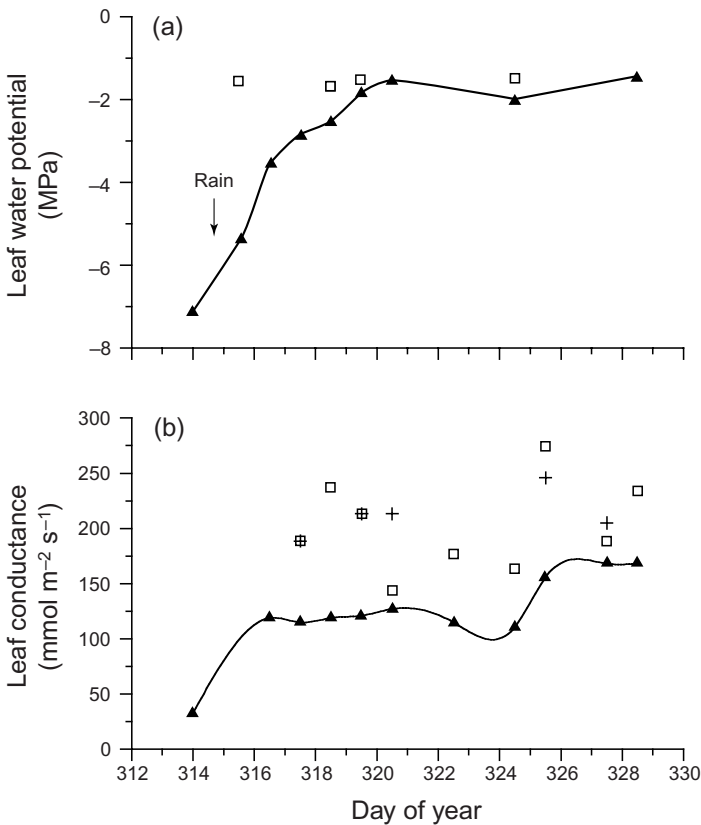

Fig. 4.7. Evolution of (a) leaf water potential (ψ_l) and (b) leaf conductance (g_l) in rain-fed olive trees after 60 mm rainfall in November 1995, following a prolonged drought at Córdoba, Spain. The open squares record the corresponding values of ψ_l and g_l for control trees that were irrigated and the crosses, g_l of rain-fed trees that carried a heavy fruit load (E. Fereres, C. Ruz, and A. Soriano, unpubl.).

growth and yield. Moriana et al. (2003) showed that oil accumulation is slowed or perhaps stopped by summer drought, but resumes in the stressed treatments in autumn at a faster rate than in fully irrigated trees.

B. Low Temperature

Olive has good cold tolerance compared to other species that share its subtropical origins (Larcher 1987). Leaves and bark can withstand temperatures to -12°C or less, depending upon cultivar and duration, provided the tissues have been previously hardened by prolonged exposure to temperature in the range 0 to 5°C (Bartolozzi and Fontanazza 1999). Significant damage to aerial parts, mainly leaf drop and twig desiccation, that threaten survival and reduce productivity can, however, be expected at temperatures around -7°C (Palliotti and Bongi 1996). In susceptible areas, damage is greatest in late autumn and early winter, decreasing in severity for the same temperatures as the plants gradually harden. Young plants require hardening before planting in the field because they are especially susceptible to low temperature. In newly planted orchards, sensitive leaf and apex tissues are close to the ground where temperature is lowest during radiative frosts. In contrast to the substantial tolerance of bark and leaves, the reproductive organs, flower buds and flowers, are seriously damaged by temperatures around 0°C and there is no evidence of differential sensitivity between cultivars. Adaptation to individual sites depends upon suitable phenological development that delays flowering until after late spring frosts, because when flowering is substantially disrupted great, or total, yield loss is likely.

Field experience, for example after the 1985 and 1991 freezes in Italy (Roselli et al. 1989; Bartolozzi and Fontanazza 1999) and in experiments with young trees in controlled environments (Mancuso 1998, 2000), has enabled the classification of some cultivars with regard to cold tolerance (Table 4.4). The wide range of olive germplasm means, however, that evaluation is far from complete, so further understanding of

Table 4.4. Some established tolerances of olive cultivars to freezing temperatures.

Tolerance	Cultivars
High	Ascolana Tenera, Bouteillan, Nostrale di Rigale, Leccino, Leccino Uzzano, Borcionna, Madonna dell'Impruneta, Vocio, Morchiaio
Low	Frantoio, Coratina, Moraiolo

Source: Roselli et al. (1989); Bartolozzi and Fontanazza (1999); Mancuso (2000).

response mechanisms to freezing temperatures is required to improve selection for cold tolerance.

Studies with many plant species have shown that damage to tissues becomes irreversible when ice forms and disrupts membranes and organelles. Further, it is known that tolerance to deep cold depends upon the ability of tissue to supercool through metabolic adjustments that lower freezing point. Measurement of supercooling and tissue damage now form the basis of tests designed to compare the behavior of cultivars. The challenge remains to ensure that such tests correlate well with field performance. Alternative screening techniques rely on correlations. For example, Roselli et al. (1989) have reported that low stomatal density correlated well with cold hardiness in cultivars that experienced the severe freeze ($<-20^{\circ}\text{C}$) in Tuscany in 1985.

Measurements of freezing tolerance on leaves are made by sampling stem segments to detect ionic leakage (leaf discs give unstable results), and on bark and leaves by measurements of differential thermal analysis and of electrical conductivity during cooling (Bartolozzi and Fontanazza 1999; Mancuso 2000). Ion leakage identifies that freezing has occurred, while differential thermal analysis and electrical conductivity identify membrane disruption. Mancuso (2000) showed that measurements of freezing temperature made by electrical conductivity satisfactorily discriminated between two cold-tolerant, 'Ascolana' (-14.5°C), 'Leccino' (-12.9°C), and two cold-sensitive, 'Frantoio' (-12.3°C), 'Coratina' (-11.8°C), cultivars. That study also revealed that the sensitivity of tissues was in the order roots $>$ leaves $>$ shoots $>$ vegetative buds. The sensitivity of roots is understandable because they do not experience low temperatures that characterize the aerial environment and therefore do not harden. The tolerance of vegetative buds contrasts with the sensitivity of floral buds and flowers.

Water stress improves the ability of olive to super cool and therefore to tolerate freezing, presumably by concentrating the aqueous phase of the cell solution. Certainly, Palliotti and Bongi (1996) showed that the increased tolerance they recorded in cold-sensitive 'Frantoio' to treatment with mefluidide, a plant growth regulator, was associated with a decrease in leaf relative water content. Perhaps this relationship reveals a further adaptive advantage of the leaf water shortage that olive experiences in winter despite high soil moisture content and low evaporative demand. Pavel and Fereres (1998), working with 'Picual', showed that leaf water stress in winter had its origin in low water uptake caused by decreased hydraulic conductivity of the root system. The cause, either physiological change in roots or some pattern of root senescence, has not been investigated.

C. Salinity

Salinity, either naturally occurring or induced by irrigation, is a major concern in many semi-arid areas to which olive is climatically adapted. The major salt concerned is NaCl, but SO_4^{2-} , HCO_3^- , and CO_3^{2-} ions may also be present. The salinity of the saturated soil extract and of irrigation water can be measured most easily by electrical conductivity (EC, dS m^{-1} at 25°C), or summarized chemically as total dissolved salts (g L^{-1}), but is most accurately described with details of particular ionic composition. As bench marks, EC of sea water falls in the range of 50 to 60 dS m^{-1} and 3 ML of irrigation water with $\text{EC} = 1 \text{ dS m}^{-1}$ adds 2 t salt.

Olive is considered moderately tolerant to salinity (Gucci and Tattini 1997) but, as in all higher plants, growth is negatively affected by salinity in three ways. First, there is an osmotic effect in the soil solution that restricts the availability of water, thus causing a water stress. Second, there are toxic effects of particular ions (most commonly Na^+ and Cl^-) when they accumulate within tissues. Third, there is the metabolic energy expended in exclusion of salt by roots and/or its sequestration within the plant. In these ways, salt has many effects on physiological processes, including water relations, photosynthesis, nutrition, biomass partitioning, and fruit quality.

The accumulation of salt modifies leaf anatomy with effects on water relations (Section III B) and photosynthesis (Section VA). Leaves become thicker and have greater water content. Bongi and Loreto (1989) recorded increases in palisade cell length and mesophyll thickness of 38 and 50%, respectively, for 'Rajo' plants exposed to 250 mM salt. Water relations are also affected and osmotic adjustment is enhanced. Exposure of 1-year-old plants of 'Frantoio' and 'Leccino' (Gucci et al. 1997) to 200 mM salt for 35 days reduced pre-dawn ψ_1 , ψ_π at full turgor, and ψ_π at the point of turgor loss. Inorganic ions (Na^+ , K^+) made the major contribution to lower ψ_π , but with significant contributions from glucose and mannitol. The two cultivars differed in their ability to accumulate inorganic ions but not carbohydrates. Net solute accumulation was greater in 'Leccino' than in the salt-tolerant 'Frantoio'.

Olive owes its tolerance to salinity to its ability to restrict transport to shoots, isolate Na in vacuoles, and maintain a high K/Na ratio to support tissue metabolism (*see also* Section VA), but a major component of its salinity tolerance actually resides in its ability to avoid salinity by restricting salt uptake by the roots. There is good evidence of variation in salt tolerance among cultivars of olive and Table 4.5 is constructed from experiments in which plant growth, and sometimes yield, have been used to evaluate relative tolerance to salt. An important point that has emerged during this review is that salt tolerance does not necessar-

Table 4.5. Some established tolerances of olive cultivars to salinity. Source: Gucci and Tattini (1997).

Tolerance	Cultivars
High	Megaritiki, Frantoio, Arbequina, Picual, Lechin de Sevilla, Chemlali
Low	Chondrolia, Chalkidikis, Leccino, Pajarero

ily imply the ability of individual physiological processes to withstand internal salt. Thus, it was shown that the salt-tolerant 'Frantoio' ceases photosynthesis at lower levels of leaf salt than does the salt-sensitive 'Leccino'. In this case, 'Frantoio' was successful by excluding salt rather than by tolerating it. As has been emphasized previously, the detailed physiological investigations on responses to salinity conducted at the leaf or at lower levels of organization have not been matched by studies leading to a complete assessment of the salinity tolerance of olive and of its responses to salinity under the relevant field conditions. Thus, we do not yet have information on yield reductions expected in olive plantations of the major cultivars from irrigating with saline waters.

D. Waterlogging

Although the roots of few plant species are able to tolerate anaerobic (lactate) respiration for considerable periods, most rely on a continuing supply of oxygen to sustain aerobic (Krebs Cycle) respiration to provide energy for metabolic processes associated with growth and nutrient uptake. Roots can acquire adequate oxygen directly from the air within drained soils or through specialized aerenchyma tissue that conducts air from shoots to roots in species (e.g., rice) that are adapted to waterlogged conditions. Olive, in common with most plants, is susceptible to waterlogging (Navarro and Parra 1998) and plantations are advisably located where inundation does not occur, or where raised tree lines or surface drains can shed water rapidly. Despite the well-known sensitivity of olive plantations to waterlogging, there have, however, been no studies on the anatomy and physiology of the response of olive to waterlogging or in search of differential adaptations between cultivars.

VIII. INTEGRATION OF RESPONSES

Two techniques are currently available to evaluate the interactions between component physiological responses of crops. The first considers responses of growth and yield in terms of resource-use efficiencies for radiation, water, and nitrogen. These efficiencies are the

quantities of biomass or yield per unit of radiation intercepted (RUE), water used (WUE), water transpired (TE), and nitrogen uptake (NUE). Biomass and yield can also be expressed in terms of glucose requirement to facilitate comparisons between organs of different chemical composition. The second is the construction of physiologically based simulation models of crop development, growth, partitioning, and yield in response to environment and management. There are many such models for herbaceous field crops (van Ittersum and Donatelli 2002) and some for perennial fruit crops also (e.g., DeJong and Goudriaan 1989; Grossman and DeJong 1994).

There are, as yet, few integrative studies for olive. Some work on leaf photosynthesis, referred to earlier, has been extended to evaluations of RUE (Mariscal et al. 2000b) and TE (Moriani et al. 2002), but nothing has been reported on NUE. In any event, that level of analysis is well removed from the functioning of entire trees, which should be an important focus for physiological research. There is now some work at the orchard level on the redistribution of rainfall intercepted by canopies (Gómez et al. 2001), interception of radiation (Villalobos et al. 1995; Mariscal et al. 2000a), transpiration and photosynthesis of trees (Diaz-Espejo et al. 2002), evapotranspiration (Bonachela et al. 1998; Villalobos 1999), and growth and partitioning of biomass (Villalobos 1999; Mariscal et al. 2000b). The complexities of working with tree crops must be acknowledged but so also must be the importance and utility of models as the only known means to integrate knowledge for practical application and as a guide for research effort.

For olive, system-thinking will be useful in identifying the major shortcomings in knowledge of root systems, the complexity of flowering response, the hydraulic architecture of trees, the photosynthesis of canopies, and the filling of fruit. Simulation modeling offers the only known opportunity to build frameworks of interacting processes to evaluate available information and to guide future research, but this research technique has hardly been applied to the study of olive (Villalobos 1999). To make significant progress, physiological research needs now to turn to more comprehensive studies of whole-tree and orchard systems and develop simulation models at various levels. It would probably be a great advantage if research in various places concentrated on a few cultivars, perhaps selected from those now being planted worldwide in new plantation methods. Such a modeling framework would provide a means to evaluate the relevance of currently available information and identify what new information is urgently required, and in what form.

IX. RECOMMENDATIONS FOR FUTURE RESEARCH

The following recommendations for future research are discussed under the headings of phenological development, and the balances of carbon, water, and nutrients that form the logic of simulation models.

A. Phenological Development

The internal mechanisms by which fruit load affects flowering behavior in the following year have received much attention. While this helps explain what occurs in the field, there has been relatively less effort to quantitatively define the role of environment on flowering and other aspects of phenological development. The substantial work on response to cold and temperature alternation has not been extended to the development of predictive models of phenological development such as exist for many field crops. An understanding of how the environment establishes signals for development could help untangle the present confusion about internal controls and provide a more secure way to seek appropriate cultivar-location combinations for new production environments.

B. Carbon Accumulation and Partitioning

Leaves are clearly the dominant organs of carbon acquisition and it is evident that studies of leaf photosynthesis dominate the physiological literature about olive. Despite the many studies of leaf gas exchange, studies on the C balance of entire trees that include photosynthesis, respiration, partitioning of biomass, and fruit filling are missing. The measurements on leaf photosynthesis, together with the start that has been made on the illumination patterns of orchard canopies, can provide inputs to studies (and models) of tree and orchard photosynthesis. Such studies are needed to understand the effect of canopy illumination on flower survival, fruit fall, and competition with shoot growth during fruit filling. There is little information on competition between leaf and shoot growth, nothing on the role of assimilate storage (C and N) in stems and roots in tree growth or survival, or the energy cost of the growth and maintenance of root systems. Studies are needed of the quantitative contribution that the olive fruit, which remains green for many months and has an internal supply of CO₂ from intense respiration, make to growth and oil formation and how this contribution can be maximized.

C. Water Relations

In common with studies on many trees, leaves have been the focus of evaluations of drought resistance in olive. Tree water balance, however, also has components of uptake and storage, and there is little information on olive at this level. There are a few, but contradictory, measurements of the extent of root systems but little on their seasonal dynamics and activity. Important questions relate to the uptake of water by root systems and the possibilities for internal redistribution. How does root growth and activity relate to the formation of new leaves, quantitatively and anatomically? How does the complex stomatal behavior influence the transpiration of canopies of different densities and arrangements? What is the quantitative relationship between leaf area and the sapwood that supports it? Are there preferential flow pathways within the tree? What are the relative contributions of sapwood, heartwood and canopy to diurnal and seasonal water status of the canopy?

D. Nutrient Balance

For centuries, olive has been produced in regions of marginal water supply where yield and hence extraction of nutrients have been small. Natural fertility, together with accessions of nutrients by rainfall and dust, have provided a continuing supply of nutrients for productivity. Recycling by leaf fall and heavy pruning also reduced nutrient export and thus deficits. However, adequate attention has not been paid to the question of whole crop nutrient balance that will become increasingly critical for the sustainability of new intensive production systems. This requires, as a first step, the construction of nutrient balance sheets for orchards, taking into account extraction by yield, internal and external cycling in nutrient withdrawal through litter fall, pruning, and cover crops, as well as losses by runoff erosion, and leaching. The contrast between the nutrient balances of high-intensity production systems, on the one hand, and the current development of organic production systems for olive, place these issues in sharp perspective.

X. CONCLUSION

This review reveals that literature on the physiology of olive has expanded greatly in recent years, providing much insight into the functioning and adaptation of the tree, but also that the distribution of effort has been uneven and has left important areas untouched. Areas of strong activity have been in photosynthesis and water relations of leaves,

pollination, fruit set, tolerance to salinity and freezing, and some micronutrient issues. Areas that have received little attention include environmental control over flowering together with the assimilate, water and nutrient balances of entire trees, including fruit and root systems, as they affect productivity and adaptation.

One noticeable feature of the literature is that a wide range of cultivars has been studied and yet few differences have been established between them at the physiological level. This can be explained by the genetic proximity that characterizes olive cultivars in response to vegetative propagation and longevity of the tree. Conflicts in the literature on relative freezing tolerance of cultivars, and to a lesser extent on salinity tolerance, are noteworthy. An exception may be in the terminal processes that determine oil quality. Cultivars are major determinants of quality, although that too is under, as yet incompletely understood, environmental control. Another feature is the amount of work that has been performed under conditions far removed from the field. There is a concentration of work on plants in pots in controlled environments that continues the emphasis on leaf physiology at the expense of whole-tree responses in the field. There is a real danger that the literature contains too many "exact answers to approximate problems." It will be a major challenge to assemble the totality of physiological responses that determines the climatic adaptation, growth, and yield responses of what are often large (and old and substantially manipulated) trees. Progress will require investment of effort more evenly across responses in realistic field environments if an adequate understanding of the processes that determine productivity and adaptability is to emerge.

In contrast to wheat and barley, the other long-standing crops of importance that evolved with it in the Mediterranean region, physiological understanding of olive remains influenced by folklore. That difference cannot be explained by its more complicated perennial growth habit alone. Perhaps part of the answer resides in globalization. Wheat and barley spread more quickly to other continents and cultures that have applied additional scientific skills to their study and development. Olive has remained a regional crop, but that too is changing. Perhaps we are now poised for more intense interest, scientific activity, and understanding of olive.

LITERATURE CITED

- Abdel-Rahman, A. A., and H. M. El-Sharkawi. 1974. Response of olive and almond orchards to partial irrigation under dry-farming practices in semi-arid regions. II. Plant-soil water relations in olive during the growing season. *Plant Soil* 41:13-31.

- Acebedo, M. M., M. L. Cañete, and J. Cuevas. 2002. Processes affecting fruit distribution and its quality in the canopy of olive trees. *Adv. Hort. Sci.* 14:169–175.
- Alcalá, A. R., and D. Barranco. 1992. Prediction of flowering time in olive for the Córdoba olive collection. *HortScience* 27:1205–1207.
- Allen, R. G., L. S. Pereira, D. Raes, and M. Smith. 1998. Crop evapotranspiration. Guidelines for computing crop water requirements. Irrigation and drainage paper 56. FAO, Rome.
- Angelopoulos, K., B. Dichio, and C. Xiloyannis. 1996. Inhibition of photosynthesis in olive trees (*Olea europaea* L.) during water stress and rewatering. *J. Expt. Bot.* 47:1093–1100.
- Anon. 2000. Catálogo mundial de variedades de olivo. Consejo Oleícola International, Madrid.
- Ayerza, R., and G. S. Sibbett. 2001. Thermal adaptability of olive (*Olea europaea* L.) to the Arid Chaco of Argentina. *Agr. Ecosyst. Environ.* 84:277–285.
- Barranco, D., C. C. de Toro, and H. F. Rapoport. 2002. Monopotassium phosphate (PO₄H₂K) for olive fruit abscission. *Acta Hort.* 586:263–266.
- Barranco, D., G. Milona, and L. Rallo. 1994. Flowering dates of olive cultivars in Cordoba. *Investigacion Agraria, Produccion y Proteccion Vegetales.* 9:213–220.
- Barranco, D., and L. Rallo. 2000. Olive cultivars in Spain. *Hort. Technol.* 10:107–110.
- Bartolozzi, F., and G. Fontanazza. 1999. Assessment of frost tolerance in olive (*Olea europaea* L.). *Scientia Hort.* 81:309–319.
- Bidner-BarHava, N. and B. Ramati. 1967. Tolerance of three olive varieties to soil salinity in Israel. *Expt. Agr.* 3:295–305.
- Bollard, E. G. 1970. The physiology and nutrition of developing fruits. p. 387–425. In: A. C. Hulme (ed.), *The biochemistry of fruits and their products*. Academic Press, New York.
- Bonachela, S., F. Orgaz, F. J. Villalobos, and E. Fereres. 1998. Measurement and simulation of evaporation from soil in olive orchards. *Irrig. Sci.* 18:205–211.
- Bongi, G., and S. P. Long. 1987. Light-dependant damage to photosynthesis in olive leaves during chilling and high temperature stress. *Plant Cell Environ.* 10:241–249.
- Bongi, G., and F. Loreto. 1989. Gas-exchange properties of salt-stressed olive (*Olea europaea* L.) leaves. *Plant Physiol.* 90:1408–1416.
- Bongi, G., and A. Palliotti. 1994. Olive. p. 165–187. In: B. Schaffer and P. C. Anderson (eds.), *Handbook of environmental physiology of fruit crops*. CRC Press, Boca Raton, FL.
- Bongi, G., M. Mencuccini, and G. Fontanazza. 1987a. Photosynthesis of olive leaves: effect of light flux density, leaf age, temperature, peltates, and H₂O vapor pressure on gas exchange. *J. Am. Soc. Hort. Sci.* 112:143–148.
- Bongi, G., G. F. Soldatini, and K. T. Hubick. 1987b. Mechanism of photosynthesis in olive tree (*Olea europaea* L.). *Photosynthetica* 21:572–578.
- Bosabalidis, A. M., and G. Kofidis. 2002. Comparative effects of drought stress on leaf anatomy of two olive cultivars. *Plant Sci.* 163:375–379.
- Bouranis, D. L., C. K. Kitsaki, S. N. Chorianopoulou, G. Aivalakis, and J. B. Drossopoulos. 1999. Nutritional dynamics of olive tree flowers. *J. Plant Nutr.* 22:245–257.
- Brodribb, T. 1996. Dynamics of changing intercellular CO₂ concentration (c_i) during drought and determination of minimum functional c_i. *Plant Physiol.* 111:179–185.
- Browse, J., and C. Somerville. 1991. Glycerolipid synthesis: biochemistry and regulation. *Annu. Rev. Plant Physiol. Plant Mol. Biol.* 42:467–506.
- Celano, G., B. Dichio, G. Montanaro, V. Nuzzo, A. M. Palese, and C. Xiloyannis. 1999. Distribution of dry matter and amount of mineral elements in irrigated and non-irrigated olive trees. *Acta Hort.* 474:381–384.

- Centritto, M., F. Loreto, and K. Chartzoulakis. 2003. The use of low [CO₂] to estimate diffusional and non-diffusional limitations of photosynthetic capacity of salt-stressed olive. *Plant Cell Environ.* 26:585–594.
- Chartzoulakis, K., M. H. Loupassaki, M. Bertaki, and I. Androulakis. 2002. Effects of NaCl salinity on growth, ion content and CO₂ assimilation rate of six olive cultivars. *Scientia Hort.* 1814:235–247.
- Chartzoulakis, K., A. Patakas, and A. M. Bosabalidis. 1999. Changes in water relations, photosynthesis and leaf anatomy induced by intermittent drought in two olive cultivars. *Environ. Expt. Bot.* 42:113–120.
- Citernesi, A. S., C. Vitagliano, and M. Giovannetti. 1998. Plant growth and root system morphology of *Olea europaea* L. rooted cuttings as influenced by arbuscular mycorrhizas. *J. Hort. Sci. Biotech.* 73:647–654.
- Cohen, M. E., E. Fereres, D. A. Goldhamer, M. Mata, and J. Girona. 2001. Assessment of peach tree responses to irrigation water deficits by continuous monitoring of trunk diameter changes. *J. Hort. Sci. Biotech.* 76:55–60.
- Connor, D. J., and A. J. Hall. 1997. Sunflower physiology. p. 113–182. In: A. A. Schneiter (ed.), *Sunflower technology and production*. Agron. Monogr. 35. ASA-CSSA-SSSA, Madison.
- Connor, D. J., and T. R. Jones. 1985. Response of sunflower to strategies of irrigation. II. Morphological and physiological responses to water shortage. *Field Crops Res.* 12:91–103.
- Cowan, I. R. 1982. Regulation of water use in relation to carbon gain in higher plants. p. 589–613. In: O. L. Lange, P. S. Nobel, C. B. Osmond, and H. Ziegler (eds.), *Physiological plant ecology II*. Springer-Verlag, New York.
- Cuevas, J., A. J. Diaz Hermoso, D. Galian, J. J. Hueso, V. Pinillos, M. Prieto, D. Sola, and V. S. Polito. 2001. Response to cross pollination and choice of pollinisers for the olive cultivars (*Olea europaea* L.) ‘Manzanilla de Sevilla’, ‘Hojiblanca’ and ‘Picual’. *Olivae.* 85:26–32.
- Cuevas, J., L. Rallo, and H. F. Rapoport. 1994. Crop load effects on floral quality in olive. *Scientia Hort.* 59:123–130.
- DeJong, T. M., and J. Goudriaan. 1989. Modeling peach fruit growth and carbohydrate requirements: reevaluation of the double-sigmoid growth pattern. *J. Am. Soc. Hort. Sci.* 114:800–804.
- de la Rosa, R., L. Rallo, and H. F. Rapoport. 2000. Olive floral bud growth and starch content during winter rest and spring budbreak. *HortScience* 35:1223–1227.
- Delgado, A., M. Benlloch, and R. Fernández-Escobar. 1994. Mobilization of boron in olive trees during flowering and fruit development. *HortScience* 29:616–618.
- Denney, J. O., and G. R. McEachern. 1983. An analysis of several climatic temperature variables dealing with olive reproduction. *J. Am. Soc. Hort. Sci.* 108:578–581.
- Diaz-Espejo, A., B. Hafidi, J. E. Fernández, and M. J. Palomo. 2002. Transpiration and photosynthesis of the olive tree: A model approach. *Acta Hort.* 586:457–460.
- Dichio, B., M. Romano, V. Nuzzo, and C. Xiloyannis. 2002. Soil water availability and relationship between canopy and roots in young olive trees (cv. Coratina). *Acta Hort.* 586:255–258.
- Dichio, B., C. Xiloyannis, K. Angelopoulos, V. Nuzzo, S. A. Bufo, and G. Celano. 2003. Drought-induced variations of water relations parameters in *Oleo europaea* L. *Plant Soil* 257:381–389.
- Dimassi, K., I. Therios, A. Balatsos, I. T. Metzidakis, and D. G. Voyiatzis. 1999. The blooming period and self-fruitfulness in twelve Greek and three foreign olive cultivars. *Acta Hort.* 474:275–278.

- Dry, P. R., and B. R. Loveys. 1999. Grape shoot growth and stomatal conductance are reduced when part of the root system is dried. *Vitis* 38:151–156.
- Dry, P. R., B. R. Loveys, and H. Doring. 2000. Partial drying of the root-zone of grape. I. Transient changes in shoot growth and gas exchange. *Vitis* 39:3–8.
- Ehleringer, J., and R. W. Pearcy. 1993. Variation in quantum yield, for CO₂ uptake among C₃ and C₄ plants. *Plant Physiol.* 73:555–559.
- Fabbri, A., and C. Benelli. 2000. Flower bud induction and differentiation in olive. *J. Hort. Sci. Biotech.* 75:131–141.
- Fahn, A. 1986. Structural and functional properties of trichomes of xeromorphic leaves. *Ann. Bot.* 57:631–637.
- FAOSTAT, 2003. FAO Statistical Databases. Agriculture Data Collection (Primary Crops). Vol. 2003, <http://apps.fao.org/page/collections?subset=agriculture>.
- Faria, T., D. Silverio, E. Breia, R. Cabral, A. Abadia, J. Abadia, J. S. Pereira, and M. M. Chaves. 1998. Differences in the response of carbon assimilation to summer stress (water deficits, high light and temperature) in four Mediterranean tree species. *Physiol. Plant.* 102:419–428.
- Farinelli, D., M. Boco, and A. Tombesi. 2002. Intensity and growth period of the fruit components of olive varieties. *Acta Hort.* 586:607–610.
- Fereres, E., and D. A. Goldhamer. 1990. Deciduous fruit and nut trees. p. 987–1017. In: B. A. Stewart and D. R. Nielsen (eds.), *Irrigation of agricultural crops*. Am. Soc. Agron. Monogr. 30. ASA, Madison, WI.
- Fereres, E., D. A. Goldhamer, and L. R. Parsons. 2003. Irrigation water management of horticultural crops. *HortScience* 38:1036–1042.
- Fernández, J. E., and F. Moreno. 1999. Water use by the olive tree. *J. Plant Prod.* 2:101–162.
- Fernández, J. E., F. Moreno, F. Cabrera, J. L. Arrue, and J. Martín-Aranda. 1991. Drip irrigation, soil characteristics and the root distribution and root activity of olive trees. *Plant Soil* 133:239–251.
- Fernández, J. E., F. Moreno, I. F. Giron, and O. M. Blazquez. 1997. Stomatal control of water use in olive tree leaves. *Plant Soil* 190:179–192.
- Fernández, J. E., F. Moreno, J. Martín Aranda, and J. Lopez Galvez. 1993. Water status of olive trees under dry-farming and drip-irrigation. *Acta Hort.* 335:157–164.
- Fernández, J. E., F. Moreno, J. Martín-Aranda, and H. F. Rapoport. 1994. Anatomical response of olive roots to dry and irrigated soils. *Adv. Hort. Sci.* 8:141–144.
- Fernández, J. E., M. J. Palomo, A. Diaz Espejo, B. E. Clothier, S. R. Green, I. F. Giron, and F. Moreno. 2001. Heat-pulse measurements of sap flow in olives for automating irrigation: Tests, root flow and diagnostics of water stress. *Agr. Water Mgt.* 51:99–123.
- Fernández-Escobar, R. 1998. Fertilización. p. 229–249. In: D. Barranco, R. Fernández-Escobar, and L. Rallo (eds.), *El cultivo del olivo*. Junta de Andalucía y Mundi-Prensa, Madrid.
- Fernández-Escobar, R., D. Barranco, and M. Benlloch. 1993. Overcoming iron chlorosis in olive and peach trees using low-pressure trunk-injection method. *HortScience* 28: 192–194.
- Fernández-Escobar, R., M. Benlloch, C. Navarro, and G. C. Martin. 1992. The time of floral induction in olive. *J. Am. Soc. Hort. Sci.* 117:304–307.
- Fernández-Escobar, R., G. Gómez-Valledor, and L. Rallo. 1983. Influence of pistil extract and temperature on in vitro pollen germination and pollen tube growth of olive cultivars. *J. Hort. Sci.* 58:219–227.
- Fernández-Escobar, R., R. Moreno, and M. García-Creus. 1999. Seasonal changes of mineral nutrients in olive leaves during the alternate-bearing cycle. *Scientia Hort.* 82:25–45.

- Ferrara, E., G. Lorusso, F. Lamparelli, I. T. Metzidakis, and D. G. Voyiatzis. 1999. A study of floral biology and the technological features of seven olive cultivars of different origins. *Acta Hort.* 474:279–283.
- Flora, L. J. and M. A. Matore. 1993. Stachyose and mannitol transport in olive (*Olea europaea* L.). *Planta* 189:484–490.
- García, J. M., and M. Mancha. 1992. Evolución de la biosíntesis de lípidos durante la maduración de las variedades de aceituna ‘Picual’ y ‘Gordal’. *Grasas y Aceites Sevilla.* 43:277–280.
- Ghrisi, N., B. Boulouha, M. Benichou, and S. Hilali. 1999. Agro-physiological evaluation of the phenomenon of pollen compatibility in olive. Case of the Mediterranean collection at the Menara Station, Marrakech. *Olivae* 79:51–59.
- Giménez, C., E. Fereres, C. Ruz, F. Orgaz, and K. S. Chartzoulakis. 1997. Water relations and gas exchange of olive trees: diurnal and seasonal patterns of leaf water potential, photosynthesis and stomatal conductance. *Acta Hort.* 449:411–415.
- Giorgelli, F., A. Minnocci, A. Panicucci, C. Vitagliano, and G. Lorenzini. 1994. Effects of long-term SO₂ pollution on olive-tree gas exchange and leaf morphology. *Acta Hort.* 356:185–188.
- Giorio, G., and R. d’Andria. 2002. Sap flow estimated by compensation heat-pulse velocity technique in olive trees under two irrigation regimes in Southern Italy. *Acta Hort.* 586:401–404.
- Giorio, P., and G. Giorio. 2003. Sap flow of several olive trees estimated with the heat-pulse technique by continuous monitoring of a single gauge. *Environ. Expt. Bot.* 49:9–20.
- Giorio, P., G. Sorrentino, and R. d’Andria. 1999. Stomatal behaviour, leaf water status and photosynthetic response in field-grown olive trees under water deficit. *Environ. Expt. Bot.* 42:95–104.
- Gómez, J. A., J. V. Giraldez, and E. Fereres. 2001. Rainfall interception by olive trees in relation to leaf area. *Agr. Water Mgt.* 49:65–76.
- Grammatikopoulos, G., G. Karabourniotis, A. Kyparissis, Y. Petropoulou, and Y. Manetas. 1994. Leaf hairs of olive (*Olea europaea*) prevent stomatal closure by ultraviolet-B radiation. *Austral. J. Plant Physiol.* 21:293–301.
- Griggs, W. H., H. T. Hartmann, M. V. Bradley, B. T. Iwakini, and J. Whisler. 1975. Olive pollination in California. *California Agr. Expt. Sta. Bul.* 869.
- Grossman, Y. L., and T. M. DeJong. 1994. PEACH: A simulation model of reproductive and vegetative growth in peach trees. *Tree Physiol.* 14:329–345.
- Gucci, R., and C. Cantini. 2000. Pruning and training systems for modern olive growing. CSIRO Publ., Collingwood, Victoria, Australia.
- Gucci, R., E. Gravano, A. Moing, and J. P. Gaudillere. 1998a. Ripartizione dei carboidrati in giovani piante di olivo soggette a stress salino o deficit idrico. *Atti Giornate Scientifiche—San Remo* 1–3:383–384.
- Gucci, R., L. Lombardini, and M. Tattini. 1997. Analysis of leaf water relations in leaves of two olive (*Olea europaea*) cultivars differing in tolerance to salinity. *Tree Physiol.* 17:13–21.
- Gucci, R., and P. E. H. Minchin. 2002. Translocation of newly-assimilated carbon in the vegetative shoot of olive. *Acta Hort.* 586:461–463.
- Gucci, R., A. Moing, E. Gravano, and J. P. Gaudillere. 1998b. Partitioning of photosynthetic carbohydrates in leaves of salt-stressed olive plants. *Austral. J. Plant Physiol.* 25:571–579.
- Gucci, R., and M. Tattini. 1997. Salinity tolerance in olive. *Hort. Rev.* 21:177–213.
- Hacke, U. G., and J. S. Sperry. 2003. Limits to xylem refilling under negative pressure in *Laurus nobilis* and *Acer negundo*. *Plant Cell Environ.* 26:303–311.

- Hackett, W. P., and H. T. Hartmann. 1964. Inflorescence formation in olive as influenced by low temperature, photoperiod, and leaf area. *Bot. Gaz.* 125:65–72.
- Hackett, W. P., and H. T. Hartmann. 1967. The influence of temperature on floral initiation in olive. *Physiol. Plant.* 20:430–436.
- Hartmann, H. T. 1953. Effect of winter chilling on fruitfulness and vegetative growth in olive. *Proc. Am. Soc. Hort. Sci.* 62:184–190.
- Hartmann, H. T., and I. C. Porlingis. 1958. Effects of different amounts of winter chilling on fruitfulness of several olive varieties. *Bot. Gaz.* 119:102–104.
- Hartmann, H. T., A. Tombesi, and J. Whisler. 1970. Promotion of ethylene evolution and fruit abscission in the olive by 2-chloroethane phosphonic acid and cycloheximide. *J. Am. Soc. Hort. Sci.* 95:635–650.
- Hartmann, H. T., and J. E. Whisler. 1975. Flower production in olive as influenced by various chilling temperature regimes. *J. Am. Soc. Hort. Sci.* 100:670–674.
- Hayman, D. S., J. M. Barea, and R. Azcon. 1976. Vesicular-arbuscular mycorrhiza in southern Spain: Its distribution in crops growing in soil of different fertility. *Phytopathol. Mediter.* 15:1–6.
- Hermoso, M., M. Uceda, L. Frías, and G. Beltrán. 1998. Maduración. p. 145–161. In: D. Baranco, R. Fernández-Escobar, and L. Rallo (eds.), *El cultivo del olivo*. Junta de Andalucía y Mundi-Prensa, Madrid.
- Hsiao, T. C. 1973. Plant responses to water stress. *Annu. Rev. Plant Physiol.* 24:519–570.
- Jordão, P. V., and F. Lietão. 1990. The olive's mineral composition and some parameters of quality in fifty olive cultivars grown in Portugal. *Acta Hort.* 286:461–464.
- Karabourniotis, G., K. Papadopoulos, M. Papamarkou, and Y. Manetas. 1992. Ultraviolet-B radiation absorbing capacity of leaf hairs. *Physiol. Plant.* 86:414–418.
- Kitsaki, C. K., J. B. Drossopoulos, G. Aivalakis, F. Anastasiadou, and C. Delis. 1999. In vitro studies of ABA and ethephon induced abscission in olive organs. *J. Hort. Sci Biotech.* 74:19–25.
- Kramer, P. J., and J. S. Boyer. 1995. *The water relations of plants and soils*. Academic Press, San Diego.
- Kreuger, W. H., Z. Heath, and B. Mulqueeny. 2002. Effect of spray solution concentration, active ingredient, additives and sequential treatments of naphthalene acetic acid for chemical thinning of Manzanillo table olives (*Olea europaea*). *Acta Hort.* 586:267–269.
- Larcher, W. 1987. Regional distribution of plants and their adaptive responses to low temperatures—Mediterranean sclerophylls. p. 174–234. In: A. Sakai and W. Larcher (eds.), *Frost survival of plants. Responses and adaptation to freezing stress*. Springer Verlag, Berlin.
- Larcher, W., J. A. P. V. De Moraes, and H. Bauer. 1981. Adaptive responses of leaf water potential, CO₂-gas exchange and water use efficiency of *Olea europaea* during drying and rewetting. p. 77–84. In: N. S. Margaris and H. A. Mooney (eds.), *Components of productivity of Mediterranean-climate regions. Basic and applied aspects*. Dr. W. Junk, The Hague.
- Lavee, S. 1986. Olive. p. 261–276. In: S. P. Monselise (ed.), *CRC handbook of fruit set and development*. CRC Press, Boca Raton, FL.
- Lavee, S. 1990. Aims, methods, and advances in breeding of new olive (*Olea europaea* L.) cultivars. *Acta Hort.* 286:23–36.
- Lavee, S. 1996. Biology and physiology of the olive. p. 59–110. In: IOOC (ed.), *World olive encyclopaedia*. Plaza & Janés Editorial, Barcelona.

- Lavee, S., L. Rallo, H. F. Rapoport, and A. Troncoso. 1999. The floral biology of the olive. II. The effect of inflorescence load and distribution per shoot on fruit set and load. *Scientia Hort.* 82:181–192.
- Legge, N. J. 1985. Anatomical aspects of water movement through stems of Mountain Ash (*Eucalyptus regnans* F. Muell). *Austral. J. Bot.* 33:287–298.
- Liakoura, V., S. Stanvrianakou, G. Liakopoulos, G. Karabourniotis, and Y. Manetas. 1999. Effects of UV-B radiation on *Olea europaea*: Comparisons between a greenhouse and field experiment. *Tree Physiol.* 19:905–908.
- Lo Gullo, M. A., A. Nardini, S. Salleo, and M. T. Tyree. 1998. Changes in root hydraulic conductance (K_R) of *Olea oleaster* seedlings following drought stress and irrigation. *New Phytol.* 140:25–31.
- Loomis, R. S., and D. J. Connor. 1991. Strategies and tactics for water-limited agriculture in low rainfall environments. p. 441–465. In: E. Acevedo, E. Fereres, C. Giménez, and J. P. Srivastara (eds.), *Improvement and management of winter cereals under temperature, drought and salinity stresses*. INIA, Madrid.
- Loomis, R. S., and D. J. Connor. 1992. *Crop ecology: Productivity and management in agricultural systems*. Cambridge Univ. Press, Cambridge.
- Loreto, F., M. Centritto, and K. Chartzoulakis. 2003. Photosynthetic limitations in olive cultivars with different sensitivities to salt stress. *Plant Cell Environ.* 26:595–601.
- Loreto, F., and T. D. Sharkey. 1990. Low humidity can cause uneven photosynthesis in olive (*Olea europaea* L.) leaves. *Tree Physiol.* 6:409–415.
- MacNaughton, K. G., and P. G. Jarvis. 1983. Predicting effects of vegetation on transpiration and evaporation. p. 1–47. In: T. T. Koslowski (ed.), *Water deficits and plant growth*. Academic Press, New York.
- Mancuso, S. 1998. Seasonal dynamics of electrical impedance parameters in shoots and leaves to rooting ability of olive (*Olea europaea*) cuttings. *Tree Physiol.* 19:95–101.
- Mancuso, S. 2000. Electrical resistance changes during exposure to low temperature measure chilling and freezing tolerance in olive tree (*Olea europaea* L.) plants. *Plant Cell Environ.* 23:291–299.
- Manrique, T., H. F. Rapoport, J. Castro, and M. Pastor. 1999. Mesocarp cell division and expansion in the growth of olive fruits. *Acta Hort.* 474:301–304.
- Mariscal, M. J., F. Orgaz, and F. J. Villalobos. 2000a. Modeling and measurement of radiation interception by olive canopies. *Agr. For. Meteorol.* 100:183–197.
- Mariscal, M. J., F. Orgaz, and F. J. Villalobos. 2000b. Radiation-use efficiency and dry matter partitioning of a young olive (*Olea europaea*) orchard. *Tree Physiol.* 20:65–72.
- Martin, G. C. 1990. Olive flower and fruit population dynamics. *Acta Hort.* 286:141–153.
- Martínez-Vilalta, J., E. Prat, and I. Oliveras. 2002. Xylem hydraulic properties of roots and stems on nine Mediterranean woody species. *Oecologia* 133:19–29.
- McDermitt, D. K., and R. S. Loomis. 1981. Elemental composition of biomass and its relation to energy content, growth efficiency and growth yield. *Ann. Bot.* 48:275–290.
- Meinzer, F. C., M. J. Clearwater, and G. Goldstein. 2001. Water transport in trees: Current perspectives, new insights and some controversies. *Environ. Expt. Bot.* 45:239–262.
- Merino, J. 1987. The costs of growing and maintaining leaves of Mediterranean plants. p. 553–564. In: J. D. Tenhunen, F. M. Catarino, O. L. Lange, W. V. Oechel (eds.), *Plant response to stress. Functional analysis in Mediterranean ecosystems*. NATO ISI Series, Vol. G15. Springer Verlag, Berlin.
- Milburn, J. A., and R. P. C. Johnson. 1966. The conduction of sap. II. Detection of vibrations produced by sap cavitation. *Planta* 69:43–52.

- Minnocci, A., A. Panicucci, L. Sebastiani, G. Lorenzini, and C. Vitagliano. 1999. Physiological and morphological responses of olive plants to ozone exposure during a growing season. *Tree Physiol.* 19:391–397.
- Miranovic, K. 1994. Investigations of elayographic properties of the olive cultivar Zutica (*Olea europaea* L.). *Acta Hort.* 356:74–77.
- Mitchell, P. D., and D. J. Chalmers. 1982. The effect of reduced water supply on peach tree growth and yield. *J. Am. Soc. Hort. Sci.* 107:853–856.
- Mitchell, P. D., B. van den Ende, P. H. Jerie, and D. J. Chalmers. 1989. Response of 'Bartlett' pear to withholding irrigation, regulated deficit irrigation, and tree spacing. *J. Am. Soc. Hort. Sci.* 114:15–19.
- Moreno, F., J. E. Fernandez, B. E. Clothier, and S. R. Green. 1996. Transpiration and root water uptake by olive trees. *Plant Soil* 184:85–96.
- Moriana, A., F. Orgaz, M. Pastor, and E. Fereres. 2003. Yield responses of a mature olive orchard to water deficits. *J. Am. Soc. Hort. Sci.* 128:425–431.
- Moriana, A., F. J. Villalobos, and E. Fereres. 2002. Stomatal and photosynthetic responses of olive (*Olea europaea* L.) leaves to water deficits. *Plant Cell Environ.* 25:395–405.
- Mulas, M., F. Virdis, M. Schirra, and M. Mura. 1999. Fruit quality of table-olive clones selected from 'Nera' variety. *Acta Hort.* 474:605–608.
- Natali, S., C. Bignami, C. Cammilli, and M. Muganu. 1999. Effect of water stress on leaf movement in olive cultivars. *Acta Hort.* 474:445–448.
- Natali, S., C. Xiloyannis, and P. Angelini. 1985. Water consumptive use of olive trees (*Olea europaea*) and effect of water stress on leaf water potential and diffusive resistance. *Acta Hort.* 171:341–345.
- Navarro, C., R. Fernández-Escobar, and M. Benlloch. 1990. Flower bud induction in Manzanillo olive. *Acta Hort.* 286:195–198.
- Navarro, C., and M. A. Parra. 1998. Plantación. p. 163–195. In: D. Barranco, R. Fernández-Escobar, and L. Rallo (eds.), *El cultivo del olivo*. Junta de Andalucía y Mundi-Prensa, Madrid.
- Nogués, S., and N. R. Baker. 2000. Effects of drought on photosynthesis in Mediterranean plants grown under enhanced UV-B radiation. *J. Expt. Bot.* 51:1309–1317.
- Orgaz, F., and E. Fereres. 1998. Riego. p. 259–280. In: D. Barranco, R. Fernández-Escobar, and L. Rallo (eds.), *El cultivo del olivo*. Mundi-Prensa, Madrid.
- Ortega Nieto, J. M. 1945. Poda del olivo; con aplicación especial a las zonas de Ubeda y 'El Condado' (Jaen). Editora El Olivo, S.S.L., Jaen.
- Owen, R. W., A. Giacosa, W. E. Hull, R. Haubner, B. Spiegelhalder, and H. Bartsch. 2000. The antioxidant/anticancer potential of phenolic compounds isolated from olive oil. *Eur. J. Cancer.* 36:1235–1347.
- Palese, A. M., V. Nuzzo, B. Dichio, G. Celano, M. Romano, C. Xiloyannis, M. I. Ferreira, and H. G. Jones. 2000. The influence of soil water content on root density in young olive trees. *Acta Hort.* 537:329–336.
- Palliotti, A., and G. Bonghi. 1996. Freezing injury in the olive leaf and effects of mefluidide treatment. *J. Hort. Sci.* 71:57–63.
- Pastor, M., J. Castro, V. Vega, and M. D. Humanes. 1998. Sistemas de manejo del suelo. p. 197–236. In: D. Barranco, R. Fernández-Escobar, and L. Rallo (eds.), *El cultivo del olivo*. Junta de Andalucía y Mundi-Prensa, Madrid.
- Pastor, M., J. Hidalgo, V. Vega, J. Girona, L. Soria, F. Orgaz, E. Fernández, J. Fernández, and J. Rojo. 2001. Programación de riegos en olivar. Consejería de Agric. y Pesca, Junta de Andalucía, Sevilla.
- Pastor Muñoz Cobo, M., and J. Humanes Guillen. 1996. Poda del olivo. Moderna olivicultura. Editorial Agr. Española, S.A., Madrid.

- Patumi, M., R. d' Andria, V. Marsilio, G. Fontanazza, G. Morelli, and B. Lanza. 2002. Olive and olive oil quality after intensive monocone olive growing (*Olea europaea* L., cv. Kalamata) in different irrigation regimes. *Food Chem.* 77:27–34.
- Pavel, E. W., and E. Fereres. 1998. Low soil temperatures induce water deficits in olive (*Olea europaea*) trees. *Physiol. Plant.* 104:525–532.
- Penning de Vries, F. W. T., A. H. M. Brunsting, and A. H. van Laar. 1974. Product requirements and efficiency of biosynthesis: A quantitative approach. *J. Theor. Biol.* 45:339–377.
- Perica, S., P. H. Brown, J. H. Connell, and H. Hu. 2002. Olive response to foliar boron application. *Acta Hort.* 586:381–383.
- Peuke, A. D., W. D. Jesche, and W. Hartung. 1994. The uptake and flow of C, N and ions between roots and shoots in *Ricinus communis* L. III. Long-distance transport of abscisic acid depending on nitrogen nutrition and salt stress. *J. Expt. Bot.* 45:741–747.
- Pinney, K., and V. S. Polito. 1990. Flower initiation in Manzanillo olive. *Acta Hort.* 286:203–205.
- Priestley, C. A. 1977. The annual turnover of resources in young olive trees. *J. Hort. Sci.* 52:105–112.
- Proietti, P. 2000. Effect of fruiting on leaf gas exchange in olive (*Olea europaea* L.). *Photosynthetica* 38:397–402.
- Proietti, P., and A. Palliotti. 1997. Contribution of the adaxial and abaxial surfaces of olive leaves to photosynthesis. *Photosynthetica* 33:63–69.
- Proietti, P., and A. Tombesi. 1996. Translocation of assimilates and source-sink influences on productive characteristics of the olive tree. *Adv. Hort. Sci.* 10:11–14.
- Proietti, P., F. Famiani, and A. Tombesi. 1999a. Gas exchange in olive fruit. *Photosynthetica* 36:423–432.
- Proietti, P., A. Palliotti, and G. Nottiani. 1999b. Availability of assimilates and development of olive fruit. *Acta Hort.* 474:297–300.
- Rallo, L. 1998. Frutificación y producción. p. 112–144. In: D. Barranco, R. Fernández-Escobar, and L. Rallo (eds.), *El cultivo del olivo*. Junta de Andalucía y Mundi-Prensa, Madrid.
- Rallo, L., and R. Fernández-Escobar. 1985. Influence of cultivar and flower thinning within the inflorescence on competition among olive fruit. *J. Am. Soc. Hort. Sci.* 110:303–308.
- Rallo, L., and G. C. Martin. 1991. The role of chilling in releasing olive floral buds from dormancy. *J. Am. Soc. Hort. Sci.* 116:1058–1062.
- Rallo, L., G. C. Martin, and S. Lavee. 1981. Relationship between abnormal embryo sac development and fruitfulness in olive. *J. Am. Soc. Hort. Sci.* 106:813–817.
- Rallo, L., and M. P. Suarez. 1989. Seasonal distribution of dry matter within the olive fruit-bearing limb. *Adv. Hort. Sci.* 3:55–59.
- Rallo, L., P. Torreno, and J. A. Vargas. 1994. Dormancy and alternate bearing in olive. *Acta Hort.* 356:127–136.
- Rallo, P., and H. F. Rapoport. 2001. Early growth and development of the olive fruit mesocarp. *J. Hort. Sci. Biotech.* 76:408–412.
- Rapoport, H., G. Costagli, and R. Gucci. 2004. The effect of water deficit during early fruit development on olive fruit morphogenesis. *J. Am. Soc. Hort. Sci.* 129: (in press).
- Rapoport, H. F. 1998. Botánica y morfología. p. 34–60. In: D. Barranco, R. Fernández-Escobar, and L. Rallo (eds.), *El cultivo del olivo*. Junta de Andalucía y Mundi-Prensa, Madrid.
- Rapoport, H. F., and L. Rallo. 1991a. Fruit set and enlargement in fertilized and unfertilized olive ovaries. *HortScience* 26:896–898.
- Rapoport, H. F., and L. Rallo. 1991b. Postanthesis flower and fruit abscission in 'Manzanillo' olive. *HortScience* 116:720–723.

- Reuter, D. J., J. B. Robinson, and C. Dutkiewicz. 1997. Plant analysis: An interpretation manual. CSIRO Publishing, Melbourne.
- Rieger, M. 1995. Offsetting effects of reduced root hydraulic conductivity and osmotic adjustment following drought. *Tree Physiol.* 15:379–385.
- Rojó, C. 1840. *Arte de cultivar del olivo*. El Olivo S.L.L., Ubeda.
- Roselli, G., G. Benelli, and D. Morelli. 1989. Relationship between stomatal density and winter hardiness in olive (*Olea europaea* L.). *J. Hort. Sci.* 64:199–203.
- Salleo, S., M. A. Lo Gullo, D. De Paoli, and M. Zippo. 1996. Xylem recovery from cavitation-induced embolism in young plants of *Laurus nobilis*. A possible mechanism. *New Phytologist*. 132:47–56.
- Salleo, S., M. A. Lo Gullo, and F. Oliveri. 1985. Hydraulic parameters measured in 1-year-old twigs of some Mediterranean species with diffuse porous wood: Changes in hydraulic conductivity and their possible functional significance. *J. Expt. Bot.* 36:1–11.
- Salleo, S., A. Nardini, F. Pitt, and M. A. lo Gullo. 2000. Xylem cavitation and hydraulic control of stomatal conductance in laurel (*Laurus nobilis* L.). *Plant Cell Environ.* 23:71–79.
- Sánchez, J. 1994. Lipid photosynthesis in olive fruit. *Progr. Lipid Res.* 33:97–104.
- Sanz Encinas, M., and L. Montanes Garcia. 1997. Visual diagnosis of iron chlorosis. *ITEA Produccion Vegetal.* 93:7–22.
- Sanz-Cortés, F., J. Martínez-Calvo, M. L. Badenes, H. Bleiholder, H. Hack, G. Llacer, and U. Meier. 2002. Phenological growth stages of olive trees (*Olea europaea*). *Ann. Appl. Biol.* 140:151–157.
- Schulze, E.-D., J. Eernák, R. Matyssek, M. Penka, R. Zimmermann, F. Vasicek, W. Gries, and J. Kueera. 1985. Canopy transpiration and water fluxes in the xylem of the trunk of *Larix* and *Picea* trees—a comparison of xylem flow, porometer and cuvette measurements. *Oecologia* 66:475–483.
- Schulze, E.-D., and A. E. Hall. 1982. Stomatal responses, water loss and CO₂ assimilation rates of plants in contrasting environments. p. 182–230. In: O. L. Lange, P. S. Nobel, C. B. Osmond, and H. Ziegler (eds.), *Physiological plant ecology II*. Springer-Verlag, New York.
- Sebastiani, L., A. Minnocci, F. Scebba, C. Vitagliano, A. Panicucci, and G. Lorenzini. 2002. Physiological and biochemical reactions of olive genotypes during site-relevant ozone exposure. *Acta Hort.* 586:445–448.
- Sibbett, G. S., and L. Ferguson. 2002. Nitrogen, boron, and potassium dynamic in ON vs OFF cropped Manzanillo olive trees in California, USA. *Acta Hort.* 586:369–373.
- Sperry, J. S. 1995. Limitations on stem water transport and their consequences. p. 105–124. In: B. L. Gartner (ed.), *Plant stems: Physiological and functional morphology*. Academic Press, San Diego.
- Sperry, J. S. 2003. Evolution of water transport and xylem structure. *Int. J. Plant Sci.* 164:S115–127.
- Sperry, J. S., J. R. Donnelly, and M. T. Tyree. 1988. A method for measuring hydraulic conductivity and embolism in xylem. *Plant Cell Environ.* 11:35–40.
- Stutte, G. W., and G. C. Martin. 1986. Effect of killing the seed on return to bloom of olive. *Scientia Hort.* 29:107–113.
- Taiz, L., and E. Zeiger. 1991. *Plant physiology*. Benjamin/Cummings, Redwood City, CA.
- Tattini, M., L. Lombardini, and R. Gucci. 1997. The effect of NaCl stress and relief on gas exchange properties of two olive cultivars differing in tolerance to salinity. *Plant Soil* 197:87–93.
- Thompson, R. G., M. T. Tyree, M. A. Lo Gullo, and S. Salleo. 1983. The water relations of young olive trees in Mediterranean winter. Measurements of evaporation from leaves and conduction in wood. *Ann. Bot.* 52:399–406.

- Tognetti, R., L. Sebastiani, A. Minnocci, C. Vitagliano, and A. Raschi. 2002. Foliar responses of olive trees (*Olea europaea* L.) under field exposure to elevated CO₂ concentration. *Acta Hort.* 586:449–452.
- Tognetti, R., L. Sebastiani, C. Vitagliano, A. Raschi, and A. Minnocci. 2001. Responses of two olive tree (*Olea europaea* L.) cultivars to elevated CO₂ concentration in the field. *Photosynthetica* 39:403–410.
- Tombesi, A. 1994. Olive fruit growth and metabolism. *Acta Hort.* 356:225–232.
- Tous, J., and L. Ferguson. 1997. Olive growing in California (USA). *Olivae* 67:18–26.
- Troncoso, A., J. Prieto, and J. Liñan. 1978. Aclareo químico de frutos en el olivar Manzanilla de Sevilla. *Ann. Edafol. Agrobio.* 37:882–893.
- Tyree, M. T., and F. W. Ewers. 1991. The hydraulic architecture of trees and other woody plants. *New Phytol.* 119:345–360.
- Tyree, M. T., S. Patiño, J. Bennink, and J. Alexander. 1995. Dynamic measurements of root hydraulic conductance using a high pressure flowmeter in the laboratory and field. *J. Expt. Bot.* 46:83–94.
- Tyree, M. T., and J. S. Sperry. 1988. Do woody plants operate near the point of catastrophic xylem dysfunction caused by dynamic water stress? Answers from a model. *Plant Physiol.* 88:574–580.
- Tyree, M. T., and J. S. Sperry. 1989. Characterization and propagation of acoustic-emission signals of woody plants—towards an improved acoustic-emission counter. *Plant Cell Environ.* 12:371–382.
- Uceda, M., and M. Hermoso. 1998. La calidad del aceite de oliva. p. 547–572. In: D. Baranco, R. Fernández-Escobar, and L. Rallo (eds.), *El cultivo del olivo*. Junta de Andalucía y Mundi-Prensa, Madrid.
- van Ittersum, M. K., and M. Donatelli. 2002. Modelling cropping systems: Science, software and applications. *Eur. J. Agron.* 18:188–393.
- Villalobos, F. J. 1999. Modelling of carbon and water balances of olive (*Olea europaea* L.). *Revista de Ciencias Agrarias.* 22:131–143.
- Villalobos, F. J., F. Orgaz, and L. Mateos. 1995. Non-destructive measurement of leaf area in olive (*Olea europaea* L.) trees using a gap inversion method. *Agr. For. Meteorol.* 73:29–42.
- Villalobos, F. J., F. Orgaz, L. Testi, and E. Fereres. 2000. Measurement and modeling of evapotranspiration of olive (*Olea europaea* L.) orchards. *Eur. J. Agron.* 13:155–163.
- Visioli, F., C. Galli, G. Galli, and D. Caruso. 2002. Biological activities and metabolic fate of olive oil phenols. *Eur. J. Lipid Sci. Technol.* 104:677–684.
- Vitagliano, C., A. Minnocci, L. Sebastiani, A. Panicucci, G. Lorenzini, I. T. Metzidakis, and D. G. Voyiatzis. 1999. Physiological response of two olive genotypes to gaseous pollutants. *Acta Hort.* 474:431–434.
- Wullschlegel, S. D., F. C. Meinzer, and R. A. Vertessy. 1998. A review of whole-plant water use studies in trees. *Tree Physiol.* 18:499–512.
- Xiloyannis, C., G. Celano, A. M. Palese, B. Dichio, and V. Nuzzo. 2002. Mineral nutrient uptake from the soil in irrigated olive trees, cultivar Coratina, over six years after planting. *Acta Hort.* 586:453–456.
- Xiloyannis, C., B. Pezzarossa, J. Jorba, and P. Angelini. 1988. Effects of soil water content on gas exchange in olive trees. *Adv. Hort. Sci.* 2:58–63.
- Yamada, H., and G. C. Martin. 1994. Physiology of olive leaf abscission induced by phosphorus. *J. Am. Soc. Hort. Sci.* 119:956–963.
- Zhang, J., and W. J. Davis. 1990. Changes in the concentration of ABA in the xylem sap as a function of changing soil water status will account for changes in leaf conductance. *Plant Cell Environ.* 13:277–285.

Crop Load Interactions in Apple

Jens N. Wünsche

The Horticulture and Food Research Institute of New Zealand
Hawke's Bay Research Centre, Private Bag 1401, Havelock North,
New Zealand

Ian B. Ferguson

The Horticulture and Food Research Institute of New Zealand
Mt Albert Research Centre, Private Bag 92 169, Auckland,
New Zealand

- I. INTRODUCTION
- II. DEFINITION
- III. FACTORS DETERMINING CROP LOAD
 - A. Plant-environment Interactions
 - 1. Climatic Factors
 - 2. Carbohydrate Availability
 - 3. Biennial Bearing
 - B. Crop Management
 - 1. Rootstock
 - 2. Flower and Fruit Thinning
- IV. FACTORS AFFECTED BY CROP LOAD
 - A. Vegetative Response
 - 1. Shoots
 - 2. Leaves
 - 3. Trunk and Roots
 - B. Reproductive Response
 - 1. Flower Formation
 - 2. Fruit Development
 - C. Fruit Attributes
 - 1. At-harvest Quality
 - 2. Postharvest Quality
 - 3. Consumer Preferences

V. PHYSIOLOGICAL AND BIOCHEMICAL RESPONSE

- A. Mineral Nutrients
- B. Water Relations
 - 1. Water Consumption
 - 2. Water Potential
- C. Carbon Production and Partitioning
 - 1. Dry Matter
 - 2. Carbohydrates
- D. Gas Exchange Characteristics
 - 1. Leaf
 - 2. Whole-canopy
 - 3. Fruit
- E. Regulation of Photosynthesis
 - 1. Chlorophyll Fluorescence
 - 2. Leaf Conductance
 - 3. Chlorophyll Concentration
 - 4. Carbohydrate Concentration
- F. Regulation of Fruit Growth

VI. CONCLUDING REMARKS

- A. A Molecular Approach
- B. Major Conclusions
 - 1. Tree Growth Response
 - 2. Fruit Growth and Quality Response

LITERATURE CITED

ABBREVIATIONS

ABA	abscisic acid
A/C _i	leaf photosynthesis rate/leaf internal CO ₂ concentration
AFB	after full bloom
BA	benzyladenine
BSA	bulked segregant analysis
CA	controlled atmosphere
CPPU	N-(2-chloro-4-pyridyl)-N'-phenylurea
DAFB	days after full bloom
EPP	effective pollination period
EST	expressed sequence tag, refers to stretches of DNA sequences whose location and base sequence are known
ETR	electron transport rate
$\Delta F/F_m'$	photochemical yield
g _s	stomatal conductance
g _m	mesophyll conductance
MAS	marker assisted selection
MLA	mass per unit leaf area
NCER	net carbon exchange rate

NPQ	non-photochemical quenching
QTL	quantitative trait loci
PAR	photosynthetic active radiation
PPFD	photosynthetic photon flux density
PS II	photosystem II
q_P	photochemical quenching
RAPD	random amplified polymorphic DNA
RFLP	restriction fragment length polymorphism—marker used in mapping
RuBP	rubisco
SPS	sucrose phosphate synthase
SS	sucrose synthase
SSC	soluble solids concentration
TCA	trunk cross-sectional area

I. INTRODUCTION

The trend to more consumer-driven food markets emphasizes a growing need to manage fruit production in order to optimize quality and produce fruit with specific quality attributes. The production of apple (*Malus × domestica* Borkh.) crops with such attributes depends on the genetic make up, a sequence of growth and developmental changes from flower evocation to maturation, and postharvest storage and handling. Once the fruit has been harvested, however, postharvest technology, at best, only ensures the maintenance of inherent fruit quality through to the consumer. Therefore, given a specific genetic background, environmental and management factors during the growing season will be the most important determinants in achieving desired product quality.

Crop load is a key cultural component of final fruit quality, and thus of managing the risks associated with achieving commercial requirements for fruit size, consumer-based quality attributes, and freedom from disorders. In this regard, information on crop manipulation and effects of harvest time and fruit maturity are of particular importance to growers in enhancing the proportion of the crop achieving desired qualities.

The presence or absence of fruit on perennial fruit trees and vines has a major effect on the photosynthetic performance and growth response of these plants (see reviews by Flore and Lakso 1989; Forshey and Elfving 1989; Jackson 1989; Wright 1989; Byers 2003). Effects of time and severity of fruit(let) thinning or crop load adjustment, and concomitant alteration of fruit to leaf ratios, have been extensively studied in a desire

to achieve high orchard productivity without compromising potential fruit size and quality or return bloom. Optimized crop loads for a given cultivar and production system in a particular environment can give enhanced financial returns to growers.

This review provides a summary of research on various factors determining cropping, and on the complex interactions between environment and physiological and biochemical plant responses to crop load in relation to apple fruit quality. Most research has focused on the impact of fruit load on tree and fruit physiology; surprisingly little has been directed specifically at the impact of cropping on final fruit quality in terms of postharvest storage, shelf life, and consumer preference. Compared to other preharvest factors such as pollination, mineral nutrition, and light and temperature environment, variability in crop load may have the greatest impact on both fruit quality and tree physiology.

II. DEFINITION

Crop load, as a measure of orchard productivity, is defined as the amount (e.g., number or weight) of fruit produced per tree or branch unit. The term yield efficiency is often used when crop load is expressed as the fruit yield per whole-canopy leaf area, trunk cross-sectional area (TCA), canopy volume or tree light interception. There are, however, a few considerations to take into account when using efficiency terms. First, as efficiency is strictly speaking dimensionless, perhaps an alternative term such as crop density or crop mass should be sought. Second, high numbers of fruit per tree do not necessarily translate to high cropping efficiency (e.g., fruit number/cm² TCA), as is often seen in large trees on vigorous rootstocks. Third, while canopy volume and tree light interception is expected to reach a maximum after a few years from planting in high-density orchards, the tree's TCA continues to increase over its life. Consequently, yield efficiency increases until tree canopies have fully occupied the allocated area; however, thereafter it declines when based on per unit of TCA. This raises issues about the usefulness of such ratios when trunk size varies greatly with tree age and TCA may not be the best denominator in this case.

Whilst providing a physiological expression of cropping, measuring crop load for a given orchard production system will also assist in specific crop management decisions such as thinning, assessment of orchard performance and profitability, and accurate forecasting of crop volume for planning transport and marketing requirements.

III. FACTORS DETERMINING CROP LOAD

A. Plant-environment Interactions

A number of environmental factors affect apple yield and fruit quality, but light and temperature are of particular interest. The amount of incident solar radiation and the prevailing temperatures vary with latitude and cloud cover. Moderate ambient temperature, high light energy input, and a long growing season are essential for setting a high potential yield in a growing region. Seasonal and daily changes in light and temperature affect plant photosynthesis and respiration, and thus carbon pools, which in turn affect source-sink relations. Hence, the appropriate cropping level within a particular fruit-growing region is largely determined by the complex nature of the interactions between various environmental factors.

1. Climatic Factors

Temperature. The main effects of temperature are likely to be on flowering and the early stages of fruit growth. Since comprehensive coverage of this topic was recently provided by Palmer et al. (2003), only specific aspects of temperature effects on cropping are presented in this review.

Exposure to freezing temperatures, particularly over the blossoming period, can, without appropriate frost protection, severely damage flowers and thus reduce fruit set. In many areas of the world the incidence of spring frosts, low spring temperatures, or the absence of winter chill have a major effect on the subsequent crop load, leading to large fluctuations in productivity. However, Khanizadeh et al. (1992) showed that the ability of apple flower buds to withstand freezing injury temperatures until pink stage was enhanced when 'McIntosh'/'M.7' trees did not carry a crop in the previous year, whereas flower buds on previously cropping trees were more susceptible to low temperature injury.

In contrast, high summer daytime temperatures can inhibit flower bud formation and reduce the production of flower buds, as controlled environment studies by Tromp (1976) and Jonkers (1984) have shown, although there is little evidence that this can occur under field conditions in temperate areas. Jackson and Hamer (1980) found that apple fruit set and yield were negatively correlated to temperature prior to bloom but positively correlated to temperatures after bloom and again in June. The negative effect of warm temperatures before bloom was associated with more bud susceptibility to frost, whereas the positive effect of high

temperatures directly after bloom was related to enhanced pollen tube growth (Williams 1970a,b). It is also well established that fruit growth, particularly during the time of cell division immediately following bloom, is very temperature responsive and important in establishing seasonal fruit size potential (Lakso 1994; Warrington et al. 1999). For example, in a comparison of fruit growth of four cultivars over two seasons, larger fruit size at 42 days after full bloom (DAFB) was associated with higher previous temperatures and increased rate of cortical cell division (Bergh 1990).

Light Availability. Light is the single most important factor controlling the acquisition of atmospheric carbon dioxide by the leaves of healthy apple trees. Estimates by Hansen (1977a) suggest that more than 90% of the total dry matter produced by apple trees originates from photosynthesis by leaves.

Apple yields are positively related to the total amount of sunlight intercepted by the orchard (Palmer 1989; Robinson and Lakso 1991; Wagenmakers 1991). However, due to deleterious multiple-year effects of overly leafy, shaded tree canopies on flowering and/or fruit development, optimum apple yields are typically obtained at about 60–70% light interception (Lakso 1994; Wünsche and Lakso 2000b). Yield performance at higher light interception can be reduced because of increased mutual shading among the leaves and internal shading of fruiting sites that require good exposure for high productivity, especially if the canopy closes early in the growing season (Jackson and Palmer 1977; Lakso et al. 1989; Robinson and Lakso 1989; Lakso and Corelli Grappadelli 1993; Wünsche et al. 1996; Wünsche and Lakso 2000a). Flowering is heavier in relatively open, well-exposed tree canopies, and experiments with artificial shading by Jackson (1975) have indicated that flowering is reduced when light levels are below 30% of full sun in the United Kingdom.

Incident light and canopy leaf area are important prerequisites for tree light interception, which not only affects leaf photosynthetic rates but also whole-canopy photosynthesis. Balancing whole-canopy source-sink relations for optimum carbon acquisition and partitioning requires careful consideration of light availability and tree interception and is fundamental to achieving regular cropping in apple.

Drought. The effects of water stress, that is, the imbalance between tree water-use demand and availability of soil water, on growth and development of apple have been extensively researched and reviewed by several authors (Landsberg and Jones 1981; Jones et al. 1985; Lakso 1994;

Behboudian and Mills 1997). In the context of this review, the effects of water deficit on fruit set can be briefly summarized. Plant processes associated with growth by cell division are typically sensitive to water stress. Consequently, early season water stress, during a growth period involving organ differentiation and active meristematic and cortical cell division, has a profound impact on vegetative growth and fruit development. Water deficit, depending on severity and timing, can lead to a reduction in flower numbers, fruit growth rate and/or fruit set, which in turn can cause crop load induced differences in fruit quality (see Sections IVB and C). In contrast, water stress that develops later in the season has a lesser effect on vegetative growth and fruit yield, but can inhibit the development of fruit growth potential and result in smaller fruit size.

2. Carbohydrate Availability. Fruit number and fruit and tree growth are determined by complex carbohydrate source-sink relationships between photosynthetic source leaves and vegetative and reproductive sinks (Flore and Lakso 1989; Lakso 1994). There are two growth stages that are of particular importance for carbohydrate partitioning into developing fruit, with major implications for crop load and fruit quality.

Early Season. The supply of carbon to individual fruitlets may be limiting during fruit growth in the first 3–5 weeks after full bloom through competition from other fruitlets and other sinks such as rapidly growing shoots (Lakso et al. 1989). Fruit development at this early stage is essentially supported by carbohydrate supply from spur leaves, whereas actively growing extension shoots utilize endogenously synthesized carbohydrates for their own development (Hansen 1971a; Lakso et al. 1989; Corelli Grappadelli et al. 1994; Lakso 1994). Sub-optimal growth conditions and/or high crop density during the first month after bloom, during fruit cell division when set and potential size are determined, may cause a deficit in the carbon availability to fruit, compared with the stronger vegetative sinks (Hansen 1971a, 1977a; Lakso et al. 1989; Lakso and Corelli Grappadelli 1993; Corelli Grappadelli et al. 1994; Bepete and Lakso 1998). If fruit demand for assimilates exceeds carbohydrate availability (e.g., heavy crop load), the resulting supply limitation leads to “non-recoverable” decreased fruit growth, resulting in fewer fruit cells and reduced final fruit size at harvest and/or increased fruit abscission (Schneider 1977; Ferree and Palmer 1982; Kondo and Takahashi 1987; Lakso et al. 1989; Byers et al. 1991; Lakso and Corelli Grappadelli 1993).

Mid- to Late-season. Mid- and late-season carbohydrate supply is less likely to limit fruit growth due to carbohydrate export from terminated

extension shoots (Lakso et al. 1989, 1995) and a more general carbohydrate distribution pattern (Hansen 1969, 1977a,b; Hansen and Christensen 1974). Final fruit growth before harvest may be limited by total tree carbohydrate production in climates with shorter seasons due to reduced light and temperature, particularly in combination with heavy crop loads (Lakso and Corelli Grappadelli 1993).

These results indicate that canopy management practices for optimizing apple productivity should ensure open, well-exposed canopies, particularly early in the growing season, since it appears that fruit yield (final crop load) and quality depend primarily on early spur canopy light microclimate. Practices that increase fruit cell division after bloom, and hence maintain fruit growth rates close to potential, have a much greater relative effect on final fruit size and quality than practices later in the season.

3. Biennial Bearing. The lack of regular cropping that occurs in many deciduous fruit tree crops, including apple, is termed alternate or biennial bearing (Jonkers 1979; Monselise and Goldschmidt 1982). These annual cyclical changes in cropping (“on” vs. “off” or “heavy” vs. “light”) may occur in an entire fruit-growing region, triggered by adverse climatic conditions, although they are more commonly observed at the tree or branch level (Davis 1957; Monselise and Goldschmidt 1982). The exact physiological processes that lead to biennial bearing are still poorly understood, but are often linked to the lack of efficient plant control of the reproductive development cycle (Lavee 1989). The tendency to alternate bearing is stronger in plant species where flower initiation takes place early, during the first stages of fruit development, as is the case in apple (Handsack 2000).

Apple cultivars differ profoundly in their tendency to fruitfulness and regular cropping behavior (Jonkers 1979; Hampson and Kemp 2003). Besides genetic differences in biennial susceptibility between cultivars, biennial bearing in apple generally increases with rootstock vigor, tree age, branch-size, and spur-bearing habit (Westwood 1978; Jonkers 1979; Monselise and Goldschmidt 1982). Excessive fruit set (crop load) has an inhibitory effect on flower induction in the same year, leading to low or no crop in the subsequent year. Cultivars with a biennial bearing habit typically initiate fewer flowers with increasing crop load (Abbott 1984). Once initiated by environmental or crop management triggers, alternate bearing is often maintained for several years because of its self-perpetuating properties (Luckwill 1970; Buban and Faust 1982). Endogenous factors, such as carbohydrate partitioning and growth promoting hormones, are believed to be the physiological basis for the effect of fruit

on flowering and biennial bearing (Fulford 1966a; Chan and Cain 1967; Grochowska, 1973; Hoad 1978; Dennis and Neilsen 1999; Neilsen and Dennis 2000).

A number of management practices are used to ameliorate biennial bearing in fruit trees and all are aimed at achieving a balance between reducing excessive cropping in the “on”-year and increasing flowering in the “off”-year. Flower/fruitlet thinning and hence crop load adjustment appears most effective (Davis 1957; Goffinet et al. 1995; Goldschmidt, 1996), but other practices such as early fruit harvest (Luckwill 1974; Williams et al. 1980), pruning and training to improve light distribution and whole-canopy carbon balance (Greene and Lord 1978; Dennis 1979), root pruning (Schupp and Ferree 1987; Ferree 1992; Schupp et al. 1992; Ferree and Rhodus 1993; Baugher et al. 1995) and the use of dwarfing rootstocks such as ‘M.9’ (Luckwill 1970; Jonkers 1979; Handschack 2000) are also commonly used. The effect of thinning and cropping level on flowering in the subsequent year will be discussed in detail in later sections.

B. Crop Management

There are many tree and orchard management practices that influence crop load and fruit quality. While we recognize that most of those practices are essential to modern fruit production, we only discuss factors that affect tree crop load in healthy and well-maintained orchard blocks. It is clear that pollination and fertilization will determine fruit set and actual crop load. Moreover, sub-optimal irrigation levels typically affect soil water availability, thus plant water status and consequently fruit size and harvest yield (Assaf et al. 1982; Erf and Proctor 1987; Irving and Drost 1987). Similar effects will be seen from an unfavorable nutrient supply. All pruning, depending on severity, reduces tree growth (Mika 1986), thereby also decreasing cropping and potential fruit bearing sites on the tree (Barlow 1964; Elfving and Forshey 1976).

The effects of rootstock and flower/fruit thinning on crop load are discussed below.

1. Rootstock. Rootstocks have a marked effect on tree size and seasonal vegetative growth increments for both fruiting and nonfruiting trees (Avery 1969; Forshey and McKee 1970; Dudney and Hadlow 1972), but they also influence fruit size and quality (Jackson and Blasco 1975; Preston et al. 1981; Autio 1991). However, effects of rootstocks on fruit characteristics can be confounded with crop density, which typically decreases with increasing rootstock vigor. J. N. Wünsche and

J. W. Palmer (unpubl. data), investigating the effect of crop load and rootstock on yield and fruit quality of 'Fuji' apple over two seasons, found that, despite an increase in TCA of trees from 27 cm² on 'M.9' to 61 cm² on 'M.26' and 104 cm² on 'MM.106' rootstock, there was a tendency for a decreasing number of fruit per unit TCA with increased tree vigor (8.8, 5.8, 4.2 fruit per TCA for 'M.9', 'M.26' and 'MM.106', respectively) when cropping levels were established by hand at full bloom. This suggests a limitation of flowering with more vigorous stocks and the lack of ability to establish the same range of crop density (fruit number cm⁻² TCA) for each rootstock.

When comparing trees on rootstocks which control size to the same extent, however, average fruit weight is negatively correlated with number of fruit per tree and crop density (Forshey and Elfving 1977; Elfving and Schechter 1993). Evaluating apple trees on a wide range of rootstock vigor, Elfving and Schechter (1993) found that average fruit weight was better related to number of fruit per tree than to crop density but was not influenced by rootstock when average fruit weight was adjusted for crop load. More recently, Marini et al. (2002) used crop density or number of fruit per tree as a covariate to evaluate the genuine effect of rootstock on average fruit weight and to determine if a given rootstock can carry a larger crop without detrimentally affecting fruit size. Their results, however, were inconclusive due to a relatively narrow range of crop density.

2. Flower and Fruit Thinning. Apple trees normally bear an abundance of flowers and thinning practices are necessary to maximize crop value and tree performance. The tendency of fruit trees to over-crop is well recognized and there is need for effective methods of regulation of fruitfulness with a number of advantages, of which two are particularly important: (1) decreasing yield, thereby increasing mean fruit weight and acceptable market quality (Fletcher 1932; Singh 1948b; Southwick and Weeks 1949; Preston 1954; Barlow 1964; Quinlan and Preston 1968; Avery 1969; Hansen 1969; Forshey and Elfving 1977; Palmer et al. 1997); and (2) overcoming inhibition of flower bud induction, hence achieving improved return bloom and consistent annual yields (Buban and Faust 1982; Monselise and Goldschmidt 1982; Tromp 2000). Reducing the number of fruit per tree inevitably increases the leaf area per fruit, resulting in increased availability of assimilates to the remaining fruit. Typically, the increase in fruit size that can be achieved from thinning is, however, smaller than the resulting reduction in fruit numbers (Hansen 1970a; Forshey and Elfving 1977; Wünsche et al. 2000). Nevertheless, most apple producers endeavor to reduce the number of fruit on a tree using either a range of exogenously applied compounds, including hor-

mone-type plant growth regulators, at bloom and/or fruitlet stage, or a combination of both chemical and hand-thinning methods. The physiological response to thinning chemicals is beyond the scope of this review and the reader may refer to Williams (1979), Byers and Carbaugh (1991), Byers (2003), and Greene (2003).

IV. FACTORS AFFECTED BY CROP LOAD

Rom (1994) emphasized that balancing vegetative growth and cropping should be in the front of the fruit grower's mind when managing orchards. Because of the complex plant \times environment \times crop management interaction, the impact of crop load on tree and fruit growth and quality should be viewed in the context of several variables.

A. Vegetative Response

1. Shoots. Fruiting reduces shoot growth, and practices such as deblossoming or defruiting increase shoot growth (Singh 1948b; Maggs 1963; Barlow 1964, 1966; Fulford 1965; Preston 1968b; Quinlan and Preston 1968; Avery 1969, 1970; Hansen 1971c; Verheij 1972; Klossowski 1976; Cripps 1981; Forshey 1982; Taylor and Ferree 1984; Erf and Proctor 1987; Wünsche and Palmer 1997a). These reports, however, do not provide clear evidence on whether crop load affects total shoot growth per tree, as a function of the number of actively growing shoots and/or mean shoot length, and whether shoot growth may be positively, negatively or not correlated with fruiting in the same season (Forshey and Elving 1989). Current season shoot growth may also be reduced when the tree carried a heavy crop load in the previous season (Wilcox 1937; Mochizuki 1962; Barlow 1975; Forshey 1982), although this influence may be reduced with increasing tree vigor (Rogers and Booth 1964).

Wünsche and Palmer (1997a) investigated a range of 'Braeburn'/'M.26' tree growth responses to various crop load levels and found that non-fruiting trees compared to heavily fruiting trees had significantly longer (31 vs. 49 cm) and thicker diameter (5.5 vs. 7.8 mm) shoots. They concluded that these differences were due to a compensatory growth response of trees with lower fruit numbers. Therefore, at the early growth stage, trees with low and in particular no crop loads must have partitioned proportionally larger amounts of photosynthate into these alternative vegetative sinks. In contrast, the reduced canopy development in fruiting trees is associated with competition between developing fruit and vegetative organs for available photosynthate.

2. Leaves

Leaf Area. Because of the effect of fruiting on total shoot growth, one may expect a similar effect on total tree leaf area, as both are closely related. While Palmer (1992), Palmer et al. (1997) and Wibbe et al. (1993) found no effect of fruiting on whole-canopy leaf area, a number of authors (Hansen 1978; Lenz and Siebertz 1980; Fujii and Kennedy 1985; Kennedy and Fujii, 1986; Lenz 1986; Schupp et al. 1992; Panthachod 1996) reported significantly greater leaf areas for nonfruiting than fruiting apple trees. Similar effects of fruiting on leaf area and shoot growth have been found in other fruit crops, e.g., grape (Petrie et al. 2000), citrus (Lenz and Döring 1975), and pistachio (Barone et al. 1995). Wünsche et al. (2000) reported that heavily cropping 'Braeburn' trees on 'M.26' rootstock had 67% less leaf area than deblossomed trees. This reduction corresponded well with a concomitant decline in percent tree light interception, as was shown previously by Wünsche et al. (1996). These results again indicate that the leaf canopy is an alternative sink for carbohydrates in the absence of fruit. McArtney et al. (1996) demonstrated that thinning 4 weeks after full bloom (AFB) resulted in a 17% decrease in whole-canopy leaf area of 'Royal Gala'/'Mark' trees compared to thinning at full bloom, whereas 'Braeburn'/'M.26' trees showed a decline in leaf area per tree from full bloom to 8 weeks AFB by approximately 6% for each 4-week period.

While cropping may reduce total shoot leaf area per tree by reducing shoot numbers without affecting mean shoot leaf area, spur leaf number per tree may be increased but mean area per spur leaf is reduced (Forshey and Marmo 1985). In much earlier work, Singh (1948b) found that nonbearing trees carried larger spur leaves than fruiting trees.

Leaf Morphology. Changes in apple leaf morphology are associated with the photosynthetic response mechanisms to crop load (see Sections VD and E). Leaves of nonfruiting compared to fruiting trees are heavier and thicker, expressed in a greater mass per unit leaf area (MLA), reduced intercellular air volume, and increased thickness of both palisade and spongy parenchyma (Wünsche et al. 1997; Wünsche 2001). Similar differences may also be found between "on" and "off" trees of a biennial cultivar. The differences in leaf morphology between nonfruiting and fruiting trees are similar to those found between sun and shade leaves (Ghosh 1973; Skene 1974; Steitberg 1975). A greater MLA of leaves on defruited trees has also been observed in other studies in apple (Maggs 1963; Hansen 1971c, 1978; Priestley 1976; Heim et al. 1979; Rom and Barritt 1990; Witte 1994; Panthachod 1996).

The compact cell structure and low intercellular airspace of leaves on nonfruiting trees (Wünsche 2001) may be responsible for inadequate CO₂ supply to the mesophyll cells and consequently lower photosynthesis rates. Investigating the photosynthetic response to varying leaf internal CO₂ concentrations (A/C_i) could provide some useful information in this respect. Chloroplast structure (grana and thylakoid membranes) was, however, unaffected in response to crop load (Wünsche 2001).

3. Trunk and Roots. The presence of fruit leads to a greater reduction in root growth compared to the growth increment of any other vegetative part of apple trees (Singh 1948b; Mochizuki 1962; Maggs 1963; Avery 1969, 1970; Head 1969; Priestley 1970a; Hansen 1971c; Heim et al. 1979; Getachew 2000). Root growth of cropping trees may be entirely inhibited under some circumstances (Avery 1970; Dudney and Hadlow 1972).

Proportionally, trunks of all the vegetative plant organs are least affected by cropping (Wilcox 1937; Singh 1948b; Mochizuki 1962; Barlow 1964; Preston 1968a, 1969; Quinlan and Preston 1968; Erf and Proctor 1987), where crop load effects on trunk enlargement have been measured within the same year. Wünsche (2001) reported greater seasonal TCA increments in nonfruiting 'Braeburn' trees on rootstock 'M.26' compared to heavily fruiting trees (3.6 vs. 1.3 cm²).

B. Reproductive Response

1. Flower Formation

Transition from Vegetative to Floral Development. The effect of cropping on return bloom and flowering behavior is widely documented and, in general, heavy crop load (particularly on biennial cultivars) delays, decreases or inhibits flower initiation, lowering the number of functional flowers the following spring (Davis 1957; Fulford 1965; Tromp 1968; Williams and Edgerton 1974; Williams 1981; Buban and Faust 1982; Monselise and Goldschmidt 1982; Palmer 1992). Regular flowering and cropping seems possible when there is a considerable proportion of "resting" spurs in the tree, i.e., nonfruiting spur clusters (S. J. McArtney, pers. commun.).

Fruit load must be adjusted as early as possible following bloom for thinning to be an effective measure for achieving adequate flower bud differentiation and regular cropping in apple. As early as 1916, Bedford and Pickering showed that alternate bearing could be controlled by hand-thinning at bloom stage instead of fruitlet thinning 6–8 weeks

AFB. Singh (1948a) reviewed several experiments and came to a similar conclusion, finding that thinning apple fruit later than 30 DAFB seldom controlled alternate bearing. Delaying post-bloom thinning for more than one month has a deleterious effect on the percentage of spurs forming flowers in the following year (Harley et al. 1942; Jonkers 1979; Williams 1981). More recently, McArtney et al. (1996) suggested that time but not level of hand-thinning affected spur quality (king flower receptacle diameter) of 'Braeburn'/'M.26' trees in the subsequent season, although crop loads were all well below commercial cropping levels. Investigating effects of various source/sink ratios on 'Granny Smith' and 'Golden Delicious' trees, Bhambota et al. (1969) found no flower bud formation at a leaf/fruit ratio below 10, but the number of flower buds was increased progressively by increasing the ratio from 20 to 50. Similar findings were made by Davis (1957), Jonkers (1979), and Monselise and Goldschmidt (1982).

All these results may be related to a carbohydrate-induced inhibitory effect of source (leaf area) limitation on flower bud formation, as some studies on early leaf removal and branch girdling have shown (Harley et al. 1932; Hansen 1969). Although the carbohydrate requirement for flower bud formation may be small compared with that of fruit sinks, the proportion of carbohydrates available for bud development may be limited in heavy cropping trees with relatively low source/sink ratios. This may particularly be the case in early season when the specific cost of fruit growth is relatively high due to the start of accumulation of energy-expensive metabolites such as starch and lipids (Walton et al. 1999). Insufficient nutrient supply for bud differentiation due to late fruit harvest has also been suggested as a causal factor for inhibition of bud development (Childers 1978).

Plant hormones have also been implicated in inhibition of flowering at relatively high crop loads with high fruit/leaf ratios. The rich sources of gibberellins (GAs) in apple seeds and their translocation into the plant can inhibit the formation of flowers for the following season (Dennis and Edgerton 1962; Fulford 1966a; Chan and Cain 1967; Luckwill et al. 1969; Sachs 1977; Grochowska and Karaszewska 1978; Hoad 1978; Looney and Kamienska 1978; Buban and Faust 1982; Grochowska et al. 1984; Lavee 1989; Bangerth 1993, 2000; Neilsen and Dennis 2000). For example, Chan and Cain (1967) and Neilsen and Dennis (2000) showed that parthenocarpic fruit, in contrast to seeded fruit, did not inhibit flower development and concluded that the effect of seed on return bloom was a hormonally regulated mechanism. Similar findings have been made in citrus (Goldschmidt and Monselise 1972), mango (Kachru et al. 1971), and pistachio (Crane et al. 1976).

The use of bloom or post-bloom thinning chemicals for the early removal of flowers/fruitlets to reduce competition for available photosynthate and to favor flower initiation for the next year's crop is an effective tool for overcoming biennial bearing (Link 1986; Byers et al. 1990; McArtney 1994; Schumacher and Stadler 1994). Plant bioregulators such as GA₃ applied during flower bud initiation in the "off"-year to reduce excessive flowering in the subsequent "on"-year, or the use of GA-synthesis inhibiting substances in the "on"-year, thereby achieving adequate flowering in the "off"-year, have had variable success (Luckwill 1970; Das et al. 1989; Schumacher et al. 1989; Ravishankar et al. 1990; Rademacher 1991; El-Kassas et al. 1994; McArtney 1994; McArtney and Li 1998).

Flower Morphology. Results indicating a crop load-induced inhibition of flowering are in conformity with the concept that biennial cultivars with a heavy fruit load will lengthen the plastochron in developing buds to such an extent that floral primordia will fail to develop (Fulford 1966b; Abbott 1977). Moreover, McLaughlin and Greene (1991) found that from 7 DAFB onwards, the number of appendages remained greater in spurs on deblossomed limbs than in spurs on fruiting limbs of the biennial bearing cultivar 'Baldwin', although appendage initiation progressed at a similar rate. In contrast, the number and rate of appendage formation on spurs in the annually bearing cultivar 'Delicious' was similar regardless of limb fruit load.

Williams (1970b) reported that both ovule longevity and the effective pollination period (EPP) of flowers are shorter in an "off"-year compared to flowers on cropping trees. More recently, Buszard and Schwabe (1995) found that heavily cropping 27-year-old 'Cox's Orange Pippin' apple trees on rootstock 'M.9' had fewer numbers of flower clusters per tree, smaller flowers (pedicel length, peduncle length, receptacle diameter), a shorter EPP, and lower initial fruit set in the subsequent spring than trees that were defruited in the previous season. They further noticed that the stigmas of the flowers of trees with a heavy crop load in the previous season had collapsed papillae. This confirmed earlier results by Schwabe (1978) that a heavy crop load in one season caused smaller flower buds in the following season. These results therefore provide some physiological reason for poor fruit set characteristics of apple flowers after heavy cropping in the previous season.

2. Fruit Development. Whilst fruit size can be optimized by crop load adjustment, there is a compromise necessary with yield, since practices such as thinning reduce yields. A relatively low crop load level will

elicit the genetically determined size potential of the cultivar and the varietal maximum fruit size response to thinning. For small-fruited cultivars, early thinning will be beneficial to increasing mean fruit size. Hence, if fruitlet numbers per tree were adjusted chemically or by hand soon after bloom rather than at a later developmental stage, higher cropping levels may be possible without reducing mean fruit size at harvest. For large-fruited cultivars, however, early thinning may result in a large amount of oversized fruit at harvest and adjustments of the tree crop load level may, consequently, be delayed in order to reduce fruit size. This, however, needs to be balanced against the effect of fruiting on return bloom for a biennial cultivar, e.g., the earlier the final fruit number is established for the large-fruited 'Pacific Rose' cultivar, the higher the percentage of return bloom (S. J. McCartney, pers. commun.). Nevertheless, effective thinning treatments may impart a considerable shift in the proportion of harvested crop from small to large fruit (Link 2000).

Fruit Drop. Wünsche and Palmer (1997a) reported that flower thinning by hand at different severities resulted in an initial crop load of 540, 310, and 180 fruit per tree, although final fruit numbers of 340, 260, and 160 per tree were recorded at harvest. Fruit drop is therefore very dependent on crop density and may indicate a shortage of carbohydrate supply for fruit growth, particularly at higher crop loads, during the early developmental stage. It is interesting that treatment differences in harvest yield were smaller than those in fruit number and this was attributable to larger fruit weights and higher percent of fruit dry matter with increasingly lower crop densities.

Fruit Growth. Since apple fruit are a major sink for carbon resources, the rate of fruit growth in healthy, well-maintained trees depends primarily on crop load (e.g., Fletcher 1932; Southwick and Weeks 1949; Quinlan and Preston 1968; Hansen 1969; Forshey and Elfving 1977; Palmer et al. 1997), but also on flowering time and flower position on the tree and within the spur (Callesen 1988; Ferree et al. 2000). The growth rate of the developing fruit depends not only on whole tree assimilate production but also on how successfully it can compete with other sinks (see Section IIIA).

Fruit size at harvest can be viewed as the result of a combination of cell number, determined during the early developmental stage of cell division, cell size, and volume of intercellular air space (Goffinet et al. 1995). This was postulated by Bain and Robertson (1951) and Pearson and Robertson (1953), when they stated that cell number and, to some extent, mean cell size and the amount of air space determine the varia-

tion in fruit size at harvest. As discussed above, high crop densities during the early growth period of fruit cell division may cause a deficit in carbohydrate availability to the developing fruit that ultimately can lead to decreased fruit growth rate and reduced final fruit size (see Lakso 1994). Increased carbohydrate supply under light cropping results in increased rates of fruit growth and greater weight of individual fruit with higher soluble carbohydrate levels (Klages et al. 2001; Greer et al. 2002). Lakso et al. (1995) showed that under non-limiting growth conditions (low crop competition), fruit growth followed an early positive curvilinear phase followed by linear growth to harvest.

The effect of crop load on fruit growth and size in apple is well documented (Assaf et al. 1982; Erf and Proctor 1987; Forshey and Elfving 1989; Koike et al. 1990; Jones et al. 1997; Palmer et al. 1997; Wünsche et al. 2000). Fruit weight at harvest is typically negatively correlated with crop load, and fruit weight is largest when there is minimum fruit to fruit competition, i.e., high leaf area per fruit ratio (Shen 1941; Hansen 1969; Palmer et al. 1997). For example, flower thinning of 'Braeburn' trees at different severities resulted in 50% heavier fruit in the low cropping trees compared to the high cropping trees (e.g., Wünsche and Palmer 1997a; Wünsche et al. 2000). In a 'Fuji' crop load trial using 'M.9', 'M.26', and 'MM.106' rootstocks, data from two seasons indicated that flower thinning to establish four cropping levels, not surprisingly, had a significant effect on mean fruit weight at harvest, numbers of fruit, and yield per tree (J. N. Wünsche and J. W. Palmer, unpubl. data). In both years, fruit numbers per tree across the three rootstocks increased five-fold from the light to the heavy cropping trees while mean fruit weight was 55% larger on the light cropping trees. While there was a clear rootstock effect on yield and fruit number per tree for each crop load, this was not translated into a significant effect on mean fruit weight. Crop load in the year before thinning may also be a source of fruit size variation since, for example, heavy cropping in the previous season reduces the cell number in flower receptacles when compared to those in trees with moderate crop loads (Bergh 1985; Buszard and Schwabe 1995).

Timing and severity of thinning has a marked influence on fruit size. Greater proportions of adequate fruit sizes can be achieved with early crop load adjustment (Harley et al. 1932, 1942; Singh 1948a; Preston 1954; Denne 1960; Westwood et al. 1967; Quinlan and Preston 1968; Silbereisen 1976; Bergh 1990; Johnson 1992, 1994; Wünsche et al. 2000), often before the intensity and duration of the unpredictable natural fruit drop are known. In fruit growth studies on 'Empire' apples, Goffinet et al. (1995) found that the earlier trees were thinned, the greater the

increase in final fruit size, this being closely associated with variation in cell numbers in the cortex rather than cell volume. Similarly, thinning trials done by Link (2000) indicated that mean fruit size was increased by up to 30% when crop densities were established between pink bud and full bloom when compared to after “June” drop (Northern hemisphere). Blossom thinning increased cell number by 5–35% and cell size by 4–10% when compared to unthinned controls. To separate the effects of time and level of thinning on fruit size at harvest, McArtney et al. (1996) found that reducing the number of fruit per TCA had a positive linear effect on mean fruit weight at harvest for both ‘Royal Gala’/‘Mark’ and ‘Braeburn’/‘M.26’ trees. The relationship was clearly affected by time of thinning, giving significantly larger fruit sizes when both cultivars were thinned at full bloom instead of 8 weeks AFB.

C. Fruit Attributes

Crop load has a number of consequences in terms of quality attributes of fruit. It has been pointed out previously (Link 2000) that thinning treatments which result in light crop loads provide fruit that have on the one hand favorable characteristics such as advanced maturity, yet on the other hand, such fruit may store less well due to lower calcium (Ca) levels in the fruit and higher predisposition to specific storage disorders. Thus, there is a conflict in matching a desire to optimize cropping and at-harvest qualities with orchard practices that are best for optimal storage behavior of the fruit.

1. At-harvest Quality. There are few studies that have been specifically designed to investigate the effects of crop load on fruit quality. However, investigation of the effects of thinning agents such as benzyladenine (BA), thidiazuron, or CPPU show consistent results; fruit from light crops almost always have greater average fruit weight, greater firmness, and higher soluble solids concentration (SSC) at harvest (e.g., with ‘McIntosh’ apples, Greene 1989, 1995; Elfving and Cline 1993). The larger fruit from such treatments also have lower Ca concentrations (Greene et al. 1992), and despite the greater at-harvest firmness, do not store well (e.g., Greene and Autio 1989). While other studies also have reported an increase in fruit firmness with lower crop loads (Johnson 1992, 1994; Opara et al. 1997; Tough et al. 1998), the underlying principles for this are not well understood but are likely to be related to the increase in soluble solids and dry matter. Fruit from light cropping trees, which had greater cell numbers or turgor, would also give higher firmness measurements. These firmness differences were retained after

storage (Tough et al. 1998), although in the work of Johnson (1994) this was only for fruit held in CA, not for those in air storage. In the latter case, there was an increased rate of softening in fruit from light cropping trees, perhaps associated with advanced maturity at harvest.

The other common feature resulting from cropping differences is an advance in fruit maturity with light loads. Effects of crop load on fruit maturity were noted, for example, by Sharples (1968) for 'Cox's Orange Pippin', Palmer et al. (1997), Kelner et al. (2000), and Wünsche et al. (2000) for 'Braeburn' apples, and by Bound and Jones (1997) and Bound (2001) for 'Delicious' fruit from trees thinned with BA and the aquatic herbicide endothal. Typically, advanced maturity in lighter cropping trees is indicated by higher ethylene concentration (Francesconi et al. 1996), a more yellow background color, greater starch conversion, and higher percent of soluble solids in the flesh juice.

Such maturity differences will contribute to and often explain different storage behavior. Advancement of maturity with light crop loads has also been found with 'Starkrimson Delicious' fruit, including higher levels of watercore at harvest (Francesconi et al. 1996). These differences were maintained during storage, where fruit from light cropping trees had higher levels of both watercore and internal breakdown after four months storage. Fruit Ca concentrations were also shown to increase with increasing crop load. Higher levels of breakdown in storage were found in 'Starkspur Golden Delicious' fruit from light cropping trees, attributed to the greater fruit size and higher concentrations of phosphorus (P) and nitrogen (N) in the fruit (Fallahi et al. 1984).

The relatively high soluble carbohydrate content of fruit from light cropping trees may have an impact on later quality, particularly being a positive factor in terms of consumer acceptance of fruit. Fruit well supplied with carbohydrates attain good color and flavor (Walter 1967). In accordance with this, thinning to lower fruit loads reduces the percentage of under-colored fruit by increasing background color and surface blush (Link 2000). The improvements in fruit size and color by thinning are often associated with higher contents of soluble solids and titratable acidity. Thinning may therefore improve taste and appearance of the fruit (Schumacher and Stadler 1987).

2. Postharvest Quality. In a cultivar such as 'Cox's Orange Pippin', there is a very clear relationship between crop load and the incidence of the disorder bitter pit: relatively low crop loads have been associated with higher incidence of bitter pit (Ferguson and Watkins 1989, 1992; Volz et al. 1993). The reasons for this effect probably lie in the associated differences in mineral contents of the fruit. In the studies on 'Cox's Orange

Pippin' fruit, Ca concentrations of the fruit flesh were significantly higher in fruit from the high yielding trees, and potassium (K) concentrations significantly lower. In fruit from the low cropping trees, the opposite was the case. In both cases there was no effect of load on magnesium (Mg) concentrations. This was also observed in an earlier study (Ferguson and Triggs 1990), where the relationship between fruit Ca and fruit size differed according to crop load. In trees with high loads, the reduction in Ca concentration of the fruit with increasing fruit weight was half that found for fruit from light cropping trees. The same effects of light crop load were found regardless of whether the light cropping level was a natural one, or achieved by flower thinning (Volz et al. 1993).

These very significant effects were independent of fruit size (Fig. 5.1). This is an important observation, since light cropping trees would be expected to have larger fruit, and larger fruit are often associated with lower Ca concentrations and higher disorder incidence. However, even small fruit from low cropping trees had less Ca than fruit of the same size from high cropping trees.

Similar associations of light crop load with low fruit Ca, high K, and relatively high levels of bitter pit have been found in other studies on 'Cox's Orange Pippin' fruit (Johnson 1992, 1994), and with 'Gala' (Wojcik et al. 2001), 'Braeburn' (Retamales and Lepe 2000; Mpelasoka et al. 2001), and 'Starkspur Golden Delicious' (Fallahi et al. 1984, 1985) fruit, although in most of these cases, the mineral differences were related to size differences.

These results raise the question of why mineral concentrations of fruit differ with different crop loadings. It is clearly not just a consequence of fruit size. There are a number of aspects of cropping physiology that might explain this. Firstly, as mentioned before, there may be differences in growth rates of fruit (Lakso et al. 1995). Rapidly growing fruit, as may occur with a light crop where there are few limitations in terms of carbohydrate and water supply, may not only have high sugar levels but also result in lower Ca concentrations since the Ca flow is unlikely to keep up with fruit expansion.

Another reason may lie with the positioning of fruit on the tree that can be affected by crop load adjustment. A decrease in leaf area associated with the developing fruit, by reducing spur and bourse leaf numbers, results in lower Ca concentrations in a number of cultivars (Ferree and Palmer 1982; Proctor and Palmer 1991; Volz et al. 1994, 1996). The transpirational pull from these leaves is important in terms of Ca flow to the fruiting wood (Lang and Volz 1998). Any differences in leaf status of the fruiting wood as found with various crop loads may be reflected

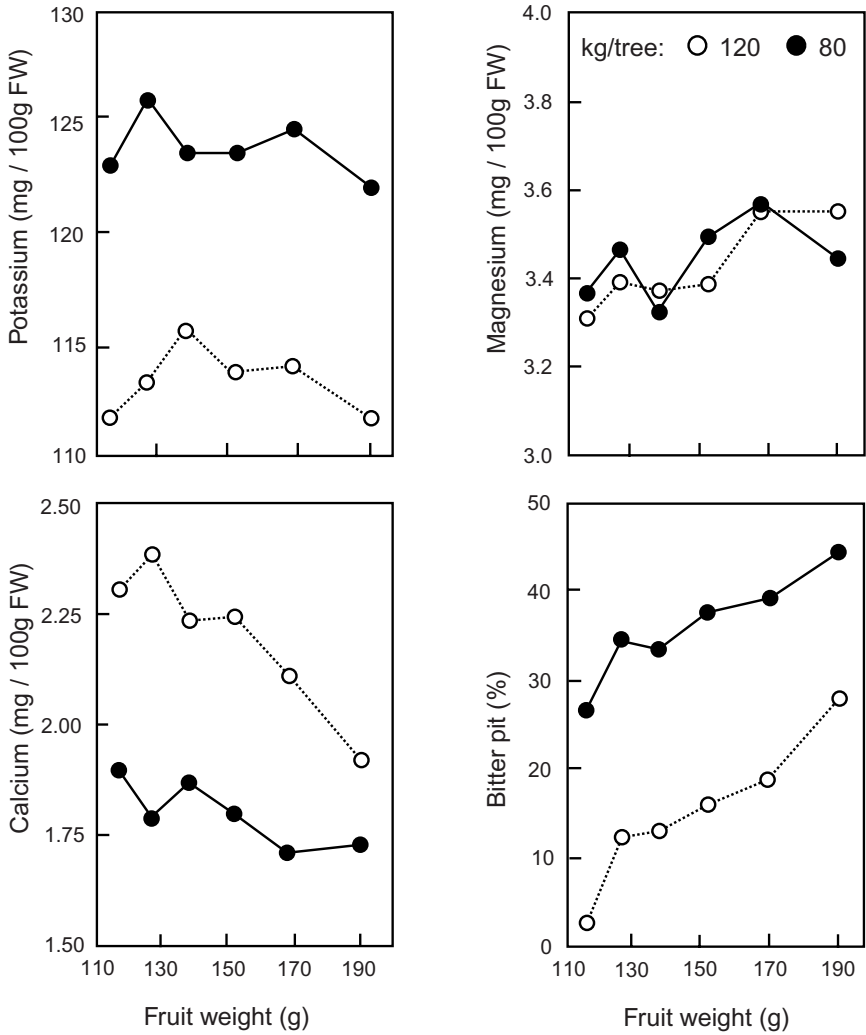

Fig. 5.1. Effects of fruiting on mineral concentration and incidence of bitter pit in 'Cox's Orange Pippin' apple fruit at harvest (redrawn from Ferguson and Watkins 1992).

in the final Ca contents of the fruit. In addition, fruit mineral contents are dependent on spur type. In a number of cultivars, fruit from terminal shoot positions had higher Ca and Mg concentrations, and that from other sites such as 1-year laterals and 2- and 3-year spurs was variable, although related to the amount of spur and bourse leaf area (Volz et al. 1994).

Thinning treatments may also result in positional effects that impact on mineral accumulation. In a study on 'Braeburn' and 'Fiesta' fruit, Volz and Ferguson (1999) showed that alternate-cluster thinning and increased fruit size reduced fruit Ca concentrations by about 20% compared with unthinned trees. However, within-cluster thinning, which also reduced load and increased fruit size, had similar fruit Ca as the unthinned controls. The reduced Ca in the former treatment was probably the result of high fruit number and low primary spur leaf area per clusters.

Thus the lower Ca concentrations in fruit from light crops are likely to be the result of fruit to shoot competition associated with more rapid fruit growth and stronger vegetative activity when compared to relatively heavy crop loads. Crop loads resulting from natural processes and artificial thinning treatments may result in different fruit qualities depending on these factors.

Light crop loads also have been associated with higher incidence of other storage disorders such as internal breakdown and coreflush in 'Cox's Orange Pippin' fruit (Johnson 1992, 1994), and internal browning, coreflush, and lenticel blotch in 'Braeburn' fruit (Tough et al. 1998; Elgar et al. 1999). Since 'Braeburn' internal browning has been linked to high CO₂ and/or low O₂ concentrations in the fruit, there was some interest in determining whether skin characteristics were part of this loading effect. However, neither skin permeance nor color, associated with exposure to high temperatures and light, were related to the disorder incidence. Further work on the same cultivar and disorder showed that when crops were adjusted to different levels through flower thinning, fruit from trees with lighter loads had lower internal O₂ and higher CO₂ concentrations, and a lower skin permeance to these gases and ethylene (Volz and Lang 2001). The reasons for the crop load effect may lie in a combination of effects on maturity and fruit exposure, as well as on water and carbon economy.

3. Consumer Preferences. Relatively light cropping usually results in fruit that are firmer, sweeter, and sometimes more highly colored, all attributes that can be positive for consumers. Thus, thinning may improve taste and appearance of the fruit (Schumacher and Stadler 1987). However, this is not always the case after storage, particularly with large fruit. When fruit from different cropping levels have been followed through storage to sensory evaluation, both 'Cox's Orange Pippin' (Johnson 1994) and 'Braeburn' (Tough et al. 1998) fruit from light crops were unacceptable in terms of textural changes, dryness, and off-flavors, suggesting that the better qualities at harvest are not always transferred to the consumer.

Compounds associated with pigmentation might be expected to change with crop load, where the effects of light loads may result in greater exposure of fruit to high light and high temperatures. Conflicting results were obtained in two studies with 'Jonagold' fruit using similar crop load differences. Awad et al. (2001) found that within a range of 50 to 200 fruit per tree (using both 'Jonagold' and 'Red Elstar' cultivars), there were no differences in concentrations of chlorogenic acids or flavonoids in the fruit, despite higher fruit weight, soluble solids, acidity, and firmness in the low crop load fruit. Stopar et al. (2002), however, found that reducing loads from 157 to 30 fruit per tree resulted in an increase in total polyphenolic concentration from 1300 to 1680 mg kg⁻¹ fruit weight, with individual increases in chlorogenic acid, 4'-p-coumaroylquinic acid, catechin, and epicatechin. Fruit from the low cropping trees also had higher soluble solids, firmness, and blush.

In addition, we would expect consumer preference attributes such as aroma volatiles to be closely related to fruit maturity and to carbohydrate metabolism, but there have been few studies on this relationship with crop load. A reduction in crop load from 6 to 4 fruit per cm² of TCA had no effect on postharvest volatile production in 'Braeburn' fruit in a lysimeter experiment (Mpelasoka and Behboudian 2002).

V. PHYSIOLOGICAL AND BIOCHEMICAL RESPONSE

A. Mineral Nutrients

The effect of crop load on composition and content of macronutrients in leaves varies in fruit crops. In apple, leaves of fruiting trees often have higher concentrations of N, Ca, Mg, but less K than those of nonfruiting trees (Shear and Faust 1970, 1980; Hansen 1973; Boon 1980a,b; Himelrick and McDuffie 1983; Stiles 1987; Schupp et al. 1992; Jadczyk and Lenz 1994; Thiebus-Käsberg and Lenz 1994; Witte 1994; Panthachod 1996; Picchioni et al. 1997; Getachew 2000). The effect of fruiting on leaf P concentration is, however, not clear, and for nutrient concentrations in apple tree organs other than the leaf, data are scarce or also lack consistency (Hansen 1971d; Lüdders and Fischer-Bölükbası 1980; Witte 1994; Panthachod 1996).

It has been suggested that high contents of carbohydrates and dry matter in leaves, as commonly seen in nonfruiting apple trees, may have a dilution effect on the nutrient concentration per unit weight of leaves (Avery et al. 1979; Lenz 1979b). There is, however, sufficient evidence showing that the transport of mineral nutrients into leaves of fruiting

trees is enhanced due to higher transpiration rates (Preston and Perring 1974; Lord et al. 1979a,b; Olszewski and Mika 1990a,b).

Getachew (2000), using a lysimeter system, found that potted 'Golden Delicious' apple trees with no crop had a greater uptake of nutrients; the permanent tree structure of nonfruiting trees accumulated 2.2 to 3.2 more N, P, K, Ca, and Mg than that of fruiting trees. This result was presumably due to the lower total biomass of fruiting trees and the fact that uptake of mineral nutrients is typically in direct proportion to total dry matter increase of vegetative tree organs, especially of roots. Similarly, Hansen (1971d, 1980) found that cropping reduced uptake of N, P, Ca, and Mg by 40–50%. Of the total uptake of nutrients by the tree, Getachew (2000) found that fruit removed 23% N, 42% P, 60% K, and 18% Mg and only 1.5% Ca. The augmented uptake of K in cropping trees was also reported by Hansen (1971d, 1980) who found that about 70% of total K was contained in fruit. The frequent finding that fruit from light cropping trees have lower Ca and higher K concentrations has been discussed in Section IVC.

B. Water Relations

1. Water Consumption. Leaf area and fruit load of tree canopies are important factors determining water consumption. Besides plant factors, climatic factors and especially high light intensity associated with high ambient temperature increase water consumption of trees (Johnson and Lakso 1986; Mager 1988; Lakso 1994). In apple, water consumption increases with leaf area (Mager 1988; Lenz 1989) and with fruit load, especially during the main fruit development period from June to September (Hansen 1971b; Lenz 1986; Panthachod 1996). Lenz (1986) reported substantially higher total water consumption of fruiting trees than deblossomed trees despite a strong reduction of whole-canopy leaf area in the presence of fruit (Fig. 5.2A). Getachew (2000), however, pointed out that the cropping effect on tree water consumption depended on whole-canopy leaf area and only fruiting trees with substantially reduced leaf areas (> 50%) consumed less water than nonfruiting trees. Fruiting increases water consumption largely through enhanced transpiration rates per unit area of leaf (*see* Section VD) and through fruit transpiration. Lüdders and Fischer-Bölükbası (1979) and El-Sayed and Lüdders (1984) reported a higher transpiration coefficient (total water consumption per total dry matter) in fruiting than in nonfruiting apple trees. By contrast, lower transpiration coefficients with increased fruit load were reported for the apple cultivars 'Cox's Orange

Pippin' (Ohme and Lüdders 1983) and 'Golden Delicious' (Lenz 1989), eggplant (Lenz 1970), and citrus (Lenz and Döring 1975).

2. Water Potential. Compared with nonfruiting trees, fruiting apple trees have lower leaf water potential (Erf and Proctor 1987), and Naor et al. (1997) found that midday stem water potential decreased with crop load. The results indicate that reduced shoot growth on heavily cropping trees (see Section IVA) may be related to lower plant water potential caused by loss of turgor since shoot tips, unlike leaves, do not adjust osmotically.

C. Carbon Production and Partitioning

1. Dry Matter. The effect of crop load on dry matter production and allocation to plant organs has been extensively studied for a range of fruit crops, including apple (Maggs 1963; Avery 1969, 1970; Forshey and McKee 1970; Quinlan and Preston 1971; Lenz 1979a, 1986; Hansen 1980; Forshey et al. 1983; Koike et al. 1990; Strong and Miller-Azarenko 1991; Buwalda and Lenz 1992; Palmer 1992; Witte 1994; Panthachod 1996; Getachew 2000), peach (Miller and Walsh 1988), sweet cherry (Kappel 1991), mandarin (Goldschmidt and Golomb 1982), and strawberry (Forney and Breen 1985).

In general, cropping trees accumulate greater amounts of total seasonal dry matter than nonfruiting trees, despite significantly reduced leaf area, shoot extension, and root growth, and thus less carbon sequestered into vegetative biomass (Chandler and Heinicke 1926; Avery 1970; Hansen 1971c; Heim et al. 1979; Lenz 1979a, 1986; Palmer 1992; Panthachod 1996). The greater efficiency of total dry matter produced per unit area of leaf in the presence of fruit was first observed in the early part of the 20th century by Harley (1925), Chandler and Heinicke (1926), who reported up to 71% greater dry matter fixation for cropping vs. deblossomed trees, and by Chandler (1934), and has been confirmed in later studies (e.g., Mochizuki 1962; Maggs 1963, 1964; Avery 1969, 1975; Hansen 1969, 1971a,c, 1977a; Priestley 1970a; Verheij 1972). Palmer (1992) showed that the efficiency of converting intercepted photosynthetic active radiation (PAR) to dry matter energy equivalents was 3.3% in trees with a heavy crop load and 1.8% noncropping trees. The cropping-induced reduction in growth and dry matter content of vegetative plant parts appears to be a common phenomenon in apple and occurs irrespective of climatic differences, rootstock vigor, and tree pruning and training methods (Forshey and Elfving 1989). As will be discussed later

(Section VD), the increased total biomass production per unit area of leaf in fruit bearing apple trees can be attributed to higher photosynthetic leaf efficiency.

Lenz (1986), for example, convincingly showed that dry matter of vegetative organs was significantly reduced in fruiting 'Golden Delicious' apple trees on 'M.9' rootstock when compared to deblossomed trees over a 2-year observation period. Dry matter was reduced by 57% in leaves, 52% in shoots, and 69% in roots (Fig. 5.2B). Despite the lower dry matter in vegetative organs, total dry matter production of the fruiting trees was approximately 65% greater, due to the 66% of total dry matter accumulated in fruit. Getachew (2000) also reported that apple fruit could accumulate between 60–70% of total dry weight, indicating that fruit is a strong sink, which can compete successfully with vegetative organs of the tree for photosynthetic products. Again for 'Golden Delicious' but on 'M.4' rootstock, cropping trees had a 10% higher seasonal dry matter increment but a nearly 70% reduced dry matter allocation to vegetative organs (Hansen 1971d, 1980).

In contrast, Maggs (1963) and Avery (1969) reported that cropping did not increase total dry matter, but these studies were carried out on potted apple trees with a relatively low crop load. In other fruit species, Petrie et al. (2000) found that fruiting grapevines sequestered more car-

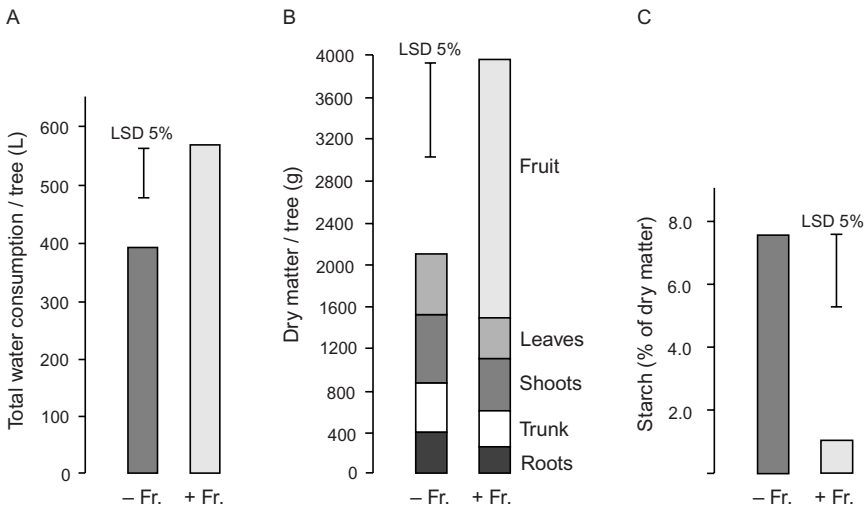

Fig. 5.2. Effects of fruiting on tree water consumption (A), dry matter partitioning into plant organs (B), and leaf starch accumulation (C). (Redrawn from Lenz 1986.)

bon into shoot biomass than nonfruiting vines and similar findings were observed in strawberry (Hancock and Cameron 1986) and cucumber (Janoudi and Withers 1993).

2. Carbohydrates

Leaves. Greater amounts of carbohydrates, in particular starch, have been shown to be retained in leaves on trees with reduced crop loads (Fig. 5.2C) and in some cases leaf starch concentration has been negatively correlated with crop load (Kazarjan et al. 1965; Hansen 1967; Grochowska 1973; Siebertz and Lenz 1982; Lenz 1986; Schupp et al. 1992; Thiebus-Käsberg and Lenz 1994; Wibbe and Blanke 1995; Panthachod 1996; Wünsche et al. 2000). Similar crop load effects on leaf carbohydrate concentration have been established for peach (Nii 1993, 1997; Grossman and DeJong 1995a,b), citrus (Lenz and Küntzel 1974; Goldschmidt and Golomb 1982; Haggag et al. 1995), pistachio (Crane and Al-Shalan 1976), pecan (Wood and McMeans 1981), and eggplant and strawberry (Hoffmann and Lenz 1974).

In apple, Wünsche et al. (2000) provided evidence that leaf starch concentration of 'Braeburn' apple trees was linearly and negatively related to crop load in mid-season at 135 DAFB. Although leaf MLA increased by 2.2 mg cm⁻², starch per unit leaf area increased by only 0.8 mg cm⁻², indicating that, besides starch, other products must have been accumulating in the leaves. The recovered photosynthetic rates of apple leaves in late season and especially after harvest are presumably due to the degradation of starch when sink-source ratios increase with root growth, bud differentiation, and exhausted carbohydrate reserve pools needing to be replenished.

The influence of crop load on soluble carbohydrates in apple and other fruit crops is not yet clear. While Panthachod (1996) reported indistinct differences in leaf soluble sugar concentration between fruiting and nonfruiting apple trees, Wünsche (2001) found that fructose, glucose, and sorbitol concentrations were all significantly increased in leaves of noncropping 'Braeburn' trees compared to trees with high crop loads (450 fruit per tree) at 145 DAFB in late-season. Increased leaf sucrose concentrations were found, however, in fruiting trees. Lower leaf soluble carbohydrates were also reported in fruiting vs. nonfruiting eggplants (Hoffmann and Lenz 1974) and "on" vs. "off" mandarin trees (Goldschmidt and Golomb 1982; Haggag et al. 1995).

Apple leaf carbohydrates show distinct diurnal changes with peak concentrations for sucrose at midday, followed by sorbitol and then starch in late afternoon (Chong 1971; Chong and Taper 1971; Wang et

al. 1997). High cropping trees appear to have much more distinct carbohydrate patterns than noncropping trees where leaf sorbitol, sucrose, and starch accumulate during the day and decline at night in mid-season (Klages et al. 2001). Similar diurnal changes in leaf carbohydrate concentrations for apple were reported by Hansen (1967). Klages et al. (2001) further found that average daily leaf starch concentration as a percentage of total non-structural carbohydrates increased from 10 to 50% with decreasing crop load. In contrast, glucose, fructose, and myo-inositol concentrations in leaves neither responded to crop load nor followed a diurnal pattern, and they represented together around 8–13% of the total non-structural carbohydrate fraction.

Woody Tissue. The effect of crop load on starch accumulation in plant organs other than leaves is not equivocal for all fruit tree species. While Goldschmidt and Golomb (1982) found increased starch contents in various permanent plant parts with decreasing crop load of mandarin, Crane et al. (1976) showed that starch contents in the bark and wood of pistachio were not significantly different between nut-bearing and non-bearing branches. In apple, cropping reduces starch in the permanent tree structure (Priestley 1970b; Grochowska 1973) and in roots (Lenz and Siebertz 1980). Getachew (2000) reported that both concentrations and content of starch were significantly higher in all vegetative tree parts (leaves, shoots, branches, trunk, roots) of nonfruiting ‘Golden Delicious’ trees, grown in lysimeters, as compared to fruiting trees.

Total content, but not concentrations of sorbitol, glucose, and fructose, have been shown to increase significantly in most vegetative organs of nonfruiting ‘Golden Delicious’ apple trees compared to their fruiting counterparts (Getachew 2000). In contrast, increased sucrose concentration was noted in all vegetative parts of fruiting apple trees in autumn, although total sucrose content was again higher in nonfruiting trees. Priestley (1970b) found that cropping brought about a consistent reduction of starch and sugar content in the trunk of three apple cultivars. In agreement with those results, crop load did not significantly affect soluble sugar concentration in bark and wood of bearing and nonbearing pistachio branches throughout the growing season (Crane and Al-Shalan 1976; Crane et al. 1976) and in leaves of fruiting and nonfruiting strawberry plants (Hoffmann and Lenz 1974). In contrast, Goldschmidt and Golomb (1982) found considerably lower soluble sugar concentration in woody plant parts of mandarin trees in the “on” year.

Fruiting reduces the concentration and content of total carbohydrates in most vegetative plant organs of apple (Priestley 1964; Head 1969;

Hansen 1970b; Priestley 1970b; Monselise and Lenz 1980b; Getachew 2000). As discussed before, the accumulated total carbohydrate reserves in “off” trees or in trees with relatively low crop load could be presumably associated with a concomitant increase in flower formation and greater fruit set in the subsequent “on” year. Apart from crop-specific source:sink relations, carbohydrate reserve pools (Oliveira and Priestley 1988) and the seasonal pattern of sugar translocation may explain the ambiguous results in the literature concerning crop load effects on carbohydrate concentration in different plant parts.

Fruit. The amount of sorbitol and sucrose in phloem exudates from fruit is considerably greater in trees with a relatively light crop compared to high cropping trees, with sorbitol comprising 63–75% and sucrose 25–35% of total sugars collected (Klages et al. 2001). Carbohydrate concentrations in both phloem exudates and fruit showed little diurnal variation and were independent of crop load in mid-season. However, concentration differences in fruit were significantly higher for starch but lower for glucose in fruit from low cropping trees compared to high cropping trees. These differences may be due to crop load-dependent fruit maturity properties that would affect the carbohydrate metabolism of the fruit.

Klages et al. (2001) showed that sucrose phosphate synthase (SPS) activity was affected by time of day and crop load, with highest activities in fruit of high cropping trees at night and of low cropping trees in the morning. SPS activity per gram fruit fresh weight, however, was consistently higher in fruit from trees with high crop loads, whereas sucrose synthase (SS) activity showed little difference between crop loads. A positive correlation between starch accumulation and SS activity as a possible marker for sink strength has been previously reported (Wang et al. 1993; Zrenner et al. 1995; Ho 1996) but was not confirmed in the study of Klages et al. (2001). In summary, the greater weight of individual fruit from low cropping trees may be due to greater availability of carbohydrate supply from source leaves per fruit rather than greater metabolic activity of the fruit sink per se.

Whole Tree. At the whole tree level, total carbohydrate content is typically higher in fruiting apple trees than in nonfruiting trees, although total starch and sorbitol contents are considerably less in cropping trees (Getachew 2000; J. N. Wünsche and J. W. Palmer, unpubl. data). Strong accumulation of sucrose, glucose, and fructose in fruit was accountable for the higher total carbohydrate content in fruiting trees.

D. Gas Exchange Characteristics

1. Leaf. There does not seem to be a large genetic variation in leaf carbon assimilation rate of apple (Flore and Lakso 1989), but the magnitude of seasonal leaf photosynthesis is dependent on the developmental stage of the tree, environmental conditions, and cultural practices, of which fruit load is the most important. Light saturated leaf net carbon exchange rates (NCER) of apple show a typical seasonal pattern with increasing rates from bloom until approximately 60 DAFB, when canopy leaf area is still developing and expanding, followed by relatively constant rates until fruit harvest and thereafter a decline in photosynthetic leaf rates.

Photosynthetic Response. Previous studies investigating the effect of fruit on photosynthesis, partitioning of assimilates, and dry matter accumulation have shown higher leaf photosynthetic efficiencies and transpiration rates in fruiting than in nonfruiting apple trees (Maggs 1963; Avery 1975; Avery et al. 1979; Heim et al. 1979; Monselise and Lenz 1980a; Fujii and Kennedy 1985; Lenz 1986; Palmer 1986; Ebert and Lenz 1991; Masarovicova and Navara 1994; Schechter et al. 1994a,b; Gucci et al. 1995). The effect of fruiting on leaf carbon assimilation and water loss is, however, not consistent for all fruit crops; e.g., similar leaf NCER were reported for fruiting vs. nonfruiting mandarin (Monselise et al. 1986), sweet cherry (Sams and Flore 1983; Roper et al. 1988), grape (Chaumont et al. 1994), and strawberries (Sruamsiri and Lenz 1985), whereas leaf NCER was enhanced, at least during maximum seasonal carbohydrate demands of fruit sinks, in peach (DeJong 1986). Some results from apple (Hansen 1970b; Proctor et al. 1976; Rom and Ferree 1986; Schechter et al. 1994a) also indicate surprisingly little effect of fruit on photosynthesis. Palmer (1986, 1992) extended the fruiting and nonfruiting approach for apple by attempting to determine the shape of the photosynthetic response curve to a range of apple crop loads of 'Golden Delicious'/'M.9' and 'Crispin'/'M.27' trees, but was unable to define the relationship clearly. Significant differences in leaf carbon assimilation rates among cropping levels were only found during maximum fruit dry weight increase (Palmer 1992). Under the prevailing climatic conditions of New Zealand, Palmer et al. (1997) provided clear evidence that leaf assimilation rate was positively and curvilinearly related to crop load (Fig. 5.3A).

Watson et al. (1978) investigated the effect of fruiting on respiratory loss of fixed carbon and found greater leaf dark respiration on defruited trees. In contrast, photorespiration does not seem to be affected by the

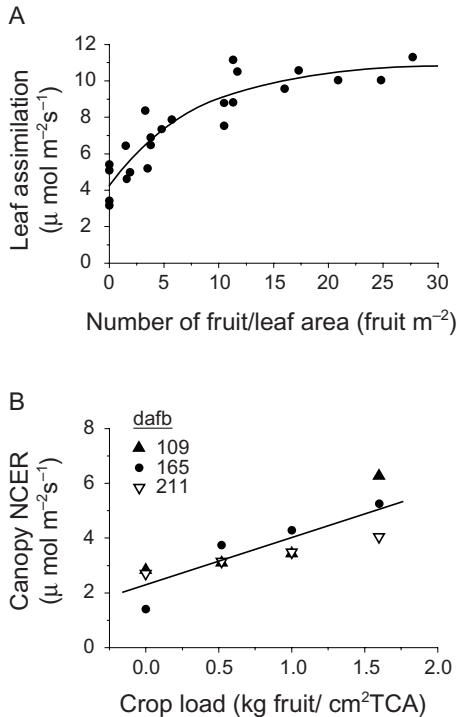

Fig. 5.3. Effect of crop load on mean leaf carbon assimilation rate (A) (Palmer et al. 1997) and whole canopy net carbon exchange per unit area of leaf (B) (Wünsche et al. 2000) of 'Braeburn'/'M.26' apple trees.

presence or absence of fruit (Monselise and Lenz 1980b; Fujii and Kennedy 1985; Kennedy and Fujii 1986).

Seasonal Changes. In the early part of the growing season, leaf NCER does not seem to be affected by crop load, irrespective of fruiting levels (Palmer et al. 1997; Wünsche 2001). In mid-season, apple leaf NCER decreases as crop load is reduced (Giuliani et al. 1997a; Palmer et al. 1997; Wünsche and Palmer 1997a; Wünsche et al. 2000), although the most significant differences are typically observed between fruiting and nonfruiting apple trees. Palmer et al. (1997) and Wünsche et al. (2000) showed the largest leaf photosynthetic decline of 35–60% to occur in mid-season between 75 and 150 DAFB on deblossomed 'Braeburn'/'M.26' trees, but there was a photosynthetic recovery of trees with reduced crop load just prior to harvest. The effect of fruit in increasing

the efficiency of leaf NCER was also shown by Fujii and Kennedy (1985) and Giuliani et al. (1997a), who found 20–30% higher leaf photosynthesis rates on fruiting spurs as compared to those on nonfruiting spurs on cropping and noncropping trees, respectively.

After fruit harvest, the leaf photosynthetic potential across crop loads is quite similar and seems to respond to changed source-sink relationships and changing environmental conditions as the days become shorter and incident photosynthetic photon flux density (*PPFD*) is lower. In the study by Wünsche et al. (2000), it is interesting to note that at 201 DAFB, 20 days after harvest, leaf photosynthesis remained comparatively high, presumably due to optimal postharvest growing conditions combined with relatively healthy foliage on all trees. Avery et al. (1979) reported that the presence of fruit delayed the decline of stomatal and mesophyll conductance in autumn, but a sudden drop in leaf photosynthesis immediately after harvest is reported frequently (e.g., Kennedy and Fujii 1986), which is not necessarily linked to unfavorable environmental conditions. In contrast, Palmer (1992) recorded a substantial increase in leaf photosynthesis of 'Crispin'/'M.27' trees in all flower removal treatments after the fruit had been picked in mid-October. Possible crop load \times rootstock \times scion \times climate interactions of apple may explain the often contradictory results reported in the literature on the response of leaf photosynthesis after harvest.

Source-sink Relations. In summary, the removal of developing organs such as flowers or fruitlets can reduce leaf photosynthesis after a few weeks or even a few days, depending on time of crop load adjustment. Early in the growing season, leaf NCER is not affected by crop load, presumably due to the compensatory response of trees with lower fruit numbers to maintain sink strength by significantly increasing vegetative growth. The significant decline of leaf NCER in response to reduced crop load in mid-season is presumably due to the cessation of shoot growth and shoot development and hence fewer alternate sinks and a lower carbohydrate requirement at that time. On the other hand, it has been found that leaves with down-regulation of photosynthesis can be rejuvenated to relatively high photosynthetic capacity in late season when source-sink ratios recover because more carbohydrates are required for flower bud development, root growth, and re-filling storage pools in root and stem tissue. Moreover, the effect of crop load on leaf photosynthesis is very dependent upon time and severity of flower/fruitlet removal, and it seems that the later the thinning occurs, the greater the effect on photosynthesis since proportionally fewer actively growing sinks are available for alternative carbohydrate movement. Two factors are impor-

tant here: first, how does the leaf cope with excess light when demand is low and, second, what is the importance of starch in down-regulating photosynthesis? These will be discussed in Section VE.

2. Whole-canopy. Understanding the whole-tree carbon balance provides a more integrated analysis of many limitations to fruit development, e.g., the effects of shading on fruit retention, the effects of crop load on fruit size and quality, the effects of temperature on respiration, and the effects of light interception on carbon assimilation. Absolute values for whole-canopy gas exchange reported in the literature may vary due to differences in environmental conditions during the measurement period, possibly affected by design and ventilation of the canopy cuvette and the homogeneity of the air distribution within the cuvette (Wünsche and Palmer 1997b), canopy architecture, plant health status, canopy source-sink relations, etc. Although several research groups have monitored gas exchange of whole canopies, Wibbe et al. (1993) first attempted to examine the effect of fruiting versus nonfruiting on the carbon budget of apple tree canopies. However, to develop accurate photosynthesis response curves, which would be useful in modeling whole apple tree carbon balance, inclusion of various crop loads is essential.

Photosynthesis. Fruiting canopies generally acquire more carbon than vegetative canopies, as has been observed in grapevines with a 22% increase (Downton et al. 1987) and apple with maximum gains between 35 to 50% (Wibbe et al. 1993; Wibbe and Blanke 1995, 1997; Wünsche et al. 2000). Wünsche et al. (2000) provided evidence that mid- to late-season whole canopy net NCER per unit area of leaf increased linearly with increasing fruit load per TCA (Fig. 5.3B), whereas absolute whole canopy photosynthesis only revealed differences between fruiting and nonfruiting trees. Relative differences in daily whole canopy NCER of 13.8 g CO₂/m² leaf area for a high cropping tree and 5.9 g CO₂/m² leaf area for a noncropping tree at 109 DAFB (Wünsche et al. 2000) were similar to those estimated by Wibbe et al. (1993) for a fruiting and nonfruiting 'Golden Delicious' apple tree at a similar growth stage. Giuliani et al. (1997a,b) also found increased NCERs in fruiting vs. nonfruiting apple canopies. The data of Wibbe et al. (1993), indicating that carbon uptake of the fruiting tree largely resembled that of the nonfruiting tree in September just prior to fruit harvest, could not be confirmed by Wünsche et al. (2000), who reported that whole canopy NCER per unit area of leaf of the heavy fruiting tree exceeded by approximately 3.5-fold that of the nonfruiting tree at 165 DAFB. The substantially enhanced whole canopy photosynthetic performance of the high cropping tree

was observed despite about 40% less leaf area and 26% less intercepted light per tree, indicating a high carbohydrate requirement of the actively growing fruit sinks and the limited number of alternative sinks for carbon uptake on trees with reduced or no crop load. The significant and positively linear trend between leaf photosynthesis and crop load is in good agreement with a substantially increasing whole canopy NCER per unit area of leaf with higher crop load (Wünsche et al. 2000).

The relative response of whole canopy NCER to varying crop densities is consistent enough so that there is now wide acceptance that whole canopy carbon acquisition can be reduced at times of low demand for carbohydrates, particularly at low sink-source ratios. The photosynthetic adjustment of the whole canopy to various crop densities and changing source-sink relationships throughout the season seems similar to what is observed at the leaf level.

Respiration. Although absolute rates of whole canopy dark respiration of apple are dependent on night-temperature, the rate differences among trees are induced by crop load and can be related to differences in daytime stomatal behavior and photosynthesis (Butler and Landsberg 1981; Wibbe et al. 1993; Wibbe and Blanke 1995; Wünsche et al. 2000). Fruiting in apple, therefore, not only increases daily carbon gain but also nighttime carbon loss compared to nonfruiting trees. Dark respiration of 'Golden Delicious' apple tree canopies decreased when deblossomed or defruited, irrespective of month of defruiting, and was associated with reduced tree photosynthesis (Wibbe et al. 1993; Wibbe and Blanke 1995). The reduction can be attributed to partial stomatal closure upon fruit removal, which may be a consequence of lower biomass production per unit area of leaf for nonfruiting trees and hence lower maintenance respiration. However, fruit removal in late autumn increased whole canopy dark respiration and it was suggested that this was possibly due to stomata losing their regulatory ability during leaf senescence and/or increased translocation of carbohydrates for storage in the perennial parts of the tree (Wibbe et al. 1993; Wibbe and Blanke 1995).

Transpiration. Wünsche et al. (2000) showed that diurnal patterns of whole canopy net carbon exchange and transpiration per unit area of leaf were similar, suggesting a strong association between gas exchange rates and stomatal conductance. Higher transpiration rates on fruiting as opposed to nonfruiting trees have been reported in mid- to late-season (Landsberg et al. 1975; Butler 1976; Lenz 1986; Wünsche et al. 2000).

3. Fruit. The greater total dry matter accumulation in fruiting apple trees can be, as discussed above, attributed to higher photosynthetic effi-

ciencies of leaves. However, fruit themselves may contribute to dry matter gain. Despite this, apple fruit respire typically more CO_2 than they can assimilate at all developmental stages, although pre-climacteric fruit respiration rates are relatively low in comparison to those of vegetative organs (Proctor et al. 1976; Butler and Landsberg 1981; Noga and Lenz 1982a). A minor role of fruit photosynthesis in the assimilate supply of apples was also shown by Hansen (1970b, 1977a,b) and Jones (1981). This indicates that fruit net carbon exchange has only a minor effect on fruit carbohydrates, and fruit growth depends on carbohydrate import from source leaves. Nevertheless, fruit photosynthesis can limit carbon losses due to re-fixing CO_2 evolved from the internal fruit tissue (Noga and Lenz 1982a; Blanke and Lenz 1989).

Rates of water loss by fruit, which are only 1–3% of those of leaf transpiration, are unlikely to account for high water consumption and transpiration rates of fruiting trees (Noga and Lenz 1982b).

E. Regulation of Photosynthesis

Fruiting trees with different source-sink ratios often exhibit differences in carbon assimilation rates, yet the amount of available light energy absorbed by the leaves may be similar. That implies that once the photon requirement for the primary photochemical apparatus is met, trees with increasingly lower sink demand must divert proportionally more excess energy through other pathways. The reader is also referred to several excellent reviews on carbohydrate synthesis and sink activity on photosynthetic capacity (Kelly and Latzko 1976; Wardlaw 1980; Leegood 1996).

1. Chlorophyll Fluorescence. One technique that is useful to study energy utilization by the leaf is *in situ* chlorophyll fluorescence (Greer 1995), which is directly related to the photosynthetic potential of the leaves. In particular, this technique allows an assessment of the orderly dissipation of absorbed light energy through the photochemical pathway to photosynthesis or through the xanthophyll-cycle-mediated photo-protective pathway (Demmig-Adams and Adams 1996), and is measured as non-photochemical quenching (Osmond 1994).

Many studies have focused on environmental stress conditions that affect photosynthesis (Chow 1994). However, there is little research on the underlying physiology of photosynthesis as affected by internal stresses such as accumulation of carbohydrate through changes in source-sink relations of plants. When starch accumulates in leaves, an increase in non-radiative thermal dissipation can occur (Pammenter et al. 1993), indicating a redistribution of energy away from photosynthesis

and hence a reduction in photochemical efficiency, that is, the interconversion of light to chemical energy by the photochemical apparatus. Consistent with this, Buwalda and Noga (1994) have demonstrated that both photochemical and non-photochemical quenching varied between fruiting and nonfruiting apple trees.

Wünsche et al. (2000) showed a reduced photochemical yield ($\Delta F/F_m$) and electron transport rate (ETR) in trees with little or no crop load, indicating a higher percentage of photosystem (PS) II reaction center pool closure (i.e., lower photochemical quenching, q_p) and a greater capacity for non-photochemical quenching (NPQ, thermal dissipation) compared to fruiting trees in mid-season. Furthermore, the linear relationship they found between leaf photosynthesis and $\Delta F/F_m$ confirms that the reduction in photosynthesis in relation to different crop loads was related to a lowered photochemical efficiency. This relationship had been shown before in maize leaves (Edwards and Baker 1993) but not in apple leaves. Their results also suggest that, as the demand for photosynthate was lowered, the leaves were protected fully by the increased capacity for thermal dissipation (Osmond 1994). Measurement of the xanthophyll-cycle pigments supported this contention, with a higher xanthophyll ratio in leaves of nonfruiting vs. fruiting trees (Wünsche 2001; J. N. Wünsche and D. H. Greer, unpubl. data). However, total xanthophyll pool size was unaffected. Greer et al. (1997) showed that down-regulated apple leaves on noncropping trees did not consistently dissipate higher proportions of excess energy through the thermal pathway or through fluorescence, in spite of clear differences in leaf carbon assimilation rates. The results suggest that other pathways for dissipating excess energy exist, e.g., the reduction of flavonoid/anthocyanin pigments or photorespiration.

2. Leaf Conductance

Stomatal Conductance. The photosynthetic leaf response to crop load is correlated with stomatal conductance (g_s) and differences are due partly to leaves of fruiting trees having higher gaseous diffusive conductance than nonfruiting trees (Avery et al. 1979; Monselise and Lenz 1980b; Erf and Proctor 1987; Panthachod 1996; Wünsche et al. 2000). Giuliani et al. (1997b) estimated that canopy conductance was higher in a fruiting vs. nonfruiting apple canopy. Differences in stomatal behavior may be explained by differences in leaf assimilate concentration, in particular starch. High accumulation of assimilates in leaf chloroplasts and in guard cells of leaf stomata may reduce stomatal opening, thereby controlling rates of carbon uptake and transpiration (Hansen 1978; Monselise and Lenz 1980b; Porpigia and Barden 1981; Siebertz and Lenz

1982; Rom and Barritt 1990). If the accumulation of assimilates increases photorespiration (Lenz 1978), an increased intercellular CO₂ concentration could lead to stomatal closure (Raschke 1975; Mansfield et al. 1981). Conversely, carbohydrate accumulation is also associated with an increase in plant hormone concentration (Kriedemann et al. 1972, 1976; Loveys and Kriedemann 1974; Kriedemann and Loveys 1975), which intensifies the sensitivity of guard cells to atmospheric CO₂ and will lead to a reduction in stomatal opening. Stomatal behavior could be hormonally controlled based on finding close relationships between leaf stomatal resistance and abscisic and phaseic acid concentrations. Heckenberger et al. (1996) found a negatively linear correlation between abscisic acid (ABA) concentration in the xylem sap and leaf stomatal conductance, but it is yet to be determined if the stomatal response to crop load is controlled hormonally.

Mesophyll Conductance. Watson et al. (1978) reported 40% higher mesophyll conductance (gm) in extension shoot leaves of fruiting trees than in those of defruited trees, although g_m of spur leaves with and without subtending fruit was similar. Kennedy and Fujii (1986) found that fruiting 'Starkrimson' spurs exhibited enhanced leaf photosynthetic rate as a result of higher carboxylation efficiency and lower mesophyll resistance.

3. Chlorophyll Concentration. Leaves of fruiting apple trees have typically a higher chlorophyll concentration and a lower chlorophyll a:b ratio (Wünsche 2001), which is characteristic for shade leaves (Ghosh 1973; Streitberg 1975). Lower chlorophyll content in leaves of non-fruiting compared with those of fruiting trees was reported for 'Golden Delicious' (Schupp et al. 1992), 'Elstar' (Panthachod 1996), and 'Braeburn' (Wünsche 2001) trees. Accumulation of leaf assimilates has been associated with decreased leaf chlorophyll concentrations (Avery et al. 1979; Lenz 1979a), and this can also be associated with the low photosynthetic rates of leaves on nonfruiting trees. Chlorophyll promoting substances such as cytokinins, amino acids, N, and Mg are suggested to be higher per total shoot dry matter in fruiting trees than in nonfruiting trees (Sato et al. 1977; Ferree et al. 1984).

4. Carbohydrate Concentration. Another mechanism by which leaf photosynthesis may be regulated is the gradual build up of starch grains within chloroplasts of the leaf palisade cells at low sink-source ratios (low crop load). This may physically prevent some absorbed light from reaching the thylakoids and hence inhibiting the light-dependent stage

of photosynthesis (Salisbury and Ross 1992). Consequently, accumulation of photosynthetic carbon reduction cycle intermediates in the leaf chloroplast may induce a feedback regulation of photosynthesis presumably brought about by an imbalance between carbon metabolism and absorbed excitation energy and a decline in translocation rates of sucrose and sorbitol (Neales and Incoll 1968; Herold 1980; Monselise and Lenz 1980a). This may be particularly the case after the cessation of shoot growth and/or when carbohydrate demands of fruit sinks are low. Stress-induced (e.g., low sink-source ratio) limitations on photoassimilate utilization leads to an accumulation of leaf carbohydrates and concomitantly to an end-product induced down-regulation of leaf carbon assimilation and damaged grana in the chloroplasts and other cell membrane structures. This has been shown in other crop species such as wheat (Azcón-Bieto 1983), soybean (Nafziger and Koller 1976), and sweet cherry (Gucci et al. 1991). Such an accumulation of starch and soluble sugars in leaves may lead to the reduction in Rubisco (RuBP) activity and leaf chlorophyll content (Avery et al. 1979; Lenz 1979a). In contrast, phytohormones produced by the fruit may be responsible for increased leaf photosynthesis rates of fruiting trees caused by either auxin- (Neales and Incoll 1968; Herold 1980) or cytokinin-stimulating effects on RuBP activity (Ferree et al. 1984; Satoh et al. 1977).

The recovered photosynthetic capacity in the later part of the growing season (Wünsche et al. 2000) may be due to the degradation of starch when sink-source ratios increase. This hypothesis warrants further detailed investigation: Can starch in leaves and possibly other organs (parenchyma cells in roots and stems) be remobilized to overcome short- and/or long-term supply limitations at increased sink/source ratios, and if true, what proportion of the total starch (recently accumulated *cf.* total) is available for remobilization? It would be interesting to uncover the physiological mechanisms of how those changes are brought about, i.e., is the increase/decrease in photosynthetic activity associated with changes in enzyme activity within the sink and hence the build up/degradation of starch?

F. Regulation of Fruit Growth

Although the importance of tree and orchard management for actual fruit yield and potential fruit size in particular are recognized (Lakso et al. 1989; Tustin et al. 1992; Wünsche et al. 1996), the underlying principles and short- to long-term dynamics of the numerous source-sink interactions are still poorly understood. What regulates the formation and activity of enzymes within a fruit sink and hence that sink's ability to attract

and utilize carbohydrate? There is now mounting evidence that a sink's (fruit) capacity to utilize photosynthates matches the supply by leaves (Farrar and Minchin 1991; Minchin et al. 1997). This presumably is brought about by sucrose-induced expression of carbohydrate metabolizing enzymes (Koch et al. 1992; Koch 1996). Developing apple fruit may consequently import photosynthates at a rate corresponding to their utilization capacity, so that augmented availability of photosynthates will lead to increased import through increased enzyme activity (Minchin et al. 1997). Carbon flow into a fruit sink thus depends on source-sink relations that can be regulated by specific leaf-to-fruit ratios. The study of gene function at the molecular level and the identification of major genetic controls on fruit growth and sink regulation may provide further insight.

VI. CONCLUDING REMARKS

A. A Molecular Approach

In recent years new research approaches based on gene function have become widely available for crop manipulation, introducing the possibility of identification of major genetic controls of fruit growth and development. This includes control of the fate of developing meristems in buds during induction or floral commitment, biennial bearing, flower/fruitlet abscission, and fruit cell division and expansion.

Major impediments to optimizing crop load include the biennial bearing character of some cultivars, the lack of reliable thinning strategies, and the inconsistent control of fruit size. Thus, an understanding of the genetic control of these processes may provide the base for consistent cropping behavior producing fruit with a uniform and marketable size profile. If we could alter the numbers of flowers per cluster through selecting for specific genes, or by modifying them, we would influence productivity and fruit quality, and also tree growth and form. As one example, identification of key genes involved in abscission and expression of self-thinning within a cluster (e.g., 'Granny Smith'), and then use of these genes to develop a molecular-based assay to study the action of chemical fruit thinners and evaluate the potential of new thinners, would provide significant new opportunities in fruit production (Van Nocker 2002).

The current increase in fruit Expressed Sequence Tags (EST) databases will enhance a molecular approach. For example, using HortResearch's extensive apple EST database, we can identify both known and non-annotated genes and transcription factors that show association with

specific plant developmental processes such as branching and flowering. In addition, identification of plant developmental genes will be increased by enriching the apple EST database for these genes by constructing and sequencing cDNAs from subtracted libraries using apple tissue of cultivars with, for example, biennial/non-biennial cropping behavior or parthenocarpic/non-parthenocarpic fruit.

The major route for use of such genes or sequences is for them to be screened as candidate restriction fragment length polymorphism (RFLP) markers over phenotype extremes of a population segregating, for example, for biennial fruiting behavior to identify putative marker-trait linkages. Associations of candidate genes with phenotype can be verified by mapping of quantitative trait loci (QTL) in the entire population of several hundred plants. Other markers can be identified by bulked segregant analysis (BSA), i.e., screening Random Amplified Polymorphic DNA (RAPD) markers over DNA from phenotypic extremes for biennial character in the same segregating population. These can also be located on the QTL map. Markers flanking genetic loci influencing biennial cropping behavior identified by either route (candidate gene or BSA) and verified in test populations may then be suitable for use by breeders for marker assisted selection (MAS) in populations related to the initial mapping populations.

This integrated approach has proven successful for major genes associated with pest and disease resistance in apple (Gardiner et al. 2003). Other programs, involving multi-gene systems (e.g., fruit Ca/bitter pit susceptibility, and dwarfing in apple) with positive early results, have also been initiated.

B. Major Conclusions

Research on crop load has revealed a powerful interplay between fruit development and shoot growth and photosynthesis (Fig. 5.4). The apple tree has a remarkable ability to compensate for the differing demands of the fruit crop for carbohydrate. This can be looked at in two ways: one from the viewpoint of leaf and shoot photosynthesis and tree growth, and the other from the impacts on fruit growth and quality.

1. Tree Growth Response. Vegetative growth with concomitant leaf and whole-canopy photosynthesis is very dependent upon time and severity of flower/fruitlet removal; the later the thinning occurs the greater the effect on depressing photosynthesis, since proportionally fewer actively growing sinks are available for alternative carbohydrate movement. Early

Tree and fruit response to crop load in apple	Physiological explanation
<p>1. Vegetative response</p> <p>As crop load increases, there is a decrease in:</p> <ul style="list-style-type: none"> • Leaf area, with heavier & thicker leaves • Shoot growth, seen in shoot number and/or mean shoot length • Trunk and root growth - although proportionally the least increment • Dry matter 	<p>Lesser amounts of assimilates / dry matter partitioned into vegetative sinks due to strong fruit sinks</p>
<p>2. Reproductive response</p> <p>A heavy crop results in:</p> <ul style="list-style-type: none"> • Fewer flowers, and lower flower quality • Reduced fruit set, growth rate, size/weight and dry matter • Retarded maturity, seen in colour, SSC, TA and firmness • Less storage disorders such as bitter pit, watercore, and internal breakdown 	<ul style="list-style-type: none"> • Hormonal (GA) regulation • Carbohydrate supply limitation due to low leaf : fruit ratio • High Ca:K conc. ratio
<p>3. Physiological and biochemical responses</p> <p>With higher crop loads, there is an increase in:</p> <ul style="list-style-type: none"> • Gas exchange - NCER, transpiration, dark respiration, g_s, g_m • Chlorophyll fluorescence - q_p, $\Delta F/F_m'$, ETR • Water consumption • Mineral nutrient uptake <p>and a decrease in:</p> <ul style="list-style-type: none"> • Concentration and content of carbohydrates 	<ul style="list-style-type: none"> • No feedback regulation of photosynthesis due to low source - sink ration and carbohydrate accumulation • Greater leaf photosynthetic efficiency • Hormonal (ABA) regulation

Fig. 5.4. Summary of plant responses to crop load in apple. Generalized effects of cropping can vary dependent upon time and severity of flower/fruitlet removal, environmental conditions and source-sink interactions.

in the growing season, gas exchange characteristics per unit area of leaf and at the whole-canopy level are not affected by crop load; trees with lower fruit numbers compensate by increasing extension shoot growth, leaf area, and trunk circumference.

In the mid to late part of the growing season, leaf and canopy photosynthesis and transpiration per unit area of leaf are significantly down-regulated with reduced crop load, yet the amount of available light energy absorbed by the leaves may be similar. Two factors are important here: first, how do leaves cope with excess light when demand is low and, second, how important are carbohydrates in down-regulating photosynthesis? First, once the photon requirement for primary photochemistry is met, low sink demand trees divert proportionally more excess energy through the thermal dissipation pathway (xanthophyll-mediated) or through reaction center closure in PS II, compared to high sink demand trees. Second, stomatal regulation of the photosynthetic process is important, and is either controlled by xylem-derived phytohormones and/or due to a build up/degradation of starch grains within leaf chloroplasts and hence varying exposure levels of the thylakoids depending on sink-source ratios.

Leaves with down-regulated photosynthesis can be relieved in autumn when sink-source ratios increase substantially due to vegetative sinks becoming more demanding for carbohydrates. In the later part of the growing season, particularly after crop removal and during optimal postharvest environmental conditions, photoassimilates are increasingly required for organ differentiation (flower bud development), actively growing organs (roots), and re-filling lowered "storage pools" (root and stem tissue). All these plant processes will make the new cyclic flush of growth in the subsequent spring possible.

2. Fruit Growth and Quality Response. The impact of crop load on fruit quality is not straightforward. With medium to high cropping loads, vegetative growth and leaf area are reduced, yet total dry matter production may be increased, suggesting higher leaf photosynthetic efficiency. Thus fruit may retain sufficient dry matter, soluble solids, firmness, and Ca contents to provide high quality after storage.

Fruit from light cropping trees mature earlier, are larger, and tend to have higher background color, red blush intensity, soluble solids, titratable acidity, and firmness. However, these qualities do not always transfer into quality after storage, where low Ca and advanced maturity increase susceptibility to disorders. Fruit from light cropping trees not only have more bitter pit but may also show a higher degree of radial

water core, moldy core, core rots, internal browning, vascular browning, and cracking.

There is insufficient research into the specific effects of crop load on quality, particularly on the physiological consequences of varying photosynthetic dynamics, and on the impacts on fruit growth over the season. The challenge for both the research scientist and the grower still remains: to balance carbohydrate supply and demand, and hence to manipulate fruit properties, by adjusting the crop load of trees early in the season so that an optimum distribution of commercially acceptable fruit can be produced. A multidisciplinary science approach with a closer link between whole plant physiologists, fruit biochemists, and molecular biologists will provide further advances in our understanding of the complex physiological interactions between the growth of vegetative and reproductive organs. This will provide the basis for the development of effective and reliable practical tools for early crop load manipulation, ensuring that genetically intrinsic fruit properties can be expressed at their full potential.

LITERATURE CITED

- Abbott, D. L. 1977. Fruit-bud formation in 'Cox's Orange Pippin'. Rpt. Long Ashton Res. Sta. 1976, 167–176.
- Abbott, D. L. 1984. The apple tree. Physiology and management. Grower Books, London.
- Assaf, R., I. Levin, and B. Bravdo. 1982. Apple fruit growth as a measure of irrigation control. *HortScience* 17:59–61.
- Autio, W. R. 1991. Rootstocks affect ripening and other qualities of 'Delicious' apple. *J. Am. Soc. Hort. Sci.* 116:378–382.
- Avery, D. J. 1969. Comparisons of fruiting and deblossomed maiden apple trees, and of non-fruiting trees on dwarfing and invigorating rootstock. *New Phytol.* 68:323–336.
- Avery, D. J. 1970. Effects of fruiting on the growth of apple trees on four rootstock varieties. *New Phytol.* 69:19–30.
- Avery, D. J. 1975. Effects of fruits on photosynthetic efficiency. p. 110–112. In: H. C. Pereira (ed.), *Climate and the orchard*. Comm. Agr. Bureaux, Farmham Royal, Slough, England.
- Avery, D. J., C. A. Priestley, and K. J. Treharne. 1979. Integration of assimilation and carbohydrate utilization of apple. p. 221–231. In: R. Marcelle, H. Clijsters and W. Van Pouke (eds.), *Conf. proc. on photosynthesis and plant development*. Dr. W. Junk, The Hague.
- Awad, M. A., A. de Jager, M. Dekker, and W. M. F. Jongen. 2001. Formation of flavonoids and chlorogenic acid in apples as affected by crop load. *Scientia Hort.* 91:227–237.
- Azcón-Bieto, J. 1983. Inhibition of photosynthesis by carbohydrates in wheat leaves. *Plant Physiol.* 73:681–686.
- Bain, J. M., and R. N. Robertson. 1951. The physiology of growth in apple fruits. I. Cell size, cell number, and fruit development. *Australian J. Sci. Res.* 4:75–91.
- Bangerth, F. 1993. Polar auxin transport as signal in the regulation of tree and fruit development. *Acta Hort.* 329:70–76.

- Bangerth, F. 2000. Abscission and thinning of young fruit and their regulation by plant hormones and bioregulators. *Plant Growth Reg.* 31:43–59.
- Barlow, H. W. B. 1964. An interim report on a long-term experiment to assess the effect of cropping on apple tree growth. *Annu. Rpt. E. Malling. Res. Sta.* 1963, p. 84–93.
- Barlow, H. W. B. 1966. Effect of cropping on the number and kind of shoots on four apple varieties. *Annu. Rpt. E. Malling. Res. Sta.* 1965, p. 120–124.
- Barlow, H. W. B. 1975. Effects of cropping on growth of orchard trees. p. 98–102. In: H. C. Pereira (ed.), *Climate and the orchard*. Comm. Agr. Bureaux, Farmham Royal, Slough, England.
- Barone, E., T. Caruso, and F. P. Marra. 1995. Vegetative growth and inflorescence bud abscission in bearing and non-bearing pistachio trees. *Acta Hort.* 419:29–35.
- Baugher, T. A., K. C. Elliott, and D. M. Glenn. 1995. Effect of sod composition and root pruning on 'Stayman' apple tree growth and fruit cracking. *HortScience* 30:222–226.
- Bedford, The Duke of, and S. U. Pickering. 1916. The fruiting of trees in consecutive seasons. p. 132–140. In: *Fifteenth Report, Woburn Experimental Fruit Farm*, Science and Fruit Growing, Macmillan, London.
- Behboudian, M. H., and T. M. Mills. 1997. Deficit irrigation in deciduous orchards. *Hort. Rev.* 21:105–131.
- Bepete, M., and A. N. Lakso. 1998. Differential effects of shade on early season fruit and shoot growth rates in 'Empire' apple branches. *HortScience* 33:823–825.
- Bergh, O. 1985. Effect of the previous crop on cortical cell number of *Malus domestica* cv. 'Starking Delicious' apple flower primordia, flowers and fruit. *S. Afr. J. Plant Soil* 2:191–196.
- Bergh, O. 1990. Effect of time of hand-thinning apple fruit size. *S. Afr. J. Plant Soil* 7:1–10.
- Bhambota, J. R., R. B. Shrestha, and D. K. Uppal. 1969. Effect of leaf area on the flower bud formation in apples. *Punjab Hort.* 9:166–168.
- Blanke, M. M., and F. Lenz. 1989. Fruit photosynthesis—a review. *Plant Cell Env.* 12:31–46.
- Boon, J. 1980a. Prediction and control of bitter pit in apples. I. Prediction based on leaf mineral composition, cropping levels and summer temperatures. *J. Hort. Sci.* 55:307–312.
- Boon, J. 1980b. Prediction and control of bitter pit in apples. II. Control by summer pruning, fruit thinning, delayed harvesting and soil dressings. *J. Hort. Sci.* 55:313–321.
- Bound, S. A. 2001. The influence of endothal and 6-benzyladenine on crop load and fruit quality of red 'Delicious' apple. *J. Hort. Sci. Biotech.* 76:691–699.
- Bound, S. A., and K. M. Jones. 1997. Investigating the efficacy of endothal as a chemical thinner of 'Red Delicious' apple. *J. Hort. Sci.* 72:171–177.
- Buban, T., and M. Faust. 1982. Internal control and differentiation of flower bud induction in apple trees. *Hort. Rev.* 4:174–203.
- Buszard D., and W. W. Schwabe. 1995. Effect of previous crop on stigmatic morphology of apple flowers. *J. Am. Soc. Hort. Sci.* 120:566–570.
- Butler, D. R. 1976. Estimation of the transpiration rate in an apple orchard from net radiation and vapour pressure deficit measurements. *Agr. Meteorol.* 16:277–289.
- Butler, D. R., and J. J. Landsberg. 1981. Respiration rates of apple trees, estimated by CO₂-efflux measurements. *Plant Cell Env.* 4:153–159.
- Buwalda, J. G., and F. Lenz. 1992. Effects of cropping, nutrition and water supply on accumulation and distribution of biomass and nutrient consumption for apples trees on M9 root system. *Physiol. Plant.* 84:21–28.
- Buwalda, J. G., and G. Noga. 1994. Intra-plant differences in leaf chlorophyll fluorescence parameters in perennial fruiting plants. *New Zealand J. Crop Hort. Sci.* 22:373–380.

- Byers, R. E. 2003. Flowering and fruit thinning and vegetative:fruiting balance. p. 409–436. In: D. C. Ferree and I. J. Warrington (eds.), Apples: Botany, production and uses. CABI Publ., Cambridge, MA.
- Byers, R. E., J. A. Barden, and D. H. Carbaugh. 1990. Thinning of spur 'Delicious' apples by shade, terbacil, carbaryl and ethephon. *J. Am. Soc. Hort. Sci.* 115:9–13.
- Byers, R. E., and D. H. Carbaugh. 1991. Effect of chemical thinning sprays on apple fruit set. *HortTechnology* 1:41–48.
- Byers, R. E., D. H. Carbaugh, C. N. Presley, and T. K. Wolf. 1991. The influence of low light levels on apple fruit abscission. *J. Hort. Sci.* 66:1–17.
- Callesen, O. 1988. Effect of flower bud position on fruit set and fruit size in apple. *Tidsskr. Planteavl.* 92:339–344.
- Chan, B. G., and J. C. Cain. 1967. The effect of seed formation on subsequent flowering in apple. *Proc. Am. Soc. Hort. Sci.* 91:63–68.
- Chandler, W. H. 1934. Dry matter residues of trees and their products in proportion to leaf area. *Proc. Am. Soc. Hort. Sci.* 31:39–56.
- Chandler, W. H., and A. J. Heinicke. 1926. The effect of fruiting on the growth of 'Oldenburg' apples trees. *Proc. Am. Soc. Hort. Sci.* 23:36–46.
- Chaumont, M., J. Morot-Gaudry, and C. H. Foyer. 1994. Seasonal and diurnal changes in photosynthesis and carbon partitioning in *Vitis vinifera* leaves in vines with and without fruit. *J. Expt. Bot.* 45:1235–1243.
- Childers, N. F. 1978. Modern fruit science: Orchard and small fruit culture. 8th ed. Horticulture Publishers, Rutgers Univ., New Brunswick, N.J.
- Chong, C. 1971. Study of the seasonal and diurnal distribution of sorbitol and related carbohydrates within apple seedlings by analysis of selected tissue and organs. *Can. J. Plant Sci.* 51:519–525.
- Chong, C., and C. D. Taper. 1971. Daily variation of sorbitol and related carbohydrates in *Malus* leaves. *Can. J. Bot.* 49:173–177.
- Chow, W. S. 1994. Photoprotection and photoinhibitory damage. p. 151–196. In: E. E. Bitar and J. Barber (eds.), Advances in molecular and cell biology. Vol. 10. Molecular processes of photosynthesis. Jai Press, Inc., Greenwich, U.K.
- Corelli Grappadelli, L., A. N. Lakso, and J. A. Flore. 1994. Early season patterns of carbohydrate partitioning in exposed and shaded apple branches. *J. Am. Soc. Hort. Sci.* 119:596–603.
- Crane, J. C., and I. Al-Shalan. 1976. Carbohydrate and nitrogen levels in pistachio branches as related to shoot extension and yield. *J. Am. Soc. Hort. Sci.* 102:396–399.
- Crane, J. C., P. B. Catlinand, and I. Al-Shalan. 1976. Carbohydrate levels in the pistachio as related to alternate bearing. *J. Am. Soc. Hort. Sci.* 101:371–374.
- Cripps, J. E. L. 1981. Biennial patterns in apple tree growth and cropping as related to irrigation and thinning. *J. Hort. Sci.* 56:161–168.
- Das, G. C., S. C. Sahoo, and D. P. Ray. 1989. Studies on effects of gibberellic acid and urea either alone or in combination on the growth and flowering behaviour of some "on" and "off" year shoots in 'Langra' mango. *Acta Hort.* 231:495–499.
- Davis, L. D. 1957. Flowering and alternate bearing. *Proc. Am. Soc. Hort. Sci.* 70:545–556.
- DeJong, T. 1986. Fruit effects on photosynthesis in *Prunus persica*. *Physiol. Plant.* 66:149–153.
- Demmig-Adams, B., and W. W. Adams III. 1996. The role of xanthophyll cycle carotenoids in the protection of photosynthesis. *Trends Plant Sci.* 1:21–26.
- Denne, M. P. 1960. The growth of apple fruitlets and the effect of early thinning on fruit development. *Ann. Bot.* 24:397–406.

- Dennis, F. G., Jr. 1979. Factor affecting yield in apple with emphasis on 'Delicious'. Hort. Rev. 1:395-422.
- Dennis, F. G., Jr., and L. J. Edgerton. 1962. Induction of parthenocarpy in the apple with gibberellin and the effects of supplementary auxin application. Proc. Am. Soc. Hort. Sci. 80:58-63.
- Dennis, F. G., Jr., and J. C. Neilsen. 1999. Physiological factors affecting biennial bearing in tree fruit: the role of seeds in apple. HortTechnology 9:317-322.
- Downton, W. J. S., W. J. R. Grant, and B. R. Loveys. 1987. Diurnal changes in the photosynthesis of field-grown grapevines. New Phytol. 105:71-80.
- Dudney, P. J., and W. C. C. Hadlow. 1972. Growth pattern experiment. Annu. Rpt. E. Malling. Res. Sta. 1971, p. 55-56.
- Ebert, G., and F. Lenz. 1991. Jahresverlauf der Wurzelatmung von Apfelbäumen und ihr Beitrag zur CO₂-Bilanz. Gartenbauwissenschaft 56:130-133.
- Edwards, G. E., and N. R. Baker. 1993. Can CO₂ assimilation in maize leaves be predicted accurately from chlorophyll fluorescence analysis? Photosyn. Res. 37:89-102.
- Elfving, D. C., and R. A. Cline. 1993. Cytokinin and ethephon affect crop load, shoot growth, and nutrient concentration of 'Empire' apple trees. HortScience 28:1011-1014.
- Elfving, D. C., and C. G. Forshey. 1976. Growth and fruiting responses of vigorous apple branches to pruning and branch orientation treatments. J. Am. Soc. Hort. Sci. 101:290-293.
- Elfving, D. C., and I. Schechter. 1993. Fruit count, fruit weight and yield relationships in 'Delicious' apple trees on nine rootstocks. HortScience 28:793-795.
- Elgar, H. J., C. B. Watkins, and N. Lallu. 1999. Harvest date and crop load effects on carbon dioxide-related storage injury of 'Braeburn' apple. HortScience 34:305-309.
- El-Kassab, S. E., M. A. Ahmed, A. M. El-Sese, and A. A. Mohammed. 1994. Physiological studies on some factors affecting alternate bearing in 'Balady' mandarin (*Citrus reticulata* Blanco). B. Effect of fruit thinning during on-flowering season by certain growth regulators. Assiut J. Agr. Sci. 25:141-153.
- El-Sayed, M. A., and P. Lüdders. 1984. Einfluß von Kalium und Unterlage auf den Wasserverbrauch von Apfelbäumen mit unterschiedlichem Fruchtbehang. Erwerbsobstbau 26:63-66.
- Erf, J. A., and J. T. A. Proctor. 1987. Changes in apple leaf water status and vegetative growth as influenced by crop load. J. Am. Soc. Hort. Sci. 112:617-620.
- Fallahi, E., D. G. Richardson, and M. N. Westwood. 1985. Quality of apple fruit from a high density orchard as influenced by rootstocks, maturity and storage. J. Am. Soc. Hort. Sci. 110:71-74.
- Fallahi, E., M. N. Westwood, D. G. Richardson, and M. H. Chaplin. 1984. Effects of rootstocks and K and N fertilizers on seasonal apple fruit mineral composition in a high density orchard. J. Plant Nutr. 7:1179-1201.
- Farrar, J. F., and P. E. H. Minchin. 1991. Carbon partitioning in split root system of barley—relation to metabolism. J. Expt. Bot. 42:1261-1269.
- Ferguson, I. B., and C. M. Triggs. 1990. Sampling factors affecting the use of mineral analysis of apple fruit for the prediction of bitter pit. New Zealand J. Crop Hort. Sci. 18:147-152.
- Ferguson, I. B., and C. B. Watkins. 1989. Bitter pit in apple fruit. Hort. Rev. 11:289-355.
- Ferguson, I. B., and C. B. Watkins. 1992. Crop load affects mineral concentrations and incidence of bitter pit in 'Cox's Orange Pippin' apple fruit. J. Am. Soc. Hort. Sci. 117:373-376.
- Ferree, D. C. 1992. Time of root pruning influences on vegetative growth, fruit size, biennial bearing and yield in 'Jonathan' apple. J. Am. Soc. Hort. Sci. 117:198-202.

- Ferree, D. C., B. L. Bishop, J. R. Schupp, D. S. Tustin, W. M. Cashmore. 2000. Influence of flower type, position in the cluster and spur characteristics on fruit set and growth of apple cultivars. *J. Hort. Sci. Biotech.* 76:1–8.
- Ferree, D. C., S. C. Myers, C. R. Rom, and B. H. Taylor. 1984. Physiological aspects of summer pruning. *Acta Hort.* 146:243–252.
- Ferree, D. C., and J. W. Palmer. 1982. Effect of spur defoliation and ringing during bloom on fruiting, fruit mineral level, and net photosynthesis of ‘Golden Delicious’ apple. *J. Am. Soc. Hort. Sci.* 107:1182–1186.
- Ferree, D. C., and W. T. Rhodus. 1993. Apple tree performance with mechanical hedging or root pruning in intensive orchards. *J. Am. Soc. Hort. Sci.* 118:707–713.
- Fletcher, L. A. 1932. Effect of thinning on colour and size of apples. *Proc. Am. Soc. Hort. Sci.* 29:51–55.
- Flore, J. A., and A. N. Lakso. 1989. Environmental and physiological regulation of photosynthesis in fruit crops. *Hort. Rev.* 11:111–157.
- Forney, C. F., and P. J. Breen. 1985. Dry matter partitioning and assimilation in fruiting and deblossomed strawberry. *J. Am. Soc. Hort. Sci.* 110:181–185.
- Forshey, C. G. 1982. Effects of fruiting, pruning and nitrogen fertilization on shoot growth of ‘Empire’ apple trees. *J. Am. Soc. Hort. Sci.* 107:1092–1097.
- Forshey, C. G., and D. C. Elfving. 1977. Fruit numbers, fruit size and yield relationships in ‘McIntosh’ apples. *J. Am. Soc. Hort. Sci.* 102:399–402.
- Forshey, C. G., and D. C. Elfving. 1989. The relationship between vegetative growth and fruiting in apple trees. *Hort. Rev.* 11:229–287.
- Forshey, C. G., and C. A. Marmo. 1985. Pruning and deblossoming effects on shoot growth and leaf area of ‘McIntosh’ apple tree. *J. Am. Soc. Hort. Sci.* 110:128–132.
- Forshey, C. G., and M. W. McKee. 1970. Production efficiency of a large and a small ‘McIntosh’ apple tree. *HortScience* 5:164–165.
- Forshey, C. G., R. W. Weires, B. H. Stanley, and R. C. Seem. 1983. Dry weight partitioning of ‘McIntosh’ apple trees. *J. Am. Soc. Hort. Sci.* 108:149–154.
- Francesconi, A. H. D., C. B. Watkins, A. N. Lakso, J. P. Nyrop, J. Barnard, and S. S. Denning. 1996. Interactions of European red mite and crop load on maturity and quality, mineral concentrations, and economic value of ‘Stark Crimson Delicious’ apples. *J. Am. Soc. Hort. Sci.* 121:967–972.
- Fujii, J. A., and R. A. Kennedy. 1985. Seasonal changes in the photosynthetic rate in apple trees. A comparison between fruiting and nonfruiting trees. *Plant Physiol.* 78:519–524.
- Fulford, R. M. 1965. Regular and irregular bearing in fruit plants. *Annu. Rpt. E. Malling. Res. Sta.* 1964, p. 71–82.
- Fulford, R. M. 1966a. The morphogenesis of apple buds. III. The inception of flowers. *Ann. Bot.* 30:207–219.
- Fulford, R. M. 1966b. The morphogenesis of apple buds. IV. The effect of fruit. *Ann. Bot.* 30:597–606.
- Gardiner, S., J. Murdoch, S. Meech, V. Bus, R. Rusholme, E. Rikkerink, H. Bassett, M. Cook, A. Gleave, R. Crowhurst, G. Ross, and I. Warrington. 2003. Candidate resistance genes from an EST database prove a rich source of markers for major genes conferring resistance to important apple pests and diseases. *Acta Hort.* 622:141–151.
- Getachew, A. D. 2000. Measures to counteract alternate bearing in apple. Dissertation, Wehle Verlag, Bonn.
- Ghosh, S. P. 1973. Internal structure and photosynthetic activity of different leaves of apple. *J. Hort. Sci.* 48:1–9.

- Giuliani, R., L. Corelli Grappadelli, and E. Magnanini. 1997a. Effects of crop load on apple photosynthetic responses and yield. *Acta Hort.* 451:303–311.
- Giuliani, R., F. Nerozzi, E. Magnanini, and L. Corelli Grappadelli. 1997b. Influence of environmental and plant factors on canopy photosynthesis and transpiration of apple trees. *Tree Physiol.* 17:637–645.
- Goffinet, M. C., T. L. Robinson, and A. N. Lakso. 1995. A comparison of 'Empire' apple fruit size and anatomy in unthinned and hand-thinned trees. *J. Hort. Sci.* 70:375–387.
- Goldschmidt, E. E., and S. P. Monselise. 1972. Hormonal control of flowering in citrus trees and other woody perennials. p. 758–766. In: D. J. Carr (ed.), *Plant growth substances*. Springer Verlag, Berlin.
- Goldschmidt, E. R. 1996. Fruit set and biennial bearing in apple cv 'Cox's Orange' and 'Belle de Boskoop'. *Swedish J. Agr. Res.* 26:147–151.
- Goldschmidt, E. R., and A. Golomb. 1982. The carbohydrate balance of alternate bearing citrus trees and the significance of reserves for flowering and fruiting. *J. Am. Soc. Hort. Sci.* 107:206–208.
- Greene, D. W. 1989. CPPU influences 'McIntosh' apple crop load and fruit characteristics. *HortScience* 24:94–96.
- Greene, D. W. 1995. Thidiazuron effects on fruit set, fruit quality, and return bloom of apples. *HortScience* 30:1238–1240.
- Greene, D. W. 2003. Endogenous hormones and bioregulator use on apples. p. 437–457. In: D. C. Ferree and I. J. Warrington (eds.), *Apples: Botany, production and uses*. CABI Publ., Cambridge, MA.
- Greene, D. W., and W. R. Autio. 1989. Evaluation of benzyladenine as a chemical thinner on 'McIntosh' apples. *J. Am. Soc. Hort. Sci.* 114:68–73.
- Greene, D. W., W. R. Autio, J. A. Erf, and Z. Y. Mao. 1992. Mode of action of benzyladenine when used as a chemical thinner on apples. *J. Am. Soc. Hort. Sci.* 117:775–779.
- Greene, D. W., and W. J. Lord. 1978. Evaluation of scoring, limb spreading and growth regulators for increasing flower bud initiation and fruit set on young 'Delicious' apple trees. *J. Am. Soc. Hort. Sci.* 103:208–210.
- Greer, D. H. 1995. Effect of canopy position on the susceptibility of kiwifruit (*Actinidia deliciosa*) leaves on vines in an orchard environment to photoinhibition throughout the growing season. *Australian J. Plant. Physiol.* 22:299–309.
- Greer, D. H., J. N. Wünsche, and E. A. Halligan. 2002. Influence of postharvest temperatures on leaf gas exchange, carbohydrate reserves and allocations, subsequent bud break, and fruit yield of 'Braeburn' apple (*Malus domestica*) trees. *New Zealand J. Crop Hort. Sci.* 30:175–185.
- Greer, D. H., J. N. Wünsche, and J. W. Palmer. 1997. Effects of fruiting on seasonal apple leaf chlorophyll fluorescence. *Acta Hort.* 451:345–350.
- Grochowska, M. J. 1973. Comparative studies on physiological and morphological features of bearing and non-bearing spurs of the apple tree. I. Changes in starch content during growth. *J. Hort. Sci.* 48:347–356.
- Grochowska, M. J., and A. Karaszewska. 1978. A possible role of hormones in growth and development of apple tree and a suggestion on how to modify their action. *Acta Hort.* 80:457–462.
- Grochowska, M. J., A. Karaszewska, B. Jankowska, and A. Mika. 1984. The pattern of hormones of intact apple shoots and its changes after spraying with growth regulators. *Acta Hort.* 149:25–38.
- Grossman, Y. L., and T. M. DeJong. 1995a. Maximum fruit growth potential and seasonal patterns of resource dynamics during peach growth. *Ann. Bot.* 75:553–560.

- Grossman, Y. L., and T. M. DeJong. 1995b. Maximum vegetative growth potential and seasonal patterns of resource dynamics during peach growth. *Ann. Bot.* 76:473–482.
- Gucci, R., L. Corelli Grappadelli, D. S. Tustin, and G. Ravaglia. 1995. The effect of defruiting at different stages of fruit development on leaf photosynthesis of 'Golden Delicious' apple. *Tree Physiol.* 15:35–40.
- Gucci, R., P. D. Petracek, and J. A. Flore. 1991. The effect of fruit harvest on photosynthetic rate, starch content, and chloroplast ultra structure in leaves of *Prunus avium* L. *Adv. Hort. Sci.* 5:19–22.
- Haggag, L. F., M. A. Maksoud, and F. M. Z. El-Barkouky. 1995. Alternate bearing of 'Balady' mandarin as influenced by nutritional status of the tree. *Ann. Agr. Sci. Cairo.* 40:759–764.
- Hampson, C. R., and H. Kemp. 2003. Characteristics of important commercial apple cultivars. p. 61–89. In: D. C. Ferree and I. J. Warrington (eds.), *Apples: Botany, production and uses*. CABI Publ., Cambridge, MA.
- Hancock, J. F., and J. S. Cameron. 1986. The effect of harvesting in the first year on subsequent yield and dry matter portioning in strawberry. *Adv. Strawberry Prod.* 5:7–10.
- Handsack, M. 2000. Komponenten der Ertragsbildung, Ertragsschwankungen und ihre Ursachen, Bekämpfung der Alternanz. p. 210–227. In: G. Friedrich and M. Fischer (eds.), *Physiologische Grundlagen des Obstbaues*. Eugen Ulmer, Stuttgart.
- Hansen, P. 1967. ¹⁴C-studies on apples trees. I. The effect of the fruit on the translocation and distribution of photosynthates. *Physiol. Plant.* 20:382–391.
- Hansen, P. 1969. ¹⁴C-studies on apple trees. IV. Photosynthesis consumption in fruits in relation to the leaf-fruit ratio and the leaf-fruit position. *Physiol. Plant.* 22:186–198.
- Hansen, P. 1970a. The influence of fruit yield on the content and distribution of carbohydrates in apples trees. *Tidsskr. Planteavl.* 74:589–597.
- Hansen, P. 1970b. ¹⁴C-studies on apple trees. VI. The influence of the fruit on the photosynthesis of leaves, and the relative photosynthetic yields of fruits and leaves. *Physiol. Plant.* 23:805–810.
- Hansen, P. 1971a. ¹⁴C-studies on apple trees. VII. The early seasonal growth in leaves, flowers and shoots as dependent upon current photosynthates and existing reserves. *Physiol. Plant.* 25:469–473.
- Hansen, P. 1971b. The effect of fruiting upon transpiration rate and stomatal opening in apple leaves. *Physiol. Plant.* 25:181–183.
- Hansen, P. 1971c. The effect of cropping on the distribution of growth in apple trees. *Tidsskr. Planteavl.* 75:119–127.
- Hansen, P. 1971d. The effects of cropping on uptake, contents, and distribution of nutrients in apple leaves. *Tidsskr. Planteavl.* 75:615–625.
- Hansen, P. 1973. Effect of cropping on the growth and uptake of nutrients by apple trees at different levels of nitrogen, potassium, magnesium and phosphorus. *Acta Agr. Scand.* 23:87–92.
- Hansen, P. 1977a. Carbohydrate allocation. p. 247–258. In: J. J. Landsberg and C. V. Cutting (eds.), *Environmental effects on crop physiology*. Academic Press, London.
- Hansen, P. 1977b. The relative importance of fruits and leaves for the cultivar-specific growth rate of apple fruits. *J. Hort. Sci.* 52:501–508.
- Hansen, P. 1978. Blatt/Frucht-Verhältnisse, Assimilatverteilung und Fruchtentwicklung. *Erwerbsobstbau* 20:228–231.
- Hansen, P. 1980. Crop load and nutrient translocation. p. 201–212. In: D. Atkinson, J. E. Jackson, R. O. Sharples, and W. M. Waller (eds.), *Mineral nutrition of fruit trees*. Butterworths, Boston, MA.
- Hansen, P., and J. V. Christensen. 1974. Fruit thinning. III. Translocation of ¹⁴C assimilates to fruit from near and distant leaves in the apple 'Golden Delicious'. *Hort. Res.* 14:41–45.

- Harley, C. P. 1925. Natural variation in the chemical composition of fruit spurs and the relation of composition to fruit bud formation. *Proc. Am. Soc. Hort. Sci.* 22:134–146.
- Harley, C. P., J. R. Magness, M. P. Masure, L. A. Fletcher, and E. S. Degman. 1942. Investigations on the cause and control of biennial bearing of apples. U.S.D.A. Tech. Bul. 792:1–58.
- Harley, C. P., M. P. Masure, and J. R. Magness. 1932. Effect of leaf area, nitrate of soda and soil moisture on fruit bud formation in 'Delicious' apple. *Proc. Am. Soc. Hort. Sci.* 29:193–198.
- Head, G. C. 1969. The effects of fruiting and defoliation on seasonal trends in new root production on apple trees. *J. Hort. Sci.* 44:175–181.
- Heckenberger, U., U. Schurr, and E-D. Schulze. 1996. Stomatal response to abscisic acid fed into the xylem of intact *Helianthus annuus* (L.) plants. *J. Expt. Bot.* 302:1405–1412.
- Heim, G., J. J. Landsberg, R. L. Watson, and P. Brain. 1979. Ecophysiology of apple trees: dry matter production and partitioning in young 'Golden Delicious' apple trees in France and England. *J. Appl. Ecol.* 16:179–194.
- Herold, A. 1980. Regulation of photosynthesis by sink activity—the missing link. *New Phytol.* 86:131–144.
- Himelrick, D. G., and R. F. McDuffie. 1983. The calcium cycle: Uptake and distribution in apple trees. *HortScience* 18:147–151.
- Ho, L. C. 1996. The mechanism of assimilate partitioning and carbohydrate compartmentation in fruit in relation to the quality and yield of tomato. *J. Expt. Bot.* 47:1239–1243.
- Hoad, G. V. 1978. The role of seeds derived hormones in the control of flowering in apple. *Acta Hort.* 80:93–103.
- Hoffmann, E., and F. Lenz. 1974. Die Photosyntheseraten und Kohlenhydratgehalte der Blätter bei fruchttragenden und nichtfruchttragenden Auberginen- und Erdbeerpflanzen. *Gartenbauwissenschaft* 39:539–547.
- Irving, D. E., and J. H. Drost. 1987. Effects of water deficit on vegetative growth, fruit growth and fruit quality of 'Cox's Orange Pippin' apple. *J. Hort. Sci.* 62:427–432.
- Jackson, J. E. 1975. Effects of light intensity on growth, cropping, and fruit quality. p. 17–31. In: H. C. Pereira (ed.), *Climate and the orchard: Effects of climatic factors on fruit tree growth and cropping in south-eastern England*. Res. Rev. No. 5, Commonwealth Bureau of Horticulture and Plantation Crops. East Malling, Maidstone.
- Jackson, J. E. 1989. The manipulation of fruiting. p. 3–12. In: C. J. Wright (ed.), *Manipulation of fruiting*. Butterworths, London.
- Jackson, J. E., and A. B. Blasco. 1975. Effects of rootstock and crop load on fruit size and quality of 'Cox's Orange Pippin' and 'Worcester Pearmain'. *Annu. Rpt. E. Malling. Res. Sta.* 1974, p. 45.
- Jackson, J. E., and P. J. C. Hamer. 1980. The causes of year-to-year variation in the average yield of Cox's Orange Pippin apple in England. *J. Hort. Sci.* 55:149–156.
- Jackson, J. E., and J. W. Palmer. 1977. Effects of shade on the growth and cropping of apple trees. I. Experimental details and effects on vegetative growth. *J. Hort. Sci.* 52:245–252.
- Jadczyk, E., and F. Lenz. 1994. Effect of nutrient supply and fruit load on K concentration in plant organ of apple. *Gartenbauwissenschaft* 59:149–153.
- Janoudi, A. K., and I. E. Withers. 1993. Water deficits and fruiting affect carbon assimilation and allocation in cucumber plants. *HortScience* 28:98–100.
- Johnson, D. S. 1992. The effect of flower and fruit thinning on the firmness of 'Cox's Orange Pippin' apple at harvest and after storage. *J. Hort. Sci.* 67:95–101.
- Johnson, D. S. 1994. Influence of time of flower and fruit thinning on the firmness of 'Cox's Orange Pippin' apples at harvest and after storage. *J. Hort. Sci.* 69:197–203.

- Johnson, R. S., and A. N. Lakso. 1986. Carbon balance model of a growing apple shoot: I. Development of the model. *J. Am. Soc. Hort. Sci.* 111:160–164.
- Jones, H. G. 1981. Carbon dioxide exchange of developing apple (*Malus pumila* Mill.) fruits. *J. Expt. Bot.* 32:1203–1210.
- Jones, H. G., A. N. Lakso, and J. P. Syvertsen. 1985. Physiological control of water status in temperate and subtropical fruit trees. *Hort. Rev.* 7:301–344.
- Jones, K. M., S. A. Bound, C. R. Drummers, and M. J. Oakford. 1997. Preliminary examination of thinning strategies on young 'Jonagold' and 'Pink Lady' apples. *Australian J. Expt. Agr.* 37:377–382.
- Jonkers, H. 1979. Biennial bearing in apple and pear: A literature survey. *Scientia Hort.* 11:303–317.
- Jonkers, H. 1984. Effect of temperature on formation of flower buds in two apple cultivars. *Acta Hort.* 149:49–51.
- Kachru, R. B., R. N. Singh, and E. K. Chacko. 1971. Inhibition of flowering in mango (*Mangifera indica* L.). *HortScience* 6:140–141.
- Kappel, F. 1991. Partitioning of above-ground dry matter in 'Lambert' sweet cherry trees with or without fruit. *J. Am. Soc. Hort. Sci.* 116:201–205.
- Kazarjan, V. O., N. V. Balagezyan, and K. A. Karapetjan. 1965. The influence of the fruit of the apple trees on the physiological activities of the leaf. *Soviet Plant Physiol.* 12:265–269.
- Kelly, G. J., and E. Latzko. 1976. Regulatory aspects of photosynthetic carbon metabolism. *Annu. Rev. Plant Physiol.* 27:181–205.
- Kelner, J. J., J. L. Regnard, and P. E. Lauri. 2000. Crop load and rootstock effects on maturation rate and harvest quality of cv. Braeburn apples. *Fruits* 55:73–81.
- Kennedy, R. A., and J. A. Fujii. 1986. Seasonal and developmental changes in apple photosynthesis: Enhancement effects due to flowering and fruit maturation. p. 27–29. In: A. N. Lakso and F. Lenz (eds.), *The regulation of photosynthesis in fruit trees*. Symp. Proc. Publ., N.Y. State Agr. Expt. Sta., Geneva, N.Y.
- Khanizadeh, S., D. Buszard, and C. G. Zarkadas. 1992. Effect of crop load on hardness, protein and amino acids content of apple flower buds at the wintering stage and the beginning of the growth. *J. Plant Nutr.* 15:2441–2455.
- Klages, K., H. Donnison, J. N. Wünsche, and H. Boldingh. 2001. Diurnal changes in non-structural carbohydrates in leaves, phloem exudate and fruit in 'Braeburn' apple. *Australian J. Plant Physiol.* 28:131–139.
- Klossowski, W. 1976. Weight and area of leaves, as well as length and thickness of shoots, and development and yield of apples. *Fruit Sci. Rpt.* 3:17–22.
- Koch, K. E. 1996. Carbohydrate modulated gene expression in plants. *Annu. Rev. Plant Phys. Plant Molec. Biol.* 47:509–540.
- Koch, K. E., K. D. Nolte, E. R. Duke, D. R. McCarty, and W. T. Asigne. 1992. Sugar levels modulate differential expression of maize sucrose synthase genes. *Plant Cell* 4:59–69.
- Koike, H., S. Yoshizawa, and K. Tsukahara. 1990. Optimum crop load and dry weight partitioning in 'Fuji'/M.26 apple trees. *J. Jap. Soc. Hort. Sci.* 58:827–834.
- Kondo, S., and Y. Takahashi. 1987. Effects of high temperature in the nighttime and shading in the daytime on the early drop of apple fruit 'Starking Delicious'. *J. Jap. Soc. Hort. Sci.* 56:142–150.
- Kriedemann, P. E., and B. R. Loveys. 1975. Hormonal influences on stomatal physiology and photosynthesis. p. 227–236. In: R. Marcelle (ed.), *Environmental and biological control of photosynthesis*. Dr. W. Junk, The Hague.
- Kriedemann, P. E., B. R. Loveys, G. L. Fuller, and A. C. Leopold. 1972. Abscisic acid and stomatal regulation. *Plant Physiol.* 49:842–847.

- Kriedemann, P. E., B. R. Loveys, J. V. Possingham, and M. Satoh. 1976. Sink effects on stomatal physiology and photosynthesis. p. 401–414. In: I. F. Wardlaw and J. B. Pas-sioura (eds.), Transport and transfer processes in plants. Academic Press.
- Lakso, A. N. 1994. Apple. p. 3–42. In: B. S. Schaffer and P. C. Andersen (eds.), Handbook of environmental physiology of fruit crops. Vol. 1. CRC Press, Boca Raton, FL.
- Lakso, A. N., and L. Corelli Grappadelli. 1993. Implications of pruning and training practices to carbon partitioning and fruit development in apple. *Acta Hort.* 332:231–240.
- Lakso, A. N., L. Corelli Grappadelli, J. Barnard, and M. C. Goffinet. 1995. An exponential model of the growth pattern of the apple fruit. *J. Hort. Sci.* 70:389–394.
- Lakso, A. N., T. L. Robinson, and R. M. Pool. 1989. Canopy microclimate effects on patterns of fruiting and fruit development in apples and grapes. p. 263–274. In: C. J. Wright (ed.), Manipulation of fruiting. Butterworths, London.
- Landsberg, J. J., C. L. Beadle, P. V. Biscoe, D. R. Butler, B. Davidson, L. D. Incoll, G. B. James, P. G. Jarvis, P. J. Martin, R. E. Neilson, D. B. B. Powell, E. M. Slack, M. R. Thorpe, N. C. Turner, B. Warrit, and W. R. Watts. 1975. Diurnal energy, water and CO₂ exchanges in an apple (*Malus pumila*) orchard. *J. Appl. Ecol.* 12:659–684.
- Landsberg, J. J., and H. G. Jones. 1981. Apple orchards. p. 419–469. In: T. T. Kozlowski (ed.), Water deficit and plant growth. Academic Press, New York.
- Lang, A., and R. K. Volz. 1998. Spur leaves increase calcium in young apples by promoting xylem inflow and outflow. *J. Am. Soc. Hort. Sci.* 123:956–960.
- Lavee, S. 1989. Involvement of plant growth regulators and endogenous growth substances in the control of alternate bearing. *Acta Hort.* 239:311–322.
- Leegood, R. C. 1996. Primary photosynthesis production: physiology and metabolism. p. 21–41. In: E. Zamski and A. A. Schaffer (eds.), Photoassimilate distribution in plants and crops. Marcel Dekker, New York.
- Lenz, F. 1970. Einfluß der Früchte auf das Wachstum, den Wasserverbrauch und die Nährstoffaufnahme von Auberginen (*Solanum melongena* L. var. Lange Violette). *Gartenbauwissenschaft* 35:281–291.
- Lenz, F. 1978. Photosynthesis and respiration of citrus as dependent upon fruit load. *Proc. Int. Soc. Citriculture* 70–71.
- Lenz, F. 1979a. Fruit effects on photosynthesis, light and dark respiration. p. 271–281. In: R. Marcelle, H. Clijsters, and W. Van Pouke (eds.), Photosynthesis and plant development. Dr. W. Junk, The Hague.
- Lenz, F. 1979b. Sink-source relationships in fruit trees. p. 141–153. In: T. K. Scott (ed.), Plant regulation and world agriculture. NATO Advanced Study Institute. Plenum Press, New York.
- Lenz, F. 1986. Fruit effects on transpiration and dry matter production in apples. p. 101–104. In: A. N. Lakso and F. Lenz (eds.), The regulation of photosynthesis in fruit trees. Symp. Proc. Publ., N.Y. State Agr. Expt. Sta., Geneva, N.Y.
- Lenz, F. 1989. Effect of training on growth, yield, water consumption and nutrient uptake of density planted trees. *Acta Hort.* 243:195–207.
- Lenz, F., and H. W. Döring. 1975. Fruit effects on growth and water consumption in citrus. *Gartenbauwissenschaft* 40:257–260.
- Lenz, F., and U. Küntzel. 1974. Carbohydrate content of citrus leaves as affected by fruit load. *Gartenbauwissenschaft* 39:99–101.
- Lenz, F., and G. Siebertz. 1980. Trockensubstanzbildung und Stärkegehalt bei Wurzeln von 'Golden Delicious' in Abhängigkeit vom Fruchtbehang. *Erwerbsobstbau* 22:203–204.
- Link, H. 1986. Growth and cropping of apple trees as influenced by growth regulators and pruning methods. *Acta Hort.* 179:207–214.

- Link, H. 2000. Significance of flower and fruit thinning on fruit quality. *Plant Growth Reg.* 31:17–26.
- Looney, N. E., and R. L. Kamienska. 1978. Metabolism of ^3H gibberellin A_4 in relation to flower initiation in apple. *Acta Hort.* 80:105–111.
- Lord, W. J., D. W. Greene, W. J. Bramlage, and M. Dranke. 1979a. Inducing flowering of apples trees and increasing fruit quality by summer pruning. *Compact Fruit Tree* 12:23–29.
- Lord, W. J., D. W. Greene, and R. A. Damon. 1979b. Flowering of young apple trees following summer pruning. *J. Am. Soc. Hort. Sci.* 104:540–544.
- Loveys, B. R., and P. E. Kriedemann. 1974. Internal control of stomatal physiology and photosynthesis. I. Stomatal regulation and associated changes in endogenous levels of abscisic and phaseic acids. *Australian J. Plant Physiol.* 1:407–415.
- Luckwill, L. C. 1970. The control of growth and fruitfulness of apple trees. p. 237–254. In: L. C. Luckwill and C. V. Cutting (eds.), *Physiology of tree crops*. Academic Press, London.
- Luckwill, L. C. 1974. A new look at the process of fruit bud formation in apple. *Proc. XIXth Int. Hort. Congr.* 3:237–245.
- Luckwill, L. C., P. Weaver, and J. MacMillan. 1969. Gibberellins and other growth hormones in apple seeds. *J. Hort. Sci.* 44:413–424.
- Lüdders, P., and T. Fischer-Bölükbası. 1980. Einfluß von Alar und TIBA auf den Mineralstoffgehalt der Früchte bei unterschiedlichem Fruchtbehang. *Gartenbauwissenschaft* 45:235–240.
- Lüdders, P., and T. Fischer-Bölükbası. 1979. Einfluß von Alar und TIBA auf das vegetative Wachstum von Apfelbäumen mit unterschiedlichem Fruchtbehang. *Gartenbauwissenschaft* 44:220–226.
- Mager, A. 1988. Einfluß verschiedener Klimafaktoren auf den Wasserverbrauch in Abhängigkeit von Nährstoffversorgung, Erziehungsmaßnahmen und Fruchtbehang. Dissertation, Bonn.
- Maggs, D. H. 1963. The reduction in growth of apple trees brought about by fruiting. *J. Hort. Sci.* 38:119–128.
- Maggs, D. H. 1964. Growth rates in relation to assimilate supply and demand. I. Leaves and roots as limiting regions. *J. Expt. Bot.* 15:574–583.
- Mansfield, T. A., A. J. Travis, and P. G. Jarvis. 1981. Responses to light and carbon dioxide. In: P. G. Jarvis and T. A. Mansfield (eds.), *Stomatal physiology*. Cambridge Univ. Press, Cambridge.
- Marini, R. P., J. A. Barden, J. A. Cline, R. L. Perry, and T. Robertson. 2002. Effect of apple rootstocks on average 'Gala' fruit weight at four locations after adjusting for crop load. *J. Am. Soc. Hort. Sci.* 127:749–753.
- Masarovicova, E., and J. Navara. 1994. Einfluß des Fruchtbehanges auf CO_2 -Gaswechsel, Wasseraufnahme und Biomassebildung bei Apfel. *Gartenbauwissenschaft* 59:132–138.
- McArtney, S. J. 1994. Exogenous gibberellin affects biennial bearing and the fruit shape of 'Braeburn' apple. *New Zealand J. Crop Hort. Sci.* 22:343–346.
- McArtney, S. J., and S.-H. Li. 1998. Selective inhibition of flowering on 'Braeburn' apple trees with gibberellins. *HortScience* 33:699–700.
- McArtney, S. J., J. W. Palmer, and H. M. Adams. 1996. Crop loading studies with 'Royal Gala' and 'Braeburn' apples: effect of time and level of hand thinning. *New Zealand J. Crop Hort. Sci.* 24:401–407.
- McLaughlin, J. M., and D. W. Greene. 1991. Fruit and hormones influence flowering of apple. I. Effect of cultivar. *J. Am. Soc. Hort. Sci.* 116:446–449.

- Mika, A. 1986. Physiological responses of fruit trees to pruning. *Hort. Rev.* 8:337–378.
- Miller, A. N., and C. S. Walsh. 1988. Growth and seasonal partitioning of dry matter in eight-year-old 'Loring' peach trees. *J. Am. Soc. Hort. Sci.* 113:309–314.
- Minchin, P. E. H., M. R. Thorpe, J. N. Wünsche, J. W. Palmer, and R. F. Picton. 1997. Carbon partitioning between apple fruits: Short and long-term responses to availability of photosynthate. *J. Expt. Bot.* 48:1401–1406.
- Mochizuki, T. 1962. Studies on the elucidation of factors affecting the decline in tree vigor as induced by fruit load. *Bul. Fac. Agr. Hirosaki Univ.* 8:40–124.
- Monselise, S. P., M. Fishler, B. Bravdo, and E. E. Goldschmidt. 1986. Source-sink relationship in citrus: Whole trees vs. girdled branches. p. 98–100. In: A. N. Lakso and F. Lenz (eds.), *The regulation of photosynthesis in fruit trees*. Symp. Proc. Publ., N.Y. State Agr. Expt. Sta., Geneva, N.Y.
- Monselise, S. P., and E. E. Goldschmidt. 1982. Alternate bearing in fruit trees. *Hort. Rev.* 4:128–173.
- Monselise, S. P., and F. Lenz. 1980a. Effect of fruit load on photosynthetic rates of budded apple trees. *Gartenbauwissenschaft* 45:220–224.
- Monselise, S. P., and F. Lenz. 1980b. Effects of fruit load on stomatal resistance, specific leaf weight and water content of apple leaves. *Gartenbauwissenschaft* 45:188–191.
- Mpelasoka, B. S., and M. H. Behboudian. 2002. Production of aroma volatiles in response to deficit irrigation and to crop load in relation to fruit maturity for 'Braeburn' apple. *Postharvest Biol. Technol.* 24:1–11.
- Mpelasoka, B. S., M. H. Behboudian, and S. Ganesh. 2001. Fruit quality attributes and interrelationships of 'Braeburn' apple to deficit irrigation and to crop load. *Gartenbauwissenschaft* 66:247–253.
- Nafziger, E. D., and H. R. Koller. 1976. Influence of leaf starch concentration on CO₂ assimilation in soybean. *Plant Physiol.* 57:560–563.
- Naor, A., I. Klein, I. Doron, Y. Gal, Z. Ben-David, and B. Bravdo. 1997. The effect of irrigation and crop load on stem water potential and apple fruit size. *J. Hort. Sci.* 72:765–771.
- Neales, T. F., and L. D. Incoll. 1968. The control of leaf photosynthesis rate by the level of assimilate concentration in the leaf: A review of the hypothesis. *Bot. Rev.* 43:107–125.
- Neilsen, J. C., and F. G. Dennis, Jr. 2000. Effects of seed number, fruit removal, bourse shoot length and crop density on flowering in 'Spencer Seedless' apple. *Acta Hort.* 527:137–146.
- Nii, N. 1993. Fruiting effects on leaf characteristics, photosynthesis and root growth in peach trees. *J. Jap. Soc. Hort. Sci.* 62:519–526.
- Nii, N. 1997. Changes of starch and sorbitol in leaves before and after removal of fruits from peach trees. *Ann. Bot.* 79:139–144.
- Noga, G., and F. Lenz. 1982a. Einfluß von verschiedenen Klimafaktoren auf den CO₂-Gaswechsel von Äpfeln während der Licht- und Dunkelperiode. *Gartenbauwissenschaft* 47:193–197.
- Noga, G., and F. Lenz. 1982b. Transpiration von Äpfeln während der Licht- und Dunkelperiode in Abhängigkeit von verschiedenen Klimafaktoren. *Gartenbauwissenschaft* 47:274–278.
- Ohme, J., and P. Lüdders. 1983. Einfluß von Stickstoff, Unterlage und Fruchtbehang auf den Wasserverbrauch und die Mineralstoffaufnahme von Apfelbäumen. *Ewerbsobstbau* 25:216–219.
- Oliveira, C. M., and C. A. Priestley. 1988. Carbohydrate reserves in deciduous fruit trees. *Hort. Rev.* 10:403–430.

- Olszewski, T., and A. Mika. 1990a. Influence of orchard cultural practices on mineral composition of apple leaves and fruit. I. Influence of time and type of pruning of young apple trees on mineral content of fruit. *Fruit Sci. Rep.* 17:111–119.
- Olszewski, T., and A. Mika. 1990b. Influence of orchard cultural practices on mineral composition of apple leaves and fruit. II. Influence of apple planting density on mineral composition of fruit. *Fruit Sci. Rep.* 17:121–128.
- Opara, L. U., C. J. Studman, and N. H. Banks. 1997. Physico-mechanical properties of ‘Gala’ apples and stem-end splitting as influenced by orchard management practices and harvest data. *J. Agr. Eng. Res.* 68:139–146.
- Osmond, C. B. 1994. What is photoinhibition? Some insights from comparisons of shade and sun plants. p. 1–24. In: N. R. Baker and J. R. Bowyer (eds.), *Photoinhibition of photosynthesis from molecular mechanisms to the field*. Bios Scientific Publishers, Oxford.
- Palmer, J. W. 1986. Seasonal variation of light saturated photosynthetic rate of ‘Golden Delicious’ apple leaves as influenced by leaf type and crop load, p. 30–33. In: A. N. Lakso and F. Lenz (eds.), *The regulation of photosynthesis in fruit trees*. Symp. Proc. Publ., N.Y. State Agr. Expt. Sta., Geneva, NY.
- Palmer, J. W. 1989. Canopy manipulation for optimum utilization of light. p. 245–262. In: C. J. Wright (ed.), *Manipulation of fruiting*. Butterworths, London.
- Palmer, J. W. 1992. Effects of varying crop load on photosynthesis, dry matter production and partitioning of ‘Crispin’/M.27 apple trees. *Tree Physiol.* 11:19–33.
- Palmer, J. W., R. Giuliani, and H. M. Adams. 1997. Effect of crop load on fruiting and leaf photosynthesis of ‘Braeburn’/M.26 apple trees. *Tree Physiol.* 17:741–746.
- Palmer, J. W., J. P. Prive, and D. S. Tustin. 2003. Temperature. p. 217–236. In: D. C. Ferree and I. J. Warrington (eds.), *Apples: Botany, production and uses*. CABI Publ., Cambridge, MA.
- Pammenter, N. W., F. Loreto, and T. D. Sharkey. 1993. End product feedback effects on photosynthetic electron transport. *Photosyn. Res.* 35:5–14.
- Panthachod, S. 1996. Vegetatives und generatives Wachstum sowie Wasserverbrauch und Nährstoffaufnahme bei Apfelbäumen in Anhängigkeit von Fruchtbehang und Sommerschnitt. Dissertation, Bonn.
- Pearson, J. A., and R. N. Robertson. 1953. The physiology of growth in apple fruits. 4. Seasonal variation in cell size, nitrogen metabolism and respiration in developing ‘Granny Smith’ apple fruits. *Australian J. Biol. Sci.* 6:1–20.
- Petrie, P. R., M. C. T. Trought, and G. S. Howell. 2000. Growth and dry matter partitioning of Pinot Noir (*Vitis vinifera* L.) in relation to leaf area and crop load. *Australian J. of Grape and Wine Res.* 4:40–45.
- Picchioni, G. A., P. H. Brown, S. A. Weinbaum, and T. T. Muraoka. 1997. Macronutrient allocation to leaves and fruit of mature, alternate-bearing pistachio trees: Magnitude and seasonal patterns at whole-canopy level. *J. Am. Soc. Hort. Sci.* 122:267–274.
- Porpigia, P. J., and J. A. Barden. 1981. Effect of pruning on penetration of photosynthetically active radiation and leaf physiology in apple trees. *J. Am. Soc. Hort. Sci.* 106:752–754.
- Preston, A. P. 1954. Effects of fruit thinning by the leaf count method on yield, size and biennial bearing of the apple ‘Duchess Favourite’. *J. Hort. Sci.* 29:269–277.
- Preston, A. P. 1968a. Pruning and rootstock as factors in the production of primary branches on apple trees. *J. Hort. Sci.* 43:17–22.
- Preston, A. P. 1968b. Pruning trials with Worcester Pearmain apple. *J. Hort. Sci.* 43:175–183.
- Preston, A. P. 1969. Pruning and fruit thinning trials with Laxton’s Superb apple on two rootstocks. *Annu. Rep. E. Malling. Res. Sta.* 1968, p. 75–79.

- Preston, A. P., D. E. Belcher, and B. C. Ley. 1981. Apple rootstocks studies: Bramley's Seedling on dwarfing clones. *Expt. Hort.* 32:18–24.
- Preston, A. P., and M. A. Perring. 1974. The effect of summer pruning and nitrogen on growth, cropping and storage quality of 'Cox's Orange Pippin' apple. *J. Am. Soc. Hort. Sci.* 49:77–83.
- Priestley, C. A. 1964. The importance of autumn foliage to carbohydrate status and root growth of apple trees. *Annu. Rep. E. Malling. Res. Sta.* 1963, p. 104–106.
- Priestley, C. A. 1970a. Carbohydrate storage and utilization. p. 113–127. In: L. C. Luckwill and C. V. Cutting (eds.), *Physiology of tree crops*. Academic Press, London.
- Priestley, C. A. 1970b. Some observations on the effect of cropping on the carbohydrate content in trunks of apple trees over a long period. *Annu. Rpt. E. Malling. Res. Sta.* 1967, 121–123.
- Priestley, C. A. 1976. Some effects of ringing branches on the distribution of dry matter in young apple trees. *J. Expt. Bot.* 27:1313–1324.
- Proctor, J. T. A., and J. W. Palmer. 1991. The role of spur and bourse shoot leaves of three apple cultivars on fruit set and growth and calcium content. *J. Hort. Sci.* 66:275–282.
- Proctor, J. T. A., R. L. Watson, and J. J. Landsberg. 1976. The carbon budget of a young apple tree. *J. Am. Soc. Hort. Sci.* 101:579–582.
- Quinlan, J. D., and A. P. Preston. 1968. Effects of thinning blossom and fruitlets on growth and cropping of 'Sunset' apple. *J. Hort. Sci.* 43:373–381.
- Quinlan, J. D., and A. P. Preston. 1971. The influence of shoot competition on fruit retention and cropping of apple trees. *J. Hort. Sci.* 46:525–534.
- Rademacher, W. 1991. Biochemical effects of plant growth retardants. p. 169–200. In: H. W. Gausman (ed.), *Plant biochemical regulators*. Marcel Dekker, New York.
- Raschke, K. 1975. Stomatal action. *Annu. Rev. Plant Physiol.* 26:309–346.
- Ravishankar, H., U. G. Nalawadi and N. C. Hulamani. 1990. Investigations on the use of growth regulators for the control of alternate bearing problem in mango (*Mangifera indica* L.). *South Indian Hort.* 38:234–239.
- Retamales, J. B., and V. P. Lepe. 2000. Control strategies for different bitter pit incidences in 'Braeburn' apples. *Acta Hort.* 517:227–233.
- Robinson, T. L., and A. N. Lakso. 1989. Light interception, yield and fruit quality of 'Empire' and 'Delicious' apple trees grown in four orchard systems. *Acta Hort.* 243:175–184.
- Robinson, T. L., and A. N. Lakso. 1991. Bases of yield and production efficiency in apple orchard systems. *J. Am. Soc. Hort. Sci.* 116:188–194.
- Rogers, W. S., and G. A. Booth. 1964. Relationship of crop and shoot growth in apple. *J. Hort. Sci.* 39:61–65.
- Rom, C. R. 1994. Balancing growth and cropping: which comes first, the canopy or the crop? *Compact Fruit Tree* 27:53–59.
- Rom, C. R., and B. Barritt. 1990. Spur development of 'Delicious' apple as influenced by position, wood age, strain and pruning. *HortScience* 25:1578–1581.
- Rom, C. R., and D. C. Ferree. 1986. Influence of fruit on spur leaf photosynthesis and transpiration in 'Golden Delicious' apple. *HortScience* 21:1026–1029.
- Roper, T. R., J. D. Keller, W. H. Loescher, and C. R. Rom. 1988. Photosynthesis and carbohydrate partitioning in sweet cherry: Fruiting effects. *Physiol. Plant.* 72:42–47.
- Sachs, R. M. 1977. Nutrient diversion: A hypothesis to explain the chemical control of flowering. *HortScience* 12:220–222.
- Salisbury, F. B., and C. W. Ross. 1992. Photosynthesis: Environmental and agricultural aspects. p. 249–265. In: F. B. Salisbury and C. W. Ross (eds.), *Plant physiology*. Wadsworth Publishing Company, Belmont, CA.

- Sams, C. E., and J. A. Flore. 1983. Net photosynthetic rate of sour cherry (*Prunus cerasus* L. 'Montmorency') during the growing season with particular reference to fruiting. *Photosyn. Res.* 4:307–316.
- Satoh, M., P. E. Kriedemann, and B. R. Loveys. 1977. Changes in photosynthetic activity and related processes following decapitation in Mulberry trees. *Physiol. Plant.* 41:203–210.
- Schechter, I., J. T. A. Proctor, and D. C. Elfving. 1994a. Carbon exchange rate and accumulation in limbs of fruiting and nonfruiting apple trees. *J. Am. Soc. Hort. Sci.* 119:150–156.
- Schechter, I., J. T. A. Proctor, and D. C. Elfving. 1994b. Apple fruit removal and limb girdling affects fruit and leaf characteristics. *J. Am. Soc. Hort. Sci.* 119:157–162.
- Schneider, G. W. 1977. Studies on the mechanism of fruit abscission in apple and peach. *J. Am. Soc. Hort. Sci.* 102:179–181.
- Schumacher, R., and W. Stadler. 1987. Zusatzpräparate verbessern die Ausdünnungswirkung von Naphthylacetamid. *Schweiz. Z. Obst-Weinbau* 123:248–252.
- Schumacher, R., and W. Stadler. 1994. Die Alternanz läßt sich auch bei anfälligen Sorten vermindern. *Schweiz. Z. Obst-Weinbau* 130:196–197.
- Schumacher, R., W. Stadler, and J. Boos. 1989. Maßnahmen zur Bekämpfung der Alternanz bei der Sorte 'Boskoop'. *Erwerbsobstbau* 31:21–25.
- Schupp, J. R., and D. C. Ferree. 1987. Effect of root pruning at different growth stages on growth and fruiting of apple trees. *HortScience* 22:387–390.
- Schupp, J. R., D. C. Ferree, and I. J. Warrington. 1992. Interactions of root pruning at deblossoming on growth development and yield of 'Golden Delicious' apple. *J. Hort. Sci.* 67:465–480.
- Schwabe, W. W. 1978. Growth regulators and control of development in fruit trees. *British Crop Protection Council Monogr.* 21:143–157.
- Sharples, R. O. 1968. Fruit thinning effects on the development and storage quality of 'Cox's Orange Pippin' apple fruits. *J. Hort. Sci.* 43:359–371.
- Shear, C. B., and M. Faust. 1970. Calcium transport in apple trees. *Plant Physiol.* 45:670–674.
- Shear, C. B., and M. Faust. 1980. Nutritional ranges in deciduous tree fruit and nuts. *Hort. Rev.* 2:142–163.
- Shen, T. 1941. The influence of leaf-fruit ratio on alternate bearing in the apple. *Proc. Am. Soc. Hort. Sci.* 38:127–132.
- Siebertz, G., and F. Lenz. 1982. Kohlenhydratgehalte von Apfelblättern. *Erwerbsobstbau.* 24:9–12.
- Silbereisen, R. 1976. Über die Wirkungen früher und gröbenselektiver Ausdünnung von Fruchtbehängen auf das Wachstum von Äpfeln. *Angew. Bot.* 50:285–300.
- Singh, L. B. 1948a. Studies in biennial bearing. II. A review of the literature. *J. Hort. Sci.* 24:45–65.
- Singh, L. B. 1948b. Studies in biennial bearing. III. Growth studies in "on" and "off" year trees. *J. Hort. Sci.* 24:123–148.
- Skene, D. S. 1974. Chloroplast structure in mature apple leaves grown under different levels of illumination and their response to changed illumination. *Proc. Royal Society London, Series B.* 186:75–78.
- Southwick, F. W., and W. D. Weeks. 1949. Chemical thinning of apples at blossom time and up to four weeks from petal fall. *Proc. Am. Soc. Hort. Sci.* 53:143–147.
- Sruamsiri, P., and F. Lenz. 1985. Photosynthese und stomatäres Verhalten bei Erdbeeren (*Fragaria X ananassa* Duch.). V. Einfluß des Fruchtbehanges. *Gartenbauwissenschaft* 50:241–248.
- Stiles, W. C. 1987. Tree nutrition, a key to good fruit quality. *Compact Fruit Tree* 20:107–111.

- Stopar, M., U. Bolcina, A. Vanzo, and U. Verhovsek. 2002. Lower crop load for cv 'Jonagold' apples (*Malus domestica* Borkh.) increases polyphenol content and fruit quality. *J. Sci. Food Agr.* 50:1643–1646.
- Streitberg, H. 1975. Der Einfluß unterschiedlicher Strahlungsintensitäten und Wassergaben auf die vegetative und generative Entwicklung von Apfelbäumen in Großgefäßen unter den klimatischen Bedingungen von Dresden-Pillnitz. 3. Mitteilung: Ergebnisse über Blattzahl, durchschnittliche Einzelblattgröße, Gesamtblattgröße, Chlorophyllgehalt und Blattanatomie der Versuchsgehölze. *Archiv Gartenbau* 3–29.
- Strong, D., and A. Miller-Azarenko. 1991. Dry matter partitioning in 'Starkspur Supreme Delicious' on nine rootstocks. *Fruit Var. J.* 45:238–241.
- Taylor, B. H., and D. C. Ferree. 1984. The influence of summer pruning and cropping on growth and fruiting of apple. *J. Am. Soc. Hort. Sci.* 109:19–24.
- Thiebus-Käsberg, P., and F. Lenz. 1994. Einfluß des Fruchtbehanges auf Wachstum, Kohlenhydrat- und Mineralstoffkonzentration der Blätter von 'Golden Delicious' Apfelbäumen. *Erwerbsobstbau* 36:130–133.
- Tough, H. J., D. G. Park, K. J. Crutchley, F. B. Bartholomew, and G. Craig. 1998. Effect of crop load on mineral status, maturity and quality of 'Braeburn' (*Malus domestica* Borkh.) apple fruit. *Acta Hort.* 464:53–58.
- Tromp, J. 1968. Flower-bud formation and shoot growth in apple as affected by shoot orientation. *Acta Bot. Neerl.* 17:212–220.
- Tromp, J. 1976. Flower-bud formation and shoot growth in apple as affected by temperature. *Scientia Hort.* 5:331–338.
- Tromp, J. 2000. Flower-bud formation in pome fruits as affected by fruit thinning. *Plant Growth Reg.* 31:27–34.
- Tustin, D. S., L. Corelli Grappadelli, and G. Ravaglia. 1992. The effect of previous-season and current light environment on early season spur development and assimilate translocation in 'Golden Delicious' apple. *J. Hort. Sci.* 67:351–360.
- Van Nocker, S. 2002. Apple fruit abscission: a molecular approach. International Conference on the Physiological Mechanisms of Apple Fruit Growth and Abscission. Hockley Highlands Conference Centre, Orangeville, Ontario, Canada, 8–10 August 2002.
- Verheij, E. W. M. 1972. Competition in apple as influenced by Alar sprays, fruiting, pruning and tree spacing. *Meded. Landbouwhog. Wageningen.* 72:1–54.
- Volz, R. K., and I. B. Ferguson. 1999. Flower thinning methods affects mineral composition of 'Braeburn' and 'Fiesta' apple fruit. *J. Hort. Sci. Biotechnol.* 74:452–457.
- Volz, R. K., I. B. Ferguson, J. H. Bowen, and C. B. Watkins. 1993. Crop load effects on fruit mineral nutrition, maturity, fruiting and tree growth of 'Cox's Orange Pippin' apple. *J. Hort. Sci.* 68:127–137.
- Volz, R. K., I. B. Ferguson, E. W. Hewett, and D. J. Woolley. 1994. Wood age and leaf area influence fruit size and mineral composition of apple fruit. *J. Hort. Sci.* 69:385–395.
- Volz, R. K., and A. Lang. 2001. Internal gas composition in 'Braeburn' apple as affected by cropping. *Acta Hort.* 553:123–124.
- Volz, R. K., D. S. Tustin, and I. B. Ferguson. 1996. Mineral accumulation in apple fruit as affected by spur leaves. *Scientia Hort.* 65:151–161.
- Wagenmakers, P. S. 1991. Planting systems for fruit trees in temperate climates. *Crit. Rev. Plant Sci.* 10:369–385.
- Walter, T. E. 1967. Factors affecting colour in apples: A review of world literature. *Annu. Rpt. E. Mallng. Res. Sta.* 1966, 70–82.
- Walton, E. F., J. N. Wünsche, and J. W. Palmer. 1999. Estimation of the bioenergetic cost of fruit and other organ synthesis in apple. *Physiol. Plant.* 106:129–134.

- Wang, F., A. Sanz, M. L. Brenner, and A. Smith. 1993. Sucrose synthase, starch accumulation, and tomato fruit sink strength. *Plant. Physiol.* 101:321–327.
- Wang, Z., Z. Yuan, and B. Quebedeaux. 1997. Photoperiod alters diurnal carbon partitioning into sorbitol and other carbohydrates in apple. *Australian J. Plant Physiol.* 24:587–597.
- Wardlaw, I. F. 1980. Translocation and source-sink relationship. p. 297–339. In: P. S. Carlson (ed.), *The biology of crop productivity*. Academic Press, New York.
- Warrington, I. J., T. A. Fulton, E. A. Halligan, and H. N. de Silva. 1999. Apple fruit growth and maturity are affected by early season temperatures. *J. Am. Soc. Hort. Sci.* 124: 468–477.
- Watson, R. L., J. J. Landsberg, and M. R. Thorpe. 1978. Photosynthetic characteristics of the leaves of ‘Golden Delicious’ apples trees. *Plant Cell Env.* 1:51–58.
- Westwood, M. N. 1978. *Temperate-zone pomology*. W. H. Freeman, San Francisco.
- Westwood, M. N., L. P. Batjer, and H. S. Billingsley. 1967. Cell size, number, and fruit density of apples as related to fruit size, position in cluster and thinning method. *Proc. Am. Soc. Hort. Sci.* 91:51–62.
- Wibbe, M. L., and M. M. Blanke. 1995. Effects of defruiting on source-sink relationships, carbon budget, leaf carbohydrates content and water use efficiency of apple trees. *Physiol. Plant.* 94:529–533.
- Wibbe, M. L., and M. M. Blanke. 1997. Effects of fruiting and drought or flooding on carbon balance of apple trees. *Photosynthetica* 33:269–275.
- Wibbe, M. L., M. M. Blanke, and F. Lenz. 1993. Effects of fruiting on carbon budgets of apple tree canopies. *Trees* 8:56–60.
- Wilcox, J. C. 1937. Field studies of apple tree growth and fruiting. III. Some observations on the measurement of the tree vigour. *Scientific Agr.* 17:657–669.
- Williams, M. W. 1979. Chemical thinning of apples. *Hort. Rev.* 1:270–300.
- Williams, M. W. 1981. Managing flowering, fruit set and seed development in apple with chemical growth regulators. p. 273–286. In: W. Meudt (ed.), *Reproduction strategies in plants*. Beltsville Symposium VI, Beltsville, MD (Allanheld Osmum Publ.).
- Williams, M. W., and L. J. Edgerton. 1974. Biennial bearing of apple trees. *Proc. XIX Int. Hort. Congr. (Warsaw)* 3:343–352.
- Williams, R. R. 1970a. Appendix. p. 57–61. In: R. R. Williams and D. Wilson, (eds.), *Towards regulated cropping: a report of recent fruit-set experiments in British orchards*. Grower Books, London.
- Williams, R. R. 1970b. Factors affecting pollination in fruit trees. p. 193–205. In: L. C. Luckwill and C. V. Cutting (eds.), *Physiology of tree crops*. Academic Press, London.
- Williams, R. R., G. M. Arnold, V. A. Flook, and C. J. Jefferies. 1980. The effect of picking date on blossoming and fruit set in the following year for apple cv. Bramley’s seedling. *J. Hort. Sci.* 55:359–362.
- Witte, M. 1994. Jahreszeitliche Entwicklung von Apfelbäumen der Sorte ‘Gloster’/M.9 in Abhängigkeit vom Fruchtbehang. Dissertation, Bonn.
- Wojcik, P., K. Rutkowski, and W. Treder. 2001. Quality and storability of ‘Gala’ apples as affected by crop load. *Folia Hort.* 13:89–96.
- Wood, B. W., and J. L. McMeans. 1981. Carbohydrate changes in various organs of bearing and non-bearing pecan trees. *J. Am. Soc. Hort. Sci.* 106:758–761.
- Wright, C. J. 1989. Interactions between vegetative and reproductive growth. p. 15–27. In: C. J. Wright (ed.), *Manipulation of fruiting*. Butterworths, London.
- Wünsche, J. N. 2001. Neue Verfahren zur quantitativen Erfassung der Assimilatproduktion und -verteilung in Abhängigkeit von Assimilatangebot und Fruchtbehang am Apfel (*Malus domestica* Borkh.). Habilitation, Wehle Verlag, Bonn.

- Wünsche, J. N., D. H. Greer, A. Lang, and D. Hopcroft. 1997. The effect of kresoxim-methyl on gas exchange and growth characteristics of apple. HortResearch Client Rep. 97/272.
- Wünsche, J. N., and A. N. Lakso. 2000a. The relationship between leaf area and light interception by spur and extension shoot leaves and apple orchard productivity. HortScience 35:1202–1206.
- Wünsche, J. N., and A. N. Lakso. 2000b. Apple tree physiology—implications for orchard and tree management. IDFTA Proceedings. Compact Fruit Tree 33:82–88.
- Wünsche, J. N., A. N. Lakso, T. L. Robinson, F. Lenz, and S. S. Denning. 1996. The bases of productivity in apple production systems: The role of light interception by different shoot types. J. Am. Soc. Hort. Sci. 121:886–893.
- Wünsche, J. N., and J. W. Palmer. 1997a. Effects of fruiting on seasonal leaf and whole-canopy carbon dioxide exchange of apple. Acta Hort. 451:295–301.
- Wünsche, J. N., and J. W. Palmer. 1997b. Portable through-flow cuvette system for measuring whole-canopy gas exchange of apple trees in the field. HortScience 32:653–658.
- Wünsche, J. N., J. W. Palmer, and D. H. Greer. 2000. Effects of crop load on fruiting and gas-exchange characteristics of 'Braeburn'/M.26 apple trees at full canopy. J. Am. Soc. Hort. Sci. 125:93–99.
- Zrenner, R., M. Salanoubat, L. Willmitzer, and V. Sonnewald. 1995. Evidence of the crucial role of sucrose synthase for sink strength using transgenic potato plants (*Solanum tuberosum* L). Plant J. 7:97–107.

Chestnut: Botany, Horticulture, and Utilization

Giancarlo Bounous and Daniela Torello Marinoni*

Department of Colture Arboree

Università degli Studi di Torino, Italy

- I. INTRODUCTION
 - A. History
 - B. Production Statistics
 - C. Terminology
- II. BOTANY
 - A. Species and Distribution of genus *Castanea*
 - 1. European Species
 - 2. Asian Species
 - 3. North American Species
 - B. Morphology of European Chestnut
 - 1. Root Systems and Mycorrhiza
 - 2. Trunk and Branches
 - 3. Leaves
 - C. Reproductive Biology
 - 1. Staminate Flowers
 - 2. Pistillate Flowers
 - 3. Blooming
 - 4. Sterility
 - 5. Nut
- III. HORTICULTURE
 - A. Propagation
 - 1. Seed Propagation
 - 2. Vegetative Propagation
 - B. Breeding
 - 1. Objectives
 - 2. Plant Characteristics

*Appreciation is expressed to Jules Janick, Sandra Anagnostakis, Richard Jaynes, Greg Miller, and Shawn Mehlenbacher for constructive comments about this manuscript.

Horticultural Reviews, Volume 31, Edited by Jules Janick
ISBN 0-471-66694-7 © 2005 John Wiley & Sons, Inc.

- 3. Nut Characteristics
- 4. Ease of Propagation
- 5. Resistance to Stress
- C. Orchard Management
 - 1. Planting Establishment
 - 2. Density and Spacing
 - 3. Rootstocks
 - 4. Cultivars
 - 5. Pollinizers
 - 6. Planting and Fertilization
 - 7. Tillage
 - 8. Mulching
 - 9. Weed Control
 - 10. Cover Crops
 - 11. Fertilization
 - 12. Pruning and Training
- D. Harvest
- IV. NUT UTILIZATION
 - A. Postharvest Quality
 - B. Fresh Market
 - C. Storage Methods
 - 1. Ricciaia
 - 2. Curing
 - 3. Sterilization
 - 4. Fumigation by Methyl Bromide
 - 5. Refrigeration in Normal Atmosphere (NA)
 - 6. Controlled Atmosphere Storage (CA)
 - 7. CO₂ Treatment
 - 8. Freezing
 - 9. Drying
 - D. Processing
 - 1. Semi-processed Products
 - 2. Finished Products
 - E. Nutritional Composition and Food Uses
 - 1. Nutritional Value
 - 2. The Chestnut as a Food in the Past and in the Present
- V. THE FUTURE OF THE CHESTNUT INDUSTRY
- LITERATURE CITED

I. INTRODUCTION

A. History

The chestnut is a multifunctional resource and has an invaluable historical and cultural heritage as well as an important economic and environmental role. Since the Middle Ages, the nuts of *Castanea sativa*, a noble hardwood, in Europe, and of *C. mollissima* and *C. crenata* in Asia provided a dietary staple and when dried, a stored food for the whole

year in many rural areas. In North America, *C. dentata*, a forest giant, was a dominant species in the broadleaf forests along the Appalachian range. Before being destroyed by chestnut blight and ink disease, it furnished nuts, fuelwood, building timber, and wood products.

The chestnut is no longer a subsistence food, but continues to play an important role in many agroforestry systems. Nut and timber productions are integrated with many activities related to a multitude of values, and are a sustainable forest resource. The nuts, with both new and traditional methods of storage and processing, reach the market as a large array of commodities and are no longer bread for the poor, but a prized food for an increasingly large market sector.

Chestnuts differ from other nuts by their low fat content, making them ideally suited for high complex carbohydrate and low fat diets. It is a unique nut crop with outstanding potential for diverse high-quality food products: as a vegetable, as bread and pastries, as a dessert, and as a snack. Semiprocessed or finished products include dried chestnuts, flour, *marrons glacés*, creams, peeled and frozen nuts, flakes, and beer or liquor. Roasted chestnuts sold in the street are a popular autumn and winter sight in cities all over the world. In songs and poems, chestnuts recall nostalgic feelings of tradition and happiness.

For optimum economic success, chestnut culture must be readjusted to market demand. Improved cultivars and production methods need to be adopted, and pending problems must be solved. Nuts often do not meet the required quality standards, and improved harvest and postharvest technologies need to be implemented. Two major diseases, canker blight (*Cryphonectria parasitica*) and ink disease (*Phytophthora cambivora*, *P. cinnamomi*) threaten the genus and insects damage nuts and trees. Genetic diversity, as well as existing valuable germplasm, must be conserved (Bounous 2003).

B. Production Statistics

Many countries around the world have suitable soils and climates for chestnut plantations and chestnuts are a nut crop with outstanding potential for commercial orcharding. East Asian production is increasing and new orchards are being established in Europe, North and South America and Australia, due to the high demand for quality nuts.

According to F.A.O. statistics, the world production in 2002 exceeded 900,000 tonnes, with China and South Korea accounting for more than 50% of the total (Table 6.1). China tremendously increased harvests over the last few years. In Europe, Italy and Turkey are the leading producers, followed by Portugal and Spain; other European producers are

Table 6.1. World chestnut production, 2002.

Country	Production (tonnes)	% of total
China	599,077	62.80
South Korea	94,000	9.85
Italy	50,000	5.24
Turkey	50,000	5.24
Japan	30,100	3.16
Portugal	31,000	3.25
Spain	10,000	1.05
Russian Federation	16,000	1.68
France	14,075	1.48
Greece	12,000	1.26
North Korea	8,700	0.91
Others	39,048	4.08
Total	954,000	100.00

Source: F.A.O. (www.fao.org).

the Russian Federation, France, and Greece. Trends in chestnut production are shown in Fig. 6.1.

C. Terminology

The English word chestnut (Middle English *chasten nut* of *chasteine*) derives from the French *châtaigne*, from the Latin *castanea*, from Greek *kastanea*. The word chinkapin used for the nuts of some American species of *Castanea* is derived from the Native American (Algonquian) word *chechinkamin*.

The words “chestnut” and “marrone” are often misunderstood and confused among wholesalers, traders, and consumers. Often the word “marroni” is used to mean very large chestnuts, but in France the term *marron* is used specifically for nuts having no epispERM (pellicle) intrusion in the kernel and with less than 12% of split nuts, while the term chestnut is used if more than 12% of the nuts are split (Bergougnoux et al. 1978). However, these terms do not have any biological basis. In Italy, *marroni* means a variety of *Castanea sativa* of excellent quality, with an oblong shape, a reddish colored epicarp (shell) that is shiny with dense, often raised stripes, and a small semi-rectangular shaped hilar scar. Large-sized marrons are not divided and have a sweet flavor, with the kernel itself free of hollows and easily separable from the pellicle, which does not penetrate the cotyledon (no split nuts). The pellicle is only superficially attached to the nut and is easily removable by mechan-

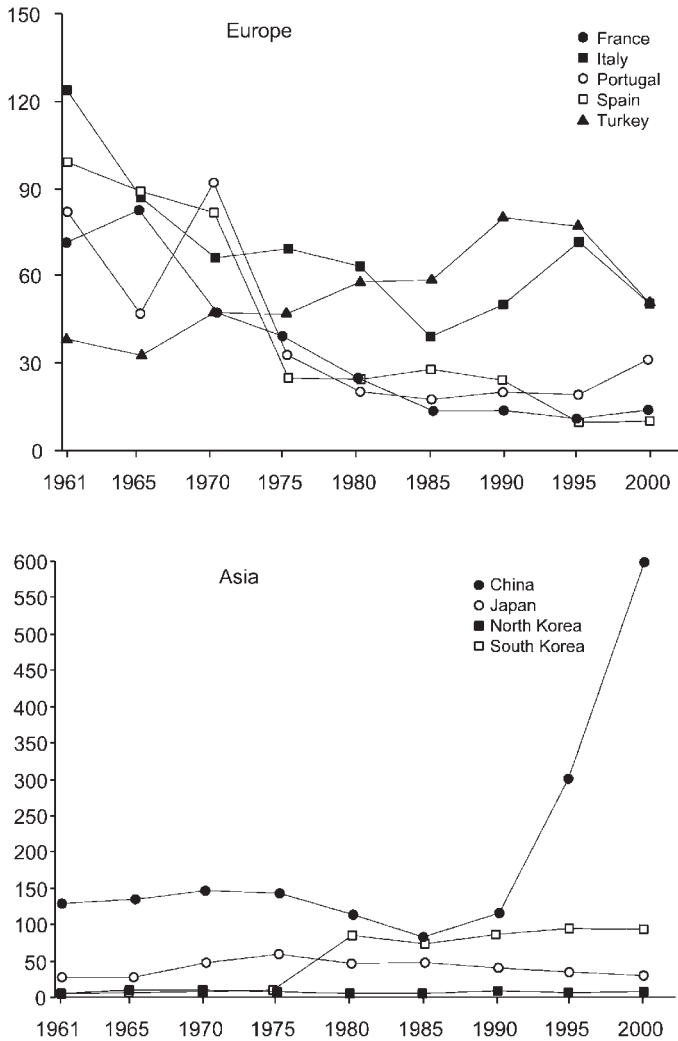

Fig. 6.1. Trends in chestnut production in Europe and Asia (in thousands of tonnes).

ical means, facilitating processing. Fenaroli (1945) adds that marrons, compared to other *Castanea*, are more demanding in terms of climatic and soil requirements, are generally less productive, and their burs contain only 1 or 2 nuts. Marrons have sterile male flowers (Breviglieri 1955a,b).

II. BOTANY

A. Species and Distribution of genus *Castanea*

Fagaceae (*Cupuliferae*) includes six genera (*Castanea*, *Castanopsis*, *Fagus*, *Lithocarpus*, *Nothofagus*, and *Quercus*) and about a thousand species. The genus *Castanea* is widespread in the Boreal Hemisphere (Fig. 6.2) and includes 12 or 13 species according to classification (Table 6.2). The natural distribution of European chestnut (*Castanea sativa*) includes Europe and all Mediterranean countries. In Asia (China, Korea, Japan, and Vietnam), *C. crenata*, *C. mollissima*, *C. seguinii*, *Castanea henryi* occur. In North America, *C. dentata* is found from Ontario and Maine and along the Appalachian Mountain Range into Georgia and Alabama (Camus 1929) and *C. pumila* in the southeastern states.

All species are diploids ($x = 12$; $2n = 24$) (Jaynes 1962). The genus is taxonomically divided into 3 sections: *Eucastanon*, *Balanocastanon*, and *Hypocastanon*, but further revisions are expected (Johnson 1988) due to new genetic studies contesting the validity of this classification (Santamour et al. 1986).

Castanea is highly variable, reflecting adaptation of the genus to different environmental conditions. *Castanea* species show variability for

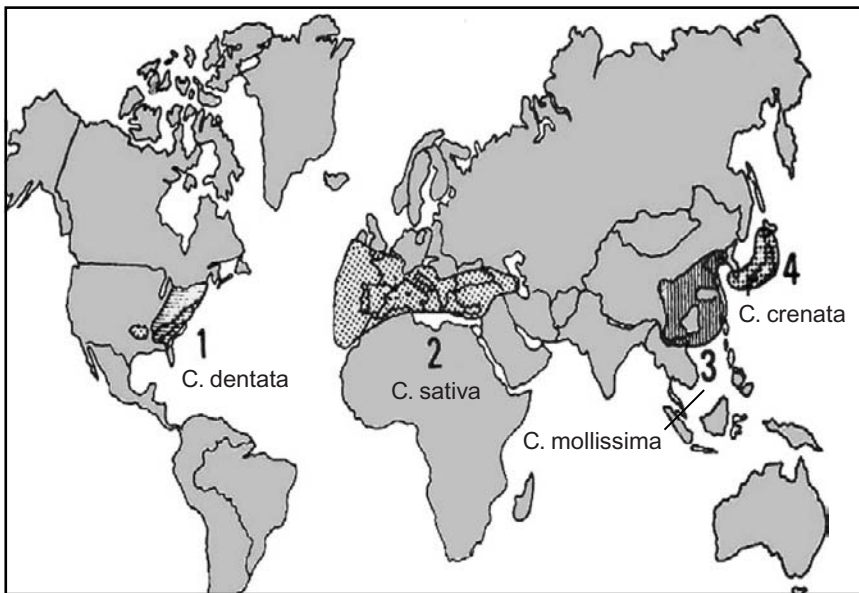

Fig. 6.2. Main chestnut species and distribution.

Table 6.2. Origin and distribution of *Castanea*.

Origin	Section	Species	Common name	Planted	Prevalent use
Europe	Eucastanon	<i>C. sativa</i> Mill.	European or sweet chestnut	Europe, Asia Minor, North Africa	Nut, timber
Asia	Eucastanon	<i>C. crenata</i> Seib & Zucc.	Japanese chestnut	Japan, Korea	Nut
		<i>C. mollissima</i> Blume	Chinese chestnut	China	Nut
	Hypocastanon	<i>C. seguinii</i> Dode		China	Firewood
		<i>C. davidii</i> Dode		China	Firewood
America	Eucastanon	<i>C. henryi</i> (Skan) Rehd. & E.H. Wils.	Willow leaf or pearl chestnut	China	Timber
		<i>C. dentata</i> (Marsh.) Borkh.	American chestnut	North America	Timber
	Balanocastanon	<i>C. pumila</i> (L.) Mill. var. <i>pumila</i>	Allegheny chinkapin	Southeast United States	Nut
		<i>C. pumila</i> (L.) Mill. var. <i>ozarkensis</i>	Ozark chinkapin	United States (Arkansas, Missouri, Oklahoma)	Timber
		<i>C. floridana</i> Ashe (Sarg.)	Florida chinkapin	Southeast United States	Ornamental
		<i>C. ashei</i> (Sudw.) Ashe	Ashe chinkapin	Southeast United States	Ornamental
		<i>C. alnifolia</i> Nutt.	Creeping chinkapin	Southern United States (Alabama-Florida)	—
		<i>C. paucispina</i> Ashe		Southern United States (Texas-Louisiana)	—

morphological and ecological traits, vegetative and reproductive habits, nut size, wood characteristics, adaptability, and resistance to biotic and abiotic stresses.

Species in the *Eucastanon*, which includes the most economically important species, display high genetic diversity. Different species are found on very different pedoclimates, but they prefer deep, soft, acidic soils (pH ranging from 4 to 6.5), temperate climates, and rainfall ranging from 700 to 1500 mm/year. The latitude distribution is related to altitude. At low latitude, chestnut trees are found above 1500 m a.s.l., as on the slopes of Mount Etna in Italy (Polacco 1938), on the Sierra Nevada in Spain, and in the Caucasus where the species thrives at an elevation of 1800 m (Fenaroli 1945).

Tree shape and form are variable. *Castanea dentata* and *C. sativa* are upright, tall and slender trees, but some species have smaller size, round foliage and branches that start from the base. Other species are dwarf shrubs. Plants can live and be regularly productive for centuries. The plant begins to produce nuts from 2 to 3 years to 15 or 20 years. Some species grow rapidly and re-sprout quickly when cut.

1. European Species. The genus *Castanea* appeared at the end of the Miocene epoch (15 million years ago) (Giordano 1993) and its indicators (*Cupuliferae* dissemination) include oak and beech. Leaves and one fossil chestnut resembling European chestnut dating back to 8.5 million years ago were found in Coiron Massif, France (Breisch 1995). During the quaternary era glaciations, chestnut trees receded southward (at the end of Würmian glaciation).

In Europe, there were two taxa of chestnut: *C. sativa* and *C. latifolia* Sord. (Paganelli 1997). At the end of the last glaciation (Würmian), as pollen charts demonstrated, only *C. sativa* survived. *C. sativa* is now the only native species in the Mediterranean and Central European regions.

The European or sweet chestnut grows in all Mediterranean countries where climatic conditions are suitable. Native or cultivated forests of this species extend from the Caucasus through Turkey, Greece, and Slovenia to Italy, France, Spain, Portugal, Germany, and Southern England. It is found in small areas bordering North Africa: Morocco, on the Beni-Hoçmar Mountains (Fernández De Ana Magán et al. 1997); Algeria, on the Atlas range; Tunisia, where it was probably introduced during the period of French domination. It grows in the Canary and Azores Islands (Ferreira Batista 1993) and is found to a smaller extent in Syria and Lebanon.

Since the Roman Empire, the chestnut tree has been cultivated and spread beyond its natural zone, not always in the best pedoclimates. It was a staple food in marginal or mountainous South European regions and human survival in some countries was due to chestnut—this relation was called “chestnut civilization.” Chestnuts were the basic food, the timber was used for several purposes (furniture, building construction, poles, fuel wood), and foliage was first used for livestock bedding and then as a fertilizer.

Castanea sativa is a tall tree of majestic appearance; it is vigorous and can exceed 30 m in height and 400 years of age. Some century-old trees measure 6–7 m in girth. The nut (10–30 g) has a white-cream pulp and it can have pellicle intrusions into the kernel.

Among the most important features of *Castanea sativa* is large nut size, with high density and sweet taste. The tree form is typically upright with high vigor, strong branches, and quality timber. However, *C. sativa* can suffer from ink disease and canker blight, although some genotypes are partially *Phytophthora*-resistant (Salesses et al. 1993a,b).

In Europe, the germplasm is very broad and the risk of genetic erosion is high, mostly in marginal or abandoned zones (Grassi 1992; Pisani 1992). The conservation of the most interesting plants, selected over centuries, is necessary to maintain valuable genotypes. Many research institutes have pursued studies on identification, description, and preservation.

There are hundreds of cultivar names used for chestnuts, many of which are synonyms. European chestnuts are sold as fresh nut (consumed boiled or roasted), dried, candied, or ground into flour. Some clones have been selected for the high quality of their timber and some others for both nut and timber characteristics (Gellini et al. 1977).

2. Asian Species

Castanea crenata (Japanese Chestnut). *Castanea crenata* can be dated by fossil findings to the middle of Jomon Civilization (1000–4000 B.C.E.). From the zone of origin it was spread from Japan to Korea and to North-east China, and it was naturalized in South Korea and in Taiwan.

C. crenata has been cultivated in Central and South Japan for 2000 years. It can be found between paddy fields and conifer forests, on fertile, recent volcanic soils. It prefers a mild summer climate, not too cold in winter, with high rainfall (1200–1400 mm/year) in summer. On the southern Japanese Islands, where there is abundant summer rain and mild winters, *C. crenata* grows to 1300 m a.s.l. It is not as cold resistant

as American and Chinese species (Rutter et al. 1991) and early flowering makes it sensitive to late spring frosts (Breisch 1995).

The tree normally does not exceed 8–10 m in height but can reach 15 m, and 60 cm in diameter. Young trees have smooth, thin, brown-olive green bark and lenticels that extend crosswise. Adult trees have brown bark with irregular and deep cracks that sometimes peel in thin strips. Buds are small, brown-reddish or brownish, ovate, hairless, and bright. The adaxial side of leaves is dark-green and the abaxial side is light green. Leaves are acute with strongly marked edges, and leaf margins are crenate. Young leaves have scattered, disk-shaped trichomes and have long, protective, whitish pubescence on major veins (Camus 1929).

The tree shows precocious blossoming and bears nuts in 3 to 4 years. Chestnut burs grow in the middle of twigs and not on tips, and are covered by 8- to 12-mm-long frail irregular thorns, divaricated, either hairless or with slight pubescence. The stalk is short and stumpy. Nuts ripen early in September to October and productivity is high. The nuts of *C. crenata* vary greatly among trees; some are the largest in the genus and can weight more than 30 g. The hilum scar is very wide and reaches the medium part of the chestnut. They are not often sweet, sometimes astringent, and have an adherent pellicle that is difficult to separate from the kernel (Tanaka and Kotobuki 1992). Wild chestnut forests provide a timber used for buildings, posts, poles, fuel wood, or as a substrate in mushroom farming.

Rutter et al. (1991) believe that Japanese chestnut is one of the most important sources of resistance to *Phytophthora*. In France, *C. crenata* germplasm has been used to a large extent in breeding programs to obtain *Phytophthora*-resistant trees (Salesses et al. 1993a). The species is more susceptible to blight than the Chinese chestnut. Many cultivars have outstanding nut quality, but they can be attacked by the gall wasp *Dryocosmus kuriphilus*, which has reduced new plantings in Japan. The Japanese chestnut was introduced into the United States in 1876 (Rosen-garten 1984).

Castanea mollissima (Chinese Chestnut). This species owes its name to the thick pubescence on buds and on the abaxial side of leaves. This is the important native nut species in China. *C. mollissima* grows in subtropical, temperate-continental, and temperate-maritime regions with mild winters and hot summers where rainfall is about 1000 mm/year (mostly in the summer). Chinese chestnut has been introduced into many countries because of its plasticity and adaptability to different pedoclimates. It has long been grown for its good quality nuts, but is also a source of firewood. In natural stands it forms a mixed forest with bam-

boo, chinese fir, and other native species. Chestnuts are harvested from plantations established in the past few years from grafted plants.

C. mollissima thrives from 41°29'N latitude in Jilin Province, close to Korea, to 18°31'N latitude North of Hainan Island. It grows in Hebei and Shandong, in the Yangtze Valley, from west to east and in Sichuan, Hubei, Anhui, Jiangsu and, in the southwest, in Yunnan Province, close to the Vietnamese border. It grows from 50 to 2800 m a.s.l. in a wide range of climatic conditions.

Many cultivars and local ecotypes have been described, of which about 50 are cultivated. They are divided into six groups with different morphological, physiological, horticultural, and geographical features. Promising germplasm includes plants with burs that turn red early in fall, with hanging branches, and some precocious dwarf types suitable for high-density plantations (Liu 1993).

Chinese chestnut is considered the most resistant *Castanea* species to canker blight caused by *Cryphonectria parasitica*. This disease was first confirmed in China in 1913 by Frank Meyer (Fairchild 1913) and is widespread. Hypovirulence has been reported. Major damage to plants is caused by the gall wasp.

C. mollissima is a medium-sized tree: 12 m tall and trunk diameters up to 75–80 cm. Its crown is spherical, the trunk branches close to the ground. The form can be weeping, and during fruiting this feature becomes more evident. The trunk is pale grey, smooth when young, with whitish stripes connected with fissures. The cylindrical branches on the distal part have light, supple ribs varying in vigor and the branches can be pubescent, with a yellowish-tan color, sometimes wool-like and can become whitish. In autumn, the wood becomes reddish-brown with some lenticels of the same color. Leaves are medium-sized, elliptical, with wide and thick edges; they have a wedged or rounded base and are almost asymmetrical; the tip is stumpy, short and mucronate. Leaf serrations are large, irregular, not well pronounced, and have a hairy, mucronate point. The adaxial leaf surface is bright green, and the abaxial surface is grey-whitish or velvet due to pubescence.

Blooming and fruiting habits are variable. Plants bear fruit 1–3 years after grafting, in mid-August to November. Sturdy and handsome, *C. mollissima* is well suited for yard and orchard culture.

Burs differ in size and are sometimes small; they have a yellow or brown-reddish color. The nuts are round or elliptical and show a long torch (the tip of the nut, formed by the remains of the styles) covered by a thick, white-cream pubescence; the pulp is very sweet, but not so sweet as the American chestnut, and is richer in proteins than the Japanese and European species. Hilum scar is wide but less developed than

in *C. crenata*. Chestnuts show thin, easy-to-peel pellicle (not invading the kernel); kernels are sweet and ripen early. In the Northern regions, chestnuts are small (< 15 g), show bright color, have a good and sweet taste. In subtropical regions, the nuts of most cultivars are large (15–20 g) with high starch content.

Seedlings of *C. mollissima* were introduced by the U.S. Department of Agriculture into the United States and are widely grown in the eastern United States. In Connecticut, seedlings regularly produce large quantities of large nuts (Anagnostakis 1992). *C. mollissima* orchards in the southeastern United States, were very productive but production decreased with the introduction of the gall wasp (Payne and Johnson 1979). The most popular *C. mollissima* cultivars in the United States are 'Crane' and 'Nanking' and the hybrids 'Colossal', 'Sleeping Giant', and 'Dunstan' (Craddock 1998).

Castanea seguinii. This small tree or shrub is scattered in subtropical regions or in southwestern China. The very small nuts (2–4 g) are harvested for nourishment by rural people. Trees are periodically coppiced to produce firewood. They have early flowering and continue to flower through the bearing season until frost (Rutter et al. 1991). In autumn, on the same tree it is possible to find ripe nuts on the base of the twigs and catkins in different growth phases. Other genotypes, coming from Jiangsu province, show shoots with 10–20 burs. The reflowering feature appears to be regulated by two recessive genes and early flowering depends on one dominant gene (Jaynes 1975). Genetic diversity has been studied through isoenzymes (Huang and Norton 1992) with the aim of finding compatible genotypes to produce dwarf rootstocks.

C. seguinii buds are damaged by *Dryocosmus kuriphilus*, the most damaging pest in Asia for chestnut species. In Hubei, chestnut trees of *C. seguinii* are planted as a hedge in plantations as a trap crop. The insect lays eggs on buds of the shrubs, making it easy to cut and destroy the infested twigs (Rutter et al. 1991) and reduce the infestation on cultivated plants of *C. mollissima*.

Castanea davidii. Some authors consider *C. davidii* Dode a variety of *C. seguinii* based on many affinities.

Castanea henryi. Known as the willow leaved chestnut, or pearl chestnut, the species is a native of warm temperate subtropical climates of China. It grows along the Yangtze River Valley and southern regions. It is cultivated for timber in Fujian and Zhejiang provinces.

C. henryi is a forest species that rapidly grows with an upright (slender) trunk over 30 m tall. Among Chinese chestnut trees it is the best species for timber production. The chestnuts (one per bur) are small (3–6 g) and marketed to some extent. *C. henryi* is considered canker blight resistant (Camus 1929) and there is evidence of high variability based on seedling studies (Rutter et al. 1991). This species appears to be resistant to Asian Chestnut gall wasp.

3. North American Species

Castanea dentata (American Chestnut). *Castanea dentata* grew in Long Island 30,000–50,000 years ago, based on pollen dating back to the last inter-glacial periods. It is native to the eastern United States and Canada and it was spread from Ontario and Maine (on the Appalachian Range) to Georgia and Alabama, where it was long a dominant species. Its natural range once covered more than 200 million acres from the Canadian border to the Gulf of Mexico. In pre-Columbian times, the Indians ate the nuts raw or cooked. The Iroquois from New York called the chestnut tree “*o-heh- yah-tah*,” meaning prickly bur (Rosengarten 1984). It grows rapidly, with an upright, slender trunk that can exceed 30 m high and a diameter of 3 m or more. Before the chestnut blight epidemic it had great importance for timber production.

The destruction of *C. dentata* by canker blight, *Cryphonectria parasitica*, was the greatest disaster in the history of forest pathology (Roane et al. 1986; Anagnostakis 1987). The canker, identified first in New York in 1904 at the Bronx Zoological Park, led to the complete removal of the species from the forest canopy. West of the native range it is possible to find adult trees that have escaped the blight.

C. dentata is the most cold-resistant species of the genus. Northern zone genotypes can survive to -35°C (Ashworth 1964).

Stems are small, sharp, brown and hairless. Leaves are similar in shape and dimension to *C. sativa*, and are generally hairless (some have only a few hairs on the mid-vein), and thin. They have large serrations, a short stalk and are light green when fully developed. Branches are brown and hairless. Nuts are sweet, not astringent, and very small, with a thin pellicle easily removed from the kernel. Chestnuts were known and eaten by Native Americans and provided food for livestock and wildlife.

Castanea pumila. This polymorphic species is divided into two botanical varieties: *C. pumila* var. *pumila* (Allegheny chinkapin) and *C. pumila* var. *ozarkensis* (Ashe) Tucker (Ozark chinkapin) (Johnson 1987, 1988). It is native in the United States from the east and southeast to the

Ozark mountains of Arkansas to Missouri and Oklahoma (Camus 1929). Chinkapin tree shapes can be bushy (*pumila*), creeping (with some reported to be stoloniferous) or 20 m tall (*ozarkensis*) (Pardo 1978; Johnson 1988). It is found in sandy soils from south of New Jersey and Pennsylvania to western Indiana and Missouri and in South Florida and Texas.

Foliage is thick and leaves are 4 to 22 cm long; they are sharp and vary from bright yellowish-green to light green. The adaxial side is hairless; the abaxial side is hairy and whitish with rough dentate margins. A high variability of leaf forms, size and color has been observed in the same plant. Catkins appear after the first leaves open. The staminate inflorescences are at the base of the shoots, and the bisexual ones grow on the distal part. Pistillate flowers are located at the base of catkins.

Burs are small (1–5 cm in diameter) with soft thorns. They remain on the branches and contain a single nut, sometime remaining all winter long. These sweet and good-tasting chestnuts are very small (1 g).

There are some cultivars such as 'Fuller', 'Rush', and 'Golden' (Payne et al. 1994), but extensive culture is difficult because of harvesting problems due to the small size of nuts and their early germination, which begins soon after harvest. Small size, early production (2–3 years) and productivity are features that should allow *C. pumila* var. *pumila* to be used as genetic material to obtain new, productive, precocious clones, suitable for high-density plantations, adapted to warm temperate regions (Payne et al. 1991, 1994).

Castanea floridana. This is a decorative bushy plant native to the southeastern United States from Florida to Texas, where it is known as Florida chinkapin. It can be 6–7 m high. The nuts (one per bur) are very small, and the plants flower much later in the season than *C. pumila*.

Castanea ashei. Ashe. Ashe chinkapin is a 6–7 m tall tree scattered in North Carolina, Georgia and Florida.

Castanea alnifolia. Shrub or creeping chinkapin is a creeping shrub (30–60 cm) originating in the southern United States, from Alabama to Florida.

Castanea paucispina. The distribution area of this creeping shrub (30–60 cm) includes Texas and Louisiana.

B. Morphology of European Chestnut

The main phenological stages of European chestnut are shown in Table 6.3.

Table 6.3. Main phenological stages of European chestnut.

Time	Vegetative growth	Staminate flowering	Pistillate flowering; nut ripening
Mid–end of March	Bud swelling		
End of March–beginning of April	Perule breakage		
Mid–end of April	Young leaves growth and perule drop	Catkin appearance (length 0.5–1 cm)	
End of April–middle of May	Well evident young leaves		
Middle of May–beginning of June	Leaves full growth	Well evident glomerules. Catkins reach the final length.	Flower appearance
Mid–end of June		Stamen appearance	Flower growth
June–middle of July		Pollen emission. Full anthesis	Well evident styles; receptive stigmas
End of August–November	Leaves turn brown and fall		Nut ripening

1. Root Systems and Mycorrhiza. The root system is strong, expanded, and penetrates the soil deeply; the smallest roots are abundantly covered by ectomycorrhiza. These mycorrhiza form a highly specialized association between plant and fungus.

Mushrooms of high gastronomic interest live in symbiosis with chestnut and are important by-products. Basomycetes include *Amanita caesarea* (king), *Boletus edulis* (boletus), *Cantharellus cibarius* (chanterelle), *Lactarius laccata* (Meotto et al. 1999). Ascomycetes (sac fungi) include *Tuber* and *Terfethia*. The mycorrhization of the chestnut tree was suggested by Chauvin et al. (1988) as a biological control for ink disease.

2. Trunk and Branches. The trunk is straight and strong. Young trunk bark is smooth and bright; its color is reddish-brown that turns to olive-gray with some long lenticels. After 20–25 years the bark has deep longitudinal grooves. The wood has thin, yellowish-white sapwood and brown heartwood and is rich in tannin (5–7%). Vigorous suckers grow at the trunk base.

Young branches have bark that is smooth, bright, brown-reddish that becomes gray olive-green upon aging with some peculiar roundish and whitish lenticels. Buds are protected by two bud scales; they are ovate, hairless, green-reddish, and fit into leaf scars in a spiral phyllotaxy.

3. Leaves. Leaves are deciduous, simple, alternate, in a spiral phyllotaxy, with petioles 15–25 mm long. They are elliptical-lanceolate in shape with a round-wedged base and serrated, with crenate margins, and an acute apex. They are 12–20 cm long and 3–7 cm wide. Leaf consistency is coriaceous; the adaxial side is shiny, hairless and deep green; the abaxial side is dull, light green.

Compared to *C. sativa*, *C. crenata* has smaller leaves (9–15 cm × 3–3.5 cm) with serrated margins. *C. mollissima* leaves are large (15–20 cm × 5–7 cm) with irregular serrated margins; the abaxial surface is covered by thin hairs with agreeable-smelling glands along the central, superior and inferior veins (Graves 1961). *C. dentata* leaves are large, narrow, sharp and bright; they are nearly hairless, and a paler green than *C. sativa*.

C. Reproductive Biology

Chestnut is a monoecious species and on the same tree there are staminate and pistillate flowers in two different kinds of catkins: staminate and bisexual. At the base of the shoots there are unisexual catkins; on the distal part they are bisexual. The number of catkins per shoot varies from 6 to 16 (Soylu and Ayfer 1993).

1. Staminate Flowers. These flowers occur in a spiral, along the unisexual or bisexual catkins. The catkins are very striking, up to 35 cm long (normally 15–20 cm) with a sweetish, musky, peculiar scent. Each unisexual catkin is composed of flowers gathered in glomerules (axillary cymes) of 3–7 flowers each; the glomerules medium number is 40 per catkin (Fig. 6.3). Four types of catkins can be distinguished: longistaminates, mesostaminates, brachistaminates, and astaminates. Almost all catkins of *C. mollissima* and *C. crenata* have longistaminate flowers, as do some cultivars of *C. sativa* and many Euro-Japanese hybrids.

Only staminate flowers having stamens with long (5–7 cm) filaments (longistaminates) with well-formed anthers are fertile. They contain a large quantity of pollen, > 1500 grains/anther (Basso 1955).

Pollen has an elongated shape, with a dullish yellow color. Jaynes (1975) and Maynard (1991) suggest procedures to collect pollen. Catkins have to be gathered at the beginning of anthesis until full blossoming. Pollen does not develop on flowers from branches cut early to “force”

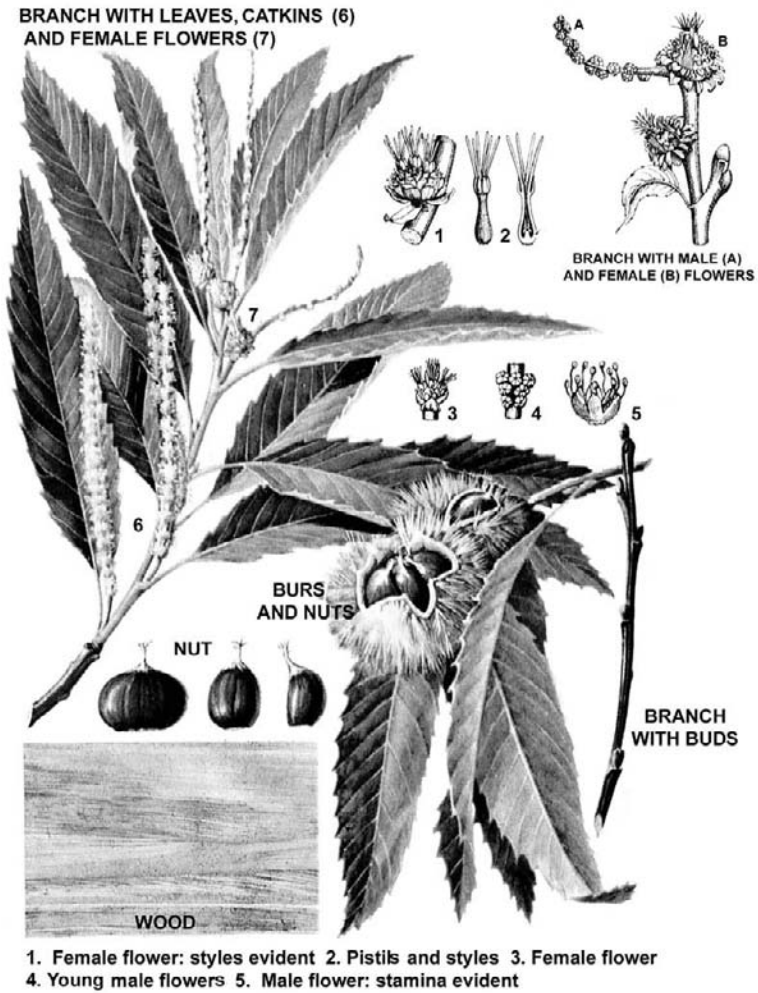

Fig. 6.3. Morphology of European chestnut (Fenaroli 1945).

bloom. Forcing branches does not give positive results. Light-colored catkins generally have a larger quantity of live pollen than darker-colored ones. Unisexual catkins are best, as bisexual catkins often produce non-functional pollen.

2. Pistillate Flowers. These flowers are gathered in globular inflorescences at the base of bisexual (androgynous) catkins. The number of inflorescence per catkin varies from 4 to 5, but only 2 or 3 of them are

fertile. Each inflorescence generally contains three flowers; they are protected by a green, scaled wrapping that is destined to form the cupule that develops into the chestnut bur. There are many ovules in each flower, normally 6, and they produce a nut with one or more seeds.

3. Blooming. Compared with other tree species of temperate climates, the chestnut is late blooming. Flowers bloom only after leaves are completely open. Protandry (pistillate flowers open after staminate) is the norm. In the same cultivar, catkins anthesis occurs 7–10 days before pistillate flowers (Soylu and Ayfer 1993). Unisexual catkins blossom before bisexual ones and the phenomenon has been named duodicogamy by Clapper (1954). Pollen production continues for about a month due to the gradual blossoming, while pistillate receptivity lasts 2 or 3 weeks. Full pistillate flowering is considered when the styles are completely evident and there is maximum receptivity.

Pollination is considered by some authors to be prevalently anemophilous; others consider it entomophilous. According to Breviglieri (1951), insects and wind have equal roles as pollinators. The presence of nectar, pollen grain viscosity, the stiff and smooth stamens and the catkins' strong scent, are attractive to insects and suggest entomophilous pollination (Morettini 1949; Breviglieri 1951; Solignat 1958; Solignat and Chapa 1975). Porsch (1950) observed that catkins are visited by bees and 134 other insect species belonging to 6 different orders, the majority of them *Coleoptera*.

Clapper (1954) considered anemophilous pollination to be the natural way to spread pollen and suggested that insect pollination is unnecessary. In trees with astaminate or brachystaminate catkins, pollination occurs without the help of insects (Solignat and Chapa 1975). According to Porsch (1950), insects have a minimal pollinating function because while they visit staminate flowers, they only occasionally visit pistillate flowers.

Anemophilous dispersion of chestnut tree pollen can take place in a range of 30 km (Peeters and Zoller 1988) to 100 km (Tampieri et al. 1977). However, within 20–30 m, pollen density is modest depending on wind direction and humidity (Pisani and Rinaldelli 1991). The period between pollination and nut ripeness varies from 70 to 120 days, from early September to the middle of November.

Seedlings of *C. sativa* start blooming at the age of about 10–15 years. Grafted trees start flowering in the 4th or 5th year. Oriental species and Euro-Japanese hybrids are usually more precocious than *C. sativa*.

4. Sterility. The chestnut is mainly self-sterile (McKay 1942; Clapper 1954; Jaynes 1975). The first systematic researches on blooming biology were done by Morettini (1949) and Breviglieri (1951), who observed self-

incompatibility in the cultivars studied. The pollination period influences the number of nuts in the bur (Shimura et al. 1971).

Studies on floral differentiation on European chestnut have been carried on by Bergamini and Ramina (1971) and Bergamini (1975). They demonstrated that some cultivars are in fact male-sterile because, even if they have catkins with morphological normal anthers, the pollen is often aborted or sterile. Peano et al. (1990) observed a high degree of sterility in different European, Japanese, and Euro-Japanese hybrid cultivars.

Castanea show two different kinds of genetic sterility: morphological and genetic (based on incompatibility alleles). Sterility was explained as a shift to dioecy (Jaynes 1975).

5. Nut. From a botanical point of view the nut is an achene protected by a thorny shell or cupule: the husk or bur (Fig. 6.3). The bur is first green and then yellow-brownish. Each bur normally bears 3 nuts and when it is ripe, opens in two or four valves. The inner part is creamy, with thin soft hair. The bur has a subspherical shape and it has a diameter of 6–7 cm in wild trees and 10–15 cm in cultivated ones.

The nuts have a smooth and coriaceous epicarp or shell, which can be light brown or deep brown in color with more or less evident stripes. The shell can be covered by soft hair. The base of the nut (hilum or hilus scar) is light, and varies in size. Inside the hilum there is a star-shaped radial pattern, which surrounds spotted granules. The chestnut apex is composed of the remains of the perianth and by dried styles that form the torch (Fig. 6.4).

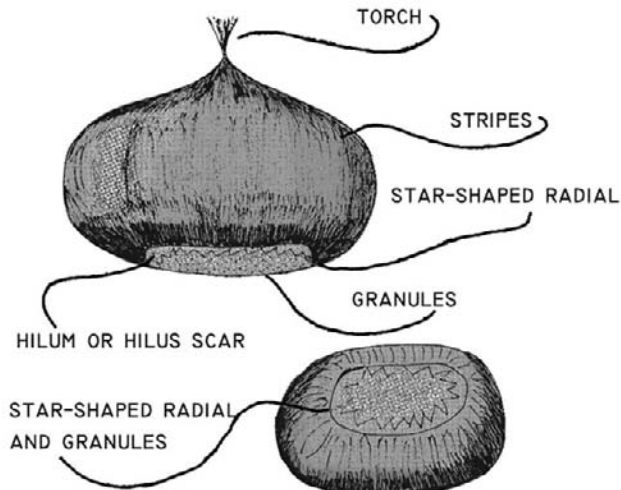

Fig. 6.4. Morphology of the nut.

The seed is wrapped in a thin pellicle (episperm) of chamois color that may penetrate the kernel. The seed can be formed by one or two cotyledons. The seed is rich in starch and is compact and whitish inside and yellowish outside. Nut shape is due to a variety of features including position and number of nuts inside the bur. Side nuts are hemispherical and central nuts are flat. The aborted empty nuts are flat. The genetic control of kernel size is polygenic (Jaynes 1963).

III. HORTICULTURE

A. Propagation

Chestnut is sexually propagated by seeds to obtain seedling rootstocks, or vegetatively (asexually) propagated by grafting, budding, layerage, or micropropagation. Plants grown from seeds vary for important traits because of genetic recombination since chestnut is cross pollinated and highly heterozygous. Most chestnut is propagated by scion or bud grafts, but layering and cuttings are used to propagate some Euro-Japanese hybrids. Micropropagation has a great potential but is not yet practical.

1. Seed Propagation. Seed used for propagation is gathered immediately after they drop to the ground to avoid mold. Only healthy and well-formed seeds are used. The best chestnut seeds are of medium size, with low percentage of septa or with a single embryo in order to obtain only one seedling per nut.

Stratification and Overcoming of Dormancy. Even though mature when harvested, chestnuts do not germinate until they are chilled under moist conditions to remove growth inhibitors. Chilling releases embryos from endodormancy. To avoid dehydration, which reduces germination, chestnuts are stratified in sand or in humid peatmoss at 1–2°C for 4 or 5 months.

Germination. During germination, chestnut seeds absorb large quantities of water and O₂, and stored food in the cotyledons is transferred to the growing embryo. The primordial root (radicle and hypocotyl) and the young shoot (epicotyl) both emerge from the pointed end of the nut.

Seeding. Pre-germinated nuts are sown in raised beds. The apex can be cut off to permit the formation of a well-expanded root system. The soil substrate should be soft and well drained. The germinated chestnuts are sown with the flat part down to facilitate root penetration in the soil. The

depth of seeding must not exceed 3–5 cm and spacing in the row is usually 30–40 cm with rows 80–100 cm apart.

Seedling Care. Seedling care includes irrigation, weed control, and fertilization. At the end of the first growing season (August–September), the seedlings are 100–150 cm tall with a diameter of 8–12 mm and are ready to be chip budded, grafted or budded the following spring.

2. Vegetative Propagation. The main chestnut nursery objectives are well formed and genetically uniform trees, avoidance of ink disease and canker blight infections, and the use of dwarfing clonal rootstocks, which are less susceptible to ink disease (like French Euro-Japanese hybrids).

Grafting and Budding. Grafting and budding are the usual way to propagate chestnut. Success involves correct technique, grafter skill, time and weather conditions (mild days, not windy, high moisture), suitable propagation material, respect for scion polarity, and rootstock/scion genetic compatibility. The formation of a successful, long-lived stock/scion union is related to taxonomic distance. The compatibility is greatest within the same species, but incompatibility often occurs between European and Asian species. Incompatibility may occur at the graft union after a few months or after a few years. To graft European cultivars, it is better to use a stock of *C. sativa*; to graft a hybrid (for example *C. crenata* × *C. sativa*) it is better to use a *C. crenata* seedling or a hybrid.

The protection of grafting wounds with waxes avoids infection by canker blight and other diseases, and prevents drying of the scion wood. Attributes of a good wax include elasticity, impermeability, disinfectant action, and capacity to avoid or reduce infections, especially in the early years after grafting. *Cryphonectria parasitica* easily enters through the graft union and provokes cortical tissue death (Turchetti 1978; Tani and Canciani 1993). Grafting and budding risk infection in the late spring, when pathogen diffusion is high (Canciani et al. 1993). Biological control to protect the wounds can be achieved with hypovirulent strains of *Cryphonectria parasitica* and waxes with a biological additive such as CERAFIX PLUS patent C.N.R. 9406 (Turchetti et al. 1990; Bounous et al. 1995). Canciani et al. (1993) have tested successfully some formulations including the fungicide carbendazim mixed with mineral oil, confirming the results of Jaynes and Anagnostakis (1971), Jaynes and Van Alfen (1977), and Elkins et al. (1978). The period for winter grafting with quiescent rootstock in Italy is February or March, when the rootstock is dormant but close to restarting vegetative growth (Table 6.4).

Table 6.4. Type and period of grafting and budding.

Type	Month (northern hemisphere)
Triangle	February–March
Whip and tongue	February–March
Cleft	March
Cadillac	March
Bark graft	April–May
Vegetative bud	April–May
Flute bud	April–May
Semi-soft scion graft	June–July
Chip budding	April, May, August, September

Grafting Techniques. Triangle (inlay) grafting is made either in the nursery or in the orchard, on rootstocks 2–3 cm in diameter, and consists of creating a triangular wedge in the rootstock into which the scion is inserted. The rootstock is horizontally cut with a bent-bladed knife. Two sloping converging cuts are made to remove a triangular wedge 3–4 cm long. The cold-stored scion wood is shaped and inserted into the wedge to insure contact between rootstock and scion cambiums; one of the buds has to be oriented outward. Wax is applied on wounds and the scion apex.

Whip grafts are made with rootstock and scion wood of the same diameter (generally with only one bud). An oblique cut in the middle of internodes of scion and rootstock and a second cut produces a small tongue. When the tongues are firmly joined, it is better to reinforce them using plastic strips covered with wax.

Cleft graft with one scion is carried out on 1- to 2-year-old rootstocks of the same diameter as the scion wood. The rootstock is cut with a 4- to 5-cm-long diametrical split. The scion wood is formed in its lower part like a wedge with two symmetrical cuts; it is put into the crack, making matching cambial tissues. Fastening and applying the wax complete the grafting. Cleft graft rootstocks with two scions are not recommended because the wounds caused by the cuts are prone to infection by canker blight.

Top working with the Cadillac method is used to graft scions onto old trees. On selected rootstocks, a deep oblique cut half of the size of the rootstock is made. The scion wood is shaped like a wedge with two cuts of different length; the longest of them has a flat surface. The scion is inserted using the branch as a fulcrum to enlarge the crack. After this, the branch portion over the grafting is cut and wax is applied.

Grafting under bark is performed in the spring at the beginning of vegetative growth when the bark slips easily. The scion wood is prepared with an oblique cut and fitted between the wood and bark of the stock. The scion wood collected in winter is dormant when grafted. Bark grafts are made by cutting the rootstock perpendicularly to its axis. The scion is shaped with a straight cut or with two cuts, one of them transversal and the other longitudinal. A small strip of bark is removed even from the opposite part of the scion so that the cambiums of scion and rootstock are in contact.

Semi-soft scion grafts are used on stocks grown in pots. At the end of June-July a semi-softwood is grafted with a softwood scion shaped like a wedge. The scion wood is cut just before grafting. The graft union is kept firm with clips, but a whip tongue grafting does not require fastening. Grafted plants are forced in the greenhouse under mist (J. Coulie, pers. commun.).

Chip budding involves a bud and small section of wood inserted in a similar-shaped wedge removed from the rootstock to obtain a joint where the chip can be put in. This chip is a bud with parts of bark and wood of the same size. Chip grafting is carried out at the end of April with stored scions, or in August-September with buds removed at the moment of grafting. In this last case the growth of the bud begins in the next spring.

Care of Grafted Plants. After grafting or budding, the shoots developed under the graft union of the young plants must be removed. Growth of the shoot of the scion is checked if more than one stem grows; only the best is preserved. Many grafts require fastening with polythene strips, rubber, or "flexibands." Some products are biodegradable and decompose after grafting; others, such as natural and synthetic raffia, have to be removed to avoid girdling the graft union. For spring grafting, fastenings are removed at the end of June or at the beginning of July. Growing stems are often staked to ensure regular development.

Self-rooting. Although grafting is the most common method used to propagate chestnut, it is expensive and some problems arise due to rootstock/scion incompatibility, canker blight, and virus infection. Chestnut self-rooting was first studied in Spain in the middle of the 20th century and is an ideal way to clone rootstocks, scion cultivars, and *Phytophthora*-resistant hybrids (Areses and Vieitez 1970; Diaz et al. 1988; Salesses et al. 1993c).

It is possible to obtain self-rooted plants using layering, soft and hardwood cuttings, or micropropagation. Cuttings and micropropagation

have many benefits and many Euro-Japanese hybrids are propagated successfully with this method, especially in France and in Spain. However, for European chestnut cultivars, grafting and budding is still the preferred propagation method because large-scale self-rooting techniques have yet to be perfected.

Adventitious rooting is influenced by biochemical, anatomical, and environmental factors. Juvenility, etiolation, exogenous promoters, and mycorrhizal fungi promote rooting (Chauvin et al. 1988; Craddock et al. 1992). Young plants have larger quantities of root promoters, and lack auxin-inhibiting factors. Thus, the success of rooting of cuttings from young plants is higher than from adult plants (Vazquez and Gesto 1982). Rooting ability is related to shoot age. The youngest shoots, removed between April and June, root in higher percentage than shoots harvested later. Leaching inhibiting factors by soaking in water promotes rooting (Bartolini et al. 1977). The anatomical structure of cuttings also influences rooting (Beakbane 1961; Edwards and Thomas 1980). If the cuttings are harvested during the first phase of their development, they have a discontinuous ring of sclerenchymal tissue and rooting is made easier. At the end of the growing season, when 5 continuous rings are developed, root emergence is difficult (Biricolti et al. 1992).

Etiolation of shoots modifies the histo-anatomical structure, reducing the sclerenchymatic rings and promoting the xylematic ray formation where former roots are initiated (Ponchia 1986; Rinallo et al. 1987). Etiolation increases the contents of endogenous auxins and phenolic cofactors (Harrison-Murray et al. 1981).

Growth regulators such as indolebutyric acid (IBA), naphthaleneacetic acid (NAA), and abscissic acid (ABA), at concentrations of 1000–2000 ppm, influence rooting positively (Craddock et al. 1992; Fernández et al. 1992; Ponchia 1986). The rooting of soft and semi-soft cuttings is increased by fogging. Factors reducing rooting ability of cuttings include vanillic, hydroxybenzoic, salicylic, silyngic acids, and some water-soluble compounds (Vieitez et al. 1967; Areses and Vieitez 1970; Vazquez et al. 1978; Gesto et al. 1981). The presence of inhibiting factors in adult plants interferes with indoleacetic acid (IAA) (Vieitez and Ballester 1988).

Layering (stooling) develops new plants by rooting stems attached to the mother plant (Solignat 1964; Vieitez 1974; Caldwell and Mudge 1985; Caldwell 1986; Lagerstedt 1987; Fabbri et al. 1992; Ferrini 1993; Gardiman et al. 1993; Ferrini 1997). In France, clonal rootstocks and cultivars of Euro-Japanese hybrids are propagated by girdling and etiolating the stems developing from the crown of the mother plant. Girdling induces hyperplasia above the girdling and induces enzymatic activity

at the base of the stem and promotes the accumulation of IAA oxidase, peroxidase, polyphenol oxidase after 40–50 days (Ferrini 1997). Etiolation reduces tissue sclerification and modifies the anatomic structure and the physiological mechanism, favoring rooting. With ‘Marrone del Brenta’, Gardiman et al. (1993), by combining girdling 8–10 cm above the base and etiolating by covering stems with 30–35 cm of fine sand, obtained 76% rooting, but with etiolation alone, rooting dropped to 9%. With ‘Marigoule’, the rooting percentage was 70% with etiolation plus girdling, and no rooting occurred with etiolation alone (Ferrini 1997).

In layering, mother plants are spaced 1–1.2 m within the row and 2.5 m between rows. Mother plants before layering must have a good root system, which usually takes two years. In the third year, the mother plant is cut at about 10 cm from the soil to promote bud break from the stems. During the spring, several sprouts grow from the stump and they are girdled by a thin, flexible iron wire 4–5 cm above the insertion point on the stump, which produces a “strangling” at the cortical level. The girdling is done from the end of May to June, when the stem length is 25–30 cm. The reduction of sap flow and stem etiolation promote the growing of adventitious roots above the girdle. The best stems are those of medium size; overly vigorous stems are cut because they do not root well. Late girdling is inefficient. The first 5–6 basal leaves are removed after girdling when stems are covered by soft, acidic (pH 4.5–5) soil kept moist to promote root development. Rooting usually occurs after 60–70 days. If the pH is higher, the percentage of rooting decreases.

Cultural cares include inter-row weeding, irrigation, phosphorus and potassium fertilization, and the addition of a small amount of nitrogen. The young rooted plants are transplanted to a nursery to increase root growth.

The success of propagating chestnut by softwood cutting depends on genotype, stem juvenility, period of cutting, and environmental factors such as presence of growth regulators, soil, relative humidity, and temperature. *Castanea crenata* × *C. sativa* hybrids show a greater ability for self-rooting. Rooting of the popular clonal rootstocks in France (‘Marsol’, ‘Maraval’, ‘Marlhac’, and ‘Ferosacre’) ranges from 60 to 90%.

The cuttings are collected from mother plants grown in pots in the nursery, where it is easier to control their health. The mother plants have to be guaranteed free from chestnut mosaic virus (ChMV). During the vegetative season, stems are pruned frequently to promote bud break. Rooting percentage is greater from the medium part of the shoots (Fernández et al. 1992). From each mother plant, 3–4 flushes of 30 cuttings are harvested. The best rooting is obtained between April and the beginning of July. Cuttings are treated with IBA (1000 to 4000 ppm) or with

ABA and NAA. Treatments with fungicides avoid the risk of rot during the rooting process.

Rooting occurs best in climate-controlled rooms followed by transfer to plastic tunnels. The temperature in acclimatization tunnels ranges from 21° to 26°C. Inside the tunnel (1.2 m wide and 0.6 m high), high relative humidity is ensured by a fog system. In the first week, the relative humidity is maintained around 100% to avoid transpiration, but it is reduced progressively. The rooting substrate, porous and well drained, is perlite (50%) and peatmoss (50%). Very good results are also obtained with peatmoss (60%) and pine bark (40%) (J. Coulie, pers. commun.). The substrate temperature is maintained around 22–24°C: higher temperatures cause dehydration of the cuttings. During the rooting process plants continue development, the internode length increases, young leaves grow, and first roots appear after 50–60 days.

In the following spring, rooted cuttings are acclimatized in the nursery using a soft substrate, fertilized, mulched with black plastic film, and often shaded. They are usually spaced 100–120 cm apart.

Micropropagation. In vitro propagation produces self-rooted plants free from pathogens. It is an ideal technique to achieve rapid propagation of unique clones. The production of plants free from ChMV, transmitted by *Myzocallis castanicola*, is another advantage of micropropagation (Vazquez and Vieitez 1962; Vieitez and Vieitez 1980a,b, 1982; Desvignes 1996; Desvignes and Cornaggia 1996).

Micropropagation has been effective for some of the Euro-Japanese hybrids selected for ink disease resistance. Vitrification is produced in Murashige and Skoog media, but normal explants are obtained with Heller and Gresshof and Doy media (Vieitez et al. 1985).

In France, a protocol to propagate interspecific hybrids (*C. crenata* × *C. sativa*) with variable levels of tolerance to the ink disease was established in 1982–1988 (Chevre 1985; Chevre and Salesses 1985; Chauvin and Salesses 1987a,b, 1988). Important factors include genotype and tissue juvenility, the use of fructose and sucrose in the multiplication phase, and temperature and light effect in the proliferation phase. The method perfected by INRA of Bordeaux is used by INRA/Agriobtentions of Dijon laboratory to propagate chestnut hybrid cultivars and rootstocks tolerant to ink disease.

B. Breeding

Chestnut culture is now improving after many years of decline and abandonment, particularly in Europe, and world production of chestnuts is increasing. Old groves are being renovated in Italy, France, Spain, Por-

tugal, and Switzerland where chestnut blight is in remission. The attenuated blight problems and the introduction of interspecific hybrids resistant to ink disease have renewed interest in the culture throughout Europe. New plantings are also being made in North America and New Zealand. Asian production continues to increase as both China and South Korea modernize their plantings and expand export markets especially towards Japan and the United States.

Breeding and selection are now of fundamental importance to obtain new and valuable cultivars for superior nut and timber production. In Europe and Asia, where chestnut has been grown for centuries or millennia, the main problems are to select the best cultivars from the available germplasm, and eventually to add genes for resistance to major diseases and pests. In America, Australia, and New Zealand, efforts are aimed at obtaining new cultivars with desirable traits or selecting locally adapted clones from the available cultivars.

In the last few years, the demand for selected cultivars of chestnut has increased. The certification of plant material is a voluntary practice aimed at yielding higher quality nursery stocks and providing growers with disease-free and genetically respondent plants. Thus, methods for the reliable characterization and identification of the cultivars have become necessary. Cultivar characterization has been traditionally carried out using morphological and biometrical descriptors and phenological observations; yet, DNA-typing techniques are newer tools that are becoming available at affordable cost for the routine check of the plant material (Botta et al. 2001, 2003). The analysis of the molecular markers allows the definition of the DNA fingerprint of the cultivars, in order to construct databases with the genetic profiles of each cultivar and then enable the rapid identification of cultivars (Boccardi et al. 2001). Among marker types, microsatellite or SSRs (Simple Sequence Repeats) are considered particularly suitable for the DNA typing (Marinoni et al. 2003; Buck et al. 2003).

1. Objectives. The chestnut ideotype is a function of final use (nuts or timber), and production and processing technology (harvesting systems, fresh or processed uses) (Tables 6.5, 6.6). For nut production the most important breeding objectives include good horticultural traits, product quality, suitability for storage and processing, and easy peeling.

For timber, important characters include wood quality, rapid growth, and non-checking of wood (ring-shake). Ease of propagation and resistance to major diseases and pests are common for nut and timber types.

2. Plant Characteristics. Semi-compact, medium or low vigor are the most suitable features for medium or high-density plantations. Other

Table 6.5. Main objectives of chestnut breeding.

Use	Characters required
Nut production	<p>Tree: Medium-low vigor, strong branches, upright growth habit for mechanical harvesting, good pollinizer, self-fertility, regular and high yields, precocious bearing, early ripening, ease of propagation, rootstock/scion compatibility, resistance to <i>Cryphonectria parasitica</i> and <i>Phytophthora</i> spp, resistance to <i>Dryocosmus kuriphilus</i>.</p> <p>Nuts: Large size for fresh or candying uses, small or medium size for drying or flour, light color, shiny, shell with evident stripes, evenness of shape, no multiple embryos, easy of manual or machine pellicle removal, no hollow kernels, good flavor, sweetness, adequate texture, good adaptability to candying, resistance to <i>Cydia</i> spp., <i>Curculio elephas</i>, <i>Cyboria batschiana</i>.</p> <p>Bur: Dehiscent for manual harvesting, Non-dehiscent for mechanical harvesting, long and dense spines for insect resistance.</p>
Wood production	<p>Tree: Resistance to <i>Cryphonectria parasitica</i> and <i>Phytophthora</i> spp., resistance to wood-boring insects, resistance to frost and drought, minor pedological needs, timber products, high vigor, straight trunk, fast growth, high wood production, high yields, self-pruning ability, non-checking wood, no ring shake.</p>

valuable cultivar characteristics include early maturity, precocious bearing, regular and high yields, strong branches, good pollinizer ability and intercompatibility with the best cultivars. Harvesting is one of the most costly aspects of chestnut production. Harvest-related traits include upright habit for mechanical shaking and low detaching force to shake off burs from the tree. Mechanical harvesting of the nuts from the ground may be easier with nuts that fall closed in the burs (to prevent nuts from infection) than with nuts that fall free from dehiscent burs. For timber production, trees have to demonstrate high vigor, high wood production, straight trunk, self-pruning ability, and wood not subject to ring-shake or radial checking.

3. Nut Characteristics. A large nut size is desirable from the standpoint of harvesting, handling, fresh marketing, and candying (*marrons glacés*), while a small or medium size nut may be used for dried chestnuts or use as a vegetable. However, the marketing of peeled or processed chestnuts puts less emphasis on size. Evenness of shape, shiny color, dark brown

Table 6.6. Main characters of chestnut species (positive characters in boldface).

Genetic resources	Characters		
	Nut	Tree	Resistance (R) Susceptibility (s)
<i>Castanea sativa</i>	Large size Adherent pellicle (some cultivars)	Strong branches Good growth habit Wood quality	<i>Phytophthora</i> (s) <i>Cryphonectria</i> (s) <i>Dryocosmus</i> (s)
<i>Castanea sativa</i> (marrone)	Large size No pellicle intrusion Easy to peel Sweet flavor Good texture Ovoid shape Small, rectangular hylar scar Light-colored shell Dark, close stripes	Lower yield Male sterility More exacting soil and climate requirements	<i>Phytophthora</i> (s) <i>Cryphonectria</i> (s) <i>Dryocosmus</i> (s)
<i>Castanea crenata</i>	Very large size (≥ 30 g) Adherent pellicle Not sweet, astringent	Small size (≤ 15 m) High yield Precocious bearing Early ripening	<i>Phytophthora</i> (R) <i>Cryphonectria</i> (R) (moderate) <i>Dryocosmus</i> (s) (high) Spring frost (s)
<i>Castanea mollissima</i>	Weight (10–30 g) Sweetness, flavor, protein content No pellicle intrusion Thin pellicle Easily removed pellicle High variable size	Medium size (≤ 20 m) Semi-upright habit Early ripening (variable) Precocious (variable) Two crops/year (in subtropical areas) (variable) Good pollinizer	<i>Phytophthora</i> (R) <i>Cryphonectria</i> (R) (variable) <i>Dryocosmus</i> (s)

(continued)

Table 6.6. (continued)

Genetic resources	Characters		
	Nut	Tree	Resistance (R) Susceptibility (s)
<i>Castanea dentata</i>	Very sweet Non-astringent Easy to peel Very small (300 nuts/kg)	Fast, straight growth with strong central leader Self-pruning Well coppiced	<i>Cryphonectria</i> (s) (high) Frost or cold (–35°C) (R)
<i>Castanea seguinii</i>	Small size Very prolonged blooming and ripening period Very precocious	Small, medium size Precocious flowering Everbearing 2 crops/year (some clones) Chain of 10–20 burs (some clones)	<i>Cryphonectria</i> (R) <i>Dryocosmus</i> (s)
<i>Castanea pumila</i>	Very small Single nut burs Sweet, flavorful Very precocious	Moderate size Stoloniferous clones Prolific suckering ability Soft spined burs Suitable for warm climate	<i>Cryphonectria</i> (R) (partial) Warmer temperate climates (R) Quickly replacing blighted stems
<i>Castanea henryi</i>	Single nut burs Very small	Fast growth Straight trunk Good wood Suitable for warm temperate or tropical climates	<i>Cryphonectria</i> (R)

stripes, flavor, and firm texture are valuable traits for fresh marketing. Other desirable traits are easy pellicle removal, no pellicle intrusion, no hollow kernel, no multi-embryo nuts, and resistance to *Cydia*, *Curculio* and other pests and to *Cyboria* and other storage diseases.

4. Ease of Propagation. Good aptitude for vegetative propagation and stock/scion compatibility are of primary importance. Chapa et al. (1990) and Bounous et al. (1992) found that *C. crenata* hybrids (*C. crenata* × *C. sativa*) are easier to propagate by cutting or layering than *C. sativa*. Ease of propagation by layering or cutting and *Phytophthora*-resistance of the French hybrids ('Marsol', 'Marigoule', 'Maraval', 'Précoce Migoule') have suggested their use as rootstocks or as direct producers. Graft incompatibility problems with many European cultivars have limited their wider application in the field, and studies have identified scion/rootstock clone combinations (Chapa et al. 1990; Ferrini et al. 1992; Breisch 1993).

Although environmental and stress factors may have a role, the success of a particular graft, stock/scion compatibility is most certainly under genetic control (Anagnostakis 1991). Three peroxidase isozyme genes are known for *Castanea* (6 types) and may be involved with graft compatibility (Santamour et al. 1986). Graft incompatibility is also affected by ChMV (Desvignes 1996).

5. Resistance to Stress

Abiotic. Resistance to spring frost is especially important for Euro-Japanese hybrids, which are early to leaf out. Resistance to drought conditions is desirable to expand chestnut cultivation into temperate, warm and dry zones.

Biotic. Breeders have concentrated their efforts on improving resistance to the major fungal pathogens: chestnut blight, caused by *Cryphonectria parasitica* (Murr.) Barr, and ink disease by *Phytophthora cambivora* (Petri) Buis and *P. cinnamomi* Rand. Other diseases such as anthracnose (*Mycosphaerella maculiformis* (Pers) Schroet.) and javart (*Diplodina castaneae* Prill and Del.) have received much less attention.

Ink disease causes serious damages in Europe, and also in China, Japan, Turkey, and the United States. The genes for resistance to the disease have been found in *Castanea crenata* and *C. mollissima*, but resistance levels vary greatly within each of these two species (Salesses et al. 1993b).

Chestnut blight is not considered important in Japan, China, and Korea, although in China there may be substantial periodic damage. In

Europe and North America, *Cryphonectria parasitica* is widely regarded as one of the most destructive of all plant pathogens. In Europe, *Castanea sativa* is recovering from initial serious damage due to a combination of factors including genetic resistance to the blight, improved orchard and environmental conditions, and the spread of hypovirulent strains of the blight fungus. Chestnut clones highly resistant to blight and hybrids between resistant and susceptible characters now exist. In North America, chestnut blight, identified in New York in 1904, had virtually destroyed *Castanea dentata* by 1950. Today root crowns of the American chestnut continue to form stump sprouts, which may survive for years before being infected and killed. Rutter et al. (1991) made the point that genetically susceptible trees will always be at risk, if mutations for resistance do not appear, despite the promising outlook for biological control. According to Burnham et al. (1986), further crossing using the backcross methods may recover full resistance.

More than 50 species of insects are known to damage chestnut (Paglietta and Bounous 1979; Payne and Johnson 1979). These include Asiatic chestnut gall wasp (*Dryocosmus kuriphilus* Yasumatsu), several species of weevils (*Curculio elephas* L.), lepidote moths (*Pammene* spp. Hb. and *Cydia* spp. Hb.), and wood-boring beetles (*Xyleborus dispar* F.) which are often serious enough to become limiting factors in chestnut production.

Resistance to insect pests has been little investigated with the exception of gall wasp. The cynipid gall wasp is a very serious insect pest of chestnut and is endemic to China and naturalized in Korea and Japan. It was accidentally introduced into the southeastern United States, where it causes significant losses (Payne and Johnson 1979; Payne et al. 1975) and was recently observed in Italy (Brussino et al. 2002). Japan, Korea, and China spend considerable research effort to control this insect. Breeding for resistance has concentrated on twig growth habit, canopy density, and bud morphology. The gall wasp resistance observed in some seedlings of *Castanea mollissima* selections is actually a form of "escape" where bud formation is delayed until second flush growth has ceased (after fruit set) and thus bud development occurs after gall wasp flight (Norton 1986). In South Korea, at the end of 1950, the government financed a program to obtain *Castanea crenata* × *C. mollissima* hybrids resistant to gall wasp and many selections have been obtained.

Chestnut weevils are found in Europe wherever *Castanea* naturally occurs. They feed on immature nuts and may cause spoilage. Infested nuts on the market may be in part responsible for the decline in consumption experienced in Europe over the past two decades. Chemical control is costly, may be environmentally harmful, and is often too dif-

ficult to be effective, especially in mountainous terrain. For this reason, it is desirable that genetic characters of resistance to this insect be found. The length of the spines on the burs may be involved in resistance, although this has not been well studied.

C. Orchard Management

1. Planting Establishment. The establishing and the management of chestnut orchards should be carried out with due consideration for climate, soil, altitude, rainfall, and other parameters apt to insure good production of high-quality products (Bounous and Beccaro 2002).

Soil. The best soils for chestnut are deep, soft, volcanic, rich in phosphorus and potassium. The pH should range from 5.0 to 6.5. Soil with active limestone must be avoided, because *Castanea* is very sensitive to high pH. Soil permeability is very important. Heavy, washed out, clayey, stagnant soils favor root rot caused by *Phytophthora* spp. and *Armillaria mellea*, and must be avoided.

Climate. Chestnuts tolerate cold winters and are adapted to environments where the average temperature is 8–15°C and with an average of 10°C per month for at least 6 months (Paganelli 1997). *Castanea sativa* is more cold resistant (–15° to –20°C) than many of the Euro-Japanese hybrids. In spite of late bud-break (March–April), the plants may be subject to spring frosts, which damage tender growing shoots. During blossoming and pollination, temperatures of 27° to 30°C are necessary. European cultivars require about 800–900 mm/year of rainfall, well distributed during the growing season. Euro-Japanese hybrids are more water demanding (1200–1300 mm/year). In temperate climates, sweet chestnut should not be planted above 700–800 m, whereas for hybrids the plantation limits are about 500–600 m.

2. Density and Spacing. The general trend in orcharding is to increase plant density to develop maximum bearing per unit area, in a minimum of time. Plantation densities range from 100 to 170–180 plants/ha, based on genotype-environment interactions and cultural practices. Generally, spacing ranges from 8 to 10 m apart in rows and 10 m between rows. For *C. crenata* cultivars, distances of 5 m × 7 m (285 plants/ha in fertile soils) or 7 m × 7 m (204 plants/ha) are recommended. For the most vigorous Euro-Japanese hybrids (*C. crenata* × *C. sativa*) the distances range between 7 m × 8 m (178 plants/ha) and 8 m × 10 m (125 plants/ha).

Spacing for European chestnut are 10 m × 10 m (100 plants/ha) and more according to climate and soil fertility. Planting patterns may be square, rectangular, or triangular, but rectangular and square are the most used because they are easier to manage. Chestnut plantations managed following the criteria for modern orchards bear the first crop 3 to 4 years after planting.

3. Rootstocks. The most popular clonal rootstocks are the Euro-Japanese hybrids selected in France. They are easy to propagate by layering or soft cutting, are tolerant to *Phytophthora* spp. and *Cryphonectria parasitica*, and have genetic compatibility with most of the best cultivated cultivars. Popular rootstocks include: CA 07 'Marsol' (moderately resistant to *Phytophthora*); CA 74 'Maraval' (*Phytophthora* resistant, low vigor); CA 118 'Marlhac' (moderately resistant to *Phytophthora*, but able to grow at temperatures < -10°C); CA 90 'Ferosacre' (*Phytophthora* resistant, but sensitive to temperatures < -10°C). European chestnut cultivars are usually grafted onto seedlings of *C. sativa*.

4. Cultivars. For fresh market, the desired traits of a good cultivar include early ripening, large size, and good taste and appearance. Cultivars ripening in September have a niche market and receive the best price. Good early ripening cultivars in Italy are 'Madonna di Canale' and 'Tempuriva' in the Piedmont Region, 'Ranaz' in Friuli, 'Venezia Giulia', 'Napoletana Riccia', 'Rossa di S. Mango' in Campania, and 'Premutico' in Lazio. Popular French Euro-Japanese hybrids are 'Bouche de Betizac' and 'Precoce Migoule', and 'Marsol'. Good Italian Euro-Japanese hybrids are 'Primato' and 'Lusenta' released by the University of Torino, Department of Arboriculture.

Italian marroni have a large size and an outstanding flavor. Among them are 'Marrone Fiorentino or Casentinese', 'Marrone di Marradi', 'Marrone di S. Giorio', 'Marrone di Chiusa Pesio', and 'Marrone di Luserna'. Other Italian chestnuts with a large nut size include 'Bracalla', 'Garrone Rosso', 'Gioviasca', 'Marrubia' in Piedmont, 'Bionda di Mercogliano' in Campania, and 'Vallerano' in Lazio (Bellini 1995; Bounous 2001; Marinoni et al. 2001).

Light and bright color is preferred. Dense stripes, as in marroni cultivars, are desirable, because consumers identify these characters with quality. A hilar scar of excessive dimensions, often with cracks, is a devaluing feature of the majority of Euro-Japanese hybrids.

To prepare *marrons glacés* and candied marrons by industrial processing, the essential technological requirements include low percentage of episperm intrusion in the kernel, suitability to mechanical peeling, resistance to flaking and to cooking, and good texture.

5. Pollinizers. Chestnut is monoecious and self-sterile (marroni types are often male-sterile). Thus, to achieve good harvests, pollinizers must be planted in the orchard. It is important to make sure that the cultivars are genetically compatible and that the pollen-shedding period coincides with pistillate receptivity.

Pollinizers have to be placed in adequate number and in a uniform way in the orchard to ensure good fruit set. However, blossoming time (June–July) depends on different environmental factors, especially temperatures of April and May, and may be delayed or advanced (Solignat 1958).

6. Planting and Fertilization. A deep plowing before planting is better than just planting in holes. Plowing at a depth of 40–50 cm is recommended, but 20–30 cm is sufficient in shallow mountain soils. Chestnuts prefer soil with 2–3% or more of organic matter.

In mild, moist winters, the best period to plant trees is late fall. In areas with cold winters, early spring planting is usually the best. Plants have to be planted in holes large enough to accommodate the root system. Bare root plants are often treated with a fungicide solution to prevent root diseases. A light surface application of fertilizers assures immediate availability of nutrients.

Phosphorus, potassium, and manure are applied at planting but nitrogen application is delayed. Phosphorous stimulates root growth (Tagliavini et al. 1993). Irrigation during the first two years should be applied at least every 2–3 weeks or as needed. Sprinkler and drip systems are widely used. Soil management in most plantings is aimed primarily at weed control, but soil structure and fertility must also be maintained and improved.

7. Tillage. Tillage (5–10 cm depth) eliminates weeds, maintains water reserves, reduces water loss by evaporation, distributes fertilizers, aerates the soil, and favors the mineralization of organic matter. Tillage is used in dryer climates.

8. Mulching. Mulches of composted sawdust, bark chips, or mowed grass, in a 1 m strip under the row, retain moisture, increase organic matter contents, and control weeds. For chestnut, mulching is recommended in the first years after planting. This technique reduces water evaporation, preserves the soil structure, and helps maintain an even soil temperature favoring the microflora and increasing the nutrient availability. Under mulch, a shallow root system is developed exploring the more fertile parts of the soil (Mage 1982).

9. Weed Control. Herbicides can be used for good weed control. This preserves moisture, improves the physical characteristics, and reduces managing costs. However, organic farmers prefer to avoid chemical weed control.

10. Cover Crops. Cover crops may be native or planted with various legumes or grasses such as *Lolium perenne*, *Festuca ovina*, and *F. arundinacea*. If the cover crop is mowed and the cut vegetation left in place, the organic matter will be beneficial. On steep slopes, cover crops reduce erosion. The presence of a cover crop makes mechanical transit easier, even after long rainy periods. Cover crops also have a positive effect on fertility, as they improve the distribution and availability of less mobile elements such as phosphorus and potassium.

11. Fertilization. Ridley and Beaumont (1999) recommend leaf sampling and analysis of chestnut for mineral content be done in mid-summer. Weir and Cresswell (1993) consider as normal the following nutrients concentration in leaves (% dry matter): N (2.4–2.9); P (0.1–0.3); K (0.8–1.6); Ca (0.6–1.4); and Mg (0.2–0.7).

Nitrogen, as in other fruit species, is the most important element as it stimulates vegetative growth. Full bearing plantations need phosphorus. It is absorbed in smaller quantities than nitrogen and potassium. Often the natural supply of the soil is sufficient, so that it is not necessary to add more before the 10th year. After this time, phosphorus may be added every 3–4 years. Potassium promotes water and heat stress resistance and the growth of nuts, while boron is useful for nut production.

Establishing a 5-year fertilization plan, Breisch (1995) suggests 50 g/plant of nitrogen in the first year, increased to 250 g/plant in the 5th year with increasing potassium, starting at 80 g/plant. From the 6th year, fertilizer should be broadcasted at the following rates: N (60–80 kg/ha); P (9–13 kg/ha); K (66–100 kg/ha).

12. Pruning and Training. Chestnut tree inflorescences originate from the buds on one-year-old branches. Flowers bloom from the apical and sub-apical end (Bergamini and Ramina 1971) or are in medium positions.

New plantings are typically trained to open-center or central-leader forms. Pruning bearing trees consists in the removal of old lower branches to stimulate sprouting to increase nut size and to ensure a high-quality harvest. However, pruning reduces potential leaf surface, which results in reduced root growth. For this reason, pruning should be light, and balanced with fertilization and irrigation.

D. Harvest

Chestnuts are collected when they drop from the tree. In some cultivars, dropped nuts remain enclosed in burs; in others the chestnuts drop to the soil from open burs still hanging on the branches.

Ripening is gradual, and can persist over one month. In warmer zones, it begins at the end of August, to September, and as late as November for late cultivars. In dryer seasons, burs do not open until a high humidity favors their opening. The chestnuts harvested before complete ripening are difficult to preserve. The harvest has to be completed in a very short time and it is a good practice to make several collections, spaced within a few days. High temperature, moisture, pathogens, and predators can spoil the harvest.

Chestnuts may be hand harvested or mechanically harvested. In hand harvest, nuts dropped on the ground are separated from burs using wood hammers or gloves and then collected. In some areas branches are struck with long poles to increase nut fall; but this practice must be avoided because it causes wounds to branches. Hand harvest is very expensive (about 50% of the total annual cost) because pickers harvest a small number of nuts/hr (about 10–15 kg/hr).

Roll-out nets are often used to receive the dropped nuts and burs in order to facilitate harvest. Nets can be laid on the soil or held by poles at 1.2–1.6 m above the soil. Rolling out the nets is time consuming, but it permits pickers to operate with greater efficiency and collect the crop with baskets fixed on long poles or with vacuums. The cost of the nets is high: about 5000–7000 US\$/ha, depending on total or partial covering of the orchard (Breisch 1993).

Mechanical harvest in the chestnut industry is less developed than for other nut species. A number of problems must be solved, particularly the avoidance of abrasions on the shell of the nuts. Machinery is available to separate nuts from burs. Harvesting machines, vacuums, and sweepers, similar to those used for walnuts, hazelnuts, and almonds, have been adapted for chestnut.

IV. NUT UTILIZATION

A. Postharvest Quality

The market for fresh nuts requires a product of high quality in order to satisfy an increasingly demanding consumer. The quality characteristics considered include large size, attractive exterior appearance, and

well-preserved nuts. Nuts from late-maturing cultivars store better than early-maturing cultivars whose nuts tend to deteriorate quickly.

Chestnuts have many storage problems due to their high sugar and moisture contents. They are particularly perishable and require special care and attention from harvest until their final use. Nuts still on the tree are damaged almost exclusively by insects, which lay eggs in the bur before shell hardening. The closed bur is a good barrier to fungal infections of the nuts. At the moment of nut fall, however, fungal contamination becomes of primary importance, especially if harvest is delayed. The principal pathway to fungal infection of the fresh nuts is the hylum scar, which may still be porous and permeable when the nuts fall, even though they are ripe. The apex of the nut may become an entrance for fungi if the nuts germinate during storage. The harvest must proceed daily to avoid losses, especially if the weather is warm and humid. Freshly fallen chestnuts have an intense metabolic activity. The large quantities of carbohydrates are utilized in respiration, producing water, carbon dioxide, and heat, which combine to create an environment particularly favorable to the growth of molds.

Many techniques prolong the storage and maintain the quality of nuts. Some are ancient while others are of recent origin. Both traditional and innovative techniques have common objectives: to reduce metabolic activity of the chestnuts in order to delay the growth of molds.

B. Fresh Market

Early ripening chestnuts, immediately packed and commercialized after harvest, are destined for the fresh market, even if they represent a minor part of the total crop. In fact, the majority of fresh chestnuts undergoes a series of treatments before marketing in order to reduce the percentage of wormy and moldy nuts and to prolong storage while maintaining their organoleptic characteristics to guarantee a healthy product and to extend the market period.

Chestnuts are sorted into size classes before marketing based on the number of chestnuts/kg and, in general, correspond to the export classes: AAA (fewer than 48/kg), AA (48–65/kg), A (66–85/kg), and B (more than 85/kg). Many private firms also specify the size class on packaging. In grading, nuts with calibre < 25 mm are destined to industry; nuts with diameter between 26–27 mm are subjected to curing; and nuts with diameter > 27 mm are heat treated (sterilization).

The nuts must be dried on the surface before sizing to avoid staining. Oxidation of the sugars on contact with the metal parts of the sizer may cause browning if the nuts are wet. The sizer used is a horizontal, cylin-

drical sieve with a slight inclination. Rotation of the cylinder advances the nuts, which are sized according to their diameter as the holes in the sieve become progressively larger at the downward end. A final hand sorting is required to eliminate wormy and imperfect nuts.

Chestnuts are often polished before marketing by rotating brushes to restore their original shiny surface, which may have dulled during the curing process, and also to eliminate some superficial molds, dust, and other impurities. Chestnuts and marrons are packed, in accordance with size and treatment, in burlap or mesh bags of various weights, and labels giving cultivar denomination, size, and origin are applied.

C. Storage Methods

1. Ricciaia. The “ricciaia,” or bur pile, is a very old storage method, almost totally abandoned in Europe, but currently used in Turkey. Chestnuts are harvested while still closed in the burs and raked into piles about 1 m tall, covered with leaves, burs, and soil. Under these conditions, the nuts undergo a form of fermentation, which stabilizes them and allows for their conservation for several months. The “ricciaia” is particularly well suited to those cultivars whose nuts fall still closed within the burs and the storage process itself facilitates the opening of the burs for extraction of the chestnuts. It is possible to separate nuts from burs with a wood hammer. Other traditional storage methods consist of maintaining whole nuts in sand or humid peat.

2. Curing. Once curing was called “novena,” because it lasted nine days. Although an ancient storage technique, this method is still used because it permits storage of nuts for several months. The procedure consists of keeping the nuts under water, at room temperature, for four to ten days. In water, the permeability of the nut skin allows solubilization of seed polyphenols and, through lactic fermentation, an acid medium is created. This medium has an antibiotic action that improves storage. To accelerate the fermentation, lactic enzymes may be added ($10\text{g}/\text{m}^3$), or water temperature may be increased to around 25°C . If water, medium, and nut temperatures are increased, curing can be reduced to 2–3 days.

Curing affects nut structure; tissues swell up, inside the nut heat is produced, and fermentation gases spread. These structural modifications make nuts more receptive to the sugar syrup used to candy them. Nuts are placed first in large stainless steel or vitrified cement tubs full of water (capacity 10–20 t) to eliminate immature and wormy nuts, which float. When tubs are emptied, the nuts are mechanically cleaned by a water jet, and kept for several days. Nuts infected by fungal parasites are

covered by hyphal strands, making it easy to eliminate them in the following sorting.

The drying phase of the curing process is carried out by manual stirring of the chestnuts piled in layers 30–40 cm thick on cement floors, and requires two weeks. Wooden paddles are often used and the nuts may be sorted during the process, eliminating any moldy nuts. Mechanical dryers or ventilated hoppers are now used.

3. Sterilization. The so-called “sterilization” normally consists of a passage in hot water (50°C) for 45 min to kill any insects and particularly the chestnut weevil, *Curculio elephas*. The temperature chosen for sterilization is the highest one that proteins can tolerate without denaturing; the length of the treatment is based on the survival capacity of insect larvae and eggs. After passage in cold water to remove any residual heat, chestnuts are then spread out on a cement floor or on some other surface to dry for several days. The product thus treated may be marketed directly without any further curing, as early season chestnuts, which command high prices on the market. Curing is necessary for longer storage.

4. Fumigation by Methyl Bromide. This method is still requested to meet world export rules in order to avoid nuts containing live insect larvae, but it is more and more subject to sanitary restrictions and will probably be forbidden in 2005.

5. Refrigeration in Normal Atmosphere (NA). Nuts may be placed in cold storage [0–2°C; 90–95% relative humidity (RH)] to be stored for 3–4 weeks if ventilation is adequate. The product is stored in 0.6 t bins inside cold storage rooms (capacity: 200–600 t). This technique can be combined with other treatments such as curing and controlled atmosphere (CA).

6. Controlled Atmosphere Storage (CA). This technique is based on the slowing down of metabolic activities, particularly respiration, to reduce nut senescence. The storage time is related to the respiratory activity. Temperatures near 0°C, high rates of CO₂, and a low rate of O₂ reduce nut decline and avoid microbe development. For oxygen there is a minimum threshold value, under which aerobic respiration is interrupted and asphyxia begins; for CO₂ there is a maximum threshold value, as nuts can be impaired. Thus, conservation depends on nut composition and ripening step, so for each product it is necessary to obtain optimum CO₂ and O₂ concentration and optimum temperature.

Good results for 4–6 months of CA storage (89% marketable) have been obtained by Anelli and Mencarelli (1992) with the following para-

meters: 0°C; 95% RH; 20% CO₂, and 2% O₂ on cured chestnuts. If chestnuts are not cured, the percentage of marketable nuts is reduced to 52%. If normal atmosphere storage follows curing, after 4 months the percentage is reduced to 80%, while the percentage of nuts affected by *Sclerotinia* increases. Thus, CA is more effective if it is combined with curing.

7. CO₂ Treatment. As an alternative to curing, Anelli and Mencarelli (1992) tested massive CO₂ treatments for 5 days (5°C), followed by normal refrigeration (0°C, 95% RH) or by CA storage (0°C, 95% RH, 20% CO₂, and 2% O₂) to preserve chestnuts for 4–6 months. For short-term storage (one month at 18°C), chestnuts packed in bags and placed in pallets are wrapped, sealed, with a polythene film of low permeability, and treated with high quantities of CO₂ (45–50%).

8. Freezing. Freezing does not alter the quality of the nuts that may be stored at –18° to –20°C for long periods (6–12 months). Chestnuts are laid in a thick bed (20 cm maximum) to permit a homogeneous and quick freezing. To avoid dehydration, peeled nuts are well dried, and packed in polythene, in bags of 0.5–2.5 kg of product.

At the beginning, freezing temperature is maintained –35° to –40°C (about 12 hr), and then adjusted to –18° to –20°C for the long storage in ventilated cold rooms. The relative humidity is maintained at 80–90%. Nuts are thawed at room temperature by spraying vapor or by immersion in cold water. After thawing, nuts must be consumed immediately because they become moldy very quickly.

9. Drying. Drying is an old storage method still used, especially in areas where there has been a long tradition of production and use of this treatment. With drying, nuts acquire flavor and digestibility, water content is reduced from 50% to 10% or less of the original fresh weight, and the concentration of nutrients and minerals increases. This technique allows the storage of the nuts for up to one year or more. Under-sized nuts (> 100 nuts/kg) are suitable for drying. Nuts suitable for drying are small, sweet, without pellicle intrusion in the kernel, and easy to peel.

The chestnut dryer is a simple square or rectangular structure, usually built of stone or brick according to local tradition. The inside is divided into two levels by a grating. A smouldering fire is lit on the floor or the lower part, usually burning chestnut sawdust, chestnut shells, and wood and regulated to maintain an even temperature. The chestnuts to be dried are placed on the grating in layers in the upper part of the dryer. The first layer is 10–15 cm thick and when the layer has dried for three or four days, another layer of 10–15 cm may be added. Subsequent

layers will be similarly added until a final amount of 30–50 cm of nuts has been reached. The chestnuts are never placed all at once in the dryer to avoid browning or off flavors. Placing a canvas over the nuts and stocking the fire for the final drying complete the process. The entire process requires an average of 30 days.

In the past, dried nuts were hand peeled but are now mechanically peeled with a separator dividing nuts from shell. Drying is done in electric ovens, which greatly reduces drying time without loss of quality. A final hand sorting is still necessary.

D. Processing

Chestnuts have many culinary uses. Examples include dried chestnuts, flour, *marrons glacés*, chestnut creams, candied marroni preserved in alcohol, peeled and ready to cook marroni, vacuum-packed or frozen marroni, chestnut purées, and precooked food called “*marroni al naturale*.”

Processing is necessary to increase the available products and to extend the use of the product throughout the year. A distinction is made between semi-processed and finished products. Semi-processed products are the basis of many chestnut-based processed foods, while finished products are sold to the final consumer.

1. Semi-processed Products. This includes peeled chestnuts and marroni and chestnut purées, both utilized by candying industries and pastry shops. Semi-processed products can be used all year round not only for preparing cakes, but also to prepare appetizers, main dishes, vegetables, sauces, fillings, and snacks.

Peeled Marroni and Chestnuts. Chestnut and marroni cultivars are peeled using different methods according to the size of the nuts and the final use for which they are destined. Complete removal of the pellicle is necessary and the nut must remain whole. Peeling methods include scorching, steaming, and multiple incisions:

- **Fire Peeling or Scorching.** This method is fast and requires a low labor input. It is used for the smallest chestnuts and marroni (130–140 nuts/kg). Nuts are scorched to high temperature (800°–1000°C) for 1–2 min in small rotating cylinders. A flame is placed under the oven so it passes through the holes between the tiles. The scorching of the nuts removes the shell and the pellicle. The nuts are then passed through a series of rigid brushes. After brushing, they are

placed in 80° to 90°C water for 4–10 min in order to soften the outer layer of the nuts, which was partially cooked during the scorching. Later on the nuts are hand sorted after a further brushing process using rollers and conveyer belts.

- **Steam Peeling.** This method takes longer and is more costly than fire peeling, and it is used for large-size nuts and marroni destined for candying. A machine makes an equatorial cut around each nut. The nuts are then placed in rotating cylinders where 60°C steam is blown for 2.5 hr, and later in cooler steam. Shell and pellicle are then washed free before a final hand sorting, which is very important to assure that nothing remaining of the pellicle is stuck in the indentations of the cotyledonal tissue.
- **Peeling by Multiple Incision.** The machine used for this method is composed of a central rotating cylindrical sieve with smaller cylinders around it. These last cylinders are armed with many tiny blades (1.5 mm high), which cut the chestnuts repeatedly as they roll through the central cylinder. The shells and the pellicles of the nuts are completely lacerated by the process and then are removed by washing in 80–90°C water for 4–5 min. A hand sorting is required to remove any pellicle remaining in the indentations of the cotyledon. Chestnuts peeled by any of the above methods may be frozen at –40°C and then stored at –20°C.

Purée. A simple process is used to obtain chestnut purée. After steaming for 15–20 min, the chestnuts are conveyed to an extrusion cylinder. Shell and pellicle remain on one side while the chestnut purée is extruded. Purée is then homogenized and sweetened by addition of 2% sucrose. The purée is sold in 5–7 kg frozen blocks. Sugar and flavorings (such as vanilla) are blended into the purée prior to the preparation of finished pastry products.

2. Finished Products

Whole Peeled. Whole peeled chestnuts and marroni may be processed for storage in various ways that maintain the fresh-cooked quality of the nuts. This product is largely marketed in France, where it is frequently used in home cooking. The chestnuts used are perfect (without molds, stains, or insect damage), easy to peel, and uniform in size (80–90 nuts/kg). Uniformity and appearance are very important to the French consumers who often serve these chestnuts as a vegetable side dish. The nuts must have enough texture and consistency to remain whole throughout cooking and should have a good flavor.

Packed in Water. Whole peeled chestnuts and marroni may be canned in hot water (70°C) with salt (2% sodium chloride) and sugar (5% sucrose). The canning process includes sterilization at 116°C for 30–35 min.

Dry-packed. Considered to be an improvement over the canning process described above, dry-packed nuts remain more compact and keep their texture better than those canned in water, but the yellow color of the pulp turns brown (Breisch 1995). The peeled nuts are packed in glass jars and sterilized at 116°C for 35–40 min or at 100°C for 3 hr. It is also possible to add 10% of water, which is absorbed during the sterilization, but when opened the nuts appear dry (Giacalone and Bounous 1993).

Vacuum-packed. Fresh peeled or frozen nuts are used to prepare chestnuts and marroni marketed in vacuum-sealed transparent or aluminum packages. The package is sterilized at 116°C for 30–35 min. Advantages of vacuum packaging are long shelf life (10–12 months) and ease of preparation. Nuts are cooked during the sterilization process and are “ready to eat.”

Frozen Peeled. Frozen peeled nuts cook better and keep more of their original flavor and texture than any of the other “convenience” foods discussed so far. The freezing process begins by placing peeled nuts at –35° to –40°C for 15–20 min. Once frozen, they may be stored at –20°C until they are marketed. The product is packed in plastic bags usually holding 0.5–3.0 kg of product.

Chestnuts in Syrup. Chestnuts, steam peeled and placed in glass jars, are covered by syrup at a low concentration of sugar (25°Brix) and canned (1 hr at 100°C). Storage at room temperature can last 6 months (Pinnavia et al. 1993, 1999).

Candied Marroni. Only the largest marroni (55–65 nuts/kg) are used to prepare candied marroni. Often the frozen peeled product is preferred for the candying process, as this allows the work to be done on a year-round basis. The marroni are gently cooked, first in water, then in sugar syrup (50°Brix), which is gradually thickened as cooking proceeds. The process involves an osmotic exchange between the nuts, which absorb sugar from the syrup, while the syrup takes up water from the nuts. Higher temperatures, which tend to make the syrup more fluid, or vacuum conditions may accelerate the process. A sucrose-glucose mixture is used for the syrup so that no crystallization occurs in the finished

product at room temperature. The candied nuts are then canned with syrup for marketing or for further processing. Some producers flavor the syrup with vanilla or other flavoring agents. A final pasteurizing at 85°C ensures product stability and prolongs shelf life.

Marrons Glacés. The justly famous “*marrons glacés*” are often simply the candied nuts as described above, covered with a baked-on glazing. The process, however, requires a delicate touch and considerable skill and, in fact, the candy industry produces very small quantities, preferring to limit themselves to the production of the candied nuts, which are, in turn, supplied to the many pastry shops whose craftsmen do the final glazing by hand. Glazing is done by covering the candied nuts with the syrup in which they are packed and placing them for one or two minutes in a 300°C oven. The heat turns the syrup into a shiny translucent “glass.”

Marroni in Alcohol. Candied marroni may be preserved in liqueur in glass jars. During storage, some osmotic exchange does occur between nuts and liquor.

Chestnut or Marroni Cream. Sucrose (30%) and often vanilla are added to the pulp, thinner than purée. The mixture is warmed up at 85°–90°C and packed under heat and it can be used directly or as an ingredient in cakes.

Flour. Chestnut flour is obtained from dried and peeled chestnuts. The flour, widely used in the past, is now being used again because it is rich in mineral elements, in sucrose, and in starch and has a high nutritional value. Flour, if well dried to avoid molds, is a genuine, highly nutritive, and easy to preserve food used to prepare gnocchi (a little ball of pasta), pasta, bread, polenta, and many different pastries. Flour is milled more than once to obtain a very fine product. Discards from drying and milling into flour are used for livestock feeding.

Flakes. The starch content of chestnut flour is similar to the starch content of cereal flour, but chestnuts have a higher content of sugars and show a good aptitude for extrusion cooking, preserving the initial organoleptic properties. A mixture of chestnut flour (40%), rice flour (55%) and salt (5%) subjected to the cooking extrusion process offers a breakfast cereal ready to use (Sacchetti and Pinnavia 1999). Drying and toasting follows the extrusion. Flakes also can be obtained from nuts after milling and pulp dehydration. In France, crumbled chestnuts and

marroni are transformed into flakes to use at breakfast (muesli), in soups, and in baby food (Breisch 1995).

Other Products. Among Italian traditional products, the “*castagne del prete*” or chestnut of the priest has a special chocolate flavor. It is obtained with partial dehydration and toasting in traditional wood-burning ovens, followed by bathing and drying. Other products are marrons cooked in syrup “*marroni cotti sciropati*,” obtained after manual peeling, through many cooking phases. In the first phase, nuts are plunged into water at room temperature and then gradually taken to 55°C; in the second phase, they slowly (30–40 min) reach the temperature of 90°C, after which they are cooked in a sugar solution (50%) for 20 min at 90°C and then left to cool. Nuts are covered with syrup (50% sugar) and sterilized. This is a very common product in Japan and Korea. It is also possible to prepare beverages from chestnuts such as liqueurs (France, Italy), beer (Corsica, Switzerland), and non-alcoholic beverages (Korea).

E. Nutritional Composition and Food Uses

1. Nutritional Value. Chestnuts meet the current demand of consumers, who are increasingly seeking natural, nutritious, and wholesome foods and food products. This makes an important niche for chestnuts, which can be produced without pesticides, and be in full accordance with organic farming principles. From a nutritional point of view, they are similar to rice or wheat and have therefore come to be termed “the grain that grows on a tree” (Burnett 1988). Fresh chestnuts have a high calorie content (160 kcal per 100 g of edible product) and the water content is around 50% in the fresh product, and 10% in the dried chestnut (Table 6.7).

Carbohydrates. Fresh chestnuts have a higher carbohydrate content (sugars and starch) than most nuts (34 g average per 100 g of fresh edible product) and are therefore an excellent energy source. Starch averages from 24 g/100 g in fresh chestnuts to almost 42 g/100 g in dry chestnuts; sugar varies from about 10 g/100 g in fresh nuts to about 24 g/100 g in flour.

Sucrose, the main sugar, is present in greater concentration than in wheat, walnut, and potato, while glucose, fructose, and maltose are present only in small quantities. The presence of soluble carbohydrates makes long storage difficult, due to the possibility of the growth of microorganisms (fungi in particular), but curing the nuts in water is a way of solving the problem (Giacalone and Bounous 1993).

Table 6.7. Composition and nutritional value of chestnuts. Sources: Food Composition Tables INN 1997, integrated with the data from Brighenti et al. 1998; Institut Scientifique d'Hygiène Alimentaire, Paris, 1974; Panatta 1999; Bounous et al. 2001.

Constituents	Product					RDA
	Fresh	Dry	Roasted	Boiled	Flour	
Proximal analysis						
Water (%)	52.9	10.1	42.4	63.3	11.4	
Calories (kcal)	160	287	200	120	343	2900 (2150) Kcal
Nutrients (g/100 g)						
Carbohydrates	34.0	57.8	39	24.4	63.6	522 (413) g
Sugar ^z	9.6	16.1	10.7	7.5	23.6	
Starch	24.4	41.7	28.3	16.9	40	
Food fiber	7.3	13.8	8.3	5.4	14.2	
Protein	3.2	6	3.7	2.5	6.1	62 (53) g
Lipid	1.8	3.4	2.4	1.3	3.7	95 (73) g
Minerals (mg/100 g)						
Potassium	395	738			847	3100 mg
Phosphorous	70	131			164	800 mg
Sulphur	48	126			126	
Magnesium	35	—			74	350 mg
Calcium	30	56			50	800 mg
Chloride	10	18.6			18	
Sodium	9	17			11	
Iron	1	1.9			3.2	10 (18) mg
Manganese	0.7	1.3			1.3	4 mg
Copper	0.6	0.6			0.6	1.2 mg
Zinc	—	0.3			0.3	10 (7) mg
Vitamins (mg/100 g)						
B1 Thiamin	0.1	0.2			0.2	1.2 (0.9) mg
B2 Riboflavin	0.3	0.4			0.4	1.6 (1.3) mg
PP Nicotinic acid	1.1	2.1			1	18 (14) mg
C Ascorbic acid	23	—			—	60 mg
B5 Pantothenic acid	0.9	—			—	5 mg
Phytic acid	50	—			—	

RDA = Recommended Daily Allowance. Referring to men or women (in brackets) of between 30–49 years of age, with a body weight of 65 and 56 kg, respectively (Human Nutrition Association, 1996).

^zSucrose, glucose, fructose, maltose.

The attention given to the nutritional content of chestnuts has increased, because it has come to be considered a valid alternative food for children who are allergic to cow's milk or lactose intolerant (Grassi et al. 1997). Chestnut flour is an ideal alternative in the preparation of sweet products and soups, providing the required carbohydrate content

for those individuals with cereal intolerance (coeliacs). The soluble solid contents give the chestnuts their sweet flavor, which is the predominant organoleptic feature of fresh chestnuts.

Fiber. Fiber content of chestnuts is almost 7–8 g/100 g of fresh product and the insoluble part is much greater than the soluble part; in chestnut flour it is around 14%. Fiber is responsible for the structure of the seed, and therefore determines chestnut consistency, which is important in assessing the acceptability of the product.

Proteins. Protein content (roughly 3 g/100 g of fresh product) is equivalent to that of milk, although prolamin and glutenin (gluten progenitors) are absent. Due to the absence of these substances it can only be made into bread if mixed together with cereal flour. The protein in chestnuts is of high quality as it contains essential amino acids (tryptophan, lysine, and the sulfonated amino-acids, methionine and cysteine), and is comparable to the protein content of eggs, considered ideal for amino acid balance (Burnett 1988). In dried nuts, the protein content (5–6%) is greater than in potato (2%) but much less than in cereals (10–12%) or in dried vegetables (20–25%) (Panatta 1999).

Lipids. Chestnuts are low in fat (1.8–2.0 g/100 g of fresh product) unlike the majority of other nuts, which are notoriously rich in fat (walnuts, hazelnuts, almonds). Although the fat content is low, it is of high quality, and a source of linoleic acid, an essential fatty acid. The concentration of linoleic and linolenic is the same as found in potato and wheat, accounting for about 65% of the total lipids (Kunsch et al. 1999).

Minerals. Chestnuts have a high potassium content (395 mg/100 g). The low sodium content (9 mg/100 g) is a further advantage of the chestnut as compared, for example, to whole rice, which contains 100 times more (323 mg/100 g) (Burnett 1988). Dried chestnuts have a modest content of sodium (17 mg/100 g of edible matter), iron (1.5–1.9 mg/100 g), calcium (< 60 mg/100 g), but a very high content of potassium (738 mg/100 g average).

Vitamins. Two important vitamins of the B group, riboflavin (B2) and nicotinic acid (PP) are found in significant quantities in chestnuts. B vitamins are thermo-stable, and are not destroyed by cooking. Other important vitamins include PP (1.1 mg/100 g of fresh product), B1 (thiamine, 0.1 mg/100 g), C (23 mg/100 g in fresh nuts), and pantothenic acid (0.9 mg/100 g).

The nutritional content of chestnuts varies according to cooking and preparation methods. When boiled, water content increases and energy values fall by about 25%. When roasted, carbohydrates (39.0 g) and energy values (200 kcal) increase by about 25%, while water content drops to 42.4%. Cooking alters the starch content, which is reduced on boiling with a reduction in the potassium and magnesium content, but not in calcium; sucrose, lipid, and protein content are altered slightly (Kunsch et al. 1999).

2. The Chestnut as a Food in the Past and in the Present. The chestnut was, for centuries, a staple food for generations of mountain people in Europe and also constituted the food of rural populations who turned to it in times of famine and poverty. For centuries chestnut was known as the “tree of bread,” and it was planted in densely populated areas, extending beyond its natural range, where it grew and bore fruit only thanks to painstaking care in tending the trees. As cultivation was gradually extended, the nuts provided an alternative to cereals, as a food for the humans, thanks to the fact that it was easily available and easy to store. Because of its low cost and high nutritional content, it later became known as the “bread of the poor.” In the daily struggle for survival, poor people learned how to use chestnuts in a variety of ways to meet their nutritional needs, and to avoid hunger.

Until the mid-20th century, the average diet of many rural people, in places where chestnuts grew in Europe, was based on chestnuts for at least 4–6 months of the year. Per-capita consumption was about 150 kg/year (Merz 1919). Chestnut growers often planted different cultivars of chestnut trees to meet various requirements for drying, for flour making, and for fresh consumption (Conedera 1996). Everything was transformed in a highly practical manner into highly creative dishes, which formed the basis of a subsistence diet. Great creativity was used in inventing various ways of preparing the chestnuts. They were roasted or boiled in water or milk, and consumed as a substitute for bread, served hot with wine or milk in the form of a soup, and ground and used as substitutes for more costly cereal flours for the preparation of polenta, porridge, bread, and thick soups. With growing affluence, chestnut consumption declined.

Due to the nutritional value, chestnut products could once again make a comeback in our daily eating habits, free of the stigma of poverty with which it has been linked for centuries. In Europe, the chestnut has acquired a new standing due to the desire to restore traditional values and the demand for wholesome foods. Gastronomically, chestnut can be viewed in two ways: on the one hand it has strong links with past

traditions; on the other, it is a food ideal for today's healthy eating trends. Although the chestnut has tended to be featured as an ingredient for sweets and desserts in the cookery books, the chestnut can also be used in the preparation of appetizers and main courses.

There are centuries of experience in chestnut growing regions of Europe in the preparation of dried chestnuts and chestnut flour, which can be used for soups and polenta and other traditional dishes. Use of chestnuts in the preparation of tagliatelle (large noodles), gnocchi, and ravioli is becoming increasingly common. Dried chestnuts are boiled in a little water and served hot with local cured pork. Whether they are served whole, boiled, stewed, or (especially) roasted they make an excellent side dish or a delicious ingredient for salads. They can also be served with various types of meat (chicken, turkey, pork, goose, rabbit) and are often used for stuffing.

Because of the abundant sugar content of the nut, it has for centuries been used in the preparation of refined desserts and sweets such as *marrons glacés*, mousse, soufflé, creams "*bavaresi*" (specialty cream-based pastries), and ice-creams. The taste, however, makes them ideal for use in less elaborate desserts such as "*castagnacci*" (chestnut flour bread), "*necci*" (a type of savory chestnut flour bread), fritters, and milk-based puddings. Just as in the past, roast chestnuts or "*ballotte*" (chestnuts cooked in water flavored with fennel seeds), that are washed down with a glass of red wine create a great convivial atmosphere during autumn afternoons in the open air or on cold winter evenings around the fire.

Chestnuts have a delicious taste, and are versatile for use in a variety of gastronomic preparations ranging from first to main course dishes as well as vegetable dishes, desserts and pastries. They also make a very healthy and high-energy food. Because they are low in fat, free of cholesterol, low in sodium and high in potassium content, with a moderate but high-quality protein content and a favorable amino-acid ratio, chestnuts are a balanced and high-quality food.

V. THE FUTURE OF THE CHESTNUT INDUSTRY

The chestnut is an important resource both for its wide geographical distribution and its economic and environmental role in many agro-forestry systems. In the last quarter of the 20th century, there has been a progressive re-evaluation of natural resources based on the principles of sustainable agricultural policies with increasing emphasis on traditional production and natural landscapes. Appropriate management of chest-

nut plantations and recovered forests will create revenue and employment along the production chain. Nut and timber production are integrated with the many activities related to a multitude of values for sustainable development of the territory.

The rediscovery of traditional tastes and products could provide a growing impetus for the chestnut industry. However, quality is essential to compete in a global and complex market. The future of the chestnut industry depends on both the quality of the raw materials and the processed product. Significant progress has been obtained in horticulture (propagation and orchard management), genetics and breeding, phytopathology, and the food processing industries based on the combined effort of researchers and producers. But research and development must be strengthened for the industry to be competitive in a knowledge-based agriculture. Clearly, the future of the chestnut industry involves the development of an integrated production system based on sound science. It requires a combination of organized research and development with grower and processor inventiveness. Absolutely essential are efforts to increase consumer awareness of the importance of chestnuts to a healthful diet (Bounous 2002).

LITERATURE CITED

- Anagnostakis, S. 1987. Chestnut blight: the classical problem of an introduced pathogen. *Mycologia* 79:23–37.
- Anagnostakis, S. L. 1991. Peroxidase allozyme phenotypes in *Castanea* and their segregation among progeny. *HortScience* 26:1424.
- Anagnostakis, S. 1992. Genetic studies with the chestnut blight fungus, *Cryphonectria parasitica*. Proc. Int. Chestnut Conf., Morgantown, WV. p. 165–167.
- Anelli, G., and F. Mencarelli. 1992. Aspetti innovativi dei trattamenti conservativi delle castagne. Atti Convegno Nazionale Castanicoltura da Frutto, Avellino, Italy. p. 343–350.
- Areses, M. L., and E. Vieitez. 1970. Monthly variation in the content of growth substances and inhibitors in cuttings leaf buds and leaves of the chestnut (*Castanea sativa* Mill.). *Anal. Edaf. Agrobiol.* 29:625–630.
- Ashworth, F. L. 1964. Winter hardy chestnuts. Ann. Rep. Northern Nut Growers Assoc. 55:23–25.
- Bartolini, G., C. Briccoli-Bati, A. Cimato, M. De Agazio, I. Napoleone, and M. Toponi. 1977. Ricerche sulla immersione in acqua delle talee. Il nota. *Riv. Ortoflorofrutt.* It. 61:39–49.
- Basso, M. 1955. Ricerche ed osservazioni sul polline di alcune specie e cultivar fruttifere della provincia di Pisa. *Agric. Ital.* 10:111–125.
- Beakbane, A. B. 1961. Structure of the plant stem in relation to adventitious rooting. *Nature* 192:954–955.
- Bellini, E. 1995. Salviamo il castagno per la produzione di pregiati marroni. *L'Inf. Agr.* 24:39–48.
- Bergamini, A. 1975. Osservazioni sulla morfologia florale di alcune cultivar di castagno. *Riv. Ortoflorofrutticoltura Italiana* 59:103–108.

- Bergamini, A., and A. Ramina. 1971. Contributo allo studio della differenziazione a fiore del castagno (*Castanea sativa* L.). Riv. Ortoflorofruitticoltura Italiana 6:484–491.
- Bergougnoux, F., A. Verlhac, H. Breish, and J. Chapa. 1978. Le Châtaignier. Production et culture. INVUFLEC, Paris. p. 192.
- Biricolti, S., A. Fabbri, F. Ferrini, and P. L. Pisani. 1992. Anatomical investigations on chestnut adventitious rooting. Proc. Int. Chestnut Conf., Morgantown, WV. p. 93–96.
- Boccacci, P., D. Marinoni, A. Akkak, G. Beccaro, G. Bounous, and R. Botta. 2001. Valutazione ed impiego di marcatori molecolari per la certificazione genetica in *Castanea sativa* Mill. Atti Convegno Nazionale Castagno. Marradi (FI):98–102.
- Botta, R., D. Marinoni, G. Beccaro, A. Akkak, and G. Bounous. 2001. Development of a DNA typing technique for the genetic certification of chestnut cultivars. For. Snow Landsc. Res. 76, 3:425–428.
- Botta, R., P. Boccacci, A. Akkak, D. Torello Marinoni, G. Beccaro, and G. Bounous. 2003. Prospettive di certificazione genetica per una frutticoltura di qualità. Italus Hortus 10 (suppl. al n.3):22–27.
- Bounous, G. 2001. Inventory of chestnut research, germplasm and references. FAO REU Technical Series, 65, Rome. p. 174.
- Bounous, G. 2002. Il Castagno: coltura, ambiente ed utilizzazioni in Italia e nel mondo. Edagricole—Edizioni Agricole del Il Sole 24 ORE Edagricole, Bologna. p. XIV + 312.
- Bounous, G. 2003. Castanicoltura in Europa: situazione e prospettive. Italus Hortus 10 (suppl. al n.3):35–45.
- Bounous, G., and G. Beccaro. 2002. Chestnut culture: directions for establishing new orchards. FAO-CIHEAM, Nucis Newsletter, 11:30–34.
- Bounous, G., R. Botta, and G. Beccaro. 2001. Valore nutritivo e pregi alimentari nelle castagne. Frutticoltura 10:37–44.
- Bounous, G., J. H. Craddock, C. Peano, and P. Salarin. 1992. Phenology of blooming and fruiting habits in Euro-Japanese hybrid chestnut. Proc. Int. Chestnut Conf., Morgantown, WV. p. 117–128.
- Bounous, G., F. Parola, C. Peano, P. Basiglio, A. De Martino, and M. Intropido. 1995. Prove di innesto abbinate all'impiego di mastici protettivi per il recupero di un castagneto da frutto. L'Inf. Agr. 51(14):77–80.
- Breisch, H. 1993. Le verger de châtaignier, une culture a part entiere. L'Arboriculture Fruitiere 458:33–38.
- Breisch, H. 1995. Châtaignes et marrons. Ctifl, Paris. p. 239.
- Breviglieri, N. 1951. Ricerca sulla biologia fiorale e di fruttificazione della *Castanea sativa* e *Castanea crenata* nel territorio di Vallombrosa. Centro di Studio sul Castagno C.N.R., pubbl. 1, suppl. a La Ricerca Scientifica 21:15–49.
- Breviglieri, N. 1955a. Ricerche sulla disseminazione e sulla germinazione del polline nel castagno. Centro di Studio sul castagno C.N.R., pubbl. 2, suppl. a La Ricerca Scientifica 25:5–25.
- Breviglieri, N. 1955b. Indagini ed osservazioni sulle migliori varietà italiane di castagno. Centro di Studio sul castagno C.N.R., pubbl. 2, suppl. a La Ricerca Scientifica 25:27–166.
- Brighenti, F., M. Campagnolo, and D. Bassi. 1998. Biochemical characterization of the seed in instinct chestnut genotypes (*C. sativa*). Abstracts Second Int. Symp. on Chestnut, Bordeaux, France.
- Brussino, G., G. Bosio, M. Baudino, R. Giordano, F. Ramello, and G. Melika. 2002. Pericoloso insetto esotico per il castagno europeo. L'Inf. Agr. 37:59–61.
- Buck, E. J., M. Hadonou, C. J. James, D. Blakesley, and K. Russell. 2003. Isolation and characterization of polymorphic microsatellites in European chestnut (*Castanea sativa* Mill.). Molecular Ecology Notes 3:239–241.

- Burnett, M. 1988. The grain that grows on a tree. Reprinted from "Chestnutworks." Portland, OR. p. 12–15.
- Burnham, C. R., P. A. Rutter, and D. W. French. 1986. Breeding blight-resistant chestnuts. *Plant Breed. Rev.* 4:347–397.
- Caldwell, B. 1986. Update on chestnut layering. 77th Ann. Rep. Northern Nut Growers Assoc. p. 116–122.
- Caldwell, B., and K. Mudge. 1985. Production of own-rooted chestnut trees. 76th Annu. Rep. North. Nut Gro. Assoc. p. 92–97.
- Camus, A. 1929. Les Châtaigniers. Monographie des genres *Castanea* et *Castanopsis*. Encyclopedie economique de sylviculture, Vol. III. Lechevalier, Paris. p. 604.
- Canciani, L., E. Dallavalle, A. Zambonelli, and A. Zecchini D'Aulerio. 1993. Prove di protezione chimica su innesti di castagno. Proc. Int. Cong. Chestnut, Spoleto (PG), Italy. p. 235–238.
- Chapa, J., P. Chazerans, and J. Coulie. 1990. Multiplication vegetative du châtaignier. Amelioration par greffage de printemps et bouturage semi-ligneux. *L'Arboriculture Fruitiere* 431:41–48.
- Chauvin, J. E., J. Guinberteau, and G. Salesses. 1988. Mycorhization in vitro de clones de châtaigniers. Perspectives d'application à la lutte biologique contre les agents de l'encre et à la production de champignons comestibles. 8^{em} Colloque sur les recherches fruitières, Bordeaux, France.
- Chauvin, J. E., and G. Salesses. 1987a. Effet du fructose sur la micropropagation du châtaignier *Castanea* spp. *C.R. Acad. Sci.* 306(III):207–212.
- Chauvin, J. E., and G. Salesses. 1987b. Quelques aspects de la culture in vitro chez le châtaignier (*Castanea* spp.). 7^{em} Colloque sur les recherches fruitières, Bordeaux, France.
- Chauvin, J. E., and G. Salesses. 1988. Advances in chestnut micropropagation (*Castanea* spp.). Vegetative propagation of woody species (Pisa). *Acta Hort.* 227:340–345.
- Chevre, A. M. 1985. Recherche sur la multiplication végétative in vitro chez le châtaignier. Thèse de l'Université de Bordeaux II, Mention Sciences de la Vie, p. 100.
- Chevre, A. M., and G. Salesses. 1985. Micropropagation du châtaignier. Problèmes et perspectives. 5^{em} Colloque sur les recherches fruitières, Bordeaux, France. p. 215–227.
- Clapper, R. B. 1954. Chestnut breeding, techniques and results. Inheritance of characters, breeding for vigour, and mutations. *J. Hered.* 45:106–114, 201–208.
- Conedera, M. 1996. Die Kastanie, der Brotbaum. *Bundnerwald* 49 (6):28–46.
- Craddock, J. H. 1998. Chestnut resources in North America. *Ann. Rep. Northern Nut Growers Assoc.* 89:19–30.
- Craddock, J. H., G. Bounous, and C. Peano. 1992. Rooting of chestnut hybrids by stem cuttings. Proc. World Chestnut Industry Conf., Morgantown, WV. p. 61–71.
- Desvignes, J. C. 1996. L'incompatibilité du châtaignier induite par le chestnut mosaic virus—ChMV. *Infos. Ctifl*, p. 121.
- Desvignes, J. C., and D. Cornaggia. 1996. Mosaïque du châtaignier. Transmission par le puceron *Myzocallis castanicola*. *Phytoma* 48:39–41.
- Diaz, T., I. Iglesias., and E. Gonzalez. 1988. Influence of cold storage (4°C) and auxin application on the rooting of chestnut cuttings. *Acta Hort.* 227:272–274.
- Edwards, R. A., and M. B. Thomas. 1980. Observations on physical barriers to root formation in cuttings. *The Plant Propagator* 6–8.
- Elkins, J. R., G. J. Griffin, and R. J. Stipes. 1978. Blight development and methyl-2-benzimidazole carbamate levels in bark tissues of American chestnut trees following soil injection of benomyl. Proc. Am. Chestnut Symp. W.V. University Books, Morgantown, WV. p. 73–79.

- Fabbri, A., F. Ferrini, A. Masia, and P. L. Pisani. 1992. Enzyme activity during adventitious rooting of stoolbed propagated chestnut. Proc. Int. Chestnut Conf., Morgantown, WV. p. 89–92.
- Fairchild, D. 1913. The discovery of the chestnut bark disease in China. Science 38: 297–299.
- Fenaroli, L. 1945. Il castagno. Reda, Roma, Italy. p. 222.
- Fernández, J., S. Pereira, and E. Miranda. 1992. Fog and substrate conditions for chestnut propagation by leafy cuttings. In: Mass production technology for genetically improved fast growing forest tree species. II. AFOCEL-IUFRO, Bordeaux, France. p. 379–383.
- Fernández De Ana Magán, F. J., M. C. Verde Figueiras, and A. Rodriguez Fernandez. 1997. O souto, un ecosistema en perigo. Xunta de Galicia. p. 205.
- Ferreira Batista, J. G. 1993. The use of chestnut logs as a substrate for the cultivation of shiitake (*Nentinus edodes*). Proc. Int. Cong. Chestnut, Spoleto (PG), Italy. p. 417–420.
- Ferrini, F. 1993. La propagazione vegetativa del castagno. Frutticoltura 12:43–48.
- Ferrini, F. 1997. Research on chestnut stoolbed propagation. COST G4—Workshop on Tree Physiology and Genetic Resources of Chestnut, Torre Pellice (TO), Italy.
- Ferrini, F., G. B. Mattii, F. P. Nicese, and P. L. Pisani. 1992. Ricerche per la costituzione di portinnesti clonali per il castagno. Giornate Scientifiche SOI, Ravello (SA), Italy. p. 412–413.
- Gardiman, M., A. Masia, and G. Ponchia. 1993. Some biochemical aspects of adventitious rooting of stooling propagated chestnut (*Castanea sativa* Mill.). Proc. Int. Cong. Chestnut, Spoleto (PG), Italy. p. 191–194.
- Gellini, R., M. Falusi, and P. Grassoni. 1977. La cultivar *Politora* di Stazzema e saggi sulla propagazione del castagno. Giornata del Castagno, Caprese Michelangelo (AR), Italy. p. 260–273.
- Gesto, M. D. V., A. Vazquez, and E. Vieitez. 1981. Changes in the rooting inhibitory effect of chestnut extracts during cold storage of the cuttings. Physiol. Plant. 51(4):365–367.
- Giacalone, G., and G. Bounous. 1993. Tradizione e innovazione nella trasformazione e nell'utilizzo delle castagne. Monti e Boschi 5:33–41.
- Giordano, E. 1993. Biology, physiology and ecology of chestnut. Proc. Int. Cong. Chestnut, Spoleto (PG), Italy. p. 89–93.
- Grassi, G. 1992. Individuazione, valutazione e conservazione di biotipi e cultivar di castagno da frutto. Atti Convegno “Germoplasma Frutticolo,” Alghero (SS), Italy. p. 603–606.
- Grassi, G., M. Mastronicola, and A. Parente. 1997. Atti Convegno Nazionale sul Castagno, Cison di Valmarino (TV), Italy. p. 575.
- Graves, A. H. 1961. Keys to chestnut species. Ann. Rep. Northern Nut Growers Assoc. 52:78–90.
- Harrison-Murray, R. S., B. H. Howard, and K. A. D. Mac Kenzie. 1981. Mechanisms of cutting propagation. Rep. E. Malling Res. Sta. for 1980. p. 60–65.
- Huang, H., and J. D. Norton. 1992. Enzyme variation in Chinese chestnut cultivars. Proc. Int. Chestnut Conf., Morgantown, WV. (Abstr).
- Jaynes, R. A. 1962. Chestnut chromosomes. Forest Sci. 8:372–377.
- Jaynes, R. A. 1963. Biparental determination of nut characteristics in *Castanea*. J. Hered. 54:84–88.
- Jaynes, R. A. 1975. Chestnuts. p. 490–503. In: J. Janick and J. N. Moore (eds.), Advances in fruit breeding. Purdue Univ. Press, West Lafayette, IN.
- Jaynes, R. A., and S. L. Anagnostakis. 1971. Inhibition of *Endothia parasitica* in field grown American chestnut trees. Plant Dis. Rptr. 55:199–200.
- Jaynes, R. A., and N. K. Van Alfen. 1977. Control of the chestnut blight fungus with injected methyl-2-benzimidazole carbamate. Plant Dis. Rptr. 61:1032–1036.

- Johnson, G. P. 1987. Chinkapins: Taxonomy, distribution, ecology, and importance. Ann. Rep. Northern Nut Growers Assoc. 78:58–62.
- Johnson, G. P. 1988. Revision of *Balanocastanon* (Fagaceae). J. Arnold Arbor. 69(1):25–49.
- Kunsch U., H. Scharer, B. Patrian, J. Hurter, M. Conedera, A. Sassella, M. Jermini, and J. Jelmini. 1999. Quality assessment of chestnut fruits. Acta Hort. 494:119–127.
- Lagerstedt, H. B. 1987. A review of chestnut propagation. p. 56–61. In: M. S. Burnett and R. D. Wallace (eds.), Chestnuts and creating a commercial chestnut industry. Proc. Second Pacific Northwest Chestnut Cong., Corvallis, OR.
- Liu, L. 1993. The germplasm resources of chestnut in China. Proc. Int. Cong. Chestnut, Spoleto (PG), Italy. p. 271–274.
- Mage, F. 1982. Black plastic mulching, compared to other orchard soil management methods. Scientia Hort. 16:131–136.
- Marangoni, B., M. Quartieri, and D. Scudellari. 1997. Tecnica colturale del ciliegio: gestione del suolo, irrigazione e fertilizzazione. Atti Convegno Nazionale Ciliegio, Valenzano (BA), Italy. p. 281–306.
- Marinoni, D., R. Botta, A. Akkak, A. M., Ferrara, and G. Bounous. 2001. Diversità genetica del germoplasma di castagno (*Castanea sativa* Mill.) coltivato in Piemonte. Atti Convegno Nazionale Castagno. Marradi (FI):74–79.
- Marinoni, D., A. Akkak, G. Bounous, K. J. Edwards, and R. Botta. 2003. Development and characterization of microsatellite markers in *Castanea sativa* (Mill.). Molec. Breed. 11:127–136.
- Maynard, C. 1991. Chestnut pollen collection and handling. J. Am. Chestnut Found. 6(2):101–106.
- McKay, J. W. 1942. Self-sterility in the Chinese chestnut (*Castanea mollissima*). Proc. Am. Soc. Hort. Sci. 41:156–160.
- Meotto, F., S. Pellegrino, and G. Bounous. 1999. Evolution of *Amanita caesarea* (Scop:Fr) Pers and *Boletus edulis* Bull.: Fr. Synthetic ectomycorrhizae on European Chestnut (*Castanea sativa* Mill.) seedlings under field conditions. Acta Hort. 494:201–204.
- Merz, F. 1919. Die Edelkastanie: Ihre volkswirtschaftliche Bedeutung, ihr Anbau und ihre Bewirtschaftung. Verlag Schw. Dept. Innern, Bern. 71 S.
- Morettini, A. 1949. Biologia florale del castagno. L'Italia agricola 12:264–274.
- Norton, J. D. 1986. Resistance to *Dryocosmus kuriphilus* in *Castanea mollissima*. HortScience 21:269 (821). (Abstr.)
- Paganelli, A. 1997. Evoluzione storica del castagno (*Castanea sativa* Mill.) nell'Italia nord-orientale dal pleistocene superiore attraverso l'indagine palinologica. Atti Convegno Nazionale sul Castagno, Cison di Valmarino (TV), Italy. p. 83–96.
- Paglietta, R., and G. Bounous. 1979. Il castagno da frutto. Edagricole, Bologna. p. 189.
- Panatta, G. B. 1999. Un frutto energetico e gustoso. Il Divulgatore, Bologna, XXII, 10:73–76.
- Pardo, R. 1978. National register of big trees. Am. For. 84(4):18–46.
- Payne, J. A., A. S. Henke, and P. M. Schroeder. 1975. *Dryocosmus kuriphilus* Yasumatsu (Hymenoptera:Cynipidae) an oriental chestnut gall wasp in North America. USDA Coop. Econ. Insect Rep. 25:903–905.
- Payne, J. A. and W. T. Johnson. 1979. Plant pests. p. 314–395. In: R. A. Jaynes (ed.), Nut tree culture in North America. Northern Nut Growers Assoc., Hamden, CT.
- Payne, J. A., G. P. Johnson, and G. Miller. 1991. Chinkapin: Potential new crop for the south. Ann. Rep. Northern Nut Growers Assoc. 82:64–71.
- Payne, J. A., G. Miller, G. P. Johnson, and S. D. Senter. 1994. *Castanea pumila* (L.) Mill.: An underused native nut tree. HortScience 29:62:130–131.
- Peano, C., G. Bounous, and R. Paglietta. 1990. Contributo allo studio della biologia florale e di fruttificazione di cultivar europee, orientali ed ibridi del genere *Castanea* Mill. Ann. Fac. Sci. Agr. Univ. Torino, XVI:83–89.

- Peeters, A. G., and H. Zoller. 1988. Long range transport of *Castanea sativa* pollen. Grana 27:203–207.
- Pinnavia, G. G., S. Pizzirani, C. Severini, and D. Bassi. 1993. Experiments using some chestnut varieties conserved in sucrose syrup. Proc. International Congress on Chestnut, Spoleto (PG):441–444.
- Pinnavia, G. G., G. Sacchetti, C. Chaves-Lopez, and S. Romani. 1999. Study on the production feasibility of preserved chestnuts under low sugar content syrup. Acta Hort. 446:111–116.
- Pisani, P. L. 1992. La difesa del germoplasma di specie non comprese nel gruppo coordinato di ricerca del CNR. Atti Convegno “Germoplasma Frutticolo,” Alghero (SS), Italy. p. 579–583.
- Pisani, P. L., and E. Rinaldelli. 1991. Alcuni aspetti della biologia florale del castagno. Frutticoltura 52:25–30.
- Polacco, F. 1938. Indagine sulla coltivazione del castagno da frutto in Italia. Boll. mensile di Statistica agraria e forestale.
- Ponchia, G. 1986. Primi risultati sulla moltiplicazione del castagno (*Castanea sativa* Mill.) per talea di germoglio con la tecnica del “fog.” Atti “Giornate di Studio sul Castagno,” Caprarola (VT), Italy. p. 161–171.
- Porsch, O. 1950. Geschichtliche lebenswertung der kastanienblüte. Oesterreichen Bot. Z. B97:3–4.
- Ridley, D., and J. Beaumont. 1999. The Australian chestnut growers’ resources manual. Agr. Victoria, Australia.
- Rinallo, C., R. Gellini, and A. Fabbri. 1987. Studies on rhizogenesis in *Castanea sativa* Mill. cuttings. Adv. Hort. Sci. 1:27–33.
- Roane, M. K., G. J. Griffin, and J. R. Elkins. 1986. Chestnut blight, other *Endothia* diseases, and the genus *Endothia*. Am. Phytopath. Soc., St. Paul, MN. p. 53.
- Rosengarten, F. Jr. 1984. The book of edible nuts. Walker and Company, New York. p. 384.
- Rutter, P. A., G. Miller, and J. A. Payne. 1991. Chestnut (*Castanea*). Acta Hort. 290:761–788.
- Sacchetti, G., and G. G. Pinnavia. 1999. A ready-to eat chestnut flour based breakfast cereal. Production and optimization. Acta Hort. 446:61–68.
- Salesses, G., J. Chapa, and P. Chazernas. 1993a. Screening and breeding for ink disease resistance. Proc. Int. Cong. Chestnut, Spoleto (PG), Italy. p. 545–549.
- Salesses, G., L. Ronco, J. E. Chauvin, and J. Chapa. 1993b. Amelioration genetique du châtaignier. Mise au point de test d’évaluation du comportement vis-à-vis de la maladie de l’encre. L’Arboriculture Fruitière 458:23–31.
- Salesses, G., J. Chapa, and P. Chazerans. 1993c. The chestnut in France-cultivars-breeding programs. Proc. International Congress on Chestnut, Spoleto (PG), Italy. p. 331–334.
- Santamour, F. S. Jr., A. J. McArdle, and R. A. Jaynes. 1986. Cambial isoperoxidase patterns in *Castanea*. J. Environ. Hort. 4(1):14–16.
- Shimura, I., M. Yasuno, and C. Otomo. 1971. Studies on the breeding behaviours of several characters in chestnuts, *Castanea* spp. Effects of the pollination time on the number of nuts in the bur. Japan. J. Breed. 21:77–80.
- Solignat, G. 1958. Observations sur la biologie du châtaignier. Ann. Amél. Plantes 8:31–58.
- Solignat, G. 1964. Rooting chestnut trees. Ann. Rep. Northern Nut Growers Assoc. 55:33–36.
- Solignat, G., and J. Chapa. 1975. La biologie florale du châtaignier. INVUFLEC, Paris. p. 36.
- Soylu, A., and M. Ayfer. 1993. Floral biology and fruit set of some chestnut cultivars (*Castanea sativa* Mill.). Proc. Int. Cong. Chestnut, Spoleto (PG), Italy. p. 125–130.

- Tagliavini, M., B. Marangoni, and P. Grazioli. 1993. Effects of P-supply on growth and P-micronutrient interactions of potted peach seedlings. p. 325–331. In: M. A. C. Frago and M. L. Van Beusichen (eds.), Optimization of plant nutrition. Kluwer Academic Publ., The Netherlands.
- Tampieri, F., P. Mandrioli, and G. L. Puppi. 1977. Medium range transport of airborne pollen. *Agr. Meteor.* 19.
- Tanaka, K., and K. Kotobuki. 1992. Studies on adhesion between pellicle and embryo of Japanese chestnut (*Castanea crenata* Sieb. et Zucc.) and Chinese chestnut (*Castanea mollissima* Bl.) *Acta Hort.* 317:175–180.
- Tani, A., and L. Canciani. 1993. Il recupero produttivo dei castagneti da frutto. A.R.F. Bologna. p. 45.
- Turchetti, T. 1978. Attacchi di *Endothia parasitica* (Murr.) And. su innesti di castagno. *L'Italia Forestale e Montana* 36:135–141.
- Turchetti, T., L. Castagneri, and G. Falchero. 1990. Prove di difesa biologica in alcuni castagneti della provincia di Torino. *Atti Convegno "Castagno 2000," Pianfei (CN), Italy.* p. 228–234.
- Vazquez, A., and M. D. V. Gesto. 1982. Juvenility and endogenous rooting substances in *Castanea sativa* Mill. *Biol. Plant.* 24(1):48–52.
- Vazquez, A., M. D. V. Gesto, and E. Vieitez. 1978. A growth inhibitor from *Castanea sativa* Mill. cuttings. *Biol. Plant.* 20(2):146–148.
- Vazquez, A., and E. Vieitez. 1962. Influencia de algunos factores en el crecimiento de embriones de castaño cultivados in vitro. *Anal. Edafol. Agrobiol.* 21:583–591.
- Vieitez, A. M., A. Ballester, M. C. San-José, and E. Vieitez. 1985. Anatomical and chemical studies of vitrified shoots of chestnut regenerated in vitro. *Physiol. Plant.* 65:177–184.
- Vieitez, A. M., and E. Vieitez. 1980a. Plantlet formation from embryonic tissue of chestnut grown in vitro. *Physiol. Plant.* 50:127–130.
- Vieitez, A. M., and M. L. Vieitez. 1980b. Culture of chestnut shoots from buds in vitro. *J. Hort. Sci.* 55:83–84.
- Vieitez, A. M., and M. L. Vieitez. 1982. *Castanea sativa* plantlet proliferated from axillary buds cultivated in vitro. *Sci. Hort.* 18:343–351.
- Vieitez, E. 1974. Vegetative propagation of chestnut. *N.Z.J. For. Sci.* 4(2):242–252.
- Vieitez, E., E. Seoane, M. D. V. Gesto, A. Vazquez, A. Mendez, A. Carnicer, and M. L. Arese. 1967. Growth substances isolated from woody cuttings of *Castanea sativa* Mill. *Phytochemistry* 6:913–920.
- Vieitez, J., and A. Ballester. 1988. Endogenous rooting inhibitors in mature chestnut cuttings. *Acta Hort.* 227:167–169.
- Weir, R. G., and G. C. Cresswell. 1993. Plant nutrient disorders. Vol. 1. Temperate and subtropical fruit and nut crops. Inkata Press, Melbourne, Australia.

The North American Pawpaw: Botany and Horticulture

Kirk W. Pomper

Kentucky State University, Land Grant Program, 129 Atwood
Research Facility, Frankfort, Kentucky 40601-2355

Desmond R. Layne

Clemson University, Department of Horticulture, Clemson, South
Carolina 29634-0319

- I. INTRODUCTION
- II. HISTORY
- III. BOTANY
 - A. Taxonomy
 - B. Morphology and Anatomy
 - C. Genetic Resources
 - D. Genetic Diversity
- IV. HORTICULTURE
 - A. Orchard Site Selection
 - B. Seedling Propagation
 - C. Clonal Propagation
 - D. Orchard Establishment and Training
 - E. Flowering, Fruit Set, and Yield
 - F. Fruit Ripening and Postharvest Physiology
 - G. Medicinal and Pesticidal Uses
 - H. Disease and Pest Management
 - I. Tree Decline
 - J. Marketing and Consumer Acceptance
- V. FUTURE PROSPECTS
- LITERATURE CITED

I. INTRODUCTION

The North American pawpaw [*Asimina triloba* (L.) Dunal] grows wild in mesic hardwood forests of 26 states in the eastern United States, flourishing in deep, fertile soils of river-bottom lands where it grows as an understory tree or thicket-shrub (Kral 1960; Callaway 1990; Callaway 1993). Pawpaws can be grown successfully in USDA plant hardiness zones 5 (minimum of -29°C) through 8 (minimum of -7°C) (Kral 1960). This tree produces the largest edible fruit native to the United States; it may reach up to 1 kg in size (Darrow 1975). The pawpaw fruit has both fresh market and processing potential, with an intense flavor that resembles a combination of banana, mango, and pineapple. Natural compounds in the leaf, bark, and twig tissues of pawpaw possess insecticidal and anti-cancer properties (McLaughlin 1997). The unique qualities of the fruit, ornamental value of the tree, and the potential for useful bioactive compounds suggest that pawpaw has great potential as a new high-value crop.

Although pawpaw has great potential for commercial production, orchard plantings remain limited. Currently, most pawpaw fruit for sale are collected from wild stands in the forest. However, in a number of states, including Alabama, California, Kentucky, Maryland, Michigan, Missouri, North Carolina, Ohio, and West Virginia, in the United States, small private orchards, usually less than 1 ha in size, have been planted and will be coming into production soon. There are also pawpaw plantings in Italy (Bellini et al. 2003), China, Israel, Japan, Romania, Belgium, and Portugal. In the United States, pawpaw fruit and products are mainly sold at farmer's markets, directly to restaurants, and via entrepreneurs on the Internet. Pawpaw fruit were sold in 2003 at the Farmer's Market in Lexington, Kentucky, for \$6.50 per kg. Local delicacies made from the fruit include pawpaw ice cream, compote, jam, and wine. However, at present the grower base is insufficient to establish a commercial processing industry.

Nursery wholesale and retail tree production represent an added economic opportunity for entrepreneurs beyond that of orchard production. Pawpaw trees currently sell for higher prices than most other fruit trees since they are attractive to homeowners in ornamental plantings, edible landscapes, specialty gardens, and habitat restoration (Layne 1996). In addition, *Asimina* spp. are suitable for butterfly gardens, as they attract the zebra swallowtail (*Eurytides marcellus* Cramer), for whom they are the exclusive larval host plant (Damman 1986; Haribal and Feeny 1998).

Many challenges are encountered in developing production practices for a new crop. Cultural practices can affect important aspects of plant growth and influence the overall dynamics of the production system.

The objective of this chapter is to review the botany and horticulture of the pawpaw and to summarize recent research efforts that have been conducted in an attempt to develop production recommendations for this promising new crop.

II. HISTORY

Pawpaws have a well-established place in folklore and American history. "Where, oh where, is dear little Nellie (Sallie, etc.)? 'Way down yonder in the pawpaw patch." This traditional American folk song and dance was quite popular once and fall hunting for pawpaws in the woods is a cherished tradition for many rural families in the southeastern United States. The first report of pawpaw dates back to 1541 when followers of the Spanish explorer Hernando de Soto found Native Americans growing and eating pawpaws in the valley of the Mississippi (Pickering 1879). The Native Americans used the bark of pawpaw trees to make fishing nets. John Lawson (1709) in *A New Voyage to Carolina* referred to pawpaws "as sweet, as any thing can well be. They make rare Puddings of this Fruit." John Filson (1784), an early settler, promoter and developer of Kentucky, stated that "the papp-tree does not grow to a great size, is a soft wood, bears a fine fruit much like a cucumber in shape and size, and tastes sweet." Daniel Boone and Mark Twain were reported to have been pawpaw fans. Lewis and Clark recorded in their journal (18 September 1806) how pawpaws helped save them from starvation. "Our party entirely out of provisions subsisting on poppaws. We divided the buisquit which amounted to nearly one buisquit per man, this in addition to the poppaws is to last us down to the Settlement's which is 150 miles. The party appear perfectly contented and tell us that they can live very well on poppaws." John James Audubon painted the yellow-billed cuckoo on a native pawpaw tree (ca. 1827). On 9 August 1882, three sons of Randolph McCoy (clan leader) were tied to pawpaw bushes and executed by the rival Hatfield family during the famous Hatfield-McCoy feud along the Kentucky–West Virginia border (Owens 1994). Several American towns, townships, creeks and rivers were named after the pawpaw during the 19th century.

Interest in pawpaw as a fruit crop was evident in the early 1900s (Little 1905; Popenoe 1916, 1917; Zimmerman 1938, 1941; Thomson 1974; Peterson 1991). At about this same time, interest in another native fruit, the blueberry (*Vaccinium* sp.), was also increasing. One reason for the failure of pawpaw to become as popular as blueberry was likely related to the rapid perishability of the fruit (Popenoe 1916, 1917). However, interest in pawpaw grew in the years between 1950 and 1985, nurtured

by the enthusiasm of individuals in the Northern Nut Growers Association (NNGA) (Peterson 2003). Since 1985, various associations and institutions committed to pawpaw development have emerged. The PawPaw Foundation (PPF) was founded in 1988, by R. Neal Peterson, as a nonprofit organization dedicated to the research and development of the pawpaw as a new fruit crop for farmers and consumers. In 1990, a full-time pawpaw research program was initiated at Kentucky State University (KSU) by Brett Callaway (Callaway 1992) and was expanded by Desmond Layne from 1993 to 1997 (Layne 1996) and has been under the direction of Kirk Pomper since 1998 (Pomper et al. 1999). For over 10 years at KSU there have been cooperative research projects with PPF to advance our understanding of the pawpaw. Two international pawpaw conferences have been held. The first conference was held in 1994 at the Western Maryland Research and Education Center in Keedysville, Maryland, where about 45 scientists, nurserymen, entrepreneurs, and enthusiasts attended. The second conference was held at KSU in Frankfort, Kentucky and had over 130 people in attendance (Pomper et al. 2003a). The Ohio Pawpaw Growers Association (Albany, Ohio) was established in 2000 to organize and advance the development of a pawpaw industry in Ohio. The Ohio Pawpaw Growers Association, PPF, and the KSU pawpaw program, as well as other associations and institutional programs that will likely be established, will be important in promoting, marketing and consumer education programs concerning pawpaw.

III. BOTANY

A. Taxonomy

The tropical custard apple family, Annonaceae, is the largest primitive family of flowering plants, containing approximately 130 genera and 2300 species (Conquist 1981). This family includes several delicious tropical fruits such as the custard apple (*Annona reticulata* L.), cherimoya (*A. cherimola* Mill.), sweetsop or sugar apple (*A. squamosa* L.), atemoya (*A. squamosa* × *A. cherimola*), and soursop (*A. muricata* L.) (Bailey 1960). The genus *Asimina* is the only temperate-zone representative of the tropical Annonaceae, and includes nine species, most of which are native to the extreme southeastern regions of Florida and Georgia (Kral 1960; Callaway 1990, 1993). These species include *Asimina incarnata* (Bartr.) Exell. (flag pawpaw), *A. longifolia* Kral, *A. obovata* (Willd.) Nash, *A. parviflora* (Michx.) Dunal (dwarf pawpaw), *A. pygmaea* (Bartr.) Dunal, *A. reticulata* Shuttlw. ex Chapman, *A. tetramera* Small (opossum pawpaw), *A. × nashii* Kral and *A. triloba* (Kral 1960). All

Asimina species are diploids, $2n = 2x = 18$, with the possible exception of *A. pygmaea* (Bartr.) Dunal, for which chromosome counts have not been reported (Bowden 1948; Kral 1960). Triploid *A. triloba* hybrids have also been reported to exist (Bowden 1949).

The genera of Annonaceae have been difficult to separate; therefore, the pawpaw has undergone a number of nomenclature changes (Kral 1960). Linnaeus first classified it as *Annona triloba* in 1753. Ten years later, Adanson assigned the pawpaw to the *Asimina* genus. It remained in this classification for several years, until 1803 when Michaux reclassified pawpaw as *Orchidocarpum arietinum*. Four years later Persoon reclassified it as *Porcelia triloba*. In 1817 Dunal returned pawpaw to *Asimina*, but Torrey and Gray transferred it to the genus *Uvaria* in 1838. In 1886, Gray reconsidered the classification and returned pawpaw to *Asimina*. *Asimina triloba* (L.) Dunal is the nomenclature currently accepted (Kral 1960).

The large-fruited pawpaw, *Asimina triloba*, is likely the best-known member of the *Asimina* genus. This species has the most northerly and largest native range of the genus, extending from northern Florida to southern Ontario, Canada, and as far west as eastern Nebraska and Texas (Kral 1960; Callaway 1990, 1993). The fruit of *A. triloba* has the greatest commercial potential of the *Asimina* genus due to the large size and usually pleasing flavor.

B. Morphology and Anatomy

Pawpaw is a moderately small, deciduous tree or shrub that flourishes in the deep, rich fertile soils of river-bottom lands of the forest understory (Kral 1960). Trees may attain 5 to 10 m in height and are usually found in patches, due to root suckering (Kral 1960; Layne 1996). In sunny locations, trees typically assume a pyramidal habit, with a straight trunk and lush, dark-green, long, drooping leaves. Leaves occur alternately, are obovate-oblong in shape, glabrous, with a cuneate base, acute midrib, and may be 15 to 30 cm long and 10 to 15 cm wide. Vegetative and flower buds occur at different nodes on the stem, the flower buds being basipetal. Vegetative buds are narrow and pointed, and the flower buds are round and covered with a dark-brown pubescence.

The dark maroon-colored flowers of the pawpaw are hypogynous and strongly protogynous (Willson and Schemske 1980). Flowers are pendant on nodding, with sturdy pubescent peduncles up to 4 cm long (Kral 1960). The mature flowers have an outer and inner whorl of three, maroon-colored, three-lobed petals (Fig. 7.1). The inner petals are smaller and fleshier, with a nectary band at the base. The flower has a fetid aroma. Flowers have a globular androecium and a gynoecium usually

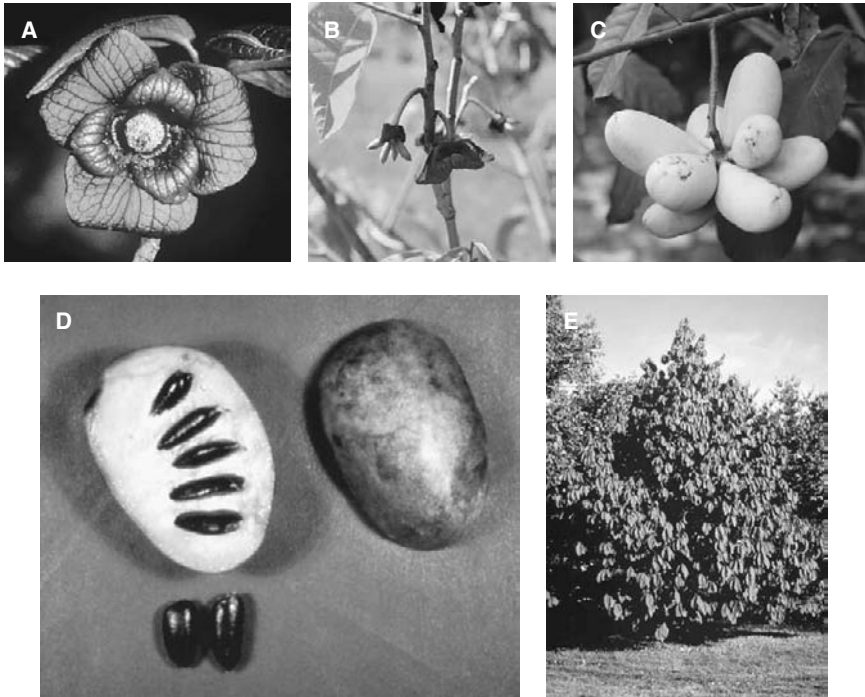

Fig. 7.1. (A) Mature flower with an outer and inner whorl of three maroon-colored, three-lobed petals. (B) A mature pawpaw flower and developing cluster from an earlier flower. (C) Pawpaw cluster with ripe fruit. (D) A fruit cut open lengthwise and seeds removed. (E) A pawpaw tree showing pyramidal growth habit in full sun.

composed of three to seven carpels resulting in three to seven fruited clusters (Kral 1960); up to nine-fruited clusters have been noted (Fig 7.1). Flowers emerge before leaves in spring (about April in Kentucky). Pawpaw blossoms occur singly on the previous year's wood, reaching up to 5 cm in diameter.

Pawpaw's custard-like fruits are berries (Dirr 1990). The fruit have an oblong shape, green skin, a pleasant but strong aroma when ripe, and intense flavor (Peterson 1991; Shiota 1991; Layne 1996). However, flavor varies among cultivars, with some fruit displaying complex flavor profiles. Fruit from poor-quality pawpaw genotypes can have a mushy texture, lack sweetness, and have an overly rich flavor with turpentine or bittersweet aftertaste; many wild pawpaws have poor eating quality. Fruit from superior genotypes have a firm texture, a delicate blend of flavors, are rich but not cloying, and have no bitter aftertaste. The flavor of a pawpaw fruit can intensify when it over-ripens, as with banana, result-

ing in pulp that is excellent for use in cooking. The fruit are oblong-cylindrical, typically 3 to 15 cm long, 3 to 10 cm wide and weigh from 100 to 1000 g. They may be borne singly or in clusters that resemble the “hands” of a banana plant. In the fruit, there are two rows of seeds (12 to 20 seeds) that are brown and bean shaped and that may be up to 3 cm long. The seed and skin of the fruit are generally not eaten. The endosperm of the seeds contains alkaloids that are emetic (Vines 1960) and if chewed may impair mammalian digestion. Pawpaw fruit allergies have been reported in some people (Barber 1905). Seed lipid profiles include octanoate and positional monoene fatty acid isomers (Wood and Peterson 1999). In the wild, the primary consumers and seed dispersers are raccoons [*Procyon lotor* (L.) Elliot], red foxes [*Vulpes fulvus* (Desmarest) Merriam], and opossums (*Didelphis virginiana* kerr) that eat fruit that has fallen to the ground. Deer (*Odocoileus virginianus*) will also eat whole pawpaw fruit when it is available and they may also disperse seed.

The pawpaw fruit has a high nutritional value (Table 7.1) (Peterson et al. 1982; Jones and Layne 1997). Pawpaw and banana are similar in dietary fiber content and overall nutritive composition. Pawpaw has three times as much vitamin C as apple, twice as much as banana, and one third as much as orange. Pawpaw has six times as much riboflavin as apple, and twice as much as orange. Niacin content of pawpaw is twice as high as banana, 14 times higher than apple, and four times higher than orange. Pawpaw and banana are both high in potassium, having about twice as much as orange and three times as much as apple. Pawpaw has one and a half times as much calcium as orange, and about 10 times as much as banana or apple. Pawpaw has two to seven times as much phosphorus, four to 20 times as much magnesium, 20 to 70 times as much iron, five to 20 times as much zinc, five to 12 times as much copper, and 16 to 100 times as much manganese, as do banana, apple, or orange. Pawpaw exceeds apple in all of the essential amino acids, and exceeds or equals banana and orange for some. Pawpaw has 32% saturated, 40% monounsaturated, and 28% polyunsaturated fatty acids as compared to banana, which has 52% saturated, 15% monounsaturated, and 34% polyunsaturated fatty acids. Pawpaw is an excellent food source.

C. Genetic Resources

Efforts to domesticate the pawpaw began early in the 20th century (Zimmerman 1941; Peterson 1991). In 1916, a contest to find the best pawpaw was sponsored by the American Genetics Association. This contest generated much interest and the sponsors thought that with time and “intelligent breeding” commercial-quality varieties could be developed

Table 7.1. Nutritional comparison of pawpaw with other fruits.^z

Composition	Units	Pawpaw	Banana	Apple	Orange
Proximal analysis					
Food Energy	cal	80	92	59	47
Protein	g	1.2	1.03	0.19	0.94
Total Fat	g	1.2	0.48	0.36	0.12
Carbohydrate	g	18.8	23.4	15.25	11.75
Dietary Fiber	g	2.6	2.4	2.7	2.4
Vitamins					
Vitamin A	RE ^y	8.6	8	5	21
Vitamin A	IU ^x	87	81	53	205
Vitamin C	mg	18.3	9.1	5.7	53.2
Thiamin	mg	0.01	0.045	0.017	0.087
Riboflavin	mg	0.09	0.1	0.014	0.04
Niacin	mg	1.1	0.54	0.077	0.282
Minerals					
Potassium	mg	345	396	115	181
Calcium	mg	63	6	7	40
Phosphorus	mg	47	20	7	14
Magnesium	mg	113	29	5	10
Iron	mg	7	0.31	0.18	0.1
Zinc	mg	0.9	0.16	0.04	0.07
Copper	mg	0.5	0.104	0.041	0.045
Manganese	mg	2.6	0.152	0.045	0.025
Essential amino acids					
Histidine	mg	21	81	3	18
Isoleucine	mg	70	33	8	25
Leucine	mg	81	71	12	23
Lysine	mg	60	48	12	47
Methionine	mg	15	11	2	20
Cystine	mg	4	17	3	10
Phenylalanine	mg	51	38	5	31
Tyrosine	mg	25	24	4	16
Threonine	mg	46	34	7	15
Tryptophan	mg	9	12	2	9
Valine	mg	58	47	9	40

^zDerived from Peterson et al. (1982) and Jones and Layne (1997). Mean value per 100 grams edible portion. Pawpaw analysis was done on pulp with skin, although the skin is not considered edible. Probably much of the dietary fiber, and possibly some of the fat, would be thrown away with the skin.

^yRetinol Equivalents—these units are used in National Research Council Recommended Dietary Allowances table (1989).

^xInternational Units.

and an industry begun (Popenoe 1916, 1917; Peterson 2003). However, an industry did not develop. Pawpaw enthusiasts noted that the rapid perishability of pawpaw fruit was the major factor inhibiting commercialization.

Beginning in the 20th century, elite pawpaw selections from the wild were assembled in extensive collections by various enthusiasts and scientists, including Benjamin Buckman (Farmington, Illinois, circa 1900 to 1920), George Zimmerman (Linglestown, Pennsylvania, 1918 to 1941), and Orland White (Blandy Experimental Farm, Boyce, Virginia, 1926 to 1955) (Peterson 1986; Peterson 1991; Peterson 2003; Zimmerman 1941). From about 1900 to 1960, at least 56 clones of pawpaw were selected and named. Fewer than 20 of these selections remain, with many being lost from cultivation through neglect, abandonment of collections, and loss of records necessary for identification (Peterson 1991). Since 1960, additional pawpaw cultivars have been selected from the wild or developed as a result of breeding efforts of hobbyists. More than 40 clones are currently available (Table 7.2) (Jones et al. 1998). The loss of cultivars over the last century may have led to erosion in the genetic base of current

Table 7.2. Commercially available pawpaw cultivars.^z

Cultivar	Description
Adam's Secret	From Pennsylvania, large fruit, few seeds, skin remains green when ripe.
Blue Ridge	Selected in Kentucky by Johnny Johnson; has white-fleshed fruit.
Collins	Selected in Georgia.
Convis	Selected from Corwin Davis orchard. Large fruit size ^y , yellow flesh; ripens 1st week of Oct. in Michigan.
Davis	Selected from the wild in Michigan by Corwin Davis in 1959. Introduced in 1961 from Bellevue, Michigan. Medium size fruit, up to 12 cm long; green skin; yellow flesh; large seed; ripens 1st week of Oct. in Michigan; keeps well in cold storage.
Duckworth A	Low-chill cultivar selected in San Mateo, Florida by Eric Duckworth, seedling of Louisiana native parent; tree with pyramidal shape.
Duckworth B	Low-chill cultivar selected in San Mateo, Florida by Eric Duckworth, seedling of Louisiana native parent; grows no larger than a shrub.
Estil	Selected by Nettie Estil in Frankfort, Kentucky. Large fruit: smooth-textured flesh.
Ford Amend	Selected from wild seedling of unknown parentage by Ford Amend around 1950. Introduced from Portland, Oregon. Medium-size fruit and earlier than Sunflower; ripens late September in Oregon; greenish-yellow skin; orange flesh.

(continues)

Table 7.2. Commercially available pawpaw cultivars.²

Cultivar	Description
G-2	Selected from G. A. Zimmerman seed by John W. McKay, College Park, Maryland, in 1942.
Glaser	Selected by P. Glaser of Evansville, Indiana. Medium-size fruit.
IXL	Hybrid of Overleese and Davis; large fruit, yellow flesh; ripens 2nd week of Oct. in Michigan.
Jack's Jumbo	Selected in California from Corwin Davis seed; large fruit.
Kirsten	Hybrid seedling of Taytwo × Overleese; selected by Tom Mansell, Aliquippa, Pennsylvania.
LA Native	From LA, blooms late in Tennessee, small fruit, somewhat frost hardy.
Little Rosie	Selected by P. Glaser of Evansville, Indiana. Has small fruit. Reported to be an excellent pollinator.
Lynn's Favorite	Selected from Corwin Davis orchard. Yellow fleshed, large fruit; ripens 2nd week of Oct. in Michigan.
M-1	Selected from G-2 seed by John W. McKay, College Park, Maryland, in 1948.
Mango	Selected from the wild in Tifton, Georgia, by Major C. Collins in 1970. Vigorous growth.
Mary Foos Johnson	Selected from the wild in Kansas by Milo Gibson. Seedling donated to North Willamette Expt. Sta., Aurora, Oregon, by Mary Foos Johnson. Large fruit; yellow skin; butter-color flesh; few seeds; ripens first week of Oct. in Michigan.
Mason/WLW	Selected from the wild in Mason, Ohio, by Ernest J. Downing in 1938.
Middletown	Selected from the wild in Middletown, Ohio, by Ernest J. Downing in 1915. Small fruit size.
Mitchell	Selected from the wild in Jefferson Co., Illinois, by Joseph W. Hickman in 1979. Fruit: Medium fruit size, slightly yellow skin, golden flesh, few seeds.
NC-1	Hybrid seedling of Davis × Overleese; selected by R. Douglas Campbell, Ontario, Canada, in 1976. Large fruit; few seeds; yellow skin and flesh; thin skin; early ripening, 15 Sept. in Ontario and early Sept. in Kentucky.
Overleese	Selected from the wild in Rushville, Indiana, by W. B. Ward in 1950. Large fruit; few seeds; bears in clusters of three to five; ripens 1st week of Oct. in Michigan and early Sept. in Kentucky.
PA-Golden 1	Selected as seedling from seed originating from George Slate collection by John Gordon, Amherst, New York. Early cropping. Medium-size fruit, yellow skin, golden flesh; matures late August in Kentucky and mid-Sept. in New York.
PA-Golden 2	Selected as seedling from seed originating from George Slate collection by John Gordon, Amherst, New York. Fruit: yellow skin, golden flesh; matures mid-Sept. in New York.
PA-Golden 3	Selected as seedling from seed originating from George Slate collection by John Gordon, Amherst, New York. Fruit: yellow skin, golden flesh; matures mid-Sept. in New York.

Cultivar	Description
PA-Golden 4	Selected as seedling from seed originating from George Slate collection by John Gordon, Amherst, New York. Fruit: yellow skin, golden flesh; matures mid-Sept. in New York.
Prolific	Selected by Corwin Davis, Bellevue, Michigan, in mid-1980s. Large fruit; yellow flesh; ripens first week of Oct. in Michigan.
Rebecca's Gold	Selected from Corwin Davis seed, Bellevue, Michigan, by J. M. Riley in 1974. Medium-size fruit; kidney-shaped; yellow flesh.
Ruby Keenan	Medium-size fruit with excellent flavor.
SAA-Overleese	Selected from Overleese seed by John Gordon, Amherst, New York, in 1982. Large fruit; rounded shape; green skin; yellow flesh; few seeds; matures in mid-Oct. in New York.
SAA-Zimmerman	Selected as seedling from seed originating from G. A. Zimmerman collection by John Gordon, Amherst, New York, in 1982. Large fruit; yellow skin and flesh; few seeds.
Silver Creek	Selected from the wild in Millstedt, Illinois, by K. Schubert. Medium fruit size.
Sue	Selected in southern Indiana. Medium-size fruit, yellow flesh, skin yellow when ripe.
Sunflower	Selected from the wild in Chanute, Kansas, by Milo Gibson in 1970. Tree reported to be self-fertile. Large fruit; yellow skin; butter-color flesh; few seeds; ripens early to mid-Sept. in Kentucky and the first week of Oct. in Michigan.
Sunglo	Yellow skin, yellow flesh, large fruit; fruit ripens 1st week of Oct. in Michigan.
Sweet Alice	Selected from the wild in West Virginia by Homer Jacobs of the Holden Arboretum, Mentor, Ohio, in 1934.
Taylor	Selected from the wild in Eaton Rapids, Michigan, by Corwin Davis in 1968. Small fruit; bears up to seven fruit in a cluster; green skin; yellow flesh; ripens 1st week of Oct. in Michigan.
Taytwo	Selected from the wild in Eaton Rapids, Michigan, by Corwin Davis in 1968. Sometimes spelled Taytoo. Small fruit; light-green skin; yellow flesh; ripens 1st week of Oct. in Michigan.
Tollgate	Yellow fleshed, large fruit, fruit ripens 1st week of Oct. in Michigan.
Wells	Selected from the wild in Salem, Indiana, by David Wells in 1990. Small to medium-size fruit; green skin; orange flesh. Ripens mid to late Sept. in Kentucky.
White Wilson	Selected in Kentucky by Johnny Johnson; has white-fleshed fruit. Selected from the wild on Black Mountain, Harlan Co., Kentucky, by John V. Creech in 1985. Small fruit; yellow skin; golden flesh.
Zimmerman	Selected in New York from G. A. Zimmerman seed by George Slate.

²Descriptions derived from Layne (1997), Jones et al. (1998), and unpublished data of K. Pomper. Descriptions come from a wide variety of sources, and most of the cultivars have not been compared for performance side by side at one geographic site.

³Fruit size categories of small, medium, and large are <100 g, 100 to 150 g, and >150 g, respectively.

pawpaw cultivars (Huang et al. 1997). Urban encroachment and the resulting destruction of native pawpaw patches may also be leading to a reduction in genetic diversity in the wild.

In 1981, R. Neal Peterson and Harry Swartz began a long-term breeding project that aimed to develop improved pawpaw cultivars (Peterson 1986, 1991, 2003). A collection of about 1500 accessions of open-pollinated seedlings was assembled at the University of Maryland Experiment Stations at Queenstown and Keedysville, Maryland. The seed for this germplasm collection was obtained from pawpaw trees that remained at the sites of the historic collections of Buckman, Zimmerman, and the Blandy Experimental Farm, as well as those of Hershey (Downington, Pennsylvania), Allard (Arlington, Virginia), Ray Schlaans-tine (West Chester, Pennsylvania), and open-pollinated seed from some modern cultivars.

In 1993, the PPF and KSU embarked on a joint venture to test 10 commercially available pawpaw cultivars and 18 of PPF's advanced selections from the Maryland orchards in a Pawpaw Regional Variety Trial (PRVT) (Layne 1996; Pomper et al. 1999; Pomper et al. 2003d). From 1996 to 1999, 13 universities or private cooperators have established or have attempted to establish PRVT demonstration orchards (Wapello, Iowa; Frankfort and Princeton, Kentucky; Baton Rouge, Louisiana; Keedysville, Maryland; Jackson, Michigan; Lincoln, Nebraska.; Ithaca, New York; Raleigh, North Carolina; Piketon, Ohio; Corvallis, Oregon; West Lafayette, Indiana; and Clemson, South Carolina). Named cultivars that were secured for testing include: 'Middletown' (selected in Ohio), 'Mitchell' (Illinois), 'NC-1' (Ontario, Canada), 'Overleese' (Indiana), 'PA-Golden' (New York), 'Sunflower' (Kansas), 'Taylor' (Michigan), 'Taytwo' (Michigan), 'Wells' (Indiana), and 'Wilson' (Kentucky). The "advanced selections" were chosen based on superior horticultural traits including fruit size and taste, flesh-to-seed ratio, resistance to pests and diseases, and overall productivity on a year-to-year basis. Regional recommendations have not yet been made because more years of performance evaluation are needed.

In 1994, KSU was designated as a satellite repository for *Asimina* preservation in the U.S. Department of Agriculture (USDA), National Plant Germplasm System (NPGS). As a result, germplasm evaluation, preservation, and dissemination are a high priority. The repository orchards currently contain over 1700 accessions collected from the wild in 17 states and more than 40 cultivars. One of the goals of the repository is to assess levels of genetic diversity in native populations, in the repository collection, and in commercially available cultivars. Another goal is to acquire unique germplasm to add to the collection that could be useful in future pawpaw breeding efforts.

D. Genetic Diversity

A range of molecular markers has been utilized in attempts to evaluate genetic diversity in pawpaw. Rogstad et al. (1991) used a minisatellite probe, M13, to determine the genetic variation in pawpaw collected in five states. Using data from one to 22 samples per population, these authors examined genetic variation at 16 sites both within and among populations. They determined that genetic variation is very low within populations, but moderate genetic variation occurred between populations. They concluded that the low level of genetic variation within populations might be due to clonality of pawpaw patches or inbreeding. However, inbreeding is considered to be rare in pawpaw's reproductive biology, because it is most likely self-incompatible and therefore may require out-crossing (Peterson 1991; Norman et al. 1992).

Huang et al. (1997) used isozymes to evaluate the genetic diversity represented in 32 pawpaw cultivars and advanced selections from the breeding program of R. Neal Peterson of the PPF. These authors determined that the isozyme marker variation in cultivated pawpaw is comparable to those of other long-lived temperate woody perennials of widespread geographic range with insect-pollinated outcrossing breeding systems, secondary asexual reproduction and animal-dispersed seed, thus having a higher level of genetic diversity than Rogstad et al. (1991) had reported (Table 7.3). Huang et al. (1997) acknowledged that the results may have been impacted by non-random selection because several of the trees studied may have been purposely selected by pawpaw enthusiasts for desirable characteristics such as large fruit size or good growth vigor.

Using isozymes, Huang et al. (1998) assessed the level of genetic diversity within wild collected pawpaw accessions at KSU and examined genetic diversity between pawpaw populations from different geographical locations. Isozymes were used to score 23 loci using 25 to 50 trees from each of nine populations. The level of genetic variation found in the KSU repository accessions was similar to that found in cultivated pawpaws (Huang et al. 1997).

Using 12 randomly amplified polymorphic DNA (RAPD) primers, Huang et al. (2000) identified 21 Mendelian markers and determined that the level of genetic diversity in six populations in the KSU repository collection was higher than determined for pawpaw by the same authors using isozymes (Huang et al. 1997, 1998). Huang et al. (2003) have also used additional RAPD markers for fingerprinting pawpaw cultivars. They reported similar levels of genetic diversity in cultivated pawpaw, in terms of Nei's genetic diversity constant (H_e) and percent polymorphic loci (P), to that reported for wild pawpaw populations by Huang et

Table 7.3. Comparison of genetic variation of pawpaw (*Asimina triloba*) with plant species having the same characteristics.

Species characteristics	Polymorphic locus (%) (P) ^y	Expected heterozygosity (H _e)
Life form: long-lived woody perennial ^z	64.7 ± 2.7	0.177 ± 0.010
Regional distribution: widespread ^z	58.9 ± 3.1	0.202 ± 0.015
Geographic range: temperate ^z	48.5 ± 1.5	0.146 ± 0.000
Breeding system: outcrossing-animal ^z	50.1 ± 2.0	0.167 ± 0.010
Seed dispersal: animal ingested ^z	45.7 ± 3.9	0.176 ± 0.019
Mode of reproduction: sexual and asexual ^z	43.8 ± 3.7	0.138 ± 0.016
Average of all characteristics ^z	51.2 ± 8.2	0.168 ± 0.023
California cherimoya ^x	73.3	0.330 ± 0.064
California and Spanish cherimoya ^w	44.8	0.183 ± 0.044
Cultivated pawpaw (Isozymes) ^v	44.4	0.166 ± 0.048
Pawpaw wild accessions (Isozymes) ^u	43.5	0.172 ± 0.013
Pawpaw wild accessions (RAPDs) ^t	64	0.249 ± 0.022
Cultivated pawpaw (RAPDs) ^s	—	0.285 ± 0.160
Cultivated pawpaw (ISSRs) ^r	80	0.358 ± 0.205

^zData from Hamrick and Godt, 1989 derived from isozyme studies +/- of standard deviation.

^yP is the percent polymorphic loci and H_e the mean gene heterozygosity, respectively.

^xCalculated by Huang et al. (1997) from the data published by Elstrand and Lee (1987) including three other monomorphic loci.

^wCalculated by Huang et al. (1997) from data published by Pascual et al. (1993) including 16 other monomorphic loci.

^vFrom Huang et al. (1997).

^uFrom Huang et al. (1998).

^tFrom Huang et al. (2000).

^sFrom Huang et al. (2003).

^rFrom Pomper et al. (2003b).

al. (2000). Pomper et al. (2003b) used 10 inter-simple sequence repeat (ISSR) markers, and determined estimates of genetic diversity (P=80% and H_e=0.358) that were higher than those based on isozymes (P=44% and H_e=0.172) for cultivated pawpaw, for RAPDs for wild pawpaw accessions (P=64% and H_e=0.249) and cultivated pawpaw (H_e=0.285) by Huang et al. (1997, 2000, 2003). These higher diversity values estimated for cultivated pawpaw by the ISSR marker system indicate that this marker methodology has a higher level of discrimination in evaluating genetic diversity in pawpaw than the isozyme or RAPD marker systems and/or that pawpaw has greater levels of genetic diversity than previously found.

IV. HORTICULTURE

A. Orchard Site Selection

Pawpaw orchards should be located at a site with characteristics that would be well suited for production of other temperate tree fruit species. The planting site should have good air drainage to reduce the risk of damage from late spring frosts that can damage both foliage and flowers. In mid-April in Kentucky, frost damage to flowers and leaves has occurred when early morning temperatures drop to -2.2°C or lower. During the first year in the ground, trees benefit from partial shading (Gould 1939). After the first year of growth, if trees are over about 45 cm in height, pawpaw trees are tolerant of full sun, and mature trees will bear large quantities of fruit in an open exposure if properly pollinated. The soil should be slightly acid (pH 5.4–7.0), deep, fertile, and well-drained. Bonney (2002) found that the soil pH ranged from neutral (7.05) to acidic (5.38) in eight wild patches in Kentucky. Pawpaw trees will not thrive if frequently flooded (Nash and Graves 1993) or if they are grown in heavy soil or waterlogged soil (Lagrange and Tramer 1985). Lagrange and Tramer (1985) reported that soils in wild pawpaw patches varied considerably in sand/silt/clay ratios, although clay contents were generally low. Pawpaw trees attained their greatest height in moist sites that were characterized by occasional flooding, but with soils with a high percentage of sand and good drainage. Pawpaws are sensitive to both flooding and drought (Nash and Graves 1993). Adequate soil moisture is critical during the first two years of establishment. Mulching pawpaws with straw helps to preserve soil moisture and enhances survival. Straw mulch also produces a soft cushion to prevent bruising of fruits that may fall to the ground before hand-harvesting.

B. Seedling Propagation

The pawpaw produces a relatively large seed averaging 2.8 ± 0.1 cm in length and 1.5 ± 0.1 cm in width (Geneve et al. 2003). The flat, spatulate seed has a dark-brown fibrous seed coat 16 cell layers thick (Corner 1948; Mohana Rao 1982). A ruminant endosperm occupies most of the seed cavity, characteristic of seeds from annonaceous species (Hayat 1963; Rizzini 1973). A small (1 mm long) embryo is located at the hilar end of the seed (Finneseth et al. 1998a).

Seed can be collected from fruit when the flesh is soft or over-ripe (Layne 1996; Hartmann et al. 2002). Pawpaw has moderately recalcitrant seed that does not tolerate desiccation, and it only has a relatively short period of viability (Bonner and Halls 1974; Finneseth et al. 1998b). Des-

iccation of pawpaw seed reduces viability by 50% when seed moisture content declines from 37 to 25% (Finneseth et al. 1998a). As little as 5 days under open air conditions can reduce the moisture content of pawpaw seeds to 5% and result in total loss of viability. Pawpaw seeds must be stored moist at chilling (5°C) temperature to retain viability in long-term storage (Finneseth et al. 1998b). The seed can be stored in moist peat moss in ziplock bags for 2 to 3 years at 5°C and maintain a high germination percentage (Finneseth et al. 1998a). In contrast, seeds stored moist at warm (25°C) temperature will lose viability in storage after 6 months to 1 year. Storing pawpaw seed below freezing (-15°C) will kill the embryo (Pomper et al. 2000).

Pawpaw seeds also display combinational (morphophysiological) dormancy (Nikolaeva 1977) requiring a period of chilling stratification to satisfy intermediate physiological endogenous dormancy followed by a moist warm period to satisfy morphological dormancy (Finneseth et al. 1998b; Geneve et al. 2003). Pawpaw seeds need to be stratified between 60 and 120 days and this range in stratification time may reflect inherent variation found in seed collected from different locations across pawpaw's wide geographic distribution (Dirr and Heuser 1987; Reich 1991; Young and Young 1992; Finneseth et al. 1998b). Using pawpaw seeds collected from six locations within Kentucky, Finneseth et al. (1998b) determined that approximately 7 weeks of chilling (5°C) stratification was required to reach 50% germination and that the greatest germination percentage (84 to 90%) occurred after approximately 100 days of stratification.

Once endogenous dormancy is relieved, pawpaw seeds still exhibit morphological dormancy. Seeds contain either a rudimentary or linear embryo that is not fully developed at the time the seed is mature and occupies less than one-half of the seed cavity (Nikolaeva 1977; Baskin and Baskin 1998; Finneseth et al. 1998a). When stratified seeds are moved to warm conditions, the cotyledons and radicle begin to grow at nearly comparable rates (Finneseth et al. 1998a). The cotyledons grow through two specialized channels that are distinct from the rest of the endosperm, while the hypocotyl and radicle emerge from the seed coat. The expanding cotyledons eventually extend to the tip of the seed. The cotyledons appear to act as haustorial structures transferring digested materials from the endosperm to the developing radicle (Finneseth et al. 1998a). The hypocotyl and radical continues to thicken to form a taproot. Forty-five days after sowing, the epicotyl emerges from the growing substrate. At this time the taproot averages (15 cm) in length and represents approximately 75% of the dry mass of the seedling. Seedling emergence is via a hypocotyl hook, but the seed coat containing the exhausted endosperm and the haustorial cotyledons may or may not

emerge from the growing medium. In either case, the cotyledons never emerge from the seed coat and are shed along with the remnants of the seed soon after the epicotyl begins to elongate. This type of seed germination where the cotyledons emerge above the soil but remain inside the seed is described as durian germination (Ng 1973). Pawpaw can be further subdivided into the blumeodendron type of durian germination (de Vogel 1980). Pawpaw is the first non-tropical species reported with durian germination (Baskin and Baskin 1998).

Pawpaw seedlings develop a strong taproot with a fragile root system, which can be easily damaged upon digging; therefore, most nurseries propagate trees in containers (Layne 1996; Pomper et al. 2003c). Desiccation of field sown seed will greatly reduce germination rates. Recent studies have developed recommendations (e.g., potting substrate type, fertilization requirements, container size, shading, etc.) for successful container production of pawpaw (Layne 1996; Finneseth et al. 1998a; Jones et al. 1998; Pomper et al. 2002a). A well-aerated potting substrate with a high sphagnum peat moss component (>75% by volume), cation exchange capacity, and water-holding capacity can be used effectively in container production (Pomper et al. 2002b). Tall containers should be used to accommodate the developing taproot of seedlings (Pomper et al. 2003c). The slow-release fertilizer Osmocote 14-14-14 (14N-6.1P-11.6K) incorporated into Pro-Mix BX potting substrate can be used effectively as the sole fertilizer source at a treatment rate of 2.22 kg m^{-3} in containerized pawpaw production (Pomper et al. 2002c). It can also be used at a lower rate of 0.81 kg m^{-3} when supplemented with weekly applications of 500 mg L^{-1} of Peters 20-20-20 (20N-8.78P-16.6K) liquid-feed fertilizer (Pomper et al. 2002c). If pawpaw seedlings are grown for longer than 4 months with Osmocote 14-14-14 (14N-6.1P-11.6K) as the sole fertilizer source in the potting substrate Pro-Mix BX, seedlings may display micronutrient deficiency symptoms. Thus, if pawpaw seedlings are to be grown in containers with Pro-MixBX or similar peat-based substrate for longer than four months, plants should receive a one-time application of soluble trace element mix (S.T.E.M.; Scotts Co., Marysville, Ohio) at a rate of 600 mg L^{-1} about 3 months after sowing. Pawpaw seedlings grown for longer than 4 months in the potting substrate Pro-MixBX may also develop calcium deficiency symptoms. One or more applications of calcium nitrate at a rate of 500 mg L^{-1} should also be provided to pawpaw seedlings at 3 months after sowing to avoid the development of calcium deficiency symptoms in plants. Bottom heating (32°C) of container-grown pawpaw seedlings results in greater lateral and total root dry weight (DW) than in seedlings grown at ambient temperature (24°C), which could increase the rate of establishment of seedlings in the

field (Pomper et al. 2002b). Bottom heating of container-grown pawpaw seedlings could decrease both the time to produce a saleable plant and the cost of heating greenhouses.

Pawpaw seedlings grown outdoors appear to be sensitive to high irradiances upon emergence from the soil, and benefit from partial shading for the first year of development (Gould 1939). Seedlings produced in greenhouses do not show sensitivity to high light levels, suggesting that seedlings grown outdoors may be sensitive to ultraviolet radiation (Peterson 1991). Pawpaws are often found in the shaded forest understory. Young and Yavitt (1987) reported that proximal pawpaw leaves, which developed before the overstory forest canopy closed, were 76% smaller than distal leaves that developed after canopy closure. Growth of containerized pawpaw seedlings was positively influenced by low to moderate shading (28% or 51%) outdoors and low shading (33%) in the greenhouse, in a manner typical of that reported for other shade-preferring plants (Pomper et al. 2002a). Shading increased leaf chlorophyll a and b concentrations for pawpaw seedlings grown outdoors, while it decreased average specific leaf DW (mg leaf DW cm⁻²). Low to moderate shading of pawpaw seedlings grown outdoors greatly increased whole plant biomass, indicating that commercial nurseries could possibly enhance production of containerized pawpaw seedlings using this shading regime outdoors. If plants are produced on a gravel container pad, higher levels of shading (>55%) that would also reduce air temperatures could be beneficial.

Pomper et al. (2002a) reported that application of Cu(OH)₂ to the interior of Rootainers (0.7 L) did not promote development of a more fibrous root system in pawpaw seedlings as reported for other tree species, based on failure of copper compound to increase lateral root dry weight production. In shaded plants, seedlings showed yellowing of leaves and reduced chlorophyll levels by the end of the experiment, suggesting that the plants were suffering from copper toxicity. However, the use of larger containers (8 L) with Cu(OH)₂ applied to the interior of containers does increase seedling lateral root dry weight.

C. Clonal Propagation

Propagation by rooting of stem cuttings is difficult in pawpaw and is not currently a viable commercial practice. Experiments using cuttings taken from seedlings of various ages showed a significant impact of juvenility on pawpaw rooting ability. In a systematic study using over 1200 stem cuttings taken from mature flowering pawpaw trees at 7-day intervals

from 17 June to 5 August only one cutting produced an adventitious root (Finneseth 1997). Cuttings taken from up to 2-month-old seedlings showed a high capacity to root. Cuttings treated with 10,000 mg L⁻¹ IBA rooted at 75% and averaged two roots per cutting (Geneve et al. 2003). Seedlings beyond 2 months showed a reduced capacity to form roots. Cuttings taken from 7-month-old seedlings rooted at less than 10% regardless of auxin treatment. Strategies to revert stock plants to a more juvenile state (i.e., tissue culture or mound layering) may be required before a reliable method for cutting propagation can be obtained.

Pawpaw is a naturally suckering species, readily forming adventitious shoots from roots. Propagation from root cuttings can be an alternative method for multiplication of difficult-to-root species such as pawpaw. Shoots derived adventitiously from roots retain a juvenile character and could serve as a source for stem cuttings or explants for tissue culture (Hackett 1985). Finneseth (1997) collected root cuttings from a wild patch in December in Kentucky, and found no shoots formed on root pieces that were less than 5 mm in diameter, while 56% of root pieces greater than 5 mm in diameter produced one or more shoots. On average, responding roots produced 2.5 buds and 1.1 elongating shoots. Buds were visible on root pieces 12 weeks after planting and shoot elongation was evident after 16 weeks. Stooling (mound layering) has been attempted in the field as a method to propagate pawpaw selections. In a factorial experiment with two levels of girdling (girdled or not) and three levels of IBA at 0, 3000, and 6000 mg L⁻¹ in lanolin paste, only two roots formed on one shoot out of 80 treated shoots (Pomper, unpubl. data).

Pawpaws are easily propagated by grafting and budding (e.g., whip-and-tongue, cleft, bark inlay, and chip budding) (Layne 1996). Winter collected, dormant budwood should have its chilling requirement fulfilled. The whip-and-tongue graft of a scion to an actively growing rootstock is used by several commercial nurseries to propagate pawpaw cultivars. Chip budding is most successful when the seedling rootstock is at least 0.5 cm diameter and actively growing. Bud take exceeding 90% can be obtained.

Currently, pawpaw cultivars with superior fruit characteristics are propagated by grafting and budding onto seedling rootstocks. Seedling rootstock research has used seed from open-pollinated half-sib trees at the Keedysville orchard at the Western Maryland Research and Education Center. Great variation in scion growth has been observed in orchards at KSU when these seedlings have been used as rootstock (Pomper et al. 2003d). Seedstock from various pawpaw genotypes are

currently being screened to identify seedling rootstocks that could result in improved pawpaw establishment rates and precocity.

Micropropagation of pawpaw has not been successful. In establishment studies, seedling nodal explants of pawpaw responded more favorably than apical sections for establishment (Finneseth 1997; Geneve et al. 2003). When nodal explants were treated with a range of benzyladenine (BA) concentrations (0, 5, 10, or 15 μM) on MS medium, fewer than 0.5 shoots developed per explant (Finneseth 1997). However, when seedling explants were treated with 1.0 μM thidiazuron (TDZ) plus 10 μM BA, all cultures produced over 1.0 shoot per culture. Explant establishment from seedling, mature, or rejuvenated sources was attempted using Murashige and Skoog (MS) medium (Murashige and Skoog 1962) supplemented with 10 μM BA plus 0.1 μM TDZ (Finneseth et al. 2000). A small number of mature explants survived and produced a limited number of shoot buds after 7 months in culture. However, these never stabilized and no mature cultures survived for more than 12 months in culture. Bellini et al. (2003) has reported difficulty in disinfecting pawpaw explants collected in the field, with cultures being lost to contamination by fungal and bacterial organisms.

Geneve et al. (2003) reported one pawpaw accession (A10-11) developed from rejuvenated explant sources showed continued growth and shoot production during subculturing. It has been maintained in culture for over 3 years. The ability for single stem explants from 3-year-old cultures of A10-11 to support shoot multiplication was investigated using 9.8 μM IBA plus 5.4 μM NAA in combination with BA (0 to 20 μM). Initial explants elongated but did not form additional shoots after 8 weeks in culture (J. Egilla, unpubl.). These were subcultured to the same medium and after 9 weeks cultures treated with 15 or 20 μM BA had the greatest number of shoots per culture and 15 μM BA had the most vigorous shoot growth. These data indicate that cultures of pawpaw can retain morphogenetic potential for a considerable time in culture. Preliminary experiments to root microcuttings of pawpaw have met with little success (S. T. Kester and R. L. Geneve, unpubl.). In these experiments, microshoots were developed from pawpaw cultures maintained for over 2 years. The original explants were shoots developed on root pieces from the A10-11 understock. Initial treatments placing explants on one-half strength MS salts medium containing IBA (0.49 to 4.9 μM) resulted in a small percentage (3.0%) of microcuttings developing one to two roots per cutting at the 4.9 μM IBA level. However, these rooted shoots did not thrive during the acclimatization stage and failed to develop further.

D. Orchard Establishment and Training

Poor establishment rates have been a problem in pawpaw orchards. Establishment and survival of trees in the PRVT has varied between 10% to 95% survival rates (Merwin et al. 2003; Pomper et al. 2003d; Postman et al. 2003). Generally, trees that are 45 to 90 cm at planting have a lower mortality rate than smaller trees. Tree establishment and survival was enhanced when trees were grown in copper treated 8 L containers (K. W. Pomper, unpubl. data).

Present recommendations for pawpaw plantings are 2.4 m within rows and 3.7 to 4.6 m between rows. During the first year of establishment, pawpaw trees show little growth and can have an early leaf drop the first fall. For the first two years, top growth is slow as the root system establishes itself, but thereafter it accelerates substantially given proper fertility and soil moisture. Row orientation should be north-south if possible.

Shading of pawpaw in the field the first year is recommended and can be accomplished by installing translucent double-walled polyethylene "tree-tubes" around each tree, securing them with bamboo stakes (Layne 1996). However, trees taller than 45 cm at planting do not require shading. During warm summer temperatures (>35°C), the tubes should be removed from the trees, otherwise foliage within tubes can become heat-stressed and desiccated. In New York, open mesh black plastic trunk guards provided adequate shade and protection for newly planted pawpaw trees, whereas translucent plastic tree-tubes caused heat stress and scorching of the young trees (Merwin et al. 2003).

Weed control is important to improve establishment, but there are no herbicides currently labeled for use on pawpaw. Mulching around trees with wood chip mulch (15 cm depth) or with straw can be an effective method of weed control for at least one year and possibly two. However, this is a labor-intensive method, and may be cost prohibitive. Weed mats or landscape fabric can control weeds for up to 3 years and assist in water conservation. Irrigation during establishment improves tree survival rates, but irrigation requirements of pawpaw have not been determined. Trickle irrigation with emitters that provided 3.8 L/hr with 2 emitters/tree for a total of about 945 L/tree per year has given good results.

Fertilization requirements have not been determined yet for bearing pawpaw trees. Trees fertigated with water-soluble fertilizer (20N-8.6P-16.6K) plus soluble trace elements once in May, June, and July during active growth in Kentucky have achieved 30 to 45 cm of shoot extension

each year. Excellent growth has been achieved with granular ammonium nitrate fertilizer (34-0-0) broadcast under pawpaw trees in early spring at 30–60 g N/tree applied before budbreak.

High-sodium conditions are potentially damaging to salt-sensitive fruit crops (Picchioni et al. 1990, 2000; Picchioni and Graham 2001). Thus, the intrinsic difficulties in field transplanting *A. triloba* (Callaway 1990) could be increased with sodium stress. For a southern *A. triloba* ecotype exposed to high-sodium conditions, the addition of gypsum improves field growth and survival rates, and increases fertilizer-N recovery during early orchard establishment (Picchioni et al. 2004).

Most pawpaw genotypes naturally develop a strong central leader. Branches can often develop sharp crotch angles in relation to the trunk. Trees should not be headed at planting and no pruning is required the first year. Pruning is conducted in late winter-early spring and consists of removing low branches to a height 60 to 90 cm on the trunk. Training to more horizontal scaffold limbs increases scaffold strength and reduces limb breakage which may occur under heavy crops.

E. Flowering, Fruit Set, and Yield

Flowers are strongly protogynous and are likely self-incompatible (Willson and Schemske 1980), although ‘Sunflower’ may be self-fruitful. Pollination is by flies (Diptera) and beetles (Nitidulidae), and possibly other nocturnal insects (Kral 1960; Faegri and van der Pijl 1971; Willson and Schemske 1980). Seedlings normally begin to flower when they reach a height of about 1.8 m, but may not set fruit; cropping is achieved at five to eight years. Grafted pawpaw trees often flower within 3 years after planting, but often fail to set fruit (Bratsch et al. 2003; Merwin et al. 2003; Pomper et al. 2003d). Failure of trees to set fruit could be due to inadequate pollination or inadequate canopy to support fruit development. Usually 5 to 6 years are required for grafted trees to begin production, although some cultivars such as ‘PA-Golden (#1)’ may produce crops 4 to 5 years after planting (Pomper et al. 2003d).

The normal bloom period for pawpaw may last from 3 to 4 weeks. Thus, harvest is often extended over a similar time frame. Each fruit cluster develops from an individual flower, and fruit within a cluster often ripen at different times (Fig. 7.1). In the spring of 2002, flowering, fruit set, fruit drop, and ripening characteristics were examined in six-year-old trees for ‘PA-Golden (#1)’, ‘Wilson’, and ‘Sunflower’ in Kentucky. The flowering period of individual trees for each cultivar extended from

April 15 until May 15, but 75% of all flowers bloomed from April 15 until May 1. Half of the trees of each cultivar examined in 2002 dropped about 50% of their clusters between May 8 and July 11. The average fruit set was 25% and this corresponded to 21, 9, and 7 fruit clusters per tree for 'PA-Golden', 'Wilson', and 'Sunflower', respectively. Fruit ripening periods for all cultivars reflected the long flowering periods of the cultivars. Harvest periods extended from August 20 to September 6 for 'PA-Golden', from August 22 to September 9 for 'Wilson', and from August 23 to September 21 for 'Sunflower'.

In cultivation, pawpaw yields per tree are often low (Peterson 1991). For the cultivars in the above 2002 study, yield averaged 6.4, 2.0, and 3.7 kg per tree for 'PA-Golden', 'Wilson', and 'Sunflower', respectively. In another study, yields per tree in the 7th year were: 4.4 kg for 'Sunflower', 2.3 kg for 8-20, and 2.2 kg for 'PA-Golden' (Pomper et al. 2003d). The tropical Annonaceae relatives of the pawpaw, such as cherimoya, sweetsop (sugar apple), soursop, and atemoya also have low yields, due to low rates of natural pollination (Peterson 1991; George et al. 1992; Pena et al. 1999). In commercial plantings, these tropical pawpaw relatives are hand pollinated to increase yields (Peterson 1991; Pena et al. 1999). Low rates (<5%) of fruit set have also been noted in wild pawpaw patches (Willson and Schemske 1980; Lagrange and Tramer 1985).

In the wild, pawpaw trees are usually found in the understory of hardwood forests. Low light levels in the understory likely result in reduced photosynthate partitioning to fruit that may cause low fruit set. Pawpaws in the wild often produce many root suckers that could potentially result in large clonal pawpaw patches contributing to poor fruit set because of self-incompatibility. Pollinator limitation can also cause low fruit set in wild pawpaw patches (Willson and Schemske 1980). Low pollinator activity is usually observed on cool, cloudy spring days. Since the pawpaw flowers are strongly protogynous (Willson and Schemske 1980), lack of pollen availability from other pawpaw genotypes could also limit pollination. Pawpaw growers report that placing carrion in buckets among pawpaw trees has resulted in improvements in fruit set (L. Sibley, pers. comm.) supporting the theory that pawpaw flowers may be pollinated by carrion flies. However, fruit set was 15 to 35% in KSU orchards in 1998 in nine-year-old seedlings where many pawpaw genotypes are in close proximity and flies are abundant due to nearby cattle. Pollinizer relationships between pawpaw cultivars need to be determined. Fruit set can be achieved by hand cross-pollination (Peterson 1997), and needs to be evaluated as a method to increase fruit set.

F. Fruit Ripening and Postharvest Physiology

The primary impediment to introduction of pawpaw into both fresh and processing markets is its perishability (Popenoe 1916, 1917; Peterson 1991). In order to facilitate the growth of a commercial pawpaw industry, several problems with harvest and postharvest handling of fruit will need to be resolved.

Pawpaw fruit ripening is characterized by an increase in soluble solids concentration (up to 20%), flesh softening, increased volatile production, and, in some genotypes, a decline in green color intensity (McGrath and Karahadian 1994). The volatile profile during ripening consists primarily of ethyl and methyl esters (Shiota 1991; McGrath and Karahadian 1994). Within 3 days after harvest, ethylene and respiratory climacteric peaks are clearly evident as pawpaw fruit rapidly soften (Archbold et al. 2003; Archbold and Pomper 2003; Koslanund 2003). Other members of the Annonaceae such as cherimoya, sweetsop (sugar apple), soursop, and atemoya, are also climacteric (Biale and Barcus 1970; Kosiyachinda and Young 1975; Paull 1982; Wills et al. 1984; Brown et al. 1988). Fruit of these tropical species exhibit similar climacteric maxima, although some have two respiratory peaks. Preliminary analyses conducted by Koslanund (2003) indicate that the decline in firmness of pawpaw fruit is due to the action of at least four enzymes: polygalacturonase, cellulase, pectin methylesterase, and endo- β -mannanase.

Color change is generally not a reliable indicator of pawpaw fruit ripeness. Although a decline in green color intensity during pawpaw ripening has been reported by McGrath and Karahadian (1994), we have found that it is not consistent among genotypes, occurs later in ripening if at all, and is not easy to identify visually. A common practice to determine maturity is to touch each fruit to determine if it is ready to harvest; ripe softening pawpaw fruit yield to slight pressure, as ripe peaches do, and can be picked easily with a gentle tug. Thus, fruit are harvested when they have already begun ripening and have lost some firmness. This is labor intensive and may result in slight bruising injury, perhaps leading to off-flavors (Peterson 1991). Also, a natural abscission zone forms where the fruit attaches to the peduncle when fruit ripen. "Wiggling" the fruit can determine how well this abscission zone has formed. Ripening fruit also give off a strong aroma. Fruit on a single tree do not ripen within close proximity in time to one another. An extended harvest period of two weeks or longer from an individual tree is not uncommon. The protracted harvest may be due in part to the staggered bloom period in the spring, but it is not known if the bloom to harvest period is the same for all fruit on a tree. Although each fruit

cluster develops from an individual flower, fruit within a cluster often ripen at different times. Currently, multiple harvests from one tree are conducted to obtain high-quality fruit. Cultivar variation in harvest period also exists. Because of the lack of easily identifiable ripening traits, it is difficult to determine fruit maturity except by individual “feel” or to determine softening. Softer fruit needs to be marketed immediately, while firmer fruit should be held in cold storage at 4°C.

Pawpaw fruit soften rapidly at room temperature after harvest. McGrath and Karahadian (1994) and Layne (1996) indicated a 2- to 3-day shelf life, although fruit that are just beginning to soften have a 5- to 7-day shelf life (Archbold et al. 2003) at room temperature. However, we have observed that pawpaw fruit can be stored for 1 month at 4°C with little change in fruit firmness; fruit then ripen upon removal to ambient temperature. The optimum temperature and duration for holding the fruit needs to be determined. Immature fruit does not ripen, even if treated with ethephon at 1000 mg L⁻¹. Controlled or modified atmosphere storage has not been evaluated. Fruit packaging needs to be developed to minimize bruising. Because fruit is non-uniform in size and shape, packing for shipping presents some unique challenges.

G. Medicinal and Pesticidal Uses

Annonaceous acetogenins have been extracted from pawpaw twigs and have potential as medications and pesticides (Zhao et al. 1994; Johnson et al. 1996; McLaughlin 1997; McCage et al. 2002). About 250 of these compounds have been isolated and characterized (McLaughlin 1997). Three compounds—bullatacin, bulletin, and bullanin—have high potencies against human solid tumor cell lines in vitro (Zhao et al. 1994). Several acetogenins have been patented for pesticidal use (McLaughlin 1997) and as anti-tumor agents (Zhao et al. 1994; McLaughlin 1997). Another patented product made from annonaceous acetogenins is a head lice remover shampoo developed by Jerry McLaughlin of Nature’s Sunshine Products [Spanish Fork, Utah; patents 4,721,727, 4,855,319, and 09/213,164 (pending); United States Patent and Trademark Office, www.uspto.gov] (McCage et al. 2002). Botanically-derived pesticides that are environmentally compatible and biologically degradable may be obtained from pawpaw (Ratnayake et al. 1993). Pests are less likely to develop resistance to botanically-derived pesticides, as they often have a larger pesticidal spectrum (Arnason et al. 1989). Asimicin, extracted from pawpaw, has been shown to have significant pesticidal activity against mosquito larvae (*Aedes aegypti* L.), blowfly larvae (*Colliphora vicina* Meig), two-spotted spider mite (*Tetranychus urticae* Koch),

striped cucumber beetle (*Acalymma vittatum* F.), melon aphid (*Aphis gossypii* Glover), Mexican bean beetle (*Epilachna varivestis* Mulsant), and a free-living nematode [*Caenorhabditis elegans* (Maupas) Dougherty] (Alkofahi et al. 1989).

A market exists for biomass produced by growers to supply annona-ceous acetogenins for the production of pawpaw products such as head lice remover shampoo. Acetogenin concentration varies monthly in pawpaw tree tissues, being highest in the spring and summer months (Johnson et al. 1996). However, pawpaw twigs can be harvested, dried, ground, and then stored for later extraction (Johnson et al. 1996).

H. Disease and Pest Management

Pawpaws have few disease problems. Pawpaw leaves can exhibit leaf spot, principally a complex of *Mycocentrospora aiminae*, *Rhopaloconidium asiminae* Ellis & Morg., and *Phyllosticta asiminae* Ellis & Kellerm (Farr et al. 1989; Peterson 1991) and some trees in the PRVT planting in Frankfort, Kentucky have exhibited signs of these foliar diseases. The pawpaw peduncle borer (*Talponia plummeriana* Busck) is a small moth larva, about 5 mm long, that burrows into the fleshy tissues of the flower, causing the flower to wither and drop (Heinrich 1926; MacKay 1959; Peterson 1991). Signs of the pawpaw peduncle borer have been observed in pawpaw orchards in Maryland (R. N. Peterson, pers. commun.), but not in Kentucky. The zebra swallowtail butterfly (*Eurytides marcellus*), whose larvae feed exclusively on young pawpaw foliage, will damage leaves, but this damage has been negligible at the PRVT plantings. The larvae of the leafroller (*Choristoneura parallela* Robinson) may damage flowers and leaves (Norman et al. 1992). Deer will not generally eat the leaves or twigs, but they will eat fruit that has dropped on the ground. Male deer may rub trees with their antlers breaking branches. Japanese beetles (*Popillia japonica* Newman) can damage young leaves on pawpaw trees.

I. Tree Decline

Pawpaw trees usually survive for 20 years or more; however, tree decline may be a problem in some pawpaw orchards. About 1% of trees in the PPF orchard at Queenstown, Maryland die annually from an unidentified decline. Grafted pawpaw trees do not survive as long as seedling trees, suggesting rootstock/scion incompatibility could result in tree decline and death (G. Reighard, Clemson University, pers. commun.).

Rootstock produced from seed from the same scion may be more compatible and promote long-term survival of grafted trees.

Vascular wilt-like symptoms have been observed in the spring after pawpaw trees leafed out in orchards in Oregon (Postman et al. 2003), North Carolina (M. Parker, North Carolina State University, pers. commun.), and Maryland (N. Peterson, pers. commun.). As transpiration demand increased with warmer and drier weather, severely affected trees collapsed and died. Moderately affected trees became chlorotic with stunted new growth. Blue and black vascular discoloration was observed beneath the bark of declining trees along the lower parts of the main stem, particularly at and above the graft unions. This symptom has been described as “blue-stain.” A canker-like bark splitting was also observed near the base of many declining trees, with smaller cankers on upper scaffold branches. Several species of fungi in the genera *Ceratocystis* and *Leptographium* have been associated with “blue-stain” in conifer timber, and a few species are associated with tree diseases. In most cases, spread of these fungi has been attributed to assorted bark beetles or other insects (Sohlheim and Safranyik 1997; Jacobs et al. 2000; Jacobs and Wingfield 2001). Blue discoloration beneath the bark of pawpaw trees seems to be a common response of this host to injury and may be associated with more than one disease or disorder.

A PRVT that was established at the USDA-NCGR in Corvallis, Oregon, in the fall of 1995 has had difficulties with high tree mortality. Postman et al. (2003) reported that two years after planting, 13% of trees had either failed to establish or had died after an initial healthy start. By July 1999, 25% of grafted trees had died due to a vascular wilt-like disease, and 2 years later mortality exceeded 50%. Seedling guard trees were unaffected until July 2000, when six guard trees of 76 died and 10 more were declining. By July 2001, 14 guard trees were dead. No fungi were consistently isolated from declining trees. A number of bacteria were isolated from infected trees, but no specific pathogen has been confirmed as the causal agent. Polymerase chain reaction (PCR) tests for phytoplasmas and for the bacterium *Xylella fastidiosa* were also negative. Research is ongoing to determine if a bacterial pathogen was the cause of the pawpaw decline. Despite the vascular wilt-like disease in this plot, healthy, producing pawpaw trees have been growing for more than 20 years at several gardens in Oregon’s Willamette Valley (J. Postman, pers. commun.). The demise of the NCGR Corvallis PRVT may help to identify sources of resistance to this as yet unidentified disease. Trees in the PPF orchard at Queenstown, Maryland have exhibited similar disease symptoms to those in Oregon, but as stated previously only about 1% die annually (N. Peterson, pers. commun.).

J. Marketing and Consumer Acceptance

The taste and aroma of overripe pawpaw fruit can be very strong and possibly objectionable to some consumers. Pawpaw fruit can also be seedy. Although there are no seedless pawpaw fruit currently available, superior genotypes have about 5 to 10% seed on a fresh weight basis. Ripe pawpaw fruit are similar in appearance to mango and papaya fruit, and if handling avoids bruising, have a similar fresh market appeal.

Pawpaw fruit have significant processing potential but commercial pulp extraction methods have not been examined. Langworthy and Holmes (1917) observed that the pawpaw fruit was little known outside of regions where it is found, but deemed it worthy of further study because of its distinctive flavor. In a consumer acceptance study conducted at a 1999 pawpaw field day (Templeton et al. 2003), pawpaw ice cream was the best-received item (55% of tasters liked it extremely), followed by pawpaw cake with lemon icing, liked extremely by 45%. The pawpaw/grape juice drink was liked extremely by 31% of participants. Plain pawpaw butter was liked extremely by 26% of tasters; pawpaw butter prepared with lemon and grape juice was liked extremely by 11%, while the version prepared with orange and lemon was liked extremely by only 8%. The custard prepared from ripe, mild-flavored fruit was liked extremely by 42% of tasters, while the custard prepared from mixed under-ripe, over-ripe, and bruised fruit was liked extremely by only 16%. Overall, the positive acceptance of pawpaw products by tasters demonstrates the potential of commercial processing ventures.

Wiese and Duffrin (2003) investigated the sensory properties of plain shortened cake using pawpaw fruit puree as a partial replacement for fat in the food formulation. The influence on the color, texture, and tenderness appeared to influence the preference ratings for the category of overall acceptability. Participants preferred the no pawpaw pulp control and 25% samples to 50% and 75% of the fat replacement with pawpaw fruit puree. The 50% and 75% replacement of fat with pawpaw fruit puree in the cake samples resulted in a reduced preference for the categories of color, texture, tenderness, and overall acceptability. In examining a muffin formulation, Duffrin et al. (2001) also found that some fat is required in a food formulation along with pawpaw fruit puree for a desirable product. The custard-like texture of the pawpaw fruit, its nutrient composition, and acceptance by tasters make it an excellent candidate as at least a partial fat-reducing agent in baked goods. Jones and Layne (1997) noted that most dessert recipes requiring banana could have equal part substitution with pawpaw puree and be very acceptable.

V. FUTURE PROSPECTS

The unique qualities of the fruit, ornamental value of the tree, and the natural compounds in the leaf and bark suggest that pawpaw has great potential as a new crop. However, there are many challenges, including developing a grower base, improving orchard establishment rates, root-stock development, improving clonal propagation methods, new cultivar development, increasing yields, postharvest handling of fruit, and developing an overall marketing strategy.

LITERATURE CITED

- Alkofahi, A., J. K. Rupprecht, J. E. Anderson, J. L. McLaughlin, K. L. Mikolajczak, and B. A. Scott. 1989. p. 25–43. In: J. T. Arnason, B. J. R. Philogene, and P. Morand (eds.), *Insecticides of plant origin: Search for new pesticides from higher plants*. Am. Chem. Soc. Washington, D.C.
- Archbold, D. D., R. Kosnalund, and K. W. Pomper. 2003. Ripening and postharvest storage of pawpaw. *HortTechnology* 13:439–441.
- Archbold, D. D., and K. W. Pomper. 2003. Ripening pawpaw fruit exhibit respiratory and ethylene climacterics. *Post. Biol. Tech.* 30:99–103.
- Arnason, J. T., B. J. R. Philogene, and P. Morand. 1989. Preface. p. ix–x. In: *Insecticides of plant origin*. J. T. Arnason, B. J. R. Philogene, and P. Morand (eds.) Am. Chem. Soc. Washington, DC.
- Bailey, L. H. 1960. *The standard cyclopedia of horticulture*, Vol. I. Macmillan Co., New York.
- Barber, M. A. 1905. Poisoning due to papaw (*Asimina triloba*). *J. Am. Med. Assoc.* 45:2013–2014.
- Bartholomew, E. A. 1962. Possibilities of the pawpaw. *Northern Nut Growers Assn. Ann. Rep.* 53:71–74.
- Baskin, C. C., and J. M. Baskin. 1998. *Seeds. Ecology, biogeography, and evolution of dormancy and germination*. Academic Press, New York.
- Bellini, E., S. Nin, and M. Cocchi. 2003. The pawpaw research program at the horticulture department of the University of Florence. *HortTechnology* 13:455–457.
- Biale, J. B., and D. E. Barcus. 1970. Respiration patterns in tropical fruits of the Amazon basin. *Trop. Sci.* 12:93–104.
- Bonner, F. T., and L. K. Halls. 1974. *Asimina* Adans.—Pawpaw. [Seed production] *U.S. Dept. of Agr. Agr. Handb.* 450:238–239.
- Bonney, T. M. 2002. Development of a sampling strategy and random amplified polymorphic DNA (RAPD) protocol for genetic analysis of the North American pawpaw [*Asimina triloba* (L.) Dunal]. M.S. Thesis, Dept. Horticulture, Univ. Kentucky, Lexington.
- Bowden, W. M. 1948. Chromosome numbers in the *Annonaceae*. *Am. J. Bot.* 35:377–381.
- Bowden, W. M. 1949. Triploid mutants among diploid seedling populations of *Asimina triloba*. *Bul. Torrey Bot. Club* 76:1–6.
- Bratsch, A., R. Bellm, and D. Kniepkamp. 2003. Early growth characteristics of seven grafted varieties and non-grafted seedling pawpaw. *HortTechnology* 13:423–427.

- Brown, B. I., L. S. Wong, A. P. George, and R. J. Nissen. 1988. Comparative studies on the postharvest physiology of fruit from different species of *Annona* (custard apple). *J. Hort. Sci.* 63:521–528.
- Callaway, M. B. 1990. The pawpaw (*Asimina triloba*). Kentucky State Univ. Pub. CRS-HORT1-901T.
- Callaway, M. B. 1992. Current research for the commercial development of pawpaw [*Asimina triloba* (L.) Dunal]. *HortScience* 27:90, 191.
- Callaway, M. B. 1993. Pawpaw (*Asimina triloba*): A “tropical” fruit for temperate climates. p. 505–515. In: J. Janick and J. E. Simon (eds.), *New crops*. Wiley, New York.
- Conquist, A. 1981. *An integrated classification of flowering plants*. Columbia Univ. Press, New York.
- Corner, E. H. J. 1948. The Annonaceous seed and its four integuments. *New Phytol.* 48: 332–364.
- Damman, A. J. 1986. Effects of seasonal changes in leaf quality and abundance of natural enemies on the insect herbivores of pawpaw. Ph.D. Dissertation, Cornell Univ., Ithaca, N.Y.
- Darrow, G. M. 1975. Minor temperate fruits. p. 276–277. In: J. Janick and J. N. Moore (eds.), *Advances in fruit breeding*. Purdue Univ. Press, West Lafayette, IN.
- de Vogel, E. F. 1980. *Seedlings of dicotyledons*. Centre Agr. Pub. Doc. Wageningen, The Netherlands.
- Dirr, M. A. 1990. *Manual of woody landscape plants: their identification, ornamental characteristics, culture, propagation and uses*. 4th ed. Stipes Publ. Co., Champaign, IL.
- Dirr, M. A., and C. W. Heuser. 1987. *The reference manual of woody plant propagation: from seed to tissue culture*. Varsity Press, Athens, GA.
- Duffrin, M. W., D. H. Holben, and M. J. Bremner. 2001. Consumer acceptance of pawpaw (*Asimina triloba*) fruit puree as a fat-reducing agent in muffins, compared to muffins made with applesauce and fat. *Family Consumer Sciences Res. J.* 29:281–287.
- Ellstrand, N. C., and J. L. Lee. 1987. Cultivar identification of cherimoya (*Annona cherimola* Mill.) using isozyme markers. *Scientia Hort.* 32:25–31.
- Faegri, K., and L. van der Pijl. 1971. *The principles of pollination ecology*, p. 112–122. Pergamon, New York.
- Farr, D. F., G. F. Bills, G. P. Chamuris, and A. Y. Rossmoan. 1989. *Fungi on plants and plant products in the United States*. APS Press, St. Paul, Minn.
- Filson, J. 1784. *The discovery, settlement, and present state of Kentucke*. Originally published in Wilmington, Delaware. Republished in 1966 as part of the Great Americana Series, Readex Microprint Corp., Chester, VT.
- Finneseth, C. H. 1997. Propagation of the North American pawpaw [*Asimina triloba* (L.) Dunal]. M.S. Thesis, Dept. Horticulture, Univ. Kentucky, Lexington.
- Finneseth, C. H., D. R. Layne, and R. L. Geneve. 2000. Establishment of North American pawpaw [*Asimina triloba* (L.) Dunal] shoots in vitro from mature and juvenile explants. *Acta Hort.* 520:97–102.
- Finneseth, C. H., D. R. Layne, and R. L. Geneve. 1998a. Morphological development of the North American pawpaw [*Asimina triloba* (L.) Dunal] during germination and seedling emergence. *HortScience* 33:802–805.
- Finneseth, C. H., D. R. Layne, and R. L. Geneve. 1998b. Requirements for seed germination in North American pawpaw [*Asimina triloba* (L.) Dunal]. *Seed Sci. Technol.* 26: 471–480.
- Geneve, R. L., K. W. Pomper, S. T. Kester, J. N. Egilla, C. L. H. Finneseth, S. B. Crabtree, and D. R. Layne. 2003. Propagation of pawpaw—a review. *HortTechnology* 13:428–433.
- George, A. P., R. J. Nissen, and J. A. Campbell. 1992. Pollination and selection in *Annona* species (cherimoya, atemoya, and sugar apple). *Acta Hort.* 321:178–185.
- Gould, H. 1939. *The native pawpaw*. U.S. Dept. of Agr., Lfl. 179. Washington, D.C.

- Hackett, W. P. 1985. Juvenility, maturation, and rejuvenation in woody plants. *Hort. Rev.* 7:109–155.
- Hamrick, J. L., and M. J. W. Godt. 1989. Allozyme diversity in plant species, p. 43–63. In A. H. D. Brown, M. T. Clegg, A. L. Kahler, and B. S. Weir (eds.), *Plant population genetics, breeding and genetic resources*. Sinauer Associates, Sunderland, Mass.
- Haribal, M., and P. Feeny. 1998. Oviposition stimulant for the zebra swallowtail butterfly, *Eurytides marcellus*, from the foliage of pawpaw, *Asimina triloba*. *Chemecology* 8:99–110.
- Hartmann, H. T., D. E. Kester, F. T. Davies, Jr., and R. L. Geneve. 2002. *Plant propagation: Principles and practices*. 7th edition. Prentice Hall, Saddle River, NJ.
- Hayat, M. A. 1963. Morphology of seed germination and seedling in *Annona squamosa*. *Bot. Gaz.* 124:360–362.
- Heinrich, C. 1926. Revision of the North American moths of the subfamilies Laspeyresinae and Olethreutinae. U.S. Natl. Museum Bul. 132.
- Huang, H., D. R. Layne, and R. N. Peterson. 1997. Using isozyme polymorphisms for identifying and assessing genetic variation in cultivated pawpaw [*Asimina triloba* (L.) Dunal]. *J. Am. Soc. Hort. Sci.* 122:504–511.
- Huang, H., D. R. Layne, and D. E. Riemenschneider. 1998. Genetic diversity and geographic differentiation in pawpaw [*Asimina triloba* (L.) Dunal] populations from nine states as revealed by allozyme analysis. *J. Am. Soc. Hort. Sci.* 123:635–641.
- Huang, H., D. R. Layne, and T. L. Kubisiak. 2000. RAPD inheritance and diversity in pawpaw [*Asimina triloba* (L.) Dunal]. *J. Am. Soc. Hort. Sci.* 125:454–459.
- Huang, H., D. R. Layne, and T. L. Kubisiak. 2003. Molecular characterization of cultivated pawpaw [*Asimina triloba* (L.) Dunal] using RAPD markers. *J. Am. Soc. Hort. Sci.* 128: 85–93.
- Jacobs, K., M. J. Wingfield, and D. R. Bergdahl. 2000. New *Leptographium* species from Indonesia and eastern North America. *Mycoscience* 41:595–606.
- Jacobs, K., and M. J. Wingfield. 2001. *Leptographium* species: Tree pathogens, insect associates and agents of blue-stain. *Phytopathology* 91(6 supplement):S113.
- Johnson, H. A., J. Gordon, and J. L. McLaughlin. 1996. Monthly variations in biological activity of *Asimina triloba*. p. 609–614. In: J. Janick (ed.), *Progress in new crops*. ASHS Press, Arlington, VA.
- Jones, S. C., and D. R. Layne. 1997. Cooking with pawpaws. Kentucky State University Cooperative Extension Program, Bul. #PIB-001.
- Jones, S. C., R. N. Peterson, T. Turner, K. W. Pomper, and D. R. Layne. 1998. Pawpaw planting guide: Cultivars and nursery sources. Kentucky State Univ. Cooperative Extension Program, Bul. #PIB-002.
- Kosiyachinda, S., and R. E. Young. 1975. Ethylene production in relation to the initiation of respiratory climacteric in fruit. *Plant Cell Physiol.* 16:595–602.
- Koslanund, R. 2003. Ethylene production, fruit softening, and their manipulation during pawpaw ripening. Ph.D. Diss., Univ. Kentucky, Lexington.
- Kral, R. 1960. A revision of *Asimina* and *Deeringothamnus* (*Annonaceae*). *Brittonia* 12: 233–278.
- Lagrange, R. L., and E. J. Tramer. 1985. Geographic variation in size and reproductive success in the paw paw (*Asimina triloba*). *Ohio J. Sci.* 85:40–45.
- Langworthy, C. F., and A. D. Holmes. 1917. The American pawpaw and its food value. *J. Home Econ.* 9:39–45.
- Lawson, J. 1709. (Reprinted in 1967.) The natural history of Carolina. p. 111. In: H. T. Lefler (ed.), *A new voyage to Carolina*. Univ. North Carolina Press, Chapel Hill, NC.
- Layne, D. R. 1996. The pawpaw [*Asimina triloba* (L.) Dunal]: A new fruit crop for Kentucky and the United States. *HortScience* 31:777–784.

- Layne, D. R. 1997. Pawpaws. p. 403–404. In: Register of Fruit and Nut Varieties, Third Edition. ASHS Press, Alexandria, VA.
- Lewis, M., and W. Clark. 1806. (Reprinted in 1981.) In: B. DeVoto (ed.), The journals of Lewis and Clark. Houghton Mifflin Co., Boston.
- Little, J. A. 1905. A treatise on the pawpaw. O. G. Swindler, Clayton, IN.
- MacKay, J. W. 1959. Variat in papaw. Northern Nut Growers Assn. Ann. Rep. 66:53–55.
- McGrath, M. J., and C. Karahadian. 1994. Evaluation of physical, chemical, and sensory properties of pawpaw fruit (*Asimina triloba*) as indicators of ripeness. J. Agr. Food Chem. 42:968–974.
- McCage, C. M., S. M. Ward, C. A. Paling, D. A. Fisher, P. J. Flynn, and J. L. McLaughlin. 2002. Development of paw paw herbal shampoo for the removal of head lice. Phytomedicine 9:743–748.
- McLaughlin, J. L. 1997. Anticancer and pesticidal components of pawpaw (*Asimina triloba*). Ann. Rep. Northern Nut Growers Assoc. 88:97–106.
- Merwin, I. A., R. Byard, and K. W. Pomper. 2003. Survival, growth, and establishment of grafted pawpaws in upstate New York. HortTechnology 13:421–422.
- Mohana Rao, P. R. 1982. Seed and fruit anatomy in *Asimina triloba*, with a discussion of the affinities of Annonaceae. Bot. Jahrb. Syst. 103:47–57.
- Murashige, T., and F. Skoog. 1962. A revised medium for rapid growth and bioassays with tobacco tissue cultures. Physiol. Plant. 15:473–497.
- Nash, L. J., and W. R. Graves. 1993. Drought and flood stress effects on plant development and leaf water relations of five taxa of trees native to bottomland habitats. J. Am. Soc. Hort. Sci. 118:845–850.
- Ng, F. S. P. 1973. The fruits, seeds and seedlings of Malayan trees XII–XV. Malaysian For. 39:110–146.
- Nichols, T. J. and A. A. Alm. 1983. Root development of container-reared, nursery-grown, and naturally regenerated pine seedlings. Can. J. For. Res. 13:239–245.
- Nikolaeva, M. G. 1977. Factors affecting the seed dormancy pattern. p. 51–76. In: A. A. Khan (ed.), The physiology and biochemistry of seed dormancy and germination. North-Holland Publ. Co., Amsterdam.
- Norman, E. M., K. Rice, and S. Cochran. 1992. Reproductive biology of *Asimina parviflora* (Annonaceae). Bul. Torrey Bot. Club 119:1–5.
- Ourecky, D. K., and G. L. Slate. 1975. Evaluation system for papaw fruit. Northern Nut Growers Assoc. Ann. Rep. 65:57–58.
- Owens, L. (publisher). 1994. Hatfield, Ky., W. Va. Battle for tourist dollars: Key happenings in the Hatfield-McCoy feud. Lexington Herald-Leader 9 Oct. 1994. Sect. B6.
- Pascual, L., F. Perfectti, M. Gutierrez, and A. M. Vargas. 1993. Characterizing isozymes of Spanish cherimoya cultivars. HortScience 28:845–847.
- Paull, R. E. 1982. Postharvest variation in composition of soursop (*Annona muricata* L.) fruit in relation to respiration and ethylene production. J. Am. Soc. Hort. Sci. 107:582–585.
- Pena, J. E., A. Castineiras, R. Bartelt, and R. Duncan. 1999. Effect of pheromone for sap beetles (*Coleoptera: Nitidulidae*) on *Annona* spp. fruit set. Fla. Entomol. 82:475–480.
- Peterson, R. N., J. P. Cherry, and J. G. Simmons. 1982. Composition of pawpaw (*Asimina triloba*) fruit. Northern Nut Growers Assoc. Ann. Rep. 73:97–107.
- Peterson, R. N. 1986. Research on the pawpaw (*Asimina triloba*) at the University of Maryland. Northern Nut Growers Assoc. Ann. Rep. 77:73–78.
- Peterson, R. N. 1991. Pawpaw (*Asimina*). Acta Hort. 290:567–600.
- Peterson, R. N. 1997. How to hand-pollinate pawpaws. Fruit Gardener, Sept/Oct. p. 10–11.
- Peterson, R. N. 2003. Pawpaw variety development: a history and future prospects. HortTechnology 13:449–454.

- Picchioni, G. A., and C. J. Graham. 2001. Salinity, growth, and ion uptake selectivity of container-grown *Crataegus opaca*. *Scientia Hort.* 90:151–166.
- Picchioni, G. A., C. J. Graham, and A. L. Ulery. 2004. Gypsum effects on growth and macroelement uptake of field-grown *Asimina triloba* (Pawpaw) irrigated with low-saline, sodic water. *HortScience* 39(5):1104–1109.
- Picchioni, G. A., H. Karaca, L. Boyse, B. D. McCaslin, and E. A. Herrera. 2000. Salinity, boron, and irrigated pecan productivity along New Mexico's Rio Grande Basin. *J. Environ. Qual.* 29:955–963.
- Picchioni, G. A., S. Miyamoto, and J. B. Storey. 1990. Salt effects on growth and ion uptake of pistachio rootstocks. *J. Amer. Soc. Hort. Sci.* 115:647–653.
- Pickering, C. 1879. p. 881. In: *Chronological history of plants*. Little, Brown, and Co., Boston.
- Pomper, K. W., D. R. Layne, and R. N. Peterson. 1999. The pawpaw regional variety trial. p. 353–357. In: J. Janick (ed.), *Perspectives on new crops and new uses*. ASHS Press, Alexandria, VA.
- Pomper, K. W., S. C. Jones, and L. Barnes. 2000. The influence of low temperature storage on the germination rate of pawpaw [*Asimina triloba* (L.) Dunal]. *Northern Nut Growers Assoc. Ann. Rep.* 91:20–27.
- Pomper, K. W., D. R. Layne, and S. C. Jones. 2002a. Incident irradiance and cupric hydroxide container treatment effects on early growth and development of container-grown pawpaw seedlings. *J. Am. Soc. Hort. Sci.* 127:13–19.
- Pomper, K. W., D. R. Layne, S. C. Jones, and M. G. Kwantes. 2002b. Growth enhancement of container-grown pawpaw seedlings as influenced by media type, root-zone temperature, and fertilization regime. *HortScience* 37:329–333.
- Pomper, K. W., D. R. Layne, and E. B. Reed. 2002c. Determination of the optimal rate of slow-release fertilizer for enhanced growth of pawpaw seedlings in containers. *HortTechnology* 13:397–401.
- Pomper, K. W., and R. J. Barney. 2003a. Introduction to the second international pawpaw conference. *HortTechnology* 13:410–411.
- Pomper, K. W., S. B. Crabtree, S. P. Brown, S. C. Jones, T. M. Bonney, and D. R. Layne. 2003b. Assessment of genetic diversity of pawpaw varieties with inter-simple sequence repeat markers. *J. Am. Soc. Hort. Sci.* 128:521–525.
- Pomper, K. W., D. R. Layne, and S. C. Jones. 2003c. Container production of pawpaw seedlings. *HortTechnology* 13:434–438.
- Pomper, K. W., D. R. Layne, R. N. Peterson, and D. Wolfe. 2003d. The pawpaw regional variety trial: background and early data. *HortTechnology* 13:412–417.
- Popenoe, W. (ed.). 1916. Where are the best papaws? *J. Hered.* 7:291–296.
- Popenoe, W. (ed.). 1917. The best papaws. *J. Hered.* 8:21–33.
- Postman, J. D., K. E. Hummer, and K. W. Pomper. 2003. Vascular disease in Oregon regional pawpaw variety trial. *HortTechnology* 13:418–420.
- Ratnayake, S., J. K. Rupprecht, W. M. Potter, and J. L. McLaughlin. 1993. Evaluation of the pawpaw tree, *Asimina triloba* (Annonaceae), as a commercial source of the pesticidal annonaceous acetogenins. p. 644–648. In: J. Janick and J. E. Simon (eds.), *New crops*. Wiley, New York.
- Reich, L. 1991. *Uncommon fruits worthy of attention: a gardener's guide*. Addison-Wesley, New York.
- Rizzini, C. T. 1973. Dormancy in seeds of *Annona crassiflora* Mart. *J. Expt. Bot.* 24:177–183.
- Rogstad, S. H., K. Wolff, and B. A. Schaal. 1991. Geographical variation in *Asimina triloba* Dunal (Annonaceae) revealed by the M13 “DNA fingerprinting” probe. *Am. J. Bot.* 78:1391–1396.
- Shiota, H. 1991. Volatile components of pawpaw fruit (*Asimina triloba* Dunal). *J. Agr. Food Chem.* 39:1631–1635.

- Sohlheim, H., and L. Safranyik. 1997. Pathogenicity to sitka spruce of *Ceratocystis rubipenni* and *Leptographium abietinum*, blue-stain fungi associated with the spruce beetle. *Can. J. For. Res.* 27:1336–1341.
- Templeton, S. B., M. Marlette, K. W. Pomper, and S. C. Jones. 2003. Favorable taste ratings for several pawpaw products. *HortTechnology* 13:445–448.
- Thomson, P. H. 1974. The paw paw—brought up to date. p. 138–180. In: California Rare Fruit Growers Yearbook, Vol. 6. Calif. Rare Fruit Growers, Bonsall, CA.
- Vines, R. A. 1960. Trees, shrubs, and woody vines of the southwest. Univ. of Texas Press, Austin.
- Westwood, M. N. 1993. Temperate-zone pomology and culture, 3rd ed. Timber Press, Portland, OR.
- Wiese, T. D., and M. W. Duffrin. 2003. Effects of substituting pawpaw fruit puree for fat on the sensory properties of a plain shortened cake. *HortTechnology* 13:442–444 .
- Wills, R. B. H., A. Poi, H. Greenfield, and C. J. Rigney. 1984. Postharvest changes in fruit composition of *Annona atemoya* during ripening and effects of storage temperature and ripening. *HortScience* 19:96–97.
- Willson, M. F., and D. W. Schemske. 1980. Pollinator limitation, fruit production, and floral display in pawpaw (*Asimina triloba*). *Bul. Torrey Bot. Club* 107:401–408.
- Wood, R., and S. Peterson. 1999. Lipids of the pawpaw fruit: *Asimina triloba*. *Lipids* 34:1099–1106.
- Young, D. R., and J. B. Yavitt. 1987. Differences in leaf structure, chlorophyll, and nutrients for the understory tree *Asimina triloba*. *Am. J. Bot.* 74:1487–1491.
- Young, J. A., and C. G. Young. 1992. Seeds of woody plants in North America. Dioscorides Press, Portland, OR.
- Zhao, G., J. H. Ng, J. F. Kozlowski, D. L. Smith, and J. L. McLaughlin. 1994. Bullatin and bullanin: two novel, highly cytotoxic acetogenins from *Asimina triloba*. *Heterocycles* 38:1897–1908.
- Zimmerman, G. A. 1938. The papaw. Northern Nut Growers Assoc. Ann. Rep. 29:99–102.
- Zimmerman, G. A. 1941. Hybrids of the American pawpaw. *J. Hered.* 32:83–91.

Subject Index

Volume 31

A

Abscisic acid, mango fruit drop, 124–125
Abscission, mango, 113–155
Apple crop load, 233–292
Auxin, mango fruit drop, 118–120

C

Chestnut, 293–349
Cytokinins, mango fruit drop, 124

D

Dedication, Warrington, I.J., xi–xii

E

Ethylene, mango fruit drop, 120–122

F

Foliage plants, industry, 47–112

Fruit:

apple crop load, 233–292
chestnut, 293–349
mango drop, 113–155
pawpaw, 351–384

Fruit crops:

apple crop load, 233–292
mango fruit drop, 113–155
olive physiology, 157–231
pawpaw, 351–384

G

Gibberellins, mango fruit drop, 122–124
Growth substances, mango fruit drop,
113–155

I

Insects and mites, particle film control,
1–45

M

Mango, fruit drop, 113–155

N

Nut crops, chestnut, 293–349

O

Olive, physiology, 157–231
Ornamental plants, foliage industry,
47–112

P

Particle films, 1–45
Pawpaw, 351–384
Pest control, particle films, 1–45
Physiology:
apple crop load, 233–292
mango fruit drop, 113–155
olive, 157–231
particle films, 1–45
Polyamines, mango fruit drop, 125–127
Propagation, foliage plants, 47–112

S

Stress, olive: 207–217

Cumulative Subject Index (Volumes 1–31)

A

- Abscisic acid:**
chilling injury, 15:78–79
cold hardiness, 11:65
dormancy, 7:275–277
genetic regulation, 16:9–14; 20–21
lychee, 28:437–443
mango fruit drop, 31:124–125
mechanical stress, 17:20
rose senescence, 9:66
stress, 4:249–250
- Abscission:**
anatomy & histochemistry, 1:172–203
citrus, 15:145–182, 163–166
flower & petals, 3:104–107
mango fruit drop, 31:113–155
regulation, 7:415–416
rose, 9:63–64
- Acclimatization:**
foliage plants, 6:119–154
herbaceous plants, 6:379–395
micropropagation, 9:278–281, 316–317
- Actinidia*, 6:4–12
- Adzuki bean, genetics, 2:373
- Agapanthus*, 25:56–57
- Agaricus*, 6:85–118
- Agrobacterium tumefaciens*, 3:34
- Air pollution, 8:1–42
- Alkaloids, steroidal, 25:171–196
- Allium* phytonutrients, 28:156–159
- Almond:**
bloom delay, 15:100–101
in vitro culture, 9:313
postharvest technology & utilization,
20:267–311
- wild of Kazakhstan, 29:262–265
- Alocasia*, 8:46, 57, *see also* Aroids
- Alternate bearing:**
chemical thinning, 1:285–289
fruit crops, 4:128–173
pistachio, 3:387–388
- Aluminum:**
deficiency & toxicity symptoms in
fruits & nuts, 2:154
Ericaceae, 10:195–196
- Amarcrinum*, 25: 57
- Amaryllidaceae, growth, development,
flowering, 25:1–70
- Amaryllis*, 25:4–15
- Amorphophallus*, 8:46, 57, *see also*
Aroids
- Anatomy & morphology:**
apple flower & fruit, 10:273–308
apple tree, 12:265–305
asparagus, 12:71
cassava, 13:106–112
citrus, abscission, 15:147–156
embryogenesis, 1:4–21, 35–40
fig, 12:420–424
fruit abscission, 1:172–203
fruit storage, 1:314
ginseng, 9:198–201
grape flower, 13:315–337
grape seedlessness, 11:160–164
heliconia, 14:5–13
kiwifruit, 6:13–50
magnetic resonance imaging, 20:78–86,
225–266
orchid, 5:281–283
navel orange, 8:132–133

- Anatomy & morphology (*cont.*)
 pecan flower, 8:217–255
 petal senescence, 1:212–216
 pollution injury, 8:15
 red bayberry, 20:92–96
 waxes, 23:1–68
- Androgenesis, woody species,
 10:171–173
- Angiosperms, embryogenesis, 1:1–78
- Anthurium, *see also* Aroids, ornamental
 fertilization, 5:334–335
- Antitranspirants, 7:334
 cold hardiness, 11:65
- Apical meristem, cryopreservation,
 6:357–372
- Apple:
 alternate bearing, 4:136–137
 anatomy & morphology of flower &
 fruit, 10:273–309
 bioregulation, 10:309–401
 bitter pit, 11:289–355
 bloom delay, 15:102–104
 CA storage, 1:303–306
 crop load, 31:233–292
 chemical thinning, 1:270–300
 fertilization, 1:105
 fire blight control, 1:423–474
 flavor, 16:197–234
 flower induction, 4:174–203
 fruiting, 11:229–287
 fruit cracking & splitting, 19:217–262
 functional phytonutrients, 27:304
 germplasm acquisition & resources,
 29:1–61
 in vitro, 5:241–243; 9:319–321
 light, 2:240–248
 maturity indices, 13:407–432
 mealiness, 20:200
 nitrogen metabolism, 4:204–246
 replant disease, 2:3
 root distribution, 2:453–456
 scald, 27:227–267
 stock-scion relationships, 3:315–375
 summer pruning, 9:351–375
 tree morphology & anatomy,
 12:265–305
 vegetative growth, 11:229–287
 watercore, 6:189–251
 weight loss, 25:197–234
 wild of Kazakhstan, 29:63–303, 305–315
 yield, 1:397–424
- Apricot:
 bloom delay, 15:101–102
 CA storage, 1:309
 origin & dissemination, 22:225–266
 wild of Kazakhstan, 29:325–326
- Arabidopsis*:
 molecular biology of flowering,
 27:1–39, 41–77
- Aroids:
 edible, 8:43–99; 12:166–170
 ornamental, 10:1–33
- Arsenic, deficiency & toxicity symptoms
 in fruits & nuts, 2:154
- Artemisia, 19:319–371
- Artemisinin, 19:346–359
- Artichoke, CA storage, 1:349–350
- Asexual embryogenesis, 1:1–78;
 2:268–310; 3:214–314; 7:163–168,
 171–173, 176–177, 184, 185–187,
 187–188, 189; 10:153–181; 14:258–
 259, 337–339; 24:6–7; 26:105–110
- Asparagus:
 CA storage, 1:350–351
 fluid drilling of seed, 3:21
 postharvest biology, 12:69–155
- Auxin:
 abscission, citrus, 15:161, 168–176
 bloom delay, 15:114–115
 citrus abscission, 15:161, 168–176
 dormancy, 7:273–274
 flowering, 15:290–291, 315
 genetic regulation, 16:5–6, 14, 21–22
 geotropism, 15:246–267
 mango fruit drop, 31:118–120
 mechanical stress, 17:18–19
 petal senescence, 11:31
- Avocado:
 CA & MA, 22:135–141
 flowering, 8:257–289
 fruit development, 10:230–238
 fruit ripening, 10:238–259
 rootstocks, 17:381–429
- Azalea, fertilization, 5:335–337
- B**
- Babaco, in vitro culture, 7:178
- Bacteria:
 diseases of fig, 12:447–451
 ice nucleating, 7:210–212; 11:69–71
 pathogens of bean, 3:28–58
 tree short life, 2:46–47

- wilt of bean, 3:46–47
- Bacteriocides, fire blight, 1:450–459
- Bacteriophage, fire blight control, 1:449–450
- Banana:
- CA & MA, 22:141–146
 - CA storage, 1:311–312
 - fertilization, 1:105
 - in vitro culture, 7:178–180
- Banksia*, 22:1–25
- Barberry, wild of Kazakhstan, 29:332–336
- Bean:
- CA storage, 1:352–353
 - fluid drilling of seed, 3:21
 - resistance to bacterial pathogens, 3:28–58
- Bedding plants, fertilization, 1:99–100; 5:337–341
- Beet:
- CA storage, 1:353
 - fluid drilling of seed, 3:18–19
- Begonia (Rieger), fertilization, 1:104
- Biennial bearing. *See* Alternate bearing
- Bilberry, wild of Kazakhstan, 29:347–348
- Biochemistry, petal senescence, 11:15–43
- Bioreactor technology, 24:1–30
- Bioregulation, *see also* Growth substances
- apple & pear, 10:309–401
- Bird damage, 6:277–278
- Bitter pit in apple, 11:289–355
- Blackberry:
- harvesting, 16:282–298
 - wild of Kazakhstan, 29:345
- Black currant, bloom delay, 15:104
- Bloom delay, deciduous fruits, 15:97
- Blueberry:
- developmental physiology, 13:339–405
 - harvesting, 16:257–282
 - nutrition, 10:183–227
- Boron:
- deficiency & toxicity symptoms in fruits & nuts, 2:151–152
 - foliar application, 6:328
 - nutrition, 5:327–328
 - pine bark media, 9:119–122
- Botanic gardens, 15:1–62
- Bramble, harvesting, 16:282–298
- Branching, lateral:
- apple, 10:328–330
 - pear, 10:328–330
- Brassica* classification, 28:27–28
- Brassicaceae, in vitro, 5:232–235
- Breeding, *see* Genetics & breeding
- Broccoli, CA storage, 1:354–355
- Brussels sprouts, CA storage, 1:355
- Bulb crops, *see also* Tulip
- development, 25:1–70
 - flowering, 25:1–70
 - genetics & breeding, 18:119–123
 - growth, 25: 1–70
 - in vitro, 18:87–169
 - micropropagation, 18:89–113
 - root physiology, 14:57–88
 - virus elimination, 18:113–123
- C**
- CA storage. *see* Controlled-atmosphere storage
- Cabbage:
- CA storage, 1:355–359
 - fertilization, 1:117–118
- Cactus:
- crops, 18:291–320
 - grafting, 28:106–109
 - reproductive biology, 18:321–346
- Caladium*, *see* Aroids, ornamental
- Calciole, nutrition, 10:183–227
- Calcifuge, nutrition, 10:183–227
- Calcium:
- bitter pit, 11:289–355
 - cell wall, 5:203–205
 - container growing, 9:84–85
 - deficiency & toxicity symptoms in fruits & nuts, 2:148–149
 - Ericaceae nutrition, 10:196–197
 - foliar application, 6:328–329
 - fruit softening, 10:107–152
 - nutrition, 5:322–323
 - pine bark media, 9:116–117
 - tipburn, disorder, 4:50–57
- Calmodulin, 10:132–134, 137–138
- Caparis*, *see* Caper bush
- Caper bush, 27:125–188
- Carbohydrate:
- fig, 12:436–437
 - kiwifruit partitioning, 12:318–324
 - metabolism, 7:69–108
 - partitioning, 7:69–108
 - petal senescence, 11:19–20
 - reserves in deciduous fruit trees, 10:403–430

- Carbon dioxide, enrichment, 7:345–398,
544–545
- Carnation, fertilization, 1:100; 5:341–345
- Carrot:
CA storage, 1:362–366
fluid drilling of seed, 3:13–14
postharvest physiology, 30:284–288
- Caryophyllaceae, in vitro, 5:237–239
- Cassava:
crop physiology, 13:105–129
molecular biology, 26:85–159
multiple cropping, 30:355–50
postharvest physiology, 30:288–295
root crop, 12:158–166;;
- Cauliflower, CA storage, 1:359–362
- Celery, CA storage, 1:366–367
fluid drilling of seed, 3:14
- Cell culture, 3:214–314
woody legumes, 14:265–332
- Cell membrane:
calcium, 10:126–140
petal senescence, 11:20–26
- Cellular mechanisms, salt tolerance,
16:33–69
- Cell wall:
calcium, 10:109–122
hydrolases, 5:169–219
ice spread, 13:245–246
tomato, 13:70–71
- Chelates, 9:169–171
- Cherimoya, CA & MA, 22:146–147
- Cherry:
bloom delay, 15:105
CA storage, 1:308
origin, 19:263–317
wild of Kazakhstan, 29:326–330
- Chestnut:
blight, 8:281–336
botany & horticulture, 31:293–349
in vitro culture, 9:311–312
- Chicory, CA storage, 1:379
- Chilling:
injury, 4:260–261; 15:63–95
injury, chlorophyll fluorescence,
23:79–84
pistachio, 3:388–389
- China, protected cultivation, 30:37–82
- Chlorine:
deficiency & toxicity symptoms in
fruits & nuts, 2:153
nutrition, 5:239
- Chlorophyll fluorescence, 23:69–107
- Chlorosis, iron deficiency induced,
9:133–186
- Chrysanthemum fertilization, 1:100–101;
5:345–352
- Citrus:
abscission, 15:145–182
alternate bearing, 4:141–144
asexual embryogenesis, 7:163–168
CA storage, 1:312–313
chlorosis, 9:166–168
cold hardiness, 7:201–238
fertilization, 1:105
flowering, 12:349–408
functional phytochemicals, fruit,
27:269–315
honey bee pollination, 9:247–248
in vitro culture, 7:161–170
irrigation, 30:37–82
juice loss, 20:200–201
navel orange, 8:129–179
nitrogen metabolism, 8:181
practices for young trees, 24:319–372
rootstock, 1:237–269
viroid dwarfing, 24:277–317
- Classification:
Brassica, 28:27–28
lettuce, 28:25–27
potato, 28:23–26
tomato, 28:21–23
- Clivia*, 25:57
- Cloche (tunnel), 7:356–357
- Coconut palm:
asexual embryogenesis, 7:184
in vitro culture, 7:183–185
- Cold hardiness, 2:33–34
apple & pear bioregulation, 10:374–375
citrus, 7:201–238
factors affecting, 11:55–56
herbaceous plants, 6:373–417
injury, 2:26–27
nutrition, 3:144–171
pruning, 8:356–357
- Colocasia*, 8:45, 55–56, *see also* Aroids
- Common blight of bean, 3:45–46
- Compositae, in vitro, 5:235–237
- Container production, nursery crops,
9:75–101
- Controlled-atmosphere (CA) storage:
asparagus, 12:76–77, 127–130
chilling injury, 15:74–77

- flowers, 3:98; 10:52–55
 fruit quality, 8:101–127
 fruits, 1:301–336; 4:259–260
 pathogens, 3:412–461
 seeds, 2:134–135
 tropical fruit, 22:123–183
 tulip, 5:105
 vegetable quality, 8:101–127
 vegetables, 1:337–394; 4:259–260
- Controlled environment agriculture,
 7:534–545, *see also* Greenhouse
 greenhouse crops; hydroponic culture;
 protected culture
- Copper:
 deficiency & toxicity symptoms in
 fruits & nuts, 2:153
 foliar application, 6:329–330
 nutrition, 5:326–327
 pine bark media, 9:122–123
Corynebacterium flaccumfaciens, 3:33, 46
- Cotoneaster, wild of Kazakhstan,
 29:316–317
- Cowpea:
 genetics, 2:317–348
 U.S. production, 12:197–222
- Cranberry:
 botany & horticulture, 21:215–249
 fertilization, 1:106
 harvesting, 16:298–311
 wild of Kazakhstan, 29:349
- Crinum*, 25:58
- Crucifers phytochemicals, 28:150–156
- Cryopreservation:
 apical meristems, 6:357–372
 cold hardiness, 11:65–66
- Cryphonectria parasitica*. *See* *Endothia parasitica*
- Crytosperma*, 8:47, 58, *see also* Aroids
- Cucumber:
 CA storage, 1:367–368
 grafting, 28:91–96
- Cucurbita pepo*, *cultivar groups history*,
 25:71–170
- Currant:
 harvesting, 16:311–327
 wild of Kazakhstan, 29:341
- Custard apple, CA & MA, 22:164
- Cyrtanthus*, 25:15–19
- Cytokinin:
 cold hardiness, 11:65
 dormancy, 7:272–273
 floral promoter, 4:112–113
- flowering, 15:294–295, 318
 genetic regulation, 16:4–5, 14, 22–23
 grape root, 5:150, 153–156
 lettuce tipburn, 4:57–58
 mango fruit drop, 31:118–120
 petal senescence, 11:30–31
 rose senescence, 9:66
- D**
- Date palm:
 asexual embryogenesis, 7:185–187
 in vitro culture, 7:185–187
- Daylength, *see* Photoperiod
- Dedication:
 Bailey, L.H., 1:v-viii
 Beach, S.A., 1:v-viii
 Bukovac, M.J., 6:x-xii
 Campbell, C.W., 19:xiii
 Cummins, J.N., 15:xii–xv
 Dennis, F.G., 22:xi–xii
 De Hertogh, A.A., 26:xi–xii
 Faust, Miklos, 5:vi–x
 Hackett, W.P., 12:x-xiii
 Halevy, A.H., 8:x-xii
 Hess, C.E., 13:x-xii
 Kader, A.A., 16:xii–xv
 Kamemoto, H., 24:x-xiii
 Kester, D.E., 30:xiii–xvii
 Looney, N.E., 18:xiii
 Magness, J.R., 2:vi–viii
 Moore, J.N., 14:xii–xv
 Possingham, J.V., 27:xi–xiii
 Pratt, C., 20:ix–xi
 Proebsting, Jr., E.L., 9:x-xiv
 Rick, Jr., C.M., 4:vi–ix
 Ryugo, K., 25:x-xii
 Sansavini, S., 17:xii–xiv
 Sherman, W.B., 21:xi–xiii
 Smock, R.M., 7:x-xiii
 Sperling, C.E., 29:ix–x
 Stevens, M.A., 28:xi–xiii
 Warrington, L.J. 31:xi–xii
 Weiser, C.J., 11:x-xiii
 Whitaker, T.W., 3:vi–x
 Wittwer, S.H., 10:x-xiii
 Yang, S.F., 23:xi
- Deficit irrigation, 21:105–131
- Deficiency symptoms, in fruit & nut
 crops, 2:145–154
- Defoliation, apple & pear bioregulation,
 10:326–328
- ‘Delicious’ apple, 1:397–424

- Desiccation tolerance, 18:171–213
- Dieffenbachia*, see Aroids, ornamental
- Dioscorea*., see Yam
- Disease:
- air pollution, 8:25
 - aroids, 8:67–69; 10:18; 12:168–169
 - bacterial, of bean, 3:28–58
 - cassava, 12:163–164
 - control by virus, 3:399–403
 - controlled-atmosphere storage, 3:412–461
 - cowpea, 12:210–213
 - fig, 12:447–479
 - flooding, 13:288–299
 - hydroponic crops, 7:530–534
 - lettuce, 2:187–197
 - mycorrhizal fungi, 3:182–185
 - ornamental aroids, 10:18
 - resistance, acquired, 18:247–289
 - root, 5:29–31
 - stress, 4:261–262
 - sweet potato, 12:173–175
 - tulip, 5:63, 92
 - turnip moasic virus, 14:199–238
 - waxes, 23:1–68
 - yam (*Dioscorea*), 12:181–183
- Disorder, see also Postharvest physiology:
- bitterpit, 11:289–355
 - fig, 12:477–479
 - pear fruit, 11:357–411
 - watercore, 6:189–251; 11:385–387
- Dormancy, 2:27–30
- blueberry, 13:362–370
 - fruit trees, 7:239–300
 - tulip, 5:93
- Drip irrigation, 4:1–48
- Drought resistance, 4:250–251
- cassava, 13:114–115
- Durian, CA & MA, 22:147–148
- Dwarfing:
- apple, 3:315–375
 - apple mutants, 12:297–298
 - by virus, 3:404–405
- E**
- Easter lily, fertilization, 5:352–355
- Eggplant:
- grafting, 28:103–104
 - phytochemicals, 28:162–163
- Elderberry, wild of Kazakhstan, 29:349–350
- Embryogenesis. See Asexual embryogenesis
- Endothia parasitica*, 8:291–336
- Energy efficiency, in greenhouses, 1:141–171; 9:1–52
- Environment:
- air pollution, 8:20–22
 - controlled for agriculture, 7:534–545
 - controlled for energy efficiency, 1:141–171; 9:1–52
 - embryogenesis, 1:22, 43–44
 - fruit set, 1:411–412
 - ginseng, 9:211–226
 - greenhouse management, 9:32–38
 - navel orange, 8:138–140
 - nutrient film technique, 5:13–26
- Epipremnum*, see Aroids, ornamental
- Eriobotrya japonica*. see Loquat
- Erwinia*:
- amylovora*, 1:423–474
 - lathyr*, 3:34
- Essential elements:
- foliar nutrition, 6:287–355
 - pine bark media, 9:103–131
 - plant nutrition, 5:318–330
 - soil testing, 7:1–68
- Ethylene:
- abscission, citrus, 15:158–161, 168–176
 - apple bioregulation, 10:366–369
 - avocado, 10:239–241
 - bloom delay, 15:107–111
 - CA storage, 1:317–319, 348
 - chilling injury, 15:80
 - citrus abscission, 15:158–161, 168–176
 - cut flower storage, 10:44–46
 - dormancy, 7:277–279
 - flowering, 15:295–296, 319
 - flower longevity, 3:66–75
 - genetic regulation, 16:6–7, 14–15, 19–20
 - kiwifruit respiration, 6:47–48
 - mango fruit crop, 31:120–122
 - mechanical stress, 17:16–17
 - petal senescence, 11:16–19, 27–30
 - rose senescence, 9:65–66
- Eucharis*, 25:19–22
- Eucrosia*, 25:58
- F**
- Feed crops, cactus, 18:298–300
- Feijoa, CA & MA, 22:148
- Fertilization & fertilizer:

- anthurium, 5:334–335
 azalea, 5:335–337
 bedding plants, 5:337–341
 blueberry, 10:183–227
 carnation, 5:341–345
 chrysanthemum, 5:345–352
 controlled release, 1:79–139;
 5:347–348
 Easter lily, 5:352–355
 Ericaceae, 10:183–227
 foliage plants, 5:367–380
 foliar, 6:287–355
 geranium, 5:355–357
 greenhouse crops, 5:317–403
 lettuce, 2:175
 nitrogen, 2:401–404
 orchid, 5:357–358
 poinsettia, 5:358–360
 rose, 5:361–363
 snapdragon, 5:363–364
 soil testing, 7:1–68
 trickle irrigation, 4:28–31
 tulip, 5:364–366
Vaccinium, 10:183–227
 zinc nutrition, 23:109–128
 Fig:
 industry, 12:409–490
 ripening, 4:258–259
 Filbert, in vitro culture, 9:313–314
 Fire blight, 1:423–474
 Flooding, fruit crops, 13:257–313
 Floral scents, 24:31–53
 Floricultural crops, *see also* individual
 crops:
 Amaryllidaceae, 25:1–70
 Banksia, 22:1–25
 China, protected culture, 30:141–148
 fertilization, 1:98–104
 growth regulation, 7:399–481
 heliconia, 14:1–55
 Leucospermum, 22:27–90
 postharvest physiology & senescence,
 1:204–236; 3:59–143; 10:35–62;
 11:15–43
 Protea, 26:1–48
 Florigen, 4:94–98
 Flower & flowering:
 Amaryllidaceae, 25:1–70
 apple anatomy & morphology,
 10:277–283
 apple bioregulation, 10:344–348
 Arabidopsis, 27:1–39, 41–77
 aroids, ornamental, 10:19–24
 avocado, 8:257–289
 Banksia, 22:1–25
 blueberry development, 13:354–378
 cactus, 18:325–335
 citrus, 12:349–408
 control, 4:159–160; 15:279–334
 development (postpollination),
 19:1–58
 fig, 12:424–429
 girdling, 20:1–26
 grape anatomy & morphology,
 13:354–378
 homeotic gene regulation, 27:41–77
 honey bee pollination, 9:239–243
 induction, 4:174–203, 254–256
 initiation, 4:152–153
 in vitro, 4:106–127
 kiwifruit, 6:21–35; 12:316–318
 Leucospermum, 22:27–90
 lychee, 28:397–421
 orchid, 5:297–300
 pear bioregulation, 10:344–348
 pecan, 8:217–255
 perennial fruit crops, 12:223–264
 phase change, 7:109–155
 photoperiod, 4:66–105
 pistachio, 3:378–387
 postharvest physiology, 1:204–236;
 3:59–143; 10:35–62; 11:15–43
 postpollination development, 19:1–58
 protea leaf blackening, 17:173–201
 pruning, 8:359–362
 raspberry, 11:187–188
 regulation in floriculture, 7:416–424
 rhododendron, 12:1–42
 rose, 9:60–66
 scents, 24:31–53
 senescence, 1:204–236; 3:59–143;
 10:35–62; 11:15–43; 18:1–85
 strawberry, 28:325–349
 sugars, 4:114
 thin cell layer morphogenesis,
 14:239–256
 tulip, 5:57–59
 water relations, 18:1–85
 Fluid drilling, 3:1–58
 Foliage plants:
 acclimatization, 6:119–154
 fertilization, 1:102–103; 5:367–380
 industry, 31:47–112
 Foliar nutrition, 6:287–355

Freeze protection, *see* Frost protection

Frost:

- apple fruit set, 1:407–408
- citrus, 7:201–238
- protection, 11:45–109

Fruit:

- abscission, 1:172–203
- abscission, citrus, 15:145–182
- apple anatomy & morphology, 10:283–297
- apple bioregulation, 10:348–374
- apple bitter pit, 11:289–355
- apple crop load, 31:233–292
- apple flavor, 16:197–234
- apple maturity indices, 13:407–432
- apple ripening & quality, 10:361–374
- apple scald, 27:227–267
- apple weight loss, 25:197–234
- avocado development & ripening, 10:229–271
- bloom delay, 15:97–144
- blueberry development, 13:378–390
- cactus physiology, 18:335–341
- CA storage & quality, 8:101–127
- chilling injury, 15:63–95
- coating physiology, 26:161–238
- cracking, 19:217–262; 30:163–184
- diseases in CA storage, 3:412–461
- drop, apple
- fresh cut, 30:185–251
- functional phytochemicals, 27:269–315
- growth measurement, 24:373–431
- kiwifruit, 6:35–48; 12:316–318
- loquat, 23:233–276
- lychee, 28:433–444
- mango fruit drop, 31:113–155
- maturity indices, 13:407–432
- navel orange, 8:129–179
- nectarine, postharvest, 11:413–452
- nondestructive postharvest quality evaluation, 20:1–119
- olive physiology, 31:157–231
- olive processing, 25:235–260
- pawpaw, 31:351–384
- peach, postharvest, 11:413–452
- pear, bioregulation, 10:348–374
- pear, fruit disorders, 11:357–411
- pear maturity indices, 13:407–432
- pear ripening & quality, 10:361–374
- pear scald, 27:227–267
- pear volatiles, 28:237–324

- pistachio, 3:382–391
 - phytochemicals, 28:125–185
 - plum, 23:179–231
 - quality & pruning, 8:365–367
 - red bayberry, 30: 83–113
 - ripening, 5:190–205
 - set, 1:397–424; 4:153–154
 - set in navel oranges, 8:140–142
 - size & thinning, 1:293–294; 4:161
 - softening, 5:109–219; 10:107–152
 - splitting, 19:217–262
 - strawberry growth & ripening, 17:267–297
 - texture, 20:121–224
 - thinning, apple & pear, 10:353–359
 - tomato cracking, 30:163–184
 - tomato parthenocarpy, 6:65–84
 - tomato ripening, 13:67–103
 - volatiles, pear, 28:237–324
- Fruit crops, *see also* Individual crop
- alternate bearing, 4:128–173
 - apple bitter pit, 11:289–355
 - apple crop load, 31:233–292
 - apple flavor, 16:197–234
 - apple fruit splitting & cracking, 19:217–262
 - apple germplasm, 29:1–61, 63–303
 - apple growth, 11:229–287
 - apple maturity indices, 13:407–432
 - apple scald, 27:227–267
 - apple, wild of Kazakhstan, 29:63–303, 305–315
 - apricot, origin & dissemination, 22:225–266
 - apricot, wild of Kazakhstan, 29–325–326
 - avocado flowering, 8:257–289
 - avocado rootstocks, 17:381–429
 - barberry, wild of Kazakhstan, 29:332–336
 - berry crop harvesting, 16:255–382
 - bilberry, wild of Kazakhstan, 29:347–348
 - blackberry, wild of Kazakhstan, 29:345
 - bloom delay, 15:97–144
 - blueberry developmental physiology, 13:339–405
 - blueberry harvesting, 16:257–282
 - blueberry nutrition, 10:183–227
 - bramble harvesting, 16:282–298
 - cactus, 18:302–309

- carbohydrate reserves, 10:403–430
 CA & MA for tropicals, 22:123–183
 CA storage, 1:301–336
 CA storage diseases, 3:412–461
 cherry origin, 19:263–317
 cherry, wild of Kazakhstan,
 29:326–330
 chilling injury, 15:145–182
 chlorosis, 9:161–165
 citrus abscission, 15:145–182
 citrus cold hardiness, 7:201–238
 citrus, culture of young trees,
 24:319–372
 citrus dwarfing by viroids, 24:277–317
 citrus flowering, 12:349–408
 citrus irrigation, 30:37–82
 cotoneaster, wild of Kazakhstan,
 29:316–317
 cranberry, 21:215–249
 cranberry harvesting, 16:298–311
 cranberry, wild of Kazakhstan, 29:349
 currant harvesting, 16:311–327
 currant, wild of Kazakhstan, 29:341
 deficit irrigation, 21:105–131
 dormancy release, 7:239–300
 elderberry, wild of Kazakhstan,
 29:349–350
 Ericaceae nutrition, 10:183–227
 fertilization, 1:104–106
 fig, industry, 12:409–490
 fireblight, 11:423–474
 flowering, 12:223–264
 foliar nutrition, 6:287–355
 frost control, 11:45–109
 gooseberry, wild of Kazakhstan,
 29:341–342
 grape flower anatomy & morphology,
 13:315–337
 grape harvesting, 16:327–348
 grape irrigation, 27:189–225
 grape nitrogen metabolism, 14:407–452
 grape pruning, 16:235–254, 336–340
 grape root, 5:127–168
 grape seedlessness, 11:164–176
 grape, wild of Kazakhstan, 29:342–343
 grapevine pruning, 16:235–254,
 336–340
 greenhouse, China, 30:149–158
 honey bee pollination, 9:244–250,
 254–256
 jojoba, 17:233–266
 in vitro culture, 7:157–200; 9:273–349
 irrigation, deficit, 21:105–131
 kiwifruit, 6:1–64; 12:307–347
 lingonberry, 27:79–123
 lingonberry, wild of Kazakhstan,
 29:348–349
 longan, 16:143–196
 loquat, 23:233–276
 lychee, 16:143–196, 28:393–453
 mango fruit drop, 113–155
 mountain ash, wild of Kazakhstan,
 29:322–324
 mulberry, wild of Kazakhstan,
 29:350–351
 muscadine grape breeding, 14:357–405
 navel orange, 8:129–179
 nectarine postharvest, 11:413–452
 nondestructive postharvest quality
 evaluation, 20:1–119
 nutritional ranges, 2:143–164
 oleaster, wild of Kazakhstan,
 29:351–353
 olive physiology, 31:157–231
 olive salinity tolerance, 21:177–214
 orange, navel, 8:129–179
 orchard floor management, 9:377–430
 pawpaw, 31:351–384
 peach origin, 17:331–379
 peach postharvest, 11:413–452
 peach thinning, 28:351–392
 pear fruit disorders, 11:357–411;
 27:227–267
 pear maturity indices, 13:407–432
 pear scald, 27:227–267
 pear volatiles, 28:237–324
 pear, wild of Kazakhstan, 29:315–316
 pecan flowering, 8:217–255
 photosynthesis, 11:111–157
Phytophthora control, 17:299–330
 plum origin, 23:179–231
 plum, wild of Kazakhstan, 29:330–332
 pruning, 8:339–380
 rambutan, 16:143–196
 raspberry, 11:185–228
 raspberry, wild of Kazakhstan,
 29:343–345
 roots, 2:453–457
 rose, wild of Kazakhstan, 29:353–360
 sapindaceous fruits, 16:143–196
 sea buckthorn, wild of Kazakhstan,
 29:361

Fruit crops, *see also* Individual crop
(*cont.*)
short life & replant problem, 2:1–116
strawberry fruit growth, 17:267–297
strawberry harvesting, 16:348–365
strawberry, wild of Kazakhstan, 29:347
summer pruning, 9:351–375
Vaccinium nutrition, 10:183–227
vacciniums, wild of Kazakhstan,
29:347–349
viburnum, wild of Kazakhstan,
29:361–362
virus elimination, 28:187–236
water status, 7:301–344
Functional phytochemicals, fruit,
27:269–315

Fungi:

fig, 12:451–474
mushroom, 6:85–118
mycorrhiza, 3:172–213; 10:211–212
pathogens in postharvest storage,
3:412–461
truffle cultivation, 16:71–107

Fungicide, & apple fruit set, 1:416

G

Galanthus, 25:22–25

Garlic, CA storage, 1:375

Genetic variation:

alternate bearing, 4:146–150
photoperiodic response, 4:82
pollution injury, 8:16–19
temperature-photoperiod interaction,
17:73–123
wild apple, 29:63–303

Genetics & breeding:

aroids (edible), 8:72–75; 12:169
aroids (ornamental), 10:18–25
bean, bacterial resistance, 3:28–58
bloom delay in fruits, 15:98–107
bulbs, flowering, 18:119–123
cassava, 12:164
chestnut blight resistance, 8:313–321
citrus cold hardiness, 7:221–223
cranberry, 21:236–239
embryogenesis, 1:23
fig, 12:432–433
fire blight resistance, 1:435–436
flowering, 15:287–290, 303–305,
306–309, 314–315; 27:1–39, 41–77
flower longevity, 1:208–209

ginseng, 9:197–198
grafting use, 28:109–115
in vitro techniques, 9:318–324;
18:119–123
lettuce, 2:185–187
lingonberry, 27:108–111
loquat, 23:252–257
muscadine grapes, 14:357–405
mushroom, 6:100–111
navel orange, 8:150–156
nitrogen nutrition, 2:410–411
pineapple, 21:138–164
plant regeneration, 3:278–283
pollution insensitivity, 8:18–19
potato tuberization, 14:121–124
rhododendron, 12:54–59
sweet potato, 12:175
sweet sorghum, 21:87–90
tomato parthenocarp, 6:69–70
tomato ripening, 13:77–98
tree short life, 2:66–70
Vigna, 2:311–394
waxes, 23:50–53
woody legume tissue & cell culture,
14:311–314
yam (*Dioscorea*), 12:183
Geophyte, *see* Bulb, Tuber
Geranium, fertilization, 5:355–357
Germination, seed, 2:117–141, 173–174;
24:229–275
Germplasm:
acquisition, apple, 29:1–61
characterization, apple, 29:45–56
cryopreservation, 6:357–372
in vitro, 5:261–264; 9:324–325
pineapple, 21:133–175
resources, apple, 29:1–61
Gibberellin:
abscission, citrus, 15:166–167
bloom delay, 15:111–114
citrus, abscission, 15:166–167
cold hardiness, 11:63
dormancy, 7:270–271
floral promoter, 4:114
flowering, 15:219–293, 315–318
genetic regulation, 16:15
grape root, 5:150–151
mango fruit drop, 31:113–155
mechanical stress, 17:19–20
Ginger postharvest physiology,
30:297–299

- Ginseng, 9:187–236
- Girdling, 1:416–417; 4:251–252, 30:1–26
- Glucosinolates, 19:99–215
- Gooseberry, wild of Kazakhstan,
29:341–342
- Gourd, history, 25:71–171
- Graft & grafting:
herbaceous, 28:61–124
incompatibility, 15:183–232
phase change, 7:136–137, 141–142
rose, 9:56–57
- Grape:
CA storage, 1:308
chlorosis, 9:165–166
flower anatomy & morphology,
13:315–337
functional phytochemicals, 27:291–298
irrigation, 27:189–225
harvesting, 16:327–348
muscadine breeding, 14:357–405
nitrogen metabolism, 14:407–452
pollen morphology, 13:331–332
pruning, 16:235–254, 336–340
root, 5:127–168
seedlessness, 11:159–187
sex determination, 13:329–331
wild of Kazakhstan, 29:342–343
- Gravitropism, 15:233–278
- Greenhouse & greenhouse crops:
carbon dioxide, 7:357–360, 544–545
China protected cultivation,
30:115–162
energy efficiency, 1:141–171; 9:1–52
growth substances, 7:399–481
nutrition & fertilization, 5:317–403
pest management, 13:1–66
vegetables, 21:1–39
- Growth regulators, *see* Growth substances
- Growth substances, 2:60–66; 24:55–138,
see also Absciscic acid, Auxin,
Cytokinins, Ethylene, Gibberellins
abscission, citrus, 15:157–176
apple bioregulation, 10:309–401
apple dwarfing, 3:315–375
apple fruit set, 1:417
apple thinning, 1:270–300
aroids, ornamental, 10:14–18
avocado fruit development,
10:229–243
bloom delay, 15:107–119
CA storage in vegetables, 1:346–348
cell cultures, 3:214–314
chilling injury, 15:77–83
citrus abscission, 15:157–176
cold hardiness, 7:223–225; 11:58–66
dormancy, 7:270–279
embryogenesis, 1:41–43; 2:277–281
floriculture, 7:399–481
flower induction, 4:190–195
flowering, 15:290–296
flower storage, 10:46–51
genetic regulation, 16:1–32
ginseng, 9:226
girdling, 20:1–26
grape seedlessness, 11:177–180
hormone reception, 26:49–84
in vitro flowering, 4:112–115
mango fruit drop, 31:113–155
mechanical stress, 17:16–21
meristem & shoot-tip culture,
5:221–227
navel oranges, 8:146–147
pear bioregulation, 10:309–401
petal senescence, 3:76–78
phase change, 7:137–138, 142–143
raspberry, 11:196–197
regulation, 11:1–14
rose, 9:53–73
seedlessness in grape, 11:177–180
triazole, 10:63–105
- H**
- Haemanthus*, 25:25–28
- Halo blight of beans, 3:44–45
- Hardiness, 4:250–251
- Harvest:
flower stage, 1:211–212
index, 7:72–74
lettuce, 2:176–181
mechanical of berry crops, 16:255–382
- Hawthorne, wild of Kazakhstan,
29:317–322
- Hazelnut. *See* Filbert
wild of Kazakhstan, 29:365–366
- Health phytochemicals:
fruit, 27:269–315
vegetables, 28:125–185
- Heat treatment (postharvest), 22:91–121
- Heliconia, 14:1–55
- Herbaceous plants, subzero stress,
6:373–417

Hippeastrum, 25:29–34

Histochemistry:

fruit induction, 4:177–179

fruit abscission, 1:172–203

Histology, flower induction, 4:179–184,

see also Anatomy & morphology

Honey bee, 9:237–272

Honeysuckle, wild of Kazakhstan, 29:350

Horseradish, CA storage, 1:368

Hydrolases, 5:169–219

Hydroponic culture, 5:1–44; 7:483–558

Hymenocallis, 25:59

Hypovirulence, in *Endothia parasitica*,
8:299–310

I

Ismene, 25:59

Ice, formation & spread in tissues,
13:215–255

Ice-nucleating bacteria, 7:210–212;
13:230–235

Industrial crops, cactus, 18:309–312

Insects & mites:

aroids, 8:65–66

avocado pollination, 8:275–277

fig, 12:442–447

hydroponic crops, 7:530–534

integrated pest management, 13:1–66

lettuce, 2:197–198

ornamental aroids, 10:18

particle film control, 31:1–45

tree short life, 2:52

tulip, 5:63, 92

waxes, 23:1–68

Integrated pest management, greenhouse
crops, 13:1–66

In vitro:

abscission, 15:156–157

apple propagation, 10:325–326

aroids, ornamental, 10:13–14

artemisia, 19:342–345

bioreactor technology, 24:1–30

bulbs, flowering, 18:87–169

cassava propagation, 13:121–123;
26:99–119

cellular salinity tolerance, 16:33–69

cold acclimation, 6:382

cryopreservation, 6:357–372

embryogenesis, 1:1–78; 2:268–310;
7:157–200; 10:153–181

environmental control, 17:123–170

flowering bulbs, 18:87–169

flowering, 4:106–127

pear propagation, 10:325–326

phase change, 7:144–145

propagation, 3:214–314; 5:221–277;
7:157–200; 9:57–58, 273–349;
17:125–172

thin cell layer morphogenesis,
14:239–264

woody legume culture, 14:265–332

Iron:

deficiency & toxicity symptoms in
fruits & nuts, 2:150

deficiency chlorosis, 9:133–186

Ericaceae nutrition, 10:193–195

foliar application, 6:330

nutrition, 5:324–325

pine bark media, 9:123

Irrigation:

citrus, 30:37–82

deficit, deciduous orchards,
21:105–131

drip or trickle, 4:1–48

frost control, 11:76–82

fruit trees, 7:331–332

grape, 27:189–225

grape root growth, 5:140–141

lettuce industry, 2:175

navel orange, 8:161–162

root growth, 2:464–465

J

Jojoba, 17:233–266

Juvenility, 4:111–112

pecan, 8:245–247

tulip, 5:62–63

woody plants, 7:109–155

K

Kale, fluid drilling of seed, 3:21

Kazakhstan, see Wild fruits & nuts

Kiwifruit:

botany, 6:1–64

vine growth, 12:307–347

L

Lamps, for plant growth, 2:514–531

Lanzon, CA & MA, 22:149

Leaves:

apple morphology, 12:283–288

flower induction, 4:188–189

- Leek:
 CA storage, 1:375
 fertilization, 1:118
- Leguminosae, *in vitro*, 5:227–229;
 14:265–332
- Lemon, rootstock, 1:244–246, *see also*
 Citrus
- Lettuce:
 CA storage, 1:369–371
 classification, 28:25–27
 fertilization, 1:118
 fluid drilling of seed, 3:14–17
 industry, 2:164–207
 seed germination, 24:229–275
 tipburn, 4:49–65
- Leucojum*, 25:34–39
- Leucospermum*, 22:27–90
- Light:
 fertilization, greenhouse crops,
 5:330–331
 flowering, 15:282–287, 310–312
 fruit set, 1:412–413
 lamps, 2:514–531
 nitrogen nutrition, 2:406–407
 orchards, 2:208–267
 ornamental aroids, 10:4–6
 photoperiod, 4:66–105
 photosynthesis, 11:117–121
 plant growth, 2:491–537
 tolerance, 18:215–246
- Lingonberry, 27:79–123
 wild of Kazakhstan, 29:348–349
- Longan, *see also* Sapindaceous fruits
 CA & MA, 22:150
- Loquat:
 botany & horticulture, 23:233–276
 CA & MA, 22:149–150
- Lychee, *see also* Sapindaceous fruits
 CA & MA, 22:150
 flowering, 28:397–421
 fruit abscission, 28–437–443
 fruit development, 28:433–436
 pollination, 28:422–428
 reproductive biology, 28:393–453
Lycoris, 25:39–43
- M**
- Magnesium:
 container growing, 9:84–85
 deficiency & toxicity symptoms in
 fruits & nuts, 2:148
- Ericaceae nutrition, 10:196–198
 foliar application, 6:331
 nutrition, 5:323
 pine bark media, 9:117–119
- Magnetic resonance imaging, 20:78–86,
 225–266
- Male sterility, temperature-photoperiod
 induction, 17:103–106
- Mandarin, rootstock, 1:250–252
- Manganese:
 deficiency & toxicity symptoms in
 fruits & nuts, 2:150–151
 Ericaceae nutrition, 10:189–193
 foliar application, 6:331
 nutrition, 5:235–326
 pine bark media, 9:123–124
- Mango:
 alternate bearing, 4:145–146
 asexual embryogenesis, 7:171–173
 CA & MA, 22:151–157
 CA storage, 1:313
 fruit drop, 31:113–155
in vitro culture, 7:171–173
- Mangosteen, CA & MA, 22:157
- Mechanical harvest, berry crops,
 16:255–382
- Mechanical stress regulation, 17:1–42
- Media:
 fertilization, greenhouse crops, 5:333
 pine bark, 9:103–131
- Medicinal crops:
 artemisia, 19:319–371
 poppy, 19:373–408
- Melon grafting, 28:96–98
- Meristem culture, 5:221–277
- Metabolism:
 flower, 1:219–223
 nitrogen in citrus, 8:181–215
 seed, 2:117–141
- Micronutrients:
 container growing, 9:85–87
 pine bark media, 9:119–124
- Micropropagation, *see also* *In vitro*;
 propagation:
 bulbs, flowering, 18:89–113
 environmental control, 17:125–172
 nuts, 9:273–349
 rose, 9:57–58
 temperate fruits, 9:273–349
 tropical fruits & palms, 7:157–200
- Microtu*, *see* Vole

Modified atmosphere (MA) for tropical fruits, 22:123–183

Moisture & seed storage, 2:125–132

Molecular biology:

- cassava, 26:85–159
- floral induction, 27:3–20
- flowering, 27:1–39;41–77
- hormone reception, 26:49–84

Molybdenum nutrition, 5:328–329

Monocot, in vitro, 5:253–257

Monstera, see Aroids, ornamental

Morphology:

- navel orange, 8:132–133
- orchid, 5:283–286
- pecan flowering, 8:217–243
- red bayberry, 30: 92–96

Moth bean, genetics, 2:373–374

Mountain ash, wild of Kazakhstan, 29:322–324

Mulberry, wild of Kazakhstan, 29:350–351

Multiple cropping, 30:355–500

Mung bean, genetics, 2:348–364

Mushroom:

- CA storage, 1:371–372
- cultivation, 19:59–97
- spawn, 6:85–118

Muskmelon, fertilization, 1:118–119

Mycoplasma-like organisms, tree short life, 2:50–51

Mycorrhizae:

- container growing, 9:93
- Ericaceae, 10:211–212
- fungi, 3:172–213
- grape root, 5:145–146

Myrica, see Red bayberry

N

Narcissus, 25:43–48

Navel orange, 8:129–179

Nectarine:

- bloom delay, 15:105–106
- CA storage, 1:309–310
- postharvest physiology, 11:413–452

Nematodes:

- aroids, 8:66
- fig, 12:475–477
- lettuce, 2:197–198
- tree short life, 2:49–50

Nerine, 25:48–56

NFT (nutrient film technique), 5:1–44

Nitrogen:

- CA storage, 8:116–117
- container growing, 9:80–82
- deficiency & toxicity symptoms in fruits & nuts, 2:146
- Ericaceae nutrition, 10:198–202
- fixation in woody legumes, 14:322–323
- foliar application, 6:332
- in embryogenesis, 2:273–275
- metabolism in apple, 4:204–246
- metabolism in citrus, 8:181–215
- metabolism in grapevine, 14:407–452
- nutrition, 2:395, 423; 5:319–320
- pine bark media, 9:108–112
- trickle irrigation, 4:29–30
- vegetable crops, 22:185–223

Nomenclature, 28:1–60

Nondestructive quality evaluation of fruits & vegetables, 20:1–119

Nursery crops:

- fertilization, 1:106–112
- nutrition, 9:75–101

Nut crops, see also Individual crop

- almond postharvest technology & utilization, 20:267–311
- almond, wild of Kazakhstan, 29:262–265
- chestnut blight, 8:291–336
- chestnut, botany & horticulture, 31:293–349
- fertilization, 1:106
- hazelnut, wild of Kazakhstan, 29:365–366
- honey bee pollination, 9:250–251
- in vitro culture, 9:273–349
- nutritional ranges, 2:143–164
- pine, wild of Kazakhstan, 29:368–369
- pistachio culture, 3:376–396
- pistachio, wild of Kazakhstan, 29:366–368
- walnut, wild of Kazakhstan, 29:369–370

Nutrient:

- concentration in fruit & nut crops, 2:154–162
- film technique, 5:1–44
- foliar-applied, 6:287–355
- media, for asexual embryogenesis, 2:273–281
- media, for organogenesis, 3:214–314
- plant & tissue analysis, 7:30–56
- solutions, 7:524–530

- uptake, in trickle irrigation, 4:30–31
- Nutrition (human):
- aroids, 8:79–84
 - CA storage, 8:101–127
 - phytochemicals in fruit, 27:269–315
 - phytochemicals in vegetables, 28:125–185
 - steroidal alkaloids, 25:171–196
- Nutrition (plant):
- air pollution, 8:22–23, 26
 - blueberry, 10:183–227
 - calcifuge, 10:183–227
 - cold hardiness, 3:144–171
 - container nursery crops, 9:75–101
 - cranberry, 21:234–235
 - ecologically based, 24:156–172
 - embryogenesis, 1:40–41
 - Ericaceae, 10:183–227
 - fire blight, 1:438–441
 - foliar, 6:287–355
 - fruit & nut crops, 2:143–164
 - ginseng, 9:209–211
 - greenhouse crops, 5:317–403
 - kiwifruit, 12:325–332
 - mycorrhizal fungi, 3:185–191
 - navel orange, 8:162–166
 - nitrogen in apple, 4:204–246
 - nitrogen in vegetable crops, 22:185–223
 - nutrient film techniques, 5:18–21, 31–53
 - ornamental aroids, 10:7–14
 - pine bark media, 9:103–131
 - raspberry, 11:194–195
 - slow-release fertilizers, 1:79–139
- O**
- Oil palm:
- asexual embryogenesis, 7:187–188
 - in vitro culture, 7:187–188
- Okra:
- botany & horticulture, 21:41–72
 - CA storage, 1:372–373
- Oleaster, wild of Kazakhstan, 29:351–353
- Olive:
- alternate bearing, 4:140–141
 - olive physiology, 31:147–231
 - salinity tolerance, 21:177–214
 - processing technology, 25:235–260
- Onion:
- CA storage, 1:373–375
 - fluid drilling of seed, 3:17–18
- Opium poppy, 19:373–408
- Orange, *see also* Citrus
- alternate bearing, 4:143–144
 - sour, rootstock, 1:242–244
 - sweet, rootstock, 1:252–253
 - trifoliolate, rootstock, 1:247–250
- Orchard & orchard systems:
- floor management, 9:377–430
 - light, 2:208–267
 - root growth, 2:469–470
 - water, 7:301–344
- Orchid:
- fertilization, 5:357–358
 - pollination regulation of flower development, 19:28–38
 - physiology, 5:279–315
- Organogenesis, 3:214–314, *see also* In vitro; tissue culture
- Ornamental plants, *see also* individual plant
- Amaryllidaceae
 - Banksia*, 22:1–25
 - cactus grafting, 28–106–109
 - chlorosis, 9:168–169
 - cotoneaster, wild of Kazakhstan, 29:316–317
 - fertilization, 1:98–104, 106–116
 - flowering bulb roots, 14:57–88
 - flowering bulbs in vitro, 18:87–169
 - foliage acclimatization, 6:119–154
 - foliage industry, 31:47–112
 - heliconia, 14:1–55
 - honeysuckle, wild of Kazakhstan, 29:350
 - Leucospermum*, 22:27–90
 - oleaster, wild of Kazakhstan, 29:351–353
 - orchid pollination regulation, 19:28–38
 - poppy, 19:373–408
 - protea leaf blackening, 17:173–201
 - rhododendron, 12:1–42
 - rose, wild of Kazakhstan, 29:353–360
 - viburnum, wild of Kazakhstan, 29:361–362
- P**
- Paclobutrazol, *see* Triazole
- Papaya:
- asexual embryogenesis, 7:176–177
 - CA & MA, 22:157–160
 - CA storage, 1:314
 - in vitro culture, 7:175–178

- Parsley:
 CA storage, 1:375
 drilling of seed, 3:13–14
- Parsnip, fluid drilling of seed, 3:13–14
- Parthenocarpy, tomato, 6:65–84
- Particle films, 31:1–45
- Passion fruit:
 in vitro culture, 7:180–181
 CA & MA, 22:160–161
- Pathogen elimination, in vitro, 5:257–261
- Pawpaw, 31:351–384
- Peach:
 bloom delay, 15:105–106
 CA storage, 1:309–310
 origin, 17:333–379
 postharvest physiology, 11:413–452
 short life, 2:4
 summer pruning, 9:351–375
 thinning, 28:351–392
 wooliness, 20:198–199
- Peach palm (Pejibaye):
 in vitro culture, 7:187–188
- Pear:
 bioregulation, 10:309–401
 bloom delay, 15:106–107
 CA storage, 1:306–308
 decline, 2:11
 fire blight control, 1:423–474
 fruit disorders, 11:357–411;
 27:227–267
 fruit volatiles, 28:237–324
 in vitro, 9:321
 maturity indices, 13:407–432
 root distribution, 2:456
 scald, 27:227–267
 short life, 2:6
 wild of Kazakhstan, 29:315–316
- Pecan:
 alternate bearing, 4:139–140
 fertilization, 1:106
 flowering, 8:217–255
 in vitro culture, 9:314–315
- Pejibaye, in vitro culture, 7:189
- Pepper (*Capsicum*):
 CA storage, 1:375–376
 fertilization, 1:119
 fluid drilling in seed, 3:20
 grafting, 28:104–105
 phytochemicals, 28:161–162
- Persimmon:
 CA storage, 1:314
 quality, 4:259
- Pest control:
 aroids (edible), 12:168–169
 aroids (ornamental), 10:18
 cassava, 12:163–164
 cowpea, 12:210–213
 ecologically based, 24:172–201
 fig, 12:442–477
 fire blight, 1:423–474
 ginseng, 9:227–229
 greenhouse management, 13:1–66
 hydroponics, 7:530–534
 particle films, 31:1–45
 sweet potato, 12:173–175
 vertebrate, 6:253–285
 yam (*Dioscorea*), 12:181–183
- Petal senescence, 11:15–43
- pH:
 container growing, 9:87–88
 fertilization greenhouse crops,
 5:332–333
 pine bark media, 9:114–117
 soil testing, 7:8–12, 19–23
- Phase change, 7:109–155
- Phenology:
 apple, 11:231–237
 raspberry, 11:186–190
- Philodendron*, see Aroids, ornamental
- Phosphonates, *Phytophthora* control,
 17:299–330
- Phosphorus:
 container growing, 9:82–84
 deficiency & toxicity symptoms in
 fruits & nuts, 2:146–147
 nutrition, 5:320–321
 pine bark media, 9:112–113
 trickle irrigation, 4:30
- Photoautotrophic micropropagation,
 17:125–172
- Photoperiod, 4:66–105, 116–117;
 17:73–123
 flowering, 15:282–284, 310–312
- Photosynthesis:
 cassava, 13:112–114
 efficiency, 7:71–72; 10:378
 fruit crops, 11:111–157
 ginseng, 9:223–226
 light, 2:237–238
- Physiology, see also Postharvest
 physiology
 apple crop load, 31:233–292
 bitter pit, 11:289–355
 blueberry development, 13:339–405

- cactus reproductive biology,
 - 18:321–346
 - calcium, 10:107–152
 - carbohydrate metabolism, 7:69–108
 - cassava, 13:105–129
 - citrus cold hardiness, 7:201–238
 - citrus irrigation, 30:55–67
 - conditioning 13:131–181
 - cut flower, 1:204–236; 3:59–143;
 - 10:35–62
 - desiccation tolerance, 18:171–213
 - disease resistance, 18:247–289
 - dormancy, 7:239–300
 - embryogenesis, 1:21–23; 2:268–310
 - floral scents, 24:31–53
 - flower development, 19:1–58
 - flowering, 4:106–127
 - fruit ripening, 13:67–103
 - fruit softening, 10:107–152
 - ginseng, 9:211–213
 - girdling, 30: 1–26
 - glucosinolates, 19:99–215
 - grafting, 28:78–84
 - heliconia, 14:5–13
 - hormone reception, 26:49–84
 - juvenility, 7:109–155
 - lettuce seed germination,
 - 24:229–275
 - light tolerance, 18:215–246
 - loquat, 23:242–252
 - lychee reproduction, 28:393–453
 - male sterility, 17:103–106
 - mango fruit drop, 31:113–155
 - mechanical stress, 17:1–42
 - nitrogen metabolism in grapevine,
 - 14:407–452
 - nutritional quality & CA storage,
 - 8:118–120
 - olive, 31:157–231
 - olive salinity tolerance, 21:177–214
 - orchid, 5:279–315
 - particle films, 31–1–45
 - petal senescence, 11:15–43
 - photoperiodism, 17:73–123
 - pollution injury, 8:12–16
 - polyamines, 14:333–356
 - potato tuberization, 14:89–188
 - pruning, 8:339–380
 - raspberry, 11:190–199
 - red bayberry, 30:96–99
 - regulation, 11:1–14
 - root pruning, 6:158–171
 - roots of flowering bulbs, 14:57–88
 - rose, 9:3–53
 - salinity hormone action, 16:1–32
 - salinity tolerance, 16:33–69
 - seed, 2:117–141
 - seed priming, 16:109–141
 - strawberry flowering, 28:28:325–349
 - subzero stress, 6:373–417
 - summer pruning, 9:351–375
 - sweet potato, 23:277–338
 - thin cell layer morphogenesis,
 - 14:239–264
 - tomato fruit ripening, 13:67–103
 - tomato parthenocarp, 6:71–74
 - triazaoles, 10:63–105; 24:55–138
 - tulip, 5:45–125
 - vernalization, 17:73–123
 - volatiles, 17:43–72
 - watercore, 6:189–251
 - water relations cut flowers, 18:1–85
 - waxes, 23:1–68
- Phytochemicals, functional:
- fruits, 27:269–315
 - vegetables, 28:125–185
- Phytohormones. *see* Growth substances
- Phytophthora* control, 17:299–330
- Phytotoxins, 2:53–56
- Pigmentation:
- flower, 1:216–219
 - rose, 9:64–65
- Pinching, by chemicals, 7:453–461
- Pine, wild of Kazakhstan, 29:368–369
- Pineapple:
- CA & MA, 22:161–162
 - CA storage, 1:314
 - genetic resources, 21:138–141
 - in vitro culture, 7:181–182
- Pine bark, potting media, 9:103–131
- Pistachio:
- alternate bearing, 4:137–139
 - culture, 3:376–393
 - in vitro culture, 9:315
 - wild of Kazakhstan, 29:366–368
- Plantain:
- CA & MA, 22:141–146
 - in vitro culture, 7:178–180
- Plant:
- classification, 28:1–60
 - protection, short life, 2:79–84
 - systematics, 28:1–60
- Plastic cover, sod production,
 - 27:317–351

Plum:

- CA storage, 1:309
 - origin, 23:179–231
 - wild of Kazakhstan, 29:330–332
- Poinsettia, fertilization, 1:103–104;
5:358–360
- Pollen, desiccation tolerance, 18:195

Pollination:

- apple, 1:402–404
 - avocado, 8:272–283
 - cactus, 18:331–335
 - embryogenesis, 1:21–22
 - fig, 12:426–429
 - floral scents, 24:31–53
 - flower regulation, 19:1–58
 - fruit crops, 12:223–264
 - fruit set, 4:153–154
 - ginseng, 9:201–202
 - grape, 13:331–332
 - heliconia, 14:13–15
 - honey bee, 9:237–272
 - kiwifruit, 6:32–35
 - lychee, 28:422–428
 - navel orange, 8:145–146
 - orchid, 5:300–302
 - petal senescence, 11:33–35
 - protection, 7:463–464
 - rhododendron, 12:1–67
- Pollution, 8:1–42
- Polyamines:
- chilling injury, 15:80
 - in horticulture, 14:333–356
 - mango fruit drop, 31:125–127
- Polygalacturonase, 13:67–103
- Poppy, opium, 19:373–408
- Postharvest physiology:
- almond, 20:267–311
 - apple bitter pit, 11:289–355
 - apple maturity indices, 13:407–432
 - apple scald, 27:227–257
 - apple weight loss, 25:197–234
 - aroids, 8:84–86
 - asparagus, 12:69–155
 - CA for tropical fruit, 22:123–183
 - CA for storage & quality, 8:101–127
 - carrot storage: 30:284–288
 - cassava storage, 30:288–295
 - chlorophyll fluorescence, 23:69–107
 - coated fruits & vegetables, 26:161–238
 - cut flower, 1:204–236; 3:59–143;
10:35–62

- foliage plants, 6:119–154
 - fresh-cut fruits & vegetables, 30:85–255
 - fruit, 1:301–336
 - fruit softening, 10:107–152
 - ginger storage, 30:297–299
 - Jerusalem artichoke storage,
30:271–276
 - heat treatment, 22:91–121
 - lettuce, 2:181–185
 - low-temperature sweetening,
17:203–231, 30:317–355
 - MA for tropical fruit, 22:123–183
 - navel orange, 8:166–172
 - nectarine, 11:413–452
 - nondestructive quality evaluation,
20:1–119
 - pathogens, 3:412–461
 - peach, 11:413–452
 - pear disorders, 11:357–411;
27:227–267
 - pear maturity indices, 13:407–432
 - pear scald, 27:227–257
 - petal senescence, 11:15–43
 - potato low temperature sweetening,
30:317–355
 - potato storage, 30:259–271
 - protea leaf blackening, 17:173–201
 - quality evaluation, 20:1–119
 - scald, 27:227–267
 - seed, 2:117–141
 - sweet potato storage, 30:276–284
 - texture in fresh fruit, 20:121–244
 - taro storage, 30:295–297;
 - tomato fruit ripening, 13:67–103
 - vegetables, 1:337–394
 - watercore, 6:189–251; 11:385–387
- Potassium:
- container growing, 9:84
 - deficiency & toxicity symptoms in
fruits & nuts, 2:147–148
 - foliar application, 6:331–332
 - nutrition, 5:321–322
 - pine bark media, 9:113–114
 - trickle irrigation, 4:29
- Potato:
- CA storage, 1:376–378
 - classification, 28:23–26
 - fertilization, 1:120–121
 - low temperature sweetening,
17:203–231; 30:317–353
 - phytochemicals, 28:160–161

- postharvest physiology & storage,
 259–271
 tuberization, 14:89–198
 Processing, table olives, 25:235–260
 Propagation, *see also* In vitro
 apple, 10:324–326; 12:288–295
 aroids, ornamental, 10:12–13
 bioreactor technology, 24:1–30
 cassava, 13:120–123
 floricultural crops, 7:461–462
 foliage plants, 31:47–112
 ginseng, 9:206–209
 orchid, 5:291–297
 pear, 10:324–326
 rose, 9:54–58
 tropical fruit, palms 7:157–200
 woody legumes in vitro, 14:265–332
 Protaceous flower crop, *see also* Protea
 Banksia, 22:1–25
 Leucospermum, 22:27–90
 Protea, leaf blackening, 17:173–201
 Protected crops, carbon dioxide,
 7:345–398
 Protoplast culture, woody species,
 10:173–201
 Pruning, 4:161; 8:339–380
 apple, 9:351–375
 apple training, 1:414
 chemical, 7:453–461
 cold hardiness, 11:56
 fire blight, 1:441–442
 grapevines, 16:235–254
 light interception, 2:250–251
 peach, 9:351–375
 phase change, 7:143–144
 root, 6:155–188
Prunus, *see also* Almond; Cherry;
 Nectarine; Peach; Plum
 in vitro, 5:243–244; 9:322
 root distribution, 2:456
Pseudomonas:
 phaseolicola, 3:32–33, 39, 44–45
 solanacearum, 3:33
 syringae, 3:33, 40; 7:210–212
 Pumpkin, history, 25:71–170
- Q**
- Quality evaluation:
 fruits & vegetables, 20:1–119, 121–224
 nondestructive, 20:1–119
 texture in fresh fruit, 20:121–224
- R**
- Rabbit, 6:275–276
 Radish, fertilization, 1:121
 Rambutan. *see* Sapindaceous fruits
 CA & MA, 22:163
 Raspberry:
 harvesting, 16:282–298
 productivity, 11:185–228
 wild of Kazakhstan, 29:343–345
 Red bayberry, 30:83–113
 Rejuvenation:
 rose, 9:59–60
 woody plants, 7:109–155
 Replant problem, deciduous fruit trees,
 2:1–116
 Respiration:
 asparagus postharvest, 12:72–77
 fruit in CA storage, 1:315–316
 kiwifruit, 6:47–48
 vegetables in CA storage, 1:341–346
Rhizobium, 3:34, 41
 Rhododendron, 12:1–67
 Rice bean, genetics, 2:375–376
 Root:
 apple, 12:269–272
 cactus, 18:297–298
 diseases, 5:29–31
 environment, nutrient film technique,
 5:13–26
 Ericaceae, 10:202–209
 grape, 5:127–168
 kiwifruit, 12:310–313
 physiology of bulbs, 14:57–88
 pruning, 6:155–188
 raspberry, 11:190
 rose, 9:57
 tree crops, 2:424–490
 Root & tuber crops:
 Amaryllidaceae, 25:1–79
 aroids, 8:43–99; 12:166–170
 carrot postharvest physiology,
 30:284–288
 cassava crop physiology, 13:105–129
 cassava molecular biology, 26:85–159
 cassava multiple cropping, 30:355–50
 cassava postharvest physiology,
 30:288–295
 cassava root crop, 12:158–166;;
 low-temperature sweetening,
 17:203–231, 30:317–355
 minor crops, 12:184–188

- Root & tuber crops (*cont.*)
 potato low temperature sweetening,
 30:317–355
 potato tuberization, 14:89–188
 sweet potato, 12:170–176
 sweet potato physiology, 23:277–338
 sweet potato postharvest physiology,
 30:276–284
 taro postharvest physiology,
 30:295–297
 yam (*Dioscorea*), 12:177–184
- Rootstocks:
 alternate bearing, 4:148
 apple, 1:405–407; 12:295–297
 avocado, 17:381–429
 citrus, 1:237–269
 cold hardiness, 11:57–58
 fire blight, 1:432–435
 light interception, 2:249–250
 navel orange, 8:156–161
 root systems, 2:471–474
 stress, 4:253–254
 tree short life, 2:70–75
- Rosaceae, *in vitro*, 5:239–248
- Rose:
 fertilization, 1:104; 5:361–363
 growth substances, 9:3–53
in vitro, 5:244–248
 wild of Kazakhstan, 29:353–360
- S**
- Salinity:
 air pollution, 8:25–26
 citrus irrigation, 30:37–83
 olive, 21:177–214
 soils, 4:22–27
 tolerance, 16:33–69
- Sapindaceae fruits, 16:143–196
- Sapodilla, CA & MA, 22:164
- Scadoxus*, 25:25–28
- Scald, apple & pear, 27:227–265
- Scoring & fruit set, 1:416–417
- Sea buckthorn, wild of Kazakhstan, 29:361
- Seed:
 abortion, 1:293–294
 apple anatomy & morphology,
 10:285–286
 conditioning, 13:131–181
 desiccation tolerance, 18:196–203
 environmental influences on size &
 composition, 13:183–213
 flower induction, 4:190–195
 fluid drilling, 3:1–58
 grape seedlessness, 11:159–184
 kiwifruit, 6:48–50
 lettuce, 2:166–174
 lettuce germination, 24:229–275
 priming, 16:109–141
 rose propagation, 9:54–55
 vegetable, 3:1–58
 viability & storage, 2:117–141
- Secondary metabolites, woody legumes,
 14:314–322
- Senescence:
 chlorophyll senescence, 23:88–93
 cut flower, 1:204–236; 3:59–143;
 10:35–62; 18:1–85
 petal, 11:15–43
 pollination-induced, 19:4–25
 rose, 9:65–66
 whole plant, 15:335–370
- Sensory quality:
 CA storage, 8:101–127
- Shoot-tip culture, 5:221–277, *see also*
 Micropropagation
- Short life problem, fruit crops, 2:1–116
- Signal transduction, 26:49–84
- Small fruit, CA storage, 1:308
- Snapdragon fertilization, 5:363–364
- Sod production, 27:317–351
- Sodium, deficiency & toxicity symptoms
 in fruits & nuts, 2:153–154
- Soil:
 grape root growth, 5:141–144
 management & root growth, 2:465–469
 orchard floor management, 9:377–430
 plant relations, trickle irrigation,
 4:18–21
 stress, 4:151–152
 testing, 7:1–68; 9:88–90
 zinc, 23:109–178
- Soilless culture, 5:1–44
- Solanaceae:
in vitro, 5:229–232
 steroidal alkaloids, 25:171–196
- Somatic embryogenesis. *See* Asexual
 embryogenesis
- Sorghum, sweet, 21:73–104
- Spathiphyllum*, *see* Aroids, ornamental
- Squash, history, 25:71–170
- Stem, apple morphology, 12:272–283
- Sternbergia*, 25:59

- Steroidal alkaloids, solanaceous,
25:171–196
- Storage, *see also* Postharvest physiology,
Controlled-atmosphere (CA) storage
carrot postharvest physiology,
30:284–288
cassava postharvest physiology, 30:
288–295
cut flower, 3:96–100; 10:35–62
ginger postharvest physiology,
30:297–299
Jerusalem artichoke postharvest
physiology, 30:259–271
low temperature sweetening,
17:203–231; 30:317–353
potato low temperature sweetening,
30–317–353
potato postharvest physiology,
30:259–271
root & tuber crops, 30:253–316
rose plants, 9:58–59
seed, 2:117–141
sweetpotato postharvest physiology,
30:295–297
taro postharvest physiology,
30:295–297
- Strawberry:
fertilization, 1:106
flowering, 28:325–349
fruit growth & ripening, 17:267–297
functional phytonutrients, 27: 303–304
harvesting, 16:348–365
in vitro, 5:239–241
wild of Kazakhstan, 29:347
- Stress:
benefits of, 4:247–271
chlorophyll fluorescence, 23:69–107
climatic, 4:150–151
flooding, 13:257–313
mechanical, 17:1–42
olive, 31:2207–217
petal, 11:32–33
plant, 2:34–37
protectants (triazoles), 24:55–138
protection, 7:463–466
salinity tolerance in olive, 21:177–214
subzero temperature, 6:373–417
waxes, 23:1–68
- Sugar, *see also* Carbohydrate
allocation, 7:74–94
flowering, 4:114
- Sugar apple, CA & MA, 22:164
Sugar beet, fluid drilling of seed, 3:18–19
- Sulfur:
deficiency & toxicity symptoms in
fruits & nuts, 2:154
nutrition, 5:323–324
- Sweet potato:
culture, 12:170–176
fertilization, 1:121
physiology, 23:277–338
postharvest physiology & storage,
30:276–284
- Sweet sop, CA & MA, 22:164
- Symptoms, deficiency & toxicity
symptoms in fruits & nuts,
2:145–154
- Syngonium*, *see* Aroids, ornamental
- Systematics, 28:1–60
- T**
- Taro, *see* Aroids, edible
postharvest physiology & storage,
30:276–284
- Taxonomy, 28:1–60
- Tea, botany & horticulture, 22:267–295
- Temperature:
apple fruit set, 1:408–411
bloom delay, 15:119–128
CA storage of vegetables, 1:340–341
chilling injury, 15:67–74
cryopreservation, 6:357–372
cut flower storage, 10:40–43
fertilization, greenhouse crops,
5:331–332
fire blight forecasting, 1:456–459
flowering, 15:284–287, 312–313
interaction with photoperiod, 4:80–81
low temperature sweetening,
17:203–231
navel orange, 8:142
nutrient film technique, 5:21–24
photoperiod interaction, 17:73–123
photosynthesis, 11:121–124
plant growth, 2:36–37
seed storage, 2:132–133
subzero stress, 6:373–417
- Texture in fresh fruit, 20:121–224
- Thinning:
apple, 1:270–300
peach & *Prunus*, 28:351–392
- Tipburn, in lettuce, 4:49–65

- Tissue: *see also* In vitro culture 1:1–78;
2:268–310; 3:214–314; 4:106–127;
5:221–277; 6:357–372; 7:157–200;
8:75–78; 9:273–349; 10:153–181,
24:1–30
cassava, 26:85–159
dwarfing, 3:347–348
nutrient analysis, 7:52–56; 9:90
- Tomato:
CA storage, 1:380–386
classification, 28:21–23
chilling injury, 20:199–200
fruit cracking, 30:163–184
fertilization, 1:121–123
fluid drilling of seed, 3:19–20
fruit ripening, 13:67–103
galacturonase, 13:67–103
grafting, 28:98–103
greenhouse quality, 26:239
parthenocarp, 6:65–84
phytochemicals, 28:160
- Toxicity symptoms in fruit & nut crops,
2:145–154
- Transport, cut flowers, 3:100–104
- Tree decline, 2:1–116
- Triazoles, 10:63–105; 24:55–138
chilling injury, 15:79–80
- Trickle irrigation, 4:1–48
- Truffle cultivation, 16:71–107
- Tuber, potato, 14:89–188
- Tuber & root crops. *See* Root & tuber crops
- Tulip, *see also* Bulb
fertilization, 5:364–366
in vitro, 18:144–145
physiology, 5:45–125
- Tunnel (cloche), 7:356–357
- Turfgrass, fertilization, 1:112–117
- Turnip, fertilization, 1:123–124
- Turnip Mosaic Virus, 14:199–238
- U**
- Urd bean, genetics, 2:364–373
- Urea, foliar application, 6:332
- V**
- Vaccinium*, 10:185–187, *see also*
Blueberry; Cranberry; Lingonberry
functional phytonutrients, 27:303
wild of Kazakhstan, 29:347–349
- Vase solutions, 3:82–95; 10:46–51
- Vegetable crops, *see also* Specific crop
Allium phytochemicals, 28:156–159
aroids, 8:43–99; 12:166–170
asparagus postharvest, 12:69–155
cactus, 18:300–302
carrot postharvest physiology &
storage, 30:284–288
cassava:
crop physiology, 13:105–129
cassava molecular biology, 26:85–159
cassava multiple cropping, 30:355–50
cassava postharvest physiology & storage,
30:288–295
cassava root crop, 12:158–166:
CA storage, 1:337–394
CA storage & quality, 8:101–127
CA storage diseases, 3:412–461
caper bush, 27:125–188
chilling injury, 15:63–95
coating physiology, 26:161–238
crucifer phytochemicals, 28:150–156
cucumber grafting, 28:91–96
ecologically based, 24:139–228
eggplant grafting, 28:103–104
eggplant phytochemicals, 28:162–163
fertilization, 1:117–124
fluid drilling of seeds, 3:1–58
fresh cut, 30:185–255
ginger postharvest physiology &
storage, 30:297–299
gourd history, 25:71–170
grafting, 28:61–124
greenhouses in China, 30:126–141
greenhouse management, 21:1–39
greenhouse pest management, 13:1–66
honey bee pollination, 9:251–254
hydroponics, 7:483–558
Jerusalem artichoke postharvest
physiology & storage, 30:271–276
lettuce seed germination, 24:229–275
low-temperature sweetening,
17:203–231
melon grafting, 28:96–98
minor root & tubers, 12:184–188
mushroom cultivation, 19:59–97
mushroom spawn, 6:85–118
N nutrition, 22:185–223
nondestructive postharvest quality
evaluation, 20:1–119
okra, 21:41–72
pepper phytochemicals, 28:161–162
phytochemicals, 28:125–185
potato low temperature sweetening,
30:317–353

- potato postharvest physiology & storage, 30:271–276
- potato phytochemicals, 28:160–161
- potato tuberization, 14:89–188
- pumpkin history, 25:71–170
- root & tuber postharvest & storage, 30:295–297
- seed conditioning, 13:131–181
- seed priming, 16:109–141
- squash history, 25:71–170
- steroidal alkaloids, Solanaceae, 25:171–196
- sweet potato, 12:170–176
- sweet potato physiology, 23:277–338
- tomato (greenhouse) fruit cracking, 30:163–184
- tomato fruit ripening, 13:67–103
- tomato (greenhouse) quality: 26:239–319
- tomato parthenocarpy, 6:65–84
- tomato phytochemicals, 28:160
- tropical production, 24:139–228
- truffle cultivation, 16:71–107
- watermelon grafting, 28:86–91
- yam (*Dioscorea*), 12:177–184
- Vegetative tissue, desiccation tolerance, 18:176–195
- Vernalization, 4:117; 15:284–287; 17:73–123
- Vertebrate pests, 6:253–285
- Viburnum, wild of Kazakhstan, 29:361–362
- Vigna*, see also Cowpea
genetics, 2:311–394
U.S. production, 12:197–222
- Viroid, dwarfing for citrus, 24:277–317
- Virus:
benefits in horticulture, 3:394–411
dwarfing for citrus, 24:277–317
elimination, 7:157–200; 9:318; 18:113–123; 28:187–236
fig, 12:474–475
tree short life, 2:50–51
turnip mosaic, 14:199–238
- Volatiles, 17:43–72; 24:31–53; 28:237–324
- Vole, 6:254–274
- W**
- Walnut:
in vitro culture, 9:312
wild of Kazakhstan, 29:369–370
- Water relations:
cut flower, 3:61–66; 18:1–85
citrus, 30:37–83
deciduous orchards, 21:105–131
desiccation tolerance, 18:171–213
fertilization,
grape & grapevine, 27:189–225
kiwifruit, 12:332–339
light in orchards, 2:248–249
photosynthesis, 11:124–131
trickle irrigation, 4:1–48
- Watercore, 6:189–251
apple, 6:189–251
pear, 11:385–387
- Watermelon:
fertilization, 1:124
grafting, 28:86–91
- Wax apple, CA & MA, 22:164
- Waxes, 23:1–68
- Weed control, ginseng, 9:228–229
- Weeds:
lettuce research, 2:198
virus, 3:403
- Wild fruit & nuts of Kazakhstan,
29:305–371
almond, 29:262–265
apple, 29:63–303, 305–315
apricot, 29:325–326
barberry, 29:332–336
bilberry, 29:347–348
blackberry, 29:345
cherry, 29:326–330
cotoneaster, 29:316–317
cranberry, 29:349
currant, 29:341
elderberry, 29:349–350
gooseberry, 29:341–342
grape, 29:342–343
hazelnut, 29:365–366
lingonberry, 29:348–349
mountain ash, 29:322–324
mulberry, 29:350–351
oleaster, 29:351–353
pear, 29:315–316
pine, 29:368–369
pistachio, 29:366–368
plum, 29:330–332
raspberry, 29:343–345
rose, 29:353–360
sea buckthorn, 29:361
strawberry, 29:347
vacciniums, 29:347–349

viburnum, 29:361–362
 walnut, 29:369–370
 Woodchuck, 6:276–277
 Woody species, somatic embryogenesis,
 10:153–181

X

Xanthomonas phaseoli, 3:29–32, 41,
 45–46
 Xanthophyll cycle, 18:226–239
Xanthosoma, 8:45–46, 56–57, *see also*
 Aroids
 Sugar, *see also* Carbohydrate
 allocation, 7:74–94
 flowering, 4:114

Y

Yam (*Dioscorea*), 12:177–184
 Yield:
 determinants, 7:70–74; 97–99
 limiting factors, 15:413–452

Z

Zantedeschi, *see* Aroids, ornamental
 Zephyranthes, 25:60–61
 Zinc:
 deficiency & toxicity symptoms in
 fruits & nuts, 2:151
 foliar application, 6:332, 336
 nutrition, 5:326; 23:109–178
 pine bark media, 9:124

Cumulative Contributor Index (Volumes 1–31)

- Abbott, J.A., 20:1
Adams III, W.W., 18:215
Afek, U., 30:253
Aldwinckle, H.S., 1:423; 15:xiii, 29:1
Amarante, C., 28:161
Anderson, I.C., 21:73
Anderson, J.L., 15:97
Anderson, P.C., 13:257
Andrews, P.K., 15:183
Ashworth, E.N., 13:215; 23:1
Asokan, M.P., 8:43
Atkinson, D., 2:424
Aung, L.H., 5:45
- Bailey, W.G., 9:187
Baird, L.A.M., 1:172
Banks, N.H., 19:217; 25:197; 26:161
Barden, J.A., 9:351
Barker, A.V., 2:411
Bartz, J.A., 30:185
Bass, L.N., 2:117
Bassett, C. L., 26:49
Becker, J.S., 18:247
Beer, S.V., 1:423
Behboudian, M.H., 21:105; 27:189
Bennett, A.B., 13:67
Benschop, M., 5:45
Ben-Ya'acov, A., 17:381
Benzioni, A., 17:233
Bevington, K.B., 24:277
Bewley, J.D., 18:171
Binzel, M.L., 16:33
Blanpied, G.D., 7:xi
Blenkinsop, R.W., 30:317
- Bliss, F.A., 16:xiii; 28:xi
Boardman, K. 27 xi
Borochoy, A., 11:15
Bounous, G.; 31:293
Bower, J.P., 10:229
Bradley, G.A., 14:xiii
Brandenburg, W., 28:1
Brecht, J.K., 30:185
Brennan, R., 16:255
Broadbent, P., 24:277
Broschat, T.K., 14:1
Brown, S. 15:xiii
Buban, T., 4:174
Bukovac, M.J., 11:1
Burke, M.J., 11:xiii
Buwalda, J.G., 12:307
Byers, R.E., 6:253; 28:351
- Caldas, L.S., 2:568
Campbell, L.E., 2:524
Cantliffe, D.J., 16:109; 17:43; 24:229;
28:325
Carter, G., 20:121
Carter, J.V., 3:144
Cathey, H.M., 2:524
Chambers, R.J., 13:1
Chandler, C.K. 28:325
Charron, C.S., 17:43
Chen, J., 31:47
Chen, K., 30:83
Chen, Z., 25:171
Chin, C.K., 5:221
Clarke, N.D., 21:1
Coetzee, J. H., 26:1

- Cohen, M., 3:394
 Collier, G.F., 4:49
 Collins, G., 25:235
 Collins, W.L., 7:483
 Colmagro, S., 25:235
 Compton, M.E., 14:239
 Conover, C.A., 5:317; 6:119
 Connor, D.J., 31:157
 Coppens d'Eukenbrugge, G., 21:133
 Costa, G. 28:351
 Coyne, D.P., 3:28
 Crane, J.C., 3:376
 Criley, R.A., 14:1; 22:27; 24:x
 Crowley, W., 15:1
 Cutting, J.G., 10:229

 Daie, J., 7:69
 Dale, A., 11:185; 16:255
 Darnell, R.L., 13:339, 28:325
 Davenport, T.L., 8:257; 12:349; 31:113
 Davies, F.S., 8:129; 24:319
 Davies, P.J., 15:335
 Davis, T.D., 10:63; 24:55
 Decker, H.F., 27:317
 DeEll, J.R., 23:69
 DeGrandi-Hoffman, G., 9:237
 De Hertogh, A.A., 5:45; 14:57; 18:87; 25:1
 Deikman, J., 16:1
 DellaPenna, D., 13:67
 Demers, D.-A., 30:163
 Demmig-Adams, B., 18:215
 Dennis, F.G., Jr., 1:395
 Dickson, E.E., 29:1
 Dorais, M., 26:239; 30:163
 Doud, S.L., 2:1
 Dudareva, N., 24:31
 Duke, S.O., 15:371
 Dunavent, M.G., 9:103
 Duval, M.-F., 21:133
 Düzyaman, E., 21:41
 Dyer, W.E., 15:371
 Dzhangaliev, A.D., 29:63, 305

 Early, J.D., 13:339
 Eastman, K., 28:125
 Elfving, D.C., 4:1; 11:229
 El-Goorani, M.A., 3:412
 Esan, E.B., 1:1
 Evans, D.A., 3:214
 Ewing, E.E., 14:89

 Faust, M., 2:vii, 142; 4:174; 6:287; 14:333;
 17:331; 19:263; 22:225; 23:179
 Felkey, K., 30:185
 Fenner, M., 13:183
 Fenwick, G.R., 19:99
 Fereres, E., 31:157
 Ferguson, A.R., 6:1
 Ferguson, I.B., 11:289; 30:83; 31:233
 Ferguson, J.J., 24:277
 Ferguson, L., 12:409
 Ferree, D.C., 6:155; 31:xi
 Ferreira, J.F.S., 19:319
 Fery, R.L., 2:311; 12:157
 Fischer, R.L., 13:67
 Fletcher, R.A., 24:53
 Flick, C.E., 3:214
 Flore, J.A., 11:111
 Forshey, C.G., 11:229
 Forsline, P.L., 29:ix; 1
 Franks, R. G., 27:41
 Fujiwara, K., 17:125

 Gazit, S., 28:393
 Geisler, D., 6:155
 Geneve, R.L., 14:265
 George, W.L., Jr., 6:25
 Gerrath, J.M., 13:315
 Gilley, A., 24:55
 Giovannetti, G., 16:71
 Giovannoni, J.J., 13:67
 Glenn, G.M., 10:107; 31:1
 Goffinet, M.C., 20:ix
 Goldschmidt, E.E., 4:128; 30:1
 Goldy, R.G., 14:357
 Goren, R., 15:145; 30:1
 Gosselin, A., 26:239
 Goszczynska, D.M., 10:35
 Gradziel, T.M., 30: xiii
 Grace, S.C., 18:215
 Graves, C.J., 5:1
 Gray, D., 3:1
 Grierson, W., 4:247
 Griffen, G.J., 8:291
 Grodzinski, B., 7:345
 Gucci, R., 21:177
 Guest, D.I., 17:299
 Guiltinan, M.J., 16:1

 Hackett, W.P., 7:109
 Halevy, A.H., 1:204; 3:59

- Hallett, I.C., 20:121
 Hammerschmidt, R., 18:247
 Hanson, E.J., 16:255
 Harker, F.R., 20:121
 Heaney, R.K., 19:99
 Heath, R.R., 17:43
 Helzer, N.L., 13:1
 Hendrix, J.W., 3:172
 Henny, R.J., 10:1; 31:47
 Hergert, G.B., 16:255
 Hess, F.D., 15:371
 Hetterscheid, W.L.A., 28:1
 Heywood, V., 15:1
 Hjalmarsson, I., 27:79–123
 Hogue, E.J., 9:377
 Hokanson, S.C. 29:1
 Holt, J.S., 15:371
 Huber, D.J., 5:169
 Huberman, M., 30:1
 Hunter, E.L., 21:73
 Hutchinson, J.F., 9:273
 Hutton, R.J., 24:277
 Indira, P., 23:277
 Ingle, M. 27:227
 Isenberg, F.M.R., 1:337
 Iwakiri, B.T., 3:376
- Jackson, J.E., 2:208
 Janick, J., 1:ix; 8:xi; 17:xiii; 19:319; 21:xi;
 23:233
 Jarvis, W.R., 21:1
 Jenks, M.A., 23:1
 Jensen, M.H., 7:483
 Jeong, B.R., 17:125
 Jewett, T.J., 21:1
 Jiang, W., 30:115
 Joiner, J.N., 5:317
 Jones, H.G., 7:301
 Jones, J.B., Jr., 7:1
 Jones, R.B., 17:173
- Kagan-Zur, V., 16:71
 Kalt, W. 27:269; 28:125
 Kang, S.-M., 4:204
 Kato, T., 8:181
 Kawa, L., 14:57
 Kawada, K., 4:247
 Kays, S.J., 30:253
 Kelly, J.F., 10:ix; 22:xi
 Kester, D.E., 25:xii
- Khan, A.A., 13:131
 Kierman, J., 3:172
 Kim, K.-W., 18:87
 Kinet, J.-M., 15:279
 King, G.A., 11:413
 Kingston, C.M., 13:407–432
 Kirschbaum, D.S. 28:325
 Kliewer, W.M., 14:407
 Knight, R.J., 19:xiii
 Knox, R.B., 12:1
 Kofranek, A.M., 8:xi
 Korcak, R.F., 9:133; 10:183
 Kozai, T., 17:125
 Krezdorn, A.H., 1:vii
 Kushad, M.M., 28:125
- Lakso, A.N., 7:301; 11:111
 Laimer, M., 28:187
 Lamb, R.C., 15:xiii
 Lang, G.A., 13:339
 Larsen, R.P., 9:xi
 Larson, R.A., 7:399
 Layne, D.R., 31:351
 Leal, F., 21:133
 Ledbetter, C.A., 11:159
 Lee, J.-M., 28:61
 Levy, Y., 30:37
 Li, P.H., 6:373
 Lill, R.E., 11:413
 Lin, S., 23:233
 Liu, Z., 27:41
 Lipton, W.J., 12:69
 Littlejohn, G.M., 26:1
 Litz, R.E., 7:157
 Lockard, R.G., 3:315
 Loescher, W.H., 6:198
 Lorenz, O.A., 1:79
 Lu, R., 20:1
 Luby, J.J., 29:1
 Lurie, S., 22:91–121
 Lyrene, P., 21:xi
- Maguire, K.M., 25:197
 Malik, A.U., 31:113
 Manivel, L., 22:267
 Maraffa, S.B., 2:268
 Marangoni, A.G., 17:203; 30:317
 Marini, R.P., 9:351
 Marinoni, D.T., 31:293
 Marlow, G.C., 6:189

- Maronek, D.M., 3:172
 Martin, G.G., 13:339
 Masiunas, J., 28:125
 Mayak, S., 1:204; 3:59
 Maynard, D.N., 1:79
 McConchie, R., 17:173
 McConnell, D.B., 31:47
 McNicol, R.J., 16:255
 Merkle, S.A., 14:265
 Michailides, T.J., 12:409
 Michelson, E., 17:381
 Mika, A., 8:339
 Miller, A.R., 25:171
 Miller, S.S., 10:309
 Mills, H.A., 2:411; 9:103
 Mills, T.M., 21:105
 Mitchell, C.A., 17:1
 Mizrahi, Y., 18:291, 321
 Mohankumar, C.R., 30:355
 Molnar, J.M., 9:1
 Monk, G.J., 9:1
 Monselise, S.P., 4:128
 Moore, G.A., 7:157
 Mor, Y., 9:53
 Morris, J.R., 16:255
 Mu, D., 30:115
 Murashige, T., 1:1
 Murr, D.P., 23:69
 Murray, S.H., 20:121
 Myers, P.N., 17:1

 Nadeau, J.A., 19:1
 Nascimento, W.M., 24:229
 Neilsen, G.H., 9:377
 Nelson, P.V., 26:xi
 Nerd, A., 18:291, 321
 Niemiera, A.X., 9:75
 Nobel, P.S., 18:291
 Norman, D.J., 31:47
 Nyujtò, F., 22:225

 Oda, M., 28:61
 O'Donoghue, E.M., 11:413
 Ogden, R.J., 9:103
 O'Hair, S.K., 8:43; 12:157
 Oliveira, C.M., 10:403
 Oliver, M.J., 18:171
 O'Neill, S.D., 19:1
 Opara, L.U., 19:217; 24:373; 25:197
 Ormrod, D.P., 8:1

 Ortiz, R., 27:79

 Palser, B.F., 12:1
 Papadopoulos, A.P., 21:1; 26:239; 30:163
 Pararajasingham, S., 21:1
 Parera, C.A., 16:109
 Paris, H.S., 25:71
 Pegg, K.G., 17:299
 Pellett, H.M., 3:144
 Perkins-Veazil, P., 17:267
 Pichersky, E., 24:31
 Piechulla, B., 24:31
 Ploetz, R.C., 13:257
 Pokorny, F.A., 9:103
 Pomper, K.W., 31:351
 Poole, R.T., 5:317; 6:119
 Poovaiah, B.W., 10:107
 Portas, C.A.M., 19:99
 Porter, M.A., 7:345
 Possingham, J.V., 16:235
 Prange, R.K., 23:69
 Pratt, C., 10:273; 12:265
 Predieri, S., 28:237
 Preece, J.E., 14:265
 Priestley, C.A., 10:403
 Proctor, J.T.A., 9:187
 Puonti-Kaerlas, J., 26:85
 Puterka, G.J., 31:1

 Qu, D., 30:115
 Quamme, H., 18:xiii

 Raese, J.T., 11:357
 Ramming, D.W., 11:159
 Rapparini, F., 28:237
 Ravi, V., 23:277; 30:355
 Reddy, A.S.N., 10:107
 Redgwell, R.J., 20:121
 Reid, M., 12:xiii; 17:123
 Reuveni, M., 16:33
 Richards, D., 5:127
 Rieger, M., 11:45
 Roper, T.R., 21:215
 Rosa, E.A.S., 19:99
 Roth-Bejerano, N., 16:71
 Roubelakis-Angelakis, K.A., 14:407
 Rouse, J.L., 12:1
 Royse, D.J., 19:59
 Rudnicki, R.M., 10:35
 Ryder, E.J., 2:164; 3:vii

- Sachs, R., 12:xiii
Sakai, A., 6:357
Salisbury, F.B., 4:66; 15:233
Salova, T. H., 29:305
Saltveit, M.E., 23:x; 23:185
San Antonio, J.P., 6:85
Sankhla, N., 10:63; 24:55
Saure, M.C., 7:239
Schaffer, B., 13:257
Schenk, M.K., 22:185
Schneider, G.W., 3:315
Schneider, K.R., 30:185
Schuster, M.L., 3:28
Scorza, R., 4:106
Scott, J.W., 6:25
Sedgley, M., 12:223; 22:1; 25:235
Seeley, S.S., 15:97
Serrano Marquez, C., 15:183
Sharp, W.R., 2:268; 3:214
Sharpe, R.H., 23:233
Shattuck, V.I., 14:199
Shear, C.B., 2:142
Sheehan, T.J., 5:279
Shipp, J.L., 21:1
Shirra, M., 20:267
Shorey, H.H., 12:409
Simon, J.E., 19:319
Singh, Z. 27:189; 31:113
Sklenksy, D.E., 15:335
Smith, A.H., Jr., 28:351
Smith, M.A.L., 28:125
Smith, G.S., 12:307
Smock, R.M., 1:301
Sommer, N.F., 3:412
Sondahl, M.R., 2:268
Sopp, P.I., 13:1
Soule, J., 4:247
Sozzi, G. O., 27:125
Sparks, D., 8:217
Splittstoesser, W.E., 6:25; 13:105
Spooner, D.M., 28:1
Srinivasan, C., 7:157
Stang, E.J., 16:255
Steffens, G.L., 10:63
Stern, R.A., 28:393
Stevens, M.A., 4:vii
Stroshine, R.L., 20:1
Struik, P.C., 14:89
Studman, C.J., 19:217
Stutte, G.W., 13:339
Styer, D.J., 5:221
Sunderland, K.D., 13:1
Sung, Y., 24:229
Surányi, D., 19:263; 22:225; 23:179
Swanson, B., 12:xiii
Swietlik, D., 6:287; 23:109
Syvertsen, J.P., 7:301, 30:37
Talcott, S.T., 30:185
Tattini, M., 21:177
Tétényi, P., 19:373
Theron, K.I., 25:1
Tibbitts, T.W., 4:49
Timon, B., 17:331
Tindall, H.D., 16:143
Tisserat, B., 1:1
Titus, J.S., 4:204
Trigiano, R.N., 14:265
Tunya, G.O., 13:105
Turekhanova, P.M., 29:305
Upchurch, B.L., 20:1
Valenzuela, H.R., 24:139
van den Berg, W.L.A., 28:1
van Doorn, W.G., 17:173; 18:1
Van Iepersen, W., 30: 163
van Kooten, O., 23:69
van Nocker, S. 27:1
Veilleux, R.E., 14:239
Vorsa, N., 21:215
Vizzotto, G., 28: 351
Wallace, A., 15:413
Wallace, D.H., 17:73
Wallace, G.A., 15:413
Wang, C.Y., 15:63
Wang, L., 30:115
Wang, S.Y., 14:333
Wann, S.R., 10:153
Watkins, C.B., 11:289
Watson, G.W., 15:1
Webster, B.D., 1:172; 13:xi
Weichmann, J., 8:101
Wetzstein, H.Y., 8:217
Whiley, A.W., 17:299
Whitaker, T.W., 2:164
White, J.W., 1:141
Williams, E.G., 12:1
Williams, M.W., 1:270

Wismer, W.V., 17:203

Wittwer, S.H., 6:xi

Woodson, W.R., 11:15

Wright, R.D., 9:75

W_nsche, J.N., 31:233

Wutscher, H.K., 1:237

Xu, C., 30:83.

Yada, R.Y., 17:203; 30:317

Yadava, U.L., 2:1

Yahia, E.M., 16:197; 22:123

Yan, W., 17:73

Yarborough, D.E., 16:255

Yelenosky, G., 7:201

Zanini, E., 16:71

Zhang, B., 30:83

Zieslin, N., 9:53

Zimmerman, R.H., 5:vii; 9:273

Ziv, M., 24:1

Zucconi, F., 11:1

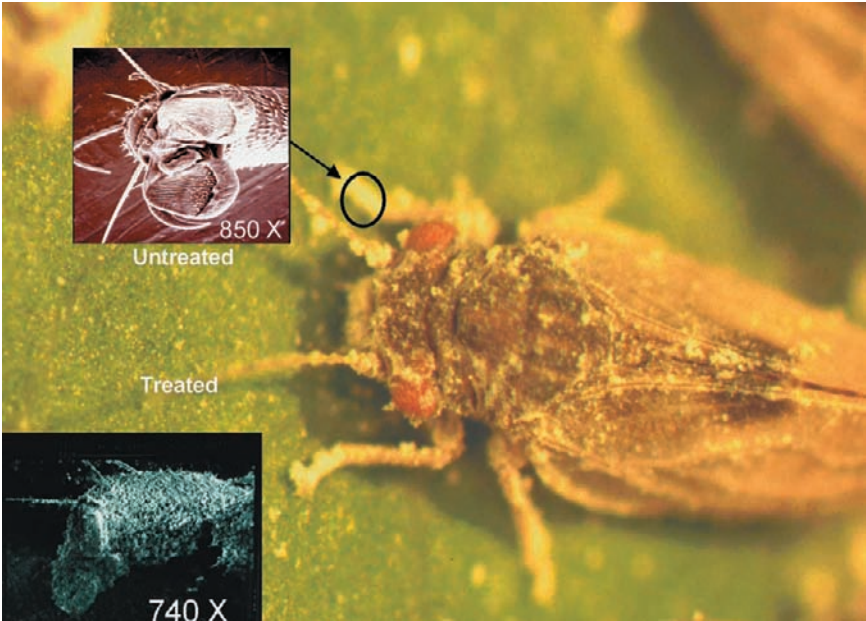

Plate 1. Top. Particle film of Surround® WP Crop protectant on apple fruit and leaves. Bottom. Pear psylla adult becomes coated with kaolin particles after exposure to particle film treated apple for 10 minutes.

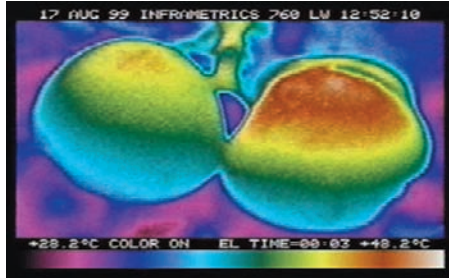
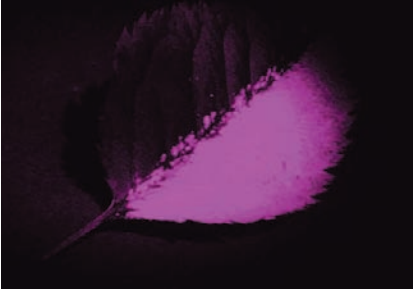

Plate 2. Top. (left) Particle film, Surround® WP, applications to dormant pear trees prior to bloom to prevent over-wintering pear psylla adults ovipositing. (right) Glassy-winged sharpshooter feeding on grape can transmit Pierce's disease caused by the bacterium, *Xylella fastidiosa*. Middle. (left) An apple leaf with and without Surround® WP under UV radiation, (right) under visible light. Bottom. (left) Treated and untreated apples and (right) thermal infrared images at solar noon.