

**COMPLETE SOLUTIONS  
MANUAL FOR**

**ZILL'S  
A FIRST COURSE IN  
DIFFERENTIAL  
EQUATIONS**

**WITH MODELING APPLICATIONS**

**7TH EDITION**

**AND**

**ZILL & CULLEN'S  
DIFFERENTIAL  
EQUATIONS**

**WITH BOUNDARY-VALUE PROBLEMS**

**5TH EDITION**

**WARREN S. WRIGHT**

*Loyola Marymount University*

**CAROL D. WRIGHT**

**BROOKS/COLE**

**THOMSON LEARNING**

Australia • Canada • Mexico • Singapore • Spain • United Kingdom • United States



# Table of Contents

1	Introduction to Differential Equations	1
2	First-Order Differential Equations	22
3	Modeling with First-Order Differential Equations	71
4	Higher-Order Differential Equations	104
5	Modeling with Higher-Order Differential Equations	194
6	Series Solutions of Linear Equations	240
7	The Laplace Transform	308
8	Systems of Linear First-Order Differential Equations	370
9	Numerical Solutions of Ordinary Differential Equations	430
10	Plane Autonomous Systems and Stability	458
11	Orthogonal Functions and Fourier Series	491
12	Partial Differential Equations and Boundary-Value Problems in Rectangular Coordinates	538
13	Boundary-Value Problems in Other Coordinate Systems	616
14	Integral Transform Method	654
15	Numerical Solutions of Partial Differential Equations	695
<b>Appendix I</b>	<b>Gamma function</b>	<b>717</b>
<b>Appendix II</b>	<b>Introduction to Matrices</b>	<b>718</b>





# 1 Introduction to Differential Equations

---

## Exercises 1.1

---

1. Second-order; linear.
2. Third-order; nonlinear because of  $(dy/dx)^4$ .
3. The differential equation is first-order. Writing it in the form  $x(dy/dx) + y^2 = 1$ , we see that it is nonlinear in  $y$  because of  $y^2$ . However, writing it in the form  $(y^2 - 1)(dx/dy) + x = 0$ , we see that it is linear in  $x$ .
4. The differential equation is first-order. Writing it in the form  $u(dv/du) + (1 + u)v = ue^u$  we see that it is linear in  $v$ . However, writing it in the form  $(v + uv - ue^u)(du/dv) + u = 0$ , we see that it is nonlinear in  $u$ .
5. Fourth-order; linear
6. Second-order; nonlinear because of  $\cos(r + u)$
7. Second-order; nonlinear because of  $\sqrt{1 + (dy/dx)^2}$
8. Second-order; nonlinear because of  $1/R^2$
9. Third-order; linear
10. Second-order; nonlinear because of  $\dot{x}^2$
11. From  $y = e^{-x/2}$  we obtain  $y' = -\frac{1}{2}e^{-x/2}$ . Then  $2y' + y = -e^{-x/2} + e^{-x/2} = 0$ .
12. From  $y = \frac{6}{5} - \frac{6}{5}e^{-20t}$  we obtain  $dy/dt = 24e^{-20t}$ , so that

$$\frac{dy}{dt} + 20y = 24e^{-20t} + 20\left(\frac{6}{5} - \frac{6}{5}e^{-20t}\right) = 24.$$

13. From  $y = e^{3x} \cos 2x$  we obtain  $y' = 3e^{3x} \cos 2x - 2e^{3x} \sin 2x$  and  $y'' = 5e^{3x} \cos 2x - 12e^{3x} \sin 2x$ , so that  $y'' - 6y' + 13y = 0$ .
14. From  $y = -\cos x \ln(\sec x + \tan x)$  we obtain  $y' = -1 + \sin x \ln(\sec x + \tan x)$  and  $y'' = \tan x + \cos x \ln(\sec x + \tan x)$ . Then  $y'' + y = \tan x$ .

### Exercises 1.1

15. Writing  $\ln(2X - 1) - \ln(X - 1) = t$  and differentiating implicitly we obtain

$$\begin{aligned} \frac{2}{2X-1} \frac{dX}{dt} - \frac{1}{X-1} \frac{dX}{dt} &= 1 \\ \left( \frac{2}{2X-1} - \frac{1}{X-1} \right) \frac{dX}{dt} &= 1 \\ \frac{2X-2-2X+1}{(2X-1)(X-1)} \frac{dX}{dt} &= 1 \\ \frac{dX}{dt} &= -(2X-1)(X-1) = (X-1)(1-2X). \end{aligned}$$

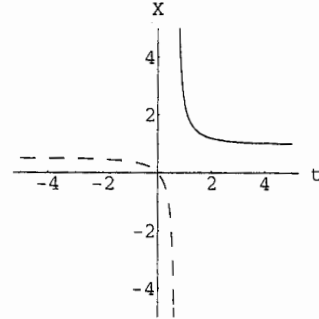

Exponentiating both sides of the implicit solution we obtain

$$\frac{2X-1}{X-1} = e^t \implies 2X-1 = Xe^t - e^t \implies (e^t - 1) = (e^t - 2)X \implies X = \frac{e^t - 1}{e^t - 2}.$$

Solving  $e^t - 2 = 0$  we get  $t = \ln 2$ . Thus, the solution is defined on  $(-\infty, \ln 2)$  or on  $(\ln 2, \infty)$ . The graph of the solution defined on  $(-\infty, \ln 2)$  is dashed, and the graph of the solution defined on  $(\ln 2, \infty)$  is solid.

16. Implicitly differentiating the solution we obtain

$$\begin{aligned} -2x^2 \frac{dy}{dx} - 4xy + 2y \frac{dy}{dx} &= 0 \implies -x^2 dy - 2xy dx + y dy = 0 \\ \implies 2xy dx + (x^2 - y) dy &= 0. \end{aligned}$$

Using the quadratic formula to solve  $y^2 - 2x^2y - 1 = 0$  for  $y$ , we get  $y = (2x^2 \pm \sqrt{4x^4 + 4})/2 = x^2 \pm \sqrt{x^4 + 1}$ . Thus, two explicit solutions are  $y_1 = x^2 + \sqrt{x^4 + 1}$  and  $y_2 = x^2 - \sqrt{x^4 + 1}$ . Both solutions are defined on  $(-\infty, \infty)$ . The graph of  $y_1(x)$  is solid and the graph of  $y_2$  is dashed.

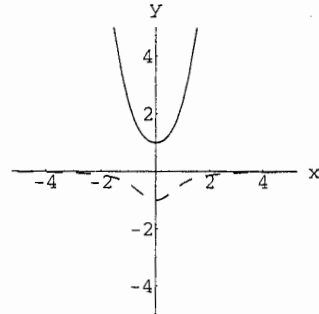

17. Differentiating  $P = c_1 e^t / (1 + c_1 e^t)$  we obtain

$$\begin{aligned} \frac{dP}{dt} &= \frac{(1 + c_1 e^t) c_1 e^t - c_1 e^t \cdot c_1 e^t}{(1 + c_1 e^t)^2} \\ &= \frac{c_1 e^t}{1 + c_1 e^t} \frac{[(1 + c_1 e^t) - c_1 e^t]}{1 + c_1 e^t} = P(1 - P). \end{aligned}$$

18. Differentiating  $y = e^{-x^2} \int_0^x e^{t^2} dt + c_1 e^{-x^2}$  we obtain

$$y' = e^{-x^2} e^{x^2} - 2xe^{-x^2} \int_0^x e^{t^2} dt - 2c_1 x e^{-x^2} = 1 - 2xe^{-x^2} \int_0^x e^{t^2} dt - 2c_1 x e^{-x^2}.$$

Substituting into the differential equation, we have

$$y' + 2xy = 1 - 2xe^{-x^2} \int_0^x e^{t^2} dt - 2c_1xe^{-x^2} + 2xe^{-x^2} \int_0^x e^{t^2} dt + 2c_1xe^{-x^2} = 1.$$

19. From  $y = c_1e^{2x} + c_2xe^{2x}$  we obtain  $\frac{dy}{dx} = (2c_1 + c_2)e^{2x} + 2c_2xe^{2x}$  and  $\frac{d^2y}{dx^2} = (4c_1 + 4c_2)e^{2x} + 4c_2xe^{2x}$ , so that

$$\frac{d^2y}{dx^2} - 4\frac{dy}{dx} + 4y = (4c_1 + 4c_2 - 8c_1 - 4c_2 + 4c_1)e^{2x} + (4c_2 - 8c_2 + 4c_2)xe^{2x} = 0.$$

20. From  $y = c_1x^{-1} + c_2x + c_3x \ln x + 4x^2$  we obtain

$$\frac{dy}{dx} = -c_1x^{-2} + c_2 + c_3 + c_3 \ln x + 8x,$$

$$\frac{d^2y}{dx^2} = 2c_1x^{-3} + c_3x^{-1} + 8,$$

and

$$\frac{d^3y}{dx^3} = -6c_1x^{-4} - c_3x^{-2},$$

so that

$$\begin{aligned} x^3 \frac{d^3y}{dx^3} + 2x^2 \frac{d^2y}{dx^2} - x \frac{dy}{dx} + y &= (-6c_1 + 4c_1 + c_1 + c_1)x^{-1} + (-c_3 + 2c_3 - c_2 - c_3 + c_2)x \\ &\quad + (-c_3 + c_3)x \ln x + (16 - 8 + 4)x^2 \\ &= 12x^2. \end{aligned}$$

21. (a) From  $\phi_1 = x^2$  we obtain  $\phi_1' = 2x$ , so

$$x\phi_1' - 2\phi_1 = x(2x) - 2x^2 = 0.$$

From  $\phi_2 = -x^2$  we obtain  $\phi_2' = -2x$ , so

$$x\phi_2' - 2\phi_2 = x(-2x) - 2(-x^2) = 0.$$

Thus,  $\phi_1$  and  $\phi_2$  are solutions of the differential equation on  $(-\infty, \infty)$ .

- (b) From  $y = \begin{cases} -x^2, & x < 0 \\ x^2, & x \geq 0 \end{cases}$  we obtain  $y' = \begin{cases} -2x, & x < 0 \\ 2x, & x \geq 0 \end{cases}$  so that  $xy' - 2y = 0$ .

22. The function  $y(x)$  is not continuous at  $x = 0$  since  $\lim_{x \rightarrow 0^-} y(x) = 5$  and  $\lim_{x \rightarrow 0^+} y(x) = -5$ . Thus,  $y'(x)$  does not exist at  $x = 0$ .

23. (a) The domain of the function, found by solving  $x + 3 \geq 0$ , is  $[-3, \infty)$ .

### Exercises 1.1

(b) From  $y' = 1 + (x + 3)^{-1/2}$  we have

$$\begin{aligned}(y - x)y' - y + x - 2 &= [x + 2\sqrt{x + 3} - x][1 + (1 + (x - 3)^{-1/2}) \\ &\quad - [x + 2\sqrt{x + 3}] + x - 2 \\ &= 2\sqrt{x + 3} + 2 - x - 2\sqrt{x + 3} + x - 2 = 0.\end{aligned}$$

Since  $y(x)$  is not differentiable at  $x = -3$ ,  $y$  is a solution of the differential equation on  $(-3, \infty)$ .

24. (a) An interval on which  $\tan 5t$  is continuous is  $-\pi/2 < 5t < \pi/2$ , so  $5 \tan 5t$  will be a solution on  $(-\pi/10, \pi/10)$ .

(b) For  $(1 - \sin t)^{-1/2}$  to be continuous we must have  $1 - \sin t > 0$  or  $\sin t < 1$ . Thus,  $(1 - \sin t)^{-1/2}$  will be a solution on  $(\pi/2, 5\pi/2)$ .

25. (a) From  $y = e^{mt}$  we obtain  $y' = me^{mt}$ . Then  $y' + 2y = 0$  implies

$$me^{mt} + 2e^{mt} = (m + 2)e^{mt} = 0.$$

Since  $e^{mt} > 0$  for all  $t$ ,  $m = -2$ . Thus  $y = e^{-2t}$  is a solution.

(b) From  $y = e^{mt}$  we obtain  $y' = me^{mt}$  and  $y'' = m^2e^{mt}$ . Then  $y'' - 5y' + 6y = 0$  implies

$$m^2e^{mt} - 5me^{mt} + 6e^{mt} = (m - 2)(m - 3)e^{mt} = 0.$$

Since  $e^{mt} > 0$  for all  $t$ ,  $m = 2$  and  $m = 3$ . Thus  $y = e^{2t}$  and  $y = e^{3t}$  are solutions.

26. (a) From  $y = t^m$  we obtain  $y' = mt^{m-1}$  and  $y'' = m(m - 1)t^{m-2}$ . Then  $ty'' + 2y' = 0$  implies

$$\begin{aligned}tm(m - 1)t^{m-2} + 2mt^{m-1} &= [m(m - 1) + 2m]t^{m-1} = (m^2 + m)t^{m-1} \\ &= m(m + 1)t^{m-1} = 0.\end{aligned}$$

Since  $t^{m-1} > 0$  for  $t > 0$ ,  $m = 0$  and  $m = -1$ . Thus  $y = 1$  and  $y = t^{-1}$  are solutions.

(b) From  $y = t^m$  we obtain  $y' = mt^{m-1}$  and  $y'' = m(m - 1)t^{m-2}$ . Then  $t^2y'' - 7ty' + 15y = 0$  implies

$$\begin{aligned}t^2m(m - 1)t^{m-2} - 7tmt^{m-1} + 15t^m &= [m(m - 1) - 7m + 15]t^m \\ &= (m^2 - 8m + 15)t^m = (m - 3)(m - 5)t^m = 0.\end{aligned}$$

Since  $t^m > 0$  for  $t > 0$ ,  $m = 3$  and  $m = 5$ . Thus  $y = t^3$  and  $y = t^5$  are solutions.

27. From  $x = e^{-2t} + 3e^{6t}$  and  $y = -e^{-2t} + 5e^{6t}$  we obtain

$$\frac{dx}{dt} = -2e^{-2t} + 18e^{6t} \quad \text{and} \quad \frac{dy}{dt} = 2e^{-2t} + 30e^{6t}.$$

Then

$$\begin{aligned}x + 3y &= (e^{-2t} + 3e^{6t}) + 3(-e^{-2t} + 5e^{6t}) \\ &= -2e^{-2t} + 18e^{6t} = \frac{dx}{dt}\end{aligned}$$

and

Exercises 1.1

$$\begin{aligned} 5x + 3y &= 5(e^{-2t} + 3e^{6t}) + 3(-e^{-2t} + 5e^{6t}) \\ &= 2e^{-2t} + 30e^{6t} = \frac{dy}{dt}. \end{aligned}$$

28. From  $x = \cos 2t + \sin 2t + \frac{1}{5}e^t$  and  $y = -\cos 2t - \sin 2t - \frac{1}{5}e^t$  we obtain

$$\frac{dx}{dt} = -2\sin 2t + 2\cos 2t + \frac{1}{5}e^t \quad \text{and} \quad \frac{dy}{dt} = 2\sin 2t - 2\cos 2t - \frac{1}{5}e^t$$

and

$$\frac{d^2x}{dt^2} = -4\cos 2t - 4\sin 2t + \frac{1}{5}e^t \quad \text{and} \quad \frac{d^2y}{dt^2} = 4\cos 2t + 4\sin 2t - \frac{1}{5}e^t.$$

Then

$$\begin{aligned} 4y + e^t &= 4(-\cos 2t - \sin 2t - \frac{1}{5}e^t) + e^t \\ &= -4\cos 2t - 4\sin 2t + \frac{1}{5}e^t = \frac{d^2x}{dt^2} \end{aligned}$$

and

$$\begin{aligned} 4x - e^t &= 4(\cos 2t + \sin 2t + \frac{1}{5}e^t) - e^t \\ &= 4\cos 2t + 4\sin 2t - \frac{1}{5}e^t = \frac{d^2y}{dt^2}. \end{aligned}$$

29.  $(y')^2 + 1 = 0$  has no real solution.

30. The only solution of  $(y')^2 + y^2 = 0$  is  $y = 0$ , since if  $y \neq 0$ ,  $y^2 > 0$  and  $(y')^2 + y^2 \geq y^2 > 0$ .

31. The first derivative of  $f(t) = e^t$  is  $e^t$ . The first derivative of  $f(t) = e^{kt}$  is  $ke^{kt}$ . The differential equations are  $y' = y$  and  $y' = ky$ , respectively.

32. Any function of the form  $y = ce^t$  or  $y = ce^{-t}$  is its own second derivative. The corresponding differential equation is  $y'' - y = 0$ . Functions of the form  $y = c\sin t$  or  $y = c\cos t$  have second derivatives that are the negatives of themselves. The differential equation is  $y'' + y = 0$ .

33. Since the  $n$ th derivative of  $\phi(x)$  must exist if  $\phi(x)$  is a solution of the  $n$ th order differential equation, all lower-order derivatives of  $\phi(x)$  must exist and be continuous. [Recall that a differentiable function is continuous.]

34. Solving the system

$$c_1y_1(0) + c_2y_2(0) = 2$$

$$c_1y_1'(0) + c_2y_2'(0) = 0$$

for  $c_1$  and  $c_2$  we get

$$c_1 = \frac{2y_2'(0)}{y_1(0)y_2'(0) - y_1'(0)y_2(0)} \quad \text{and} \quad c_2 = -\frac{2y_1'(0)}{y_1(0)y_2'(0) - y_1'(0)y_2(0)}.$$

## Exercises 1.1

Thus, a particular solution is

$$y = \frac{2y_2'(0)}{y_1(0)y_2'(0) - y_1'(0)y_2(0)} y_1 - \frac{2y_1'(0)}{y_1(0)y_2'(0) - y_1'(0)y_2(0)} y_2,$$

where we assume that  $y_1(0)y_2'(0) - y_1'(0)y_2(0) \neq 0$ .

35. For the first-order differential equation integrate  $f(x)$ . For the second-order differential equation integrate twice. In the latter case we get  $y = \int(\int f(t)dt)dt + c_1t + c_2$ .
36. Solving for  $y'$  using the quadratic formula we obtain the two differential equations

$$y' = \frac{1}{t} \left( 2 + 2\sqrt{1 + 3t^6} \right) \quad \text{and} \quad y' = \frac{1}{t} \left( 2 - 2\sqrt{1 + 3t^6} \right),$$

so the differential equation cannot be put in the form  $dy/dt = f(t, y)$ .

37. The differential equation  $yy' - ty = 0$  has normal form  $dy/dt = t$ . These are not equivalent because  $y = 0$  is a solution of the first differential equation but not a solution of the second.
38. Differentiating we get  $y' = c_1 + 3c_2t^2$  and  $y'' = 6c_2t$ . Then  $c_2 = y''/6t$  and  $c_1 = y' - ty''/2$ , so

$$y = \left( y' - \frac{ty''}{2} \right) t + \left( \frac{y''}{6t} \right) t^3 = ty' - \frac{1}{3}t^2y''$$

and the differential equation is  $t^2y'' - 3ty' + 3y = 0$ .

39. When  $g(t) = 0$ ,  $y = 0$  is a solution of a linear equation.
40. (a) Solving  $(10 - 5y)/3x = 0$  we see that  $y = 2$  is a constant solution.
- (b) Solving  $y^2 + 2y - 3 = (y + 3)(y - 1) = 0$  we see that  $y = -3$  and  $y = 1$  are constant solutions.
- (c) Since  $1/(y - 1) = 0$  has no solutions, the differential equation has no constant solutions.
- (d) Setting  $y' = 0$  we have  $y'' = 0$  and  $6y = 10$ . Thus  $y = 5/3$  is a constant solution.
41. One solution is given by the upper portion of the graph with domain approximately  $(0, 2.6)$ . The other solution is given by the lower portion of the graph, also with domain approximately  $(0, 2.6)$ .
42. One solution, with domain approximately  $(-\infty, 1.6)$  is the portion of the graph in the second quadrant together with the lower part of the graph in the first quadrant. A second solution, with domain approximately  $(0, 1.6)$  is the upper part of the graph in the first quadrant. The third solution, with domain  $(0, \infty)$ , is the part of the graph in the fourth quadrant.

Exercises 1.1

43. Differentiating  $(x^3 + y^3)/xy = 3c$  we obtain

$$\frac{xy(3x^2 + 3y^2y') - (x^3 + y^3)(xy' + y)}{x^2y^2} = 0$$

$$3x^3y + 3xy^3y' - x^4y' - x^3y - xy^3y' - y^4 = 0$$

$$(3xy^3 - x^4 - xy^3)y' = -3x^3y + x^3y + y^4$$

$$y' = \frac{y^4 - 2x^3y}{2xy^3 - x^4} = \frac{y(y^3 - 2x^3)}{x(2y^3 - x^3)}$$

44. A tangent line will be vertical where  $y'$  is undefined, or in this case, where  $x(2y^3 - x^3) = 0$ . This gives  $x = 0$  and  $2y^3 = x^3$ . Substituting  $y^3 = x^3/2$  into  $x^3 + y^3 = 3xy$  we get

$$x^3 + \frac{1}{2}x^3 = 3x \left( \frac{1}{2^{1/3}} x \right)$$

$$\frac{3}{2}x^3 = \frac{3}{2^{1/3}}x^2$$

$$x^3 = 2^{2/3}x^2$$

$$x^2(x - 2^{2/3}) = 0.$$

Thus, there are vertical tangent lines at  $x = 0$  and  $x = 2^{2/3}$ , or at  $(0, 0)$  and  $(2^{2/3}, 2^{1/3})$ . Since  $2^{2/3} \approx 1.59$ , the estimates of the domains in Problem 42 were close.

45. Since  $\phi'(x) > 0$  for all  $x$  in  $I$ ,  $\phi(x)$  is an increasing function on  $I$ . Hence, it can have no relative extrema on  $I$ .
46. (a) When  $y = 5$ ,  $y' = 0$ , so  $y = 5$  is a solution of  $y' = 5 - y$ .
- (b) When  $y > 5$ ,  $y' < 0$ , and the solution must be decreasing. When  $y < 5$ ,  $y' > 0$ , and the solution must be increasing. Thus, none of the curves in color can be solutions.

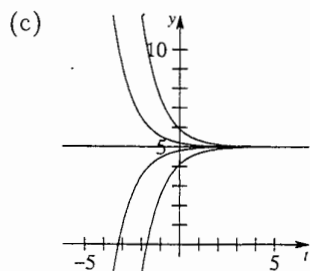

47. (a)  $y = 0$  and  $y = a/b$ .
- (b) Since  $dy/dx = y(a - by) > 0$  for  $0 < y < a/b$ ,  $y = \phi(x)$  is increasing on this interval. Since  $dy/dx < 0$  for  $y < 0$  or  $y > a/b$ ,  $y = \phi(x)$  is decreasing on these intervals.

## Exercises 1.1

(c) Using implicit differentiation we compute

$$\frac{d^2y}{dx^2} = y(-by') + y'(a - by) = y'(a - 2by).$$

Solving  $d^2y/dx^2 = 0$  we obtain  $y = a/2b$ . Since  $d^2y/dx^2 > 0$  for  $0 < y < a/2b$  and  $d^2y/dx^2 < 0$  for  $a/2b < y < a/b$ , the graph of  $y = \phi(x)$  has a point of inflection at  $y = a/2b$ .

(d)

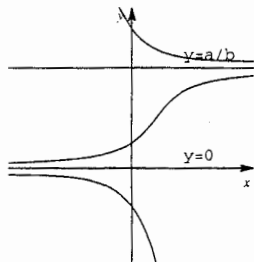

48. The family of parabolas is plotted using  $c_1 = \pm 1, \pm 4, \pm 10$ . The ellipses are plotted using  $c_2 = 1, 2, 3$ . It appears from the figure that the parabolas and ellipses intersect at right angles. To verify this we note that the first differential equation can be written in the form  $dy/dx = y/2x$  and the second in the form  $dy/dx = -2x/y$ . Thus, at a point of intersection, the slopes of tangent lines are negative reciprocals of each other, and the two tangent lines are perpendicular.

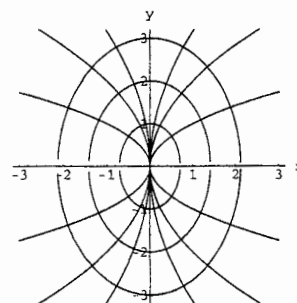

49. In *Mathematica* use

```
Clear[y]
y[x_]:= x Exp[5x] Cos[2x]
y[x]
y''''[x] - 20 y'''[x] + 158 y''[x] - 580 y'[x] + 841 y[x] // Simplify
```

50. In *Mathematica* use

```
Clear[y]
y[x_]:= 20 Cos[5 Log[x]]/x - 3 Sin[5 Log[x]]/x
y[x]
x^3 y''''[x] + 2x^2 y'''[x] + 20 x y'[x] - 78 y[x] // Simplify
```



---

**Exercises 1.2**

---

- Solving  $-\frac{1}{3} = \frac{1}{1+c_1}$  we get  $c_1 = -4$ . The solution is  $y = \frac{1}{1-4e^{-t}}$ .
- Solving  $2 = \frac{1}{1+c_1e}$  we get  $c_1 = -\frac{1}{2}e^{-1}$ . The solution is  $y = \frac{2}{2-e^{-(t+1)}}$ .
- Using  $x' = -c_1 \sin t + c_2 \cos t$  we obtain  $c_1 = -1$  and  $c_2 = 8$ . The solution is  $x = -\cos t + 8 \sin t$ .
- Using  $x' = -c_1 \sin t + c_2 \cos t$  we obtain  $c_2 = 0$  and  $-c_1 = 1$ . The solution is  $x = -\cos t$ .
- Using  $x' = -c_1 \sin t + c_2 \cos t$  we obtain

$$\begin{aligned}\frac{\sqrt{3}}{2}c_1 + \frac{1}{2}c_2 &= \frac{1}{2} \\ -\frac{1}{2}c_1 + \frac{\sqrt{3}}{2}c_2 &= 0.\end{aligned}$$

Solving we find  $c_1 = \frac{\sqrt{3}}{4}$  and  $c_2 = \frac{1}{4}$ . The solution is  $x = \frac{\sqrt{3}}{4} \cos t + \frac{1}{4} \sin t$ .

- Using  $x' = -c_1 \sin t + c_2 \cos t$  we obtain

$$\begin{aligned}\frac{\sqrt{2}}{2}c_1 + \frac{\sqrt{2}}{2}c_2 &= \sqrt{2} \\ -\frac{\sqrt{2}}{2}c_1 + \frac{\sqrt{2}}{2}c_2 &= 2\sqrt{2}.\end{aligned}$$

Solving we find  $c_1 = -1$  and  $c_2 = 3$ . The solution is  $x = -\cos t + 3 \sin t$ .

- From the initial conditions we obtain the system

$$\begin{aligned}c_1 + c_2 &= 1 \\ c_1 - c_2 &= 2.\end{aligned}$$

Solving we get  $c_1 = \frac{3}{2}$  and  $c_2 = -\frac{1}{2}$ . A solution of the initial-value problem is  $y = \frac{3}{2}e^x - \frac{1}{2}e^{-x}$ .

- From the initial conditions we obtain the system

$$\begin{aligned}c_1e + c_2e^{-1} &= 0 \\ c_1e - c_2e^{-1} &= e.\end{aligned}$$

Solving we get  $c_1 = \frac{1}{2}$  and  $c_2 = -\frac{1}{2}e^2$ . A solution of the initial-value problem is  $y = \frac{1}{2}e^x - \frac{1}{2}e^{2-x}$ .

- From the initial conditions we obtain

$$\begin{aligned}c_1e^{-1} + c_2e &= 5 \\ c_1e^{-1} - c_2e &= -5.\end{aligned}$$

Solving we get  $c_1 = 0$  and  $c_2 = 5e^{-1}$ . A solution of the initial-value problem is  $y = 5e^{-x-1}$ .

## Exercises 1.2

10. From the initial conditions we obtain

$$c_1 + c_2 = 0$$

$$c_1 - c_2 = 0.$$

Solving we get  $c_1 = c_2 = 0$ . A solution of the initial-value problem is  $y = 0$ .

11. Two solutions are  $y = 0$  and  $y = x^3$ .
12. Two solutions are  $y = 0$  and  $y = x^2$ . (Also, any constant multiple of  $x^2$  is a solution.)
13. For  $f(x, y) = y^{2/3}$  we have  $\frac{\partial f}{\partial y} = \frac{2}{3}y^{-1/3}$ . Thus the differential equation will have a unique solution in any rectangular region of the plane where  $y \neq 0$ .
14. For  $f(x, y) = \sqrt{xy}$  we have  $\frac{\partial f}{\partial y} = \frac{1}{2}\sqrt{\frac{x}{y}}$ . Thus the differential equation will have a unique solution in any region where  $x > 0$  and  $y > 0$  or where  $x < 0$  and  $y < 0$ .
15. For  $f(x, y) = \frac{y}{x}$  we have  $\frac{\partial f}{\partial y} = \frac{1}{x}$ . Thus the differential equation will have a unique solution in any region where  $x \neq 0$ .
16. For  $f(x, y) = x + y$  we have  $\frac{\partial f}{\partial y} = 1$ . Thus the differential equation will have a unique solution in the entire plane.
17. For  $f(x, y) = \frac{x^2}{4 - y^2}$  we have  $\frac{\partial f}{\partial y} = \frac{2x^2y}{(4 - y^2)^2}$ . Thus the differential equation will have a unique solution in any region where  $y < -2$ ,  $-2 < y < 2$ , or  $y > 2$ .
18. For  $f(x, y) = \frac{x^2}{1 + y^3}$  we have  $\frac{\partial f}{\partial y} = \frac{-3x^2y^2}{(1 + y^3)^2}$ . Thus the differential equation will have a unique solution in any region where  $y \neq -1$ .
19. For  $f(x, y) = \frac{y^2}{x^2 + y^2}$  we have  $\frac{\partial f}{\partial y} = \frac{2x^2y}{(x^2 + y^2)^2}$ . Thus the differential equation will have a unique solution in any region not containing  $(0, 0)$ .
20. For  $f(x, y) = \frac{y + x}{y - x}$  we have  $\frac{\partial f}{\partial y} = \frac{-2x}{(y - x)^2}$ . Thus the differential equation will have a unique solution in any region where  $y < x$  or where  $y > x$ .
21. The differential equation has a unique solution at  $(1, 4)$ .
22. The differential equation is not guaranteed to have a unique solution at  $(5, 3)$ .
23. The differential equation is not guaranteed to have a unique solution at  $(2, -3)$ .

## Exercises 1.2

24. The differential equation is not guaranteed to have a unique solution at  $(-1, 1)$ .
25. (a) A one-parameter family of solutions is  $y = cx$ . Since  $y' = c$ ,  $xy' = xc = y$  and  $y(0) = c \cdot 0 = 0$ .
- (b) Writing the equation in the form  $y' = y/x$  we see that  $R$  cannot contain any point on the  $y$ -axis. Thus, any rectangular region disjoint from the  $y$ -axis and containing  $(x_0, y_0)$  will determine an interval around  $x_0$  and a unique solution through  $(x_0, y_0)$ . Since  $x_0 = 0$  in part (a) we are not guaranteed a unique solution through  $(0, 0)$ .
- (c) The piecewise-defined function which satisfies  $y(0) = 0$  is not a solution since it is not differentiable at  $x = 0$ .
26. (a) Since  $\frac{d}{dx} \tan(x + c) = \sec^2(x + c) = 1 + \tan^2(x + c)$ , we see that  $y = \tan(x + c)$  satisfies the differential equation.
- (b) Solving  $y(0) = \tan c = 0$  we obtain  $c = 0$  and  $y = \tan x$ . Since  $\tan x$  is discontinuous at  $x = \pm\pi/2$ , the solution is not defined on  $(-2, 2)$  because it contains  $\pm\pi/2$ .
- (c) The largest interval on which the solution can exist is  $(-\pi/2, \pi/2)$ .
27. (a) Since  $\frac{d}{dt} \left( -\frac{1}{t+c} \right) = \frac{1}{(t+c)^2} = y^2$ , we see that  $y = -\frac{1}{t+c}$  is a solution of the differential equation.
- (b) Solving  $y(0) = -1/c = 1$  we obtain  $c = -1$  and  $y = 1/(1-t)$ . Solving  $y(0) = -1/c = -1$  we obtain  $c = 1$  and  $y = -1/(1+t)$ . Being sure to include  $t = 0$ , we see that the interval of existence of  $y = 1/(1-t)$  is  $(-\infty, 1)$ , while the interval of existence of  $y = -1/(1+t)$  is  $(-1, \infty)$ .
- (c) Solving  $y(0) = -1/c = y_0$  we obtain  $c = -1/y_0$  and
- $$y = -\frac{1}{-1/y_0 + t} = \frac{y_0}{1 - y_0 t}, \quad y_0 \neq 0.$$
- Since we must have  $-1/y_0 + t \neq 0$ , the largest interval of existence (which must contain 0) is either  $(-\infty, 1/y_0)$  when  $y_0 > 0$  or  $(1/y_0, \infty)$  when  $y_0 < 0$ .
- (d) By inspection we see that  $y = 0$  is a solution on  $(-\infty, \infty)$ .
28. (a) Differentiating  $3x^2 - y^2 = c$  we get  $6x - 2yy' = 0$  or  $yy' = 3x$ .

## Exercises 1.2

(b) Solving  $3x^2 - y^2 = 3$  for  $y$  we get

$$y = \phi_1(x) = \sqrt{3(x^2 - 1)}, \quad 1 < x < \infty,$$

$$y = \phi_2(x) = -\sqrt{3(x^2 - 1)}, \quad 1 < x < \infty,$$

$$y = \phi_3(x) = \sqrt{3(x^2 - 1)}, \quad -\infty < x < -1,$$

$$y = \phi_4(x) = -\sqrt{3(x^2 - 1)}, \quad -\infty < x < -1.$$

Only  $y = \phi_3(x)$  satisfies  $y(-2) = 3$ .

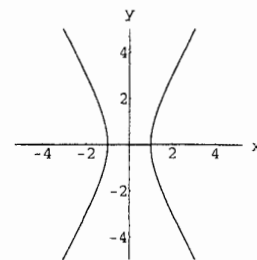

(c) Setting  $x = 2$  and  $y = -4$  in  $3x^2 - y^2 = c$  we get  $12 - 16 = -4 = c$ , so the explicit solution is

$$y = -\sqrt{3x^2 + 4}, \quad -\infty < x < \infty.$$

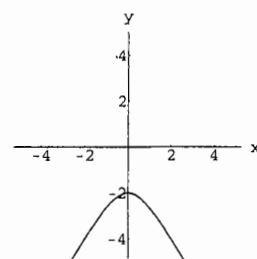

(d) Setting  $c = 0$  we have  $y = \sqrt{3}x$  and  $y = -\sqrt{3}x$ , both defined on  $(-\infty, \infty)$ .

29. When  $x = 0$  and  $y = \frac{1}{2}$ ,  $y' = -1$ , so the only plausible solution curve is the one with negative slope at  $(0, \frac{1}{2})$ , or the black curve.
30. The value of  $y' = dy/dx = f(x, y)$  is determined by  $f(x, y)$ , so it cannot be arbitrarily specified at  $x = x_0$ .
31. If the solution is tangent to the  $x$ -axis at  $(x_0, 0)$ , then  $y' = 0$  when  $x = x_0$  and  $y = 0$ . Substituting these values into  $y' + 2y = 3x - 6$  we get  $0 + 0 = 3x_0 - 6$  or  $x_0 = 2$ .
32. We look for the curve containing the point corresponding to the initial conditions.  
 (a) D      (b) A      (c) C      (d) C      (e) B      (f) A
33. The theorem guarantees a unique (meaning single) solution through any point. Thus, there cannot be two distinct solutions through any point.
34. The functions are the same on the interval  $(0, 4)$ , which is all that is required by Theorem 1.1.

### Exercises 1.3

35. From  $y' = 0$ , for  $y = x - 1$ , we see that solutions intersecting the line  $y = x - 1$  have horizontal tangent lines at the point of intersection. From  $y' > 0$ , for  $y > x - 1$ , we see that solutions above the line  $y = x - 1$  are increasing. From  $y' < 0$ , for  $y < x - 1$ , we see that solutions are decreasing below the line  $y = x - 1$ . From  $y'' = 0$ , for  $y = x$ , we see that solutions have possible inflection points on the line  $y = x$ . Actually,  $y = x$  is easily seen to be a solution of the differential equation, so the solutions do not have inflection points. From  $y'' > 0$  for  $y > x$  we see that solutions above the line  $y = x$  are concave up. From  $y'' < 0$  for  $y < x$  we see that solutions below the line  $y = x$  are concave down.

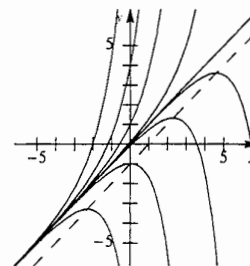

### Exercises 1.3

- $\frac{dP}{dt} = kP + r$ ;  $\frac{dP}{dt} = kP - r$
- Let  $b$  be the rate of births and  $d$  the rate of deaths. Then  $b = k_1P$  and  $d = k_2P$ . Since  $dP/dt = b - d$ , the differential equation is  $dP/dt = k_1P - k_2P$ .
- Let  $b$  be the rate of births and  $d$  the rate of deaths. Then  $b = k_1P$  and  $d = k_2P^2$ . Since  $dP/dt = b - d$ , the differential equation is  $dP/dt = k_1P - k_2P^2$ .
- Let  $P(t)$  be the number of owls present at time  $t$ . Then  $dP/dt = k(P - 200 + 10t)$ .
- From the graph we estimate  $T_0 = 180^\circ$  and  $T_m = 75^\circ$ . We observe that when  $T = 85$ ,  $dT/dt \approx -1$ . From the differential equation we then have

$$k = \frac{dT/dt}{T - T_m} = \frac{-1}{85 - 75} = -0.1.$$

- By inspecting the graph we take  $T_m$  to be  $T_m(t) = 80 - 30 \cos \pi t/12$ . Then the temperature of the body at time  $t$  is determined by the differential equation

$$\frac{dT}{dt} = k \left[ T - \left( 80 - 30 \cos \frac{\pi}{12} t \right) \right], \quad t > 0.$$

- The number of students with the flu is  $x$  and the number not infected is  $1000 - x$ , so  $dx/dt = kx(1000 - x)$ .
- By analogy with differential equation modeling the spread of a disease we assume that the rate at which the technological innovation is adopted is proportional to the number of people who have adopted the innovation and also to the number of people,  $y(t)$ , who have not yet adopted it. If one person who has adopted the innovation is introduced into the population then  $x + y = n + 1$  and

$$\frac{dx}{dt} = kx(n + 1 - x), \quad x(0) = 1.$$

### Exercises 1.3

9. The rate at which salt is leaving the tank is

$$(3 \text{ gal/min}) \cdot \left(\frac{A}{300} \text{ lb/gal}\right) = \frac{A}{100} \text{ lb/min.}$$

Thus  $dA/dt = A/100$ .

10. The rate at which salt is entering the tank is

$$R_1 = (3 \text{ gal/min}) \cdot (2 \text{ lb/gal}) = 6 \text{ lb/min.}$$

Since the solution is pumped out at a slower rate, it is accumulating at the rate of  $(3 - 2)\text{gal/min} = 1 \text{ gal/min}$ . After  $t$  minutes there are  $300 + t$  gallons of brine in the tank. The rate at which salt is leaving is

$$R_2 = (2 \text{ gal/min}) \cdot \left(\frac{A}{300 + t} \text{ lb/gal}\right) = \frac{2A}{300 + t} \text{ lb/min.}$$

The differential equation is

$$\frac{dA}{dt} = 6 - \frac{2A}{300 + t}.$$

11. The volume of water in the tank at time  $t$  is  $V = A_w h$ . The differential equation is then

$$\frac{dh}{dt} = \frac{1}{A_w} \frac{dV}{dt} = \frac{1}{A_w} (-cA_0 \sqrt{2gh}) = -\frac{cA_0}{A_w} \sqrt{2gh}.$$

Using  $A_0 = \pi \left(\frac{2}{12}\right)^2 = \frac{\pi}{36}$ ,  $A_w = 10^2 = 100$ , and  $g = 32$ , this becomes

$$\frac{dh}{dt} = -\frac{c\pi/36}{100} \sqrt{64h} = -\frac{c\pi}{450} \sqrt{h}.$$

12. The volume of water in the tank at time  $t$  is  $V = \frac{1}{3}\pi r^2 h = \frac{1}{3}A_w h$ . Using the formula from Problem 11 for the volume of water leaving the tank we see that the differential equation is

$$\frac{dh}{dt} = \frac{3}{A_w} \frac{dV}{dt} = \frac{3}{A_w} (-cA_h \sqrt{2gh}) = -\frac{3cA_h}{A_w} \sqrt{2gh}.$$

Using  $A_h = \pi(2/12)^2 = \pi/36$ ,  $g = 32$ , and  $c = 0.6$ , this becomes

$$\frac{dh}{dt} = -\frac{3(0.6)\pi/36}{A_w} \sqrt{64h} = -\frac{0.4\pi}{A_w} h^{1/2}.$$

To find  $A_w$  we let  $r$  be the radius of the top of the water. Then  $r/h = 8/20$ , so  $r = 2h/5$  and  $A_w = \pi(2h/5)^2 = 4\pi h^2/25$ . Thus

$$\frac{dh}{dt} = -\frac{0.4\pi}{4\pi h^2/25} h^{1/2} = -2.5h^{-3/2}.$$

13. Since  $i = \frac{dq}{dt}$  and  $L\frac{d^2q}{dt^2} + R\frac{dq}{dt} = E(t)$  we obtain  $L\frac{di}{dt} + Ri = E(t)$ .

14. By Kirchoff's second law we obtain  $R\frac{dq}{dt} + \frac{1}{C}q = E(t)$ .

15. From Newton's second law we obtain  $m \frac{dv}{dt} = -kv^2 + mg$ .

16. We have from Archimedes' principle

$$\begin{aligned} \text{upward force of water on barrel} &= \text{weight of water displaced} \\ &= (62.4) \times (\text{volume of water displaced}) \\ &= (62.4)\pi(s/2)^2 y = 15.6\pi s^2 y. \end{aligned}$$

It then follows from Newton's second law that  $\frac{w}{g} \frac{d^2 y}{dt^2} = -15.6\pi s^2 y$  or  $\frac{d^2 y}{dt^2} + \frac{15.6\pi s^2 g}{w} y = 0$ , where  $g = 32$  and  $w$  is the weight of the barrel in pounds.

17. The net force acting on the mass is

$$F = ma = m \frac{d^2 x}{dt^2} = -k(s+x) + mg = -kx + mg - ks.$$

Since the condition of equilibrium is  $mg = ks$ , the differential equation is

$$m \frac{d^2 x}{dt^2} = -kx.$$

18. From Problem 17, without a damping force, the differential equation is  $m d^2 x/dt^2 = -kx$ . With a damping force proportional to velocity the differential equation becomes

$$m \frac{d^2 x}{dt^2} = -kx - \beta \frac{dx}{dt} \quad \text{or} \quad m \frac{d^2 x}{dt^2} + \beta \frac{dx}{dt} + kx = 0.$$

19. Let  $x(t)$  denote the height of the top of the chain at time  $t$  with the positive direction upward. The weight of the portion of chain off the ground is  $W = (x \text{ ft}) \cdot (1 \text{ lb/ft}) = x$ . The mass of the chain is  $m = W/g = x/32$ . The net force is  $F = 5 - W = 5 - x$ . By Newton's second law,

$$\frac{d}{dt} \left( \frac{x}{32} v \right) = 5 - x \quad \text{or} \quad x \frac{dv}{dt} + v \frac{dx}{dt} = 160 - 32x.$$

Thus, the differential equation is

$$x \frac{d^2 x}{dt^2} + \left( \frac{dx}{dt} \right)^2 + 32x = 160.$$

20. The force is the weight of the chain,  $2L$ , so by Newton's second law,  $\frac{d}{dt}[mv] = 2L$ . Since the mass of the portion of chain off the ground is  $m = 2(L-x)/g$ , we have

$$\frac{d}{dt} \left[ \frac{2(L-x)}{g} v \right] = 2L \quad \text{or} \quad (L-x) \frac{dv}{dt} + v \left( -\frac{dx}{dt} \right) = Lg.$$

Thus, the differential equation is

$$(L-x) \frac{d^2 x}{dt^2} - \left( \frac{dx}{dt} \right)^2 = Lg.$$

### Exercises 1.3

21. From  $g = k/R^2$  we find  $k = gR^2$ . Using  $a = d^2r/dt^2$  and the fact that the positive direction is upward we get

$$\frac{d^2r}{dt^2} = -a = -\frac{k}{r^2} = -\frac{gR^2}{r^2} \quad \text{or} \quad \frac{d^2r}{dt^2} + \frac{gR^2}{r^2} = 0.$$

22. The gravitational force on  $m$  is  $F = -kM_r m/r^2$ . Since  $M_r = 4\pi\delta r^3/3$  and  $M = 4\pi\delta R^3/3$  we have  $M_r = r^3M/R^3$  and

$$F = -k \frac{M_r m}{r^2} = -k \frac{r^3 M m / R^3}{r^2} = -k \frac{mM}{R^3} r.$$

Now from  $F = ma = d^2r/dt^2$  we have

$$m \frac{d^2r}{dt^2} = -k \frac{mM}{R^3} r \quad \text{or} \quad \frac{d^2r}{dt^2} = -\frac{kM}{R^3} r.$$

23. The differential equation is  $\frac{dA}{dt} = k(M - A)$ .  
 24. The differential equation is  $\frac{dA}{dt} = k_1(M - A) - k_2A$ .  
 25. The differential equation is  $x'(t) = r - kx(t)$  where  $k > 0$ .

26. By the Pythagorean Theorem the slope of the tangent line is  $y' = \frac{-y}{\sqrt{s^2 - y^2}}$ .

27. We see from the figure that  $2\theta + \alpha = \pi$ . Thus

$$\frac{y}{-x} = \tan \alpha = \tan(\pi - 2\theta) = -\tan 2\theta = -\frac{2 \tan \theta}{1 - \tan^2 \theta}.$$

Since the slope of the tangent line is  $y' = \tan \theta$  we have  $y/x = 2y'[1 - (y')^2]$  or  $y - y(y')^2 = 2xy'$ , which is the quadratic equation  $y(y')^2 + 2xy' - y = 0$  in  $y'$ . Using the quadratic formula we get

$$y' = \frac{-2x \pm \sqrt{4x^2 + 4y^2}}{2y} = \frac{-x \pm \sqrt{x^2 + y^2}}{y}.$$

Since  $dy/dx > 0$ , the differential equation is

$$\frac{dy}{dx} = \frac{-x + \sqrt{x^2 + y^2}}{y} \quad \text{or} \quad y \frac{dy}{dx} - \sqrt{x^2 + y^2} + x = 0.$$

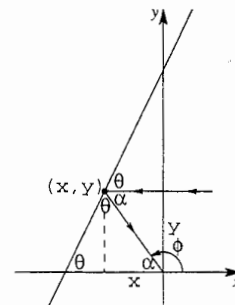

28. The differential equation is  $dP/dt = kP$ , so from Problem 31 in Exercises 1.1,  $P = e^{kt}$ , and a one-parameter family of solutions is  $P = ce^{kt}$ .  
 29. The differential equation in (3) is  $dT/dt = k(T - T_m)$ . When the body is cooling,  $T > T_m$ , so  $T - T_m > 0$ . Since  $T$  is decreasing,  $dT/dt < 0$  and  $k < 0$ . When the body is warming,  $T < T_m$ , so  $T - T_m < 0$ . Since  $T$  is increasing,  $dT/dt > 0$  and  $k < 0$ .





### Exercises 1.3

From Newton's second law,  $\frac{d}{dt}[mv] = mg$ , where  $v$  is the velocity of the raindrop. Then

$$m \frac{dv}{dt} + v \frac{dm}{dt} = mg \quad \text{or} \quad \rho \left( \frac{4}{3} \pi r^3 \right) \frac{dv}{dt} + v(k4\pi r^2) = \rho \left( \frac{4}{3} \pi r^3 \right) g.$$

Dividing by  $4\rho\pi r^3/3$  we get

$$\frac{dv}{dt} + \frac{3k}{\rho r} v = g \quad \text{or} \quad \frac{dv}{dt} + \frac{3k/\rho}{kt/\rho + r_0} v = g, \quad k < 0.$$

36. We assume that the plow clears snow at a constant rate of  $k$  cubic miles per hour. Let  $t$  be the time in hours after noon,  $x(t)$  the depth in miles of the snow at time  $t$ , and  $y(t)$  the distance the plow has moved in  $t$  hours. Then  $dy/dt$  is the velocity of the plow and the assumption gives

$$wx \frac{dy}{dt} = k$$

where  $w$  is the width of the plow. Each side of this equation simply represents the volume of snow plowed in one hour. Now let  $t_0$  be the number of hours before noon when it started snowing and let  $s$  be the constant rate in miles per hour at which  $x$  increases. Then for  $t > -t_0$ ,  $x = s(t + t_0)$ . The differential equation then becomes

$$\frac{dy}{dt} = \frac{k}{ws} \frac{1}{t + t_0}.$$

Integrating we obtain

$$y = \frac{k}{ws} [\ln(t + t_0) + c]$$

where  $c$  is a constant. Now when  $t = 0$ ,  $y = 0$  so  $c = -\ln t_0$  and

$$y = \frac{k}{ws} \ln \left( 1 + \frac{t}{t_0} \right).$$

Finally, from the fact that when  $t = 1$ ,  $y = 2$  and when  $t = 2$ ,  $y = 3$ , we obtain

$$\left( 1 + \frac{2}{t_0} \right)^2 = \left( 1 + \frac{1}{t_0} \right)^3.$$

Expanding and simplifying gives  $t_0^2 + t_0 - 1 = 0$ . Since  $t_0 > 0$ , we find  $t_0 \approx 0.618$  hours  $\approx$  37 minutes. Thus it started snowing at about 11:23 in the morning.

## Chapter 1 Review Exercises

1.  $\frac{d}{dx} c_1 e^{kt} = c_1 k e^{kt}; \quad \frac{dy}{dx} = ky$
2.  $\frac{d}{dx} (5 + c_1 e^{-2x}) = -2c_1 e^{-2x} = -2(5 + c_1 e^{-2x} - 5); \quad \frac{dy}{dx} = -2(y - 5) \quad \text{or} \quad \frac{dy}{dx} = -2y + 10$
3.  $\frac{d}{dx} (c_1 \cos kx + c_2 \sin kx) = -kc_1 \sin kx + kc_2 \cos kx;$   
 $\frac{d^2}{dx^2} (c_1 \cos kx + c_2 \sin kx) = -k^2 c_1 \cos kx - k^2 c_2 \sin kx = -k^2 (c_1 \cos kx + c_2 \sin kx);$   
 $\frac{d^2 y}{dx^2} = -k^2 y \quad \text{or} \quad \frac{d^2 y}{dx^2} + k^2 y = 0$
4.  $\frac{d}{dx} (c_1 \cosh kx + c_2 \sinh kx) = kc_1 \sinh kx + kc_2 \cosh kx;$   
 $\frac{d^2}{dx^2} (c_1 \cosh kx + c_2 \sinh kx) = k^2 c_1 \cosh kx + k^2 c_2 \sinh kx = k^2 (c_1 \cosh kx + c_2 \sinh kx);$   
 $\frac{d^2 y}{dx^2} = k^2 y \quad \text{or} \quad \frac{d^2 y}{dx^2} - k^2 y = 0$
5.  $y' = c_1 e^x + c_2 x e^x + c_2 e^x; \quad y'' = c_1 e^x + c_2 x e^x + 2c_2 e^x;$   
 $y'' + y = 2(c_1 e^x + c_2 x e^x) + 2c_2 e^x = 2(c_1 e^x + c_2 x e^x + c_2 e^x) = 2y'; \quad y'' - 2y' + y = 0$
6.  $y' = -c_1 e^x \sin x + c_1 e^x \cos x + c_2 e^x \cos x + c_2 e^x \sin x;$   
 $y'' = -c_1 e^x \cos x - c_1 e^x \sin x - c_1 e^x \sin x + c_1 e^x \cos x - c_2 e^x \sin x + c_2 e^x \cos x + c_2 e^x \cos x + c_2 e^x \sin x$   
 $= -2c_1 e^x \sin x + 2c_2 e^x \cos x;$   
 $y'' - 2y' = -2c_1 e^x \cos x - 2c_2 e^x \sin x = -2y; \quad y'' - 2y' + 2y = 0$
7. a,d            8. c            9. b            10. a,c            11. b            12. a,b,d
13. A few solutions are  $y = 0$ ,  $y = c$ , and  $y = e^x$ .
14. Easy solutions to see are  $y = 0$  and  $y = 3$ .
15. The slope of the tangent line at  $(x, y)$  is  $y'$ , so the differential equation is  $y' = x^2 + y^2$ .
16. The rate at which the slope changes is  $dy'/dx = y''$ , so the differential equation is  $y'' = -y'$  or  $y'' + y' = 0$ .
17. (a) The domain is all real numbers.  
 (b) Since  $y' = 2/3x^{1/3}$ , the solution  $y = x^{2/3}$  is undefined at  $x = 0$ . This function is a solution of the differential equation on  $(-\infty, 0)$  and also on  $(0, \infty)$ .
18. (a) Differentiating  $y^2 - 2y = x^2 - x + c$  we obtain  $2yy' - 2y' = 2x - 1$  or  $(2y - 2)y' = 2x - 1$ .

## Chapter 1 Review Exercises

- (b) Setting  $x = 0$  and  $y = 1$  in the solution we have  $1 - 2 = 0 - 0 + c$  or  $c = -1$ . Thus, a solution of the initial-value problem is  $y^2 - 2y = x^2 - x - 1$ .
- (c) Solving  $y^2 - 2y - (x^2 - x - 1) = 0$  by the quadratic formula we get  $y = (2 \pm \sqrt{4 + 4(x^2 - x - 1)})/2 = 1 \pm \sqrt{x^2 - x} = 1 \pm \sqrt{x(x-1)}$ . Since  $x(x-1) \geq 0$  for  $x \leq 0$  or  $x \geq 1$ , we see that neither  $y = 1 + \sqrt{x(x-1)}$  nor  $y = 1 - \sqrt{x(x-1)}$  is differentiable at  $x = 0$ . Thus, both functions are solutions of the differential equation, but neither is a solution of the initial-value problem.

19. (a)

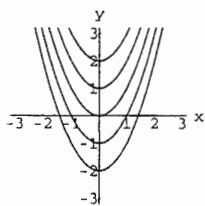

$$y = x^2 + c_1$$

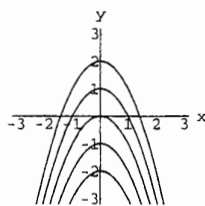

$$y = -x^2 + c_2$$

- (b) When  $y = x^2 + c_1$ ,  $y' = 2x$  and  $(y')^2 = 4x^2$ . When  $y = -x^2 + c_2$ ,  $y' = -2x$  and  $(y')^2 = 4x^2$ .
- (c) Pasting together  $x^2$ ,  $x \geq 0$ , and  $-x^2$ ,  $x \leq 0$ , we get  $y = \begin{cases} -x^2, & x \leq 0 \\ x^2, & x > 0 \end{cases}$ .

20. The slope of the tangent line is  $y' |_{(-1,4)} = 6\sqrt{4} + 5(-1)^3 = 7$ .

21. Differentiating  $y = \sin(\ln x)$  we obtain  $y' = \cos(\ln x)/x$  and  $y'' = -[\sin(\ln x) + \cos(\ln x)]/x^2$ . Then

$$x^2 y'' + x y' + y = x^2 \left( -\frac{\sin(\ln x) + \cos(\ln x)}{x^2} \right) + x \frac{\cos(\ln x)}{x} + \sin(\ln x) = 0.$$

22. Differentiating  $y = \cos(\ln x) \ln(\cos(\ln x)) + (\ln x) \sin(\ln x)$  we obtain

$$\begin{aligned} y' &= \cos(\ln x) \frac{1}{\cos(\ln x)} \left( -\frac{\sin(\ln x)}{x} \right) + \ln(\cos(\ln x)) \left( -\frac{\sin(\ln x)}{x} \right) + \ln x \frac{\cos(\ln x)}{x} + \frac{\sin(\ln x)}{x} \\ &= -\frac{\ln(\cos(\ln x)) \sin(\ln x)}{x} + \frac{(\ln x) \cos(\ln x)}{x} \end{aligned}$$

and

$$\begin{aligned} y'' &= -x \left[ \ln(\cos(\ln x)) \frac{\cos(\ln x)}{x} + \sin(\ln x) \frac{1}{\cos(\ln x)} \left( -\frac{\sin(\ln x)}{x} \right) \right] \frac{1}{x^2} \\ &\quad + \ln(\cos(\ln x)) \sin(\ln x) \frac{1}{x^2} + x \left[ (\ln x) \left( -\frac{\sin(\ln x)}{x} \right) + \frac{\cos(\ln x)}{x} \right] \frac{1}{x^2} - (\ln x) \cos(\ln x) \frac{1}{x^2} \\ &= \frac{1}{x^2} \left[ -\ln(\cos(\ln x)) \cos(\ln x) + \frac{\sin^2(\ln x)}{\cos(\ln x)} + \ln(\cos(\ln x)) \sin(\ln x) \right. \\ &\quad \left. - (\ln x) \sin(\ln x) + \cos(\ln x) - (\ln x) \cos(\ln x) \right]. \end{aligned}$$

Then

$$\begin{aligned} x^2 y'' + xy' + y &= -\ln(\cos(\ln x)) \cos(\ln x) + \frac{\sin^2(\ln x)}{\cos(\ln x)} + \ln(\cos(\ln x)) \sin(\ln x) - (\ln x) \sin(\ln x) \\ &\quad + \cos(\ln x) - (\ln x) \cos(\ln x) - \ln(\cos(\ln x)) \sin(\ln x) \\ &\quad + (\ln x) \cos(\ln x) + \cos(\ln x) \ln(\cos(\ln x)) + (\ln x) \sin(\ln x) \\ &= \frac{\sin^2(\ln x)}{\cos(\ln x)} + \cos(\ln x) = \frac{\sin^2(\ln x) + \cos^2(\ln x)}{\cos(\ln x)} = \frac{1}{\cos(\ln x)} = \sec(\ln x). \end{aligned}$$

(This problem is easily done using *Mathematica*.)

23. From the graph we see that estimates for  $y_0$  and  $y_1$  are  $y_0 = -3$  and  $y_1 = 0$ .  
 24. The differential equation is

$$\frac{dh}{dt} = -\frac{cA_0}{A_w} \sqrt{2gh}.$$

Using  $A_0 = \pi(1/24)^2 = \pi/576$ ,  $A_w = \pi(2)^2 = 4\pi$ , and  $g = 32$ , this becomes

$$\frac{dh}{dt} = -\frac{c\pi/576}{4\pi} \sqrt{64h} = \frac{c}{288} \sqrt{h}.$$

25. From Newton's second law we obtain

$$m \frac{dv}{dt} = \frac{1}{2} mg - \mu \frac{\sqrt{3}}{2} mg \quad \text{or} \quad \frac{dv}{dt} = 16(1 - \sqrt{3}\mu).$$

# 2 First-Order Differential Equations

## Exercises 2.1

---

1.

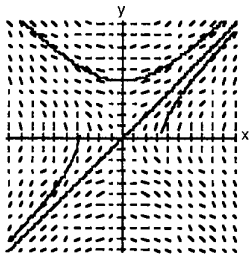

2.

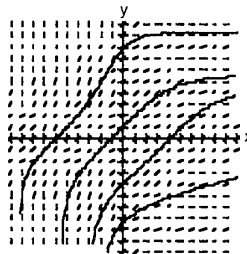

3.

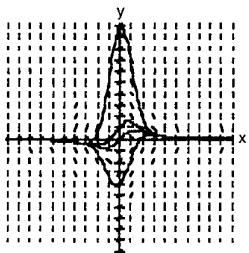

4.

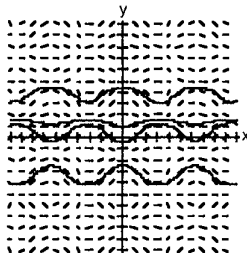

5.

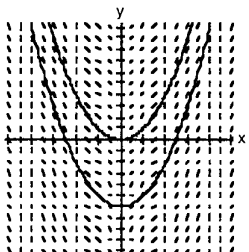

6.

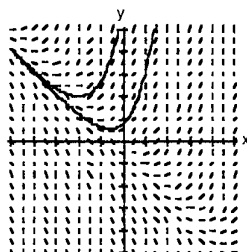

7.

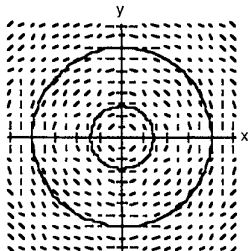

8.

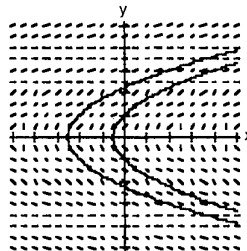

Exercises 2.1

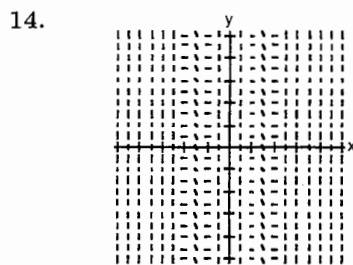
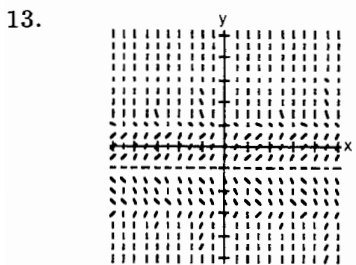
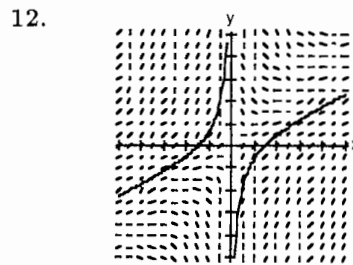
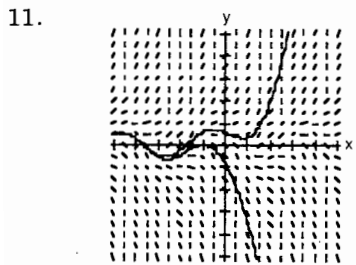
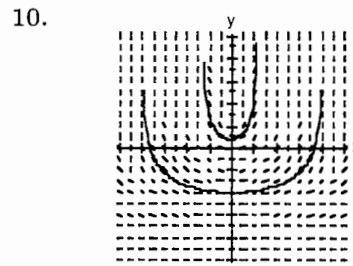
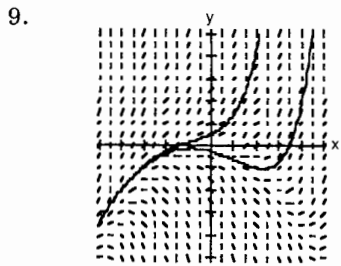

15. Writing the differential equation in the form  $dy/dx = y(1-y)(1+y)$  we see that critical points are located at  $y = -1$ ,  $y = 0$ , and  $y = 1$ . The phase portrait is shown below.

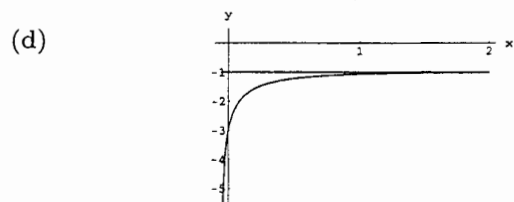
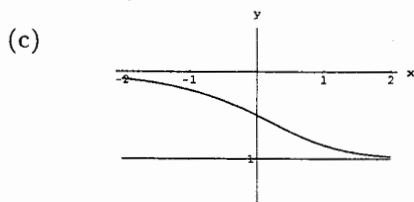
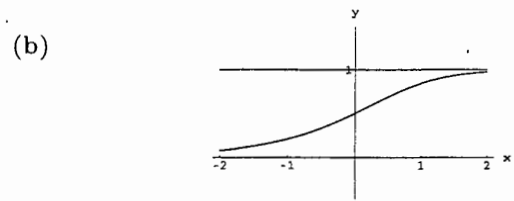
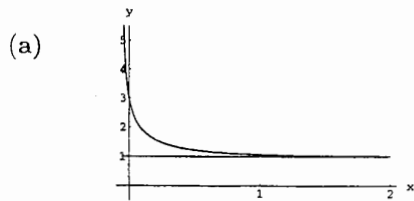
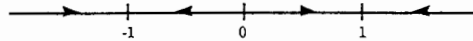

### Exercises 2.1

16. Writing the differential equation in the form  $dy/dx = y^2(1-y)(1+y)$  we see that critical points are located at  $y = -1$ ,  $y = 0$ , and  $y = 1$ . The phase portrait is shown below.

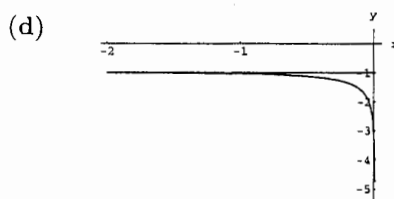
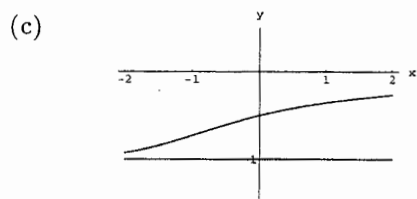
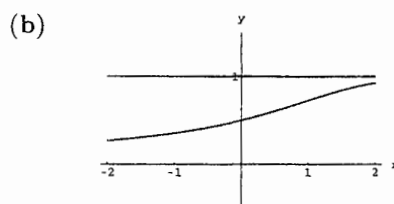
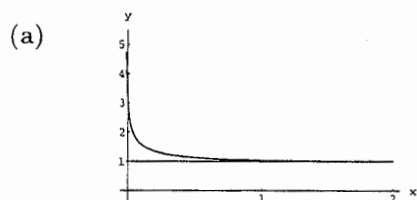
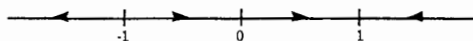

17. Solving  $y^2 - 3y = y(y - 3) = 0$  we obtain the critical points 0 and 3.

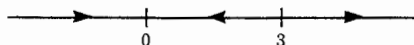

From the phase portrait we see that 0 is asymptotically stable and 3 is unstable.

18. Solving  $y^2 - y^3 = y^2(1 - y) = 0$  we obtain the critical points 0 and 1.

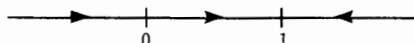

From the phase portrait we see that 1 is asymptotically stable and 0 is semi-stable.

19. Solving  $(y - 2)^4 = 0$  we obtain the critical point 2.

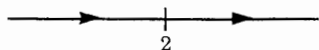

From the phase portrait we see that 2 is semi-stable.

20. Solving  $10 + 3y - y^2 = (5 - y)(2 + y) = 0$  we obtain the critical points  $-2$  and  $5$ .

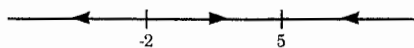

From the phase portrait we see that  $5$  is asymptotically stable and  $-2$  is unstable.

21. Solving  $y^2(4 - y^2) = y^2(2 - y)(2 + y) = 0$  we obtain the critical points  $-2$ ,  $0$ , and  $2$ .

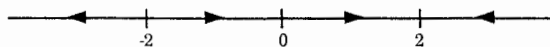



Exercises 2.1

From the phase portrait we see that 2 is asymptotically stable, 0 is semi-stable, and  $-2$  is unstable.

22. Solving  $y(2 - y)(4 - y) = 0$  we obtain the critical points 0, 2, and 4.

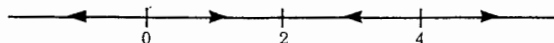

From the phase portrait we see that 2 is asymptotically stable and 0 and 4 are unstable.

23. Solving  $y \ln(y + 2) = 0$  we obtain the critical points  $-1$  and 0.

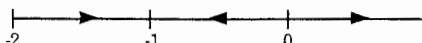

From the phase portrait we see that  $-1$  is asymptotically stable and 0 is unstable.

24. Solving  $ye^y - 9y = y(e^y - 9) = 0$  we obtain the critical points 0 and  $\ln 9$ .

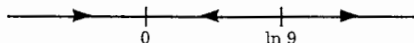

From the phase portrait we see that 0 is asymptotically stable and  $\ln 9$  is unstable.

25. (a) Writing the differential equation in the form

$$\frac{dv}{dt} = \frac{k}{m} \left( \frac{mg}{k} - v \right)$$

we see that a critical point is  $mg/k$ .

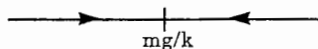

From the phase portrait we see that  $mg/k$  is an asymptotically stable critical point. Thus,  $\lim_{t \rightarrow \infty} v = mg/k$ .

- (b) Writing the differential equation in the form

$$\frac{dv}{dt} = \frac{k}{m} \left( \frac{mg}{k} - v^2 \right) = \frac{k}{m} \left( \sqrt{\frac{mg}{k}} - v \right) \left( \sqrt{\frac{mg}{k}} + v \right)$$

we see that a critical point is  $\sqrt{mg/k}$ .

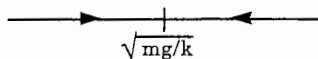

From the phase portrait we see that  $\sqrt{mg/k}$  is an asymptotically stable critical point. Thus,  $\lim_{t \rightarrow \infty} v = \sqrt{mg/k}$ .

26. (a) From the phase portrait we see that critical points are  $\alpha$  and  $\beta$ . Let  $X(0) = X_0$ .

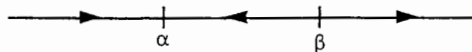

If  $X_0 < \alpha$ , we see that  $X \rightarrow \alpha$  as  $t \rightarrow \infty$ . If  $\alpha < X_0 < \beta$ , we see that  $X \rightarrow \alpha$  as  $t \rightarrow \infty$ .

### Exercises 2.1

If  $X_0 > \beta$ , we see that  $X(t)$  increases in an unbounded manner, but more specific behavior of  $X(t)$  as  $t \rightarrow \infty$  is not known.

- (b) When  $\alpha = \beta$  the phase portrait is as shown.

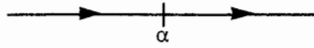

If  $X_0 < \alpha$ , then  $X(t) \rightarrow \alpha$  as  $t \rightarrow \infty$ . If  $X_0 > \alpha$ , then  $X(t)$  increases in an unbounded manner. This could happen in a finite amount of time. That is, the phase portrait does not indicate that  $X$  becomes unbounded as  $t \rightarrow \infty$ .

- (c) When  $k = 1$  and  $\alpha = \beta$  the differential equation is  $dX/dt = (\alpha - X)^2$ . Separating variables and integrating we have

$$\begin{aligned} \frac{dX}{(\alpha - X)^2} &= dt \\ \frac{1}{\alpha - X} &= t + c \\ \alpha - X &= \frac{1}{t + c} \\ X &= \alpha - \frac{1}{t + c} \end{aligned}$$

For  $X(0) = \alpha/2$  we obtain

$$X(t) = \alpha - \frac{1}{t + 2/\alpha}$$

For  $X(0) = 2\alpha$  we obtain

$$X(t) = \alpha - \frac{1}{t - 1/\alpha}$$

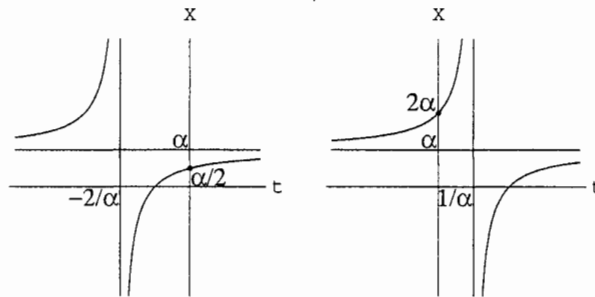

For  $X_0 > \alpha$ ,  $X(t)$  increases without bound up to  $t = 1/\alpha$ . For  $t > 1/\alpha$ ,  $X(t)$  increases but  $X \rightarrow \alpha$  as  $t \rightarrow \infty$ .

Exercises 2.1

27. Critical points are  $y = 0$  and  $y = c$ .

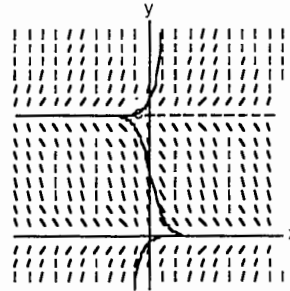
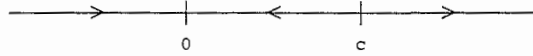

28. Critical points are  $y = -2.2$ ,  $y = 0.5$ , and  $y = 1.7$ .

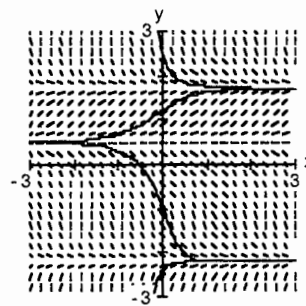
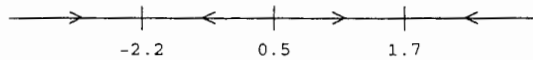

29. At each point on the circle of radius  $c$  the lineal element has slope  $c^2$ .
30. (a) When  $x = 0$  or  $y = 4$ ,  $dy/dx = -2$  so the lineal elements have slope  $-2$ . When  $y = 3$  or  $y = 5$ ,  $dy/dx = x - 2$ , so the lineal elements at  $(x, 3)$  or  $(x, 5)$  have slopes  $x - 2$ .
- (b) At  $(0, y_0)$  the solution curve is headed down. As  $x$  increases, it will eventually turn around and head up, but it can never cross  $y = 4$  where a tangent line to a solution curve must have slope 0. Thus,  $y$  cannot approach  $\infty$  as  $x$  approaches  $\infty$ .
31. When  $y < \frac{1}{2}x^2$ ,  $y' = x^2 - 2y$  is positive and the portions of solution curves "inside" the nullcline parabola are increasing. When  $y > \frac{1}{2}x^2$ ,  $y' = x^2 - 2y$  is negative and the portions of the solution curves "outside" the nullcline parabola are decreasing.

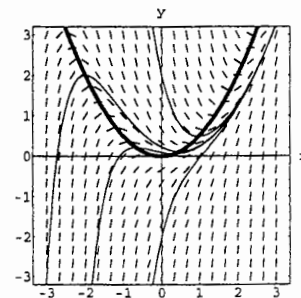

32. For  $dx/dt = 0$  every real number is a critical point, and hence all critical points are nonisolated.
33. Recall that for  $dy/dx = f(y)$  we are assuming that  $f$  and  $f'$  are continuous functions of  $y$  on some interval  $I$ . Now suppose that the graph of a nonconstant solution of the differential equation

## Exercises 2.1

crosses the line  $y = c$ . If the point of intersection is taken as an initial condition we have two distinct solutions of the initial-value problem. This violates uniqueness, so the graph of any nonconstant solution must lie entirely on one side of any equilibrium solution. Since  $f$  is continuous it can only change signs around a point where it is 0. But this is a critical point. Thus,  $f(y)$  is completely positive or completely negative in each region  $R_i$ . If  $y(x)$  is oscillatory or has a relative extremum, then it must have a horizontal tangent line at some point  $(x_0, y_0)$ . In this case  $y_0$  would be a critical point of the differential equation, but we saw above that the graph of a nonconstant solution cannot intersect the graph of the equilibrium solution  $y = y_0$ .

34. By Problem 33, a solution  $y(x)$  of  $dy/dx = f(y)$  cannot have relative extrema and hence must be monotone. Since  $y'(x) = f(y) > 0$ ,  $y(x)$  is monotone increasing, and since  $y(x)$  is bounded above by  $c_2$ ,  $\lim_{x \rightarrow \infty} y(x) = L$ , where  $L \leq c_2$ . We want to show that  $L = c_2$ . Since  $L$  is a horizontal asymptote of  $y(x)$ ,  $\lim_{x \rightarrow \infty} y'(x) = 0$ . Using the fact that  $f(y)$  is continuous we have

$$f(L) = f(\lim_{x \rightarrow \infty} y(x)) = \lim_{x \rightarrow \infty} f(y(x)) = \lim_{x \rightarrow \infty} y'(x) = 0.$$

But then  $L$  is a critical point of  $f$ . Since  $c_1 < L \leq c_2$ , and  $f$  has no critical points between  $c_1$  and  $c_2$ ,  $L = c_2$ .

35. (a) Assuming the existence of the second derivative, points of inflection of  $y(x)$  occur where  $y''(x) = 0$ . From  $dy/dx = g(y)$  we have  $d^2y/dx^2 = g'(y) dy/dx$ . Thus, the  $y$ -coordinate of a point of inflection can be located by solving  $g'(y) = 0$ . (Points where  $dy/dx = 0$  correspond to constant solutions of the differential equation.)
- (b) Solving  $y^2 - y - 6 = (y - 3)(y + 2) = 0$  we see that 3 and  $-2$  are critical points. Now  $d^2y/dx^2 = (2y - 1) dy/dx = (2y - 1)(y - 3)(y + 2)$ , so the only possible point of inflection is at  $y = \frac{1}{2}$ , although the concavity of solutions can be different on either side of  $y = -2$  and  $y = 3$ . Since  $y''(x) < 0$  for  $y < -2$  and  $\frac{1}{2} < y < 3$ , and  $y''(x) > 0$  for  $-2 < y < \frac{1}{2}$  and  $y > 3$ , we see that solution curves are concave down for  $y < -2$  and  $\frac{1}{2} < y < 3$  and concave up for  $-2 < y < \frac{1}{2}$  and  $y > 3$ . Points of inflection of solutions of autonomous differential equations will have the same  $y$ -coordinates because between critical points they are horizontal translates of each other.

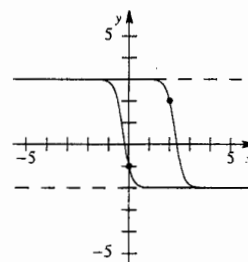

---

**Exercises 2.2**

---

In many of the following problems we will encounter an expression of the form  $\ln |g(y)| = f(x) + c$ . To solve for  $g(y)$  we exponentiate both sides of the equation. This yields  $|g(y)| = e^{f(x)+c} = e^c e^{f(x)}$  which implies  $g(y) = \pm e^c e^{f(x)}$ . Letting  $c_1 = \pm e^c$  we obtain  $g(y) = c_1 e^{f(x)}$ .

1. From  $dy = \sin 5x \, dx$  we obtain  $y = -\frac{1}{5} \cos 5x + c$ .
2. From  $dy = (x+1)^2 \, dx$  we obtain  $y = \frac{1}{3}(x+1)^3 + c$ .
3. From  $dy = -e^{-3x} \, dx$  we obtain  $y = \frac{1}{3}e^{-3x} + c$ .
4. From  $\frac{1}{(y-1)^2} \, dy = dx$  we obtain  $-\frac{1}{y-1} = x + c$  or  $y = 1 - \frac{1}{x+c}$ .
5. From  $\frac{1}{y} \, dy = \frac{4}{x} \, dx$  we obtain  $\ln |y| = 4 \ln |x| + c$  or  $y = c_1 x^4$ .
6. From  $\frac{1}{y} \, dy = -2x \, dx$  we obtain  $\ln |y| = -x^2 + c$  or  $y = c_1 e^{-x^2}$ .
7. From  $e^{-2y} \, dy = e^{3x} \, dx$  we obtain  $3e^{-2y} + 2e^{3x} = c$ .
8. From  $ye^y \, dy = (e^{-x} + e^{-3x}) \, dx$  we obtain  $ye^y - e^y + e^{-x} + \frac{1}{3}e^{-3x} = c$ .
9. From  $\left(y + 2 + \frac{1}{y}\right) \, dy = x^2 \ln x \, dx$  we obtain  $\frac{y^2}{2} + 2y + \ln |y| = \frac{x^3}{3} \ln |x| - \frac{1}{9}x^3 + c$ .
10. From  $\frac{1}{(2y+3)^2} \, dy = \frac{1}{(4x+5)^2} \, dx$  we obtain  $\frac{2}{2y+3} = \frac{1}{4x+5} + c$ .
11. From  $\frac{1}{\csc y} \, dy = -\frac{1}{\sec^2 x} \, dx$  or  $\sin y \, dy = -\cos^2 x \, dx = -\frac{1}{2}(1 + \cos 2x) \, dx$  we obtain  $-\cos y = -\frac{1}{2}x - \frac{1}{4} \sin 2x + c$  or  $4 \cos y = 2x + \sin 2x + c_1$ .
12. From  $2y \, dy = -\frac{\sin 3x}{\cos^3 3x} \, dx = -\tan 3x \sec^2 3x \, dx$  we obtain  $y^2 = -\frac{1}{6} \sec^2 3x + c$ .
13. From  $\frac{e^y}{(e^y+1)^2} \, dy = \frac{-e^x}{(e^x+1)^3} \, dx$  we obtain  $-(e^y+1)^{-1} = \frac{1}{2}(e^x+1)^{-2} + c$ .
14. From  $\frac{y}{(1+y^2)^{1/2}} \, dy = \frac{x}{(1+x^2)^{1/2}} \, dx$  we obtain  $(1+y^2)^{1/2} = (1+x^2)^{1/2} + c$ .
15. From  $\frac{1}{S} \, dS = k \, dr$  we obtain  $S = ce^{kr}$ .
16. From  $\frac{1}{Q-70} \, dQ = k \, dt$  we obtain  $\ln |Q-70| = kt + c$  or  $Q-70 = c_1 e^{kt}$ .

## Exercises 2.2

17. From  $\frac{1}{P-P^2}dP = \left(\frac{1}{P} + \frac{1}{1-P}\right)dP = dt$  we obtain  $\ln|P| - \ln|1-P| = t+c$  so that  $\ln \frac{P}{1-P} = t+c$  or  $\frac{P}{1-P} = c_1 e^t$ . Solving for  $P$  we have  $P = \frac{c_1 e^t}{1+c_1 e^t}$ .

18. From  $\frac{1}{N}dN = (te^{t+2} - 1)dt$  we obtain  $\ln|N| = te^{t+2} - e^{t+2} - t + c$ .

19. From  $\frac{y-2}{y+3}dy = \frac{x-1}{x+4}dx$  or  $\left(1 - \frac{5}{y+3}\right)dy = \left(1 - \frac{5}{x+4}\right)dx$  we obtain

$$y - 5 \ln|y+3| = x - 5 \ln|x+4| + c \quad \text{or} \quad \left(\frac{x+4}{y+3}\right)^5 = c_1 e^{x-y}.$$

20. From  $\frac{y+1}{y-1}dy = \frac{x+2}{x-3}dx$  or  $\left(1 + \frac{2}{y-1}\right)dy = \left(1 + \frac{5}{x-3}\right)dx$  we obtain

$$y + 2 \ln|y-1| = x + 5 \ln|x-3| + c \quad \text{or} \quad \frac{(y-1)^2}{(x-3)^5} = c_1 e^{x-y}.$$

21. From  $x dx = \frac{1}{\sqrt{1-y^2}}dy$  we obtain  $\frac{1}{2}x^2 = \sin^{-1}y + c$  or  $y = \sin\left(\frac{x^2}{2} + c_1\right)$ .

22. From  $\frac{1}{y^2}dy = \frac{1}{e^x + e^{-x}}dx = \frac{e^x}{(e^x)^2 + 1}dx$  we obtain  $-\frac{1}{y} = \tan^{-1}e^x + c$  or  $y = -\frac{1}{\tan^{-1}e^x + c}$ .

23. From  $\frac{1}{x^2+1}dx = 4dt$  we obtain  $\tan^{-1}x = 4t + c$ . Using  $x(\pi/4) = 1$  we find  $c = -3\pi/4$ . The solution of the initial-value problem is  $\tan^{-1}x = 4t - \frac{3\pi}{4}$  or  $x = \tan\left(4t - \frac{3\pi}{4}\right)$ .

24. From  $\frac{1}{y^2-1}dy = \frac{1}{x^2-1}dx$  or  $\frac{1}{2}\left(\frac{1}{y-1} - \frac{1}{y+1}\right)dy = \frac{1}{2}\left(\frac{1}{x-1} - \frac{1}{x+1}\right)dx$  we obtain

$$\ln|y-1| - \ln|y+1| = \ln|x-1| - \ln|x+1| + \ln c \quad \text{or} \quad \frac{y-1}{y+1} = \frac{c(x-1)}{x+1}.$$

Using  $y(2) = 2$  we find  $c = 1$ . The solution of the initial-value problem is  $\frac{y-1}{y+1} = \frac{x-1}{x+1}$  or  $y = x$ .

25. From  $\frac{1}{y}dy = \frac{1-x}{x^2}dx = \left(\frac{1}{x^2} - \frac{1}{x}\right)dx$  we obtain  $\ln|y| = -\frac{1}{x} - \ln|x| = c$  or  $xy = c_1 e^{-1/x}$ . Using  $y(-1) = -1$  we find  $c_1 = e^{-1}$ . The solution of the initial-value problem is  $xy = e^{-1-1/x}$ .

26. From  $\frac{1}{1-2y}dy = dt$  we obtain  $-\frac{1}{2}\ln|1-2y| = t+c$  or  $1-2y = c_1 e^{-2t}$ . Using  $y(0) = 5/2$  we find  $c_1 = -4$ . The solution of the initial-value problem is  $1-2y = -4e^{-2t}$  or  $y = 2e^{-2t} + \frac{1}{2}$ .

27. Separating variables and integrating we obtain

$$\frac{dx}{\sqrt{1-x^2}} - \frac{dy}{\sqrt{1-y^2}} = 0 \quad \text{and} \quad \sin^{-1}x - \sin^{-1}y = c.$$

## Exercises 2.2

Setting  $x = 0$  and  $y = \sqrt{3}/2$  we obtain  $c = -\pi/3$ . Thus, an implicit solution of the initial-value problem is  $\sin^{-1} x - \sin^{-1} y = \pi/3$ . Solving for  $y$  and using a trigonometric identity we get

$$y = \sin\left(\sin^{-1} x + \frac{\pi}{3}\right) = x \cos \frac{\pi}{3} + \sqrt{1-x^2} \sin \frac{\pi}{3} = \frac{x}{2} + \frac{\sqrt{3}\sqrt{1-x^2}}{2}.$$

28. From  $\frac{1}{1+(2y)^2} dy = \frac{-x}{1+(x^2)^2} dx$  we obtain

$$\frac{1}{2} \tan^{-1} 2y = -\frac{1}{2} \tan^{-1} x^2 + c \quad \text{or} \quad \tan^{-1} 2y + \tan^{-1} x^2 = c_1.$$

Using  $y(1) = 0$  we find  $c_1 = \pi/4$ . The solution of the initial-value problem is

$$\tan^{-1} 2y + \tan^{-1} x^2 = \frac{\pi}{4}.$$

29. (a) The equilibrium solutions  $y(x) = 2$  and  $y(x) = -2$  satisfy the initial conditions  $y(0) = 2$  and  $y(0) = -2$ , respectively. Setting  $x = \frac{1}{4}$  and  $y = 1$  in  $y = 2(1 + ce^{4x})/(1 - ce^{4x})$  we obtain

$$1 = 2 \frac{1+ce}{1-ce}, \quad 1 - ce = 2 + 2ce, \quad -1 = 3ce, \quad \text{and} \quad c = -\frac{1}{3e}.$$

The solution of the corresponding initial-value problem is

$$y = 2 \frac{1 - \frac{1}{3}e^{4x-1}}{1 + \frac{1}{3}e^{4x-1}} = 2 \frac{3 - e^{4x-1}}{3 + e^{4x-1}}.$$

- (b) Separating variables and integrating yields

$$\frac{1}{4} \ln |y-2| - \frac{1}{4} \ln |y+2| + \ln c_1 = x$$

$$\ln |y-2| - \ln |y+2| + \ln c = 4x$$

$$\ln \left| \frac{c(y-2)}{y+2} \right| = 4x$$

$$c \frac{y-2}{y+2} = e^{4x}.$$

Solving for  $y$  we get  $y = 2(c + e^{4x})/(c - e^{4x})$ . The initial condition  $y(0) = -2$  can be solved for, yielding  $c = 0$  and  $y(x) = -2$ . The initial condition  $y(0) = 2$  does not correspond to a value of  $c$ , and it must simply be recognized that  $y(x) = 2$  is a solution of the initial-value problem. Setting  $x = \frac{1}{4}$  and  $y = 1$  in  $y = 2(c + e^{4x})/(c - e^{4x})$  leads to  $c = -3e$ . Thus, a solution of the initial-value problem is

$$y = 2 \frac{-3e + e^{4x}}{-3e - e^{4x}} = 2 \frac{3 - e^{4x-1}}{3 + e^{4x-1}}.$$

## Exercises 2.2

30. From  $\left(\frac{1}{y-1} + \frac{-1}{y}\right) dy = \frac{1}{x} dx$  we obtain  $\ln|y-1| - \ln|y| = \ln|x| + c$  or  $y = \frac{1}{1-c_1x}$ .

Another solution is  $y = 0$ .

(a) If  $y(0) = 1$  then  $y = 1$ .

(b) If  $y(0) = 0$  then  $y = 0$ .

(c) If  $y(1/2) = 1/2$  then  $y = \frac{1}{1+2x}$ .

(d) Setting  $x = 2$  and  $y = \frac{1}{4}$  we obtain

$$\frac{1}{4} = \frac{1}{1-c_1(2)}, \quad 1-2c_1 = 4, \quad \text{and} \quad c_1 = -\frac{3}{2}.$$

$$\text{Thus, } y = \frac{1}{1+\frac{3}{2}x} = \frac{2}{2+3x}.$$

31. Singular solutions of  $dy/dx = x\sqrt{1-y^2}$  are  $y = -1$  and  $y = 1$ . A singular solution of  $(e^x + e^{-x})dy/dx = y^2$  is  $y = 0$ .

32. Differentiating  $\ln(x^2 + 10) + \csc y = c$  we get

$$\frac{2x}{x^2 + 10} - \cot y \csc y \frac{dy}{dx} = 0,$$

$$\frac{2x}{x^2 + 10} - \frac{\cos y}{\sin y} \frac{1}{\sin y} \frac{dy}{dx} = 0,$$

or

$$2x \sin^2 y \, dx - (x^2 + 10) \cos y \, dy = 0.$$

Writing the differential equation in the form

$$\frac{dy}{dx} = \frac{2x \sin^2 y}{(x^2 + 10) \cos y}$$

we see that singular solutions occur when  $\sin^2 y = 0$ , or  $y = k\pi$ , where  $k$  is an integer.



Exercises 2.2

33. The singular solution  $y = 1$  satisfies the initial-value problem.

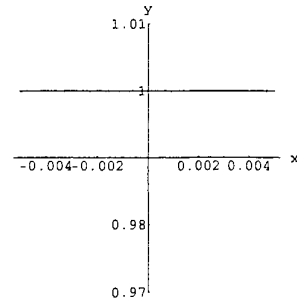

34. Separating variables we obtain  $\frac{dy}{(y-1)^2} = dx$ . Then

$$-\frac{1}{y-1} = x + c \quad \text{and} \quad y = \frac{x+c-1}{x+c}.$$

Setting  $x = 0$  and  $y = 1.01$  we obtain  $c = -100$ . The solution is

$$y = \frac{x-101}{x-100}.$$

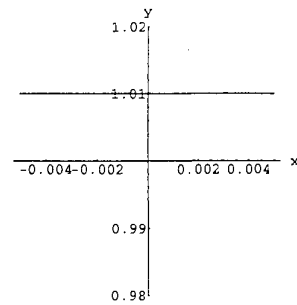

35. Separating variables we obtain  $\frac{dy}{(y-1)^2 + 0.01} = dx$ . Then

$$10 \tan^{-1} 10(y-1) = x + c \quad \text{and} \quad y = 1 + \frac{1}{10} \tan \frac{x+c}{10}.$$

Setting  $x = 0$  and  $y = 1$  we obtain  $c = 0$ . The solution is

$$y = 1 + \frac{1}{10} \tan \frac{x}{10}.$$

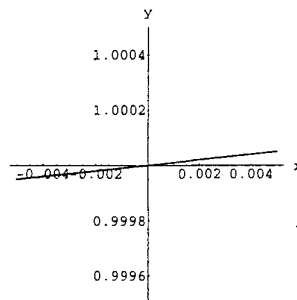

36. Separating variables we obtain  $\frac{dy}{(y-1)^2 - 0.01} = dx$ . Then

$$5 \ln \left| \frac{10y-11}{10y-9} \right| = x + c.$$

Setting  $x = 0$  and  $y = 1$  we obtain  $c = 5 \ln 1 = 0$ . The solution is

$$5 \ln \left| \frac{10y-11}{10y-9} \right| = x.$$

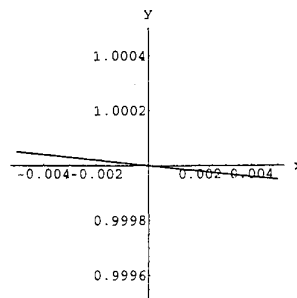

## Exercises 2.2

37. Separating variables, we have

$$\frac{dy}{y-y^3} = \frac{dy}{y(1-y)(1+y)} = \left(\frac{1}{y} + \frac{1/2}{1-y} - \frac{1/2}{1+y}\right)dy = dx.$$

Integrating, we get

$$\ln|y| - \frac{1}{2}\ln|1-y| - \frac{1}{2}\ln|1+y| = x + c.$$

When  $y > 1$ , this becomes

$$\ln y - \frac{1}{2}\ln(y-1) - \frac{1}{2}\ln(y+1) = \ln \frac{y}{\sqrt{y^2-1}} = x + c.$$

Letting  $x = 0$  and  $y = 2$  we find  $c = \ln(2/\sqrt{3})$ . Solving for  $y$  we get  $y_1(x) = 2e^x/\sqrt{4e^{2x}-3}$ , where  $x > \ln(\sqrt{3}/2)$ .

When  $0 < y < 1$  we have

$$\ln y - \frac{1}{2}\ln(1-y) - \frac{1}{2}\ln(1+y) = \ln \frac{y}{\sqrt{1-y^2}} = x + c.$$

Letting  $x = 0$  and  $y = \frac{1}{2}$  we find  $c = \ln(1/\sqrt{3})$ . Solving for  $y$  we get  $y_2(x) = e^x/\sqrt{e^{2x}+3}$ , where  $-\infty < x < \infty$ .

When  $-1 < y < 0$  we have

$$\ln(-y) - \frac{1}{2}\ln(1-y) - \frac{1}{2}\ln(1+y) = \ln \frac{-y}{\sqrt{1-y^2}} = x + c.$$

Letting  $x = 0$  and  $y = -\frac{1}{2}$  we find  $c = \ln(1/\sqrt{3})$ . Solving for  $y$  we get  $y_3(x) = -e^x/\sqrt{e^{2x}+3}$ , where  $-\infty < x < \infty$ .

When  $y < -1$  we have

$$\ln(-y) - \frac{1}{2}\ln(1-y) - \frac{1}{2}\ln(-1-y) = \ln \frac{-y}{\sqrt{y^2-1}} = x + c.$$

Letting  $x = 0$  and  $y = -2$  we find  $c = \ln(2/\sqrt{3})$ . Solving for  $y$  we get  $y_4(x) = -2e^x/\sqrt{4e^{2x}-3}$ , where  $x > \ln(\sqrt{3}/2)$ .

Exercises 2.2

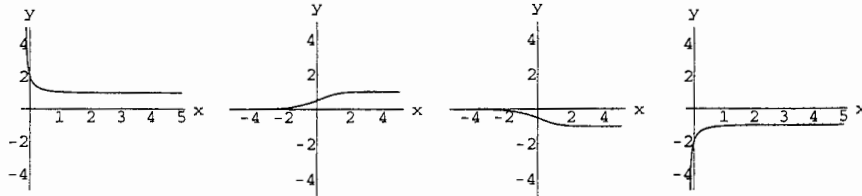

38. (a) The second derivative of  $y$  is

$$\frac{d^2y}{dx^2} = -\frac{dy/dx}{(y-1)^2} = -\frac{1/(y-3)}{(y-3)^2} = -\frac{1}{(y-3)^3}.$$

The solution curve is concave up when  $d^2y/dx^2 > 0$  or  $y > 3$ , and concave down when  $d^2y/dx^2 < 0$  or  $y < 3$ . From the phase portrait we see that the solution curve is decreasing when  $y < 3$  and increasing when  $y > 3$ .

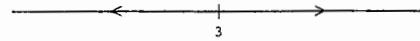
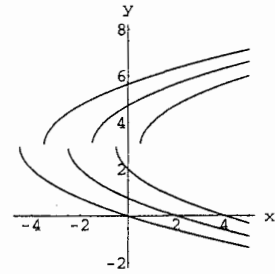

(b) Separating variables and integrating we obtain

$$\begin{aligned} (y-3) dy &= dx \\ \frac{1}{2}y^2 - 3y &= x + c \\ y^2 - 6y + 9 &= 2x + c_1 \\ (y-3)^2 &= 2x + c_1 \\ y &= 3 \pm \sqrt{2x + c_1}. \end{aligned}$$

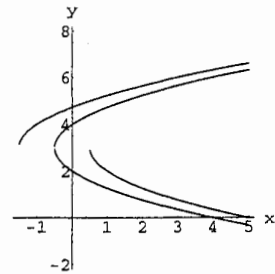

The initial condition dictates whether to use the plus or minus sign.

When  $y_1(0) = 4$  we have  $c_1 = 1$  and  $y_1(x) = 3 + \sqrt{2x+1}$ .

When  $y_2(0) = 2$  we have  $c_1 = 1$  and  $y_2(x) = 3 - \sqrt{2x+1}$ .

When  $y_3(1) = 2$  we have  $c_1 = -1$  and  $y_3(x) = 3 - \sqrt{2x-1}$ .

When  $y_4(-1) = 4$  we have  $c_1 = 3$  and  $y_4(x) = 3 + \sqrt{2x+3}$ .

39. (a) Separating variables we have  $2y dy = (2x+1)dx$ . Integrating gives  $y^2 = x^2 + x + c$ . When  $y(-2) = -1$  we find  $c = -1$ , so  $y^2 = x^2 + x - 1$  and  $y = -\sqrt{x^2 + x - 1}$ . The negative square root is chosen because of the initial condition.

## Exercises 2.2

(b) The interval of definition appears to be approximately  $(-\infty, -1.65)$ .

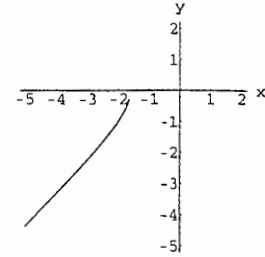

(c) Solving  $x^2 + x - 1 = 0$  we get  $x = -\frac{1}{2} \pm \frac{1}{2}\sqrt{5}$ , so the exact interval of definition is  $(-\infty, -\frac{1}{2} - \frac{1}{2}\sqrt{5})$ .

40. (a) From Problem 7 the general solution is  $3e^{-2y} + 2e^{3x} = c$ . When  $y(0) = 0$  we find  $c = 5$ , so  $3e^{-2y} + 2e^{3x} = 5$ . Solving for  $y$  we get  $y = -\frac{1}{2} \ln \frac{1}{3}(5 - 2e^{3x})$ .

(b) The interval of definition appears to be approximately  $(-\infty, 0.3)$ .

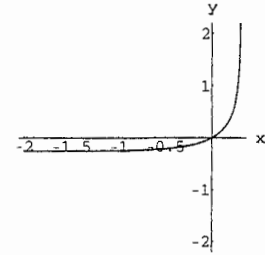

(c) Solving  $\frac{1}{3}(5 - 2e^{3x}) = 0$  we get  $x = \frac{1}{3} \ln(\frac{5}{2})$ , so the exact interval of definition is  $(-\infty, \frac{1}{3} \ln(\frac{5}{2}))$ .

41. (a) While  $y_2(x) = -\sqrt{25 - x^2}$  is defined at  $x = -5$  and  $x = 5$ ,  $y_2'(x)$  is not defined at these values, and so the interval of definition is the open interval  $(-5, 5)$ .

(b) At any point on the  $x$ -axis the derivative of  $y(x)$  is undefined, so no solution curve can cross the  $x$ -axis. Since  $-x/y$  is not defined when  $y = 0$ , the initial-value problem has no solution.

42. (a) Separating variables and integrating we obtain  $x^2 - y^2 = c$ . For  $c \neq 0$  the graph is a square hyperbola centered at the origin. All four initial conditions imply  $c = 0$  and  $y = \pm x$ . Since the differential equation is not defined for  $y = 0$ , solutions are  $y = \pm x$ ,  $x < 0$  and  $y = \pm x$ ,  $x > 0$ . The solution for  $y(a) = a$  is  $y = x$ ,  $x > 0$ ; for  $y(a) = -a$  is  $y = -x$ ; for  $y(-a) = a$  is  $y = -x$ ,  $x < 0$ ; and for  $y(-a) = -a$  is  $y = x$ ,  $x < 0$ .

(b) Since  $x/y$  is not defined when  $y = 0$ , the initial-value problem has no solution.

(c) Setting  $x = 1$  and  $y = 2$  in  $x^2 - y^2 = c$  we get  $c = -3$ , so  $y^2 = x^2 + 3$  and  $y(x) = \sqrt{x^2 + 3}$ , where the positive square root is chosen because of the initial condition. The domain is all real numbers since  $x^2 + 3 > 0$  for all  $x$ .

## Exercises 2.2

43. Separating variables we have  $dy/(\sqrt{1+y^2} \sin^2 y) = dx$  which is not readily integrated (even by a CAS). We note that  $dy/dx \geq 0$  for all values of  $x$  and  $y$  and that  $dy/dx = 0$  when  $y = 0$  and  $y = \pi$ , which are equilibrium solutions.

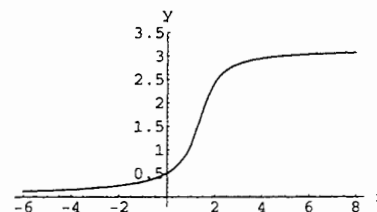

44. Separating variables we have  $dy/(\sqrt{y} + y) = dx/(\sqrt{x} + x)$ . To integrate  $\int dt/(\sqrt{t} + t)$  we substitute  $u^2 = t$  and get

$$\int \frac{2u}{u + u^2} du = \int \frac{2}{1 + u} du = 2 \ln |1 + u| + c = 2 \ln(1 + \sqrt{x}) + c.$$

Integrating the separated differential equation we have

$$2 \ln(1 + \sqrt{y}) = 2 \ln(1 + \sqrt{x}) + c \quad \text{or} \quad \ln(1 + \sqrt{y}) = \ln(1 + \sqrt{x}) + \ln c_1.$$

Solving for  $y$  we get  $y = [c_1(1 + \sqrt{x}) - 1]^2$ .

45. We are looking for a function  $y(x)$  such that

$$y^2 + \left(\frac{dy}{dx}\right)^2 = 1.$$

Using the positive square root gives

$$\frac{dy}{dx} = \sqrt{1 - y^2} \implies \frac{dy}{\sqrt{1 - y^2}} = dx \implies \sin^{-1} y = x + c.$$

Thus a solution is  $y = \sin(x + c)$ . If we use the negative square root we obtain

$$y = \sin(c - x) = -\sin(x - c) = -\sin(x + c_1).$$

Note also that  $y = 1$  and  $y = -1$  are solutions.

46. (a)

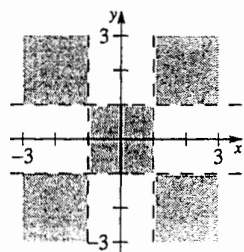

- (b) For  $|x| > 1$  and  $|y| > 1$  the differential equation is  $dy/dx = \sqrt{y^2 - 1}/\sqrt{x^2 - 1}$ . Separating variables and integrating, we obtain

$$\frac{dy}{\sqrt{y^2 - 1}} = \frac{dx}{\sqrt{x^2 - 1}} \quad \text{and} \quad \cosh^{-1} y = \cosh^{-1} x + c.$$

## Exercises 2.2

Setting  $x = 2$  and  $y = 2$  we find  $c = \cosh^{-1} 2 - \cosh^{-1} 2 = 0$  and  $\cosh^{-1} y = \cosh^{-1} x$ . An explicit solution is  $y = x$ .

47. (a) Separating variables and integrating, we have

$$(3y^2 + 1)dy = -(8x + 5)dx \quad \text{and} \quad y^3 + y = -4x^2 - 5x + c.$$

Using a CAS we show various contours of  $f(x, y) = y^3 + y + 4x^2 + 5x$ . The plots shown on  $[-5, 5] \times [-5, 5]$  correspond to  $c$ -values of 0,  $\pm 5$ ,  $\pm 20$ ,  $\pm 40$ ,  $\pm 80$ , and  $\pm 125$ .

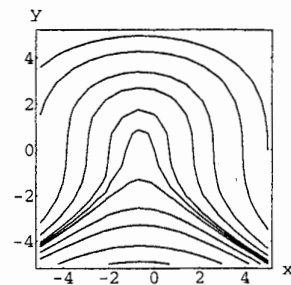

- (b) The value of  $c$  corresponding to  $y(0) = -1$  is  $f(0, -1) = -2$ ; to  $y(0) = 2$  is  $f(0, 2) = 10$ ; to  $y(-1) = 4$  is  $f(-1, 4) = 67$ ; and to  $y(-1) = -3$  is  $-31$ .

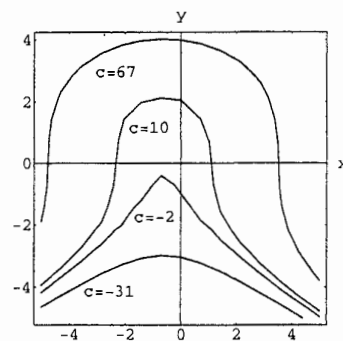

48. (a) Separating variables and integrating, we have

$$(-2y + y^2)dy = (x - x^2)dx$$

and

$$-y^2 + \frac{1}{3}y^3 = \frac{1}{2}x^2 - \frac{1}{3}x^3 + c.$$

Using a CAS we show some contours of  $f(x, y) = 2y^3 - 6y^2 + 2x^3 - 3x^2$ . The plots shown on  $[-7, 7] \times [-5, 5]$  correspond to  $c$ -values of  $-450$ ,  $-300$ ,  $-200$ ,  $-120$ ,  $-60$ ,  $-20$ ,  $-10$ ,  $-8.1$ ,  $-5$ ,  $-0.8$ ,  $20$ ,  $60$ , and  $120$ .

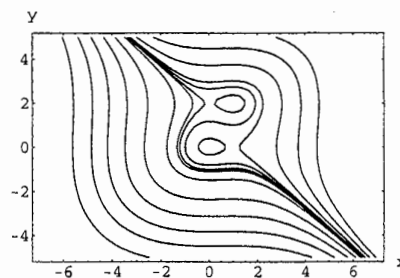

## Exercises 2.3

(b) The value of  $c$  corresponding to  $y(0) = \frac{3}{2}$  is  $f(0, \frac{3}{2}) = -\frac{27}{4}$ . The portion of the graph between the dots corresponds to the solution curve satisfying the initial condition. To determine the interval of definition we find  $dy/dx$  for  $2y^3 - 6y^2 + 2x^3 - 3x^2 = -\frac{27}{4}$ . Using implicit differentiation we get  $y' = (x - x^2)/(y^2 - 2y)$ , which is infinite when  $y = 0$  and  $y = 2$ . Letting  $y = 0$  in  $2y^3 - 6y^2 + 2x^3 - 3x^2 = -\frac{27}{4}$  and using a CAS to solve for  $x$  we get  $x = -1.13232$ . Similarly, letting  $y = 2$ , we find  $x = 1.71299$ . The largest interval of definition is approximately  $(-1.13232, 1.71299)$ .

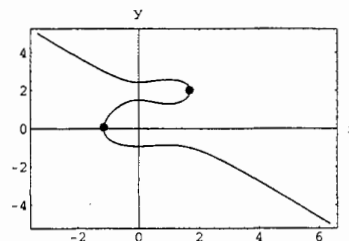

(c) The value of  $c$  corresponding to  $y(0) = -2$  is  $f(0, -2) = -40$ . The portion of the graph to the right of the dot corresponds to the solution curve satisfying the initial condition. To determine the interval of definition we find  $dy/dx$  for  $2y^3 - 6y^2 + 2x^3 - 3x^2 = -40$ . Using implicit differentiation we get  $y' = (x - x^2)/(y^2 - 2y)$ , which is infinite when  $y = 0$  and  $y = 2$ . Letting  $y = 0$  in  $2y^3 - 6y^2 + 2x^3 - 3x^2 = -40$  and using a CAS to solve for  $x$  we get  $x = -2.29551$ . The largest interval of definition is approximately  $(-2.29551, \infty)$ .

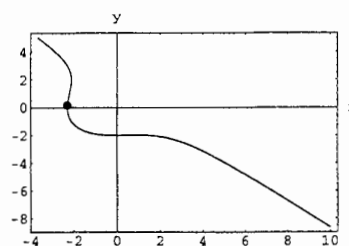

## Exercises 2.3

1. For  $y' - 5y = 0$  an integrating factor is  $e^{-\int 5 dx} = e^{-5x}$  so that  $\frac{d}{dx} [e^{-5x}y] = 0$  and  $y = ce^{5x}$  for  $-\infty < x < \infty$ .
2. For  $y' + 2y = 0$  an integrating factor is  $e^{\int 2 dx} = e^{2x}$  so that  $\frac{d}{dx} [e^{2x}y] = 0$  and  $y = ce^{-2x}$  for  $-\infty < x < \infty$ . The transient term is  $ce^{-2x}$ .
3. For  $y' + y = e^{3x}$  an integrating factor is  $e^{\int dx} = e^x$  so that  $\frac{d}{dx} [e^x y] = e^{4x}$  and  $y = \frac{1}{4}e^{3x} + ce^{-x}$  for  $-\infty < x < \infty$ . The transient term is  $ce^{-x}$ .
4. For  $y' + 4y = \frac{4}{3}$  an integrating factor is  $e^{\int 4 dx} = e^{4x}$  so that  $\frac{d}{dx} [e^{4x}y] = \frac{4}{3}e^{4x}$  and  $y = \frac{1}{3} + ce^{-4x}$  for  $-\infty < x < \infty$ . The transient term is  $ce^{-4x}$ .
5. For  $y' + 3x^2y = x^2$  an integrating factor is  $e^{\int 3x^2 dx} = e^{x^3}$  so that  $\frac{d}{dx} [e^{x^3}y] = x^2e^{x^3}$  and  $y = \frac{1}{3} + ce^{-x^3}$  for  $-\infty < x < \infty$ . The transient term is  $ce^{-x^3}$ .

### Exercises 2.3

6. For  $y' + 2xy = x^3$  an integrating factor is  $e^{\int 2x dx} = e^{x^2}$  so that  $\frac{d}{dx} [e^{x^2} y] = x^3 e^{x^2}$  and  $y = \frac{1}{2}x^2 - \frac{1}{2} + ce^{-x^2}$  for  $-\infty < x < \infty$ . The transient term is  $ce^{-x^2}$ .
7. For  $y' + \frac{1}{x}y = \frac{1}{x^2}$  an integrating factor is  $e^{\int (1/x) dx} = x$  so that  $\frac{d}{dx} [xy] = \frac{1}{x}$  and  $y = \frac{1}{x} \ln x + \frac{c}{x}$  for  $0 < x < \infty$ .
8. For  $y' - 2y = x^2 + 5$  an integrating factor is  $e^{-\int 2 dx} = e^{-2x}$  so that  $\frac{d}{dx} [e^{-2x} y] = x^2 e^{-2x} + 5e^{-2x}$  and  $y = -\frac{1}{2}x^2 - \frac{1}{2}x - \frac{11}{4} + ce^{2x}$  for  $-\infty < x < \infty$ .
9. For  $y' - \frac{1}{x}y = x \sin x$  an integrating factor is  $e^{-\int (1/x) dx} = \frac{1}{x}$  so that  $\frac{d}{dx} \left[ \frac{1}{x} y \right] = \sin x$  and  $y = cx - x \cos x$  for  $0 < x < \infty$ .
10. For  $y' + \frac{2}{x}y = \frac{3}{x}$  an integrating factor is  $e^{\int (2/x) dx} = x^2$  so that  $\frac{d}{dx} [x^2 y] = 3x$  and  $y = \frac{3}{2} + cx^{-2}$  for  $0 < x < \infty$ .
11. For  $y' + \frac{4}{x}y = x^2 - 1$  an integrating factor is  $e^{\int (4/x) dx} = x^4$  so that  $\frac{d}{dx} [x^4 y] = x^6 - x^4$  and  $y = \frac{1}{7}x^3 - \frac{1}{5}x + cx^{-4}$  for  $0 < x < \infty$ .
12. For  $y' - \frac{x}{(1+x)}y = x$  an integrating factor is  $e^{-\int [x/(1+x)] dx} = (x+1)e^{-x}$  so that  $\frac{d}{dx} [(x+1)e^{-x} y] = x(x+1)e^{-x}$  and  $y = -x - \frac{2x+3}{x+1} + \frac{ce^x}{x+1}$  for  $-1 < x < \infty$ .
13. For  $y' + \left(1 + \frac{2}{x}\right)y = \frac{e^x}{x^2}$  an integrating factor is  $e^{\int [1+(2/x)] dx} = x^2 e^x$  so that  $\frac{d}{dx} [x^2 e^x y] = e^{2x}$  and  $y = \frac{1}{2} \frac{e^x}{x^2} + \frac{ce^{-x}}{x^2}$  for  $0 < x < \infty$ . The transient term is  $\frac{ce^{-x}}{x^2}$ .
14. For  $y' + \left(1 + \frac{1}{x}\right)y = \frac{1}{x} e^{-x} \sin 2x$  an integrating factor is  $e^{\int [1+(1/x)] dx} = x e^x$  so that  $\frac{d}{dx} [x e^x y] = \sin 2x$  and  $y = -\frac{1}{2x} e^{-x} \cos 2x + \frac{ce^{-x}}{x}$  for  $0 < x < \infty$ . The entire solution is transient.
15. For  $\frac{dx}{dy} - \frac{4}{y}x = 4y^5$  an integrating factor is  $e^{-\int (4/y) dy} = y^{-4}$  so that  $\frac{d}{dy} [y^{-4} x] = 4y$  and  $x = 2y^6 + cy^4$  for  $0 < y < \infty$ .
16. For  $\frac{dx}{dy} + \frac{2}{y}x = e^y$  an integrating factor is  $e^{\int (2/y) dy} = y^2$  so that  $\frac{d}{dy} [y^2 x] = y^2 e^y$  and  $x = e^y - \frac{2}{y} e^y + \frac{2}{y^2} + \frac{c}{y^2}$  for  $0 < y < \infty$ . The transient term is  $\frac{2+c}{y^2}$ .



Exercises 2.3

17. For  $y' + (\tan x)y = \sec x$  an integrating factor is  $e^{\int \tan x dx} = \sec x$  so that  $\frac{d}{dx}[(\sec x)y] = \sec^2 x$  and  $y = \sin x + c \cos x$  for  $-\pi/2 < x < \pi/2$ .
18. For  $y' + (\cot x)y = \sec^2 x \csc x$  an integrating factor is  $e^{\int \cot x dx} = \sin x$  so that  $\frac{d}{dx}[(\sin x)y] = \sec^2 x$  and  $y = \sec x + c \csc x$  for  $0 < x < \pi/2$ .
19. For  $y' + \frac{x+2}{x+1}y = \frac{2xe^{-x}}{x+1}$  an integrating factor is  $e^{\int [(x+2)/(x+1)]dx} = (x+1)e^x$ , so  $\frac{d}{dx}[(x+1)e^xy] = 2x$  and  $y = \frac{x^2}{x+1}e^{-x} + \frac{c}{x+1}e^{-x}$  for  $-1 < x < \infty$ . The entire solution is transient.
20. For  $y' + \frac{4}{x+2}y = \frac{5}{(x+2)^2}$  an integrating factor is  $e^{\int [4/(x+2)]dx} = (x+2)^4$  so that  $\frac{d}{dx}[(x+2)^4y] = 5(x+2)^2$  and  $y = \frac{5}{3}(x+2)^{-1} + c(x+2)^{-4}$  for  $-2 < x < \infty$ . The entire solution is transient.
21. For  $\frac{dr}{d\theta} + r \sec \theta = \cos \theta$  an integrating factor is  $e^{\int \sec \theta d\theta} = \sec \theta + \tan \theta$  so that  $\frac{d}{d\theta}[r(\sec \theta + \tan \theta)] = 1 + \sin \theta$  and  $r(\sec \theta + \tan \theta) = \theta - \cos \theta + c$  for  $-\pi/2 < \theta < \pi/2$ .
22. For  $\frac{dP}{dt} + (2t-1)P = 4t-2$  an integrating factor is  $e^{\int (2t-1)dt} = e^{t^2-t}$  so that  $\frac{d}{dt}[Pe^{t^2-t}] = (4t-2)e^{t^2-t}$  and  $P = 2 + ce^{t-t^2}$  for  $-\infty < t < \infty$ . The transient term is  $ce^{t-t^2}$ .
23. For  $y' + \left(3 + \frac{1}{x}\right)y = \frac{e^{-3x}}{x}$  an integrating factor is  $e^{\int [3+(1/x)]dx} = xe^{3x}$  so that  $\frac{d}{dx}[xe^{3x}y] = 1$  and  $y = e^{-3x} + \frac{ce^{-3x}}{x}$  for  $0 < x < \infty$ . The transient term is  $ce^{-3x}/x$ .
24. For  $y' + \frac{2}{x^2-1}y = \frac{x+1}{x-1}$  an integrating factor is  $e^{\int [2/(x^2-1)]dx} = \frac{x-1}{x+1}$  so that  $\frac{d}{dx}\left[\frac{x-1}{x+1}y\right] = 1$  and  $(x-1)y = x(x+1) + c(x+1)$  for  $-1 < x < 1$ .
25. For  $y' + \frac{1}{x}y = \frac{1}{x}e^x$  an integrating factor is  $e^{\int (1/x)dx} = x$  so that  $\frac{d}{dx}[xy] = e^x$  and  $y = \frac{1}{x}e^x + \frac{c}{x}$  for  $0 < x < \infty$ . If  $y(1) = 2$  then  $c = 2 - e$  and  $y = \frac{1}{x}e^x + \frac{2-e}{x}$ .
26. For  $\frac{dx}{dy} - \frac{1}{y}x = 2y$  an integrating factor is  $e^{-\int (1/y)dy} = \frac{1}{y}$  so that  $\frac{d}{dy}\left[\frac{1}{y}x\right] = 2$  and  $x = 2y^2 + cy$  for  $-\infty < y < \infty$ . If  $y(1) = 5$  then  $c = -49/5$  and  $x = 2y^2 - \frac{49}{5}y$ .
27. For  $\frac{di}{dt} + \frac{R}{L}i = \frac{E}{L}$  an integrating factor is  $e^{\int (R/L)dt} = e^{Rt/L}$  so that  $\frac{d}{dt}[ie^{Rt/L}] = \frac{E}{L}e^{Rt/L}$  and  $i = \frac{E}{R} + ce^{-Rt/L}$  for  $-\infty < t < \infty$ . If  $i(0) = i_0$  then  $c = i_0 - E/R$  and  $i = \frac{E}{R} + \left(i_0 - \frac{E}{R}\right)e^{-Rt/L}$ .
28. For  $\frac{dT}{dt} - kT = -T_m k$  an integrating factor is  $e^{\int (-k)dt} = e^{-kt}$  so that  $\frac{d}{dt}[Te^{-kt}] = -T_m ke^{-kt}$  and  $T = T_m + ce^{kt}$  for  $-\infty < t < \infty$ . If  $T(0) = T_0$  then  $c = T_0 - T_m$  and  $T = T_m + (T_0 - T_m)e^{kt}$ .

### Exercises 2.3

29. For  $y' + \frac{1}{x+1}y = \frac{\ln x}{x+1}$  an integrating factor is  $e^{\int 1/(x+1)dx} = x+1$  so that  $\frac{d}{dx}[(x+1)y] = \ln x$  and  $y = \frac{x}{x+1} \ln x - \frac{x}{x+1} + \frac{c}{x+1}$  for  $0 < x < \infty$ . If  $y(1) = 10$  then  $c = 21$  and  $y = \frac{x}{x+1} \ln x - \frac{x}{x+1} + \frac{21}{x+1}$ .

30. For  $y' + (\tan x)y = \cos^2 x$  an integrating factor is  $e^{\int \tan x dx} = \sec x$  so that  $\frac{d}{dx}[(\sec x)y] = \cos x$  and  $y = \sin x \cos x + c \cos x$  for  $-\pi/2 < x < \pi/2$ . If  $y(0) = -1$  then  $c = -1$  and  $y = \sin x \cos x - \cos x$ .

31. For  $y' + 2y = f(x)$  an integrating factor is  $e^{2x}$  so that

$$ye^{2x} = \begin{cases} \frac{1}{2}e^{2x} + c_1, & 0 \leq x \leq 3; \\ c_2, & x > 3. \end{cases}$$

If  $y(0) = 0$  then  $c_1 = -1/2$  and for continuity we must have  $c_2 = \frac{1}{2}e^6 - \frac{1}{2}$  so that

$$y = \begin{cases} \frac{1}{2}(1 - e^{-2x}), & 0 \leq x \leq 3; \\ \frac{1}{2}(e^6 - 1)e^{-2x}, & x > 3. \end{cases}$$

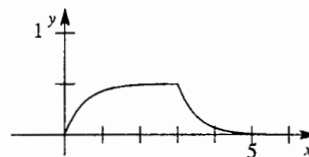

32. For  $y' + y = f(x)$  an integrating factor is  $e^x$  so that

$$ye^x = \begin{cases} e^x + c_1, & 0 \leq x \leq 1; \\ -e^x + c_2, & x > 1. \end{cases}$$

If  $y(0) = 1$  then  $c_1 = 0$  and for continuity we must have  $c_2 = 2e$  so that

$$y = \begin{cases} 1, & 0 \leq x \leq 1; \\ 2e^{1-x} - 1, & x > 1. \end{cases}$$

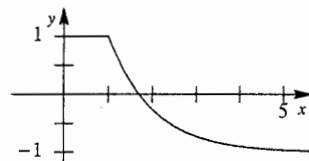

33. For  $y' + 2xy = f(x)$  an integrating factor is  $e^{x^2}$  so that

$$ye^{x^2} = \begin{cases} \frac{1}{2}e^{x^2} + c_1, & 0 \leq x \leq 1; \\ c_2, & x > 1. \end{cases}$$

If  $y(0) = 2$  then  $c_1 = 3/2$  and for continuity we must have  $c_2 = \frac{1}{2}e + \frac{3}{2}$  so that

$$y = \begin{cases} \frac{1}{2} + \frac{3}{2}e^{-x^2}, & 0 \leq x \leq 1; \\ \left(\frac{1}{2}e + \frac{3}{2}\right)e^{-x^2}, & x > 1. \end{cases}$$

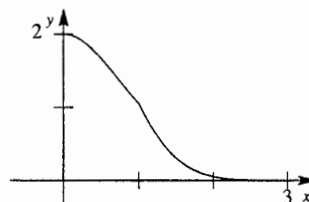

Exercises 2.3

34. For 
$$y' + \frac{2x}{1+x^2}y = \begin{cases} \frac{x}{1+x^2}, & 0 \leq x \leq 1; \\ \frac{-x}{1+x^2}, & x > 1 \end{cases}$$

an integrating factor is  $1+x^2$  so that

$$(1+x^2)y = \begin{cases} \frac{1}{2}x^2 + c_1, & 0 \leq x \leq 1; \\ -\frac{1}{2}x^2 + c_2, & x > 1. \end{cases}$$

If  $y(0) = 0$  then  $c_1 = 0$  and for continuity we must have  $c_2 = 1$  so that

$$y = \begin{cases} \frac{1}{2} - \frac{1}{2(1+x^2)}, & 0 \leq x \leq 1; \\ \frac{3}{2(1+x^2)} - \frac{1}{2}, & x > 1. \end{cases}$$

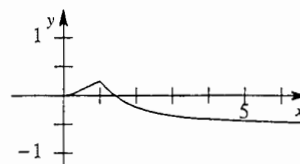

35. We need

$$\int P(x)dx = \begin{cases} 2x, & 0 \leq x \leq 1 \\ -2 \ln x, & x > 1 \end{cases}$$

An integrating factor is

$$e^{\int P(x)dx} = \begin{cases} e^{2x}, & 0 \leq x \leq 1 \\ 1/x^2, & x > 1 \end{cases}$$

and

$$\frac{d}{dx} \left[ \begin{cases} ye^{2x}, & 0 \leq x \leq 1 \\ y/x^2, & x > 1 \end{cases} \right] = \begin{cases} 4xe^{2x}, & 0 \leq x \leq 1 \\ 4/x, & x > 1 \end{cases}$$

Integrating we get

$$\begin{cases} ye^{2x}, & 0 \leq x \leq 1 \\ y/x^2, & x > 1 \end{cases} = \begin{cases} 2xe^{2x} - e^{2x} + c_1, & 0 \leq x \leq 1 \\ 4 \ln x + c_2, & x > 1 \end{cases}$$

Using  $y(0) = 3$  we find  $c_1 = 4$ . For continuity we must have  $c_2 = 2 - 1 + 4e^{-2} = 1 + 4e^{-2}$ . Then

$$y = \begin{cases} 2x - 1 + 4e^{-2x}, & 0 \leq x \leq 1 \\ 4x^2 \ln x + (1 + 4e^{-2})x^2, & x > 1 \end{cases}$$

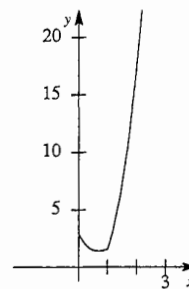

36. An integrating factor for  $y' - 2xy = 1$  is  $e^{-x^2}$ . Thus

$$\begin{aligned} \frac{d}{dx} [e^{-x^2}y] &= e^{-x^2} \\ e^{-x^2}y &= \int_0^x e^{-t^2} dt = \operatorname{erf}(x) + c \end{aligned}$$

and

$$y = e^{x^2} \operatorname{erf}(x) + ce^{x^2}.$$

### Exercises 2.3

From  $y(1) = 1$  we get  $1 = e \operatorname{erf}(1) + ce$ , so that  $c = e^{-1} - \operatorname{erf}(1)$ . Thus

$$y = e^{x^2} \operatorname{erf}(x) + (e^{-1} - \operatorname{erf}(1))e^{x^2} = e^{x^2-1} + e^{x^2}(\operatorname{erf}(x) - \operatorname{erf}(1)).$$

37. For  $y' + e^x y = 1$  an integrating factor is  $e^{e^x}$ . Thus

$$\frac{d}{dx} [e^{e^x} y] = e^{e^x} \quad \text{and} \quad e^{e^x} y = \int_0^x e^{e^t} dt + c.$$

From  $y(0) = 1$  we get  $c = e$ , so  $y = e^{-e^x} \int_0^x e^{e^t} dt + e^{1-e^x}$ .

When  $y' + e^x y = 0$  we can separate variables and integrate:

$$\frac{dy}{y} = -e^x dx \quad \text{and} \quad \ln |y| = -e^x + c.$$

Thus  $y = c_1 e^{-e^x}$ . From  $y(0) = 1$  we get  $c_1 = e$ , so  $y = e^{1-e^x}$ .

When  $y' + e^x y = e^x$  we can see by inspection that  $y = 1$  is a solution.

38. We want 4 to be a critical point, so use  $y' = 4 - y$ .

39. (a) All solutions of the form  $y = x^5 e^x - x^4 e^x + cx^4$  satisfy the initial condition. In this case, since  $4/x$  is discontinuous at  $x = 0$ , the hypotheses of Theorem 1.1 are not satisfied and the initial-value problem does not have a unique solution.

(b) The differential equation has no solution satisfying  $y(0) = y_0$ ,  $y_0 \neq 0$ .

(c) In this case, since  $x_0 \neq 0$ , Theorem 1.1 applies and the initial-value problem has a unique solution given by  $y = x^5 e^x - x^4 e^x + cx^4$  where  $c = y_0/x_0^4 - x_0 e^{x_0} + e^{x_0}$ .

40. On the interval  $(-3, 3)$  the integrating factor is

$$e^{\int x dx/(x^2-9)} = e^{-\int x dx/(9-x^2)} = e^{\frac{1}{2} \ln(9-x^2)} = \sqrt{9-x^2}$$

and so

$$\frac{d}{dx} [\sqrt{9-x^2} y] = 0 \quad \text{and} \quad y = \frac{c}{\sqrt{9-x^2}}.$$

41. We want the general solution to be  $y = 3x - 5 + ce^{-x}$ . (Rather than  $e^{-x}$ , any function that approaches 0 as  $x \rightarrow \infty$  could be used.) Differentiating we get

$$y' = 3 - ce^{-x} = 3 - (y - 3x + 5) = -y + 3x - 2,$$

so the differential equation  $y' + y = 3x - 2$  has solutions asymptotic to the line  $y = 3x - 5$ .

42. The left-hand derivative of the function at  $x = 1$  is  $1/e$  and the right-hand derivative at  $x = 1$  is  $1 - 1/e$ . Thus,  $y$  is not differentiable at  $x = 1$ .

43. (a) Differentiating  $y_c = c/x^3$  we get

$$y'_c = -\frac{3c}{x^4} = -\frac{3}{x} \frac{c}{x^3} = -\frac{3}{x} y_c$$

Exercises 2.3

so a differential equation with general solution  $y_c = c/x^3$  is  $xy' + 3y = 0$ . Now

$$xy'_p + 3y_p = x(3x^2) + 3(x^3) = 6x^3$$

so a differential equation with general solution  $y = c/x^3 + x^3$  is  $xy' + 3y = 6x^3$ . This will be a general solution on  $(0, \infty)$ .

- (b) Since  $y(1) = 1^3 - 1/1^3 = 0$ , an initial condition is  $y(1) = 0$ . Since  $y(1) = 1^3 + 2/1^3 = 3$ , an initial condition is  $y(1) = 3$ . In each case the interval of definition is  $(0, \infty)$ . The initial-value problem  $xy' + 3y = 6x^3$ ,  $y(0) = 0$  has solution  $y = x^3$  for  $-\infty < x < \infty$ .

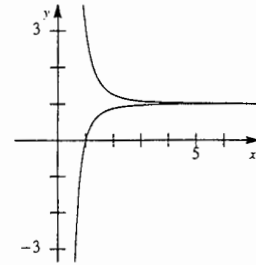

- (c) The first two initial-value problems in part (b) are not unique. For example, setting  $y(2) = 2^3 - 1/2^3 = 63/8$ , we see that  $y(2) = 63/8$  is also an initial condition leading to the solution  $y = x^3 - 1/x^3$ .

44. Since  $e^{\int P(x)dx+c} = e^c e^{\int P(x)dx} = c_1 e^{\int P(x)dx}$ , we would have

$$c_1 e^{\int P(x)dx} y = c_2 + \int c_1 e^{\int P(x)dx} f(x) dx \quad \text{and} \quad e^{\int P(x)dx} y = c_3 + \int e^{\int P(x)dx} f(x) dx,$$

which is the same as (6) in the text.

45. We see by inspection that  $y = 0$  is a solution.  
 46. The first equation can be solved by separation of variables. We obtain  $x = c_1 e^{-\lambda_1 t}$ . From  $x(0) = x_0$  we obtain  $c_1 = x_0$  and so  $x = x_0 e^{-\lambda_1 t}$ . The second equation then becomes

$$\frac{dy}{dt} = x_0 \lambda_1 e^{-\lambda_1 t} - \lambda_2 y \quad \text{or} \quad \frac{dy}{dt} + \lambda_2 y = x_0 \lambda_1 e^{-\lambda_1 t}$$

which is linear. An integrating factor is  $e^{\lambda_2 t}$ . Thus

$$\frac{d}{dt} [e^{\lambda_2 t} y] = x_0 \lambda_1 e^{-\lambda_1 t} e^{\lambda_2 t} = x_0 \lambda_1 e^{(\lambda_2 - \lambda_1)t}$$

$$e^{\lambda_2 t} y = \frac{x_0 \lambda_1}{\lambda_2 - \lambda_1} e^{(\lambda_2 - \lambda_1)t} + c_2$$

$$y = \frac{x_0 \lambda_1}{\lambda_2 - \lambda_1} e^{-\lambda_1 t} + c_2 e^{-\lambda_2 t}.$$

From  $y(0) = y_0$  we obtain  $c_2 = (y_0 \lambda_2 - y_0 \lambda_1 - x_0 \lambda_1)/(\lambda_2 - \lambda_1)$ . The solution is

$$y = \frac{x_0 \lambda_1}{\lambda_2 - \lambda_1} e^{-\lambda_1 t} + \frac{y_0 \lambda_2 - y_0 \lambda_1 - x_0 \lambda_1}{\lambda_2 - \lambda_1} e^{-\lambda_2 t}.$$

### Exercises 2.3

47. (a) Letting  $y = y_1 + y_2$  we have  $y(x_0) = y_1(x_0) + y_2(x_0) = \alpha + 0 = \alpha$  and

$$\begin{aligned} y' + P(x)y &= (y_1 + y_2)' + P(x)(y_1 + y_2) \\ &= (y_1' + P(x)y_1) + (y_2' + P(x)y_2) = 0 + f(x) = f(x). \end{aligned}$$

Thus  $y = y_1 + y_2$  is a solution of the initial-value problem  $y' + P(x)y = f(x)$ ,  $y(x_0) = \alpha$ .

- (b) By Theorem 1.1 the initial-value problem

$$y' + P(x)y = f_1(x) + f_2(x), \quad y(x_0) = \alpha + \beta \quad (1)$$

has a unique solution. Consider  $y = y_1 + y_2$ . Since  $y(x_0) = y_1(x_0) + y_2(x_0) = \alpha + \beta$ ,  $y$  satisfies the initial condition of (1). Also

$$\begin{aligned} y' + P(x)y &= (y_1 + y_2)' + P(x)(y_1 + y_2) \\ &= (y_1' + P(x)y_1) + (y_2' + P(x)y_2) = f_1(x) + f_2(x), \end{aligned}$$

so  $y$  satisfies the differential equation in (1). Thus  $y = y_1 + y_2$  is the unique solution of (1) and  $y(x_0) = \alpha + \beta$ .

Since  $c_1 y_1$  is a solution of  $y' + P(x)y = c_1 f_1(x)$ ,  $y(x_0) = c_1 \alpha$ , and  $c_2 y_2$  is a solution of  $y' + P(x)y = c_2 f_2(x)$ ,  $y(x_0) = c_2 \beta$ , we see by the above argument that  $y(x_0) = c_1 \alpha + c_2 \beta$ .

48. (a) An integrating factor for  $y' - 2xy = -1$  is  $e^{-x^2}$ . Thus

$$\begin{aligned} \frac{d}{dx}[e^{-x^2}y] &= -e^{-x^2} \\ e^{-x^2}y &= -\int_0^x e^{-t^2} dt = -\frac{\sqrt{\pi}}{2} \operatorname{erf}(x) + c. \end{aligned}$$

From  $y(0) = \sqrt{\pi}/2$ , and noting that  $\operatorname{erf}(0) = 0$ , we get  $c = \sqrt{\pi}/2$ . Thus

$$y = e^{x^2} \left( -\frac{\sqrt{\pi}}{2} \operatorname{erf}(x) + \frac{\sqrt{\pi}}{2} \right) = \frac{\sqrt{\pi}}{2} e^{x^2} (1 - \operatorname{erf}(x)) = \frac{\sqrt{\pi}}{2} e^{x^2} \operatorname{erfc}(x).$$

- (b) Using *Mathematica* we find  $y(2) \approx 0.226339$ .

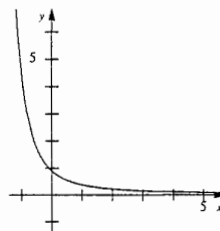

49. (a) An integrating factor for

$$y' + \frac{2}{x}y = \frac{10 \sin x}{x^3}$$

Exercises 2.3

is  $x^2$ . Thus

$$\begin{aligned}\frac{d}{dx}[x^2y] &= 10\frac{\sin x}{x} \\ x^2y &= 10\int_0^x \frac{\sin t}{t} dt + c \\ y &= 10x^{-2}\text{Si}(x) + cx^{-2}.\end{aligned}$$

From  $y(1) = 0$  we get  $c = -10\text{Si}(1)$ . Thus

$$y = 10x^{-2}\text{Si}(x) - 10x^{-2}\text{Si}(1) = 10x^{-2}(\text{Si}(x) - \text{Si}(1)).$$

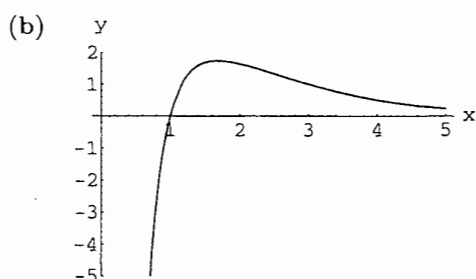

- (c) From the graph in part (b) we see that the absolute maximum occurs around  $x = 1.7$ . Using the root-finding capability of a CAS and solving  $y'(x) = 0$  for  $x$  we see that the absolute maximum is  $(1.688, 1.742)$ .

50. (a) Separating variables and integrating, we have

$$\frac{dy}{y} = \sin x^2 dx \quad \text{and} \quad \ln|y| = \int_0^x \sin t^2 dt + c.$$

Now, letting  $t = \sqrt{\pi/2}u$  we have

$$\int_0^x \sin t^2 dt = \sqrt{\frac{\pi}{2}} \int_0^{\sqrt{2/\pi}x} \sin\left(\frac{\pi}{2}u^2\right) du,$$

so

$$y = c_1 e^{\int_0^x \sin t^2 dt} = c_1 e^{\sqrt{\pi/2} \int_0^{\sqrt{2/\pi}x} \sin(\pi u^2/2) du} = c_1 e^{\sqrt{\pi/2} S(\sqrt{2/\pi}x)}.$$

Using  $S(0) = 0$  and  $y(0) = 5$  we see that  $c_1 = 5$  and  $y = 5e^{\sqrt{\pi/2} S(\sqrt{2/\pi}x)}$ .

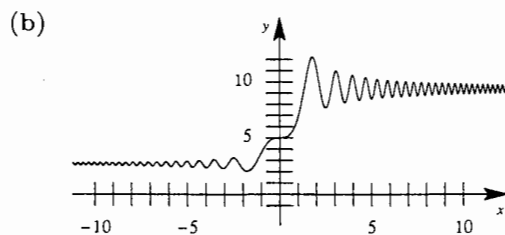

### Exercises 2.3

- (c) From the graph we see that as  $x \rightarrow \infty$ ,  $y(x)$  oscillates with decreasing amplitude approaching 9.35672. Since  $\lim_{x \rightarrow \infty} 5(x) = \frac{1}{2}$ ,  $\lim_{x \rightarrow \infty} y(x) = 5e^{\sqrt{\pi}/8} \approx 9.357$ , and since  $\lim_{x \rightarrow -\infty} S(x) = -\frac{1}{2}$ ,  $\lim_{x \rightarrow -\infty} y(x) = 5e^{-\sqrt{\pi}/8} \approx 2.672$ .
- (d) From the graph in part (b) we see that the absolute maximum occurs around  $x = 1.7$  and the absolute minimum occurs around  $x = -1.8$ . Using the root-finding capability of a CAS and solving  $y'(x) = 0$  for  $x$ , we see that the absolute maximum is (1.772, 12.235) and the absolute minimum is (-1.772, 2.044).

---

### Exercises 2.4

---

1. Let  $M = 2x - 1$  and  $N = 3y + 7$  so that  $M_y = 0 = N_x$ . From  $f_x = 2x - 1$  we obtain  $f = x^2 - x + h(y)$ ,  $h'(y) = 3y + 7$ , and  $h(y) = \frac{3}{2}y^2 + 7y$ . The solution is  $x^2 - x + \frac{3}{2}y^2 + 7y = c$ .
2. Let  $M = 2x + y$  and  $N = -x - 6y$ . Then  $M_y = 1$  and  $N_x = -1$ , so the equation is not exact.
3. Let  $M = 5x + 4y$  and  $N = 4x - 8y^3$  so that  $M_y = 4 = N_x$ . From  $f_x = 5x + 4y$  we obtain  $f = \frac{5}{2}x^2 + 4xy + h(y)$ ,  $h'(y) = -8y^3$ , and  $h(y) = -2y^4$ . The solution is  $\frac{5}{2}x^2 + 4xy - 2y^4 = c$ .
4. Let  $M = \sin y - y \sin x$  and  $N = \cos x + x \cos y - y$  so that  $M_y = \cos y - \sin x = N_x$ . From  $f_x = \sin y - y \sin x$  we obtain  $f = x \sin y + y \cos x + h(y)$ ,  $h'(y) = -y$ , and  $h(y) = -\frac{1}{2}y^2$ . The solution is  $x \sin y + y \cos x - \frac{1}{2}y^2 = c$ .
5. Let  $M = 2y^2x - 3$  and  $N = 2yx^2 + 4$  so that  $M_y = 4xy = N_x$ . From  $f_x = 2y^2x - 3$  we obtain  $f = x^2y^2 - 3x + h(y)$ ,  $h'(y) = 4$ , and  $h(y) = 4y$ . The solution is  $x^2y^2 - 3x + 4y = c$ .
6. Let  $M = 4x^3 - 3y \sin 3x - y/x^2$  and  $N = 2y - 1/x + \cos 3x$  so that  $M_y = -3 \sin 3x - 1/x^2$  and  $N_x = 1/x^2 - 3 \sin 3x$ . The equation is not exact.
7. Let  $M = x^2 - y^2$  and  $N = x^2 - 2xy$  so that  $M_y = -2y$  and  $N_x = 2x - 2y$ . The equation is not exact.
8. Let  $M = 1 + \ln x + y/x$  and  $N = -1 + \ln x$  so that  $M_y = 1/x = N_x$ . From  $f_y = -1 + \ln x$  we obtain  $f = -y + y \ln x + h(x)$ ,  $h'(x) = 1 + \ln x$ , and  $h(x) = x \ln x$ . The solution is  $-y + y \ln x + x \ln x = c$ .
9. Let  $M = y^3 - y^2 \sin x - x$  and  $N = 3xy^2 + 2y \cos x$  so that  $M_y = 3y^2 - 2y \sin x = N_x$ . From  $f_x = y^3 - y^2 \sin x - x$  we obtain  $f = xy^3 + y^2 \cos x - \frac{1}{2}x^2 + h(y)$ ,  $h'(y) = 0$ , and  $h(y) = 0$ . The solution is  $xy^3 + y^2 \cos x - \frac{1}{2}x^2 = c$ .
10. Let  $M = x^3 + y^3$  and  $N = 3xy^2$  so that  $M_y = 3y^2 = N_x$ . From  $f_x = x^3 + y^3$  we obtain  $f = \frac{1}{4}x^4 + xy^3 + h(y)$ ,  $h'(y) = 0$ , and  $h(y) = 0$ . The solution is  $\frac{1}{4}x^4 + xy^3 = c$ .
11. Let  $M = y \ln y - e^{-xy}$  and  $N = 1/y + x \ln y$  so that  $M_y = 1 + \ln y + ye^{-xy}$  and  $N_x = \ln y$ . The equation is not exact.



Exercises 2.4

12. Let  $M = 3x^2y + e^y$  and  $N = x^3 + xe^y - 2y$  so that  $M_y = 3x^2 + e^y = N_x$ . From  $f_x = 3x^2y + e^y$  we obtain  $f = x^3y + xe^y + h(y)$ ,  $h'(y) = -2y$ , and  $h(y) = -y^2$ . The solution is  $x^3y + xe^y - y^2 = c$ .
13. Let  $M = y - 6x^2 - 2xe^x$  and  $N = x$  so that  $M_y = 1 = N_x$ . From  $f_x = y - 6x^2 - 2xe^x$  we obtain  $f = xy - 2x^3 - 2xe^x + h(y)$ ,  $h'(y) = 0$ , and  $h(y) = 0$ . The solution is  $xy - 2x^3 - 2xe^x + 2e^x = c$ .
14. Let  $M = 1 - 3/x + y$  and  $N = 1 - 3/y + x$  so that  $M_y = 1 = N_x$ . From  $f_x = 1 - 3/x + y$  we obtain  $f = x - 3 \ln|x| + xy + h(y)$ ,  $h'(y) = 1 - \frac{3}{y}$ , and  $h(y) = y - 3 \ln|y|$ . The solution is  $x + y + xy - 3 \ln|xy| = c$ .
15. Let  $M = x^2y^3 - 1/(1 + 9x^2)$  and  $N = x^3y^2$  so that  $M_y = 3x^2y^2 = N_x$ . From  $f_x = x^2y^3 - 1/(1 + 9x^2)$  we obtain  $f = \frac{1}{3}x^3y^3 - \frac{1}{3} \arctan(3x) + h(y)$ ,  $h'(y) = 0$ , and  $h(y) = 0$ . The solution is  $x^3y^3 - \arctan(3x) = c$ .
16. Let  $M = -2y$  and  $N = 5y - 2x$  so that  $M_y = -2 = N_x$ . From  $f_x = -2y$  we obtain  $f = -2xy + h(y)$ ,  $h'(y) = 5y$ , and  $h(y) = \frac{5}{2}y^2$ . The solution is  $-2xy + \frac{5}{2}y^2 = c$ .
17. Let  $M = \tan x - \sin x \sin y$  and  $N = \cos x \cos y$  so that  $M_y = -\sin x \cos y = N_x$ . From  $f_x = \tan x - \sin x \sin y$  we obtain  $f = \ln|\sec x| + \cos x \sin y + h(y)$ ,  $h'(y) = 0$ , and  $h(y) = 0$ . The solution is  $\ln|\sec x| + \cos x \sin y = c$ .
18. Let  $M = 2y \sin x \cos x - y + 2y^2e^{xy^2}$  and  $N = -x + \sin^2 x + 4xye^{xy^2}$  so that

$$M_y = 2 \sin x \cos x - 1 + 4xy^3e^{xy^2} + 4ye^{xy^2} = N_x.$$

From  $f_x = 2y \sin x \cos x - y + 2y^2e^{xy^2}$  we obtain  $f = y \sin^2 x - xy + 2e^{xy^2} + h(y)$ ,  $h'(y) = 0$ , and  $h(y) = 0$ . The solution is  $y \sin^2 x - xy + 2e^{xy^2} = c$ .

19. Let  $M = 4t^3y - 15t^2 - y$  and  $N = t^4 + 3y^2 - t$  so that  $M_y = 4t^3 - 1 = N_t$ . From  $f_t = 4t^3y - 15t^2 - y$  we obtain  $f = t^4y - 5t^3 - ty + h(y)$ ,  $h'(y) = 3y^2$ , and  $h(y) = y^3$ . The solution is  $t^4y - 5t^3 - ty + y^3 = c$ .
20. Let  $M = 1/t + 1/t^2 - y/(t^2 + y^2)$  and  $N = ye^y + t/(t^2 + y^2)$  so that  $M_y = (y^2 - t^2)/(t^2 + y^2)^2 = N_t$ . From  $f_t = 1/t + 1/t^2 - y/(t^2 + y^2)$  we obtain  $f = \ln|t| - \frac{1}{t} - \arctan\left(\frac{t}{y}\right) + h(y)$ ,  $h'(y) = ye^y$ , and  $h(y) = ye^y - e^y$ . The solution is

$$\ln|t| - \frac{1}{t} - \arctan\left(\frac{t}{y}\right) + ye^y - e^y = c.$$

21. Let  $M = x^2 + 2xy + y^2$  and  $N = 2xy + x^2 - 1$  so that  $M_y = 2(x + y) = N_x$ . From  $f_x = x^2 + 2xy + y^2$  we obtain  $f = \frac{1}{3}x^3 + x^2y + xy^2 + h(y)$ ,  $h'(y) = -1$ , and  $h(y) = -y$ . The general solution is  $\frac{1}{3}x^3 + x^2y + xy^2 - y = c$ . If  $y(1) = 1$  then  $c = 4/3$  and the solution of the initial-value problem is  $\frac{1}{3}x^3 + x^2y + xy^2 - y = \frac{4}{3}$ .

## Exercises 2.4

22. Let  $M = e^x + y$  and  $N = 2 + x + ye^y$  so that  $M_y = 1 = N_x$ . From  $f_x = e^x + y$  we obtain  $f = e^x + xy + h(y)$ ,  $h'(y) = 2 + ye^y$ , and  $h(y) = 2y + ye^y - y$ . The general solution is  $e^x + xy + 2y + ye^y - e^y = c$ . If  $y(0) = 1$  then  $c = 3$  and the solution of the initial-value problem is  $e^x + xy + 2y + ye^y - e^y = 3$ .
23. Let  $M = 4y + 2t - 5$  and  $N = 6y + 4t - 1$  so that  $M_y = 4 = N_t$ . From  $f_t = 4y + 2t - 5$  we obtain  $f = 4ty + t^2 - 5t + h(y)$ ,  $h'(y) = 6y - 1$ , and  $h(y) = 3y^2 - y$ . The general solution is  $4ty + t^2 - 5t + 3y^2 - y = c$ . If  $y(-1) = 2$  then  $c = 8$  and the solution of the initial-value problem is  $4ty + t^2 - 5t + 3y^2 - y = 8$ .
24. Let  $M = t/2y^4$  and  $N = (3y^2 - t^2)/y^5$  so that  $M_y = -2t/y^5 = N_t$ . From  $f_t = t/2y^4$  we obtain  $f = \frac{t^2}{4y^4} + h(y)$ ,  $h'(y) = \frac{3}{y^3}$ , and  $h(y) = -\frac{3}{2y^2}$ . The general solution is  $\frac{t^2}{4y^4} - \frac{3}{2y^2} = c$ . If  $y(1) = 1$  then  $c = -5/4$  and the solution of the initial-value problem is  $\frac{t^2}{4y^4} - \frac{3}{2y^2} = -\frac{5}{4}$ .
25. Let  $M = y^2 \cos x - 3x^2y - 2x$  and  $N = 2y \sin x - x^3 + \ln y$  so that  $M_y = 2y \cos x - 3x^2 = N_x$ . From  $f_x = y^2 \cos x - 3x^2y - 2x$  we obtain  $f = y^2 \sin x - x^3y - x^2 + h(y)$ ,  $h'(y) = \ln y$ , and  $h(y) = y \ln y - y$ . The general solution is  $y^2 \sin x - x^3y - x^2 + y \ln y - y = c$ . If  $y(0) = e$  then  $c = 0$  and the solution of the initial-value problem is  $y^2 \sin x - x^3y - x^2 + y \ln y - y = 0$ .
26. Let  $M = y^2 + y \sin x$  and  $N = 2xy - \cos x - 1/(1 + y^2)$  so that  $M_y = 2y + \sin x = N_x$ . From  $f_x = y^2 + y \sin x$  we obtain  $f = xy^2 - y \cos x + h(y)$ ,  $h'(y) = \frac{-1}{1 + y^2}$ , and  $h(y) = -\tan^{-1} y$ . The general solution is  $xy^2 - y \cos x - \tan^{-1} y = c$ . If  $y(0) = 1$  then  $c = -1 - \pi/4$  and the solution of the initial-value problem is  $xy^2 - y \cos x - \tan^{-1} y = -1 - \frac{\pi}{4}$ .
27. Equating  $M_y = 3y^2 + 4kxy^3$  and  $N_x = 3y^2 + 40xy^3$  we obtain  $k = 10$ .
28. Equating  $M_y = 18xy^2 - \sin y$  and  $N_x = 4kxy^2 - \sin y$  we obtain  $k = 9/2$ .
29. Let  $M = -x^2y^2 \sin x + 2xy^2 \cos x$  and  $N = 2x^2y \cos x$  so that  $M_y = -2x^2y \sin x + 4xy \cos x = N_x$ . From  $f_y = 2x^2y \cos x$  we obtain  $f = x^2y^2 \cos x + h(y)$ ,  $h'(y) = 0$ , and  $h(y) = 0$ . The solution of the differential equation is  $x^2y^2 \cos x = c$ .
30. Let  $M = (x^2 + 2xy - y^2)/(x^2 + 2xy + y^2)$  and  $N = (y^2 + 2xy - x^2)/(y^2 + 2xy + x^2)$  so that  $M_y = -4xy/(x + y)^3 = N_x$ . From  $f_x = (x^2 + 2xy + y^2 - 2y^2)/(x + y)^2$  we obtain  $f = x + \frac{2y^2}{x + y} + h(y)$ ,  $h'(y) = -1$ , and  $h(y) = -y$ . The solution of the differential equation is  $x^2 + y^2 = c(x + y)$ .
31. We note that  $(M_y - N_x)/N = 1/x$ , so an integrating factor is  $e^{\int dx/x} = x$ . Let  $M = 2xy^2 + 3x^2$  and  $N = 2x^2y$  so that  $M_y = 4xy = N_x$ . From  $f_x = 2xy^2 + 3x^2$  we obtain  $f = x^2y^2 + x^3 + h(y)$ ,  $h'(y) = 0$ , and  $h(y) = 0$ . The solution of the differential equation is  $x^2y^2 + x^3 = c$ .
32. We note that  $(M_y - N_x)/N = 1$ , so an integrating factor is  $e^{\int dx} = e^x$ . Let  $M = xye^x + y^2e^x + ye^x$

## Exercises 2.4

and  $N = xe^x + 2ye^x$  so that  $M_y = xe^x + 2ye^x + e^x = N_x$ . From  $f_y = xe^x + 2ye^x$  we obtain  $f = xye^x + y^2e^x + h(x)$ ,  $h'(y) = 0$ , and  $h(y) = 0$ . The solution of the differential equation is  $xye^x + y^2e^x = c$ .

33. We note that  $(N_x - M_y)/M = 2/y$ , so an integrating factor is  $e^{\int 2dy/y} = y^2$ . Let  $M = 6xy^3$  and  $N = 4y^3 + 9x^2y^2$  so that  $M_y = 18xy^2 = N_x$ . From  $f_x = 6xy^3$  we obtain  $f = 3x^2y^3 + h(y)$ ,  $h'(y) = 4y^3$ , and  $h(y) = y^4$ . The solution of the differential equation is  $3x^2y^3 + y^4 = c$ .

34. We note that  $(M_y - N_x)/N = -\cot x$ , so an integrating factor is  $e^{-\int \cot x dx} = \csc x$ . Let  $M = \cos x \csc x = \cot x$  and  $N = (1 + 2/y) \sin x \csc x = 1 + 2/y$ , so that  $M_y = 0 = N_x$ . From  $f_x = \cot x$  we obtain  $f = \ln(\sin x) + h(y)$ ,  $h'(y) = 1 + 2/y$ , and  $h(y) = y + \ln y^2$ . The solution of the differential equation is  $\ln(\sin x) + y + \ln y^2 = c$ .

35. We note that  $(M_y - N_x)/N = 3$ , so an integrating factor is  $e^{\int 3 dx} = e^{3x}$ . Let

$$M = (10 - 6y + e^{-3x})e^{3x} = 10e^{3x} - 6ye^{3x} + 1$$

and

$$N = -2e^{3x},$$

so that  $M_y = -6e^{3x} + N_x$ . From  $f_x = 10e^{3x} - 6ye^{3x} + 1$  we obtain  $f = \frac{10}{3}e^{3x} - 2ye^{3x} + x + h(y)$ ,  $h'(y) = 0$ , and  $h(y) = 0$ . The solution of the differential equation is  $\frac{10}{3}e^{3x} - 2ye^{3x} + x = c$ .

36. We note that  $(N_x - M_y)/M = -3/y$ , so an integrating factor is  $e^{-3 \int dy/y} = 1/y^3$ . Let

$$M = (y^2 + xy^3)/y^3 = 1/y + x$$

and

$$N = (5y^2 - xy + y^3 \sin y)/y^3 = 5/y - x/y^2 + \sin y,$$

so that  $M_y = -1/y^2 = N_x$ . From  $f_x = 1/y + x$  we obtain  $f = x/y + \frac{1}{2}x^2 + h(y)$ ,  $h'(y) = 5/y + \sin y$ , and  $h(y) = 5 \ln |y| - \cos y$ . The solution of the differential equation is  $x/y + \frac{1}{2}x^2 + 5 \ln |y| - \cos y = c$ .

37. We note that  $(M_y - N_x)/N = 2x/(4 + x^2)$ , so an integrating factor is  $e^{-2 \int x dx/(4+x^2)} = 1/(4 + x^2)$ . Let  $M = x/(4 + x^2)$  and  $N = (x^2y + 4y)/(4 + x^2) = y$ , so that  $M_y = 0 = N_x$ . From  $f_x = x/(4 + x^2)$  we obtain  $f = \frac{1}{2} \ln(4 + x^2) + h(y)$ ,  $h'(y) = y$ , and  $h(y) = \frac{1}{2}y^2$ . The solution of the differential equation is  $\frac{1}{2} \ln(4 + x^2) + \frac{1}{2}y^2 = c$ .

38. We note that  $(M_y - N_x)/N = -3/(1 + x)$ , so an integrating factor is  $e^{-3 \int dx/(1+x)} = 1/(1+x)^3$ . Let  $M = (x^2 + y^2 - 5)/(1+x)^3$  and  $N = -(y + xy)/(1+x)^3 = -y/(1+x)^2$ , so that  $M_y = 2y/(1+x)^3 = N_x$ . From  $f_y = -y/(1+x)^2$  we obtain  $f = -\frac{1}{2}y^2/(1+x)^2 + h(x)$ ,  $h'(x) = (x^2 - 5)/(1+x)^3$ , and  $h(x) = 2/(1+x)^2 + 2/(1+x) + \ln |1+x|$ . The solution of the differential equation is

$$-\frac{y^2}{2(1+x)^2} + \frac{2}{(1+x)^2} + \frac{2}{(1+x)} + \ln |1+x| = c.$$

## Exercises 2.4

39. (a) Implicitly differentiating  $x^3 + 2x^2y + y^2 = c$  and solving for  $dy/dx$  we obtain

$$3x^2 + 2x^2 \frac{dy}{dx} + 4xy + 2y \frac{dy}{dx} = 0 \quad \text{and} \quad \frac{dy}{dx} = -\frac{3x^2 + 4xy}{2x^2 + 2y}$$

Separating variables we get  $(4xy + 3x^2)dx + (2y + 2x^2)dy = 0$ .

- (b) Setting  $x = 0$  and  $y = -2$  in  $x^3 + 2x^2y + y^2 = c$  we find  $c = 4$ , and setting  $x = y = 1$  we also find  $c = 4$ . Thus, both initial conditions determine the same implicit solution.

- (c) Solving  $x^3 + 2x^2y + y^2 = 4$  for  $y$  we get

$$y_1(x) = -x^2 - \sqrt{4 - x^3 + x^4}$$

and

$$y_2(x) = -x^2 + \sqrt{4 - x^3 + x^4}.$$

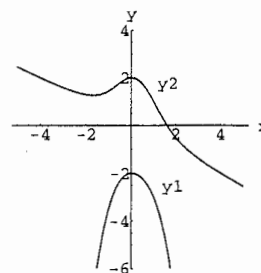

40. To see that the equations are not equivalent consider  $dx = (x/y)dy = 0$ . An integrating factor is  $\mu(x, y) = y$  resulting in  $y dx + x dy = 0$ . A solution of the latter equation is  $y = 0$ , but this is not a solution of the original equation.

41. The explicit solution is  $y = \sqrt{(3 + \cos^2 x)/(1 - x^2)}$ . Since  $3 + \cos^2 x > 0$  for all  $x$  we must have  $1 - x^2 > 0$  or  $-1 < x < 1$ . Thus, the interval of definition is  $(-1, 1)$ .

42. (a) Since  $f_y = N(x, y) = xe^{xy} + 2xy + 1/x$  we obtain  $f = e^{xy} + xy^2 + \frac{y}{x} + h(x)$  so that  $f_x = ye^{xy} + y^2 - \frac{y}{x^2} + h'(x)$ . Let  $M(x, y) = ye^{xy} + y^2 - \frac{y}{x^2}$ .

- (b) Since  $f_x = M(x, y) = y^{1/2}x^{-1/2} + x(x^2 + y)^{-1}$  we obtain  $f = 2y^{1/2}x^{1/2} + \frac{1}{2} \ln|x^2 + y| + g(y)$  so that  $f_y = y^{-1/2}x^{1/2} + \frac{1}{2}(x^2 + y)^{-1} + g'(y)$ . Let  $N(x, y) = y^{-1/2}x^{1/2} + \frac{1}{2}(x^2 + y)^{-1}$ .

43. First note that

$$d(\sqrt{x^2 + y^2}) = \frac{x}{\sqrt{x^2 + y^2}} dx + \frac{y}{\sqrt{x^2 + y^2}} dy.$$

Then  $x dx + y dy = \sqrt{x^2 + y^2} dx$  becomes

$$\frac{x}{\sqrt{x^2 + y^2}} dx + \frac{y}{\sqrt{x^2 + y^2}} dy = d(\sqrt{x^2 + y^2}) = dx.$$

The left side is the total differential of  $\sqrt{x^2 + y^2}$  and the right side is the total differential of  $x + c$ . Thus  $\sqrt{x^2 + y^2} = x + c$  is a solution of the differential equation.

44. To see that the statement is true, write the separable equation as  $-g(x) dx + dy/h(y)$ . Identifying  $M = -g(x)$  and  $N = 1/h(y)$ , we see that  $M_y = 0 = N_x$ , so the differential equation is exact.

---

**Exercises 2.5**

---

1. Letting  $y = ux$  we have

$$\begin{aligned}(x - ux) dx + x(u dx + x du) &= 0 \\ dx + x du &= 0 \\ \frac{dx}{x} + du &= 0 \\ \ln|x| + u &= c \\ x \ln|x| + y &= cx.\end{aligned}$$

2. Letting  $y = ux$  we have

$$\begin{aligned}(x + ux) dx + x(u dx + x du) &= 0 \\ (1 + 2u) dx + x du &= 0 \\ \frac{dx}{x} + \frac{du}{1 + 2u} &= 0 \\ \ln|x| + \frac{1}{2} \ln|1 + 2u| &= c \\ x^2 \left(1 + 2\frac{y}{x}\right) &= c_1 \\ x^2 + 2xy &= c_1.\end{aligned}$$

3. Letting  $x = vy$  we have

$$\begin{aligned}vy(v dy + y dv) + (y - 2vy) dy &= 0 \\ vy dv + (v^2 - 2v + 1) dy &= 0 \\ \frac{v dv}{(v - 1)^2} + \frac{dy}{y} &= 0 \\ \ln|v - 1| - \frac{1}{v - 1} + \ln|y| &= c \\ \ln\left|\frac{x}{y} - 1\right| - \frac{1}{x/y - 1} + \ln y &= c \\ (x - y) \ln|x - y| - y &= c(x - y).\end{aligned}$$

## Exercises 2.5

4. Letting  $x = vy$  we have

$$y(v dy + y dv) - 2(vy + y) dy = 0$$

$$y dv - (v + 2) dy = 0$$

$$\frac{dv}{v+2} - \frac{dy}{y} = 0$$

$$\ln|v+2| - \ln|y| = c$$

$$\ln\left|\frac{x}{y} + 2\right| - \ln|y| = c$$

$$x + 2y = c_1 y^2.$$

5. Letting  $y = ux$  we have

$$(u^2 x^2 + ux^2) dx - x^2(u dx + x du) = 0$$

$$u^2 dx - x du = 0$$

$$\frac{dx}{x} - \frac{du}{u^2} = 0$$

$$\ln|x| + \frac{1}{u} = c$$

$$\ln|x| + \frac{x}{y} = c$$

$$y \ln|x| + x = cy.$$

6. Letting  $y = ux$  we have

$$(u^2 x^2 + ux^2) dx + x^2(u dx + x du) = 0$$

$$(u^2 + 2u) dx + x du = 0$$

$$\frac{dx}{x} + \frac{du}{u(u+2)} = 0$$

$$\ln|x| + \frac{1}{2} \ln|u| - \frac{1}{2} \ln|u+2| = c$$

$$\frac{x^2 u}{u+2} = c_1$$

$$x^2 \frac{y}{x} = c_1 \left(\frac{y}{x} + 2\right)$$

$$x^2 y = c_1 (y + 2x).$$

7. Letting  $y = ux$  we have

$$(ux - x) dx - (ux + x)(u dx + x du) = 0$$

$$(u^2 + 1) dx + x(u + 1) du = 0$$

$$\frac{dx}{x} + \frac{u + 1}{u^2 + 1} du = 0$$

$$\ln |x| + \frac{1}{2} \ln(u^2 + 1) + \tan^{-1} u = c$$

$$\ln x^2 \left( \frac{y^2}{x^2} + 1 \right) + 2 \tan^{-1} \frac{y}{x} = c_1$$

$$\ln(x^2 + y^2) + 2 \tan^{-1} \frac{y}{x} = c_1.$$

8. Letting  $y = ux$  we have

$$(x + 3ux) dx - (3x + ux)(u dx + x du) = 0$$

$$(u^2 - 1) dx + x(u + 3) du = 0$$

$$\frac{dx}{x} + \frac{u + 3}{(u - 1)(u + 1)} du = 0$$

$$\ln |x| + 2 \ln |u - 1| - \ln |u + 1| = c$$

$$\frac{x(u - 1)^2}{u + 1} = c_1$$

$$x \left( \frac{y}{x} - 1 \right)^2 = c_1 \left( \frac{y}{x} + 1 \right)$$

$$(y - x)^2 = c_1(y + x).$$

9. Letting  $y = ux$  we have

$$-ux dx + (x + \sqrt{u}x)(u dx + x du) = 0$$

$$(x + x\sqrt{u}) du + u^{3/2} dx = 0$$

$$\left( u^{-3/2} + \frac{1}{u} \right) du + \frac{dx}{x} = 0$$

$$-2u^{-1/2} + \ln |u| + \ln |x| = c$$

$$\ln |y/x| + \ln |x| = 2\sqrt{x/y} + c$$

$$y(\ln |y| - c)^2 = 4x.$$

### Exercises 2.5

10. Letting  $y = ux$  we have

$$\begin{aligned} (ux + \sqrt{x^2 + u^2x^2}) dx - x(u dx + x du) &= 0 \\ x\sqrt{1+u^2} dx - x^2 du &= 0 \\ \frac{dx}{x} - \frac{du}{\sqrt{1+u^2}} &= 0 \\ \ln|x| - \ln|u + \sqrt{1+u^2}| &= c \\ u + \sqrt{1+u^2} &= c_1x \\ y + \sqrt{y^2 + x^2} &= c_1x^2. \end{aligned}$$

11. Letting  $y = ux$  we have

$$\begin{aligned} (x^3 - u^3x^3) dx + u^2x^3(u dx + x du) &= 0 \\ dx + u^2x du &= 0 \\ \frac{dx}{x} + u^2 du &= 0 \\ \ln|x| + \frac{1}{3}u^3 &= c \\ 3x^3 \ln|x| + y^3 &= c_1x^3. \end{aligned}$$

Using  $y(1) = 2$  we find  $c_1 = 8$ . The solution of the initial-value problem is  $3x^3 \ln|x| + y^3 = 8x^3$ .

12. Letting  $y = ux$  we have

$$\begin{aligned} (x^2 + 2u^2x^2) dx - ux^2(u dx + x du) &= 0 \\ (1 + u^2) dx - ux du &= 0 \\ \frac{dx}{x} - \frac{u du}{1+u^2} &= 0 \\ \ln|x| - \frac{1}{2} \ln(1+u^2) &= c \\ \frac{x^2}{1+u^2} &= c_1 \\ x^4 &= c_1(y^2 + x^2). \end{aligned}$$

Using  $y(-1) = 1$  we find  $c_1 = 1/2$ . The solution of the initial-value problem is  $2x^4 = y^2 + x^2$ .



Exercises 2.5

13. Letting  $y = ux$  we have

$$(x + uxe^u) dx - xe^u(u dx + x du) = 0$$

$$dx - xe^u du = 0$$

$$\frac{dx}{x} - e^u du = 0$$

$$\ln|x| - e^u = c$$

$$\ln|x| - e^{y/x} = c.$$

Using  $y(1) = 0$  we find  $c = -1$ . The solution of the initial-value problem is  $\ln|x| = e^{y/x} - 1$ .

14. Letting  $x = vy$  we have

$$y(v dy + y dv) + vy(\ln vy - \ln y - 1) dy = 0$$

$$y dv + v \ln v dy = 0$$

$$\frac{dv}{v \ln v} + \frac{dy}{y} = 0$$

$$\ln|\ln|v|| + \ln|y| = c$$

$$y \ln \left| \frac{x}{y} \right| = c_1.$$

Using  $y(1) = e$  we find  $c_1 = -e$ . The solution of the initial-value problem is  $y \ln \left| \frac{x}{y} \right| = -e$ .

15. From  $y' + \frac{1}{x}y = \frac{1}{x}y^{-2}$  and  $w = y^3$  we obtain  $\frac{dw}{dx} + \frac{3}{x}w = \frac{3}{x}$ . An integrating factor is  $x^3$  so that  $x^3w = x^3 + c$  or  $y^3 = 1 + cx^{-3}$ .
16. From  $y' - y = e^xy^2$  and  $w = y^{-1}$  we obtain  $\frac{dw}{dx} + w = -e^x$ . An integrating factor is  $e^x$  so that  $e^xw = -\frac{1}{2}e^{2x} + c$  or  $y^{-1} = -\frac{1}{2}e^x + ce^{-x}$ .
17. From  $y' + y = xy^4$  and  $w = y^{-3}$  we obtain  $\frac{dw}{dx} - 3w = -3x$ . An integrating factor is  $e^{-3x}$  so that  $e^{-3x} = xe^{-3x} + \frac{1}{3}e^{-3x} + c$  or  $y^{-3} = x + \frac{1}{3} + ce^{3x}$ .
18. From  $y' - \left(1 + \frac{1}{x}\right)y = y^2$  and  $w = y^{-1}$  we obtain  $\frac{dw}{dx} + \left(1 + \frac{1}{x}\right)w = -1$ . An integrating factor is  $xe^x$  so that  $xe^xw = -xe^x + e^x + c$  or  $y^{-1} = -1 + \frac{1}{x} + \frac{c}{x}e^{-x}$ .
19. From  $y' - \frac{1}{t}y = -\frac{1}{t^2}y^2$  and  $w = y^{-1}$  we obtain  $\frac{dw}{dt} + \frac{1}{t}w = \frac{1}{t^2}$ . An integrating factor is  $t$  so that

## Exercises 2.5

$tw = \ln t + c$  or  $y^{-1} = \frac{1}{t} \ln t + \frac{c}{t}$ . Writing this in the form  $\frac{t}{y} = \ln x + c$ , we see that the solution can also be expressed in the form  $e^{t/y} = c_1 x$ .

20. From  $y' + \frac{2}{3(1+t^2)}y = \frac{2t}{3(1+t^2)}y^4$  and  $w = y^{-3}$  we obtain  $\frac{dw}{dt} - \frac{2t}{1+t^2}w = \frac{-2t}{1+t^2}$ . An integrating factor is  $\frac{1}{1+t^2}$  so that  $\frac{w}{1+t^2} = \frac{1}{1+t^2} + c$  or  $y^{-3} = 1 + c(1+t^2)$ .
21. From  $y' - \frac{2}{x}y = \frac{3}{x^2}y^4$  and  $w = y^{-3}$  we obtain  $\frac{dw}{dx} + \frac{6}{x}w = -\frac{9}{x^2}$ . An integrating factor is  $x^6$  so that  $x^6 w = -\frac{9}{5}x^5 + c$  or  $y^{-3} = -\frac{9}{5}x^{-1} + cx^{-6}$ . If  $y(1) = \frac{1}{2}$  then  $c = \frac{49}{5}$  and  $y^{-3} = -\frac{9}{5}x^{-1} + \frac{49}{5}x^{-6}$ .
22. From  $y' + y = y^{-1/2}$  and  $w = y^{3/2}$  we obtain  $\frac{dw}{dx} + \frac{3}{2}w = \frac{3}{2}$ . An integrating factor is  $e^{3x/2}$  so that  $e^{3x/2}w = e^{3x/2} + c$  or  $y^{3/2} = 1 + ce^{-3x/2}$ . If  $y(0) = 4$  then  $c = 7$  and  $y^{3/2} = 1 + 7e^{-3x/2}$ .
23. Let  $u = x + y + 1$  so that  $du/dx = 1 + dy/dx$ . Then  $\frac{du}{dx} - 1 = u^2$  or  $\frac{1}{1+u^2} du = dx$ . Thus  $\tan^{-1} u = x + c$  or  $u = \tan(x + c)$ , and  $x + y + 1 = \tan(x + c)$  or  $y = \tan(x + c) - x - 1$ .
24. Let  $u = x + y$  so that  $du/dx = 1 + dy/dx$ . Then  $\frac{du}{dx} - 1 = \frac{1-u}{u}$  or  $u du = dx$ . Thus  $\frac{1}{2}u^2 = x + c$  or  $u^2 = 2x + c_1$ , and  $(x + y)^2 = 2x + c_1$ .
25. Let  $u = x + y$  so that  $du/dx = 1 + dy/dx$ . Then  $\frac{du}{dx} - 1 = \tan^2 u$  or  $\cos^2 u du = dx$ . Thus  $\frac{1}{2}u + \frac{1}{4}\sin 2u = x + c$  or  $2u + \sin 2u = 4x + c_1$ , and  $2(x + y) + \sin 2(x + y) = 4x + c_1$  or  $2y + \sin 2(x + y) = 2x + c_1$ .
26. Let  $u = x + y$  so that  $du/dx = 1 + dy/dx$ . Then  $\frac{du}{dx} - 1 = \sin u$  or  $\frac{1}{1 + \sin u} du = dx$ . Multiplying by  $(1 - \sin u)/(1 - \sin u)$  we have  $\frac{1 - \sin u}{\cos^2 u} du = dx$  or  $(\sec^2 u - \tan u \sec u) du = dx$ . Thus  $\tan u - \sec u = x + c$  or  $\tan(x + y) - \sec(x + y) = x + c$ .
27. Let  $u = y - 2x + 3$  so that  $du/dx = dy/dx - 2$ . Then  $\frac{du}{dx} + 2 = 2 + \sqrt{u}$  or  $\frac{1}{\sqrt{u}} du = dx$ . Thus  $2\sqrt{u} = x + c$  and  $2\sqrt{y - 2x + 3} = x + c$ .
28. Let  $u = y - x + 5$  so that  $du/dx = dy/dx - 1$ . Then  $\frac{du}{dx} + 1 = 1 + e^u$  or  $e^{-u} du = dx$ . Thus  $-e^{-u} = x + c$  and  $-e^{y-x+5} = x + c$ .
29. Let  $u = x + y$  so that  $du/dx = 1 + dy/dx$ . Then  $\frac{du}{dx} - 1 = \cos u$  and  $\frac{1}{1 + \cos u} du = dx$ . Now

$$\frac{1}{1 + \cos u} = \frac{1 - \cos u}{1 - \cos^2 u} = \frac{1 - \cos u}{\sin^2 u} = \csc^2 u - \csc u \cot u$$

Exercises 2.5

so we have  $\int(\csc^2 u - \csc u \cot u) du = \int dx$  and  $-\cot u + \csc u = x + c$ . Thus  $-\cot(x+y) + \csc(x+y) = x + c$ . Setting  $x = 0$  and  $y = \pi/4$  we obtain  $c = \sqrt{2} - 1$ . The solution is

$$\csc(x+y) - \cot(x+y) = x + \sqrt{2} - 1.$$

30. Let  $u = 3x + 2y$  so that  $du/dx = 3 + 2 dy/dx$ . Then  $\frac{du}{dx} = 3 + \frac{2u}{u+2} = \frac{5u+6}{u+2}$  and  $\frac{u+2}{5u+6} du = dx$ .  
Now

$$\frac{u+2}{5u+6} = \frac{1}{5} + \frac{4}{25u+30}$$

so we have

$$\int \left( \frac{1}{5} + \frac{4}{25u+30} \right) du = dx$$

and  $\frac{1}{5}u + \frac{4}{25} \ln|25u+30| = x + c$ . Thus

$$\frac{1}{5}(3x+2y) + \frac{4}{25} \ln|75x+50y+30| = x + c.$$

Setting  $x = -1$  and  $y = -1$  we obtain  $c = \frac{4}{5} \ln 95$ . The solution is

$$\frac{1}{5}(3x+2y) + \frac{4}{25} \ln|75x+50y+30| = x + \frac{4}{5} \ln 95$$

or

$$5y - 5x + 2 \ln|75x + 50y + 30| = 10 \ln 95.$$

31. We write the differential equation  $M(x,y)dx + N(x,y)dy = 0$  as  $dy/dx = f(x,y)$  where

$$f(x,y) = -\frac{M(x,y)}{N(x,y)}.$$

The function  $f(x,y)$  must necessarily be homogeneous of degree 0 when  $M$  and  $N$  are homogeneous of degree  $\alpha$ . Since  $M$  is homogeneous of degree  $\alpha$ ,  $M(tx,ty) = t^\alpha M(x,y)$ , and letting  $t = 1/x$  we have

$$M(1,y/x) = \frac{1}{x^\alpha} M(x,y) \quad \text{or} \quad M(x,y) = x^\alpha M(1,y/x).$$

Thus

$$\frac{dy}{dx} = f(x,y) = -\frac{x^\alpha M(1,y/x)}{x^\alpha N(1,y/x)} = -\frac{M(1,y/x)}{N(1,y/x)} = F\left(\frac{y}{x}\right).$$

To show that the differential equation also has the form

$$\frac{dy}{dx} = G\left(\frac{x}{y}\right)$$

we use the fact that  $M(x,y) = y^\alpha M(x/y,1)$ . The forms  $F(y/x)$  and  $G(x/y)$  suggest, respectively, the substitutions  $u = y/x$  or  $y = ux$  and  $v = x/y$  or  $x = vy$ .

## Exercises 2.5

32. As  $x \rightarrow -\infty$ ,  $e^{6x} \rightarrow 0$  and  $y \rightarrow 2x + 3$ . Now write  $(1 + ce^{6x})/(1 - ce^{6x})$  as  $(e^{-6x} + c)/(e^{-6x} - c)$ . Then, as  $x \rightarrow \infty$ ,  $e^{-6x} \rightarrow 0$  and  $y \rightarrow 2x - 3$ .
33. (a) The substitutions  $y = y_1 + u$  and

$$\frac{dy}{dx} = \frac{dy_1}{dx} + \frac{du}{dx}$$

lead to

$$\begin{aligned} \frac{dy_1}{dx} + \frac{du}{dx} &= P + Q(y_1 + u) + R(y_1 + u)^2 \\ &= P + Qy_1 + Ry_1^2 + Qu + 2y_1Ru + Ru^2 \end{aligned}$$

or

$$\frac{du}{dx} - (Q + 2y_1R)u = Ru^2.$$

This is a Bernoulli equation with  $n = 2$  which can be reduced to the linear equation

$$\frac{dw}{dx} + (Q + 2y_1R)w = -R$$

by the substitution  $w = u^{-1}$ .

- (b) Identify  $P(x) = -4/x^2$ ,  $Q(x) = -1/x$ , and  $R(x) = 1$ . Then  $\frac{dw}{dx} + \left(-\frac{1}{x} + \frac{4}{x}\right)w = -1$ . An integrating factor is  $x^3$  so that  $x^3w = -\frac{1}{4}x^4 + c$  or  $u = \left[-\frac{1}{4}x + cx^{-3}\right]^{-1}$ . Thus,  $y = \frac{2}{x} + u$ .
34. Write the differential equation in the form  $x(y'/y) = \ln x + \ln y$  and let  $u = \ln y$ . Then  $du/dx = y'/y$  and the differential equation becomes  $x(du/dx) = \ln x + u$  or  $du/dx - u/x = (\ln x)/x$ , which is first-order, linear. An integrating factor is  $e^{-\int dx/x} = 1/x$ , so that (using integration by parts)

$$\frac{d}{dx} \left[ \frac{1}{x} u \right] = \frac{\ln x}{x^2} \quad \text{and} \quad \frac{u}{x} = -\frac{1}{x} - \frac{\ln x}{x} + c.$$

The solution is

$$\ln y = -1 - \ln x + cx \quad \text{or} \quad y = \frac{e^{-cx-1}}{x}.$$

---

## Exercises 2.6

---

1. We identify  $f(x, y) = 2x - 3y + 1$ . Then, for  $h = 0.1$ ,

$$y_{n+1} = y_n + 0.1(2x_n - 3y_n + 1) = 0.2x_n + 0.7y_n + 0.1,$$

and

$$y(1.1) \approx y_1 = 0.2(1) + 0.7(5) + 0.1 = 3.8$$

$$y(1.2) \approx y_2 = 0.2(1.1) + 0.7(3.8) + 0.1 = 2.98.$$

For  $h = 0.05$

$$y_{n+1} = y_n + 0.05(2x_n - 3y_n + 1) = 0.1x_n + 0.85y_n + 0.1,$$

and

$$y(1.05) \approx y_1 = 0.1(1) + 0.85(5) + 0.1 = 4.4$$

$$y(1.1) \approx y_2 = 0.1(1.05) + 0.85(4.4) + 0.1 = 3.895$$

$$y(1.15) \approx y_3 = 0.1(1.1) + 0.85(3.895) + 0.1 = 3.47075$$

$$y(1.2) \approx y_4 = 0.1(1.15) + 0.85(3.47075) + 0.1 = 3.11514$$

2. We identify  $f(x, y) = x + y^2$ . Then, for  $h = 0.1$ ,

$$y_{n+1} = y_n + 0.1(x_n + y_n^2) = 0.1x_n + y_n + 0.1y_n^2,$$

and

$$y(0.1) \approx y_1 = 0.1(0) + 0 + 0.1(0)^2 = 0$$

$$y(0.2) \approx y_2 = 0.1(0.1) + 0 + 0.1(0)^2 = 0.01.$$

For  $h = 0.05$

$$y_{n+1} = y_n + 0.05(x_n + y_n^2) = 0.05x_n + y_n + 0.05y_n^2,$$

and

$$y(0.05) \approx y_1 = 0.05(0) + 0 + 0.05(0)^2 = 0$$

$$y(0.1) \approx y_2 = 0.05(0.05) + 0 + 0.05(0)^2 = 0.0025$$

$$y(0.15) \approx y_3 = 0.05(0.1) + 0.0025 + 0.05(0.0025)^2 = 0.0075$$

$$y(0.2) \approx y_4 = 0.05(0.15) + 0.0075 + 0.05(0.0075)^2 = 0.0150.$$

3. Separating variables and integrating, we have

$$\frac{dy}{y} = dx \quad \text{and} \quad \ln |y| = x + c.$$

Thus  $y = c_1 e^x$  and, using  $y(0) = 1$ , we find  $c = 1$ , so  $y = e^x$  is the solution of the initial-value problem.

## Exercises 2.6

h=0.1

$x_n$	$y_n$	True Value	Abs. Error	% Rel. Error
0.00	1.0000	1.0000	0.0000	0.00
0.10	1.1000	1.1052	0.0052	0.47
0.20	1.2100	1.2214	0.0114	0.93
0.30	1.3310	1.3499	0.0189	1.40
0.40	1.4641	1.4918	0.0277	1.86
0.50	1.6105	1.6487	0.0382	2.32
0.60	1.7716	1.8221	0.0506	2.77
0.70	1.9487	2.0138	0.0650	3.23
0.80	2.1436	2.2255	0.0820	3.68
0.90	2.3579	2.4596	0.1017	4.13
1.00	2.5937	2.7183	0.1245	4.58

h=0.05

$x_n$	$y_n$	True Value	Abs. Error	% Rel. Error
0.00	1.0000	1.0000	0.0000	0.00
0.05	1.0500	1.0513	0.0013	0.12
0.10	1.1025	1.1052	0.0027	0.24
0.15	1.1576	1.1618	0.0042	0.36
0.20	1.2155	1.2214	0.0059	0.48
0.25	1.2763	1.2840	0.0077	0.60
0.30	1.3401	1.3499	0.0098	0.72
0.35	1.4071	1.4191	0.0120	0.84
0.40	1.4775	1.4918	0.0144	0.96
0.45	1.5513	1.5683	0.0170	1.08
0.50	1.6289	1.6487	0.0198	1.20
0.55	1.7103	1.7333	0.0229	1.32
0.60	1.7959	1.8221	0.0263	1.44
0.65	1.8856	1.9155	0.0299	1.56
0.70	1.9799	2.0138	0.0338	1.68
0.75	2.0789	2.1170	0.0381	1.80
0.80	2.1829	2.2255	0.0427	1.92
0.85	2.2920	2.3396	0.0476	2.04
0.90	2.4066	2.4596	0.0530	2.15
0.95	2.5270	2.5857	0.0588	2.27
1.00	2.6533	2.7183	0.0650	2.39

4. Separating variables and integrating, we have

$$\frac{dy}{y} = 2x dx \quad \text{and} \quad \ln|y| = x^2 + c.$$

Thus  $y = c_1 e^{x^2}$  and, using  $y(1) = 1$ , we find  $c = e^{-1}$ , so  $y = e^{x^2-1}$  is the solution of the initial-value problem.

h=0.1

$x_n$	$y_n$	True Value	Abs. Error	% Rel. Error
1.00	1.0000	1.0000	0.0000	0.00
1.10	1.2000	1.2337	0.0337	2.73
1.20	1.4640	1.5527	0.0887	5.71
1.30	1.8154	1.9937	0.1784	8.95
1.40	2.2874	2.6117	0.3243	12.42
1.50	2.9278	3.4903	0.5625	16.12

h=0.05

$x_n$	$y_n$	True Value	Abs. Error	% Rel. Error
1.00	1.0000	1.0000	0.0000	0.00
1.05	1.1000	1.1079	0.0079	0.72
1.10	1.2155	1.2337	0.0182	1.47
1.15	1.3492	1.3806	0.0314	2.27
1.20	1.5044	1.5527	0.0483	3.11
1.25	1.6849	1.7551	0.0702	4.00
1.30	1.8955	1.9937	0.0982	4.93
1.35	2.1419	2.2762	0.1343	5.90
1.40	2.4311	2.6117	0.1806	6.92
1.45	2.7714	3.0117	0.2403	7.98
1.50	3.1733	3.4903	0.3171	9.08

Exercises 2.6

5.  $h=0.1$

$x_n$	$y_n$
0.00	0.0000
0.10	0.1000
0.20	0.1905
0.30	0.2731
0.40	0.3492
0.50	0.4198

$h=0.05$

$x_n$	$y_n$
0.00	0.0000
0.05	0.0500
0.10	0.0976
0.15	0.1429
0.20	0.1863
0.25	0.2278
0.30	0.2676
0.35	0.3058
0.40	0.3427
0.45	0.3782
0.50	0.4124

6.  $h=0.1$

$x_n$	$y_n$
0.00	1.0000
0.10	1.1000
0.20	1.2220
0.30	1.3753
0.40	1.5735
0.50	1.8371

$h=0.05$

$x_n$	$y_n$
0.00	1.0000
0.05	1.0500
0.10	1.1053
0.15	1.1668
0.20	1.2360
0.25	1.3144
0.30	1.4039
0.35	1.5070
0.40	1.6267
0.45	1.7670
0.50	1.9332

7.  $h=0.1$

$x_n$	$y_n$
0.00	0.5000
0.10	0.5250
0.20	0.5431
0.30	0.5548
0.40	0.5613
0.50	0.5639

$h=0.05$

$x_n$	$y_n$
0.00	0.5000
0.05	0.5125
0.10	0.5232
0.15	0.5322
0.20	0.5395
0.25	0.5452
0.30	0.5496
0.35	0.5527
0.40	0.5547
0.45	0.5559
0.50	0.5565

8.  $h=0.1$

$x_n$	$y_n$
0.00	1.0000
0.10	1.1000
0.20	1.2159
0.30	1.3505
0.40	1.5072
0.50	1.6902

$h=0.05$

$x_n$	$y_n$
0.00	1.0000
0.05	1.0500
0.10	1.1039
0.15	1.1619
0.20	1.2245
0.25	1.2921
0.30	1.3651
0.35	1.4440
0.40	1.5293
0.45	1.6217
0.50	1.7219

9.  $h=0.1$

$x_n$	$y_n$
1.00	1.0000
1.10	1.0000
1.20	1.0191
1.30	1.0588
1.40	1.1231
1.50	1.2194

$h=0.05$

$x_n$	$y_n$
1.00	1.0000
1.05	1.0000
1.10	1.0049
1.15	1.0147
1.20	1.0298
1.25	1.0506
1.30	1.0775
1.35	1.1115
1.40	1.1538
1.45	1.2057
1.50	1.2696

10.  $h=0.1$

$x_n$	$y_n$
0.00	0.5000
0.10	0.5250
0.20	0.5499
0.30	0.5747
0.40	0.5991
0.50	0.6231

$h=0.05$

$x_n$	$y_n$
0.00	0.5000
0.05	0.5125
0.10	0.5250
0.15	0.5375
0.20	0.5499
0.25	0.5623
0.30	0.5746
0.35	0.5868
0.40	0.5989
0.45	0.6109
0.50	0.6228

11.

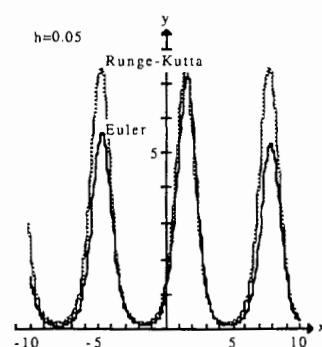
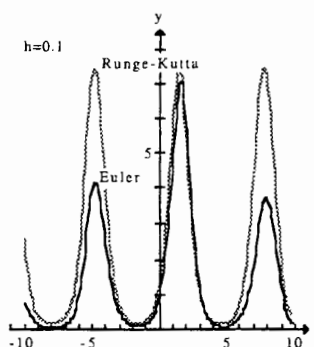
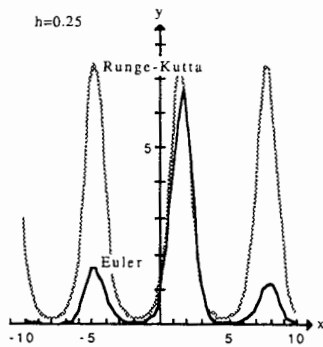

Exercises 2.6

12.

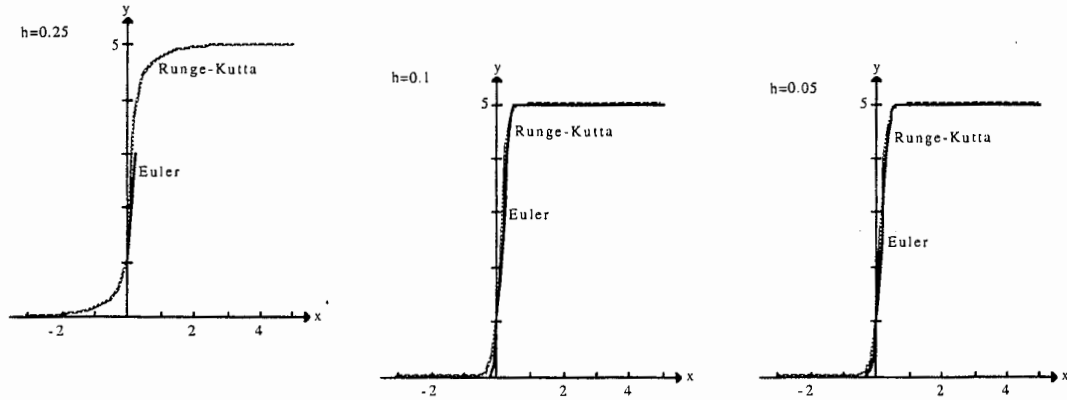

13. Using separation of variables we find that the solution of the differential equation is  $y = 1/(1 - x^2)$ , which is undefined at  $x = 1$ , where the graph has a vertical asymptote.

h=0.1 Euler		h=0.05 Euler		h=0.1 R-K		h=0.05 R-K	
$x_n$	$y_n$	$x_n$	$y_n$	$x_n$	$y_n$	$x_n$	$y_n$
0.00	1.0000	0.00	1.0000	0.00	1.0000	0.00	1.0000
0.10	1.0000	0.05	1.0000	0.10	1.0101	0.05	1.0025
0.20	1.0200	0.10	1.0050	0.20	1.0417	0.10	1.0101
0.30	1.0616	0.15	1.0151	0.30	1.0989	0.15	1.0230
0.40	1.1292	0.20	1.0306	0.40	1.1905	0.20	1.0417
0.50	1.2313	0.25	1.0518	0.50	1.3333	0.25	1.0667
0.60	1.3829	0.30	1.0795	0.60	1.5625	0.30	1.0989
0.70	1.6123	0.35	1.1144	0.70	1.9607	0.35	1.1396
0.80	1.9763	0.40	1.1579	0.80	2.7771	0.40	1.1905
0.90	2.6012	0.45	1.2115	0.90	5.2388	0.45	1.2539
1.00	3.8191	0.50	1.2776	1.00	42.9931	0.50	1.3333
		0.55	1.3592			0.55	1.4337
		0.60	1.4608			0.60	1.5625
		0.65	1.5888			0.65	1.7316
		0.70	1.7529			0.70	1.9608
		0.75	1.9679			0.75	2.2857
		0.80	2.2584			0.80	2.7777
		0.85	2.6664			0.85	3.6034
		0.90	3.2708			0.90	5.2609
		0.95	4.2336			0.95	10.1973
		1.00	5.9363			1.00	84.0132

Because the actual solution of the differential equation becomes unbounded as  $x$  approaches 1, very small changes in the inputs  $x$  will result in large changes in the corresponding outputs  $y$ . This can be expected to have a serious effect on numerical procedures.



14. (a)

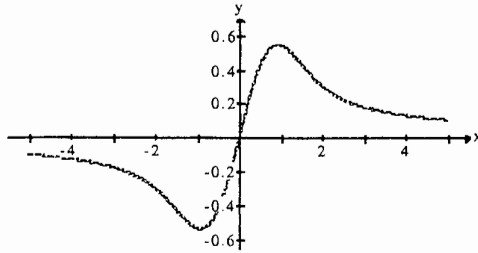

(b) For  $y' + 2xy = 1$  an integrating factor is  $e^{\int 2x dx} = e^{x^2}$  so that  $\frac{d}{dx}[e^{x^2}y] = e^{x^2}$  and

$$y = e^{-x^2} \int_0^x e^{x^2} dx + ce^{-x^2} = \frac{\sqrt{\pi}}{2} \operatorname{erf}(x) + ce^{-x^2}.$$

If  $y(0) = 0$  then  $c = 0$  and  $y = \frac{\sqrt{\pi}}{2} \operatorname{erf}(x)$ .

(c) Using **FindRoot** in *Mathematica* we see that the solution has a relative minimum at  $(-0.924139, -0.541044)$  and a relative maximum at  $(0.924139, 0.541044)$ .

## Chapter 2 Review Exercises

- Writing the differential equation in the form  $y' = k(y + A/k)$  we see that the critical point  $-A/k$  is a repeller for  $k > 0$  and an attractor for  $k < 0$ .
- Separating variables and integrating we have

$$\frac{dy}{y} = \frac{4}{x} dx$$

$$\ln y = 4 \ln x + c = \ln x^4 + c$$

$$y = c_1 x^4.$$

We see that when  $x = 0$ ,  $y = 0$ , so the initial-value problem has an infinite number of solutions for  $k = 0$  and no solutions for  $k \neq 0$ .

- $\frac{dy}{dx} = (y-1)^2(y-3)^2$
- $\frac{dy}{dx} = y(y-2)^2(y-4)$

## Chapter 2 Review Exercises

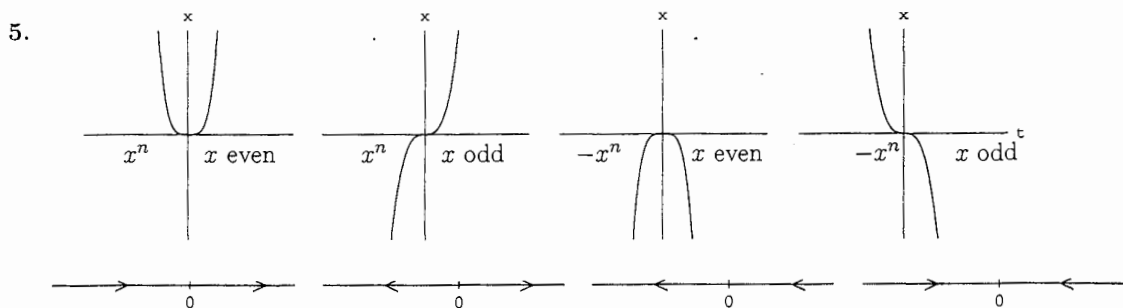

For  $dx/dt = x^n$ , when  $n$  is even,  $0$  is semi-stable; when  $n$  is odd,  $0$  is unstable. For  $dx/dt = -x^n$ , when  $n$  is even,  $0$  is semi-stable; when  $n$  is odd,  $0$  is stable.

6. The zero of  $f$  occurs at approximately 1.3. Since  $P'(t) = f(P) > 0$  for  $P < 1.3$  and  $P'(t) = f(P) < 0$  for  $P > 1.3$ ,  $\lim_{t \rightarrow \infty} P(t) = 1.3$ .

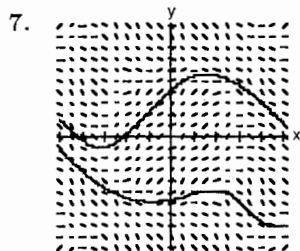

8. (a) linear in  $y$ , homogeneous, exact  
 (b) linear in  $x$   
 (c) separable, exact, linear in  $x$  and  $y$   
 (d) Bernoulli in  $x$   
 (e) separable  
 (f) separable, linear in  $x$ , Bernoulli  
 (g) linear in  $x$   
 (h) homogeneous  
 (i) Bernoulli  
 (j) homogeneous, exact, Bernoulli  
 (k) linear in  $x$  and  $y$ , exact, separable, homogeneous  
 (l) exact, linear in  $y$   
 (m) homogeneous  
 (n) separable

Chapter 2 Review Exercises

9. Separating variables we obtain

$$\cos^2 x \, dx = \frac{y}{y^2+1} \, dy \implies \frac{1}{2}x + \frac{1}{4} \sin 2x = \frac{1}{2} \ln(y^2+1) + c \implies 2x + \sin 2x = 2 \ln(y^2+1) + c.$$

10. Write the differential equation in the form  $y \ln \frac{x}{y} \, dx = \left(x \ln \frac{x}{y} - y\right) \, dy$ . This is a homogeneous equation, so let  $x = uy$ . Then  $dx = u \, dy + y \, du$  and the differential equation becomes

$$y \ln u (u \, dy + y \, du) = (uy \ln u - y) \, dy \quad \text{or} \quad y \ln u \, du = -dy.$$

Separating variables we obtain

$$\begin{aligned} \ln u \, du = -\frac{dy}{y} &\implies u \ln |u| - u = -\ln |y| + c \implies \frac{x}{y} \ln \left| \frac{x}{y} \right| - \frac{x}{y} = -\ln |y| + c \\ &\implies x(\ln x - \ln y) - x = -y \ln |y| + cy. \end{aligned}$$

11. The differential equation  $\frac{dy}{dx} + \frac{2}{6x+1}y = -\frac{3x^2}{6x+1}y^{-2}$  is Bernoulli. Using  $w = y^3$  we obtain

$$\frac{dw}{dx} + \frac{6}{6x+1}w = -\frac{9x^2}{6x+1}. \quad \text{An integrating factor is } 6x+1, \text{ so}$$

$$\frac{d}{dx} [(6x+1)w] = -9x^2 \implies w = -\frac{3x^3}{6x+1} + \frac{c}{6x+1} \implies (6x+1)y^3 = -3x^3 + c.$$

(Note: The differential equation is also exact.)

12. Write the differential equation in the form  $(3y^2+2x)dx + (4y^2+6xy)dy = 0$ . Letting  $M = 3y^2+2x$  and  $N = 4y^2+6xy$  we see that  $M_y = 6y = N_x$  so the differential equation is exact. From  $f_x = 3y^2+2x$  we obtain  $f = 3xy^2+x^2+h(y)$ . Then  $f_y = 6xy+h'(y) = 4y^2+6xy$  and  $h'(y) = 4y^2$  so  $h(y) = \frac{4}{3}y^3$ . The general solution is

$$3xy^2 + x^2 + \frac{4}{3}y^3 = c.$$

13. Write the equation in the form

$$\frac{dQ}{dt} + \frac{1}{t}Q = t^3 \ln t.$$

An integrating factor is  $e^{\ln t} = t$ , so

$$\begin{aligned} \frac{d}{dt}[tQ] = t^4 \ln t &\implies tQ = -\frac{1}{25}t^5 + \frac{1}{5}t^5 \ln t + c \\ \implies Q &= -\frac{1}{25}t^4 + \frac{1}{5}t^4 \ln t + \frac{c}{t}. \end{aligned}$$

14. Letting  $u = 2x + y + 1$  we have

$$\frac{du}{dx} = 2 + \frac{dy}{dx},$$

## Chapter 2 Review Exercises

and so the given differential equation is transformed into

$$u \left( \frac{du}{dx} - 2 \right) = 1 \quad \text{or} \quad \frac{du}{dx} = \frac{2u+1}{u}.$$

Separating variables and integrating we get

$$\begin{aligned} \frac{u}{2u+1} du &= dx \\ \left( \frac{1}{2} - \frac{1}{2} \frac{1}{2u+1} \right) du &= dx \\ \frac{1}{2}u - \frac{1}{4} \ln |2u+1| &= x + c \\ 2u - \ln |2u+1| &= 2x + c_1. \end{aligned}$$

Resubstituting for  $u$  gives the solution

$$4x + 2y + 2 - \ln |4x + 2y + 3| = 2x + c_1$$

or

$$2x + 2y + 2 - \ln |4x + 2y + 3| = c_1.$$

15. Write the equation in the form  $\frac{dy}{dx} + \frac{8x}{x^2+4}y = \frac{2x}{x^2+4}$ . An integrating factor is  $(x^2+4)^4$ , so

$$\frac{d}{dx} \left[ (x^2+4)^4 y \right] = 2x(x^2+4)^3 \implies (x^2+4)^4 y = \frac{1}{4}(x^2+4)^4 + c \implies y = \frac{1}{4} + c(x^2+4)^{-4}.$$

16. Letting  $M = 2r^2 \cos \theta \sin \theta + r \cos \theta$  and  $N = 4r + \sin \theta - 2r \cos^2 \theta$  we see that  $M_r = 4r \cos \theta \sin \theta + \cos \theta = N_\theta$  so the differential equation is exact. From  $f_\theta = 2r^2 \cos \theta \sin \theta + r \cos \theta$  we obtain  $f = -r^2 \cos^2 \theta + r \sin \theta + h(r)$ . Then  $f_r = -2r \cos^2 \theta + \sin \theta + h'(r) = 4r + \sin \theta - 2r \cos^2 \theta$  and  $h'(r) = 4r$  so  $h(r) = 2r^2$ . The general solution is

$$-r^2 \cos^2 \theta + r \sin \theta + 2r^2 = c.$$

17. The differential equation has the form  $\frac{d}{dx} [(\sin x)y] = 0$ . Integrating we have  $(\sin x)y = c$  or  $y = c/\sin x$ . The initial condition implies  $c = -2 \sin(7\pi/6) = 1$ . Thus,  $y = 1/\sin x$ , where  $\pi < x < 2\pi$  is chosen to include  $x = 7\pi/6$ .

18. Separating variables and integrating we have

$$\begin{aligned}\frac{dy}{y^2} &= -2(t+1) dt \\ -\frac{1}{y} &= -(t+1)^2 + c \\ y &= \frac{1}{(t+1)^2 + c}.\end{aligned}$$

The initial condition implies  $c = -9$ , so the solution of the initial-value problem is

$$y = \frac{1}{t^2 + 2t - 8} \quad \text{where} \quad -4 < t < 2.$$

19. (a) For  $y < 0$ ,  $\sqrt{y}$  is not a real number.

(b) Separating variables and integrating we have

$$\frac{dy}{\sqrt{y}} = dx \quad \text{and} \quad 2\sqrt{y} = x + c.$$

Letting  $y(x_0) = y_0$  we get  $c = 2\sqrt{y_0} - x_0$ , so that

$$2\sqrt{y} = x + 2\sqrt{y_0} - x_0 \quad \text{and} \quad y = \frac{1}{4}(x + 2\sqrt{y_0} - x_0)^2.$$

Since  $\sqrt{y} > 0$  for  $y \neq 0$ , we see that  $dy/dx = \frac{1}{2}(x + 2\sqrt{y_0} - x_0)$  must be positive. Thus, the interval on which the solution is defined is  $(x_0 - 2\sqrt{y_0}, \infty)$ .

20. (a) The differential equation is homogeneous and we let  $y = ux$ . Then

$$\begin{aligned}(x^2 - y^2) dx + xy dy &= 0 \\ (x^2 - u^2x^2) dx + ux^2(u dx + x du) &= 0 \\ dx + ux du &= 0 \\ u du &= -\frac{dx}{x} \\ \frac{1}{2}u^2 &= -\ln|x| + c \\ \frac{y^2}{x^2} &= -2\ln|x| + c_1.\end{aligned}$$

The initial condition gives  $c_1 = 2$ , so an implicit solution is  $y^2 = x^2(2 - 2\ln|x|)$ .

## Chapter 2 Review Exercises

(b) Solving for  $y$  in part (a) and being sure that the initial condition is still satisfied, we have  $y = -\sqrt{2}|x|(1 - \ln|x|)^{1/2}$ , where  $-e \leq x \leq e$  so that  $1 - \ln|x| \geq 0$ . The graph of this function indicates that the derivative is not defined at  $x = 0$  and  $x = e$ . Thus, the solution of the initial-value problem is  $y = -\sqrt{2}x(1 - \ln x)^{1/2}$ , for  $0 < x < e$ .

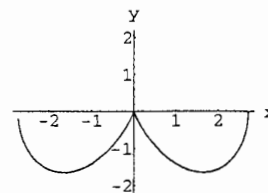

21. The graph of  $y_1(x)$  is the portion of the closed black curve lying in the fourth quadrant. Its interval of definition is approximately  $(0.7, 4.3)$ . The graph of  $y_2(x)$  is the portion of the left-hand black curve lying in the third quadrant. Its interval of definition is  $(-\infty, 0)$ .
22. The first step of Euler's method gives  $y(1.1) \approx 9 + 0.1(1 + 3) = 9.4$ . Applying Euler's method one more time gives  $y(1.2) \approx 9.4 + 0.1(1 + 1.1\sqrt{9.4}) \approx 9.8373$ .

# 3 Modeling with First-Order Differential Equations

## Exercises 3.1

1. Let  $P = P(t)$  be the population at time  $t$ , and  $P_0$  the initial population. From  $dP/dt = kP$  we obtain  $P = P_0e^{kt}$ . Using  $P(5) = 2P_0$  we find  $k = \frac{1}{5} \ln 2$  and  $P = P_0e^{(\ln 2)t/5}$ . Setting  $P(t) = 3P_0$  we have

$$3 = e^{(\ln 2)t/5} \implies \ln 3 = \frac{(\ln 2)t}{5} \implies t = \frac{5 \ln 3}{\ln 2} \approx 7.9 \text{ years.}$$

Setting  $P(t) = 4P_0$  we have

$$4 = e^{(\ln 2)t/5} \implies \ln 4 = \frac{(\ln 2)t}{5} \implies t = 10 \text{ years.}$$

2. Setting  $P = 10,000$  and  $t = 3$  in Problem 1 we obtain

$$10,000 = P_0e^{(\ln 2)3/5} \implies P_0 = 10,000e^{-0.6 \ln 2} \approx 6597.5.$$

Then  $P(10) = P_0e^{2 \ln 2} = 4P_0 \approx 26,390$ .

3. Let  $P = P(t)$  be the population at time  $t$ . From  $dP/dt = kt$  and  $P(0) = P_0 = 500$  we obtain  $P = 500e^{kt}$ . Using  $P(10) = 575$  we find  $k = \frac{1}{10} \ln 1.15$ . Then  $P(30) = 500e^{3 \ln 1.15} \approx 760$  years.

4. Let  $N = N(t)$  be the number of bacteria at time  $t$  and  $N_0$  the initial number. From  $dN/dt = kN$  we obtain  $N = N_0e^{kt}$ . Using  $N(3) = 400$  and  $N(10) = 2000$  we find  $400 = N_0e^{3k}$  or  $e^k = (400/N_0)^{1/3}$ . From  $N(10) = 2000$  we then have

$$2000 = N_0e^{10k} = N_0 \left( \frac{400}{N_0} \right)^{10/3} \implies \frac{2000}{400^{10/3}} = N_0^{-7/3} \implies N_0 = \left( \frac{2000}{400^{10/3}} \right)^{-3/7} \approx 201.$$

5. Let  $I = I(t)$  be the intensity,  $t$  the thickness, and  $I(0) = I_0$ . If  $dI/dt = kI$  and  $I(3) = 0.25I_0$  then  $I = I_0e^{kt}$ ,  $k = \frac{1}{3} \ln 0.25$ , and  $I(15) = 0.00098I_0$ .

6. From  $dS/dt = rS$  we obtain  $S = S_0e^{rt}$  where  $S(0) = S_0$ .

(a) If  $S_0 = \$5000$  and  $r = 5.75\%$  then  $S(5) = \$6665.45$ .

(b) If  $S(t) = \$10,000$  then  $t = 12$  years.

(c)  $S \approx \$6651.82$

7. Let  $N = N(t)$  be the amount of lead at time  $t$ . From  $dN/dt = kN$  and  $N(0) = 1$  we obtain  $N = e^{kt}$ . Using  $N(3.3) = 1/2$  we find  $k = \frac{1}{3.3} \ln 1/2$ . When 90% of the lead has decayed, 0.1 grams

### Exercises 3.1

will remain. Setting  $N(t) = 0.1$  we have

$$e^{t(1/3.3)\ln(1/2)} = 0.1 \implies \frac{t}{3.3} \ln \frac{1}{2} = \ln 0.1 \implies t = \frac{3.3 \ln 0.1}{\ln 1/2} \approx 10.96 \text{ hours.}$$

8. Let  $N = N(t)$  be the amount at time  $t$ . From  $dN/dt = kt$  and  $N(0) = 100$  we obtain  $N = 100e^{kt}$ . Using  $N(6) = 97$  we find  $k = \frac{1}{6} \ln 0.97$ . Then  $N(24) = 100e^{(1/6)(\ln 0.97)24} = 100(0.97)^4 \approx 88.5$  mg.
9. Setting  $N(t) = 50$  in Problem 8 we obtain

$$50 = 100e^{kt} \implies kt = \ln \frac{1}{2} \implies t = \frac{\ln 1/2}{(1/6) \ln 0.97} \approx 136.5 \text{ hours.}$$

10. (a) The solution of  $dA/dt = kA$  is  $A(t) = A_0e^{kt}$ . Letting  $A = \frac{1}{2}A_0$  and solving for  $t$  we obtain the half-life  $T = -(\ln 2)/k$ .

(b) Since  $k = -(\ln 2)/T$  we have

$$A(t) = A_0e^{-(\ln 2)t/T} = A_02^{-t/T}.$$

(c) Writing  $\frac{1}{8}A_0 = A_02^{-t/T}$  as  $2^{-3} = 2^{-t/T}$  and solving for  $t$  we get  $t = 3T$ . Thus, an initial amount  $A_0$  will decay to  $\frac{1}{8}A_0$  in three half lives.

11. Assume that  $A = A_0e^{kt}$  and  $k = -0.00012378$ . If  $A(t) = 0.145A_0$  then  $t \approx 15,600$  years.
12. From Example 3, the amount of carbon present at time  $t$  is  $A(t) = A_0e^{-0.00012378t}$ . Letting  $t = 660$  and solving for  $A_0$  we have  $A(660) = A_0e^{-0.0001237(660)} = 0.921553A_0$ . Thus, approximately 92% of the original amount of C-14 remained in the cloth as of 1988.
13. Assume that  $dT/dt = k(T - 10)$  so that  $T = 10 + ce^{kt}$ . If  $T(0) = 70^\circ$  and  $T(1/2) = 50^\circ$  then  $c = 60$  and  $k = 2 \ln(2/3)$  so that  $T(1) = 36.67^\circ$ . If  $T(t) = 15^\circ$  then  $t = 3.06$  minutes.
14. Assume that  $dT/dt = k(T - 5)$  so that  $T = 5 + ce^{kt}$ . If  $T(1) = 55^\circ$  and  $T(5) = 30^\circ$  then  $k = -\frac{1}{4} \ln 2$  and  $c = 59.4611$  so that  $T(0) = 64.4611^\circ$ .
15. Assume that  $dT/dt = k(T - 100)$  so that  $T = 100 + ce^{kt}$ . If  $T(0) = 20^\circ$  and  $T(1) = 22^\circ$  then  $c = -80$  and  $k = \ln(39/40)$  so that  $T(t) = 90^\circ$  implies  $t = 82.1$  seconds. If  $T(t) = 98^\circ$  then  $t = 145.7$  seconds.
16. Using separation of variables to solve  $dT/dt = k(T - T_m)$  we get  $T(t) = T_m + ce^{kt}$ . Using  $T(0) = 70$  we find  $c = 70 - T_m$ , so  $T(t) = T_m + (70 - T_m)e^{kt}$ . Using the given observations, we obtain

$$T\left(\frac{1}{2}\right) = T_m + (70 - T_m)e^{k/2} = 110$$

$$T(1) = T_m + (70 - T_m)e^k = 145.$$



Exercises 3.1

Then  $e^{k/2} = (110 - T_m)/(70 - T_m)$  and

$$e^k = (e^{k/2})^2 = \left(\frac{110 - T_m}{70 - T_m}\right)^2 = \frac{145 - T_m}{70 - T_m}$$

$$\frac{(110 - T_m)^2}{70 - T_m} = 145 - T_m$$

$$12100 - 220T_m + T_m^2 = 10150 - 250T_m + T_m^2$$

$$T_m = 390.$$

The temperature in the oven is  $390^\circ$ .

17. From  $dA/dt = 4 - A/50$  we obtain  $A = 200 + ce^{-t/50}$ . If  $A(0) = 30$  then  $c = -170$  and  $A = 200 - 170e^{-t/50}$ .
18. From  $dA/dt = 0 - A/50$  we obtain  $A = ce^{-t/50}$ . If  $A(0) = 30$  then  $c = 30$  and  $A = 30e^{-t/50}$ .
19. From  $dA/dt = 10 - A/100$  we obtain  $A = 1000 + ce^{-t/100}$ . If  $A(0) = 0$  then  $c = -1000$  and  $A = 1000 - 1000e^{-t/100}$ . At  $t = 5$ ,  $A(5) \approx 48.77$  pounds.
20. From  $\frac{dA}{dt} = 10 - \frac{10A}{500 - (10 - 5)t} = 10 - \frac{2A}{100 - t}$  we obtain  $A = 1000 - 10t + c(100 - t)^2$ . If  $A(0) = 0$  then  $c = -\frac{1}{10}$ . The tank is empty in 100 minutes.
21. From  $\frac{dA}{dt} = 3 - \frac{4A}{100 + (6 - 4)t} = 3 - \frac{2A}{50 + t}$  we obtain  $A = 50 + t + c(50 + t)^{-2}$ . If  $A(0) = 10$  then  $c = -100,000$  and  $A(30) = 64.38$  pounds.
22. (a) Initially the tank contains 300 gallons of solution. Since brine is pumped in at a rate of 3 gal/min and the solution is pumped out at a rate of 2 gal/min, the net change is an increase of 1 gal/min. Thus, in 100 minutes the tank will contain its capacity of 400 gallons.
- (b) The differential equation describing the amount of salt in the tank is  $A'(t) = 6 - 2A/(300 + t)$  with solution

$$A(t) = 600 + 2t - (4.95 \times 10^7)(300 + t)^{-2}, \quad 0 \leq t \leq 100,$$

as noted in the discussion following Example 5 in the text. Thus, the amount of salt in the tank when it overflows is

$$A(100) = 800 - (4.95 \times 10^7)(400)^{-2} = 490.625 \text{ lbs.}$$

- (c) When the tank is overflowing the amount of salt in the tank is governed by the differential

### Exercises 3.1

equation

$$\begin{aligned}\frac{dA}{dt} &= (3 \text{ gal/min})(2 \text{ lb/gal}) - \left(\frac{A}{400} \text{ lb/gal}\right)(3 \text{ gal/min}) \\ &= 6 - \frac{3A}{400}, \quad A(100) = 490.625.\end{aligned}$$

Solving the equation we obtain  $A(t) = 800 + ce^{-3t/400}$ . The initial condition yields  $c = -654.947$ , so that

$$A(t) = 800 - 654.947e^{-3t/400}.$$

When  $t = 150$ ,  $A(150) = 587.37$  lbs.

- (d) As  $t \rightarrow \infty$ , the amount of salt is 800 lbs, which is to be expected since  $(400 \text{ gal})(2 \text{ lbs/gal}) = 800$  lbs.

(e)

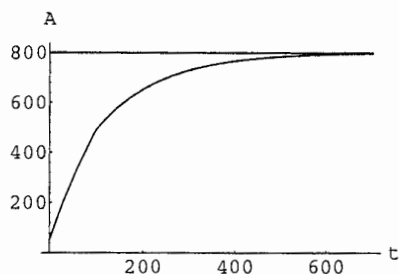

23. Assume  $L di/dt + Ri = E(t)$ ,  $L = 0.1$ ,  $R = 50$ , and  $E(t) = 50$  so that  $i = \frac{3}{5} + ce^{-500t}$ . If  $i(0) = 0$  then  $c = -3/5$  and  $\lim_{t \rightarrow \infty} i(t) = 3/5$ .

24. Assume  $L di/dt + Ri = E(t)$ ,  $E(t) = E_0 \sin \omega t$ , and  $i(0) = i_0$  so that

$$i = \frac{E_0 R}{L^2 \omega^2 + R^2} \sin \omega t - \frac{E_0 L \omega}{L^2 \omega^2 + R^2} \cos \omega t + ce^{-Rt/L}.$$

Since  $i(0) = i_0$  we obtain  $c = i_0 + \frac{E_0 L \omega}{L^2 \omega^2 + R^2}$ .

25. Assume  $R dq/dt + (1/c)q = E(t)$ ,  $R = 200$ ,  $C = 10^{-4}$ , and  $E(t) = 100$  so that  $q = 1/100 + ce^{-50t}$ . If  $q(0) = 0$  then  $c = -1/100$  and  $i = \frac{1}{2}e^{-50t}$ .

26. Assume  $R dq/dt + (1/c)q = E(t)$ ,  $R = 1000$ ,  $C = 5 \times 10^{-6}$ , and  $E(t) = 200$ . Then  $q = \frac{1}{1000} + ce^{-200t}$  and  $i = -200ce^{-200t}$ . If  $i(0) = 0.4$  then  $c = -\frac{1}{500}$ ,  $q(0.005) = 0.003$  coulombs, and  $i(0.005) = 0.1472$  amps. As  $t \rightarrow \infty$  we have  $q \rightarrow \frac{1}{1000}$ .

27. For  $0 \leq t \leq 20$  the differential equation is  $20 di/dt + 2i = 120$ . An integrating factor is  $e^{t/10}$ , so  $\frac{d}{dt} [e^{t/10} i] = 6e^{t/10}$  and  $i = 60 + c_1 e^{-t/10}$ . If  $i(0) = 0$  then  $c_1 = -60$  and  $i = 60 - 60e^{-t/10}$ .

For  $t > 20$  the differential equation is  $20 di/dt + 2i = 0$  and  $i = c_2 e^{-t/10}$ .

At  $t = 20$  we want  $c_2 e^{-2} = 60 - 60e^{-2}$  so that  $c_2 = 60(e^2 - 1)$ . Thus

$$i(t) = \begin{cases} 60 - 60e^{-t/10}, & 0 \leq t \leq 20; \\ 60(e^2 - 1)e^{-t/10}, & t > 20. \end{cases}$$

28. Separating variables we obtain

$$\frac{dq}{E_0 - q/C} = \frac{dt}{k_1 + k_2 t} \implies -C \ln \left| E_0 - \frac{q}{C} \right| = \frac{1}{k_2} \ln |k_1 + k_2 t| + c_1 \implies \frac{(E_0 - q/C)^{-C}}{(k_1 + k_2 t)^{1/k_2}} = c_2.$$

Setting  $q(0) = q_0$  we find  $c_2 = \frac{(E_0 - q_0/C)^{-C}}{k_1^{1/k_2}}$ , so

$$\begin{aligned} \frac{(E_0 - q/C)^{-C}}{(k_1 + k_2 t)^{1/k_2}} &= \frac{(E_0 - q_0/C)^{-C}}{k_1^{1/k_2}} \implies \left( E_0 - \frac{q}{C} \right)^{-C} = \left( E_0 - \frac{q_0}{C} \right)^{-C} \left( \frac{k_1}{k_1 + k_2 t} \right)^{-1/k_2} \\ &\implies E_0 - \frac{q}{C} = \left( E_0 - \frac{q_0}{C} \right) \left( \frac{k_1}{k_1 + k_2 t} \right)^{1/Ck_2} \\ &\implies q = E_0 C + (q_0 - E_0 C) \left( \frac{k_1}{k_1 + k_2 t} \right)^{1/Ck_2}. \end{aligned}$$

29. (a) From  $m dv/dt = mg - kv$  we obtain  $v = gm/k + ce^{-kt/m}$ . If  $v(0) = v_0$  then  $c = v_0 - gm/k$  and the solution of the initial-value problem is

$$v = \frac{gm}{k} + \left( v_0 - \frac{gm}{k} \right) e^{-kt/m}.$$

(b) As  $t \rightarrow \infty$  the limiting velocity is  $gm/k$ .

(c) From  $ds/dt = v$  and  $s(0) = 0$  we obtain

$$s = \frac{gm}{k} t - \frac{m}{k} \left( v_0 - \frac{gm}{k} \right) e^{-kt/m} + \frac{m}{k} \left( v_0 - \frac{gm}{k} \right).$$

30. (a) Integrating  $d^2s/dt^2 = -g$  we get  $v(t) = ds/dt = -gt + c$ . From  $v(0) = 300$  we find  $c = 300$ , so the velocity is  $v(t) = -32t + 300$ .

(b) Integrating again and using  $s(0) = 0$  we get  $s(t) = -16t^2 + 300t$ . The maximum height is attained when  $v = 0$ , that is, at  $t_a = 9.375$ . The maximum height will be  $s(9.375) = 1406.25$  ft.

31. When air resistance is proportional to velocity, the model for the velocity is  $m dv/dt = -mg - kv$  (using the fact that the positive direction is upward.) Solving the differential equation using separation of variables we obtain  $v(t) = -mg/k + ce^{-kt/m}$ . From  $v(0) = 300$  we get

$$v(t) = -\frac{mg}{k} + \left( 300 + \frac{mg}{k} \right) e^{-kt/m}.$$

### Exercises 3.1

Integrating and using  $s(0) = 0$  we find

$$s(t) = -\frac{mg}{k}t + \frac{m}{k}\left(300 + \frac{mg}{k}\right)(1 - e^{-kt/m}).$$

Setting  $k = 0.0025$ ,  $m = 16/32 = 0.5$ , and  $g = 32$  we have

$$s(t) = 1,340,000 - 6,400t - 1,340,000e^{-0.005t}$$

and

$$v(t) = -6,400 + 6,700e^{-0.005t}.$$

The maximum height is attained when  $v = 0$ , that is, at  $t_a = 9.162$ . The maximum height will be  $s(9.162) = 1363.79$  ft, which is less than the maximum height in part (a).

32. Assuming that air resistance is proportional to velocity and the positive direction is downward, the model for the velocity is  $m dv/dt = mg - kv$ . Using separation of variables to solve this differential equation we obtain  $v(t) = mg/k + ce^{-kt/m}$ . From  $v(0) = 0$  we get  $v(t) = (mg/k)(1 - e^{-kt/m})$ . Letting  $k = 0.5$ ,  $m = 160/32 = 5$ , and  $g = 32$  we have  $v(t) = 320(1 - e^{-0.1t})$ . Integrating, we find  $s(t) = 320t + 3200e^{-0.1t}$ . At  $t = 15$ , when the parachute opens,  $v(15) = 248.598$  and  $s(15) = 5514.02$ . At this point the value of  $k$  changes to  $k = 10$  and the new initial velocity is  $v_0 = 248.598$ . Her velocity with the parachute open (with time measured from the instant of opening) is  $v_p(t) = 16 + 232.598e^{-2t}$ . Integrating, we find  $s_p(t) = 16t - 116.299e^{-2t}$ . Twenty seconds after leaving the plane is five seconds after the parachute opens. Her velocity at this time is  $v_p(5) = 16.0106$  ft/sec and she has fallen  $s(15) + s_p(5) = 5514.02 + 79.9947 = 5594.01$  ft. Her terminal velocity is  $\lim_{t \rightarrow \infty} v_p(t) = 16$ , so she has very nearly reached her terminal velocity five seconds after the parachute opens. When the parachute opens, the distance to the ground is  $15,000 - 5514.02 = 9485.98$  ft. Solving  $s_p(t) = 9485.98$  we get  $t = 592.874$  s = 9.88 min. Thus, it will take her approximately 9.88 minutes to reach the ground after her parachute has opened and a total of  $(592.874 + 15)/60 = 10.13$  minutes after she exits the plane.

33. (a) The differential equation is first-order, linear. Letting  $b = k/\rho$ , the integrating factor is  $e^{\int 3b dt/(bt+r_0)} = (r_0 + bt)^3$ . Then

$$\frac{d}{dt}[(r_0 + bt)^3 v] = g(r_0 + bt)^3 \quad \text{and} \quad (r_0 + bt)^3 v = \frac{g}{4b}(r_0 + bt)^4 + c.$$

The solution of the differential equation is  $v(t) = (g/4b)(r_0 + bt) + c(r_0 + bt)^{-3}$ . Using  $v(0) = 0$  we find  $c = -gr_0^4/4b$ , so that

$$v(t) = \frac{g}{4b}(r_0 + bt) - \frac{gr_0^4}{4b(r_0 + bt)^3} = \frac{g\rho}{4k}\left(r_0 + \frac{k}{\rho}t\right) - \frac{g\rho r_0^4}{4k(r_0 + kt/\rho)^3}.$$

- (b) Integrating  $dr/dt = k/\rho$  we get  $r = kt/\rho + c$ . Using  $r(0) = r_0$  we have  $c = r_0$ , so  $r(t) = kt/\rho + r_0$ .

### Exercises 3.1

- (c) If  $r = 0.007$  ft when  $t = 10$  s, then solving  $r(10) = 0.007$  for  $k/\rho$ , we obtain  $k/\rho = -0.0003$  and  $r(t) = 0.01 - 0.0003t$ . Solving  $r(t) = 0$  we get  $t = 33.3$ , so the raindrop will have evaporated completely at 33.3 seconds.

34. Separating variables we obtain

$$\frac{dP}{P} = k \cos t \, dt \implies \ln |P| = k \sin t + c \implies P = c_1 e^{k \sin t}.$$

If  $P(0) = P_0$  then  $c_1 = P_0$  and  $P = P_0 e^{k \sin t}$ .

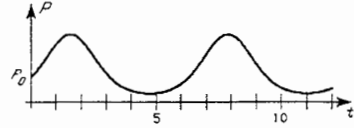

35. (a) From  $dP/dt = (k_1 - k_2)P$  we obtain  $P = P_0 e^{(k_1 - k_2)t}$  where  $P_0 = P(0)$ .
- (b) If  $k_1 > k_2$  then  $P \rightarrow \infty$  as  $t \rightarrow \infty$ . If  $k_1 = k_2$  then  $P = P_0$  for every  $t$ . If  $k_1 < k_2$  then  $P \rightarrow 0$  as  $t \rightarrow \infty$ .
36. The first equation can be solved by separation of variables. We obtain  $x = c_1 e^{-\lambda_1 t}$ . From  $x(0) = x_0$  we obtain  $c_1 = x_0$  and so  $x = x_0 e^{-\lambda_1 t}$ . The second equation then becomes

$$\frac{dy}{dt} = x_0 \lambda_1 e^{-\lambda_1 t} - \lambda_2 y \quad \text{or} \quad \frac{dy}{dt} + \lambda_2 y = x_0 \lambda_1 e^{-\lambda_1 t}$$

which is linear. An integrating factor is  $e^{\lambda_2 t}$ . Thus

$$\frac{d}{dt} [e^{\lambda_2 t} y] = x_0 \lambda_1 e^{-\lambda_1 t} e^{\lambda_2 t} = x_0 \lambda_1 e^{(\lambda_2 - \lambda_1)t}$$

$$e^{\lambda_2 t} y = \frac{x_0 \lambda_1}{\lambda_2 - \lambda_1} e^{(\lambda_2 - \lambda_1)t} + c_2$$

$$y = \frac{x_0 \lambda_1}{\lambda_2 - \lambda_1} e^{-\lambda_1 t} + c_2 e^{-\lambda_2 t}.$$

From  $y(0) = y_0$  we obtain  $c_2 = (y_0 \lambda_2 - y_0 \lambda_1 - x_0 \lambda_1) / (\lambda_2 - \lambda_1)$ . The solution is

$$y = \frac{x_0 \lambda_1}{\lambda_2 - \lambda_1} e^{-\lambda_1 t} + \frac{y_0 \lambda_2 - y_0 \lambda_1 - x_0 \lambda_1}{\lambda_2 - \lambda_1} e^{-\lambda_2 t}.$$

37. (a) Solving  $k_1(M - A) - k_2 A = 0$  for  $A$  we find the equilibrium solution  $A = k_1 M / (k_1 + k_2)$ . From the phase portrait we see that  $\lim_{t \rightarrow \infty} A(t) = k_1 M / (k_1 + k_2)$ .

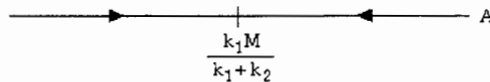

Since  $k_2 > 0$ , the material will never be completely memorized and the larger  $k_2$  is, the less the amount of material will be memorized over time.

### Exercises 3.1

- (b) Write the differential equation in the form  $dA/dt + (k_1 + k_2)A = k_1M$ . Then an integrating factor is  $e^{(k_1+k_2)t}$ , and

$$\begin{aligned} \frac{d}{dt} [e^{(k_1+k_2)t}A] &= k_1M e^{(k_1+k_2)t} \\ \implies e^{(k_1+k_2)t}A &= \frac{k_1M}{k_1+k_2} e^{(k_1+k_2)t} + c \\ \implies A &= \frac{k_1M}{k_1+k_2} + ce^{-(k_1+k_2)t}. \end{aligned}$$

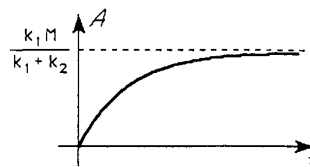

Using  $A(0) = 0$  we find  $c = -\frac{k_1M}{k_1+k_2}$  and  $A = \frac{k_1M}{k_1+k_2} (1 - e^{-(k_1+k_2)t})$ . As  $t \rightarrow \infty$ ,  $A \rightarrow \frac{k_1M}{k_1+k_2}$ .

38. (a) Solving  $r - kx = 0$  for  $x$  we find the equilibrium solution  $x = r/k$ . When  $x < r/k$ ,  $dx/dt > 0$  and when  $x > r/k$ ,  $dx/dt < 0$ . From the phase portrait we see that  $\lim_{t \rightarrow \infty} x(t) = r/k$ .

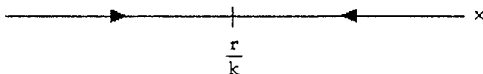

- (b) From  $dx/dt = r - kx$  and  $x(0) = 0$  we obtain  $x = r/k - (r/k)e^{-kt}$  so that  $x \rightarrow r/k$  as  $t \rightarrow \infty$ . If  $x(T) = r/2k$  then  $T = (\ln 2)/k$ .

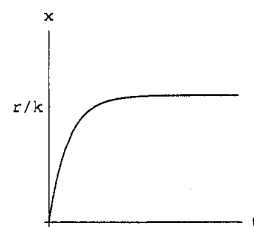

39. It is necessary to know the air temperature from the time of death until the medical examiner arrives. We will assume that the temperature of the air is a constant 65°F. By Newton's law of cooling we then have

$$\frac{dT}{dt} = k(T - 65), \quad T(0) = 82.$$

Using linearity or separation of variables we obtain  $T = 65 + ce^{kt}$ . From  $T(0) = 82$  we find  $c = 17$ , so that  $T = 65 + 17e^{kt}$ . To find  $k$  we need more information so we assume that the body temperature at  $t = 2$  hours was 75°F. Then  $75 = 65 + 17e^{2k}$  and  $k = -0.2653$  and

$$T(t) = 65 + 17e^{-0.2653t}.$$

At the time of death,  $t_0$ ,  $T(t_0) = 98.6^\circ\text{F}$ , so  $98.6 = 65 + 17e^{-0.2653t_0}$ , which gives  $t_0 = -2.568$ . Thus, the murder took place about 2.568 hours prior to the discovery of the body.

## Exercises 3.2

40. We will assume that the temperature of both the room and the cream is  $72^\circ\text{F}$ , and that the temperature of the coffee when it is first put on the table is  $175^\circ\text{F}$ . If we let  $T_1(t)$  represent the temperature of the coffee in Mr. Jones' cup at time  $t$ , then

$$\frac{dT_1}{dt} = k(T_1 - 72),$$

which implies  $T_1 = 72 + c_1e^{kt}$ . At time  $t = 0$  Mr. Jones adds cream to his coffee which immediately reduces its temperature by an amount  $\alpha$ , so that  $T_1(0) = 175 - \alpha$ . Thus  $175 - \alpha = T_1(0) = 72 + c_1$ , which implies  $c_1 = 103 - \alpha$ , so that  $T_1(t) = 72 + (103 - \alpha)e^{kt}$ . At  $t = 5$ ,  $T_1(5) = 72 + (103 - \alpha)e^{5k}$ . Now we let  $T_2(t)$  represent the temperature of the coffee in Mrs. Jones' cup. From  $T_2 = 72 + c_2e^{kt}$  and  $T_2(0) = 175$  we obtain  $c_2 = 103$ , so that  $T_2(t) = 72 + 103e^{kt}$ . At  $t = 5$ ,  $T_2(5) = 72 + 103e^{5k}$ . When cream is added to Mrs. Jones' coffee the temperature is reduced by an amount  $\alpha$ . Using the fact that  $k < 0$  we have

$$\begin{aligned} T_2(5) - \alpha &= 72 + 103e^{5k} - \alpha < 72 + 103e^{5k} - \alpha e^{5k} \\ &= 72 + (103 - \alpha)e^{5k} = T_1(5). \end{aligned}$$

Thus, the temperature of the coffee in Mr. Jones' cup is hotter.

41. Drop an object from a great height and measure its terminal velocity,  $v_t$ . In Problem 29(b) we saw that  $v_t = gm/k$ , so  $k = gm/v_t$ .
42. We saw in part (a) of Problem 30 that the ascent time is  $t_a = 9.375$ . To find when the cannonball hits the ground we solve  $s(t) = -16t^2 + 300t = 0$ , getting a total time in flight of  $t = 18.75$ . Thus, the time of descent is  $t_d = 18.75 - 9.375 = 9.375$ . The impact velocity is  $v_i = v(18.75) = -300$ , which has the same magnitude as the initial velocity.

We saw in part (b) of Problem 30 that the ascent time in the case of air resistance is  $t_a = 9.162$ . Solving  $s(t) = 1,340,000 - 6,400t - 1,340,000e^{-0.005t} = 0$  we see that the total time of flight is 18.466. Thus, the descent time is  $t_d = 18.466 - 9.162 = 9.304$ . The impact velocity is  $v_i = v(18.466) = -290.91$ , compared to an initial velocity of  $v_0 = 300$ .

---

## Exercises 3.2

---

1. (a) Solving  $N(1 - 0.0005N) = 0$  for  $N$  we find the equilibrium solutions  $N = 0$  and  $N = 2000$ . When  $0 < N < 2000$ ,  $dN/dt > 0$ . From the phase portrait we see that  $\lim_{t \rightarrow \infty} N(t) = 2000$ .

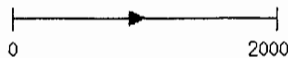

A graph of the solution is shown in part (b).

### Exercises 3.2

(b) Separating variables and integrating we have

$$\frac{dN}{N(1 - 0.0005N)} = \left( \frac{1}{N} - \frac{1}{N - 2000} \right) dN = dt$$

and

$$\ln N - \ln(N - 2000) = t + c.$$

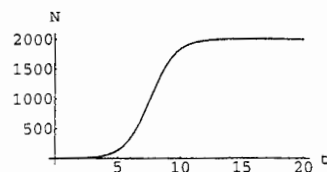

Solving for  $N$  we get  $N(t) = 2000e^{c+t}/(1 + e^{c+t}) = 2000e^c e^t / (1 + e^c e^t)$ . Using  $N(0) = 1$  and solving for  $e^c$  we find  $e^c = 1/1999$  and so  $N(t) = 2000e^t / (1999 + e^t)$ . Then  $N(10) = 1833.59$ , so 1834 companies are expected to adopt the new technology when  $t = 10$ .

2. From  $\frac{dN}{dt} = N(a - bN)$  and  $N(0) = 500$  we obtain  $N = \frac{500a}{500b + (a - 500b)e^{-at}}$ . Since  $\lim_{t \rightarrow \infty} N = \frac{a}{b} = 50,000$  and  $N(1) = 1000$  we have  $a = 0.7033$ ,  $b = 0.00014$ , and  $N = \frac{50,000}{1 + 99e^{-0.7033t}}$ .
3. From  $\frac{dP}{dt} = P(10^{-1} - 10^{-7}P)$  and  $P(0) = 5000$  we obtain  $P = \frac{500}{0.0005 + 0.0995e^{-0.1t}}$  so that  $P \rightarrow 1,000,000$  as  $t \rightarrow \infty$ . If  $P(t) = 500,000$  then  $t = 52.9$  months.
4. (a) We have  $dP/dt = P(a - bP)$  with  $P(0) = 3.929$  million. Using separation of variables we obtain

$$\begin{aligned} P(t) &= \frac{3.929a}{3.929b + (a - 3.929b)e^{-at}} = \frac{a/b}{1 + (a/3.929b - 1)e^{-at}} \\ &= \frac{c}{1 + (c/3.929 - 1)e^{-at}}. \end{aligned}$$

At  $t = 60(1850)$  the population is 23.192 million, so

$$23.192 = \frac{c}{1 + (c/3.929 - 1)e^{-60a}}$$

or  $c = 23.192 + 23.192(c/3.929 - 1)e^{-60a}$ . At  $t = 120(1910)$

$$91.972 = \frac{c}{1 + (c/3.929 - 1)e^{-120a}}$$

or  $c = 91.972 + 91.972(c/3.929 - 1)(e^{-60a})^2$ . Combining the two equations for  $c$  we get

$$\left( \frac{c - 23.192}{c/3.929 - 1} \right)^2 \left( \frac{c}{3.929} - 1 \right) = \frac{c - 91.972}{91.972}$$

or

$$91.972(3.929)(c - 23.192)^2 = (23.192)^2(c - 91.972)(c - 3.929).$$

The solution of this quadratic equation is  $c = 197.274$ . This in turn gives  $a = 0.0313$ . Therefore

$$P(t) = \frac{197.274}{1 + 49.21e^{-0.0313t}}.$$



### Exercises 3.2

8. From  $\frac{dX}{dt} = k(150 - X)^2$ ,  $X(0) = 0$ , and  $X(5) = 10$  we obtain  $X = 150 - \frac{150}{150kt + 1}$  where  $k = .000095238$ . Then  $X(20) = 33.3$  grams and  $X \rightarrow 150$  as  $t \rightarrow \infty$  so that the amount of  $A \rightarrow 0$  and the amount of  $B \rightarrow 0$  as  $t \rightarrow \infty$ . If  $X(t) = 75$  then  $t = 70$  minutes.

9. (a) The initial-value problem is  $dh/dt = -8A_h\sqrt{h}/A_w$ ,  $h(0) = H$ . Separating variables and integrating we have

$$\frac{dh}{\sqrt{h}} = -\frac{8A_h}{A_w} dt \quad \text{and} \quad 2\sqrt{h} = -\frac{8A_h}{A_w}t + c.$$

Using  $h(0) = H$  we find  $c = 2\sqrt{H}$ , so the solution of the initial-value problem is  $\sqrt{h(t)} = (A_w\sqrt{H} - 4A_h t)/A_w$ , where  $A_w\sqrt{H} - 4A_h t \geq 0$ . Thus,  $h(t) = (A_w\sqrt{H} - 4A_h t)^2/A_w^2$  for  $0 \leq t \leq A_wH/4A_h$ .

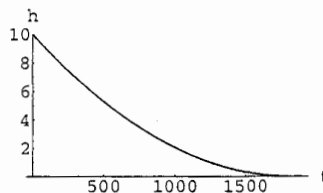

- (b) Identifying  $H = 10$ ,  $A_w = 4\pi$ , and  $A_h = \pi/576$  we have  $h(t) = t^2/331,776 - (\sqrt{5/2}/144)t + 10$ . Solving  $h(t) = 0$  we see that the tank empties in  $576\sqrt{10}$  seconds or 30.36 minutes.
10. To obtain the solution of this differential equation we use  $h(t)$  from part (a) of Problem 11 in Exercises 11.3 with  $A_h$  replaced by  $cA_h$ . Then  $h(t) = (A_w\sqrt{H} - 4cA_h t)^2/A_w^2$ . Solving  $h(t) = 0$  with  $c = 0.6$  and the values from Problem 11 we see that the tank empties in 3035.79 seconds or 50.6 minutes.

11. (a) Separating variables and integrating we have

$$6h^{3/2}dh = -5t \quad \text{and} \quad \frac{12}{5}h^{5/2} = -5t + c.$$

Using  $h(0) = 20$  we find  $c = 1920\sqrt{5}$ , so the solution of the initial-value problem is  $h(t) = (800\sqrt{5} - \frac{25}{12}t)^{2/5}$ . Solving  $h(t) = 0$  we see that the tank empties in  $384\sqrt{5}$  seconds or 14.31 minutes.

- (b) When the height of the water is  $h$ , the radius of the top of the water is  $r = h \tan 30^\circ = h/\sqrt{3}$  and  $A_w = \pi h^2/3$ . The differential equation is

$$\frac{dh}{dt} = -c\frac{A_h}{A_w}\sqrt{2gh} = -0.6\frac{\pi(2/12)^2}{\pi h^2/3}\sqrt{64h} = -\frac{2}{5h^{3/2}}.$$

Separating variables and integrating we have

$$5h^{3/2}dh = -2dt \quad \text{and} \quad 2h^{5/2} = -2t + c.$$

Using  $h(0) = 9$  we find  $c = 486$ , so the solution of the initial-value problem is  $h(t) = (243 - t)^{2/5}$ . Solving  $h(t) = 0$  we see that the tank empties in 24.3 seconds or 4.05 minutes.

12. When the height of the water is  $h$ , the radius of the top of the water is  $\frac{2}{5}(20 - h)$  and  $A_w = 4\pi(20 - h)^2/25$ . The differential equation is

$$\frac{dh}{dt} = -c\frac{A_h}{A_w}\sqrt{2gh} = -0.6\frac{\pi(2/12)^2}{4\pi(20 - h)^2/25}\sqrt{64h} = -\frac{5}{6}\frac{\sqrt{h}}{(20 - h)^2}.$$

Exercises 3.2

(b)

Year	Census Population	Predicted Population	Error	% Error
1790	3.929	3.929	0.000	0.00
1800	5.308	5.334	-0.026	-0.49
1810	7.240	7.222	0.018	0.24
1820	9.638	9.746	-0.108	-1.12
1830	12.866	13.090	-0.224	-1.74
1840	17.069	17.475	-0.406	-2.38
1850	23.192	23.143	0.049	0.21
1860	31.433	30.341	1.092	3.47
1870	38.558	39.272	-0.714	-1.85
1880	50.156	50.044	0.112	0.22
1890	62.948	62.600	0.348	0.55
1900	75.996	76.666	-0.670	-0.88
1910	91.972	91.739	0.233	0.25
1920	105.711	107.143	-1.432	-1.35
1930	122.775	122.140	0.635	0.52
1940	131.669	136.068	-4.399	-3.34
1950	150.697	148.445	2.252	1.49

The model predicts a population of 159.0 million for 1960 and 167.8 million for 1970. The census populations for these years were 179.3 and 203.3, respectively. The percentage errors are 12.8 and 21.2, respectively.

5. (a) The differential equation is  $dP/dt = P(1 - \ln P)$ , which has equilibrium solution  $P = e$ . When  $P_0 > e$ ,  $dP/dt < 0$ , and when  $P_0 < e$ ,  $dP/dt > 0$ .

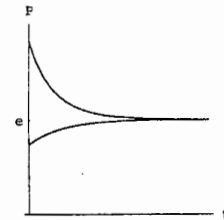

- (b) The differential equation is  $dP/dt = P(1 + \ln P)$ , which has equilibrium solution  $P = 1/e$ . When  $P_0 > 1/e$ ,  $dP/dt > 0$ , and when  $P_0 < 1/e$ ,  $dP/dt < 0$ .

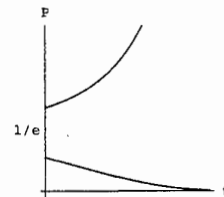

6. From  $\frac{dP}{dt} = P(a - b \ln P)$  we obtain  $\frac{-1}{b} \ln |a - b \ln P| = t + c_1$  so that  $P = e^{a/b} e^{-ce^{-bt}}$ . If  $P(0) = P_0$  then  $c = \frac{a}{b} - \ln P_0$ .

7. Let  $X = X(t)$  be the amount of  $C$  at time  $t$  and  $\frac{dX}{dt} = k(120 - 2X)(150 - X)$ . If  $X(0) = 0$  and  $X(5) = 10$  then  $X = \frac{150 - 150e^{180kt}}{1 - 2.5e^{180kt}}$  where  $k = .0001259$ , and  $X(20) = 29.3$  grams. Now  $X \rightarrow 60$  as  $t \rightarrow \infty$ , so that the amount of  $A \rightarrow 0$  and the amount of  $B \rightarrow 30$  as  $t \rightarrow \infty$ .

### Exercises 3.2

14. We solve

$$m \frac{dv}{dt} = -mg - kv^2, \quad v(0) = 300$$

using separation of variables. This gives

$$v(t) = \sqrt{\frac{mg}{k}} \tan \left( \tan^{-1} 300 \sqrt{\frac{k}{mg}} - \sqrt{\frac{kg}{m}} t \right).$$

Integrating and using  $s(0) = 0$  we find

$$s(t) = \frac{m}{k} \ln \left| \cos \sqrt{\frac{kg}{m}} t - \tan^{-1} 300 \sqrt{\frac{k}{mg}} \right| + \frac{m}{2k} \ln \left( 1 + \frac{90000k}{mg} \right).$$

Solving  $v(t) = 0$  we see that  $t_a = 6.60159$ . The maximum height is  $s(t_a) = 823.84$  ft.

15. (a) Let  $\rho$  be the weight density of the water and  $V$  the volume of the object. Archimedes' principle states that the upward buoyant force has magnitude equal to the weight of the water displaced. Taking the positive direction to be down, the differential equation is

$$m \frac{dv}{dt} = mg - kv^2 - \rho V.$$

(b) Using separation of variables we have

$$\begin{aligned} \frac{m dv}{(mg - \rho V) - kv^2} &= dt \\ \frac{m}{\sqrt{k}} \frac{\sqrt{k} dv}{(\sqrt{mg - \rho V})^2 - (\sqrt{k} v)^2} &= dt \\ \frac{m}{\sqrt{k}} \frac{1}{\sqrt{mg - \rho V}} \tanh^{-1} \frac{\sqrt{k} v}{\sqrt{mg - \rho V}} &= t + c. \end{aligned}$$

Thus

$$v(t) = \sqrt{\frac{mg - \rho V}{k}} \tanh \left( \frac{\sqrt{kmg - k\rho V}}{m} t + c_1 \right).$$

(c) Since  $\tanh t \rightarrow 1$  as  $t \rightarrow \infty$ , the terminal velocity is  $\sqrt{(mg - \rho V)/k}$ .

16. (a) Writing the equation in the form  $(x - \sqrt{x^2 + y^2})dx + y dy$  we identify  $M = x - \sqrt{x^2 + y^2}$  and  $N = y$ . Since  $M$  and  $N$  are both homogeneous of degree 1 we use the substitution  $y = ux$ . It

Separating variables and integrating we have

$$\frac{(20-h)^2}{\sqrt{h}} dh = -\frac{5}{6} dt \quad \text{and} \quad 800\sqrt{h} - \frac{80}{3}h^{3/2} + \frac{2}{5}h^{5/2} = -\frac{5}{6}t + c.$$

Using  $h(0) = 20$  we find  $c = 2560\sqrt{5}/3$ , so an implicit solution of the initial-value problem is

$$800\sqrt{h} - \frac{80}{3}h^{3/2} + \frac{2}{5}h^{5/2} = -\frac{5}{6}t + \frac{2560\sqrt{5}}{3}.$$

To find the time it takes the tank to empty we set  $h = 0$  and solve for  $t$ . The tank empties in  $1024\sqrt{5}$  seconds or 38.16 minutes. Thus, the tank empties more slowly when the base of the cone is on the bottom.

13. (a) Separating variables we obtain

$$\begin{aligned} \frac{m dv}{mg - kv^2} &= dt \\ \frac{1}{g} \frac{dv}{1 - (kv/mg)^2} &= dt \\ \frac{\sqrt{mg}}{\sqrt{k}g} \frac{\sqrt{k/mg} dv}{1 - (\sqrt{k}v/\sqrt{mg})^2} &= dt \\ \sqrt{\frac{m}{kg}} \tanh^{-1} \frac{\sqrt{k}v}{\sqrt{mg}} &= t + c \\ \tanh^{-1} \frac{\sqrt{k}v}{\sqrt{mg}} &= \sqrt{\frac{kg}{m}} t + c_1. \end{aligned}$$

Thus the velocity at time  $t$  is

$$v(t) = \sqrt{\frac{mg}{k}} \tanh \left( \sqrt{\frac{kg}{m}} t + c_1 \right).$$

Setting  $t = 0$  and  $v = v_0$  we find  $c_1 = \tanh^{-1}(\sqrt{k}v_0/\sqrt{mg})$ .

(b) Since  $\tanh t \rightarrow 1$  as  $t \rightarrow \infty$ , we have  $v \rightarrow \sqrt{mg/k}$  as  $t \rightarrow \infty$ .

(c) Integrating the expression for  $v(t)$  in part (a) we obtain

$$s(t) = \sqrt{\frac{mg}{k}} \int \tanh \left( \sqrt{\frac{kg}{m}} t + c_1 \right) dt = \frac{m}{k} \ln \left[ \cosh \left( \sqrt{\frac{kg}{m}} t + c_1 \right) \right] + c_2.$$

Setting  $t = 0$  and  $s = s_0$  we find  $c_2 = s_0 - \frac{m}{k} \ln(\cosh c_1)$ .

follows that

$$\begin{aligned} (x - \sqrt{x^2 + u^2 x^2}) dx + ux(u dx + x du) &= 0 \\ x \left[ (1 - \sqrt{1 + u^2}) + u^2 \right] dx + x^2 u du &= 0 \\ -\frac{u du}{1 + u^2 - \sqrt{1 + u^2}} &= \frac{dx}{x} \\ \frac{u du}{\sqrt{1 + u^2} (1 - \sqrt{1 + u^2})} &= \frac{dx}{x}. \end{aligned}$$

Letting  $w = 1 - \sqrt{1 + u^2}$  we have  $dw = -u du / \sqrt{1 + u^2}$  so that

$$\begin{aligned} -\ln(1 - \sqrt{1 + u^2}) &= \ln x + c \\ \frac{1}{1 - \sqrt{1 + u^2}} &= c_1 x \\ 1 - \sqrt{1 + u^2} &= -\frac{c_2}{x} \quad (-c_2 = 1/c_1) \\ 1 + \frac{c_2}{x} &= \sqrt{1 + \frac{y^2}{x^2}} \\ 1 + \frac{2c_2}{x} + \frac{c_2^2}{x^2} &= 1 + \frac{y^2}{x^2}. \end{aligned}$$

Solving for  $y^2$  we have

$$y^2 = 2c_2 x + c_2^2 = 4 \left( \frac{c_2}{2} \right) \left( x + \frac{c_2}{2} \right)$$

which is a family of parabolas symmetric with respect to the  $x$ -axis with vertex at  $(-c_2/2, 0)$  and focus at the origin.

(b) Let  $u = x^2 + y^2$  so that

$$\frac{du}{dx} = 2x + 2y \frac{dy}{dx}.$$

Then

$$y \frac{dy}{dx} = \frac{1}{2} \frac{du}{dx} - x$$

and the differential equation can be written in the form

$$\frac{1}{2} \frac{du}{dx} - x = -x + \sqrt{u} \quad \text{or} \quad \frac{1}{2} \frac{du}{dx} = \sqrt{u}.$$

### Exercises 3.2

Separating variables and integrating we have

$$\begin{aligned}\frac{du}{2\sqrt{u}} &= dx \\ \sqrt{u} &= x + c \\ u &= x^2 + 2cx + c^2 \\ x^2 + y^2 &= x^2 + 2cx + c^2 \\ y^2 &= 2cx + c^2.\end{aligned}$$

17. (a) From  $2W^2 - W^3 = W^2(2 - W) = 0$  we see that  $W = 0$  and  $W = 2$  are constant solutions.  
 (b) Separating variables and using a CAS to integrate we get

$$\frac{dW}{W\sqrt{4-2W}} = dx \quad \text{and} \quad -\tanh^{-1}\left(\frac{1}{2}\sqrt{4-2W}\right) = x + c.$$

Using the facts that the hyperbolic tangent is an odd function and  $1 - \tanh^2 x = \operatorname{sech}^2 x$  we have

$$\begin{aligned}\frac{1}{2}\sqrt{4-2W} &= \tanh(-x - c) = -\tanh(x + c) \\ \frac{1}{4}(4-2W) &= \tanh^2(x + c) \\ 1 - \frac{1}{2}W &= \tanh^2(x + c) \\ \frac{1}{2}W &= 1 - \tanh^2(x + c) = \operatorname{sech}^2(x + c).\end{aligned}$$

Thus,  $W(x) = 2\operatorname{sech}^2(x + c)$ .

- (c) Letting  $x = 0$  and  $W = 2$  we find that  $\operatorname{sech}^2(c) = 1$  and  $c = 0$ .

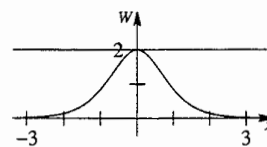

18. (a) Solving  $r^2 + (10 - h)^2 = 10^2$  for  $r^2$  we see that  $r^2 = 20h - h^2$ . Combining the rate of input of water,  $\pi$ , with the rate of output due to evaporation,  $k\pi r^2 = k\pi(20h - h^2)$ , we have  $dV/dt = \pi - k\pi(20h - h^2)$ . Using  $V = 10\pi h^2 - \frac{1}{3}\pi h^3$ , we see also that  $dV/dt = (20\pi h - \pi h^2)dh/dt$ . Thus,

$$(20\pi h - \pi h^2)\frac{dh}{dt} = \pi - k\pi(20h - h^2) \quad \text{and} \quad \frac{dh}{dt} = \frac{1 - 20kh + kh^2}{20h - h^2}.$$

Exercises 3.2

- (b) Letting  $k = 1/100$ , separating variables and integrating (with the help of a CAS), we get

$$\frac{100h(h-20)}{(h-10)^2} dh = dt \quad \text{and} \quad \frac{100(h^2 - 10h + 100)}{10-h} = t + c.$$

Using  $h(0) = 0$  we find  $c = 1000$ , and solving for  $h$  we get  $h(t) = 0.005(\sqrt{t^2 + 4000t} - t)$ , where the positive square root is chosen because  $h \geq 0$ .

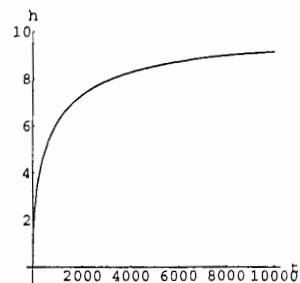

- (c) The volume of the tank is  $V = \frac{2}{3}\pi(10)^3$  feet, so at a rate of  $\pi$  cubic feet per minute, the tank will fill in  $\frac{2}{3}(10)^3 \approx 666.67$  minutes  $\approx 11.11$  hours.
- (d) At 666.67 minutes, the depth of the water is  $h(666.67) = 5.486$  feet. From the graph in (b) we suspect that  $\lim_{t \rightarrow \infty} h(t) = 10$ , in which case the tank will never completely fill. To prove this we compute the limit of  $h(t)$ :

$$\begin{aligned} \lim_{t \rightarrow \infty} h(t) &= 0.005 \lim_{t \rightarrow \infty} (\sqrt{t^2 + 4000t} - t) = 0.005 \lim_{t \rightarrow \infty} \frac{t^2 + 4000t - t^2}{\sqrt{t^2 + 4000t} + t} \\ &= 0.005 \lim_{t \rightarrow \infty} \frac{4000t}{t\sqrt{1 + 4000/t} + t} = 0.005 \lim_{t \rightarrow \infty} \frac{4000}{1 + 1} = 0.005(2000) = 10. \end{aligned}$$

19. (a)

t	P(t)	Q(t)
0	3.929	0.035
10	5.308	0.036
20	7.240	0.033
30	9.638	0.033
40	12.866	0.033
50	17.069	0.036
60	23.192	0.036
70	31.433	0.023
80	38.558	0.030
90	50.156	0.026
100	62.948	0.021
110	75.996	0.021
120	91.972	0.015
130	105.711	0.016
140	122.775	0.007
150	131.669	0.014
160	150.697	0.019
170	179.300	

Exercises 3.2

- (b) The regression line is  $Q = 0.0348391 - 0.000168222P$ .

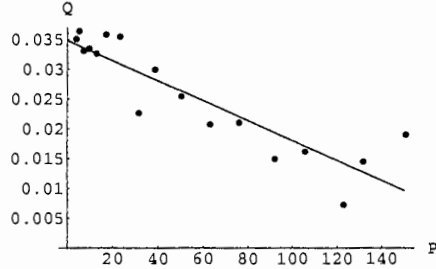

- (c) The solution of the logistic equation is given in equation (5) in the text. Identifying  $a = 0.0348391$  and  $b = 0.000168222$  we have

$$P(t) = \frac{aP_0}{bP_0 + (a - bP_0)e^{-at}}$$

- (d) With  $P_0 = 3.929$  the solution becomes

$$P(t) = \frac{0.136883}{0.000660944 + 0.0341781e^{-0.0348391t}}$$

- (e)

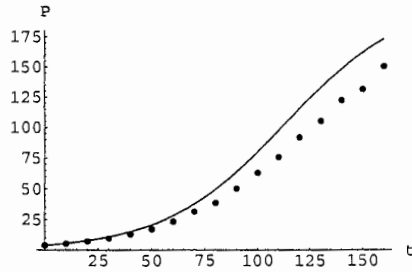

- (f) We identify  $t = 180$  with 1970,  $t = 190$  with 1980, and  $t = 200$  with 1990. The model predicts  $P(180) = 188.661$ ,  $P(190) = 193.735$ , and  $P(200) = 197.485$ . The actual population figures for these years are 203.303, 226.542, and 248.765 millions. As  $t \rightarrow \infty$ ,  $P(t) \rightarrow a/b = 207.102$ .
20. (a) Using a CAS to solve  $P(1 - P) + 0.3e^{-P} = 0$  for  $P$  we see that  $P = 1.09216$  is an equilibrium solution.
- (b) Since  $f(P) > 0$  for  $0 < P < 1.09216$ , the solution  $P(t)$  of

$$dP/dt = P(1 - P) + 0.3e^{-P}, \quad P(0) = P_0,$$

is increasing for  $P_0 < 1.09216$ . Since  $f(P) < 0$  for  $P > 1.09216$ , the solution  $P(t)$  is decreasing for  $P_0 > 1.09216$ . Thus  $P = 1.09216$  is an attractor.

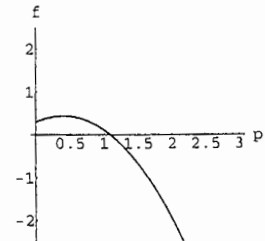



Exercises 3.2

- (c) The curves for the second initial-value problem are thicker. The equilibrium solution for the logic model is  $P = 1$ . Comparing 1.09216 and 1, we see that the percentage increase is 9.216%.

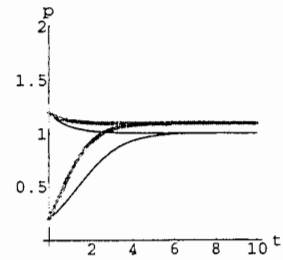

21. To find  $t_d$  we solve

$$m \frac{dv}{dt} = mg - kv^2, \quad v(0) = 0$$

using separation of variables. This gives

$$v(t) = \sqrt{\frac{mg}{k}} \tanh \sqrt{\frac{kg}{m}} t.$$

Integrating and using  $s(0) = 0$  gives

$$s(t) = \frac{m}{k} \ln \left( \cosh \sqrt{\frac{kg}{m}} t \right).$$

To find the time of descent we solve  $s(t) = 823.84$  and find  $t_d = 7.77882$ . The impact velocity is  $v(t_d) = 182.998$ , which is positive because the positive direction is downward.

22. (a) Solving  $v_t = \sqrt{mg/k}$  for  $k$  we obtain  $k = mg/v_t^2$ . The differential equation then becomes

$$m \frac{dv}{dt} = mg - \frac{mg}{v_t^2} v^2 \quad \text{or} \quad \frac{dv}{dt} = g \left( 1 - \frac{1}{v_t^2} v^2 \right).$$

Separating variables and integrating gives

$$v_t \tanh^{-1} \frac{v}{v_t} = gt + c_1.$$

The initial condition  $v(0) = 0$  implies  $c_1 = 0$ , so

$$v(t) = v_t \tanh \frac{gt}{v_t}.$$

We find the distance by integrating:

$$s(t) = \int v_t \tanh \frac{gt}{v_t} dt = \frac{v_t^2}{g} \ln \left( \cosh \frac{gt}{v_t} \right) + c_2.$$

The initial condition  $s(0) = 0$  implies  $c_2 = 0$ , so

$$s(t) = \frac{v_t^2}{g} \ln \left( \cosh \frac{gt}{v_t} \right).$$

In 25 seconds she has fallen  $20,000 - 14,800 = 5,200$  feet. Solving

$$5200 = (v_t^2/32) \ln \left( \cosh \frac{32(25)}{v_t} \right)$$

### Exercises 3.2

for  $v_t$  gives  $v_t \approx 271.711$  ft/s. Then

$$s(t) = \frac{v_t^2}{g} \ln\left(\cosh \frac{gt}{v_t}\right) = 2307.08 \ln(\cosh 0.117772t).$$

(b) At  $t = 15$ ,  $s(15) = 2,542.94$  ft and  $v(15) = s'(15) = 256.287$  ft/sec.

23. While the object is in the air its velocity is modeled by the linear differential equation  $m dv/dt = mg - kv$ . Using  $m = 160$ ,  $k = \frac{1}{4}$ , and  $g = 32$ , the differential equation becomes  $dv/dt + (1/640)v = 32$ . The integrating factor is  $e^{\int dt/640} = e^{t/640}$  and the solution of the differential equation is  $e^{t/640}v = \int 32e^{t/640}dt = 20,480e^{t/640} + c$ . Using  $v(0) = 0$  we see that  $c = -20,480$  and  $v(t) = 20,480 - 20,480e^{-t/640}$ . Integrating we get  $s(t) = 20,480t + 13,107,200e^{-t/640} + c$ . Since  $s(0) = 0$ ,  $c = -13,107,200$  and  $s(t) = -13,107,200 + 20,480t + 13,107,200e^{-t/640}$ . To find when the object hits the liquid we solve  $s(t) = 500 - 75 = 425$ , obtaining  $t_a = 5.16018$ . The velocity at the time of impact with the liquid is  $v_a = v(t_a) = 164.482$ . When the object is in the liquid its velocity is modeled by  $m dv/dt = mg - kv^2$ . Using  $m = 160$ ,  $g = 32$ , and  $k = 0.1$  this becomes  $dv/dt = (51,200 - v^2)/1600$ . Separating variables and integrating we have

$$\frac{dv}{51,200 - v^2} = \frac{dt}{1600} \quad \text{and} \quad \frac{\sqrt{2}}{640} \ln \left| \frac{v - 160\sqrt{2}}{v + 160\sqrt{2}} \right| = \frac{1}{1600}t + c.$$

Solving  $v(0) = v_a = 164.482$  we obtain  $c = -0.00407537$ . Then, for  $v < 160\sqrt{2} = 226.274$ ,

$$\left| \frac{v - 160\sqrt{2}}{v + 160\sqrt{2}} \right| = e^{\sqrt{2}t/5 - 1.8443} \quad \text{or} \quad -\frac{v - 160\sqrt{2}}{v + 160\sqrt{2}} = e^{\sqrt{2}t/5 - 1.8443}.$$

Solving for  $v$  we get

$$v(t) = \frac{13964.6 - 2208.29e^{\sqrt{2}t/5}}{61.7153 + 9.75937e^{\sqrt{2}t/5}}.$$

Integrating we find

$$s(t) = 226.275t - 1600 \ln(6.3237 + e^{\sqrt{2}t/5}) + c.$$

Solving  $s(0) = 0$  we see that  $c = 3185.78$ , so

$$s(t) = 3185.78 + 226.275t - 1600 \ln(6.3237 + e^{\sqrt{2}t/5}).$$

To find when the object hits the bottom of the tank we solve  $s(t) = 75$ , obtaining  $t_b = 0.466273$ . The time from when the object is dropped from the helicopter to when it hits the bottom of the tank is  $t_a + t_b = 5.62708$  seconds.

## Exercises 3.3

1. The equation  $dx/dt = -\lambda_1 x$  can be solved by separation of variables. Integrating both sides of  $dx/x = -\lambda_1 dt$  we obtain  $\ln|x| = -\lambda_1 t + c$  from which we get  $x = c_1 e^{-\lambda_1 t}$ . Using  $x(0) = x_0$  we find  $c_1 x_0$  so that  $x = x_0 e^{-\lambda_1 t}$ . Substituting this result into the second differential equation we have

$$\frac{dy}{dt} + \lambda_2 y = \lambda_1 x_0 e^{-\lambda_1 t}$$

which is linear. An integrating factor is  $e^{\lambda_2 t}$  so that

$$\begin{aligned} \frac{d}{dt} [e^{\lambda_2 t} y] &= \lambda_1 x_0 e^{(\lambda_2 - \lambda_1)t} + c_2 \\ y &= \frac{\lambda_1 x_0}{\lambda_2 - \lambda_1} e^{(\lambda_2 - \lambda_1)t} e^{-\lambda_2 t} + c_2 e^{-\lambda_2 t} = \frac{\lambda_1 x_0}{\lambda_2 - \lambda_1} e^{-\lambda_1 t} + c_2 e^{-\lambda_2 t}. \end{aligned}$$

Using  $y(0) = 0$  we find  $c_2 = -\lambda_1 x_0 / (\lambda_2 - \lambda_1)$ . Thus

$$y = \frac{\lambda_1 x_0}{\lambda_2 - \lambda_1} (e^{-\lambda_1 t} - e^{-\lambda_2 t}).$$

Substituting this result into the third differential equation we have

$$\frac{dz}{dt} = \frac{\lambda_1 \lambda_2 x_0}{\lambda_2 - \lambda_1} (e^{-\lambda_1 t} - e^{-\lambda_2 t}).$$

Integrating we find

$$z = -\frac{\lambda_2 x_0}{\lambda_2 - \lambda_1} e^{-\lambda_1 t} + \frac{\lambda_1 x_0}{\lambda_2 - \lambda_1} e^{-\lambda_2 t} + c_3.$$

Using  $z(0) = 0$  we find  $c_3 = x_0$ . Thus

$$z = x \left( 1 - \frac{\lambda_2}{\lambda_2 - \lambda_1} e^{-\lambda_1 t} + \frac{\lambda_1}{\lambda_2 - \lambda_1} e^{-\lambda_2 t} \right).$$

2. We see from the graph that the half-life of  $A$  is approximately 4.7 days. To determine the half-life of  $B$  we use  $t = 50$  as a base, since at this time the amount of substance  $A$  is so small that it contributes very little to substance  $B$ . Now we see from the graph that  $y(50) \approx 16.2$  and  $y(191) \approx 8.1$ . Thus, the half-life of  $B$  is approximately 141 days.

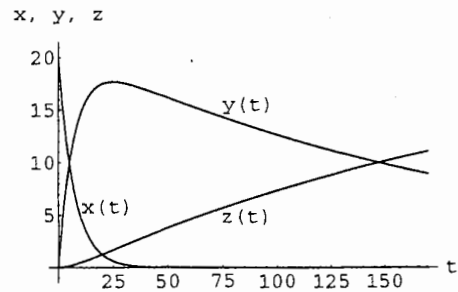

3. The amounts of  $x$  and  $y$  are the same at about  $t = 5$  days. The amounts of  $x$  and  $z$  are the same at about  $t = 20$  days. The amounts of  $y$  and  $z$  are the same at about  $t = 147$  days. The time when  $y$  and  $z$  are the same makes sense because most of  $A$  and half of  $B$  are gone, so half of  $C$  should have been formed.

### Exercises 3.3

4. Suppose that the series is described schematically by  $W \Rightarrow -\lambda_1 X \Rightarrow -\lambda_2 Y \Rightarrow -\lambda_3 Z$  where  $-\lambda_1$ ,  $-\lambda_2$ , and  $-\lambda_3$  are the decay constants for  $W$ ,  $X$  and  $Y$ , respectively, and  $Z$  is a stable element. Let  $w(t)$ ,  $x(t)$ ,  $y(t)$ , and  $z(t)$  denote the amounts of substances  $W$ ,  $X$ ,  $Y$ , and  $Z$ , respectively. A model for the radioactive series is

$$\begin{aligned}\frac{dw}{dt} &= -\lambda_1 w \\ \frac{dx}{dt} &= \lambda_1 w - \lambda_2 x \\ \frac{dy}{dt} &= \lambda_2 x - \lambda_3 y \\ \frac{dz}{dt} &= \lambda_3 y.\end{aligned}$$

5. The system is

$$\begin{aligned}x_1' &= 2 \cdot 3 + \frac{1}{50}x_2 - \frac{1}{50}x_1 \cdot 4 = -\frac{2}{25}x_1 + \frac{1}{50}x_2 + 6 \\ x_2' &= \frac{1}{50}x_1 \cdot 4 - \frac{1}{50}x_2 - \frac{1}{50}x_2 \cdot 3 = \frac{2}{25}x_1 - \frac{2}{25}x_2.\end{aligned}$$

6. Let  $x_1$ ,  $x_2$ , and  $x_3$  be the amounts of salt in tanks A, B, and C, respectively, so that

$$\begin{aligned}x_1' &= \frac{1}{100}x_2 \cdot 2 - \frac{1}{100}x_1 \cdot 6 = \frac{1}{50}x_2 - \frac{3}{50}x_1 \\ x_2' &= \frac{1}{100}x_1 \cdot 6 + \frac{1}{100}x_3 - \frac{1}{100}x_2 \cdot 2 - \frac{1}{100}x_2 \cdot 5 = \frac{3}{50}x_1 - \frac{7}{100}x_2 + \frac{1}{100}x_3 \\ x_3' &= \frac{1}{100}x_2 \cdot 5 - \frac{1}{100}x_3 - \frac{1}{100}x_3 \cdot 4 = \frac{1}{20}x_2 - \frac{1}{20}x_3.\end{aligned}$$

7. (a) A model is

$$\begin{aligned}\frac{dx_1}{dt} &= 3 \cdot \frac{x_2}{100-t} - 2 \cdot \frac{x_1}{100+t}, & x_1(0) &= 100 \\ \frac{dx_2}{dt} &= 2 \cdot \frac{x_1}{100+t} - 3 \cdot \frac{x_2}{100-t}, & x_2(0) &= 50.\end{aligned}$$

- (b) Since the system is closed, no salt enters or leaves the system and  $x_1(t) + x_2(t) = 100 + 50 = 150$  for all time. Thus  $x_1 = 150 - x_2$  and the second equation in part (a) becomes

$$\frac{dx_2}{dt} = \frac{2(150 - x_2)}{100 + t} - \frac{3x_2}{100 - t} = \frac{300}{100 + t} - \frac{2x_2}{100 + t} - \frac{3x_2}{100 - t}$$

or

$$\frac{dx_2}{dt} + \left( \frac{2}{100 + t} + \frac{3}{100 - t} \right) x_2 = \frac{300}{100 + t},$$

which is linear in  $x_2$ . An integrating factor is

$$e^{2 \ln(100+t) - 3 \ln(100-t)} = (100 + t)^2 (100 - t)^{-3}$$

### Exercises 3.3

so

$$\frac{d}{dt}[(100+t)^2(100-t)^{-3}x_2] = 300(100+t)(100-t)^{-3}.$$

Using integration by parts, we obtain

$$(100+t)^2(100-t)^{-3}x_2 = 300 \left[ \frac{1}{2}(100+t)(100-t)^{-2} - \frac{1}{2}(100-t)^{-1} + c \right].$$

Thus

$$\begin{aligned} x_2 &= \frac{300}{(100+t)^2} \left[ c(100-t)^3 - \frac{1}{2}(100-t)^2 + \frac{1}{2}(100+t)(100-t) \right] \\ &= \frac{300}{(100+t)^2} [c(100-t)^3 + t(100-t)]. \end{aligned}$$

Using  $x_2(0) = 50$  we find  $c = 5/3000$ . At  $t = 30$ ,  $x_2 = (300/130^2)(70^3c + 30 \cdot 70) \approx 47.4$  lbs.

8. A model is

$$\begin{aligned} \frac{dx_1}{dt} &= (4 \text{ gal/min})(0 \text{ lb/gal}) - (4 \text{ gal/min}) \left( \frac{1}{200}x_1 \text{ lb/gal} \right) \\ \frac{dx_2}{dt} &= (4 \text{ gal/min}) \left( \frac{1}{200}x_1 \text{ lb/gal} \right) - (4 \text{ gal/min}) \left( \frac{1}{150}x_2 \text{ lb/gal} \right) \\ \frac{dx_3}{dt} &= (4 \text{ gal/min}) \left( \frac{1}{150}x_2 \text{ lb/gal} \right) - (4 \text{ gal/min}) \left( \frac{1}{100}x_3 \text{ lb/gal} \right) \end{aligned}$$

or

$$\begin{aligned} \frac{dx_1}{dt} &= -\frac{1}{50}x_1 \\ \frac{dx_2}{dt} &= \frac{1}{50}x_1 - \frac{2}{75}x_2 \\ \frac{dx_3}{dt} &= \frac{2}{75}x_2 - \frac{1}{25}x_3. \end{aligned}$$

Over a long period of time we would expect  $x_1$ ,  $x_2$ , and  $x_3$  to approach 0 because the entering pure water should flush the salt out of all three tanks.

9. From the graph we see that the populations are first equal at about  $t = 5.6$ . The approximate periods of  $x$  and  $y$  are both 45.

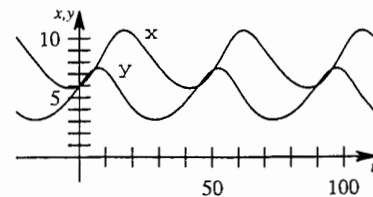

### Exercises 3.3

10. (a) The population  $y(t)$  approaches 10,000, while the population  $x(t)$  approaches extinction.

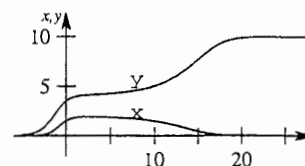

- (b) The population  $x(t)$  approaches 5,000, while the population  $y(t)$  approaches extinction.

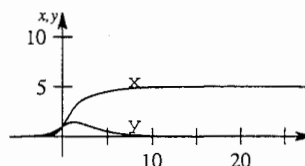

- (c) The population  $y(t)$  approaches 10,000, while the population  $x(t)$  approaches extinction.

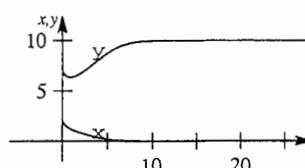

- (d) The population  $x(t)$  approaches 5,000, while the population  $y(t)$  approaches extinction.

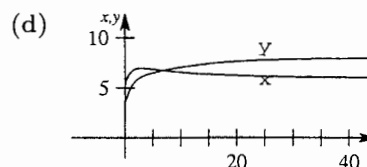
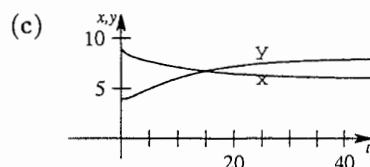
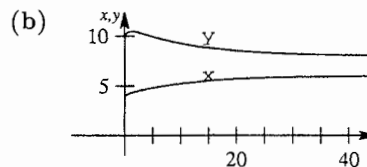
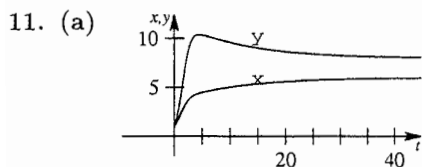
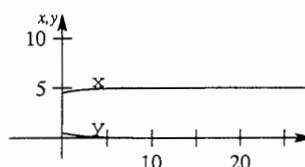

In each case the population  $x(t)$  approaches 6,000, while the population  $y(t)$  approaches 8,000.

12. By Kirchoff's first law we have  $i_1 = i_2 + i_3$ . By Kirchoff's second law, on each loop we have  $E(t) = Li_1' + R_1i_2$  and  $E(t) = Li_1' + R_2i_3 + \frac{1}{C}q$  so that  $q = CR_1i_2 - CR_2i_3$ . Then  $i_3 = q' = CR_1i_2' - CR_2i_3'$  so that the system is

$$Li_2' + Li_3' + R_1i_2 = E(t)$$

$$-R_1i_2' + R_2i_3' + \frac{1}{C}i_3 = 0.$$

### Exercises 3.3

13. By Kirchoff's first law we have  $i_1 = i_2 + i_3$ . Applying Kirchoff's second law to each loop we obtain

$$E(t) = i_1 R_1 + L_1 \frac{di_2}{dt} + i_2 R_2$$

and

$$E(t) = i_1 R_1 + L_2 \frac{di_3}{dt} + i_3 R_3.$$

Combining the three equations, we obtain the system

$$L_1 \frac{di_2}{dt} + (R_1 + R_2)i_2 + R_1 i_3 = E$$

$$L_2 \frac{di_3}{dt} + R_1 i_2 + (R_1 + R_3)i_3 = E.$$

14. By Kirchoff's first law we have  $i_1 = i_2 + i_3$ . By Kirchoff's second law, on each loop we have

$E(t) = Li_1' + Ri_2$  and  $E(t) = Li_1' + \frac{1}{C}q$  so that  $q = CRi_2$ . Then  $i_3 = q' = CRi_2'$  so that system is

$$Li_1' + Ri_2 = E(t)$$

$$CRi_2' + i_2 - i_1 = 0.$$

15. We first note that  $s(t) + i(t) + r(t) = n$ . Now the rate of change of the number of susceptible persons,  $s(t)$ , is proportional to the number of contacts between the number of people infected and the number who are susceptible; that is,  $ds/dt = -k_1 s i$ . We use  $-k_1$  because  $s(t)$  is decreasing. Next, the rate of change of the number of persons who have recovered is proportional to the number infected; that is,  $dr/dt = k_2 i$  where  $k_2$  is positive since  $r$  is increasing. Finally, to obtain  $di/dt$  we use

$$\frac{d}{dt}(s + i + r) = \frac{d}{dt} n = 0.$$

This gives

$$\frac{di}{dt} = -\frac{dr}{dt} - \frac{ds}{dt} = -k_2 i + k_1 s i.$$

The system of equations is then

$$\frac{ds}{dt} = -k_1 s i$$

$$\frac{di}{dt} = -k_2 i + k_1 s i$$

$$\frac{dr}{dt} = k_2 i.$$

A reasonable set of initial conditions is  $i(0) = i_0$ , the number of infected people at time 0,  $s(0) = n - i_0$ , and  $r(0) = 0$ .

16. (a) If we know  $s(t)$  and  $i(t)$  then we can determine  $r(t)$  from  $s + i + r = n$ .

### Exercises 3.3

(b) In this case the system is

$$\frac{ds}{dt} = -0.2si$$

$$\frac{di}{dt} = -0.7i + 0.2si.$$

We also note that when  $i(0) = i_0$ ,  $s(0) = 10 - i_0$  since  $r(0) = 0$  and  $i(t) + s(t) + r(t) = 10$  for all values of  $t$ . Now  $k_2/k_1 = 0.7/0.2 = 3.5$ , so we consider initial conditions  $s(0) = 2, i(0) = 8$ ;  $s(0) = 3.4, i(0) = 6.6$ ;  $s(0) = 7, i(0) = 3$ ; and  $s(0) = 9, i(0) = 1$ .

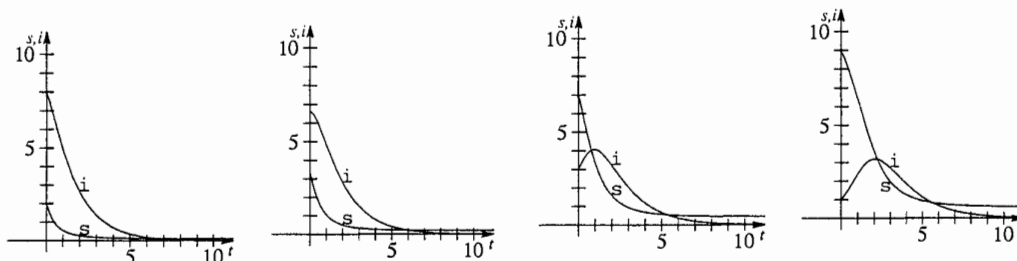

We see that an initial susceptible population greater than  $k_2/k_1$  results in an epidemic in the sense that the number of infected persons increases to a maximum before decreasing to 0. On the other hand, when  $s(0) < k_2/k_1$ , the number of infected persons decreases from the start and there is no epidemic.

17. Since  $x_0 > y_0 > 0$  we have  $x(t) > y(t)$  and  $y - x < 0$ . Thus  $dx/dt < 0$  and  $dy/dt > 0$ . We conclude that  $x(t)$  is decreasing and  $y(t)$  is increasing. As  $t \rightarrow \infty$  we expect that  $x(t) \rightarrow C$  and  $y(t) \rightarrow C$ , where  $C$  is a constant common equilibrium concentration.

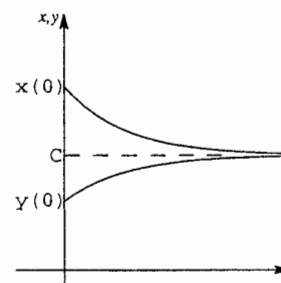

18. We write the system in the form

$$\frac{dx}{dt} = k_1(y - x)$$

$$\frac{dy}{dt} = k_2(x - y),$$



### Exercises 3.3

where  $k_1 = \kappa/V_A$  and  $k_2 = \kappa/V_B$ . Letting  $z(t) = x(t) - y(t)$  we have

$$\frac{dx}{dt} - \frac{dy}{dt} = k_1(y - x) - k_2(x - y)$$

$$\frac{dz}{dt} = k_1(-z) - k_2z$$

$$\frac{dz}{dt} + (k_1 + k_2)z = 0.$$

This is a first-order linear differential equation with solution  $z(t) = c_1 e^{-(k_1+k_2)t}$ . Now

$$\frac{dx}{dt} = -k_1(y - x) = -k_1z = -k_1c_1 e^{-(k_1+k_2)t}$$

and

$$x(t) = c_1 \frac{k_1}{k_1 + k_2} e^{-(k_1+k_2)t} + c_2.$$

Since  $y(t) = x(t) - z(t)$  we have

$$y(t) = -c_1 \frac{k_2}{k_1 + k_2} e^{-(k_1+k_2)t} + c_2.$$

The initial conditions  $x(0) = x_0$  and  $y(0) = y_0$  imply

$$c_1 = x_0 - y_0 \quad \text{and} \quad c_2 = \frac{x_0 k_2 + y_0 k_1}{k_1 + k_2}.$$

The solution of the system is

$$x(t) = \frac{(x_0 - y_0)k_1}{k_1 + k_2} e^{-(k_1+k_2)t} + \frac{x_0 k_2 + y_0 k_1}{k_1 + k_2}$$

$$y(t) = \frac{(y_0 - x_0)k_2}{k_1 + k_2} e^{-(k_1+k_2)t} + \frac{x_0 k_2 + y_0 k_1}{k_1 + k_2}.$$

As  $t \rightarrow \infty$ ,  $x(t)$  and  $y(t)$  approach the common limit

$$\begin{aligned} \frac{x_0 k_2 + y_0 k_1}{k_1 + k_2} &= \frac{x_0 \kappa/V_B + y_0 \kappa/V_A}{\kappa/V_A + \kappa/V_B} = \frac{x_0 V_A + y_0 V_B}{V_A + V_B} \\ &= x_0 \frac{V_A}{V_A + V_B} + y_0 \frac{V_B}{V_A + V_B}. \end{aligned}$$

This makes intuitive sense because the limiting concentration is seen to be a weighted average of the two initial concentrations.

### Exercises 3.3

19. Since there are initially 25 pounds of salt in tank A and none in tank B, and since furthermore only pure water is being pumped into tank A, we would expect that  $x_1(t)$  would steadily decrease over time. On the other hand, since salt is being added to tank B from tank A, we would expect  $x_2(t)$  to increase over time. However, since pure water is being added to the system at a constant rate and a mixed solution is being pumped out of the system, it makes sense that the amount of salt in both tanks would approach 0 over time.

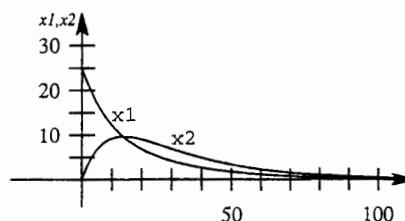

## Chapter 3 Review Exercises

- From  $\frac{dP}{dt} = 0.018P$  and  $P(0) = 4$  billion we obtain  $P = 4e^{0.018t}$  so that  $P(45) = 8.99$  billion.
- Let  $A = A(t)$  be the volume of  $\text{CO}_2$  at time  $t$ . From  $\frac{dA}{dt} = 1.2 - \frac{A}{4}$  and  $A(0) = 16\text{ft}^3$  we obtain  $A = 4.8 + 11.2e^{-t/4}$ . Since  $A(10) = 5.7\text{ft}^3$ , the concentration is 0.017%. As  $t \rightarrow \infty$  we have  $A \rightarrow 4.8\text{ft}^3$  or 0.06%.
- (a) For  $0 \leq t < 4$ ,  $6 \leq t < 10$ , and  $12 \leq t < 16$ , no voltage is applied to the heart and  $E(t) = 0$ . At the other times the differential equation is  $dE/dt = -E/RC$ . Separating variables, integrating, and solving for  $E$ , we get  $E = ke^{-t/RC}$ , subject to  $E(4) = E(10) = E(16) = 12$ . These initial conditions yield, respectively,  $k = 12e^{4/RC}$ ,  $k = 12e^{10/RC}$ , and  $k = 12e^{16/RC}$ . Thus

$$E(t) = \begin{cases} 0, & 0 \leq t < 4, \quad 6 \leq t < 10, \quad 12 \leq t < 16 \\ 12e^{(4-t)/RC}, & 4 \leq t < 6 \\ 12e^{(10-t)/RC}, & 10 \leq t < 12 \\ 12e^{(16-t)/RC}, & 16 \leq t < 18. \end{cases}$$

(b)

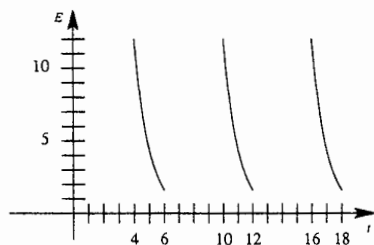

- From  $V dC/dt = kA(C_s - C)$  and  $C(0) = C_0$  we obtain  $C = C_s + (C_0 - C_s)e^{-kAt/V}$ .

5. (a) The differential equation is

$$\frac{dT}{dt} = k[T - T_2 - B(T_1 - T)] = k[(1+B)T - (BT_1 + T_2)].$$

Separating variables we obtain  $\frac{dT}{(1+B)T - (BT_1 + T_2)} = k dt$ . Then

$$\frac{1}{1+B} \ln |(1+B)T - (BT_1 + T_2)| = kt + c \quad \text{and} \quad T(t) = \frac{BT_1 + T_2}{1+B} + c_3 e^{k(1+B)t}.$$

Since  $T(0) = T_1$  we must have  $c_3 = \frac{T_1 - T_2}{1+B}$  and so

$$T(t) = \frac{BT_1 + T_2}{1+B} + \frac{T_1 - T_2}{1+B} e^{k(1+B)t}.$$

(b) Since  $k < 0$ ,  $\lim_{t \rightarrow \infty} e^{k(1+B)t} = 0$  and  $\lim_{t \rightarrow \infty} T(t) = \frac{BT_1 + T_2}{1+B}$ .

(c) Since  $T_s = T_2 + B(T_1 - T)$ ,  $\lim_{t \rightarrow \infty} T_s = T_2 + BT_1 - B \left( \frac{BT_1 + T_2}{1+B} \right) = \frac{BT_1 + T_2}{1+B}$ .

6. We first solve  $\left(1 - \frac{t}{10}\right) \frac{di}{dt} + 0.2i = 4$ . Separating variables we obtain

$$\frac{di}{40 - 2i} = \frac{dt}{10 - t}. \quad \text{Then}$$

$$-\frac{1}{2} \ln |40 - 2i| = -\ln |10 - t| + c \quad \text{or} \quad \sqrt{40 - 2i} = c_1(10 - t).$$

Since  $i(0) = 0$  we must have  $c_1 = 2/\sqrt{10}$ . Solving for  $i$  we get  $i(t) = 4t - \frac{1}{5}t^2$ ,  $0 \leq t < 10$ . For  $t \geq 10$  the equation for the current becomes  $0.2i = 4$  or  $i = 20$ . Thus

$$i(t) = \begin{cases} 4t - \frac{1}{5}t^2, & 0 \leq t < 10 \\ 20, & t \geq 10 \end{cases}.$$

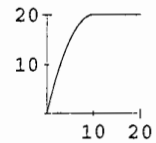

7. From  $y [1 + (y')^2] = k$  we obtain  $dx = \frac{\sqrt{y}}{\sqrt{k-y}} dy$ . If  $y = k \sin^2 \theta$  then

$$dy = 2k \sin \theta \cos \theta d\theta, \quad dx = 2k \left( \frac{1}{2} - \frac{1}{2} \cos 2\theta \right) d\theta, \quad \text{and} \quad x = k\theta - \frac{k}{2} \sin 2\theta + c.$$

If  $x = 0$  when  $\theta = 0$  then  $c = 0$ .

8. (a) From  $y = -x - 1 + c_1 e^x$  we obtain  $y' = y + x$  so that the differential equation of the orthogonal family is  $\frac{dy}{dx} = -\frac{1}{y+x}$  or  $\frac{dx}{dy} + x = -y$ . An integrating factor is  $e^y$ , so

$$\frac{d}{dy} [e^y x] = -ye^y \implies e^y x = -ye^y + e^y + c \implies x = -y + 1 + ce^{-y}.$$

### Chapter 3 Review Exercises

(b) Differentiating the family of curves, we have

$$y' = -\frac{1}{(x + c_1)^2} = -\frac{1}{y^2}.$$

The differential equation for the family of orthogonal trajectories is then  $y' = y^2$ . Separating variables and integrating we get

$$\begin{aligned} \frac{dy}{y^2} &= dx \\ -\frac{1}{y} &= x + c_1 \\ y &= -\frac{1}{x + c_1}. \end{aligned}$$

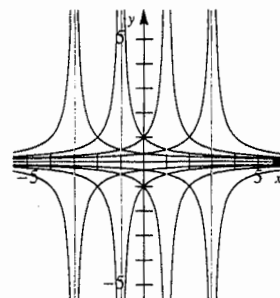

9. From  $\frac{dx}{dt} = k_1x(\alpha - x)$  we obtain  $\left(\frac{1/\alpha}{x} + \frac{1/\alpha}{\alpha - x}\right) dx = k_1 dt$  so that  $x = \frac{\alpha c_1 e^{\alpha k_1 t}}{1 + c_1 e^{\alpha k_1 t}}$ . From  $\frac{dy}{dt} = k_2xy$  we obtain

$$\ln |y| = \frac{k_2}{k_1} \ln |1 + c_1 e^{\alpha k_1 t}| + c \quad \text{or} \quad y = c_2 (1 + c_1 e^{\alpha k_1 t})^{k_2/k_1}.$$

10. In tank A the salt input is

$$\left(7 \frac{\text{gal}}{\text{min}}\right) \left(2 \frac{\text{lb}}{\text{gal}}\right) + \left(1 \frac{\text{gal}}{\text{min}}\right) \left(\frac{x_2}{100} \frac{\text{lb}}{\text{gal}}\right) = \left(14 + \frac{1}{100}x_2\right) \frac{\text{lb}}{\text{min}}.$$

The salt output is

$$\left(3 \frac{\text{gal}}{\text{min}}\right) \left(\frac{x_1}{100} \frac{\text{lb}}{\text{gal}}\right) + \left(5 \frac{\text{gal}}{\text{min}}\right) \left(\frac{x_1}{100} \frac{\text{lb}}{\text{gal}}\right) = \frac{2}{25}x_1 \frac{\text{lb}}{\text{min}}.$$

In tank B the salt input is

$$\left(5 \frac{\text{gal}}{\text{min}}\right) \left(\frac{x_1}{100} \frac{\text{lb}}{\text{gal}}\right) = \frac{1}{20}x_1 \frac{\text{lb}}{\text{min}}.$$

The salt output is

$$\left(1 \frac{\text{gal}}{\text{min}}\right) \left(\frac{x_2}{100} \frac{\text{lb}}{\text{gal}}\right) + \left(4 \frac{\text{gal}}{\text{min}}\right) \left(\frac{x_2}{100} \frac{\text{lb}}{\text{gal}}\right) = \frac{1}{20}x_2 \frac{\text{lb}}{\text{min}}.$$

The system of differential equations is then

$$\begin{aligned} \frac{dx_1}{dt} &= 14 + \frac{1}{100}x_2 - \frac{2}{25}x_1 \\ \frac{dx_2}{dt} &= \frac{1}{20}x_1 - \frac{1}{20}x_2. \end{aligned}$$

## Chapter 3 Related Exercises

1. (a) The differential equation is  $dP/dt = P(5 - P) - 4$ . Solving  $P(5 - P) - 4 = 0$  for  $P$  we obtain equilibrium solutions  $P = 1$  and  $P = 4$ . The phase portrait is shown below and solution curves are shown in part (b).

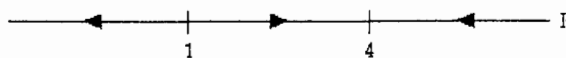

We see that for  $P_0 > 4$  and  $1 < P_0 < 4$  the population approaches 4 as  $t$  increases. For  $0 < P_0 < 1$  the population decreases to 0 in finite time.

- (b) The differential equation is

$$\frac{dP}{dt} = P(5 - P) - 4 = -(P^2 - 5P + 4) = -(P - 4)(P - 1).$$

Separating variables and integrating, we obtain

$$\begin{aligned} \frac{dP}{(P - 4)(P - 1)} &= -dt \\ \left( \frac{1/3}{P - 4} - \frac{1/3}{P - 1} \right) dP &= -dt \\ \frac{1}{3} \ln \left| \frac{P - 4}{P - 1} \right| &= -t + c \\ \frac{P - 4}{P - 1} &= c_1 e^{-3t}. \end{aligned}$$

Setting  $t = 0$  and  $P = P_0$  we find  $c_1 = (P_0 - 4)/(P_0 - 1)$ . Solving for  $P$  we obtain

$$P(t) = \frac{4(P_0 - 1) - (P_0 - 4)e^{-3t}}{(P_0 - 1) - (P_0 - 4)e^{-3t}}.$$

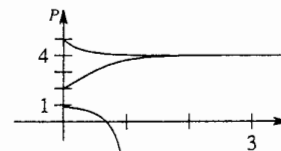

- (c) To find when the population becomes extinct in the case  $0 < P_0 < 1$  we set  $P = 0$  in

$$\frac{P - 4}{P - 1} = \frac{P_0 - 4}{P_0 - 1} e^{-3t}$$

from part (a) and solve for  $t$ . This gives the time of extinction

$$t = -\frac{1}{3} \ln \frac{4(P_0 - 1)}{P_0 - 4}.$$

2. (a) Solving  $P(5 - P) - \frac{25}{4} = 0$  for  $P$  we obtain the equilibrium solution  $P = \frac{5}{2}$ . For  $P \neq \frac{5}{2}$ ,  $dP/dt < 0$ . Thus, if  $P_0 < \frac{5}{2}$ , the population becomes extinct (otherwise there would be another equilibrium solution.) Using separation of variables to solve the initial-value problem we get

### Chapter 3 Related Exercises

$P(t) = [4P_0 + (10P_0 - 25)t]/[4 + (4P_0 - 10)t]$ . To find when the population becomes extinct for  $P_0 < \frac{5}{2}$  we solve  $P(t) = 0$  for  $t$ . We see that the time of extinction is  $t = 4P_0/5(5 - 2P_0)$ .

- (b) Solving  $P(5 - P) - 7 = 0$  for  $P$  we obtain complex roots, so there are no equilibrium solutions. Since  $dP/dt < 0$  for all values of  $P$ , the population becomes extinct for any initial condition. Using separation of variables to solve the initial-value problem we get

$$P(t) = \frac{5}{2} + \frac{\sqrt{3}}{2} \tan \left[ \tan^{-1} \left( \frac{2P_0 - 5}{\sqrt{3}} \right) - \frac{\sqrt{3}}{2} t \right].$$

Solving  $P(t) = 0$  for  $t$  we see that the time of extinction is

$$t = \frac{2}{3} \left( \sqrt{3} \tan^{-1}(5/\sqrt{3}) + \sqrt{3} \tan^{-1}[(2P_0 - 5)/\sqrt{3}] \right).$$

3. (a) Without harvesting, the population is governed by the logistic equation  $dP/dt = P(r - rP/K)$ . With initial population  $P_0$ , the population was shown in Section 3.2 to be

$$\begin{aligned} P(t) &= \frac{rP_0}{rP_0/K + (r - rP_0/K)e^{-rt}} \\ &= \frac{P_0}{P_0/K + (1 - P_0/K)e^{-rt}}. \end{aligned}$$

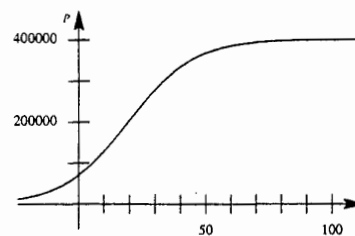

To find when  $P(t) = \frac{1}{2}K$  we solve

$$\frac{P_0}{P_0/K + (1 - P_0/K)e^{-rt}} = \frac{1}{2}K \quad \text{or} \quad \frac{2P_0}{P_0 + (K - P_0)e^{-rt}} = 1.$$

This gives

$$t = -\frac{1}{r} \ln \left( \frac{P_0}{K - P_0} \right) = -\frac{1}{0.08} \ln \left( \frac{70,000}{400,000 - 70,000} \right) \approx 19.4 \text{ yrs.}$$

- (b) Letting  $K = 400,000$ ,  $P_0 = 70,000$ , and  $r = 0.08$ , and solving

$$P_1 = \frac{K - \sqrt{K^2 - 4Kh/r}}{2} = P_0$$

for  $h$ , we get  $h = h_0 = 4620$ .

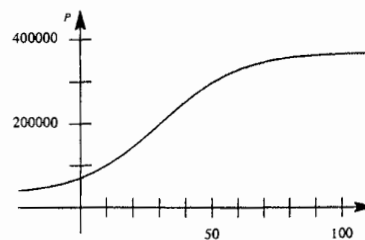

Chapter 3 Related Exercises

- (c) The MSY is obtained when  $E_0 = r/2 = 0.04$ , and the yield in this case is  $EP_1 = KE(1 - E/r) = 8,000$ . The limiting population is  $K(1 - E/r) = 200,000$ .

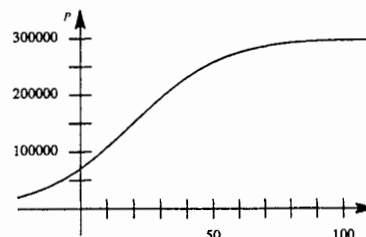

4. (a) Letting 1959 be year 0 and 1973 year 14, we obtain the graph shown.

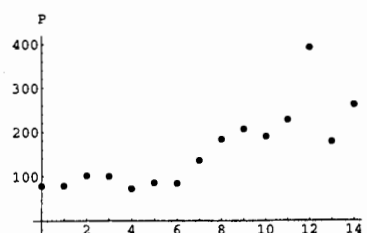

- (b) Taking  $P(0) = 1.91/(c \cdot 414 \cdot 294) \approx 78.4613$  and experimenting with the other parameters, we find that the graph of the logistic function fits the data points reasonably well for  $K = 500$  and  $r = 0.11$ .

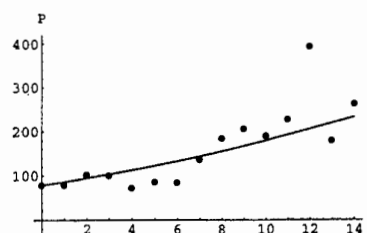

- (c) The graph is shown with  $P_0 = 78.4613$ ,  $K = 500$ ,  $r = 0.11$ , and  $h = \frac{1}{8}rK \approx 6.875$ .

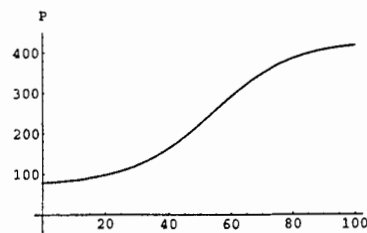

- (d) The graph is shown with  $P_0 = 78.4613$ ,  $K = 500$ ,  $r = 0.11$ , and  $E = \frac{1}{2}r = 0.055$ .

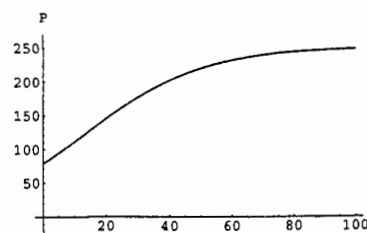

# 4 Higher-Order Differential Equations

## Exercises 4.1

1. From  $y = c_1e^x + c_2e^{-x}$  we find  $y' = c_1e^x - c_2e^{-x}$ . Then  $y(0) = c_1 + c_2 = 0$ ,  $y'(0) = c_1 - c_2 = 1$  so that  $c_1 = 1/2$  and  $c_2 = -1/2$ . The solution is  $y = \frac{1}{2}e^x - \frac{1}{2}e^{-x}$ .
2. From  $y = c_1e^{4x} + c_2e^{-x}$  we find  $y' = 4c_1e^{4x} - c_2e^{-x}$ . Then  $y(0) = c_1 + c_2 = 1$ ,  $y'(0) = 4c_1 - c_2 = 2$  so that  $c_1 = 3/5$  and  $c_2 = 2/5$ . The solution is  $y = \frac{3}{5}e^{4x} + \frac{2}{5}e^{-x}$ .
3. From  $y = c_1x + c_2x \ln x$  we find  $y' = c_1 + c_2(1 + \ln x)$ . Then  $y(1) = c_1 = 3$ ,  $y'(1) = c_1 + c_2 = -1$  so that  $c_1 = 3$  and  $c_2 = -4$ . The solution is  $y = 3x - 4x \ln x$ .
4. From  $y = c_1 + c_2 \cos x + c_3 \sin x$  we find  $y' = -c_2 \sin x + c_3 \cos x$  and  $y'' = -c_2 \cos x - c_3 \sin x$ . Then  $y(\pi) = c_1 - c_2 = 0$ ,  $y'(\pi) = -c_3 = 2$ ,  $y''(\pi) = c_2 = -1$  so that  $c_1 = -1$ ,  $c_2 = -1$ , and  $c_3 = -2$ . The solution is  $y = -1 - \cos x - 2 \sin x$ .
5. From  $y = c_1 + c_2x^2$  we find  $y' = 2c_2x$ . Then  $y(0) = c_1 = 0$ ,  $y'(0) = 2c_2 \cdot 0 = 0$  and  $y''(0) = 1$  is not possible. Since  $a_2(x) = x$  is 0 at  $x = 0$ , Theorem 4.1 is not violated.
6. In this case we have  $y(0) = c_1 = 0$ ,  $y'(0) = 2c_2 \cdot 0 = 0$  so  $c_1 = 0$  and  $c_2$  is arbitrary. Two solutions are  $y = x^2$  and  $y = 2x^2$ .
7. From  $x(0) = x_0 = c_1$  we see that  $x(t) = x_0 \cos \omega t + c_2 \sin \omega t$  and  $x'(t) = -x_0 \sin \omega t + c_2 \omega \cos \omega t$ . Then  $x'(0) = x_1 = c_2 \omega$  implies  $c_2 = x_1/\omega$ . Thus

$$x(t) = x_0 \cos \omega t + \frac{x_1}{\omega} \sin \omega t.$$

8. Solving the system

$$x(t_0) = c_1 \cos \omega t_0 + c_2 \sin \omega t_0 = x$$

$$x'(t_0) = -c_1 \omega \sin \omega t_0 + c_2 \omega \cos \omega t_0 = x_1$$

for  $c_1$  and  $c_2$  gives

$$c_1 = \frac{\omega x_0 \cos \omega t_0 - x_1 \sin \omega t_0}{\omega} \quad \text{and} \quad c_2 = \frac{x_1 \cos \omega t_0 + \omega x_0 \sin \omega t_0}{\omega}.$$

Thus

$$\begin{aligned} x(t) &= \frac{\omega x_0 \cos \omega t_0 - x_1 \sin \omega t_0}{\omega} \cos \omega t + \frac{x_1 \cos \omega t_0 + \omega x_0 \sin \omega t_0}{\omega} \sin \omega t \\ &= x_0(\cos \omega t \cos \omega t_0 + \sin \omega t \sin \omega t_0) + \frac{x_1}{\omega}(\sin \omega t \cos \omega t_0 - \cos \omega t \sin \omega t_0) \\ &= x_0 \cos \omega(t - t_0) + \frac{x_1}{\omega} \sin \omega(t - t_0). \end{aligned}$$



Exercises 4.1

9. Since  $a_2(x) = x - 2$  and  $x_0 = 0$  the problem has a unique solution for  $-\infty < x < 2$ .
10. Since  $a_0(x) = \tan x$  and  $x_0 = 0$  the problem has a unique solution for  $-\pi/2 < x < \pi/2$ .
11. We have  $y(0) = c_1 + c_2 = 0$ ,  $y'(1) = c_1 e + c_2 e^{-1} = 1$  so that  $c_1 = e / (e^2 - 1)$  and  $c_2 = -e / (e^2 - 1)$ . The solution is  $y = e (e^x - e^{-x}) / (e^2 - 1)$ .
12. In this case we have  $y(0) = c_1 = 1$ ,  $y'(1) = 2c_2 = 6$  so that  $c_1 = 1$  and  $c_2 = 3$ . The solution is  $y = 1 + 3x^2$ .
13. From  $y = c_1 e^x \cos x + c_2 e^x \sin x$  we find  $y' = c_1 e^x (-\sin x + \cos x) + c_2 e^x (\cos x + \sin x)$ .
- (a) We have  $y(0) = c_1 = 1$ ,  $y'(0) = c_1 + c_2 = 0$  so that  $c_1 = 1$  and  $c_2 = -1$ . The solution is  $y = e^x \cos x - e^x \sin x$ .
- (b) We have  $y(0) = c_1 = 1$ ,  $y(\pi) = -c_1 e^\pi = -1$ , which is not possible.
- (c) We have  $y(0) = c_1 = 1$ ,  $y(\pi/2) = c_2 e^{\pi/2} = 1$  so that  $c_1 = 1$  and  $c_2 = e^{-\pi/2}$ . The solution is  $y = e^x \cos x + e^{-\pi/2} e^x \sin x$ .
- (d) We have  $y(0) = c_1 = 0$ ,  $y(\pi) = -c_1 e^\pi = 0$  so that  $c_1 = 0$  and  $c_2$  is arbitrary. Solutions are  $y = c_2 e^x \sin x$ , for any real numbers  $c_2$ .
14. (a) We have  $y(-1) = c_1 + c_2 + 3 = 0$ ,  $y(1) = c_1 + c_2 + 3 = 4$ , which is not possible.
- (b) We have  $y(0) = c_1 \cdot 0 + c_2 \cdot 0 + 3 = 1$ , which is not possible.
- (c) We have  $y(0) = c_1 \cdot 0 + c_2 \cdot 0 + 3 = 3$ ,  $y(1) = c_1 + c_2 + 3 = 0$  so that  $c_1$  is arbitrary and  $c_2 = -3 - c_1$ . Solutions are  $y = c_1 x^2 - (c_1 + 3)x^4 + 3$ .
- (d) We have  $y(1) = c_1 + c_2 + 3 = 3$ ,  $y(2) = 4c_1 + 16c_2 + 3 = 15$  so that  $c_1 = -1$  and  $c_2 = 1$ . The solution is  $y = -x^2 + x^4 + 3$ .
15. Since  $(-4)x + (3)x^2 + (1)(4x - 3x^2) = 0$  the functions are linearly dependent.
16. Since  $(1)0 + (0)x + (0)e^x = 0$  the functions are linearly dependent. A similar argument shows that any set of functions containing  $f(x) = 0$  will be linearly dependent.
17. Since  $(-1/5)5 + (1)\cos^2 x + (1)\sin^2 x = 0$  the functions are linearly dependent.
18. Since  $(1)\cos 2x + (1)1 + (-2)\cos^2 x = 0$  the functions are linearly dependent.
19. Since  $(-4)x + (3)(x - 1) + (1)(x + 3) = 0$  the functions are linearly dependent.
20. From the graphs of  $f_1(x) = 2 + x$  and  $f_2(x) = 2 + |x|$  we see that the functions are linearly independent since they cannot be multiples of each other.

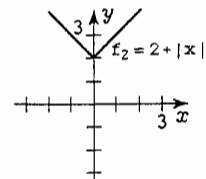
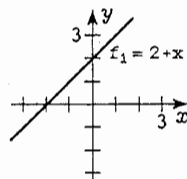

### Exercises 4.1

21. The functions are linearly independent since  $W(1+x, x, x^2) = \begin{vmatrix} 1+x & x & x^2 \\ 1 & 1 & 2x \\ 0 & 0 & 2 \end{vmatrix} = 2 \neq 0$ .

22. Since  $(-1/2)e^x + (1/2)e^{-x} + (1)\sinh x = 0$  the functions are linearly dependent.

23. The functions satisfy the differential equation and are linearly independent since

$$W(e^{-3x}, e^{4x}) = 7e^x \neq 0$$

for  $-\infty < x < \infty$ . The general solution is

$$y = c_1 e^{-3x} + c_2 e^{4x}.$$

24. The functions satisfy the differential equation and are linearly independent since

$$W(\cosh 2x, \sinh 2x) = 2$$

for  $-\infty < x < \infty$ . The general solution is

$$y = c_1 \cosh 2x + c_2 \sinh 2x.$$

25. The functions satisfy the differential equation and are linearly independent since

$$W(e^x \cos 2x, e^x \sin 2x) = 2e^{2x} \neq 0$$

for  $-\infty < x < \infty$ . The general solution is  $y = c_1 e^x \cos 2x + c_2 e^x \sin 2x$ .

26. The functions satisfy the differential equation and are linearly independent since

$$W(e^{x/2}, xe^{x/2}) = e^x \neq 0$$

for  $-\infty < x < \infty$ . The general solution is

$$y = c_1 e^{x/2} + c_2 x e^{x/2}.$$

27. The functions satisfy the differential equation and are linearly independent since

$$W(x^3, x^4) = x^6 \neq 0$$

for  $0 < x < \infty$ . The general solution is

$$y = c_1 x^3 + c_2 x^4.$$

28. The functions satisfy the differential equation and are linearly independent since

$$W(\cos(\ln x), \sin(\ln x)) = 1/x \neq 0$$

for  $0 < x < \infty$ . The general solution is

$$y = c_1 \cos(\ln x) + c_2 \sin(\ln x).$$

29. The functions satisfy the differential equation and are linearly independent since

$$W(x, x^{-2}, x^{-2} \ln x) = 9x^{-6} \neq 0$$

for  $0 < x < \infty$ . The general solution is

$$y = c_1 x + c_2 x^{-2} + c_3 x^{-2} \ln x.$$

30. The functions satisfy the differential equation and are linearly independent since

$$W(1, x, \cos x, \sin x) = 1$$

for  $-\infty < x < \infty$ . The general solution is

$$y = c_1 + c_2 x + c_3 \cos x + c_4 \sin x.$$

31. The functions  $y_1 = e^{2x}$  and  $y_2 = e^{5x}$  form a fundamental set of solutions of the homogeneous equation, and  $y_p = 6e^x$  is a particular solution of the nonhomogeneous equation.

32. The functions  $y_1 = \cos x$  and  $y_2 = \sin x$  form a fundamental set of solutions of the homogeneous equation, and  $y_p = x \sin x + (\cos x) \ln(\cos x)$  is a particular solution of the nonhomogeneous equation.

33. The functions  $y_1 = e^{2x}$  and  $y_2 = xe^{2x}$  form a fundamental set of solutions of the homogeneous equation, and  $y_p = x^2 e^{2x} + x - 2$  is a particular solution of the nonhomogeneous equation.

34. The functions  $y_1 = x^{-1/2}$  and  $y_2 = x^{-1}$  form a fundamental set of solutions of the homogeneous equation, and  $y_p = \frac{1}{15}x^2 - \frac{1}{6}x$  is a particular solution of the nonhomogeneous equation.

35. (a) We have  $y'_{p_1} = 6e^{2x}$  and  $y''_{p_1} = 12e^{2x}$ , so

$$y''_{p_1} - 6y'_{p_1} + 5y_{p_1} = 12e^{2x} - 36e^{2x} + 15e^{2x} = -9e^{2x}.$$

Also,  $y'_{p_2} = 2x + 3$  and  $y''_{p_2} = 2$ , so

$$y''_{p_2} - 6y'_{p_2} + 5y_{p_2} = 2 - 6(2x + 3) + 5(x^2 + 3x) = 5x^2 + 3x - 16.$$

- (b) By the superposition principle for nonhomogeneous equations a particular solution of  $y'' - 6y' + 5y = 5x^2 + 3x - 16 - 9e^{2x}$  is  $y_p = x^2 + 3x + 3e^{2x}$ . A particular solution of the second equation is

$$y_p = -2y_{p_2} - \frac{1}{9}y_{p_1} = -2x^2 - 6x - \frac{1}{3}e^{2x}.$$

36. (a)  $y_{p_1} = 5$

(b)  $y_{p_2} = -2x$

(c)  $y_p = y_{p_1} + y_{p_2} = 5 - 2x$

(d)  $y_p = \frac{1}{2}y_{p_1} - 2y_{p_2} = \frac{5}{2} + 4x$

37. (a) Since  $D^2x = 0$ ,  $x$  and  $1$  are solutions of  $y'' = 0$ . Since they are linearly independent, the general solution is  $y = c_1 x + c_2$ .

### Exercises 4.1

- (b) Since  $D^3x^2 = 0$ ,  $x^2$ ,  $x$ , and  $1$  are solutions of  $y''' = 0$ . Since they are linearly independent, the general solution is  $y = c_1x^2 + c_2x + c_3$ .
- (c) Since  $D^4x^3 = 0$ ,  $x^3$ ,  $x^2$ ,  $x$ , and  $1$  are solutions of  $y^{(4)} = 0$ . Since they are linearly independent, the general solution is  $y = c_1x^3 + c_2x^2 + c_3x + c_4$ .
- (d) By part (a), the general solution of  $y'' = 0$  is  $y_c = c_1x + c_2$ . Since  $D^2x^2 = 2! = 2$ ,  $y_p = x^2$  is a particular solution of  $y'' = 2$ . Thus, the general solution is  $y = c_1x + c_2 + x^2$ .
- (e) By part (b), the general solution of  $y''' = 0$  is  $y_c = c_1x^2 + c_2x + c_3$ . Since  $D^3x^3 = 3! = 6$ ,  $y_p = x^3$  is a particular solution of  $y''' = 6$ . Thus, the general solution is  $y = c_1x^2 + c_2x + c_3 + x^3$ .
- (f) By part (c), the general solution of  $y^{(4)} = 0$  is  $y_c = c_1x^3 + c_2x^2 + c_3x + c_4$ . Since  $D^4x^4 = 4! = 24$ ,  $y_p = x^4$  is a particular solution of  $y^{(4)} = 24$ . Thus, the general solution is  $y = c_1x^3 + c_2x^2 + c_3x + c_4 + x^4$ .

38. By the superposition principle, if  $y_1 = e^x$  and  $y_2 = e^{-x}$  are both solutions of a homogeneous linear differential equation, then so are

$$\frac{1}{2}(y_1 + y_2) = \frac{e^x + e^{-x}}{2} = \cosh x \quad \text{and} \quad \frac{1}{2}(y_1 - y_2) = \frac{e^x - e^{-x}}{2} = \sinh x.$$

39. (a) From the graphs of  $y_1 = x^3$  and  $y_2 = |x|^3$  we see that the functions are linearly independent since they cannot be multiples of each other. It is easily shown that  $y_1 = x^3$  solves  $x^2y'' - 4xy' + 6y = 0$ . To show that  $y_2 = |x|^3$  is a solution let  $y_2 = x^3$  for  $x \geq 0$  and let  $y_2 = -x^3$  for  $x < 0$ .

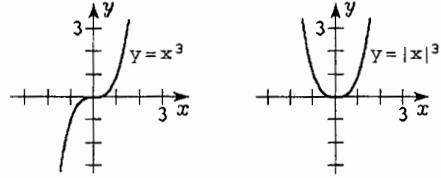

- (b) If  $x \geq 0$  then  $y_2 = x^3$  and  $W(y_1, y_2) = \begin{vmatrix} x^3 & x^3 \\ 3x^2 & 3x^2 \end{vmatrix} = 0$ .  
If  $x < 0$  then  $y_2 = -x^3$  and  $W(y_1, y_2) = \begin{vmatrix} x^3 & -x^3 \\ 3x^2 & -3x^2 \end{vmatrix} = 0$ .

This does not violate Theorem 4.3 since  $a_2(x) = x^2$  is zero at  $x = 0$ .

- (c) The functions  $Y_1 = x^3$  and  $Y_2 = x^2$  are solutions of  $x^2y'' - 4xy' + 6y = 0$ . They are linearly independent since  $W(x^3, x^2) = x^4 \neq 0$  for  $-\infty < x < \infty$ .
- (d) The function  $y = x^3$  satisfies  $y(0) = 0$  and  $y'(0) = 0$ .
- (e) Neither is the general solution since we form a general solution on an interval for which  $a_2(x) \neq 0$  for every  $x$  in the interval.
40. Since  $e^{x-3} = e^{-3}e^x = (e^{-5}e^2)e^x = e^{-5}e^{x+2}$ , we see that  $e^{x-3}$  is a constant multiple of  $e^{x+2}$  and the functions are linearly dependent.

41. Since  $0y_1 + 0y_2 + \cdots + 0y_k + 1y_{k+1} = 0$ , the set of solutions is linearly dependent.
42. The solutions are linearly dependent. Suppose  $n$  of the solutions are linearly independent (if not, then the set of  $n + 1$  solutions is linearly dependent). Without loss of generality, let this set be  $y_1, y_2, \dots, y_n$ . Then  $y = c_1y_1 + c_2y_2 + \cdots + c_ny_n$  is the general solution of the  $n$ th-order differential equation and for some choice,  $c_1^*, c_2^*, \dots, c_n^*$ , of the coefficients  $y_{n+1} = c_1^*y_1 + c_2^*y_2 + \cdots + c_n^*y_n$ . But then the set  $y_1, y_2, \dots, y_n, y_{n+1}$  is linearly dependent.

## Exercises 4.2

In Problems 1-8 we use reduction of order to find a second solution. In Problems 9-16 we use formula (5) from the text.

1. Define  $y = u(x)e^{2x}$  so

$$y' = 2ue^{2x} + u'e^{2x}, \quad y'' = e^{2x}u'' + 4e^{2x}u' + 4e^{2x}u, \quad \text{and} \quad y'' - 4y' + 4y = 4e^{2x}u'' = 0.$$

Therefore  $u'' = 0$  and  $u = c_1x + c_2$ . Taking  $c_1 = 1$  and  $c_2 = 0$  we see that a second solution is  $y_2 = xe^{2x}$ .

2. Define  $y = u(x)xe^{-x}$  so

$$y' = (1-x)e^{-x}u + xe^{-x}u', \quad y'' = xe^{-x}u'' + 2(1-x)e^{-x}u' - (2-x)e^{-x}u,$$

and

$$y'' + 2y' + y = e^{-x}(xu'' + 2u') = 0 \quad \text{or} \quad u'' + \frac{2}{x}u' = 0.$$

If  $w = u'$  we obtain the first-order equation  $w' + \frac{2}{x}w = 0$  which has the integrating factor  $e^{2 \int dx/x} = x^2$ . Now

$$\frac{d}{dx}[x^2w] = 0 \quad \text{gives} \quad x^2w = c.$$

Therefore  $w = u' = c/x^2$  and  $u = c_1/x$ . A second solution is  $y_2 = \frac{1}{x}xe^{-x} = e^{-x}$ .

3. Define  $y = u(x) \cos 4x$  so

$$y' = -4u \sin 4x + u' \cos 4x, \quad y'' = u'' \cos 4x - 8u' \sin 4x - 16u \cos 4x$$

and

$$y'' + 16y = (\cos 4x)u'' - 8(\sin 4x)u' = 0 \quad \text{or} \quad u'' - 8(\tan 4x)u' = 0.$$

If  $w = u'$  we obtain the first-order equation  $w' - 8(\tan 4x)w = 0$  which has the integrating factor  $e^{-8 \int \tan 4x dx} = \cos^2 4x$ . Now

$$\frac{d}{dx}[(\cos^2 4x)w] = 0 \quad \text{gives} \quad (\cos^2 4x)w = c.$$

## Exercises 4.2

Therefore  $w = u' = c \sec^2 4x$  and  $u = c_1 \tan 4x$ . A second solution is  $y_2 = \tan 4x \cos 4x = \sin 4x$ .

4. Define  $y = u(x) \sin 3x$  so

$$y' = 3u \cos 3x + u' \sin 3x, \quad y'' = u'' \sin 3x + 6u' \cos 3x - 9u \sin 3x,$$

and

$$y'' + 9y = (\sin 3x)u'' + 6(\cos 3x)u' = 0 \quad \text{or} \quad u'' + 6(\cot 3x)u' = 0.$$

If  $w = u'$  we obtain the first-order equation  $w' + 6(\cot 3x)w = 0$  which has the integrating factor  $e^{6 \int \cot 3x dx} = \sin^2 3x$ . Now

$$\frac{d}{dx}[(\sin^2 3x)w] = 0 \quad \text{gives} \quad (\sin^2 3x)w = c.$$

Therefore  $w = u' = c \csc^2 3x$  and  $u = c_1 \cot 3x$ . A second solution is  $y_2 = \cot 3x \sin 3x = \cos 3x$ .

5. Define  $y = u(x) \cosh x$  so

$$y' = u \sinh x + u' \cosh x, \quad y'' = u'' \cosh x + 2u' \sinh x + u \cosh x$$

and

$$y'' - y = (\cosh x)u'' + 2(\sinh x)u' = 0 \quad \text{or} \quad u'' + 2(\tanh x)u' = 0.$$

If  $w = u'$  we obtain the first-order equation  $w' + 2(\tanh x)w = 0$  which has the integrating factor  $e^{2 \int \tanh x dx} = \cosh^2 x$ . Now

$$\frac{d}{dx}[(\cosh^2 x)w] = 0 \quad \text{gives} \quad (\cosh^2 x)w = c.$$

Therefore  $w = u' = c \operatorname{sech}^2 x$  and  $u = c_1 \tanh x$ . A second solution is  $y_2 = \tanh x \cosh x = \sinh x$ .

6. Define  $y = u(x)e^{5x}$  so

$$y' = 5e^{5x}u + e^{5x}u', \quad y'' = e^{5x}u'' + 10e^{5x}u' + 25e^{5x}u$$

and

$$y'' - 25y = e^{5x}(u'' + 10u') = 0 \quad \text{or} \quad u'' + 10u' = 0.$$

If  $w = u'$  we obtain the first-order equation  $w' + 10w = 0$  which has the integrating factor  $e^{10 \int dx} = e^{10x}$ . Now

$$\frac{d}{dx}[e^{10x}w] = 0 \quad \text{gives} \quad e^{10x}w = c.$$

Therefore  $w = u' = ce^{-10x}$  and  $u = c_1 e^{-10x}$ . A second solution is  $y_2 = e^{-10x}e^{5x} = e^{-5x}$ .

7. Define  $y = u(x)e^{2x/3}$  so

$$y' = \frac{2}{3}e^{2x/3}u + e^{2x/3}u', \quad y'' = e^{2x/3}u'' + \frac{4}{3}e^{2x/3}u' + \frac{4}{9}e^{2x/3}u$$

and

$$9y'' - 12y' + 4y = 9e^{2x/3}u'' = 0.$$

## Exercises 4.2

Therefore  $u'' = 0$  and  $u = c_1x + c_2$ . Taking  $c_1 = 1$  and  $c_2 = 0$  we see that a second solution is  $y_2 = xe^{2x/3}$ .

8. Define  $y = u(x)e^{x/3}$  so

$$y' = \frac{1}{3}e^{x/3}u + e^{x/3}u', \quad y'' = e^{x/3}u'' + \frac{2}{3}e^{x/3}u' + \frac{1}{9}e^{x/3}u$$

and

$$6y'' + y' - y = e^{x/3}(6u'' + 5u') = 0 \quad \text{or} \quad u'' + \frac{5}{6}u' = 0.$$

If  $w = u'$  we obtain the first-order equation  $w' + \frac{5}{6}w = 0$  which has the integrating factor  $e^{(5/6)\int dx} = e^{5x/6}$ . Now

$$\frac{d}{dx}[e^{5x/6}w] = 0 \quad \text{gives} \quad e^{5x/6}w = c.$$

Therefore  $w = u' = ce^{-5x/6}$  and  $u = c_1e^{-5x/6}$ . A second solution is  $y_2 = e^{-5x/6}e^{x/3} = e^{-x/2}$ .

9. Identifying  $P(x) = -7/x$  we have

$$y_2 = x^4 \int \frac{e^{-\int -(7/x) dx}}{x^8} dx = x^4 \int \frac{1}{x} dx = x^4 \ln|x|.$$

A second solution is  $y_2 = x^4 \ln|x|$ .

10. Identifying  $P(x) = 2/x$  we have

$$y_2 = x^2 \int \frac{e^{-\int (2/x) dx}}{x^4} dx = x^2 \int x^{-6} dx = -\frac{1}{5}x^{-3}.$$

A second solution is  $y_2 = x^{-3}$ .

11. Identifying  $P(x) = 1/x$  we have

$$y_2 = \ln x \int \frac{e^{-\int dx/x}}{(\ln x)^2} dx = \ln x \int \frac{dx}{x(\ln x)^2} = \ln x \left( -\frac{1}{\ln x} \right) = -1.$$

A second solution is  $y_2 = 1$ .

12. Identifying  $P(x) = 0$  we have

$$y_2 = x^{1/2} \ln x \int \frac{e^{-\int 0 dx}}{x(\ln x)^2} dx = x^{1/2} \ln x \left( -\frac{1}{\ln x} \right) = -x^{1/2}.$$

A second solution is  $y_2 = x^{1/2}$ .

13. Identifying  $P(x) = -1/x$  we have

$$\begin{aligned} y_2 &= x \sin(\ln x) \int \frac{e^{-\int -dx/x}}{x^2 \sin^2(\ln x)} dx = x \sin(\ln x) \int \frac{x}{x^2 \sin^2(\ln x)} dx \\ &= [x \sin(\ln x)] [-\cot(\ln x)] = -x \cos(\ln x). \end{aligned}$$

A second solution is  $y_2 = x \cos(\ln x)$ .

## Exercises 4.2

14. Identifying  $P(x) = -3/x$  we have

$$\begin{aligned} y_2 &= x^2 \cos(\ln x) \int \frac{e^{-\int -3 dx/x}}{x^4 \cos^2(\ln x)} dx = x^2 \cos(\ln x) \int \frac{x^3}{x^4 \cos^2(\ln x)} dx \\ &= x^2 \cos(\ln x) \tan(\ln x) = x^2 \sin(\ln x). \end{aligned}$$

A second solution is  $y_2 = x^2 \sin(\ln x)$ .

15. Identifying  $P(x) = 2(1+x)/(1-2x-x^2)$  we have

$$\begin{aligned} y_2 &= (x+1) \int \frac{e^{-\int 2(1+x)dx/(1-2x-x^2)}}{(x+1)^2} dx = (x+1) \int \frac{e^{\ln(1-2x-x^2)}}{(x+1)^2} dx \\ &= (x+1) \int \frac{1-2x-x^2}{(x+1)^2} dx = (x+1) \int \left[ \frac{2}{(x+1)^2} - 1 \right] dx \\ &= (x+1) \left[ -\frac{2}{x+1} - x \right] = -2 - x^2 - x. \end{aligned}$$

A second solution is  $y_2 = x^2 + x + 2$ .

16. Identifying  $P(x) = -2x/(1-x^2)$  we have

$$y_2 = \int e^{-\int -2x dx/(1-x^2)} dx = \int e^{-\ln(1-x^2)} dx = \int \frac{1}{1-x^2} dx = \frac{1}{2} \ln \left| \frac{1+x}{1-x} \right|.$$

A second solution is  $y_2 = \ln |(1+x)/(1-x)|$ .

17. Define  $y = u(x)e^{-2x}$  so

$$y' = -2ue^{-2x} + u'e^{-2x}, \quad y'' = u''e^{-2x} - 4u'e^{-2x} + 4ue^{-2x}$$

and

$$y'' - 4y = e^{-2x}u'' - 4e^{-2x}u' = 0 \quad \text{or} \quad u'' - 4u' = 0.$$

If  $w = u'$  we obtain the first order equation  $w' - 4w = 0$  which has the integrating factor  $e^{-4 \int dx} = e^{-4x}$ . Now

$$\frac{d}{dx}[e^{-4x}w] = 0 \quad \text{gives} \quad e^{-4x}w = c.$$

Therefore  $w = u' = ce^{4x}$  and  $u = c_1e^{4x}$ . A second solution is  $y_2 = e^{-2x}e^{4x} = e^{2x}$ . We see by observation that a particular solution is  $y_p = -1/2$ . The general solution is

$$y = c_1e^{-2x} + c_2e^{2x} - \frac{1}{2}.$$

18. Define  $y = u(x) \cdot 1$  so

$$y' = u', \quad y'' = u'' \quad \text{and} \quad y'' + y' = u'' + u' = 0.$$



## Exercises 4.2

If  $w = u'$  we obtain the first order equation  $w' + w = 0$  which has the integrating factor  $e^{\int dx} = e^x$ . Now

$$\frac{d}{dx}[e^x w] = 0 \quad \text{gives} \quad e^x w = c.$$

Therefore  $w = u' = ce^{-x}$  and  $u = c_1 e^{-x}$ . A second solution is  $y_2 = 1 \cdot e^{-x} = e^{-x}$ . We see by observation that a particular solution is  $y_p = x$ . The general solution is

$$y = c_1 + c_2 e^{-x} + x.$$

19. Define  $y = u(x)e^x$  so

$$y' = ue^x + u'e^x, \quad y'' = u''e^x + 2u'e^x + ue^x$$

and

$$y'' - 3y' + 2y = e^x u'' - e^x u' = 0 \quad \text{or} \quad u'' - u' = 0.$$

If  $w = u'$  we obtain the first order equation  $w' - w = 0$  which has the integrating factor  $e^{-\int dx} = e^{-x}$ . Now

$$\frac{d}{dx}[e^{-x} w] = 0 \quad \text{gives} \quad e^{-x} w = c.$$

Therefore  $w = u' = ce^x$  and  $u = ce^x$ . A second solution is  $y_2 = e^x e^x = e^{2x}$ . To find a particular solution we try  $y_p = Ae^{3x}$ . Then  $y' = 3Ae^{3x}$ ,  $y'' = 9Ae^{3x}$ , and  $9Ae^{3x} - 3(3Ae^{3x}) + 2Ae^{3x} = 5e^{3x}$ . Thus  $A = 5/2$  and  $y_p = \frac{5}{2}e^{3x}$ . The general solution is

$$y = c_1 e^x + c_2 e^{2x} + \frac{5}{2}e^{3x}.$$

20. Define  $y = u(x)e^x$  so

$$y' = ue^x + u'e^x, \quad y'' = u''e^x + 2u'e^x + ue^x$$

and

$$y'' - 4y' + 3y = e^x u'' - 2e^x u' = 0 \quad \text{or} \quad u'' - 2u' = 0.$$

If  $w = u'$  we obtain the first order equation  $w' - 2w = 0$  which has the integrating factor  $e^{-2\int dx} = e^{-2x}$ . Now

$$\frac{d}{dx}[e^{-2x} w] = 0 \quad \text{gives} \quad e^{-2x} w = c.$$

Therefore  $w = u' = ce^{2x}$  and  $u = c_1 e^{2x}$ . A second solution is  $y_2 = e^x e^{2x} = e^{3x}$ . To find a particular solution we try  $y_p = ax + b$ . Then  $y'_p = a$ ,  $y''_p = 0$ , and  $0 - 4a + 3(ax + b) = 3ax - 4a + 3b = x$ . Then  $3a = 1$  and  $-4a + 3b = 0$  so  $a = 1/3$  and  $b = 4/9$ . A particular solution is  $y_p = \frac{1}{3}x + \frac{4}{9}$  and the general solution is

$$y = c_1 e^x + c_2 e^{3x} + \frac{1}{3}x + \frac{4}{9}.$$

## Exercises 4.2

21. (a) For  $m_1$  constant, let  $y_1 = e^{m_1 x}$ . Then  $y_1' = m_1 e^{m_1 x}$  and  $y_1'' = m_1^2 e^{m_1 x}$ . Substituting into the differential equation we obtain

$$\begin{aligned} ay_1'' + by_1' + cy_1 &= am_1^2 e^{m_1 x} + bm_1 e^{m_1 x} + ce^{m_1 x} \\ &= e^{m_1 x}(am_1^2 + bm_1 + c) = 0. \end{aligned}$$

Thus,  $y_1 = e^{m_1 x}$  will be a solution of the differential equation whenever  $am_1^2 + bm_1 + c = 0$ . Since a quadratic equation always has at least one real or complex root, the differential equation must have a solution of the form  $y_1 = e^{m_1 x}$ .

- (b) Write the differential equation in the form

$$y'' + \frac{b}{a}y' + \frac{c}{a}y = 0,$$

and let  $y_1 = e^{m_1 x}$  be a solution. Then a second solution is given by

$$\begin{aligned} y_2 &= e^{m_1 x} \int \frac{e^{-bx/a}}{e^{2m_1 x}} dx \\ &= e^{m_1 x} \int e^{-(b/a+2m_1)x} dx \\ &= -\frac{1}{b/a+2m_1} e^{m_1 x} e^{-(b/a+2m_1)x} \quad (m_1 \neq -b/2a) \\ &= -\frac{1}{b/a+2m_1} e^{-(b/a+m_1)x}. \end{aligned}$$

Thus, when  $m_1 \neq -b/2a$ , a second solution is given by  $y_2 = e^{m_2 x}$  where  $m_2 = -b/a - m_1$ .

When  $m_1 = -b/2a$  a second solution is given by

$$y_2 = e^{m_1 x} \int dx = x e^{m_1 x}.$$

- (c) The functions

$$\begin{aligned} \sin x &= \frac{1}{2i}(e^{ix} - e^{-ix}) & \cos x &= \frac{1}{2}(e^{ix} + e^{-ix}) \\ \sinh x &= \frac{1}{2}(e^x - e^{-x}) & \cosh x &= \frac{1}{2}(e^x + e^{-x}) \end{aligned}$$

are all expressible in terms of exponential functions.

22. We have  $y_1' = 1$  and  $y_1'' = 0$ , so  $xy_1'' - xy_1' + y_1 = 0 - x + x = 0$  and  $y_1(x) = x$  is a solution of the differential equation. Letting  $y = u(x)y_1(x) = xu(x)$  we get

$$y' = xu'(x) + u(x) \quad \text{and} \quad y'' = xu''(x) + 2u'(x).$$

Then  $xy'' - xy' + y = x^2u'' + 2xu' - x^2u' - xu + xu = x^2u'' - (x^2 - 2x)u' = 0$ . If we make the substitution  $w = u'$ , the second-order linear differential equation becomes  $x^2w' - (x^2 - x)w = 0$ ,

which is separable:

$$\frac{dw}{dx} = \left(1 - \frac{1}{x}\right)w$$

$$\frac{dw}{w} = \left(1 - \frac{1}{x}\right)dx$$

$$\ln w = x - \ln x + c$$

$$w = c_1 \frac{e^x}{x}.$$

Then  $u' = c_1 e^x/x$  and  $u = c_1 \int e^x dx/x$ . To integrate  $e^x/x$  we use the series representation for  $e^x$ . Thus, a second solution is

$$\begin{aligned} y_2 = xu(x) &= c_1 x \int \frac{e^x}{x} dx \\ &= c_1 x \int \frac{1}{x} \left(1 + x + \frac{1}{2!}x^2 + \frac{1}{3!}x^3 + \cdots\right) dx \\ &= c_1 x \int \left(\frac{1}{x} + 1 + \frac{1}{2!}x + \frac{1}{3!}x^2 + \cdots\right) dx \\ &= c_1 x \left(\ln x + x + \frac{1}{2(2!)}x^2 + \frac{1}{3(3!)}x^3 + \cdots\right) \\ &= c_1 \left(x \ln x + x^2 + \frac{1}{2(2!)}x^3 + \frac{1}{3(3!)}x^4 + \cdots\right). \end{aligned}$$

An interval of definition is probably  $(0, \infty)$  because of the  $\ln x$  term.

23. (a) We have  $y' = y'' = e^x$ , so

$$xy'' - (x+10)y' + 10y = xe^x - (x+10)e^x + 10e^x = 0,$$

and  $y = e^x$  is a solution of the differential equation.

- (b) By (5) a second solution is

$$\begin{aligned} y_2 &= y_1 \int \frac{e^{-\int P(x) dx}}{y_1^2} dx = e^x \int \frac{e^{\int \frac{x+10}{x} dx}}{e^{2x}} dx = e^x \int \frac{e^{\int (1+10/x) dx}}{e^{2x}} dx \\ &= e^x \int \frac{e^{x+\ln x^{10}}}{e^{2x}} dx = e^x \int x^{10} e^{-x} dx \\ &= e^x (-3,628,800 - 3,628,800x - 1,814,400x^2 - 604,800x^3 - 151,200x^4 \\ &\quad - 30,240x^5 - 5,040x^6 - 720x^7 - 90x^8 - 10x^9 - x^{10})e^{-x} \\ &= -3,628,800 - 3,628,800x - 1,814,400x^2 - 604,800x^3 - 151,200x^4 \\ &\quad - 30,240x^5 - 5,040x^6 - 720x^7 - 90x^8 - 10x^9 - x^{10}. \end{aligned}$$

## Exercises 4.2

(c) By Corollary (A) of Theorem 4.2,  $-\frac{1}{10!}y_2 = \sum_{n=0}^{10} \frac{1}{n!}x^n$  is a solution.

---

## Exercises 4.3

---

1. From  $4m^2 + m = 0$  we obtain  $m = 0$  and  $m = -1/4$  so that  $y = c_1 + c_2e^{-x/4}$ .
2. From  $m^2 - 36 = 0$  we obtain  $m = 6$  and  $m = -6$  so that  $y = c_1e^{6x} + c_2e^{-6x}$ .
3. From  $m^2 - m - 6 = 0$  we obtain  $m = 3$  and  $m = -2$  so that  $y = c_1e^{3x} + c_2e^{-2x}$ .
4. From  $m^2 - 3m + 2 = 0$  we obtain  $m = 1$  and  $m = 2$  so that  $y = c_1e^x + c_2e^{2x}$ .
5. From  $m^2 + 8m + 16 = 0$  we obtain  $m = -4$  and  $m = -4$  so that  $y = c_1e^{-4x} + c_2xe^{-4x}$ .
6. From  $m^2 - 10m + 25 = 0$  we obtain  $m = 5$  and  $m = 5$  so that  $y = c_1e^{5x} + c_2xe^{5x}$ .
7. From  $12m^2 - 5m - 2 = 0$  we obtain  $m = -1/4$  and  $m = 2/3$  so that  $y = c_1e^{-x/4} + c_2e^{2x/3}$ .
8. From  $m^2 + 4m - 1 = 0$  we obtain  $m = -2 \pm \sqrt{5}$  so that  $y = c_1e^{(-2+\sqrt{5})x} + c_2e^{(-2-\sqrt{5})x}$ .
9. From  $m^2 + 9 = 0$  we obtain  $m = 3i$  and  $m = -3i$  so that  $y = c_1 \cos 3x + c_2 \sin 3x$ .
10. From  $3m^2 + 1 = 0$  we obtain  $m = i/\sqrt{3}$  and  $m = -i/\sqrt{3}$  so that  $y = c_1 \cos x/\sqrt{3} + c_2 \sin x/\sqrt{3}$ .
11. From  $m^2 - 4m + 5 = 0$  we obtain  $m = 2 \pm i$  so that  $y = e^{2x}(c_1 \cos x + c_2 \sin x)$ .
12. From  $2m^2 + 2m + 1 = 0$  we obtain  $m = -1/2 \pm i/2$  so that

$$y = e^{-x/2}(c_1 \cos x/2 + c_2 \sin x/2).$$

13. From  $3m^2 + 2m + 1 = 0$  we obtain  $m = -1/3 \pm \sqrt{2}i/3$  so that

$$y = e^{-x/3}(c_1 \cos \sqrt{2}x/3 + c_2 \sin \sqrt{2}x/3).$$

14. From  $2m^2 - 3m + 4 = 0$  we obtain  $m = 3/4 \pm \sqrt{23}i/4$  so that

$$y = e^{3x/4}(c_1 \cos \sqrt{23}x/4 + c_2 \sin \sqrt{23}x/4).$$

15. From  $m^3 - 4m^2 - 5m = 0$  we obtain  $m = 0$ ,  $m = 5$ , and  $m = -1$  so that

$$y = c_1 + c_2e^{5x} + c_3e^{-x}.$$

16. From  $m^3 - 1 = 0$  we obtain  $m = 1$  and  $m = -1/2 \pm \sqrt{3}i/2$  so that

$$y = c_1e^x + e^{-x/2}(c_2 \cos \sqrt{3}x/2 + c_3 \sin \sqrt{3}x/2).$$

17. From  $m^3 - 5m^2 + 3m + 9 = 0$  we obtain  $m = -1$ ,  $m = 3$ , and  $m = 3$  so that

$$y = c_1e^{-x} + c_2e^{3x} + c_3xe^{3x}.$$

### Exercises 4.3

18. From  $m^3 + 3m^2 - 4m - 12 = 0$  we obtain  $m = -2$ ,  $m = 2$ , and  $m = -3$  so that

$$y = c_1 e^{-2x} + c_2 e^{2x} + c_3 e^{-3x}.$$

19. From  $m^3 + m^2 - 2 = 0$  we obtain  $m = 1$  and  $m = -1 \pm i$  so that

$$u = c_1 e^t + e^{-t}(c_2 \cos t + c_3 \sin t).$$

20. From  $m^3 - m^2 - 4 = 0$  we obtain  $m = 2$  and  $m = -1/2 \pm \sqrt{7}i/2$  so that

$$x = c_1 e^{2t} + e^{-t/2} (c_2 \cos \sqrt{7}t/2 + c_3 \sin \sqrt{7}t/2).$$

21. From  $m^3 + 3m^2 + 3m + 1 = 0$  we obtain  $m = -1$ ,  $m = -1$ , and  $m = -1$  so that

$$y = c_1 e^{-x} + c_2 x e^{-x} + c_3 x^2 e^{-x}.$$

22. From  $m^3 - 6m^2 + 12m - 8 = 0$  we obtain  $m = 2$ ,  $m = 2$ , and  $m = 2$  so that

$$y = c_1 e^{2x} + c_2 x e^{2x} + c_3 x^2 e^{2x}.$$

23. From  $m^4 + m^3 + m^2 = 0$  we obtain  $m = 0$ ,  $m = 0$ , and  $m = -1/2 \pm \sqrt{3}i/2$  so that

$$y = c_1 + c_2 x + e^{-x/2} (c_3 \cos \sqrt{3}x/2 + c_4 \sin \sqrt{3}x/2).$$

24. From  $m^4 - 2m^2 + 1 = 0$  we obtain  $m = 1$ ,  $m = 1$ ,  $m = -1$ , and  $m = -1$  so that

$$y = c_1 e^x + c_2 x e^x + c_3 e^{-x} + c_4 x e^{-x}.$$

25. From  $16m^4 + 24m^2 + 9 = 0$  we obtain  $m = \pm\sqrt{3}i/2$  and  $m = \pm\sqrt{3}i/2$  so that

$$y = c_1 \cos \sqrt{3}x/2 + c_2 \sin \sqrt{3}x/2 + c_3 x \cos \sqrt{3}x/2 + c_4 x \sin \sqrt{3}x/2.$$

26. From  $m^4 - 7m^2 - 18 = 0$  we obtain  $m = 3$ ,  $m = -3$ , and  $m = \pm\sqrt{2}i$  so that

$$y = c_1 e^{3x} + c_2 e^{-3x} + c_3 \cos \sqrt{2}x + c_4 \sin \sqrt{2}x.$$

27. From  $m^5 + 5m^4 - 2m^3 - 10m^2 + m + 5 = 0$  we obtain  $m = -1$ ,  $m = -1$ ,  $m = 1$ , and  $m = 1$ , and  $m = -5$  so that

$$u = c_1 e^{-r} + c_2 r e^{-r} + c_3 e^r + c_4 r e^r + c_5 e^{-5r}.$$

28. From  $2m^5 - 7m^4 + 12m^3 + 8m^2 = 0$  we obtain  $m = 0$ ,  $m = 0$ ,  $m = -1/2$ , and  $m = 2 \pm 2i$  so that

$$x = c_1 + c_2 s + c_3 e^{-s/2} + e^{2s}(c_4 \cos 2s + c_5 \sin 2s).$$

29. From  $m^2 + 16 = 0$  we obtain  $m = \pm 4i$  so that  $y = c_1 \cos 4x + c_2 \sin 4x$ . If  $y(0) = 2$  and  $y'(0) = -2$  then  $c_1 = 2$ ,  $c_2 = -1/2$ , and  $y = 2 \cos 4x - \frac{1}{2} \sin 4x$ .

30. From  $m^2 + 1 = 0$  we obtain  $m = \pm i$  so that  $y = c_1 \cos \theta + c_2 \sin \theta$ . If  $y(\pi/3) = 0$  and  $y'(\pi/3) = 2$  then  $\frac{1}{2}c_1 + \frac{\sqrt{3}}{2}c_2 = 0$ ,  $-\frac{\sqrt{3}}{2}c_1 + \frac{1}{2}c_2 = 2$ , so  $c_1 = -\sqrt{3}$ ,  $c_2 = 1$ , and  $y = -\sqrt{3} \cos \theta + \sin \theta$ .

### Exercises 4.3

31. From  $m^2 - 4m - 5 = 0$  we obtain  $m = -1$  and  $m = 5$ , so that  $y = c_1e^{-x} + c_2e^{5x}$ . If  $y(1) = 0$  and  $y'(1) = 2$ , then  $c_1e^{-1} + c_2e^5 = 0$ ,  $-c_1e^{-1} + 5c_2e^5 = 2$ , so  $c_1 = -e/3$ ,  $c_2 = e^{-5}/3$ , and  $y = -\frac{1}{3}e^{1-x} + \frac{1}{3}e^{5x-5}$ .
32. From  $4m^2 - 4m - 3 = 0$  we obtain  $m = -1/2$  and  $m = 3/2$  so that  $y = c_1e^{-x/2} + c_2e^{3x/2}$ . If  $y(0) = 1$  and  $y'(0) = 5$  then  $c_1 + c_2 = 1$ ,  $-\frac{1}{2}c_1 + \frac{3}{2}c_2 = 5$ , so  $c_1 = -7/4$ ,  $c_2 = 11/4$ , and  $y = -\frac{7}{4}e^{-x/2} + \frac{11}{4}e^{3x/2}$ .
33. From  $m^2 + m + 2 = 0$  we obtain  $m = -1/2 \pm \sqrt{7}i/2$  so that  $y = e^{-x/2} (c_1 \cos \sqrt{7}x/2 + c_2 \sin \sqrt{7}x/2)$ . If  $y(0) = 0$  and  $y'(0) = 0$  then  $c_1 = 0$  and  $c_2 = 0$  so that  $y = 0$ .
34. From  $m^2 - 2m + 1 = 0$  we obtain  $m = 1$  and  $m = 1$  so that  $y = c_1e^x + c_2xe^x$ . If  $y(0) = 5$  and  $y'(0) = 10$  then  $c_1 = 5$ ,  $c_1 + c_2 = 10$  so  $c_1 = 5$ ,  $c_2 = 5$ , and  $y = 5e^x + 5xe^x$ .
35. From  $m^3 + 12m^2 + 36m = 0$  we obtain  $m = 0$ ,  $m = -6$ , and  $m = -6$  so that  $y = c_1 + c_2e^{-6x} + c_3xe^{-6x}$ . If  $y(0) = 0$ ,  $y'(0) = 1$ , and  $y''(0) = -7$  then

$$c_1 + c_2 = 0, \quad -6c_2 + c_3 = 1, \quad 36c_2 - 12c_3 = -7,$$

$$\text{so } c_1 = 5/36, \quad c_2 = -5/36, \quad c_3 = 1/6; \text{ and } y = \frac{5}{36} - \frac{5}{36}e^{-6x} + \frac{1}{6}xe^{-6x}.$$

36. From  $m^3 + 2m^2 - 5m - 6 = 0$  we obtain  $m = -1$ ,  $m = 2$ , and  $m = -3$  so that

$$y = c_1e^{-x} + c_2e^{2x} + c_3e^{-3x}.$$

If  $y(0) = 0$ ,  $y'(0) = 0$ , and  $y''(0) = 1$  then

$$c_1 + c_2 + c_3 = 0, \quad -c_1 + 2c_2 - 3c_3 = 0, \quad c_1 + 4c_2 + 9c_3 = 1,$$

so  $c_1 = -1/6$ ,  $c_2 = 1/15$ ,  $c_3 = 1/10$ , and

$$y = -\frac{1}{6}e^{-x} + \frac{1}{15}e^{2x} + \frac{1}{10}e^{-3x}.$$

37. From  $m^2 - 10m + 25 = 0$  we obtain  $m = 5$  and  $m = 5$  so that  $y = c_1e^{5x} + c_2xe^{5x}$ . If  $y(0) = 1$  and  $y(1) = 0$  then  $c_1 = 1$ ,  $c_1e^5 + c_2e^5 = 0$ , so  $c_1 = 1$ ,  $c_2 = -1$ , and  $y = e^{5x} - xe^{5x}$ .
38. From  $m^2 + 4 = 0$  we obtain  $m = \pm 2i$  so that  $y = c_1 \cos 2x + c_2 \sin 2x$ . If  $y(0) = 0$  and  $y(\pi) = 0$  then  $c_1 = 0$  and  $y = c_2 \sin 2x$ .
39. From  $m^2 + 1 = 0$  we obtain  $m = \pm i$  so that  $y = c_1 \cos x + c_2 \sin x$ . If  $y'(0) = 0$  and  $y'(\pi/2) = 2$  then  $c_1 = -2$ ,  $c_2 = 0$ , and  $y = -2 \cos x$ .
40. From  $m^2 - 2m + 2 = 0$  we obtain  $m = 1 \pm i$  so that  $y = e^x(c_1 \cos x + c_2 \sin x)$ . If  $y(0) = 1$  and  $y(\pi) = 1$  then  $c_1 = 1$  and  $y(\pi) = e^\pi \cos \pi = -e^\pi$ . Since  $-e^\pi \neq 1$ , the boundary-value problem has no solution.
41. The auxiliary equation is  $m^2 - 3 = 0$  which has roots  $-\sqrt{3}$  and  $\sqrt{3}$ . By (10) the general solution is  $y = c_1e^{\sqrt{3}x} + c_2e^{-\sqrt{3}x}$ . By (11) the general solution is  $y = c_1 \cosh \sqrt{3}x + c_2 \sinh \sqrt{3}x$ . For  $y = c_1e^{\sqrt{3}x} + c_2e^{-\sqrt{3}x}$  the initial conditions imply  $c_1 + c_2 = 1$ ,  $\sqrt{3}c_1 - \sqrt{3}c_2 = 5$ . Solving for  $c_1 + c_2$

### Exercises 4.3

we find  $c_1 = \frac{1}{6}(3 + 5\sqrt{3})$  and  $c_2 = \frac{1}{6}(3 - 5\sqrt{3})$  so  $y = \frac{1}{6}(3 + 5\sqrt{3})e^{\sqrt{3}x} + \frac{1}{6}(3 - 5\sqrt{3})e^{-\sqrt{3}x}$ . For  $y = c_1 \cosh \sqrt{3}x + c_2 \sinh \sqrt{3}x$  the initial conditions imply  $c_1 = 1$ ,  $\sqrt{3}c_2 = 5$ . Solving for  $c_1$  and  $c_2$  we find  $c_1 = 1$  and  $c_2 = \frac{5}{3}\sqrt{3}$  so  $y = \cosh \sqrt{3}x + \frac{5}{3}\sqrt{3} \sinh \sqrt{3}x$ .

42. The auxiliary equation is  $m^2 - 1 = 0$  which has roots  $-1$  and  $1$ . By (10) the general solution is  $y = c_1 e^x + c_2 e^{-x}$ . By (11) the general solution is  $y = c_1 \cosh x + c_2 \sinh x$ . For  $y = c_1 e^x + c_2 e^{-x}$  the boundary conditions imply  $c_1 + c_2 = 1$ ,  $c_1 e - c_2 e^{-1} = 0$ . Solving for  $c_1$  and  $c_2$  we find  $c_1 = 1/(1 + e^2)$  and  $c_2 = e^2/(1 + e^2)$  so  $y = e^x/(1 + e^2) + e^2 e^{-x}/(1 + e^2)$ . For  $y = c_1 \cosh x + c_2 \sinh x$  the boundary conditions imply  $c_1 = 1$ ,  $c_2 = -\tanh 1$ , so  $y = \cosh x - (\tanh 1) \sinh x$ .
43. The auxiliary equation should have two positive roots, so that the solution has the form  $y = c_1 e^{k_1 x} + c_2 e^{k_2 x}$ . Thus, the differential equation is (f).
44. The auxiliary equation should have one positive and one negative root, so that the solution has the form  $y = c_1 e^{k_1 x} + c_2 e^{-k_2 x}$ . Thus, the differential equation is (a).
45. The auxiliary equation should have a pair of complex roots  $a \pm bi$  where  $a < 0$ , so that the solution has the form  $e^{ax}(c_1 \cos bx + c_2 \sin bx)$ . Thus, the differential equation is (e).
46. The auxiliary equation should have a repeated negative root, so that the solution has the form  $y = c_1 e^{-x} + c_2 x e^{-x}$ . Thus, the differential equation is (c).
47. The differential equation should have the form  $y'' + k^2 y = 0$  where  $k = 1$  so that the period of the solution is  $2\pi$ . Thus, the differential equation is (d).
48. The differential equation should have the form  $y'' + k^2 y = 0$  where  $k = 2$  so that the period of the solution is  $\pi$ . Thus, the differential equation is (b).
49. (a) The auxiliary equation is  $m^2 - 64/L = 0$  which has roots  $\pm 8/\sqrt{L}$ . Thus, the general solution of the differential equation is  $x = c_1 \cosh(8t/\sqrt{L}) + c_2 \sinh(8t/\sqrt{L})$ .
- (b) Setting  $x(0) = x_0$  and  $x'(0) = 0$  we have  $c_1 = x_0$ ,  $8c_2/\sqrt{L} = 0$ . Solving for  $c_1$  and  $c_2$  we get  $c_1 = x_0$  and  $c_2 = 0$ , so  $x(t) = x_0 \cosh(8t/\sqrt{L})$ .
- (c) When  $L = 20$  and  $x_0 = 1$ ,  $x(t) = \cosh(4t\sqrt{5})$ . The chain will last touch the peg when  $x(t) = 10$ . Solving  $x(t) = 10$  for  $t$  we get  $t_1 = \frac{1}{4}\sqrt{5} \cosh^{-1} 10 \approx 1.67326$ . The velocity of the chain at this instant is  $x'(t_1) = 12\sqrt{11/5} \approx 17.7989$  ft/s.
50. Both  $-C[1]$  and  $c_1$  represent arbitrary constants, and each may take on any real value.
51. Since  $(m-4)(m+5)^2 = m^3 + 6m^2 - 15m - 100$  the differential equation is  $y''' + 6y'' - 15y' - 100y = 0$ . The differential equation is not unique since any constant multiple of the left-hand side of the differential equation would lead to the auxiliary roots.
52. A third root must be  $m_3 = 3 - i$  and the auxiliary equation is

$$\left(m + \frac{1}{2}\right)[m - (3 + i)][m - (3 - i)] = \left(m + \frac{1}{2}\right)(m^2 - 6m + 10) = m^3 - \frac{11}{2}m^2 + 7m + 5.$$

### Exercises 4.3

The differential equation is

$$y''' - \frac{11}{2}y'' + 7y' + 5y = 0.$$

53. From the solution  $y_1 = e^{-4x} \cos x$  we conclude that  $m_1 = -4 + i$  and  $m_2 = -4 - i$  are roots of the auxiliary equation. Hence another solution must be  $y_2 = e^{-4x} \sin x$ . Now dividing the polynomial  $m^3 + 6m^2 + m - 34$  by  $[m - (-4 + i)][m - (-4 - i)] = m^2 + 8m + 17$  gives  $m - 2$ . Therefore  $m_3 = 2$  is the third root of the auxiliary equation, and the general solution of the differential equation is

$$y = c_1 e^{-4x} \cos x + c_2 e^{-4x} \sin x + c_3 e^{2x}.$$

54. Since  $1/x \rightarrow 0$  as  $x \rightarrow \infty$ , we would expect the solutions of  $y'' + (1/x)y' + y = 0$  to behave similar to the solutions of  $y'' + y = 0$ ; that is, like  $\sin x$  and  $\cos x$  for large values of  $x$ . Solutions of  $xy'' + y' + xy = 0$  are obtained using an ODE solver and are shown below with the indicated initial conditions.

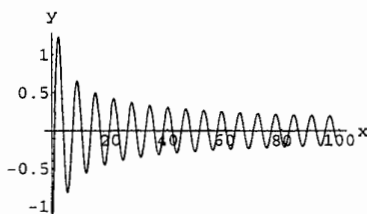

$$y(1) = 0, \quad y'(1) = 2$$

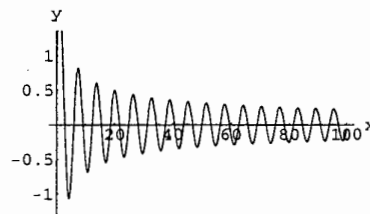

$$y(1) = 2, \quad y'(1) = 0$$

55. Factoring the difference of two squares we obtain

$$m^4 + 1 = (m^2 + 1)^2 - 2m^2 = (m^2 + 1 - \sqrt{2}m)(m^2 + 1 + \sqrt{2}m) = 0.$$

Using the quadratic formula on each factor we get  $m = \pm\sqrt{2}/2 \pm \sqrt{2}i/2$ . The solution of the differential equation is

$$y(x) = e^{\sqrt{2}x/2} \left( c_1 \cos \frac{\sqrt{2}}{2} x + c_2 \sin \frac{\sqrt{2}}{2} x \right) + e^{-\sqrt{2}x/2} \left( c_3 \cos \frac{\sqrt{2}}{2} x + c_4 \sin \frac{\sqrt{2}}{2} x \right).$$

56. (a) The auxiliary equation  $m^2 + bm + c = 0$  has solutions  $m = (-b \pm \sqrt{b^2 - 4c})/2$ . If  $b \leq 0$ , then the solution will contain a term of the form  $e^{\beta x}$  for  $\beta > 0$ , and the solution cannot approach 0 as  $x \rightarrow \infty$ . Thus, for the solution to approach 0 we must have  $b > 0$ . Now, if  $c < 0$  then  $\sqrt{b^2 - 4c} > b$  and  $-b + \sqrt{b^2 - 4c} > 0$ . Thus  $y(x)$  cannot approach 0. Finally, if  $c > 0$  then  $\sqrt{b^2 - 4c} < b$  and  $-b \pm \sqrt{b^2 - 4c} < 0$ . In this case the solution has terms of the form  $e^{\beta x}$  where  $\beta < 0$ . Therefore  $y(x) \rightarrow 0$  as  $x \rightarrow \infty$  if and only if  $b > 0$  and  $c > 0$ .
- (b) If  $b^2 - 4c > 0$ , then  $y = c_1 e^{m_1 x} + c_2 e^{m_2 x}$  and the only solution satisfying  $y(0) = 0, y(1) = 0$  is  $y = 0$ .



### Exercises 4.3

If  $b^2 - 4c = 0$ , then  $y = c_1 e^{mx} + c_2 t e^{mx}$ . Again, the only solution satisfying  $y(0) = 0$ ,  $y(1) = 0$  is  $y = 0$ .

If  $b^2 - 4c < 0$  then

$$y = c_1 e^{-bx/2} \cos \sqrt{4c - b^2} x + c_2 e^{-bx/2} \sin \sqrt{4c - b^2} x.$$

Now  $y(0) = 0$  implies  $c_1 = 0$  and

$$y = c_2 e^{-bx/2} \sin \sqrt{4c - b^2} x.$$

If we are to have a nontrivial solution, the condition  $y(1) = 0$  implies  $\sqrt{4c - b^2} = n\pi$  or  $4c - b^2 = n^2\pi^2$  for  $n$  a positive integer.

57. The auxiliary equation is  $m^2 + \lambda = 0$  and we consider three cases.

**Case I** When  $\lambda = 0$  the general solution of the differential equation is  $y = c_1 + c_2 x$ . The boundary conditions imply  $0 = y(0) = c_1$  and  $0 = y(\pi/2) = c_2\pi/2$ , so that  $c_1 = c_2 = 0$  and the problem possesses only the trivial solution.

**Case II** When  $\lambda < 0$  the general solution of the differential equation is  $y = c_1 e^{\sqrt{-\lambda}x} + c_2 e^{-\sqrt{-\lambda}x}$ , or alternatively,  $y = c_1 \cosh \sqrt{-\lambda}x + c_2 \sinh \sqrt{-\lambda}x$ . Again,  $y(0) = 0$  implies  $c_1 = 0$  so  $y = c_2 \sinh \sqrt{-\lambda}x$ . The second boundary condition implies  $0 = y(\pi/2) = c_2 \sinh \sqrt{-\lambda}\pi/2$  or  $c_2 = 0$ . In this case also, the problem possesses only the trivial solution.

**Case III** When  $\lambda > 0$  the general solution of the differential equation is  $y = c_1 \cos \sqrt{\lambda}x + c_2 \sin \sqrt{\lambda}x$ . In this case also,  $y(0) = 0$  yields  $c_1 = 0$ , so that  $y = c_2 \sin \sqrt{\lambda}x$ . The second boundary condition implies  $0 = c_2 \sin \sqrt{\lambda}\pi/2$ . When  $\sqrt{\lambda}\pi/2$  is an integer multiple of  $\pi$ , that is, when  $\sqrt{\lambda} = 2k$  for  $k$  a nonzero integer, the problem will have nontrivial solutions. Thus, for  $\lambda = 4k^2$  the boundary-value problem will have nontrivial solutions  $y = c_2 \sin 2kx$ , where  $k$  is a nonzero integer. On the other hand, when  $\sqrt{\lambda}$  is not an even integer, the boundary-value problem will have only the trivial solution.

58. Applying integration by parts twice we have

$$\begin{aligned} \int e^{ax} f(x) dx &= \frac{1}{a} e^{ax} f(x) - \frac{1}{a} \int e^{ax} f'(x) dx \\ &= \frac{1}{a} e^{ax} f(x) - \frac{1}{a} \left[ \frac{1}{a} e^{ax} f'(x) - \frac{1}{a} \int e^{ax} f''(x) dx \right] \\ &= \frac{1}{a} e^{ax} f(x) - \frac{1}{a^2} e^{ax} f'(x) + \frac{1}{a^2} \int e^{ax} f''(x) dx. \end{aligned}$$

Collecting the integrals we get

$$\int e^{ax} \left( f(x) - \frac{1}{a^2} f''(x) \right) dx = \frac{1}{a} e^{ax} f(x) - \frac{1}{a^2} e^{ax} f'(x).$$

### Exercises 4.3

In order for the technique to work we need to have

$$\int e^{ax} \left( f(x) - \frac{1}{a^2} f''(x) \right) dx = k \int e^{ax} f(x) dx$$

or

$$f(x) - \frac{1}{a^2} f''(x) = kf(x),$$

where  $k \neq 0$ . This is the second-order differential equation

$$f''(x) + a^2(k-1)f(x) = 0.$$

If  $k < 1$ ,  $k \neq 0$ , the solution of the differential equation is a pair of exponential functions, in which case the original integrand is an exponential function and does not require integration by parts for its evaluation. Similarly, if  $k = 1$ ,  $f''(x) = 0$  and  $f(x)$  has the form  $f(x) = ax + b$ . In this case a single application of integration by parts will suffice. Finally, if  $k > 1$ , the solution of the differential equation is

$$f(x) = c_1 \cos a\sqrt{k-1}x + c_2 \sin a\sqrt{k-1}x,$$

and we see that the technique will work for linear combinations of  $\cos \alpha x$  and  $\sin \alpha x$ .

59. Using a CAS to solve the auxiliary equation  $m^3 - 6m^2 + 2m + 1 = 0$  we find  $m_1 = -0.270534$ ,  $m_2 = 0.658675$ , and  $m_3 = 5.61186$ . The general solution is

$$y = c_1 e^{-0.270534x} + c_2 e^{0.658675x} + c_3 e^{5.61186x}.$$

60. Using a CAS to solve the auxiliary equation  $6.11m^3 + 8.59m^2 + 7.93m + 0.778 = 0$  we find  $m_1 = -0.110241$ ,  $m_2 = -0.647826 + 0.857532i$ , and  $m_3 = -0.647826 - 0.857532i$ . The general solution is

$$y = c_1 e^{-0.110241x} + e^{-0.647826x} (c_2 \cos 0.857532x + c_3 \sin 0.857532x).$$

61. Using a CAS to solve the auxiliary equation  $3.15m^4 - 5.34m^2 + 6.33m - 2.03 = 0$  we find  $m_1 = -1.74806$ ,  $m_2 = 0.501219$ ,  $m_3 = 0.62342 + 0.588965i$ , and  $m_4 = 0.62342 - 0.588965i$ . The general solution is

$$y = c_1 e^{-1.74806x} + c_2 e^{0.501219x} + e^{0.62342x} (c_3 \cos 0.588965x + c_4 \sin 0.588965x).$$

62. Using a CAS to solve the auxiliary equation  $m^4 + 2m^2 - m + 2 = 0$  we find  $m_1 = 1/2 + \sqrt{3}i/2$ ,  $m_2 = 1/2 - \sqrt{3}i/2$ ,  $m_3 = -1/2 + \sqrt{7}i/2$ , and  $m_4 = -1/2 - \sqrt{7}i/2$ . The general solution is

$$y = e^{x/2} \left( c_1 \cos \frac{\sqrt{3}}{2}x + c_2 \sin \frac{\sqrt{3}}{2}x \right) + e^{-x/2} \left( c_3 \cos \frac{\sqrt{7}}{2}x + c_4 \sin \frac{\sqrt{7}}{2}x \right).$$

## Exercises 4.4

63. From  $2m^4 + 3m^3 - 16m^2 + 15m - 4 = 0$  we obtain  $m = -4$ ,  $m = \frac{1}{2}$ ,  $m = 1$ , and  $m = 1$ , so that  $y = c_1e^{-4x} + c_2e^{x/2} + c_3e^x + c_4xe^x$ . If  $y(0) = -2$ ,  $y'(0) = 6$ ,  $y''(0) = 3$ , and  $y'''(0) = \frac{1}{2}$ , then

$$\begin{aligned}c_1 + c_2 + c_3 &= -2 \\ -4c_1 + \frac{1}{2}c_2 + c_3 + c_4 &= 6 \\ 16c_1 + \frac{1}{4}c_2 + c_3 + 2c_4 &= 3 \\ -64c_1 + \frac{1}{8}c_2 + c_3 + 3c_4 &= \frac{1}{2},\end{aligned}$$

so  $c_1 = -\frac{4}{75}$ ,  $c_2 = -\frac{116}{3}$ ,  $c_3 = \frac{918}{25}$ ,  $c_4 = -\frac{58}{5}$ , and

$$y = -\frac{4}{75}e^{-4x} - \frac{116}{3}e^{x/2} + \frac{918}{25}e^x - \frac{58}{5}xe^x.$$

64. From  $m^4 - 3m^3 + 3m^2 - m = 0$  we obtain  $m = 0$ ,  $m = 1$ ,  $m = 1$ , and  $m = 1$  so that  $y = c_1 + c_2e^x + c_3xe^x + c_4x^2e^x$ . If  $y(0) = 0$ ,  $y'(0) = 0$ ,  $y''(0) = 1$ , and  $y'''(0) = 1$  then

$$c_1 + c_2 = 0, \quad c_2 + c_3 = 0, \quad c_2 + 2c_3 + 2c_4 = 1, \quad c_2 + 3c_3 + 6c_4 = 1,$$

so  $c_1 = 2$ ,  $c_2 = -2$ ,  $c_3 = 2$ ,  $c_4 = -1/2$ , and

$$y = 2 - 2e^x + 2xe^x - \frac{1}{2}x^2e^x.$$

---

## Exercises 4.4

---

1. From  $m^2 + 3m + 2 = 0$  we find  $m_1 = -1$  and  $m_2 = -2$ . Then  $y_c = c_1e^{-x} + c_2e^{-2x}$  and we assume  $y_p = A$ . Substituting into the differential equation we obtain  $2A = 6$ . Then  $A = 3$ ,  $y_p = 3$  and

$$y = c_1e^{-x} + c_2e^{-2x} + 3.$$

2. From  $4m^2 + 9 = 0$  we find  $m_1 = -\frac{3}{2}i$  and  $m_2 = \frac{3}{2}i$ . Then  $y_c = c_1 \cos \frac{3}{2}x + c_2 \sin \frac{3}{2}x$  and we assume  $y_p = A$ . Substituting into the differential equation we obtain  $9A = 15$ . Then  $A = \frac{5}{3}$ ,  $y_p = \frac{5}{3}$  and

$$y = c_1 \cos \frac{3}{2}x + c_2 \sin \frac{3}{2}x + \frac{5}{3}.$$

3. From  $m^2 - 10m + 25 = 0$  we find  $m_1 = m_2 = 5$ . Then  $y_c = c_1e^{5x} + c_2xe^{5x}$  and we assume  $y_p = Ax + B$ . Substituting into the differential equation we obtain  $25A = 30$  and  $-10A + 25B = 3$ . Then  $A = \frac{6}{5}$ ,  $B = \frac{6}{5}$ ,  $y_p = \frac{6}{5}x + \frac{6}{5}$ , and

$$y = c_1e^{5x} + c_2xe^{5x} + \frac{6}{5}x + \frac{6}{5}.$$

### Exercises 4.4

4. From  $m^2 + m - 6 = 0$  we find  $m_1 = -3$  and  $m_2 = 2$ . Then  $y_c = c_1e^{-3x} + c_2e^{2x}$  and we assume  $y_p = Ax + B$ . Substituting into the differential equation we obtain  $-6A = 2$  and  $A - 6B = 0$ . Then  $A = -\frac{1}{3}$ ,  $B = -\frac{1}{18}$ ,  $y_p = -\frac{1}{3}x - \frac{1}{18}$ , and

$$y = c_1e^{-3x} + c_2e^{2x} - \frac{1}{3}x - \frac{1}{18}.$$

5. From  $\frac{1}{4}m^2 + m + 1 = 0$  we find  $m_1 = m_2 = 0$ . Then  $y_c = c_1e^{-2x} + c_2xe^{-2x}$  and we assume  $y_p = Ax^2 + Bx + C$ . Substituting into the differential equation we obtain  $A = 1$ ,  $2A + B = -2$ , and  $\frac{1}{2}A + B + C = 0$ . Then  $A = 1$ ,  $B = -4$ ,  $C = \frac{7}{2}$ ,  $y_p = x^2 - 4x + \frac{7}{2}$ , and

$$y = c_1e^{-2x} + c_2xe^{-2x} + x^2 - 4x + \frac{7}{2}.$$

6. From  $m^2 - 8m + 20 = 0$  we find  $m_1 = 2 + 4i$  and  $m_2 = 2 - 4i$ . Then  $y_c = e^{2x}(c_1 \cos 4x + c_2 \sin 4x)$  and we assume  $y_p = Ax^2 + Bx + C + (Dx + E)e^x$ . Substituting into the differential equation we obtain

$$2A - 8B + 20C = 0$$

$$-6D + 13E = 0$$

$$-16A + 20B = 0$$

$$13D = -26$$

$$20A = 100.$$

Then  $A = 5$ ,  $B = 4$ ,  $C = \frac{11}{10}$ ,  $D = -2$ ,  $E = -\frac{12}{13}$ ,  $y_p = 5x^2 + 4x + \frac{11}{10} + (-2x - \frac{12}{13})e^x$  and

$$y = e^{2x}(c_1 \cos 4x + c_2 \sin 4x) + 5x^2 + 4x + \frac{11}{10} + (-2x - \frac{12}{13})e^x.$$

7. From  $m^2 + 3 = 0$  we find  $m_1 = \sqrt{3}i$  and  $m_2 = -\sqrt{3}i$ . Then  $y_c = c_1 \cos \sqrt{3}x + c_2 \sin \sqrt{3}x$  and we assume  $y_p = (Ax^2 + Bx + C)e^{3x}$ . Substituting into the differential equation we obtain  $2A + 6B + 12C = 0$ ,  $12A + 12B = 0$ , and  $12A = -48$ . Then  $A = -4$ ,  $B = 4$ ,  $C = -\frac{4}{3}$ ,  $y_p = (-4x^2 + 4x - \frac{4}{3})e^{3x}$  and

$$y = c_1 \cos \sqrt{3}x + c_2 \sin \sqrt{3}x + (-4x^2 + 4x - \frac{4}{3})e^{3x}.$$

8. From  $4m^2 - 4m - 3 = 0$  we find  $m_1 = \frac{3}{2}$  and  $m_2 = -\frac{1}{2}$ . Then  $y_c = c_1e^{3x/2} + c_2e^{-x/2}$  and we assume  $y_p = A \cos 2x + B \sin 2x$ . Substituting into the differential equation we obtain  $-19 - 8B = 1$  and  $8A - 19B = 0$ . Then  $A = -\frac{19}{425}$ ,  $B = -\frac{8}{425}$ ,  $y_p = -\frac{19}{425} \cos 2x - \frac{8}{425} \sin 2x$ , and

$$y = c_1e^{3x/2} + c_2e^{-x/2} - \frac{19}{425} \cos 2x - \frac{8}{425} \sin 2x.$$

## Exercises 4.4

9. From  $m^2 - m = 0$  we find  $m_1 = 1$  and  $m_2 = 0$ . Then  $y_c = c_1e^x + c_2$  and we assume  $y_p = Ax$ . Substituting into the differential equation we obtain  $-A = -3$ . Then  $A = 3$ ,  $y_p = 3x$  and  $y = c_1e^x + c_2 + 3x$ .

10. From  $m^2 + 2m = 0$  we find  $m_1 = -2$  and  $m_2 = 0$ . Then  $y_c = c_1e^{-2x} + c_2$  and we assume  $y_p = Ax^2 + Bx + Cxe^{-2x}$ . Substituting into the differential equation we obtain  $2A + 2B = 5$ ,  $4A = 2$ , and  $-2C = -1$ . Then  $A = \frac{1}{2}$ ,  $B = 2$ ,  $C = \frac{1}{2}$ ,  $y_p = \frac{1}{2}x^2 + 2x + \frac{1}{2}xe^{-2x}$ , and

$$y = c_1e^{-2x} + c_2 + \frac{1}{2}x^2 + 2x + \frac{1}{2}xe^{-2x}.$$

11. From  $m^2 - m + \frac{1}{4} = 0$  we find  $m_1 = m_2 = \frac{1}{2}$ . Then  $y_c = c_1e^{x/2} + c_2xe^{x/2}$  and we assume  $y_p = A + Bx^2e^{x/2}$ . Substituting into the differential equation we obtain  $\frac{1}{4}A = 3$  and  $2B = 1$ . Then  $A = 12$ ,  $B = \frac{1}{2}$ ,  $y_p = 12 + \frac{1}{2}x^2e^{x/2}$ , and

$$y = c_1e^{x/2} + c_2xe^{x/2} + 12 + \frac{1}{2}x^2e^{x/2}.$$

12. From  $m^2 - 16 = 0$  we find  $m_1 = 4$  and  $m_2 = -4$ . Then  $y_c = c_1e^{4x} + c_2e^{-4x}$  and we assume  $y_p = Axe^{4x}$ . Substituting into the differential equation we obtain  $8A = 2$ . Then  $A = \frac{1}{4}$ ,  $y_p = \frac{1}{4}xe^{4x}$  and

$$y = c_1e^{4x} + c_2e^{-4x} + \frac{1}{4}xe^{4x}.$$

13. From  $m^2 + 4 = 0$  we find  $m_1 = 2i$  and  $m_2 = -2i$ . Then  $y_c = c_1 \cos 2x + c_2 \sin 2x$  and we assume  $y_p = Ax \cos 2x + Bx \sin 2x$ . Substituting into the differential equation we obtain  $4B = 0$  and  $-4A = 3$ . Then  $A = -\frac{3}{4}$ ,  $B = 0$ ,  $y_p = -\frac{3}{4}x \cos 2x$ , and

$$y = c_1 \cos 2x + c_2 \sin 2x - \frac{3}{4}x \cos 2x.$$

14. From  $m^2 + 4 = 0$  we find  $m_1 = 2i$  and  $m_2 = -2i$ . Then  $y_c = c_1 \cos 2x + c_2 \sin 2x$  and we assume  $y_p = (Ax^3 + Bx^2 + Cx) \cos 2x + (Dx^3 + Ex^2 + Fx) \sin 2x$ . Substituting into the differential equation we obtain

$$2B + 4F = 0$$

$$6A + 8E = 0$$

$$12D = 0$$

$$-4C + 2E = -3$$

$$-8B + 6D = 0$$

$$-12A = 1.$$

### Exercises 4.4

Then  $A = -\frac{1}{12}$ ,  $B = 0$ ,  $C = \frac{25}{32}$ ,  $D = 0$ ,  $E = \frac{1}{16}$ ,  $F = 0$ ,  $y_p = \left(-\frac{1}{12}x^3 + \frac{25}{32}x\right) \cos 2x + \frac{1}{16}x^2 \sin 2x$ , and

$$y = c_1 \cos 2x + c_2 \sin 2x + \left(-\frac{1}{12}x^3 + \frac{25}{32}x\right) \cos 2x + \frac{1}{16}x^2 \sin 2x.$$

15. From  $m^2 + 1 = 0$  we find  $m_1 = i$  and  $m_2 = -i$ . Then  $y_c = c_1 \cos x + c_2 \sin x$  and we assume  $y_p = (Ax^2 + Bx) \cos x + (Cx^2 + Dx) \sin x$ . Substituting into the differential equation we obtain  $4C = 0$ ,  $2A + 2D = 0$ ,  $-4A = 2$ , and  $-2B + 2C = 0$ . Then  $A = -\frac{1}{2}$ ,  $B = 0$ ,  $C = 0$ ,  $D = \frac{1}{2}$ ,  $y_p = -\frac{1}{2}x^2 \cos x + \frac{1}{2}x \sin x$ , and

$$y = c_1 \cos x + c_2 \sin x - \frac{1}{2}x^2 \cos x + \frac{1}{2}x \sin x.$$

16. From  $m^2 - 5m = 0$  we find  $m_1 = 5$  and  $m_2 = 0$ . Then  $y_c = c_1 e^{5x} + c_2$  and we assume  $y_p = Ax^4 + Bx^3 + Cx^2 + Dx$ . Substituting into the differential equation we obtain  $-20A = 2$ ,  $12A - 15B = -4$ ,  $6B - 10C = -1$ , and  $2C - 5D = 6$ . Then  $A = -\frac{1}{10}$ ,  $B = \frac{14}{75}$ ,  $C = \frac{53}{250}$ ,  $D = -\frac{697}{625}$ ,  $y_p = -\frac{1}{10}x^4 + \frac{14}{75}x^3 + \frac{53}{250}x^2 - \frac{697}{625}x$ , and

$$y = c_1 e^{5x} + c_2 - \frac{1}{10}x^4 + \frac{14}{75}x^3 + \frac{53}{250}x^2 - \frac{697}{625}x.$$

17. From  $m^2 - 2m + 5 = 0$  we find  $m_1 = 1 + 2i$  and  $m_2 = 1 - 2i$ . Then  $y_c = e^x(c_1 \cos 2x + c_2 \sin 2x)$  and we assume  $y_p = Axe^x \cos 2x + Bxe^x \sin 2x$ . Substituting into the differential equation we obtain  $4B = 1$  and  $-4A = 0$ . Then  $A = 0$ ,  $B = \frac{1}{4}$ ,  $y_p = \frac{1}{4}xe^x \sin 2x$ , and

$$y = e^x(c_1 \cos 2x + c_2 \sin 2x) + \frac{1}{4}xe^x \sin 2x.$$

18. From  $m^2 - 2m + 2 = 0$  we find  $m_1 = 1 + i$  and  $m_2 = 1 - i$ . Then  $y_c = e^x(c_1 \cos x + c_2 \sin x)$  and we assume  $y_p = Ae^{2x} \cos x + Be^{2x} \sin x$ . Substituting into the differential equation we obtain  $A + 2B = 1$  and  $-2A + B = -3$ . Then  $A = \frac{7}{5}$ ,  $B = -\frac{1}{5}$ ,  $y_p = \frac{7}{5}e^{2x} \cos x - \frac{1}{5}e^{2x} \sin x$  and

$$y = e^x(c_1 \cos x + c_2 \sin x) + \frac{7}{5}e^{2x} \cos x - \frac{1}{5}e^{2x} \sin x.$$

19. From  $m^2 + 2m + 1 = 0$  we find  $m_1 = m_2 = -1$ . Then  $y_c = c_1 e^{-x} + c_2 x e^{-x}$  and we assume  $y_p = A \cos x + B \sin x + C \cos 2x + D \sin 2x$ . Substituting into the differential equation we obtain  $2B = 0$ ,  $-2A = 1$ ,  $-3C + 4D = 3$ , and  $-4C - 3D = 0$ . Then  $A = -\frac{1}{2}$ ,  $B = 0$ ,  $C = -\frac{9}{25}$ ,  $D = \frac{12}{25}$ ,  $y_p = -\frac{1}{2} \cos x - \frac{9}{25} \cos 2x + \frac{12}{25} \sin 2x$ , and

$$y = c_1 e^{-x} + c_2 x e^{-x} - \frac{1}{2} \cos x - \frac{9}{25} \cos 2x + \frac{12}{25} \sin 2x.$$

20. From  $m^2 + 2m - 24 = 0$  we find  $m_1 = -6$  and  $m_2 = 4$ . Then  $y_c = c_1 e^{-6x} + c_2 e^{4x}$  and we assume  $y_p = A + (Bx^2 + Cx)e^{4x}$ . Substituting into the differential equation we obtain  $-24A = 16$ ,

$2B+10C = -2$ , and  $20B = -1$ . Then  $A = -\frac{2}{3}$ ,  $B = -\frac{1}{20}$ ,  $C = -\frac{19}{100}$ ,  $y_p = -\frac{2}{3} - \left(\frac{1}{20}x^2 + \frac{19}{100}x\right)e^{4x}$ , and

$$y = c_1e^{-6x} + c_2e^{4x} - \frac{2}{3} - \left(\frac{1}{20}x^2 + \frac{19}{100}x\right)e^{4x}.$$

21. From  $m^3 - 6m^2 = 0$  we find  $m_1 = m_2 = 0$  and  $m_3 = 6$ . Then  $y_c = c_1 + c_2x + c_3e^{6x}$  and we assume  $y_p = Ax^2 + B \cos x + C \sin x$ . Substituting into the differential equation we obtain  $-12A = 3$ ,  $6B - C = -1$ , and  $B + 6C = 0$ . Then  $A = -\frac{1}{4}$ ,  $B = -\frac{6}{37}$ ,  $C = \frac{1}{37}$ ,  $y_p = -\frac{1}{4}x^2 - \frac{6}{37} \cos x + \frac{1}{37} \sin x$ , and

$$y = c_1 + c_2x + c_3e^{6x} - \frac{1}{4}x^2 - \frac{6}{37} \cos x + \frac{1}{37} \sin x.$$

22. From  $m^3 - 2m^2 - 4m + 8 = 0$  we find  $m_1 = m_2 = 2$  and  $m_3 = -2$ . Then  $y_c = c_1e^{2x} + c_2xe^{2x} + c_3e^{-2x}$  and we assume  $y_p = (Ax^3 + Bx^2)e^{2x}$ . Substituting into the differential equation we obtain  $24A = 6$  and  $6A + 8B = 0$ . Then  $A = \frac{1}{4}$ ,  $B = -\frac{3}{16}$ ,  $y_p = \left(\frac{1}{4}x^3 - \frac{3}{16}x^2\right)e^{2x}$ , and

$$y = c_1e^{2x} + c_2xe^{2x} + c_3e^{-2x} + \left(\frac{1}{4}x^3 - \frac{3}{16}x^2\right)e^{2x}.$$

23. From  $m^3 - 3m^2 + 3m - 1 = 0$  we find  $m_1 = m_2 = m_3 = 1$ . Then  $y_c = c_1e^x + c_2xe^x + c_3x^2e^x$  and we assume  $y_p = Ax + B + Cx^3e^x$ . Substituting into the differential equation we obtain  $-A = 1$ ,  $3A - B = 0$ , and  $6C = -4$ . Then  $A = -1$ ,  $B = -3$ ,  $C = -\frac{2}{3}$ ,  $y_p = -x - 3 - \frac{2}{3}x^3e^x$ , and

$$y = c_1e^x + c_2xe^x + c_3x^2e^x - x - 3 - \frac{2}{3}x^3e^x.$$

24. From  $m^3 - m^2 - 4m + 4 = 0$  we find  $m_1 = 1$ ,  $m_2 = 2$ , and  $m_3 = -2$ . Then  $y_c = c_1e^x + c_2e^{2x} + c_3e^{-2x}$  and we assume  $y_p = A + Bxe^x + Cxe^{2x}$ . Substituting into the differential equation we obtain  $4A = 5$ ,  $-3B = -1$ , and  $4C = 1$ . Then  $A = \frac{5}{4}$ ,  $B = \frac{1}{3}$ ,  $C = \frac{1}{4}$ ,  $y_p = \frac{5}{4} + \frac{1}{3}xe^x + \frac{1}{4}xe^{2x}$ , and

$$y = c_1e^x + c_2e^{2x} + c_3e^{-2x} + \frac{5}{4} + \frac{1}{3}xe^x + \frac{1}{4}xe^{2x}.$$

25. From  $m^4 + 2m^2 + 1 = 0$  we find  $m_1 = m_3 = i$  and  $m_2 = m_4 = -i$ . Then  $y_c = c_1 \cos x + c_2 \sin x + c_3x \cos x + c_4x \sin x$  and we assume  $y_p = Ax^2 + Bx + C$ . Substituting into the differential equation we obtain  $A = 1$ ,  $B = -2$ , and  $4A + C = 1$ . Then  $A = 1$ ,  $B = -2$ ,  $C = -3$ ,  $y_p = x^2 - 2x - 3$ , and

$$y = c_1 \cos x + c_2 \sin x + c_3x \cos x + c_4x \sin x + x^2 - 2x - 3.$$

26. From  $m^4 - m^2 = 0$  we find  $m_1 = m_2 = 0$ ,  $m_3 = 1$ , and  $m_4 = -1$ . Then  $y_c = c_1 + c_2x + c_3e^x + c_4e^{-x}$  and we assume  $y_p = Ax^3 + Bx^2 + (Cx^2 + Dx)e^{-x}$ . Substituting into the differential equation we obtain  $-6A = 4$ ,  $-2B = 0$ ,  $10C - 2D = 0$ , and  $-4C = 2$ . Then  $A = -\frac{2}{3}$ ,  $B = 0$ ,  $C = -\frac{1}{2}$ ,  $D = -\frac{5}{2}$ ,  $y_p = -\frac{2}{3}x^3 - \left(\frac{1}{2}x^2 + \frac{5}{2}x\right)e^{-x}$ , and

$$y = c_1 + c_2x + c_3e^x + c_4e^{-x} - \frac{2}{3}x^3 - \left(\frac{1}{2}x^2 + \frac{5}{2}x\right)e^{-x}.$$

### Exercises 4.4

27. We have  $y_c = c_1 \cos 2x + c_2 \sin 2x$  and we assume  $y_p = A$ . Substituting into the differential equation we find  $A = -\frac{1}{2}$ . Thus  $y = c_1 \cos 2x + c_2 \sin 2x - \frac{1}{2}$ . From the initial conditions we obtain  $c_1 = 0$  and  $c_2 = \sqrt{2}$ , so  $y = \sqrt{2} \sin 2x - \frac{1}{2}$ .

28. We have  $y_c = c_1 e^{-2x} + c_2 e^{x/2}$  and we assume  $y_p = Ax^2 + Bx + C$ . Substituting into the differential equation we find  $A = -7$ ,  $B = -19$ , and  $C = -37$ . Thus  $y = c_1 e^{-2x} + c_2 e^{x/2} - 7x^2 - 19x - 37$ . From the initial conditions we obtain  $c_1 = -\frac{1}{5}$  and  $c_2 = \frac{186}{5}$ , so

$$y = -\frac{1}{5}e^{-2x} + \frac{186}{5}e^{x/2} - 7x^2 - 19x - 37.$$

29. We have  $y_c = c_1 e^{-x/5} + c_2$  and we assume  $y_p = Ax^2 + Bx$ . Substituting into the differential equation we find  $A = -3$  and  $B = 30$ . Thus  $y = c_1 e^{-x/5} + c_2 - 3x^2 + 30x$ . From the initial conditions we obtain  $c_1 = 200$  and  $c_2 = -200$ , so

$$y = 200e^{-x/5} - 200 - 3x^2 + 30x.$$

30. We have  $y_c = c_1 e^{-2x} + c_2 x e^{-2x}$  and we assume  $y_p = (Ax^3 + Bx^2)e^{-2x}$ . Substituting into the differential equation we find  $A = \frac{1}{6}$  and  $B = \frac{3}{2}$ . Thus  $y = c_1 e^{-2x} + c_2 x e^{-2x} + \left(\frac{1}{6}x^3 + \frac{3}{2}x^2\right)e^{-2x}$ . From the initial conditions we obtain  $c_1 = 2$  and  $c_2 = 9$ , so

$$y = 2e^{-2x} + 9xe^{-2x} + \left(\frac{1}{6}x^3 + \frac{3}{2}x^2\right)e^{-2x}.$$

31. We have  $y_c = e^{-2x}(c_1 \cos x + c_2 \sin x)$  and we assume  $y_p = Ae^{-4x}$ . Substituting into the differential equation we find  $A = 5$ . Thus  $y = e^{-2x}(c_1 \cos x + c_2 \sin x) + 7e^{-4x}$ . From the initial conditions we obtain  $c_1 = -10$  and  $c_2 = 9$ , so

$$y = e^{-2x}(-10 \cos x + 9 \sin x + 7e^{-4x}).$$

32. We have  $y_c = c_1 \cosh x + c_2 \sinh x$  and we assume  $y_p = Ax \cosh x + Bx \sinh x$ . Substituting into the differential equation we find  $A = 0$  and  $B = \frac{1}{2}$ . Thus

$$y = c_1 \cosh x + c_2 \sinh x + \frac{1}{2}x \sinh x.$$

From the initial conditions we obtain  $c_1 = 2$  and  $c_2 = 12$ , so

$$y = 2 \cosh x + 12 \sinh x + \frac{1}{2}x \sinh x.$$

33. We have  $x_c = c_1 \cos \omega t + c_2 \sin \omega t$  and we assume  $x_p = At \cos \omega t + Bt \sin \omega t$ . Substituting into the differential equation we find  $A = -F_0/2\omega$  and  $B = 0$ . Thus  $x = c_1 \cos \omega t + c_2 \sin \omega t - (F_0/2\omega)t \cos \omega t$ . From the initial conditions we obtain  $c_1 = 0$  and  $c_2 = F_0/2\omega^2$ , so

$$x = (F_0/2\omega^2) \sin \omega t - (F_0/2\omega)t \cos \omega t.$$



## Exercises 4.4

34. We have  $x_c = c_1 \cos \omega t + c_2 \sin \omega t$  and we assume  $x_p = A \cos \gamma t + B \sin \gamma t$ , where  $\gamma \neq \omega$ . Substituting into the differential equation we find  $A = F_0/(\omega^2 - \gamma^2)$  and  $B = 0$ . Thus

$$x = c_1 \cos \omega t + c_2 \sin \omega t + \frac{F_0}{(\omega^2 - \gamma^2)} \cos \gamma t.$$

From the initial conditions we obtain  $c_1 = F_0/(\omega^2 - \gamma^2)$  and  $c_2 = 0$ , so

$$x = \frac{F_0}{(\omega^2 - \gamma^2)} \cos \omega t + \frac{F_0}{(\omega^2 - \gamma^2)} \cos \gamma t.$$

35. We have  $y_c = c_1 + c_2 e^x + c_3 x e^x$  and we assume  $y_p = Ax + Bx^2 e^x + Ce^{5x}$ . Substituting into the differential equation we find  $A = 2$ ,  $B = -12$ , and  $C = \frac{1}{2}$ . Thus

$$y = c_1 + c_2 e^x + c_3 x e^x + 2x - 12x^2 e^x + \frac{1}{2} e^{5x}.$$

From the initial conditions we obtain  $c_1 = 11$ ,  $c_2 = -11$ , and  $c_3 = 9$ , so

$$y = 11 - 11e^x + 9xe^x + 2x - 12x^2 e^x + \frac{1}{2} e^{5x}.$$

36. We have  $y_c = c_1 e^{-2x} + e^x(c_2 \cos \sqrt{3}x + c_3 \sin \sqrt{3}x)$  and we assume  $y_p = Ax + B + Cxe^{-2x}$ . Substituting into the differential equation we find  $A = \frac{1}{4}$ ,  $B = -\frac{5}{8}$ , and  $C = \frac{2}{3}$ . Thus

$$y = c_1 e^{-2x} + e^x(c_2 \cos \sqrt{3}x + c_3 \sin \sqrt{3}x) + \frac{1}{4}x - \frac{5}{8} + \frac{2}{3}xe^{-2x}.$$

From the initial conditions we obtain  $c_1 = -\frac{23}{12}$ ,  $c_2 = -\frac{59}{24}$ , and  $c_3 = \frac{17}{72}\sqrt{3}$ , so

$$y = -\frac{23}{12}e^{-2x} + e^x \left( -\frac{59}{24} \cos \sqrt{3}x + \frac{17}{72} \sqrt{3} \sin \sqrt{3}x \right) + \frac{1}{4}x - \frac{5}{8} + \frac{2}{3}xe^{-2x}.$$

37. We have  $y_c = c_1 \cos x + c_2 \sin x$  and we assume  $y_p = A^2 + Bx + C$ . Substituting into the differential equation we find  $A = 1$ ,  $B = 0$ , and  $C = -1$ . Thus  $y = c_1 \cos x + c_2 \sin x + x^2 - 1$ . From  $y(0) = 5$  and  $y(1) = 0$  we obtain

$$c_1 - 1 = 5$$

$$(\cos 1)c_1 + \sin(1)c_2 = 0.$$

Solving this system we find  $c_1 = 6$  and  $c_2 = -6 \cot 1$ . The solution of the boundary-value problem is

$$y = 6 \cos x - 6(\cot 1) \sin x + x^2 - 1.$$

38. We have  $y_c = e^x(c_1 \cos x + c_2 \sin x)$  and we assume  $y_p = Ax + B$ . Substituting into the differential equation we find  $A = 1$  and  $B = 0$ . Thus  $y = e^x(c_1 \cos x + c_2 \sin x) + x$ . From  $y(0) = 0$  and  $y(\pi) = \pi$  we obtain

$$c_1 = 0$$

$$\pi - e^\pi c_1 = \pi.$$

### Exercises 4.4

Solving this system we find  $c_1 = 0$  and  $c_2$  is any real number. The solution of the boundary-value problem is

$$y = c_2 e^x \sin x + x.$$

39. We have  $y_c = c_1 \cos 2x + c_2 \sin 2x$  and we assume  $y_p = A \cos x + B \sin x$  on  $[0, \pi/2]$ . Substituting into the differential equation we find  $A = 0$  and  $B = \frac{1}{3}$ . Thus  $y = c_1 \cos 2x + c_2 \sin 2x + \frac{1}{3} \sin x$  on  $[0, \pi/2]$ . On  $(\pi/2, \infty)$  we have  $y = c_3 \cos 2x + c_4 \sin 2x$ . From  $y(0) = 1$  and  $y'(0) = 2$  we obtain

$$c_1 = 1$$

$$\frac{1}{3} + 2c_2 = 2.$$

Solving this system we find  $c_1 = 1$  and  $c_2 = \frac{5}{6}$ . Thus  $y = \cos 2x + \frac{5}{6} \sin 2x + \frac{1}{3} \sin x$  on  $[0, \pi/2]$ . Now continuity of  $y$  at  $x = \pi/2$  implies

$$\cos \pi + \frac{5}{6} \sin \pi + \frac{1}{3} \sin \frac{\pi}{2} = c_3 \cos \pi + c_4 \sin \pi$$

or  $-1 + \frac{1}{3} = -c_3$ . Hence  $c_3 = \frac{2}{3}$ . Continuity of  $y'$  at  $x = \pi/2$  implies

$$-2 \sin \pi + \frac{5}{3} \cos \pi + \frac{1}{3} \cos \frac{\pi}{2} = -2c_3 \sin \pi + 2c_4 \cos \pi$$

or  $-\frac{5}{3} = -2c_4$ . Then  $c_4 = \frac{5}{6}$  and the solution of the initial-value problem is

$$y(x) = \begin{cases} \cos 2x + \frac{5}{6} \sin 2x + \frac{1}{3} \sin x, & 0 \leq x \leq \pi/2 \\ \frac{2}{3} \cos 2x + \frac{5}{6} \sin 2x, & x > \pi/2. \end{cases}$$

40. We have  $y_c = e^x(c_1 \cos 3x + c_2 \sin 3x)$  and we assume  $y_p = A$  on  $[0, \pi]$ . Substituting into the differential equation we find  $A = 2$ . Thus,  $y = e^x(c_1 \cos 3x + c_2 \sin 3x) + 2$  on  $[0, \pi]$ . On  $(\pi, \infty)$  we have  $y = e^x(c_3 \cos 3x + c_4 \sin 3x)$ . From  $y(0) = 0$  and  $y'(0) = 0$  we obtain

$$c_1 = -2, \quad c_1 + 3c_2 = 0.$$

Solving this system, we find  $c_1 = -2$  and  $c_2 = \frac{2}{3}$ . Thus  $y = e^x(-2 \cos 3x + \frac{2}{3} \sin 3x) + 2$  on  $[0, \pi]$ . Now, continuity of  $y$  at  $x = \pi$  implies

$$e^\pi(-2 \cos 3\pi + \frac{2}{3} \sin 3\pi) + 2 = e^\pi(c_3 \cos 3\pi + c_4 \sin 3\pi)$$

or  $2 + 2e^\pi = -c_3 e^\pi$  or  $c_3 = -2e^{-\pi}(1 + e^\pi)$ . Continuity of  $y'$  at  $\pi$  implies

$$\frac{20}{3} e^\pi \sin 3\pi = e^\pi[(c_3 + 3c_4) \cos 3\pi + (-3c_3 + c_4) \sin 3\pi]$$

or  $-c_3 e^\pi - 3c_4 e^\pi = 0$ . Since  $c_3 = -2e^{-\pi}(1 + e^\pi)$  we have  $c_4 = \frac{2}{3} e^{-\pi}(1 + e^\pi)$ . The solution of the initial-value problem is

$$y(x) = \begin{cases} e^x(-2 \cos 3x + \frac{2}{3} \sin 3x) + 2, & 0 \leq x \leq \pi \\ (1 + e^\pi) e^{x-\pi}(-2 \cos 3x + \frac{2}{3} \sin 3x), & x > \pi. \end{cases}$$

## Exercises 4.4

41. (a) From  $y_p = Ae^{kx}$  we find  $y'_p = Ake^{kx}$  and  $y''_p = Ak^2e^{kx}$ . Substituting into the differential equation we get

$$aAk^2e^{kx} + bAke^{kx} + cAe^{kx} = (ak^2 + bk + c)Ae^{kx} = e^{kx},$$

so  $(ak^2 + bk + c)A = 1$ . Since  $k$  is not a root of  $am^2 + bm + c = 0$ ,  $A = 1/(ak^2 + bk + c)$ .

- (b) From  $y_p = Axe^{kx}$  we find  $y'_p = Akxe^{kx} + Ae^{kx}$  and  $y''_p = Ak^2xe^{kx} + 2Ake^{kx}$ . Substituting into the differential equation we get

$$\begin{aligned} aAk^2xe^{kx} + 2aAke^{kx} + bAkxe^{kx} + bAe^{kx} + cAxe^{kx} \\ &= (ak^2 + bk + c)Axe^{kx} + (2ak + b)Ae^{kx} \\ &= (0)Axe^{kx} + (2ak + b)Ae^{kx} = (2ak + b)Ae^{kx} = e^{kx} \end{aligned}$$

where  $ak^2 + bk + c = 0$  because  $k$  is a root of the auxiliary equation. Now, the roots of the auxiliary equation are  $-b/2a \pm \sqrt{b^2 - 4ac}$ , and since  $k$  is a root of multiplicity one,  $k \neq -b/2a$  and  $2ak + b \neq 0$ . Thus  $(2ak + b)A = 1$  and  $A = 1/(2ak + b)$ .

- (c) If  $k$  is a root of multiplicity two, then, as we saw in part (b),  $k = -b/2a$  and  $2ak + b = 0$ . From  $y_p = Ax^2e^{kx}$  we find  $y'_p = Akx^2e^{kx} + 2Axe^{kx}$  and  $y''_p = Ak^2x^2e^{kx} + 4Akxe^{kx} = 2Ae^{kx}$ . Substituting into the differential equation, we get

$$\begin{aligned} aAk^2x^2e^{kx} + 4aAke^{kx} + 2aAe^{kx} + bAkx^2e^{kx} + 2bAxe^{kx} + cAx^2e^{kx} \\ &= (ak^2 + bk + c)Ax^2e^{kx} + 2(2ak + b)Axe^{kx} + 2aAe^{kx} \\ &= (0)Ax^2e^{kx} + 2(0)Axe^{kx} + 2aAe^{kx} = 2aAe^{kx} = e^{kx}. \end{aligned}$$

Since the differential equation is second-order,  $a \neq 0$  and  $A = 1/(2a)$ .

42. Using the double-angle formula for the cosine, we have

$$\sin x \cos 2x = \sin x(\cos^2 x - \sin^2 x) = \sin x(1 - 2\sin^2 x) = \sin x - 2\sin^3 x.$$

Since  $\sin x$  is a solution of the related homogeneous differential equation we look for a particular solution of the form  $y_p = Ax \sin x + Bx \cos x + C \sin^3 x$ . Substituting into the differential equation we obtain

$$2a \cos x + (6c - 2b) \sin x - 8c \sin^3 x = \sin x - 2\sin^3 x.$$

Equating coefficients we find  $a = 0$ ,  $c = \frac{1}{4}$ , and  $b = \frac{1}{4}$ . Thus, a particular solution is

$$y_p = \frac{1}{4}x \cos x + \frac{1}{4}\sin^3 x.$$

43. (a)  $f(t) = e^t \sin t$ . We see that  $y_p \rightarrow \infty$  as  $t \rightarrow \infty$  and  $y_p \rightarrow 0$  as  $t \rightarrow -\infty$ .  
 (b)  $f(t) = e^{-t}$ . We see that  $y_p \rightarrow \infty$  as  $t \rightarrow \infty$  and  $y_p \rightarrow \infty$  as  $t \rightarrow -\infty$ .

### Exercises 4.4

(c)  $f(t) = \sin 2t$ . We see that  $y_p$  is sinusoidal.

(d)  $f(t) = 1$ . We see that  $y_p$  is constant and simply translates  $y_c$  vertically.

44. The complementary function is  $y_c = e^{2x}(c_1 \cos 2x + c_2 \sin 2x)$ . We assume a particular solution of the form  $y_p = (Ax^3 + Bx^2 + Cx)e^{2x} \cos 2x + (Dx^3 + Ex^2 + F)e^{2x} \sin 2x$ . Substituting into the differential equation and using a CAS to simplify yields

$$\begin{aligned} & [12Dx^2 + (6A + 8E)x + (2B + 4F)]e^{2x} \cos 2x \\ & + [-12Ax^2 + (-8B + 6D)x + (-4C + 2E)]e^{2x} \sin 2x \\ & = (2x^2 - 3x)e^{2x} \cos 2x + (10x^2 - x - 1)e^{2x} \sin 2x. \end{aligned}$$

This gives the system of equations

$$\begin{aligned} 12D &= 2, & 6A + 8E &= -3, & 2B + 4F &= 0, \\ -12A &= 10, & -8B + 6D &= -1, & -4C + 2E &= -1, \end{aligned}$$

from which we find  $A = -\frac{5}{6}$ ,  $B = \frac{1}{4}$ ,  $C = \frac{3}{8}$ ,  $D = \frac{1}{6}$ ,  $E = \frac{1}{4}$ , and  $F = -\frac{1}{8}$ . Thus, a particular solution of the differential equation is

$$y_p = \left(-\frac{5}{6}x^3 + \frac{1}{4}x^2 + \frac{3}{8}x\right)e^{2x} \cos 2x + \left(\frac{1}{6}x^3 + \frac{1}{4}x^2 - \frac{1}{8}x\right)e^{2x} \sin 2x.$$

45. The complementary function is  $y_c = c_1 \cos x + c_2 \sin x + c_3 x \cos x + c_4 x \sin x$ . We assume a particular solution of the form  $y_p = Ax^2 \cos x + Bx^3 \sin x$ . Substituting into the differential equation and using a CAS to simplify yields

$$(-8a + 24b) \cos x + 3bx \sin x = 2 \cos x - 3x \sin x.$$

This implies  $-8a + 24b = 2$  and  $-24b = -3$ . Thus  $b = \frac{1}{8}$ ,  $a = \frac{1}{8}$ , and  $y_p = \frac{1}{8}x^2 \cos x + \frac{1}{8}x^3 \sin x$ .

---

### Exercises 4.5

---

- $(9D^2 - 4)y = (3D - 2)(3D + 2)y = \sin x$
- $(D^2 - 5)y = (D - \sqrt{5})(D + \sqrt{5})y = x^2 - 2x$
- $(D^2 - 4D - 12)y = (D - 6)(D + 2)y = x - 6$
- $(2D^2 - 3D - 2)y = (2D + 1)(D - 2)y = 1$
- $(D^3 + 10D^2 + 25D)y = D(D + 5)^2y = e^x$
- $(D^3 + 4D)y = D(D^2 + 4)y = e^x \cos 2x$
- $(D^3 + 2D^2 - 13D + 10)y = (D - 1)(D - 2)(D + 5)y = xe^{-x}$
- $(D^3 + 4D^2 + 3D)y = D(D + 1)(D + 3)y = x^2 \cos x - 3x$

## Exercises 4.5

9.  $(D^4 + 8D)y = D(D + 2)(D^2 - 2D + 4)y = 4$
10.  $(D^4 - 8D^2 + 16)y = (D - 2)^2(D + 2)^2y = (x^3 - 2x)e^{4x}$
11.  $D^4y = D^4(10x^3 - 2x) = D^3(30x^2 - 2) = D^2(60x) = D(60) = 0$
12.  $(2D - 1)y = (2D - 1)4e^{x/2} = 8De^{x/2} - 4e^{x/2} = 4e^{x/2} - 4e^{x/2} = 0$
13.  $(D - 2)(D + 5)(e^{2x} + 3e^{-5x}) = (D - 2)(2e^{2x} - 15e^{-5x} + 5e^{2x} + 15e^{-5x}) = (D - 2)7e^{2x} = 14e^{2x} - 14e^{2x} = 0$
14.  $(D^2 + 64)(2 \cos 8x - 5 \sin 8x) = D(-16 \sin 8x - 40 \cos 8x) + 64(2 \cos 8x - 5 \sin 8x)$   
 $= -128 \cos 8x + 320 \sin 8x + 128 \cos 8x - 320 \sin 8x = 0$
15.  $D^4$  because of  $x^3$
16.  $D^5$  because of  $x^4$
17.  $D(D - 2)$  because of 1 and  $e^{2x}$
18.  $D^2(D - 6)^2$  because of  $x$  and  $xe^{6x}$
19.  $D^2 + 4$  because of  $\cos 2x$
20.  $D(D^2 + 1)$  because of 1 and  $\sin x$
21.  $D^3(D^2 + 16)$  because of  $x^2$  and  $\sin 4x$
22.  $D^2(D^2 + 1)(D^2 + 25)$  because of  $x$ ,  $\sin x$ , and  $\cos 5x$
23.  $(D + 1)(D - 1)^3$  because of  $e^{-x}$  and  $x^2e^x$
24.  $D(D - 1)(D - 2)$  because of 1,  $e^x$ , and  $e^{2x}$
25.  $D(D^2 - 2D + 5)$  because of 1 and  $e^x \cos 2x$
26.  $(D^2 + 2D + 2)(D^2 - 4D + 5)$  because of  $e^{-x} \sin x$  and  $e^{2x} \cos x$
27. 1,  $x$ ,  $x^2$ ,  $x^3$ ,  $x^4$
28.  $D^2 + 4D = D(D + 4)$ ; 1,  $e^{-4x}$
29.  $e^{6x}$ ,  $e^{-3x/2}$
30.  $D^2 - 9D - 36 = (D - 12)(D + 3)$ ;  $e^{12x}$ ,  $e^{-3x}$
31.  $\cos \sqrt{5}x$ ,  $\sin \sqrt{5}x$
32.  $D^2 - 6D + 10 = D^2 - 2(3)D + (3^2 + 1^2)$ ;  $e^{3x} \cos x$ ,  $e^{3x} \sin x$
33.  $D^3 - 10D^2 + 25D = D(D - 5)^2$ ; 1,  $e^{5x}$ ,  $xe^{5x}$
34. 1,  $x$ ,  $e^{5x}$ ,  $e^{7x}$
35. Applying  $D$  to the differential equation we obtain

$$D(D^2 - 9)y = 0.$$

Then

$$y = \underbrace{c_1 e^{3x} + c_2 e^{-3x}}_{y_c} + c_3$$

### Exercises 4.5

and  $y_p = A$ . Substituting  $y_p$  into the differential equation yields  $-9A = 54$  or  $A = -6$ . The general solution is

$$y = c_1 e^{3x} + c_2 e^{-3x} - 6.$$

36. Applying  $D$  to the differential equation we obtain

$$D(2D^2 - 7D + 5)y = 0.$$

Then

$$y = \underbrace{c_1 e^{5x/2} + c_2 e^x}_{y_c} + c_3$$

and  $y_p = A$ . Substituting  $y_p$  into the differential equation yields  $5A = -29$  or  $A = -29/5$ . The general solution is

$$y = c_1 e^{5x/2} + c_2 e^x - \frac{29}{5}.$$

37. Applying  $D$  to the differential equation we obtain

$$D(D^2 + D)y = D^2(D + 1)y = 0.$$

Then

$$y = \underbrace{c_1 + c_2 e^{-x}}_{y_c} + c_3 x$$

and  $y_p = Ax$ . Substituting  $y_p$  into the differential equation yields  $A = 3$ . The general solution is

$$y = c_1 + c_2 e^{-3x} + 3x.$$

38. Applying  $D$  to the differential equation we obtain

$$D(D^3 + 2D^2 + D)y = D^2(D + 1)^2 y = 0.$$

Then

$$y = \underbrace{c_1 + c_2 e^{-x} + c_3 x e^{-x}}_{y_c} + c_4 x$$

and  $y_p = Ax$ . Substituting  $y_p$  into the differential equation yields  $A = 10$ . The general solution is

$$y = c_1 + c_2 e^{-x} + c_3 x e^{-x} + 10x.$$

39. Applying  $D^2$  to the differential equation we obtain

$$D^2(D^2 + 4D + 4)y = D^2(D + 2)^2 y = 0.$$

Then

$$y = \underbrace{c_1 e^{-2x} + c_2 x e^{-2x}}_{y_c} + c_3 + c_4 x$$

Exercises 4.5

and  $y_p = Ax + B$ . Substituting  $y_p$  into the differential equation yields  $4Ax + (4A + 4B) = 2x + 6$ . Equating coefficients gives

$$4A = 2$$

$$4A + 4B = 6.$$

Then  $A = 1/2$ ,  $B = 1$ , and the general solution is

$$y = c_1 e^{-2x} + c_2 x e^{-2x} + \frac{1}{2}x + 1.$$

40. Applying  $D^2$  to the differential equation we obtain

$$D^2(D^2 + 3D)y = D^3(D + 3)y = 0.$$

Then

$$y = \underbrace{c_1 + c_2 e^{-3x}}_{y_c} + c_3 x^2 + c_4 x$$

and  $y_p = Ax^2 + Bx$ . Substituting  $y_p$  into the differential equation yields  $6Ax + (2A + 3B) = 4x - 5$ . Equating coefficients gives

$$6A = 4$$

$$2A + 3B = -5.$$

Then  $A = 2/3$ ,  $B = -19/9$ , and the general solution is

$$y = c_1 + c_2 e^{-3x} + \frac{2}{3}x^2 - \frac{19}{9}x.$$

41. Applying  $D^3$  to the differential equation we obtain

$$D^3(D^3 + D^2)y = D^5(D + 1)y = 0.$$

Then

$$y = \underbrace{c_1 + c_2 x + c_3 e^{-x}}_{y_c} + c_4 x^4 + c_5 x^3 + c_6 x^2$$

and  $y_p = Ax^4 + Bx^3 + Cx^2$ . Substituting  $y_p$  into the differential equation yields

$$12Ax^2 + (24A + 6B)x + (6B + 2C) = 8x^2.$$

Equating coefficients gives

$$12A = 8$$

$$24A + 6B = 0$$

$$6B + 2C = 0.$$

### Exercises 4.5

Then  $A = 2/3$ ,  $B = -8/3$ ,  $C = 8$ , and the general solution is

$$y = c_1 + c_2x + c_3e^{-x} + \frac{2}{3}x^4 - \frac{8}{3}x^3 + 8x^2.$$

42. Applying  $D^4$  to the differential equation we obtain

$$D^4(D^2 - 2D + 1)y = D^4(D - 1)^2y = 0.$$

Then

$$y = \underbrace{c_1e^x + c_2xe^x}_{y_c} + c_3x^3 + c_4x^2 + c_5x + c_6$$

and  $y_p = Ax^3 + Bx^2 + Cx + D$ . Substituting  $y_p$  into the differential equation yields

$$Ax^3 + (B - 6A)x^2 + (6A - 4B + C)x + (2B - 2C + D) = x^3 + 4x.$$

Equating coefficients gives

$$A = 1$$

$$B - 6A = 0$$

$$6A - 4B + C = 4$$

$$2B - 2C + D = 0.$$

Then  $A = 1$ ,  $B = 6$ ,  $C = 22$ ,  $D = 32$ , and the general solution is

$$y = c_1e^x + c_2xe^x + x^3 + 6x^2 + 22x + 32.$$

43. Applying  $D - 4$  to the differential equation we obtain

$$(D - 4)(D^2 - D - 12)y = (D - 4)^2(D + 3)y = 0.$$

Then

$$y = \underbrace{c_1e^{4x} + c_2e^{-3x}}_{y_c} + c_3xe^{4x}$$

and  $y_p = Axe^{4x}$ . Substituting  $y_p$  into the differential equation yields  $7Ae^{4x} = e^{4x}$ . Equating coefficients gives  $A = 1/7$ . The general solution is

$$y = c_1e^{4x} + c_2e^{-3x} + \frac{1}{7}xe^{4x}.$$

44. Applying  $D - 6$  to the differential equation we obtain

$$(D - 6)(D^2 + 2D + 2)y = 0.$$

Then

$$y = \underbrace{e^{-x}(c_1 \cos x + c_2 \sin x)}_{y_c} + c_3e^{6x}$$



Exercises 4.5

and  $y_p = Ae^{6x}$ . Substituting  $y_p$  into the differential equation yields  $50Ae^{6x} = 5e^{6x}$ . Equating coefficients gives  $A = 1/10$ . The general solution is

$$y = e^{-x}(c_1 \cos x + c_2 \sin x) + \frac{1}{10}e^{6x}.$$

45. Applying  $D(D - 1)$  to the differential equation we obtain

$$D(D - 1)(D^2 - 2D - 3)y = D(D - 1)(D + 1)(D - 3)y = 0.$$

Then

$$y = \underbrace{c_1 e^{3x} + c_2 e^{-x}}_{y_c} + c_3 e^x + c_4$$

and  $y_p = Ae^x + B$ . Substituting  $y_p$  into the differential equation yields  $-4Ae^x - 3B = 4e^x - 9$ . Equating coefficients gives  $A = -1$  and  $B = 3$ . The general solution is

$$y = c_1 e^{3x} + c_2 e^{-x} - e^x + 3.$$

46. Applying  $D^2(D + 2)$  to the differential equation we obtain

$$D^2(D + 2)(D^2 + 6D + 8)y = D^2(D + 2)^2(D + 4)y = 0.$$

Then

$$y = \underbrace{c_1 e^{-2x} + c_2 e^{-4x}}_{y_c} + c_3 x e^{-2x} + c_4 x + c_5$$

and  $y_p = Axe^{-2x} + Bx + C$ . Substituting  $y_p$  into the differential equation yields

$$2Ae^{-2x} + 8Bx + (6B + 8C) = 3e^{-2x} + 2x.$$

Equating coefficients gives

$$2A = 3$$

$$8B = 2$$

$$6B + 8C = 0.$$

Then  $A = 3/2$ ,  $B = 1/4$ ,  $C = -3/16$ , and the general solution is

$$y = c_1 e^{-2x} + c_2 e^{-4x} + \frac{3}{2}x e^{-2x} + \frac{1}{4}x - \frac{3}{16}.$$

47. Applying  $D^2 + 1$  to the differential equation we obtain

$$(D^2 + 1)(D^2 + 25)y = 0.$$

Then

$$y = \underbrace{c_1 \cos 5x + c_2 \sin 5x}_{y_c} + c_3 \cos x + c_4 \sin x$$

### Exercises 4.5

and  $y_p = A \cos x + B \sin x$ . Substituting  $y_p$  into the differential equation yields

$$24A \cos x + 24B \sin x = 6 \sin x.$$

Equating coefficients gives  $A = 0$  and  $B = 1/4$ . The general solution is

$$y = c_1 \cos 5x + c_2 \sin 5x + \frac{1}{4} \sin x.$$

48. Applying  $D(D^2 + 1)$  to the differential equation we obtain

$$D(D^2 + 1)(D^2 + 4)y = 0.$$

Then

$$y = \underbrace{c_1 \cos 2x + c_2 \sin 2x}_{y_c} + c_3 \cos x + c_4 \sin x + c_5$$

and  $y_p = A \cos x + B \sin x + C$ . Substituting  $y_p$  into the differential equation yields

$$3A \cos x + 3B \sin x + 4C = 4 \cos x + 3 \sin x - 8.$$

Equating coefficients gives  $A = 4/3$ ,  $B = 1$ , and  $C = -2$ . The general solution is

$$y = c_1 \cos 2x + c_2 \sin 2x + \frac{4}{3} \cos x + \sin x - 2.$$

49. Applying  $(D - 4)^2$  to the differential equation we obtain

$$(D - 4)^2(D^2 + 6D + 9)y = (D - 4)^2(D + 3)^2y = 0.$$

Then

$$y = \underbrace{c_1 e^{-3x} + c_2 x e^{-3x}}_{y_c} + c_3 x e^{4x} + c_4 e^{4x}$$

and  $y_p = A x e^{4x} + B e^{4x}$ . Substituting  $y_p$  into the differential equation yields

$$49A x e^{4x} + (14A + 49B) e^{4x} = -x e^{4x}.$$

Equating coefficients gives

$$49A = -1$$

$$14A + 49B = 0.$$

Then  $A = -1/49$ ,  $B = 2/343$ , and the general solution is

$$y = c_1 e^{-3x} + c_2 x e^{-3x} - \frac{1}{49} x e^{4x} + \frac{2}{343} e^{4x}.$$

50. Applying  $D^2(D - 1)^2$  to the differential equation we obtain

$$D^2(D - 1)^2(D^2 + 3D - 10)y = D^2(D - 1)^2(D - 2)(D + 5)y = 0.$$

Then

$$y = \underbrace{c_1 e^{2x} + c_2 e^{-5x}}_{y_c} + c_3 x e^x + c_4 e^x + c_5 x + c_6$$

and  $y_p = Ax e^x + B e^x + Cx + D$ . Substituting  $y_p$  into the differential equation yields

$$-6Ax e^x + (5A - 6B)e^x - 10Cx + (3C - 10D) = x e^x + x.$$

Equating coefficients gives

$$-6A = 1$$

$$5A - 6B = 0$$

$$-10C = 1$$

$$3C - 10D = 0.$$

Then  $A = -1/6$ ,  $B = -5/36$ ,  $C = -1/10$ ,  $D = -3/100$ , and the general solution is

$$y = c_1 e^{2x} + c_2 e^{-5x} - \frac{1}{6} x e^x - \frac{5}{36} e^x - \frac{1}{10} x - \frac{3}{100}.$$

51. Applying  $D(D-1)^3$  to the differential equation we obtain

$$D(D-1)^3(D^2-1)y = D(D-1)^4(D+1)y = 0.$$

Then

$$y = \underbrace{c_1 e^x + c_2 e^{-x}}_{y_c} + c_3 x^3 e^x + c_4 x^2 e^x + c_5 x e^x + c_6$$

and  $y_p = Ax^3 e^x + Bx^2 e^x + Cx e^x + D$ . Substituting  $y_p$  into the differential equation yields

$$6Ax^2 e^x + (6A + 4B)x e^x + (2B + 2C)e^x - D = x^2 e^x + 5.$$

Equating coefficients gives

$$6A = 1$$

$$6A + 4B = 0$$

$$2B + 2C = 0$$

$$-D = 5.$$

Then  $A = 1/6$ ,  $B = -1/4$ ,  $C = 1/4$ ,  $D = -5$ , and the general solution is

$$y = c_1 e^x + c_2 e^{-x} + \frac{1}{6} x^3 e^x - \frac{1}{4} x^2 e^x + \frac{1}{4} x e^x - 5.$$

52. Applying  $(D+1)^3$  to the differential equation we obtain

$$(D+1)^3(D^2+2D+1)y = (D+1)^5 y = 0.$$

### Exercises 4.5

Then

$$y = \underbrace{c_1 e^{-x} + c_2 x e^{-x}}_{y_c} + c_3 x^4 e^{-x} + c_4 x^3 e^{-x} + c_5 x^2 e^{-x}$$

and  $y_p = Ax^4 e^{-x} + Bx^3 e^{-x} + Cx^2 e^{-x}$ . Substituting  $y_p$  into the differential equation yields

$$12Ax^2 e^{-x} + 6Bx e^{-x} + 2C e^{-x} = x^2 e^{-x}.$$

Equating coefficients gives  $A = \frac{1}{12}$ ,  $B = 0$ , and  $C = 0$ . The general solution is

$$y = c_1 e^{-x} + c_2 x e^{-x} + \frac{1}{12} x^4 e^{-x}.$$

53. Applying  $D^2 - 2D + 2$  to the differential equation we obtain

$$(D^2 - 2D + 2)(D^2 - 2D + 5)y = 0.$$

Then

$$y = \underbrace{e^x(c_1 \cos 2x + c_2 \sin 2x)}_{y_c} + e^x(c_3 \cos x + c_4 \sin x)$$

and  $y_p = Ae^x \cos x + Be^x \sin x$ . Substituting  $y_p$  into the differential equation yields

$$3Ae^x \cos x + 3Be^x \sin x = e^x \sin x.$$

Equating coefficients gives  $A = 0$  and  $B = 1/3$ . The general solution is

$$y = e^x(c_1 \cos 2x + c_2 \sin 2x) + \frac{1}{3} e^x \sin x.$$

54. Applying  $D^2 - 2D + 10$  to the differential equation we obtain

$$(D^2 - 2D + 10) \left( D^2 + D + \frac{1}{4} \right) y = (D^2 - 2D + 10) \left( D + \frac{1}{2} \right)^2 y = 0.$$

Then

$$y = \underbrace{c_1 e^{-x/2} + c_2 x e^{-x/2}}_{y_c} + c_3 e^x \cos 3x + c_4 e^x \sin 3x$$

and  $y_p = Ae^x \cos 3x + Be^x \sin 3x$ . Substituting  $y_p$  into the differential equation yields

$$(9B - 27A/4)e^x \cos 3x - (9A + 27B/4)e^x \sin 3x = -e^x \cos 3x + e^x \sin 3x.$$

Equating coefficients gives

$$-\frac{27}{4}A + 9B = -1$$

$$-9A - \frac{27}{4}B = 1.$$

Then  $A = -4/225$ ,  $B = -28/225$ , and the general solution is

$$y = c_1 e^{-x/2} + c_2 x e^{-x/2} - \frac{4}{225} e^x \cos 3x - \frac{28}{225} e^x \sin 3x.$$

55. Applying  $D^2 + 25$  to the differential equation we obtain

$$(D^2 + 25)(D^2 + 25) = (D^2 + 25)^2 = 0.$$

Then

$$y = \underbrace{c_1 \cos 5x + c_2 \sin 5x}_{y_c} + c_3 x \cos 5x + c_4 x \sin 5x$$

and  $y_p = Ax \cos 5x + Bx \sin 5x$ . Substituting  $y_p$  into the differential equation yields

$$10B \cos 5x - 10A \sin 5x = 20 \sin 5x.$$

Equating coefficients gives  $A = -2$  and  $B = 0$ . The general solution is

$$y = c_1 \cos 5x + c_2 \sin 5x - 2x \cos 5x.$$

56. Applying  $D^2 + 1$  to the differential equation we obtain

$$(D^2 + 1)(D^2 + 1) = (D^2 + 1)^2 = 0.$$

Then

$$y = \underbrace{c_1 \cos x + c_2 \sin x}_{y_c} + c_3 x \cos x + c_4 x \sin x$$

and  $y_p = Ax \cos x + Bx \sin x$ . Substituting  $y_p$  into the differential equation yields

$$2B \cos x - 2A \sin x = 4 \cos x - \sin x.$$

Equating coefficients gives  $A = 1/2$  and  $B = 2$ . The general solution is

$$y = c_1 \cos x + c_2 \sin x + \frac{1}{2}x \cos x - 2x \sin x.$$

57. Applying  $(D^2 + 1)^2$  to the differential equation we obtain

$$(D^2 + 1)^2(D^2 + D + 1) = 0.$$

Then

$$y = e^{-x/2} \underbrace{\left[ c_1 \cos \frac{\sqrt{3}}{2} x + c_2 \sin \frac{\sqrt{3}}{2} x \right]}_{y_c} + c_3 \cos x + c_4 \sin x + c_5 x \cos x + c_6 x \sin x$$

and  $y_p = A \cos x + B \sin x + Cx \cos x + Dx \sin x$ . Substituting  $y_p$  into the differential equation yields

$$(B + C + 2D) \cos x + Dx \cos x + (-A - 2C + D) \sin x - Cx \sin x = x \sin x.$$

Equating coefficients gives

$$B + C + 2D = 0$$

$$D = 0$$

$$-A - 2C + D = 0$$

$$-C = 1.$$

### Exercises 4.5

Then  $A = 2$ ,  $B = 1$ ,  $C = -1$ , and  $D = 0$ , and the general solution is

$$y = e^{-x/2} \left[ c_1 \cos \frac{\sqrt{3}}{2} x + c_2 \sin \frac{\sqrt{3}}{2} x \right] + 2 \cos x + \sin x - x \cos x.$$

58. Writing  $\cos^2 x = \frac{1}{2}(1 + \cos 2x)$  and applying  $D(D^2 + 4)$  to the differential equation we obtain

$$D(D^2 + 4)(D^2 + 4) = D(D^2 + 4)^2 = 0.$$

Then

$$y = \underbrace{c_1 \cos 2x + c_2 \sin 2x}_{y_c} + c_3 x \cos 2x + c_4 x \sin 2x + c_5$$

and  $y_p = Ax \cos 2x + Bx \sin 2x + C$ . Substituting  $y_p$  into the differential equation yields

$$-4A \sin 2x + 4B \cos 2x + 4C = \frac{1}{2} + \frac{1}{2} \cos 2x.$$

Equating coefficients gives  $A = 0$ ,  $B = 1/8$ , and  $C = 1/8$ . The general solution is

$$y = c_1 \cos 2x + c_2 \sin 2x + \frac{1}{8} x \sin 2x + \frac{1}{8}.$$

59. Applying  $D^3$  to the differential equation we obtain

$$D^3(D^3 + 8D^2) = D^5(D + 8) = 0.$$

Then

$$y = \underbrace{c_1 + c_2 x + c_3 e^{-8x}}_{y_c} + c_4 x^2 + c_5 x^3 + c_6 x^4$$

and  $y_p = Ax^2 + Bx^3 + Cx^4$ . Substituting  $y_p$  into the differential equation yields

$$16A + 6B + (48B + 24C)x + 96Cx^2 = 2 + 9x - 6x^2.$$

Equating coefficients gives

$$16A + 6B = 2$$

$$48B + 24C = 9$$

$$96C = -6.$$

Then  $A = 11/256$ ,  $B = 7/32$ , and  $C = -1/16$ , and the general solution is

$$y = c_1 + c_2 x + c_3 e^{-8x} + \frac{11}{256} x^2 + \frac{7}{32} x^3 - \frac{1}{16} x^4.$$

60. Applying  $D(D - 1)^2(D + 1)$  to the differential equation we obtain

$$D(D - 1)^2(D + 1)(D^3 - D^2 + D - 1) = D(D - 1)^3(D + 1)(D^2 + 1) = 0.$$

Then

$$y = \underbrace{c_1 e^x + c_2 \cos x + c_3 \sin x}_{y_c} + c_4 + c_5 e^{-x} + c_6 x e^x + c_7 x^2 e^x$$

and  $y_p = A + Be^{-x} + Cxe^x + Dx^2e^x$ . Substituting  $y_p$  into the differential equation yields

$$4Dxe^x + (2C + 4D)e^x - 4Be^{-x} - A = xe^x - e^{-x} + 7.$$

Equating coefficients gives

$$4D = 1$$

$$2C + 4D = 0$$

$$-4B = -1$$

$$-A = 7.$$

Then  $A = -7$ ,  $B = 1/4$ ,  $C = -1/2$ , and  $D = 1/4$ , and the general solution is

$$y = c_1e^x + c_2 \cos x + c_3 \sin x - 7 + \frac{1}{4}e^{-x} - \frac{1}{2}xe^x + \frac{1}{4}x^2e^x.$$

61. Applying  $D^2(D-1)$  to the differential equation we obtain

$$D^2(D-1)(D^3 - 3D^2 + 3D - 1) = D^2(D-1)^4 = 0.$$

Then

$$y = \underbrace{c_1e^x + c_2xe^x + c_3x^2e^x}_{y_c} + c_4 + c_5x + c_6x^3e^x$$

and  $y_p = A + Bx + Cx^3e^x$ . Substituting  $y_p$  into the differential equation yields

$$(-A + 3B) - Bx + 6Ce^x = 16 - x + e^x.$$

Equating coefficients gives

$$-A + 3B = 16$$

$$-B = -1$$

$$6C = 1.$$

Then  $A = -13$ ,  $B = 1$ , and  $C = 1/6$ , and the general solution is

$$y = c_1e^x + c_2xe^x + c_3x^2e^x - 13 + x + \frac{1}{6}x^3e^x.$$

62. Writing  $(e^x + e^{-x})^2 = 2 + e^{2x} + e^{-2x}$  and applying  $D(D-2)(D+2)$  to the differential equation we obtain

$$D(D-2)(D+2)(2D^3 - 3D^2 - 3D + 2) = D(D-2)^2(D+2)(D+1)(2D-1) = 0.$$

Then

$$y = \underbrace{c_1e^{-x} + c_2e^{2x} + c_3e^{x/2}}_{y_c} + c_4 + c_5xe^{2x} + c_6e^{-2x}$$

### Exercises 4.5

and  $y_p = A + Bxe^{2x} + Ce^{-2x}$ . Substituting  $y_p$  into the differential equation yields

$$2A + 9Be^{2x} - 20Ce^{-2x} = 2 + e^{2x} + e^{-2x}.$$

Equating coefficients gives  $A = 1$ ,  $B = 1/9$ , and  $C = -1/20$ . The general solution is

$$y = c_1e^{-x} + c_2e^{2x} + c_3e^{x/2} + 1 + \frac{1}{9}xe^{2x} - \frac{1}{20}e^{-2x}.$$

63. Applying  $D(D - 1)$  to the differential equation we obtain

$$D(D - 1)(D^4 - 2D^3 + D^2) = D^3(D - 1)^3 = 0.$$

Then

$$y = \underbrace{c_1 + c_2x + c_3e^x + c_4xe^x}_{y_c} + c_5x^2 + c_6x^2e^x$$

and  $y_p = Ax^2 + Bx^2e^x$ . Substituting  $y_p$  into the differential equation yields  $2A + 2Be^x = 1 + e^x$ .

Equating coefficients gives  $A = 1/2$  and  $B = 1/2$ . The general solution is

$$y = c_1 + c_2x + c_3e^x + c_4xe^x + \frac{1}{2}x^2 + \frac{1}{2}x^2e^x.$$

64. Applying  $D^3(D - 2)$  to the differential equation we obtain

$$D^3(D - 2)(D^4 - 4D^2) = D^5(D - 2)^2(D + 2) = 0.$$

Then

$$y = \underbrace{c_1 + c_2x + c_3e^{2x} + c_4e^{-2x}}_{y_c} + c_5x^2 + c_6x^3 + c_7x^4 + c_8xe^{2x}$$

and  $y_p = Ax^2 + Bx^3 + Cx^4 + Dxe^{2x}$ . Substituting  $y_p$  into the differential equation yields

$$(-8A + 24C) - 24Bx - 48Cx^2 + 16De^{2x} = 5x^2 - e^{2x}.$$

Equating coefficients gives

$$-8A + 24C = 0$$

$$-24B = 0$$

$$-48C = 5$$

$$16D = -1.$$

Then  $A = -5/16$ ,  $B = 0$ ,  $C = -5/48$ , and  $D = -1/16$ , and the general solution is

$$y = c_1 + c_2x + c_3e^{2x} + c_4e^{-2x} - \frac{5}{16}x^2 - \frac{5}{48}x^4 - \frac{1}{16}xe^{2x}.$$



Exercises 4.5

65. The complementary function is  $y_c = c_1e^{8x} + c_2e^{-8x}$ . Using  $D$  to annihilate 16 we find  $y_p = A$ . Substituting  $y_p$  into the differential equation we obtain  $-64A = 16$ . Thus  $A = -1/4$  and

$$y = c_1e^{8x} + c_2e^{-8x} - \frac{1}{4}$$

$$y' = 8c_1e^{8x} - 8c_2e^{-8x}.$$

The initial conditions imply

$$c_1 + c_2 = \frac{5}{4}$$

$$8c_1 - 8c_2 = 0.$$

Thus  $c_1 = c_2 = 5/8$  and

$$y = \frac{5}{8}e^{8x} + \frac{5}{8}e^{-8x} - \frac{1}{4}.$$

66. The complementary function is  $y_c = c_1 + c_2e^{-x}$ . Using  $D^2$  to annihilate  $x$  we find  $y_p = Ax + Bx^2$ . Substituting  $y_p$  into the differential equation we obtain  $(A + 2B) + 2Bx = x$ . Thus  $A = -1$  and  $B = 1/2$ , and

$$y = c_1 + c_2e^{-x} - x + \frac{1}{2}x^2$$

$$y' = -c_2e^{-x} - 1 + x.$$

The initial conditions imply

$$c_1 + c_2 = 1$$

$$-c_2 = 1.$$

Thus  $c_1 = 2$  and  $c_2 = -1$ , and

$$y = 2 - e^{-x} - x + \frac{1}{2}x^2.$$

67. The complementary function is  $y_c = c_1 + c_2e^{5x}$ . Using  $D^2$  to annihilate  $x - 2$  we find  $y_p = Ax + Bx^2$ . Substituting  $y_p$  into the differential equation we obtain  $(-5A + 2B) - 10Bx = -2 + x$ . Thus  $A = 9/25$  and  $B = -1/10$ , and

$$y = c_1 + c_2e^{5x} + \frac{9}{25}x - \frac{1}{10}x^2$$

$$y' = 5c_2e^{5x} + \frac{9}{25} - \frac{1}{5}x.$$

The initial conditions imply

$$c_1 + c_2 = 0$$

$$5c_2 = \frac{41}{125}.$$

### Exercises 4.5

Thus  $c_1 = -41/125$  and  $c_2 = 41/125$ , and

$$y = -\frac{41}{125} + \frac{41}{125}e^{5x} + \frac{9}{25}x - \frac{1}{10}x^2.$$

68. The complementary function is  $y_c = c_1e^x + c_2e^{-6x}$ . Using  $D - 2$  to annihilate  $10e^{2x}$  we find  $y_p = Ae^{2x}$ . Substituting  $y_p$  into the differential equation we obtain  $8Ae^{2x} = 10e^{2x}$ . Thus  $A = 5/4$  and

$$y = c_1e^x + c_2e^{-6x} + \frac{5}{4}e^{2x}$$

$$y' = c_1e^x - 6c_2e^{-6x} + \frac{5}{2}e^{2x}.$$

The initial conditions imply

$$c_1 + c_2 = -\frac{1}{4}$$

$$c_1 - 6c_2 = -\frac{3}{2}.$$

Thus  $c_1 = -3/7$  and  $c_2 = 5/28$ , and

$$y = -\frac{3}{7}e^x + \frac{5}{28}e^{-6x} + \frac{5}{4}e^{2x}$$

69. The complementary function is  $y_c = c_1 \cos x + c_2 \sin x$ . Using  $(D^2 + 1)(D^2 + 4)$  to annihilate  $8 \cos 2x - 4 \sin x$  we find  $y_p = Ax \cos x + Bx \sin x + C \cos 2x + D \sin 2x$ . Substituting  $y_p$  into the differential equation we obtain  $2B \cos x - 3C \cos 2x - 2A \sin x - 3D \sin 2x = 8 \cos 2x - 4 \sin x$ . Thus  $A = 2$ ,  $B = 0$ ,  $C = -8/3$ , and  $D = 0$ , and

$$y = c_1 \cos x + c_2 \sin x + 2x \cos x - \frac{8}{3} \cos 2x$$

$$y' = -c_1 \sin x + c_2 \cos x + 2 \cos x - 2x \sin x + \frac{16}{3} \sin 2x.$$

The initial conditions imply

$$c_2 + \frac{8}{3} = -1$$

$$-c_1 - \pi = 0.$$

Thus  $c_1 = -\pi$  and  $c_2 = -11/3$ , and

$$y = -\pi \cos x - \frac{11}{3} \sin x + 2x \cos x - \frac{8}{3} \cos 2x.$$

70. The complementary function is  $y_c = c_1 + c_2e^x + c_3xe^x$ . Using  $D(D - 1)^2$  to annihilate  $xe^x + 5$  we find  $y_p = Ax + Bx^2e^x + Cx^3e^x$ . Substituting  $y_p$  into the differential equation

Exercises 4.5

we obtain  $A + (2B + 6C)e^x + 6Cxe^x = xe^x + 5$ . Thus  $A = 5$ ,  $B = -1/2$ , and  $C = 1/6$ , and

$$y = c_1 + c_2e^x + c_3xe^x + 5x - \frac{1}{2}x^2e^x + \frac{1}{6}x^3e^x$$

$$y' = c_2e^x + c_3(xe^x + e^x) + 5 - xe^x + \frac{1}{6}x^3e^x$$

$$y'' = c_2e^x + c_3(xe^x + 2e^x) - e^x - xe^x + \frac{1}{2}x^2e^x + \frac{1}{6}x^3e^x.$$

The initial conditions imply

$$c_1 + c_2 = 2$$

$$c_2 + c_3 + 5 = 2$$

$$c_2 + 2c_3 - 1 = -1.$$

Thus  $c_1 = 8$ ,  $c_2 = -6$ , and  $c_3 = 3$ , and

$$y = 8 - 6e^x + 3xe^x + 5x - \frac{1}{2}x^2e^x + \frac{1}{6}x^3e^x.$$

71. The complementary function is  $y_c = e^{2x}(c_1 \cos 2x + c_2 \sin 2x)$ . Using  $D^4$  to annihilate  $x^3$  we find  $y_p = A + Bx + Cx^2 + Dx^3$ . Substituting  $y_p$  into the differential equation we obtain  $(8A - 4B + 2C) + (8B - 8C + 6D)x + (8C - 12D)x^2 + 8Dx^3 = x^3$ . Thus  $A = 0$ ,  $B = 3/32$ ,  $C = 3/16$ , and  $D = 1/8$ , and

$$y = e^{2x}(c_1 \cos 2x + c_2 \sin 2x) + \frac{3}{32}x + \frac{3}{16}x^2 + \frac{1}{8}x^3$$

$$y' = e^{2x} [c_1(2 \cos 2x - 2 \sin 2x) + c_2(2 \cos 2x + 2 \sin 2x)] + \frac{3}{32} + \frac{3}{8}x + \frac{3}{8}x^2.$$

The initial conditions imply

$$c_1 = 2$$

$$2c_1 + 2c_2 + \frac{3}{32} = 4.$$

Thus  $c_1 = 2$ ,  $c_2 = -3/64$ , and

$$y = e^{2x}(2 \cos 2x - \frac{3}{64} \sin 2x) + \frac{3}{32}x + \frac{3}{16}x^2 + \frac{1}{8}x^3.$$

72. The complementary function is  $y_c = c_1 + c_2x + c_3x^2 + c_4e^x$ . Using  $D^2(D - 1)$  to annihilate  $x + e^x$  we find  $y_p = Ax^3 + Bx^4 + Cxe^x$ . Substituting  $y_p$  into the differential equation we obtain

### Exercises 4.5

$(-6A + 24B) - 24Bx + Ce^x = x + e^x$ . Thus  $A = -1/6$ ,  $B = -1/24$ , and  $C = 1$ , and

$$y = c_1 + c_2x + c_3x^2 + c_4e^x - \frac{1}{6}x^3 - \frac{1}{24}x^4 + xe^x$$

$$y' = c_2 + 2c_3x + c_4e^x - \frac{1}{2}x^2 - \frac{1}{6}x^3 + e^x + xe^x$$

$$y'' = 2c_3 + c_4e^x - x - \frac{1}{2}x^2 + 2e^x + xe^x.$$

$$y''' = c_4e^x - 1 - x + 3e^x + xe^x$$

The initial conditions imply

$$c_1 + c_4 = 0$$

$$c_2 + c_4 + 1 = 0$$

$$2c_3 + c_4 + 2 = 0$$

$$2 + c_4 = 0.$$

Thus  $c_1 = 2$ ,  $c_2 = 1$ ,  $c_3 = 0$ , and  $c_4 = -2$ , and

$$y = 2 + x - 2e^x - \frac{1}{6}x^3 - \frac{1}{24}x^4 + xe^x.$$

73. To see in this case that the factors of  $L$  do not commute consider the operators  $(xD - 1)(D + 4)$  and  $(D + 4)(xD - 1)$ . Applying the operators to the function  $x$  we find

$$\begin{aligned}(xD - 1)(D + 4)x &= (xD^2 + 4xD - D - 4)x \\ &= xD^2x + 4xDx - Dx - 4x \\ &= x(0) + 4x(1) - 1 - 4x = -1\end{aligned}$$

and

$$\begin{aligned}(D + 4)(xD - 1)x &= (D + 4)(xDx - x) \\ &= (D + 4)(x \cdot 1 - x) = 0.\end{aligned}$$

Thus, the operators are not the same.

---

### Exercises 4.6

---

The particular solution,  $y_p = u_1y_1 + u_2y_2$ , in the following problems can take on a variety of forms, especially where trigonometric functions are involved. The validity of a particular form can best be checked by substituting it back into the differential equation.

1. The auxiliary equation is  $m^2 + 1 = 0$ , so  $y_c = c_1 \cos x + c_2 \sin x$  and

$$W = \begin{vmatrix} \cos x & \sin x \\ -\sin x & \cos x \end{vmatrix} = 1.$$

Identifying  $f(x) = \sec x$  we obtain

$$u_1' = -\frac{\sin x \sec x}{1} = -\tan x$$

$$u_2' = \frac{\cos x \sec x}{1} = 1.$$

Then  $u_1 = \ln |\cos x|$ ,  $u_2 = x$ , and

$$y = c_1 \cos x + c_2 \sin x + \cos x \ln |\cos x| + x \sin x.$$

2. The auxiliary equation is  $m^2 + 1 = 0$ , so  $y_c = c_1 \cos x + c_2 \sin x$  and

$$W = \begin{vmatrix} \cos x & \sin x \\ -\sin x & \cos x \end{vmatrix} = 1.$$

Identifying  $f(x) = \tan x$  we obtain

$$u_1' = -\sin x \tan x = \frac{\cos^2 x - 1}{\cos x} = \cos x - \sec x$$

$$u_2' = \sin x.$$

Then  $u_1 = \sin x - \ln |\sec x + \tan x|$ ,  $u_2 = -\cos x$ , and

$$y = c_1 \cos x + c_2 \sin x + \cos x (\sin x - \ln |\sec x + \tan x|) - \cos x \sin x.$$

3. The auxiliary equation is  $m^2 + 1 = 0$ , so  $y_c = c_1 \cos x + c_2 \sin x$  and

$$W = \begin{vmatrix} \cos x & \sin x \\ -\sin x & \cos x \end{vmatrix} = 1.$$

Identifying  $f(x) = \sin x$  we obtain

$$u_1' = -\sin^2 x$$

$$u_2' = \cos x \sin x.$$

Then

$$u_1 = \frac{1}{4} \sin 2x - \frac{1}{2}x = \frac{1}{2} \sin x \cos x - \frac{1}{2}x$$

$$u_2 = -\frac{1}{2} \cos^2 x.$$

and

$$\begin{aligned} y &= c_1 \cos x + c_2 \sin x + \frac{1}{2} \sin x \cos^2 x - \frac{1}{2}x \cos x - \frac{1}{2} \cos^2 x \sin x \\ &= c_1 \cos x + c_2 \sin x - \frac{1}{2}x \cos x. \end{aligned}$$

### Exercises 4.6

4. The auxiliary equation is  $m^2 + 1 = 0$ , so  $y_c = c_1 \cos x + c_2 \sin x$  and

$$W = \begin{vmatrix} \cos x & \sin x \\ -\sin x & \cos x \end{vmatrix} = 1.$$

Identifying  $f(x) = \sec x \tan x$  we obtain

$$u_1' = -\sin x(\sec x \tan x) = -\tan^2 x = 1 - \sec^2 x$$

$$u_2' = \cos x(\sec x \tan x) = \tan x.$$

Then  $u_1 = x - \tan x$ ,  $u_2 = -\ln |\cos x|$ , and

$$\begin{aligned} y &= c_1 \cos x + c_2 \sin x + x \cos x - \sin x - \sin x \ln |\cos x| \\ &= c_1 \cos x + c_3 \sin x + x \cos x - \sin x \ln |\cos x|. \end{aligned}$$

5. The auxiliary equation is  $m^2 + 1 = 0$ , so  $y_c = c_1 \cos x + c_2 \sin x$  and

$$W = \begin{vmatrix} \cos x & \sin x \\ -\sin x & \cos x \end{vmatrix} = 1.$$

Identifying  $f(x) = \cos^2 x$  we obtain

$$u_1' = -\sin x \cos^2 x$$

$$u_2' = \cos^3 x = \cos x (1 - \sin^2 x).$$

Then  $u_1 = \frac{1}{3} \cos^3 x$ ,  $u_2 = \sin x - \frac{1}{3} \sin^3 x$ , and

$$\begin{aligned} y &= c_1 \cos x + c_2 \sin x + \frac{1}{3} \cos^4 x + \sin^2 x - \frac{1}{3} \sin^4 x \\ &= c_1 \cos x + c_2 \sin x + \frac{1}{3} (\cos^2 x + \sin^2 x) (\cos^2 x - \sin^2 x) + \sin^2 x \\ &= c_1 \cos x + c_2 \sin x + \frac{1}{3} \cos^2 x + \frac{2}{3} \sin^2 x \\ &= c_1 \cos x + c_2 \sin x + \frac{1}{3} + \frac{1}{3} \sin^2 x. \end{aligned}$$

6. The auxiliary equation is  $m^2 + 1 = 0$ , so  $y_c = c_1 \cos x + c_2 \sin x$  and

$$W = \begin{vmatrix} \cos x & \sin x \\ -\sin x & \cos x \end{vmatrix} = 1.$$

Identifying  $f(x) = \sec^2 x$  we obtain

$$u_1' = -\frac{\sin x}{\cos^2 x}$$

$$u_2' = \sec x.$$

Then

$$u_1 = -\frac{1}{\cos x} = -\sec x$$

$$u_2 = \ln |\sec x + \tan x|$$

and

$$\begin{aligned} y &= c_1 \cos x + c_2 \sin x - \cos x \sec x + \sin x \ln |\sec x + \tan x| \\ &= c_1 \cos x + c_2 \sin x - 1 + \sin x \ln |\sec x + \tan x|. \end{aligned}$$

7. The auxiliary equation is  $m^2 - 1 = 0$ , so  $y_c = c_1 e^x + c_2 e^{-x}$  and

$$W = \begin{vmatrix} e^x & e^{-x} \\ e^x & -e^{-x} \end{vmatrix} = -2.$$

Identifying  $f(x) = \cosh x = \frac{1}{2}(e^{-x} + e^x)$  we obtain

$$u_1' = \frac{1}{4}e^{2x} + \frac{1}{4}$$

$$u_2' = -\frac{1}{4} - \frac{1}{4}e^{2x}.$$

Then

$$u_1 = -\frac{1}{8}e^{-2x} + \frac{1}{4}x$$

$$u_2 = -\frac{1}{8}e^{2x} - \frac{1}{4}x$$

and

$$\begin{aligned} y &= c_1 e^x + c_2 e^{-x} - \frac{1}{8}e^{-x} + \frac{1}{4}xe^x - \frac{1}{8}e^x - \frac{1}{4}xe^{-x} \\ &= c_3 e^x + c_4 e^{-x} + \frac{1}{4}x(e^x - e^{-x}) \\ &= c_3 e^x + c_4 e^{-x} + \frac{1}{2}x \sinh x. \end{aligned}$$

8. The auxiliary equation is  $m^2 - 1 = 0$ , so  $y_c = c_1 e^x + c_2 e^{-x}$  and

$$W = \begin{vmatrix} e^x & e^{-x} \\ e^x & -e^{-x} \end{vmatrix} = -2.$$

Identifying  $f(x) = \sinh 2x$  we obtain

$$u_1' = -\frac{1}{4}e^{-3x} + \frac{1}{4}e^x$$

$$u_2' = \frac{1}{4}e^{-x} - \frac{1}{4}e^{3x}.$$

### Exercises 4.6

Then

$$u_1 = \frac{1}{12}e^{-3x} + \frac{1}{4}e^x$$

$$u_2 = -\frac{1}{4}e^{-x} - \frac{1}{12}e^{3x}$$

and

$$\begin{aligned} y &= c_1e^x + c_2e^{-x} + \frac{1}{12}e^{-2x} + \frac{1}{4}e^{2x} - \frac{1}{4}e^{-2x} - \frac{1}{12}e^{2x} \\ &= c_1e^x + c_2e^{-x} + \frac{1}{6}(e^{2x} - e^{-2x}) \\ &= c_1e^x + c_2e^{-x} + \frac{1}{3}\sinh 2x. \end{aligned}$$

9. The auxiliary equation is  $m^2 - 4 = 0$ , so  $y_c = c_1e^{2x} + c_2e^{-2x}$  and

$$W = \begin{vmatrix} e^{2x} & e^{-2x} \\ 2e^{2x} & -2e^{-2x} \end{vmatrix} = -4.$$

Identifying  $f(x) = e^{2x}/x$  we obtain  $u'_1 = 1/4x$  and  $u'_2 = -e^{4x}/4x$ . Then

$$u_1 = \frac{1}{4}\ln|x|,$$

$$u_2 = -\frac{1}{4}\int_{x_0}^x \frac{e^{4t}}{t} dt$$

and

$$y = c_1e^{2x} + c_2e^{-2x} + \frac{1}{4}\left(e^{2x}\ln|x| - e^{-2x}\int_{x_0}^x \frac{e^{4t}}{t} dt\right), \quad x_0 > 0.$$

10. The auxiliary equation is  $m^2 - 9 = 0$ , so  $y_c = c_1e^{3x} + c_2e^{-3x}$  and

$$W = \begin{vmatrix} e^{3x} & e^{-3x} \\ 3e^{3x} & -3e^{-3x} \end{vmatrix} = -6.$$

Identifying  $f(x) = 9x/e^{3x}$  we obtain  $u'_1 = \frac{3}{2}xe^{-6x}$  and  $u'_2 = -\frac{3}{2}x$ . Then

$$u_1 = -\frac{1}{24}e^{-6x} - \frac{1}{4}xe^{-6x},$$

$$u_2 = -\frac{3}{4}x^2$$

and

$$\begin{aligned} y &= c_1e^{3x} + c_2e^{-3x} - \frac{1}{24}e^{-3x} - \frac{1}{4}xe^{-3x} - \frac{3}{4}x^2e^{-3x} \\ &= c_1e^{3x} + c_3e^{-3x} - \frac{1}{4}xe^{-3x}(1 - 3x). \end{aligned}$$



Exercises 4.6

11. The auxiliary equation is  $m^2 + 3m + 2 = (m + 1)(m + 2) = 0$ , so  $y_c = c_1e^{-x} + c_2e^{-2x}$  and

$$W = \begin{vmatrix} e^{-x} & e^{-2x} \\ -e^{-x} & -2e^{-2x} \end{vmatrix} = -e^{-3x}.$$

Identifying  $f(x) = 1/(1 + e^x)$  we obtain

$$u_1' = \frac{e^x}{1 + e^x}$$

$$u_2' = -\frac{e^{2x}}{1 + e^x} = \frac{e^x}{1 + e^x} - e^x.$$

Then  $u_1 = \ln(1 + e^x)$ ,  $u_2 = \ln(1 + e^x) - e^x$ , and

$$\begin{aligned} y &= c_1e^{-x} + c_2e^{-2x} + e^{-x} \ln(1 + e^x) + e^{-2x} \ln(1 + e^x) - e^{-x} \\ &= c_3e^{-x} + c_2e^{-2x} + (1 + e^{-x})e^{-x} \ln(1 + e^x). \end{aligned}$$

12. The auxiliary equation is  $m^2 - 2m + 1 = (m - 1)^2 = 0$ , so  $y_c = c_1e^x + c_2xe^x$  and

$$W = \begin{vmatrix} e^x & xe^x \\ e^x & xe^x + e^x \end{vmatrix} = e^{2x}.$$

Identifying  $f(x) = e^x/(1 + x^2)$  we obtain

$$u_1' = -\frac{xe^xe^x}{e^{2x}(1 + x^2)} = -\frac{x}{1 + x^2}$$

$$u_2' = \frac{e^xe^x}{e^{2x}(1 + x^2)} = \frac{1}{1 + x^2}.$$

Then  $u_1 = -\frac{1}{2} \ln(1 + x^2)$ ,  $u_2 = \tan^{-1} x$ , and

$$y = c_1e^x + c_2xe^x - \frac{1}{2}e^x \ln(1 + x^2) + xe^x \tan^{-1} x.$$

13. The auxiliary equation is  $m^2 + 3m + 2 = (m + 1)(m + 2) = 0$ , so  $y_c = c_1e^{-x} + c_2e^{-2x}$  and

$$W = \begin{vmatrix} e^{-x} & e^{-2x} \\ -e^{-x} & -2e^{-2x} \end{vmatrix} = -e^{-3x}.$$

Identifying  $f(x) = \sin e^x$  we obtain

$$u_1' = \frac{e^{-2x} \sin e^x}{e^{-3x}} = e^x \sin e^x$$

$$u_2' = \frac{e^{-x} \sin e^x}{-e^{-3x}} = -e^{2x} \sin e^x.$$

Then  $u_1 = -\cos e^x$ ,  $u_2 = e^x \cos x - \sin e^x$ , and

$$\begin{aligned} y &= c_1e^{-x} + c_2e^{-2x} - e^{-x} \cos e^x + e^{-x} \cos e^x - e^{-2x} \sin e^x \\ &= c_1e^{-x} + c_2e^{-2x} - e^{-2x} \sin e^x. \end{aligned}$$

### Exercises 4.6

14. The auxiliary equation is  $m^2 - 2m + 1 = (m - 1)^2 = 0$ , so  $y_c = c_1 e^t + c_2 t e^t$  and

$$W = \begin{vmatrix} e^t & t e^t \\ e^t & t e^t + e^t \end{vmatrix} = e^{2t}.$$

Identifying  $f(t) = e^t \tan^{-1} t$  we obtain

$$u'_1 = -\frac{t e^t e^t \tan^{-1} t}{e^{2t}} = -t \tan^{-1} t$$

$$u'_2 = \frac{e^t e^t \tan^{-1} t}{e^{2t}} = \tan^{-1} t.$$

Then

$$u_1 = -\frac{1+t^2}{2} \tan^{-1} t + \frac{t}{2}$$

$$u_2 = t \tan^{-1} t - \frac{1}{2} \ln(1+t^2)$$

and

$$\begin{aligned} y &= c_1 e^t + c_2 t e^t + \left(-\frac{1+t^2}{2} \tan^{-1} t + \frac{t}{2}\right) e^t + \left(t \tan^{-1} t - \frac{1}{2} \ln(1+t^2)\right) t e^t \\ &= c_1 e^t + c_3 t e^t + \frac{1}{2} e^t \left[(t^2 - 1) \tan^{-1} t - \ln(1+t^2)\right]. \end{aligned}$$

15. The auxiliary equation is  $m^2 + 2m + 1 = (m + 1)^2 = 0$ , so  $y_c = c_1 e^{-t} + c_2 t e^{-t}$  and

$$W = \begin{vmatrix} e^{-t} & t e^{-t} \\ -e^{-t} & -t e^{-t} + e^{-t} \end{vmatrix} = e^{-2t}.$$

Identifying  $f(t) = e^{-t} \ln t$  we obtain

$$u'_1 = -\frac{t e^{-t} e^{-t} \ln t}{e^{-2t}} = -t \ln t$$

$$u'_2 = \frac{e^{-t} e^{-t} \ln t}{e^{-2t}} = \ln t.$$

Then

$$u_1 = -\frac{1}{2} t^2 \ln t + \frac{1}{4} t^2$$

$$u_2 = t \ln t - t$$

and

$$\begin{aligned} y &= c_1 e^{-t} + c_2 t e^{-t} - \frac{1}{2} t^2 e^{-t} \ln t + \frac{1}{4} t^2 e^{-t} + t^2 e^{-t} \ln t - t^2 e^{-t} \\ &= c_1 e^{-t} + c_2 t e^{-t} + \frac{1}{2} t^2 e^{-t} \ln t - \frac{3}{4} t^2 e^{-t}. \end{aligned}$$

16. The auxiliary equation is  $2m^2 + 2m + 1 = 0$ , so  $y_c = e^{-x/2}(c_1 \cos x/2 + c_2 \sin x/2)$  and

$$W = \begin{vmatrix} e^{-x/2} \cos \frac{x}{2} & e^{-x/2} \sin \frac{x}{2} \\ -\frac{1}{2}e^{-x/2} \cos \frac{x}{2} - \frac{1}{2}e^{-x/2} \sin \frac{x}{2} & \frac{1}{2}e^{-x/2} \cos \frac{x}{2} - \frac{1}{2}e^{x/2} \sin \frac{x}{2} \end{vmatrix} = \frac{1}{2}e^{-x}.$$

Identifying  $f(x) = 2\sqrt{x}$  we obtain

$$u_1' = -\frac{e^{-x/2} \sin(x/2) 2\sqrt{x}}{e^{-x/2}} = -4e^{x/2} \sqrt{x} \sin \frac{x}{2}$$

$$u_2' = -\frac{e^{-x/2} \cos(x/2) 2\sqrt{x}}{e^{-x/2}} = 4e^{x/2} \sqrt{x} \cos \frac{x}{2}.$$

Then

$$u_1 = -4 \int_{x_0}^x e^{t/2} \sqrt{t} \sin \frac{t}{2} dt$$

$$u_2 = 4 \int_{x_0}^x e^{t/2} \sqrt{t} \cos \frac{t}{2} dt$$

and

$$y = e^{-x/2} \left( c_1 \cos \frac{x}{2} + c_2 \sin \frac{x}{2} \right) - 4e^{-x/2} \cos \frac{x}{2} \int_{x_0}^x e^{t/2} \sqrt{t} \sin \frac{t}{2} dt + 4e^{-x/2} \sin \frac{x}{2} \int_{x_0}^x e^{t/2} \sqrt{t} \cos \frac{t}{2} dt.$$

17. The auxiliary equation is  $3m^2 - 6m + 6 = 0$ , so  $y_c = e^x(c_1 \cos x + c_2 \sin x)$  and

$$W = \begin{vmatrix} e^x \cos x & e^x \sin x \\ e^x \cos x - e^x \sin x & e^x \cos x + e^x \sin x \end{vmatrix} = e^{2x}.$$

Identifying  $f(x) = \frac{1}{3}e^x \sec x$  we obtain

$$u_1' = -\frac{(e^x \sin x)(e^x \sec x)/3}{e^{2x}} = -\frac{1}{3} \tan x$$

$$u_2' = \frac{(e^x \cos x)(e^x \sec x)/3}{e^{2x}} = \frac{1}{3}.$$

Then  $u_1 = \frac{1}{3} \ln(\cos x)$ ,  $u_2 = \frac{1}{3}x$ , and

$$y = c_1 e^x \cos x + c_2 e^x \cos x + \frac{1}{3} \ln(\cos x) e^x \cos x + \frac{1}{3} x e^x \sin x.$$

18. The auxiliary equation is  $4m^2 - 4m + 1 = (2m - 1)^2 = 0$ , so  $y_c = c_1 e^{x/2} + c_2 x e^{x/2}$  and

$$W = \begin{vmatrix} e^{x/2} & x e^{x/2} \\ \frac{1}{2} e^{x/2} & \frac{1}{2} x e^{x/2} + e^{x/2} \end{vmatrix} = e^x.$$

Identifying  $f(x) = \frac{1}{4}e^{x/2} \sqrt{1-x^2}$  we obtain

$$u_1' = -\frac{x e^{x/2} e^{x/2} \sqrt{1-x^2}}{4e^x} = -\frac{1}{4} x \sqrt{1-x^2}$$

$$u_2' = \frac{e^{x/2} e^{x/2} \sqrt{1-x^2}}{4e^x} = \frac{1}{4} \sqrt{1-x^2}.$$

### Exercises 4.6

Then

$$u_1 = \frac{1}{12} (1 - x^2)^{3/2}$$

$$u_2 = \frac{x}{8} \sqrt{1 - x^2} + \frac{1}{8} \sin^{-1} x$$

and

$$y = c_1 e^{x/2} + c_2 x e^{x/2} + \frac{1}{12} e^{x/2} (1 - x^2)^{3/2} + \frac{1}{8} x^2 e^{x/2} \sqrt{1 - x^2} + \frac{1}{8} x e^{x/2} \sin^{-1} x.$$

19. The auxiliary equation is  $4m^2 - 1 = (2m - 1)(2m + 1) = 0$ , so  $y_c = c_1 e^{x/2} + c_2 e^{-x/2}$  and

$$W = \begin{vmatrix} e^{x/2} & e^{-x/2} \\ \frac{1}{2} e^{x/2} & -\frac{1}{2} e^{-x/2} \end{vmatrix} = -1.$$

Identifying  $f(x) = x e^{x/2}/4$  we obtain  $u'_1 = x/4$  and  $u'_2 = -x e^x/4$ . Then  $u_1 = x^2/8$  and  $u_2 = -x e^x/4 + e^x/4$ . Thus

$$\begin{aligned} y &= c_1 e^{x/2} + c_2 e^{-x/2} + \frac{1}{8} x^2 e^{x/2} - \frac{1}{4} x e^{x/2} + \frac{1}{4} e^{x/2} \\ &= c_3 e^{x/2} + c_2 e^{-x/2} + \frac{1}{8} x^2 e^{x/2} - \frac{1}{4} x e^{x/2} \end{aligned}$$

and

$$y' = \frac{1}{2} c_3 e^{x/2} - \frac{1}{2} c_2 e^{-x/2} + \frac{1}{16} x^2 e^{x/2} + \frac{1}{8} x e^{x/2} - \frac{1}{4} e^{x/2}.$$

The initial conditions imply

$$c_3 + c_2 = 1$$

$$\frac{1}{2} c_3 - \frac{1}{2} c_2 - \frac{1}{4} = 0.$$

Thus  $c_3 = 3/4$  and  $c_2 = 1/4$ , and

$$y = \frac{3}{4} e^{x/2} + \frac{1}{4} e^{-x/2} + \frac{1}{8} x^2 e^{x/2} - \frac{1}{4} x e^{x/2}.$$

20. The auxiliary equation is  $2m^2 + m - 1 = (2m - 1)(m + 1) = 0$ , so  $y_c = c_1 e^{x/2} + c_2 e^{-x}$  and

$$W = \begin{vmatrix} e^{x/2} & e^{-x} \\ \frac{1}{2} e^{x/2} & -e^{-x} \end{vmatrix} = -\frac{3}{2} e^{-x/2}.$$

Identifying  $f(x) = (x + 1)/2$  we obtain

$$u'_1 = \frac{1}{3} e^{-x/2} (x + 1)$$

$$u'_2 = -\frac{1}{3} e^x (x + 1).$$

Then

$$u_1 = -e^{-x/2} \left( \frac{2}{3}x - 2 \right)$$

$$u_2 = -\frac{1}{3}xe^x.$$

Thus

$$y = c_1e^{x/2} + c_2e^{-x} - x - 2$$

and

$$y' = \frac{1}{2}c_1e^{x/2} - c_2e^{-x} - 1.$$

The initial conditions imply

$$c_1 - c_2 - 2 = 1$$

$$\frac{1}{2}c_1 - c_2 - 1 = 0.$$

Thus  $c_1 = 8/3$  and  $c_2 = 1/3$ , and

$$y = \frac{8}{3}e^{x/2} + \frac{1}{3}e^{-x} - x - 2.$$

21. The auxiliary equation is  $m^2 + 2m - 8 = (m - 2)(m + 4) = 0$ , so  $y_c = c_1e^{2x} + c_2e^{-4x}$  and

$$W = \begin{vmatrix} e^{2x} & e^{-4x} \\ 2e^{2x} & -4e^{-4x} \end{vmatrix} = -6e^{-2x}.$$

Identifying  $f(x) = 2e^{-2x} - e^{-x}$  we obtain

$$u_1' = \frac{1}{3}e^{-4x} - \frac{1}{6}e^{-3x}$$

$$u_2' = -\frac{1}{6}e^{3x} - \frac{1}{3}e^{2x}.$$

Then

$$u_1 = -\frac{1}{12}e^{-4x} + \frac{1}{18}e^{-3x}$$

$$u_2 = \frac{1}{18}e^{3x} - \frac{1}{6}e^{2x}.$$

Thus

$$y = c_1e^{2x} + c_2e^{-4x} - \frac{1}{12}e^{-2x} + \frac{1}{18}e^{-x} + \frac{1}{18}e^{-x} - \frac{1}{6}e^{-2x}$$

$$= c_1e^{2x} + c_2e^{-4x} - \frac{1}{4}e^{-2x} + \frac{1}{9}e^{-x}$$

and

$$y' = 2c_1e^{2x} - 4c_2e^{-4x} + \frac{1}{2}e^{-2x} - \frac{1}{9}e^{-x}.$$

### Exercises 4.6

The initial conditions imply

$$\begin{aligned}c_1 + c_2 - \frac{5}{36} &= 1 \\ 2c_1 - 4c_2 + \frac{7}{18} &= 0.\end{aligned}$$

Thus  $c_1 = 25/36$  and  $c_2 = 4/9$ , and

$$y = \frac{25}{36}e^{2x} + \frac{4}{9}e^{-4x} - \frac{1}{4}e^{-2x} + \frac{1}{9}e^{-x}.$$

22. The auxiliary equation is  $m^2 - 4m + 4 = (m - 2)^2 = 0$ , so  $y_c = c_1e^{2x} + c_2xe^{2x}$  and

$$W = \begin{vmatrix} e^{2x} & xe^{2x} \\ 2e^{2x} & 2xe^{2x} + e^{2x} \end{vmatrix} = e^{4x}.$$

Identifying  $f(x) = (12x^2 - 6x)e^{2x}$  we obtain

$$u_1' = 6x^2 - 12x^3$$

$$u_2' = 12x^2 - 6x.$$

Then

$$u_1 = 2x^3 - 3x^4$$

$$u_2 = 4x^3 - 3x^2.$$

Thus

$$\begin{aligned}y &= c_1e^{2x} + c_2xe^{2x} + (2x^3 - 3x^4)e^{2x} + (4x^3 - 3x^2)xe^{2x} \\ &= c_1e^{2x} + c_2xe^{2x} + e^{2x}(x^4 - x^3)\end{aligned}$$

and

$$y' = 2c_1e^{2x} + c_2(2xe^{2x} + e^{2x}) + e^{2x}(4x^3 - 3x^2) + 2e^{2x}(x^4 - x^3).$$

The initial conditions imply

$$c_1 = 1$$

$$2c_1 + c_2 = 0.$$

Thus  $c_1 = 1$  and  $c_2 = -2$ , and

$$y = e^{2x} - 2xe^{2x} + e^{2x}(x^4 - x^3) = e^{2x}(x^4 - x^3 - 2x + 1).$$

23. Write the equation in the form

$$y'' + \frac{1}{x}y' + \left(1 - \frac{1}{4x^2}\right)y = x^{-1/2}$$

and identify  $f(x) = x^{-1/2}$ . From  $y_1 = x^{-1/2} \cos x$  and  $y_2 = x^{-1/2} \sin x$  we compute

Exercises 4.6

$$W(y_1, y_2) = \begin{vmatrix} x^{-1/2} \cos x & x^{-1/2} \sin x \\ -x^{-1/2} \sin x - \frac{1}{2}x^{-3/2} \cos x & x^{-1/2} \cos x - \frac{1}{2}x^{-3/2} \sin x \end{vmatrix} = \frac{1}{x}.$$

Now

$$u_1' = \sin x \quad \text{so} \quad u_1 = \cos x,$$

and

$$u_2' = \cos x \quad \text{so} \quad u_2 = \sin x.$$

Thus

$$\begin{aligned} y &= c_1 x^{-1/2} \cos x + c_2 x^{-1/2} \sin x + x^{-1/2} \cos^2 x + x^{-1/2} \sin^2 x \\ &= c_1 x^{-1/2} \cos x + c_2 x^{-1/2} \sin x + x^{-1/2}. \end{aligned}$$

24. Write the equation in the form

$$y'' + \frac{1}{x}y' + \frac{1}{x^2}y = \frac{\sec(\ln x)}{x^2}$$

and identify  $f(x) = \sec(\ln x)/x^2$ . From  $y_1 = \cos(\ln x)$  and  $y_2 = \sin(\ln x)$  we compute

$$W = \begin{vmatrix} \cos(\ln x) & \sin(\ln x) \\ -\frac{\sin(\ln x)}{x} & \frac{\cos(\ln x)}{x} \end{vmatrix} = \frac{1}{x}.$$

Now

$$u_1' = -\frac{\tan(\ln x)}{x} \quad \text{so} \quad u_1 = \ln |\cos(\ln x)|,$$

and

$$u_2' = \frac{1}{x} \quad \text{so} \quad u_2 = \ln x.$$

Thus, a particular solution is

$$y_p = \cos(\ln x) \ln |\cos(\ln x)| + (\ln x) \sin(\ln x).$$

25. The auxiliary equation is  $m^3 + m = m(m^2 + 1) = 0$ , so  $y_c = c_1 + c_2 \cos x + c_3 \sin x$  and

$$W = \begin{vmatrix} 1 & \cos x & \sin x \\ 0 & -\sin x & \cos x \\ 0 & -\cos x & -\sin x \end{vmatrix} = 1.$$

### Exercises 4.6

Identifying  $f(x) = \tan x$  we obtain

$$u'_1 = W_1 = \begin{vmatrix} 0 & \cos x & \sin x \\ 0 & -\sin x & \cos x \\ \tan x & -\cos x & -\sin x \end{vmatrix} = \tan x$$

$$u'_2 = W_2 = \begin{vmatrix} 1 & 0 & \sin x \\ 0 & 0 & \cos x \\ 0 & \tan x & -\sin x \end{vmatrix} = -\sin x$$

$$u'_3 = W_3 = \begin{vmatrix} 1 & \cos x & 0 \\ 0 & -\sin x & 0 \\ 0 & -\cos x & \tan x \end{vmatrix} = -\sin x \tan x = \frac{\cos^2 x - 1}{\cos x} = \cos x - \sec x.$$

Then

$$u_1 = -\ln |\cos x|$$

$$u_2 = \cos x$$

$$u_3 = \sin x - \ln |\sec x + \tan x|$$

and

$$\begin{aligned} y &= c_1 + c_2 \cos x + c_3 \sin x - \ln |\cos x| + \cos^2 x \\ &\quad + \sin^2 x - \sin x \ln |\sec x + \tan x| \\ &= c_4 + c_2 \cos x + c_3 \sin x - \ln |\cos x| - \sin x \ln |\sec x + \tan x| \end{aligned}$$

for  $-\infty < x < \infty$ .

26. The auxiliary equation is  $m^3 + 4m = m(m^2 + 4) = 0$ , so  $y_c = c_1 + c_2 \cos 2x + c_3 \sin 2x$  and

$$W = \begin{vmatrix} 1 & \cos 2x & \sin 2x \\ 0 & -2 \sin 2x & 2 \cos 2x \\ 0 & -4 \cos 2x & -4 \sin 2x \end{vmatrix} = 8.$$



Identifying  $f(x) = \sec 2x$  we obtain

$$u'_1 = \frac{1}{8}W_1 = \frac{1}{8} \begin{vmatrix} 0 & \cos 2x & \sin 2x \\ 0 & -2 \sin 2x & 2 \cos 2x \\ \sec 2x & -4 \cos 2x & -4 \sin 2x \end{vmatrix} = \frac{1}{4} \sec 2x$$

$$u'_2 = \frac{1}{8}W_2 = \frac{1}{8} \begin{vmatrix} 1 & 0 & \sin 2x \\ 0 & 0 & 2 \cos 2x \\ 0 & \sec 2x & -4 \sin 2x \end{vmatrix} = -\frac{1}{4}$$

$$u'_3 = \frac{1}{8}W_3 = \frac{1}{8} \begin{vmatrix} 1 & \cos 2x & 0 \\ 0 & -2 \sin 2x & 0 \\ 0 & -4 \cos 2x & \sec 2x \end{vmatrix} = -\frac{1}{4} \tan 2x.$$

Then

$$u_1 = \frac{1}{8} \ln |\sec 2x + \tan 2x|$$

$$u_2 = -\frac{1}{4}x$$

$$u_3 = \frac{1}{8} \ln |\cos 2x|$$

and

$$y = c_1 + c_2 \cos 2x + c_3 \sin 2x + \frac{1}{8} \ln |\sec 2x + \tan 2x| - \frac{1}{4}x \cos 2x + \frac{1}{8} \sin 2x \ln |\cos 2x|$$

for  $-\pi/4 < x < \pi/4$ .

27. The auxiliary equation is  $3m^2 - 6m + 30 = 0$ , which has roots  $1 + 3i$ , so  $y_c = e^x(c_1 \cos 3x + c_2 \sin 3x)$ . We consider first the differential equation  $3y'' - 6y' + 30y = 15 \sin x$ , which can be solved using undetermined coefficients. Letting  $y_{p1} = A \cos x + B \sin x$  and substituting into the differential equation we get

$$(27A - 6B) \cos x + (6A + 27B) \sin x = 15 \sin x.$$

Then

$$27A - 6B = 0 \quad \text{and} \quad 6A + 27B = 15,$$

so  $A = \frac{2}{17}$  and  $B = \frac{9}{17}$ . Thus,  $y_{p1} = \frac{2}{17} \cos x + \frac{9}{17} \sin x$ . Next, we consider the differential equation  $3y'' - 6y' + 30y$ , for which a particular solution  $y_{p2}$  can be found using variation of parameters. The Wronskian is

$$W = \begin{vmatrix} e^x \cos 3x & e^x \sin 3x \\ e^x \cos 3x - 3e^x \sin 3x & 3e^x \cos 3x + e^x \sin 3x \end{vmatrix} = 3e^{2x}.$$

Identifying  $f(x) = \frac{1}{3}e^x \tan x$  we obtain

$$u'_1 = -\frac{1}{9} \sin 3x \tan 3x \quad \text{and} \quad u'_2 = \frac{1}{9} \sin 3x.$$

### Exercises 4.6

Then

$$u_1 = \frac{1}{27} \sin 3x + \frac{1}{27} \left[ \ln \left( \cos \frac{3x}{2} - \sin \frac{3x}{2} \right) - \ln \left( \cos \frac{3x}{2} + \sin \frac{3x}{2} \right) \right]$$

$$u_2 = -\frac{1}{27} \cos 3x.$$

Thus

$$y_{p2} = \frac{1}{27} e^x \cos 3x \left[ \ln \left( \cos \frac{3x}{2} - \sin \frac{3x}{2} \right) - \ln \left( \cos \frac{3x}{2} + \sin \frac{3x}{2} \right) \right]$$

and the general solution of the original differential equation is

$$y = e^x (c_1 \cos 3x + c_2 \sin 3x) + y_{p1}(x) + y_{p2}(x).$$

28. The auxiliary equation is  $m^2 - 2m + 1 = (m-1)^2 = 0$ , which has repeated root 1, so  $y_c = c_1 e^x + c_2 x e^x$ . We consider first the differential equation  $y'' - 2y' + y = 4x^2 - 3$ , which can be solved using undetermined coefficients. Letting  $y_{p1} = Ax^2 + Bx + C$  and substituting into the differential equation we get

$$Ax^2 + (-4A + B)x + (2A - 2B + C) = 4x^2 - 3.$$

Then

$$A = 4, \quad -4A + B = 0, \quad \text{and} \quad 2A - 2B + C = -3,$$

so  $A = 4$ ,  $B = 16$ , and  $C = 21$ . Thus,  $y_{p1} = 4x^2 + 16x + 21$ . Next we consider the differential equation  $y'' - 2y' + y = x^{-1}e^x$ , for which a particular solution  $y_{p2}$  can be found using variation of parameters. The Wronskian is

$$W = \begin{vmatrix} e^x & x e^x \\ e^x & x e^x + e^x \end{vmatrix} = e^{2x}.$$

Identifying  $f(x) = e^x/x$  we obtain  $u_1' = -1$  and  $u_2' = 1/x$ . Then  $u_1 = -x$  and  $u_2 = \ln x$ , so that

$$y_{p2} = -x e^x + x e^x \ln x,$$

and the general solution of the original differential equation is

$$y = y_c + y_{p1} + y_{p2} = c_1 e^x + c_2 x e^x + 4x^2 + 16x + 21 - x e^x + x e^x \ln x.$$

29. The interval of definition for Problem 1 is  $(-\pi/2, \pi/2)$ , for Problem 7 is  $(-\infty, \infty)$ , for Problem 9 is  $(0, \infty)$ , and for Problem 18 is  $(-1, 1)$ . In Problem 24 the general solution is

$$y = c_1 \cos(\ln x) + c_2 \sin(\ln x) + \cos(\ln x) \ln |\cos(\ln x)| + (\ln x) \sin(\ln x)$$

for  $-\pi/2 < \ln x < \pi/2$  or  $e^{-\pi/2} < x < e^{\pi/2}$ . The bounds on  $\ln x$  are due to the presence of  $\sec(\ln x)$  in the differential equation.

30. We are given that  $y_1 = x^2$  is a solution of  $x^4 y'' + x^3 y' - 4x^2 y = 0$ . To find a second solution we use reduction of order. Let  $y = x^2 u(x)$ . Then the product rule gives

$$y' = x^2 u' + 2xu \quad \text{and} \quad y'' = x^2 u'' + 4xu' + 2u,$$

so

$$x^4 y'' + x^3 y' - 4x^2 y = x^5(xu'' + 5u') = 0.$$

Letting  $w = u'$ , this becomes  $xw' + 5w = 0$ . Separating variables and integrating we have

$$\frac{dw}{w} = -\frac{5}{x} dx \quad \text{and} \quad \ln|w| = -5 \ln x + c.$$

Thus,  $w = x^{-5}$  and  $u = -\frac{1}{4}x^{-4}$ . A second solution is then  $y_2 = x^2 x^{-4} = 1/x^2$ , and the general solution of the homogeneous differential equation is  $y_c = c_1 x^2 + c_2/x^2$ . To find a particular solution,  $y_p$ , we use variation of parameters. The Wronskian is

$$W = \begin{vmatrix} x^2 & 1/x^2 \\ 2x & -2/x^3 \end{vmatrix} = -\frac{4}{x}.$$

Identifying  $f(x) = 1/x^4$  we obtain  $u'_1 = \frac{1}{4}x^{-5}$  and  $u'_2 = -\frac{1}{4}x^{-1}$ . Then  $u_1 = -\frac{1}{16}x^{-4}$  and  $u_2 = -\frac{1}{4} \ln x$ , so

$$y_p = -\frac{1}{16}x^{-4}x^2 - \frac{1}{4}(\ln x)x^{-2} = -\frac{1}{16}x^{-2} - \frac{1}{4}x^{-2} \ln x.$$

The general solution is

$$y = c_1 x^2 + \frac{c_2}{x^2} - \frac{1}{16x^2} - \frac{1}{4x^2} \ln x.$$

---

## Exercises 4.7

---

1. The auxiliary equation is  $m^2 - m - 2 = (m + 1)(m - 2) = 0$  so that  $y = c_1 x^{-1} + c_2 x^2$ .
2. The auxiliary equation is  $4m^2 - 4m + 1 = (2m - 1)^2 = 0$  so that  $y = c_1 x^{1/2} + c_2 x^{1/2} \ln x$ .
3. The auxiliary equation is  $m^2 = 0$  so that  $y = c_1 + c_2 \ln x$ .
4. The auxiliary equation is  $m^2 - 4m = m(m - 4) = 0$  so that  $y = c_1 + c_2 x^4$ .
5. The auxiliary equation is  $m^2 + 4 = 0$  so that  $y = c_1 \cos(2 \ln x) + c_2 \sin(2 \ln x)$ .
6. The auxiliary equation is  $m^2 + 4m + 3 = (m + 1)(m + 3) = 0$  so that  $y = c_1 x^{-1} + c_2 x^{-3}$ .
7. The auxiliary equation is  $m^2 - 4m - 2 = 0$  so that  $y = c_1 x^{2-\sqrt{6}} + c_2 x^{2+\sqrt{6}}$ .
8. The auxiliary equation is  $m^2 + 2m - 4 = 0$  so that  $y = c_1 x^{-1+\sqrt{5}} + c_2 x^{-1-\sqrt{5}}$ .
9. The auxiliary equation is  $25m^2 + 1 = 0$  so that  $y = c_1 \cos\left(\frac{1}{5} \ln x\right) + c_2 \left(\frac{1}{5} \ln x\right)$ .
10. The auxiliary equation is  $4m^2 - 1 = (2m - 1)(2m + 1) = 0$  so that  $y = c_1 x^{1/2} + c_2 x^{-1/2}$ .
11. The auxiliary equation is  $m^2 + 4m + 4 = (m + 2)^2 = 0$  so that  $y = c_1 x^{-2} + c_2 x^{-2} \ln x$ .
12. The auxiliary equation is  $m^2 + 7m + 6 = (m + 1)(m + 6) = 0$  so that  $y = c_1 x^{-1} + c_2 x^{-6}$ .
13. The auxiliary equation is  $3m^2 + 3m + 1 = 0$  so that  $y = x^{-1/2} \left[ c_1 \cos\left(\frac{\sqrt{3}}{6} \ln x\right) + c_2 \sin\left(\frac{\sqrt{3}}{6} \ln x\right) \right]$ .

### Exercises 4.7

14. The auxiliary equation is  $m^2 - 8m + 41 = 0$  so that  $y = x^4 [c_1 \cos(5 \ln x) + c_2 \sin(5 \ln x)]$ .

15. Assuming that  $y = x^m$  and substituting into the differential equation we obtain

$$m(m-1)(m-2) - 6 = m^3 - 3m^2 + 2m - 6 = (m-3)(m^2 + 2) = 0.$$

Thus

$$y = c_1 x^3 + c_2 \cos(\sqrt{2} \ln x) + c_3 \sin(\sqrt{2} \ln x).$$

16. Assuming that  $y = x^m$  and substituting into the differential equation we obtain

$$m(m-1)(m-2) + m - 1 = m^3 - 3m^2 + 3m - 1 = (m-1)^3 = 0.$$

Thus

$$y = c_1 x + c_2 x \ln x + c_3 x (\ln x)^2.$$

17. Assuming that  $y = x^m$  and substituting into the differential equation we obtain

$$m(m-1)(m-2)(m-3) + 6m(m-1)(m-2) = m^4 - 7m^2 + 6m = m(m-1)(m-2)(m+3) = 0.$$

Thus

$$y = c_1 + c_2 x + c_3 x^2 + c_4 x^{-3}.$$

18. Assuming that  $y = x^m$  and substituting into the differential equation we obtain

$$m(m-1)(m-2)(m-3) + 6m(m-1)(m-2) + 9m(m-1) + 3m + 1 = m^4 + 2m^2 + 1 = (m^2 + 1)^2 = 0.$$

Thus

$$y = c_1 \cos(\ln x) + c_2 \sin(\ln x) + c_3 \ln x \cos(\ln x) + c_4 \ln x \sin(\ln x).$$

19. The auxiliary equation is  $m^2 - 5m = m(m-5) = 0$  so that  $y_c = c_1 + c_2 x^5$  and

$$W(1, x^5) = \begin{vmatrix} 1 & x^5 \\ 0 & 5x^4 \end{vmatrix} = 5x^4.$$

Identifying  $f(x) = x^3$  we obtain  $u'_1 = -\frac{1}{5}x^4$  and  $u'_2 = 1/5x$ . Then  $u_1 = -\frac{1}{25}x^5$ ,  $u_2 = \frac{1}{5} \ln x$ , and

$$y = c_1 + c_2 x^5 - \frac{1}{25}x^5 + \frac{1}{5}x^5 \ln x = c_1 + c_3 x^5 + \frac{1}{5}x^5 \ln x.$$

20. The auxiliary equation is  $2m^2 + 3m + 1 = (2m+1)(m+1) = 0$  so that  $y_c = c_1 x^{-1} + c_2 x^{-1/2}$  and

$$W(x^{-1}, x^{-1/2}) = \begin{vmatrix} x^{-1} & x^{-1/2} \\ -x^{-2} & -\frac{1}{2}x^{-3/2} \end{vmatrix} = \frac{1}{2}x^{-5/2}.$$

Identifying  $f(x) = \frac{1}{2} - \frac{1}{2x}$  we obtain  $u'_1 = x - x^2$  and  $u'_2 = x^{3/2} - x^{1/2}$ . Then  $u_1 = \frac{1}{2}x^2 - \frac{1}{3}x^3$ ,  $u_2 = \frac{2}{5}x^{5/2} - \frac{2}{3}x^{3/2}$ , and

$$y = c_1 x^{-1} + c_2 x^{-1/2} + \frac{1}{2}x - \frac{1}{3}x^2 + \frac{2}{5}x^2 - \frac{2}{3}x = c_1 x^{-1} + c_2 x^{-1/2} - \frac{1}{6}x + \frac{1}{15}x^2.$$

Exercises 4.7

21. The auxiliary equation is  $m^2 - 2m + 1 = (m - 1)^2 = 0$  so that  $y_c = c_1x + c_2x \ln x$  and

$$W(x, x \ln x) = \begin{vmatrix} x & x \ln x \\ 1 & 1 + \ln x \end{vmatrix} = x.$$

Identifying  $f(x) = 2/x$  we obtain  $u_1' = -2 \ln x/x$  and  $u_2' = 2/x$ . Then  $u_1 = -(\ln x)^2$ ,  $u_2 = 2 \ln x$ , and

$$\begin{aligned} y &= c_1x + c_2x \ln x - x(\ln x)^2 + 2x(\ln x)^2 \\ &= c_1x + c_2x \ln x + x(\ln x)^2. \end{aligned}$$

22. The auxiliary equation is  $m^2 - 3m + 2 = (m - 1)(m - 2) = 0$  so that  $y_c = c_1x + c_2x^2$  and

$$W(x, x^2) = \begin{vmatrix} x & x^2 \\ 1 & 2x \end{vmatrix} = x^2.$$

Identifying  $f(x) = x^2e^x$  we obtain  $u_1' = -x^2e^x$  and  $u_2' = xe^x$ . Then  $u_1 = -x^2e^x + 2xe^x - 2e^x$ ,  $u_2 = xe^x - e^x$ , and

$$\begin{aligned} y &= c_1x + c_2x^2 - x^3e^x + 2x^2e^x - 2xe^x + x^3e^x - x^2e^x \\ &= c_1x + c_2x^2 + x^2e^x - 2xe^x. \end{aligned}$$

23. The auxiliary equation is  $m^2 + 2m = m(m + 2) = 0$ , so that

$$y = c_1 + c_2x^{-2} \quad \text{and} \quad y' = -2c_2x^{-3}.$$

The initial conditions imply

$$c_1 + c_2 = 0$$

$$-2c_2 = 4.$$

Thus,  $c_1 = 2$ ,  $c_2 = -2$ , and  $y = 2 - 2x^{-2}$ .

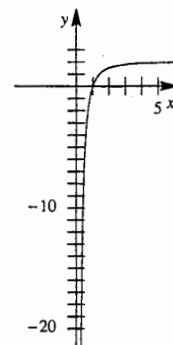

24. The auxiliary equation is  $m^2 - 6m + 8 = (m - 2)(m - 4) = 0$ , so that

$$y = c_1x^2 + c_2x^4 \quad \text{and} \quad y' = 2c_1x + 4c_2x^3.$$

The initial conditions imply

$$4c_1 + 16c_2 = 32$$

$$4c_1 + 32c_2 = 0.$$

Thus,  $c_1 = 16$ ,  $c_2 = -2$ , and  $y = 16x^2 - 2x^4$ .

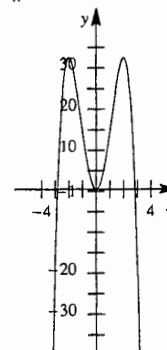

### Exercises 4.7

25. The auxiliary equation is  $m^2 + 1 = 0$ , so that

$$y = c_1 \cos(\ln x) + c_2 \sin(\ln x)$$

and

$$y' = -c_1 \frac{1}{x} \sin(\ln x) + c_2 \frac{1}{x} \cos(\ln x).$$

The initial conditions imply  $c_1 = 1$  and  $c_2 = 2$ . Thus

$$y = \cos(\ln x) + 2 \sin(\ln x).$$

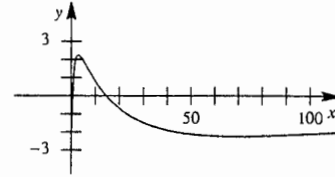

26. The auxiliary equation is  $m^2 - 4m + 4 = (m - 2)^2 = 0$ , so that

$$y = c_1 x^2 + c_2 x^2 \ln x \quad \text{and} \quad y' = 2c_1 x + c_2(x + 2x \ln x).$$

The initial conditions imply  $c_1 = 5$  and  $c_2 + 10 = 3$ . Thus  $y = 5x^2 - 7x^2 \ln x$ .

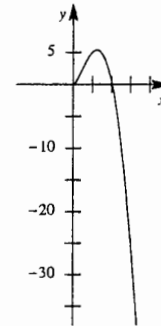

27. The auxiliary equation is  $m^2 = 0$  so that  $y_c = c_1 + c_2 \ln x$  and

$$W(1, \ln x) = \begin{vmatrix} 1 & \ln x \\ 0 & 1/x \end{vmatrix} = \frac{1}{x}.$$

Identifying  $f(x) = 1$  we obtain  $u'_1 = -x \ln x$  and  $u'_2 = x$ . Then

$$u_1 = \frac{1}{4}x^2 - \frac{1}{2}x^2 \ln x, \quad u_2 = \frac{1}{2}x^2, \quad \text{and}$$

$$y = c_1 + c_2 \ln x + \frac{1}{4}x^2 - \frac{1}{2}x^2 \ln x + \frac{1}{2}x^2 \ln x = c_1 + c_2 \ln x + \frac{1}{4}x^2.$$

The initial conditions imply  $c_1 + \frac{1}{4} = 1$  and  $c_2 + \frac{1}{2} = -\frac{1}{2}$ . Thus,  $c_1 = \frac{3}{4}$ ,  $c_2 = -1$ , and  $y = \frac{3}{4} - \ln x + \frac{1}{4}x^2$ .

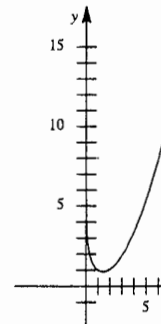

28. The auxiliary equation is  $m^2 - 6m + 8 = (m - 2)(m - 4) = 0$ , so that  $y_c = c_1 x^2 + c_2 x^4$  and

$$W = \begin{vmatrix} x^2 & x^4 \\ 2x & 4x^3 \end{vmatrix} = 2x^5.$$

Identifying  $f(x) = 8x^4$  we obtain  $u'_1 = -4x^3$  and  $u'_2 = 4x$ . Then

$u_1 = -x^4$ ,  $u_2 = 2x^2$ , and  $y = c_1 x^2 + c_2 x^4 + x^6$ . The initial conditions imply

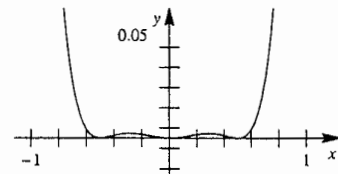

$$\begin{aligned}\frac{1}{4}c_1 + \frac{1}{16}c_2 &= -\frac{1}{64} \\ c_1 + \frac{1}{2}c_2 &= -\frac{3}{16}.\end{aligned}$$

Thus  $c_1 = \frac{1}{16}$ ,  $c_2 = -\frac{1}{2}$ , and  $y = \frac{1}{16}x^2 - \frac{1}{2}x^4 + x^6$ .

29. Substituting into the differential equation we obtain

$$\frac{d^2y}{dt^2} + 8\frac{dy}{dt} - 20y = 0.$$

The auxiliary equation is  $m^2 + 8m - 20 = (m + 10)(m - 2) = 0$  so that

$$y = c_1e^{-10t} + c_2e^{2t} = c_1x^{-10} + c_2x^2.$$

30. Substituting into the differential equation we obtain

$$\frac{d^2y}{dt^2} - 10\frac{dy}{dt} + 25y = 0.$$

The auxiliary equation is  $m^2 - 10m + 25 = (m - 5)^2 = 0$  so that

$$y = c_1e^{5t} + c_2te^{5t} = c_1x^5 + c_2x^5 \ln x.$$

31. Substituting into the differential equation we obtain

$$\frac{d^2y}{dt^2} + 9\frac{dy}{dt} + 8y = e^{2t}.$$

The auxiliary equation is  $m^2 + 9 + 8 = (m + 1)(m + 8) = 0$  so that  $y_c = c_1e^{-t} + c_2e^{-8t}$ . Using undetermined coefficients we try  $y_p = Ae^{2t}$ . This leads to  $30Ae^{2t} = e^{2t}$ , so that  $A = 1/30$  and

$$y = c_1e^{-t} + c_2e^{-8t} + \frac{1}{30}e^{2t} = c_1x^{-1} + c_2x^{-8} + \frac{1}{30}x^2.$$

32. Substituting into the differential equation we obtain

$$\frac{d^2y}{dt^2} - 5\frac{dy}{dt} + 6y = 2t.$$

The auxiliary equation is  $m^2 - 5m + 6 = (m - 2)(m - 3) = 0$  so that  $y_c = c_1e^{2t} + c_2e^{3t}$ . Using undetermined coefficients we try  $y_p = At + B$ . This leads to  $(-5A + 6B) + 6At = 2t$ , so that  $A = 1/3$ ,  $B = 5/18$ , and

$$y = c_1e^{2t} + c_2e^{3t} + \frac{1}{3}t + \frac{5}{18} = c_1x^2 + c_2x^3 + \frac{1}{3}\ln x + \frac{5}{18}.$$

33. Substituting into the differential equation we obtain

$$\frac{d^2y}{dt^2} - 4\frac{dy}{dt} + 13y = 4 + 3e^t.$$

### Exercises 4.7

The auxiliary equation is  $m^2 - 4m + 13 = 0$  so that  $y_c = e^{2t}(c_1 \cos 3t + c_2 \sin 3t)$ . Using undetermined coefficients we try  $y_p = A + Be^t$ . This leads to  $13A + 10Be^t = 4 + 3e^t$ , so that  $A = 4/13$ ,  $B = 3/10$ , and

$$\begin{aligned} y &= e^{2t}(c_1 \cos 3t + c_2 \sin 3t) + \frac{4}{13} + \frac{3}{10}e^t \\ &= x^2 [c_1 \cos(3 \ln x) + c_2 \sin(3 \ln x)] + \frac{4}{13} + \frac{3}{10}x. \end{aligned}$$

34. From

$$\frac{d^2y}{dx^2} = \frac{1}{x^2} \left( \frac{d^2y}{dt^2} - \frac{dy}{dt} \right)$$

it follows that

$$\begin{aligned} \frac{d^3y}{dx^3} &= \frac{1}{x^2} \frac{d}{dx} \left( \frac{d^2y}{dt^2} - \frac{dy}{dt} \right) - \frac{2}{x^3} \left( \frac{d^2y}{dt^2} - \frac{dy}{dt} \right) \\ &= \frac{1}{x^2} \frac{d}{dx} \left( \frac{d^2y}{dt^2} \right) - \frac{1}{x^2} \frac{d}{dx} \left( \frac{dy}{dt} \right) - \frac{2}{x^3} \frac{d^2y}{dt^2} + \frac{2}{x^3} \frac{dy}{dt} \\ &= \frac{1}{x^2} \frac{d^3y}{dt^3} \left( \frac{1}{x} \right) - \frac{1}{x^2} \frac{d^2y}{dt^2} \left( \frac{1}{x} \right) - \frac{2}{x^3} \frac{d^2y}{dt^2} + \frac{2}{x^3} \frac{dy}{dt} \\ &= \frac{1}{x^3} \left( \frac{d^3y}{dt^3} - 3 \frac{d^2y}{dt^2} + 2 \frac{dy}{dt} \right). \end{aligned}$$

Substituting into the differential equation we obtain

$$\frac{d^3y}{dt^3} - 3 \frac{d^2y}{dt^2} + 2 \frac{dy}{dt} - 3 \left( \frac{d^2y}{dt^2} - \frac{dy}{dt} \right) + 6 \frac{dy}{dt} - 6y = 3 + 3t$$

or

$$\frac{d^3y}{dt^3} - 6 \frac{d^2y}{dt^2} + 11 \frac{dy}{dt} - 6y = 3 + 3t.$$

The auxiliary equation is  $m^3 - 6m^2 + 11m - 6 = (m-1)(m-2)(m-3) = 0$  so that  $y_c = c_1e^t + c_2e^{2t} + c_3e^{3t}$ . Using undetermined coefficients we try  $y_p = A + Bt$ . This leads to  $(11B - 6A) - 6Bt = 3 + 3t$ , so that  $A = -17/12$ ,  $B = -1/2$ , and

$$y = c_1e^t + c_2e^{2t} + c_3e^{3t} - \frac{17}{12} - \frac{1}{2}t = c_1x + c_2x^2 + c_3x^3 - \frac{17}{12} - \frac{1}{2} \ln x.$$



## Exercises 4.7

In the next two problems we use the substitution  $t = -x$  since the initial conditions are on the interval  $(-\infty, 0)$ . In this case

$$\frac{dy}{dt} = \frac{dy}{dx} \frac{dx}{dt} = -\frac{dy}{dx}$$

and

$$\frac{d^2y}{dt^2} = \frac{d}{dt} \left( \frac{dy}{dt} \right) = \frac{d}{dt} \left( -\frac{dy}{dx} \right) = -\frac{d}{dt} (y') = -\frac{dy'}{dx} \frac{dx}{dt} = -\frac{d^2y}{dx^2} \frac{dx}{dt} = \frac{d^2y}{dx^2}.$$

35. The differential equation and initial conditions become

$$4t^2 \frac{d^2y}{dt^2} + y = 0; \quad y(t) \Big|_{t=1} = 2, \quad y'(t) \Big|_{t=1} = -4.$$

The auxiliary equation is  $4m^2 - 4m + 1 = (2m - 1)^2 = 0$ , so that

$$y = c_1 t^{1/2} + c_2 t^{1/2} \ln t \quad \text{and} \quad y' = \frac{1}{2} c_1 t^{-1/2} + c_2 \left( t^{-1/2} + \frac{1}{2} t^{-1/2} \ln t \right).$$

The initial conditions imply  $c_1 = 2$  and  $1 + c_2 = -4$ . Thus

$$y = 2t^{1/2} - 5t^{1/2} \ln t = 2(-x)^{1/2} - 5(-x)^{1/2} \ln(-x), \quad x < 0.$$

36. The differential equation and initial conditions become

$$t^2 \frac{d^2y}{dt^2} - 4t \frac{dy}{dt} + 6y = 0; \quad y(t) \Big|_{t=2} = 8, \quad y'(t) \Big|_{t=2} = 0.$$

The auxiliary equation is  $m^2 - 5m + 6 = (m - 2)(m - 3) = 0$ , so that

$$y = c_1 t^2 + c_2 t^3 \quad \text{and} \quad y' = 2c_1 t + 3c_2 t^2.$$

The initial conditions imply

$$4c_1 + 8c_2 = 8$$

$$4c_1 + 12c_2 = 0$$

from which we find  $c_1 = 6$  and  $c_2 = -2$ . Thus

$$y = 6t^2 - 2t^3 = 6x^2 + 2x^3, \quad x < 0.$$

37. Letting  $u = x + 2$  we obtain  $\frac{dy}{dx} = \frac{dy}{du}$  and, using the chain rule,

$$\frac{d^2y}{dx^2} = \frac{d}{dx} \left( \frac{dy}{du} \right) = \frac{d^2y}{du^2} \frac{du}{dx} = \frac{d^2y}{du^2} (1) = \frac{d^2y}{du^2}.$$

Substituting into the differential equation we obtain

$$u^2 \frac{d^2y}{du^2} + u \frac{dy}{du} + y = 0.$$

The auxiliary equation is  $m^2 + 1 = 0$  so that

$$y = c_1 \cos(\ln u) + c_2 \sin(\ln u) = c_1 \cos[\ln(x + 2)] + c_2 \sin[\ln(x + 2)].$$

### Exercises 4.7

38. If  $1 - i$  is a root of the auxiliary equation then so is  $1 + i$ , and the auxiliary equation is

$$(m - 2)[m - (1 + i)][m - (1 - i)] = m^3 - 4m^2 + 6m - 4 = 0.$$

We need  $m^3 - 4m^2 + 6m - 4$  to have the form  $m(m - 1)(m - 2) + bm(m - 1) + cm + d$ . Expanding this last expression and equating coefficients we get  $b = -1$ ,  $c = 3$ , and  $d = -4$ . Thus, the differential equation is

$$x^3 y''' - x^2 y'' + 3xy' - 4y = 0.$$

39. For  $x^2 y'' = 0$  the auxiliary equation is  $m(m - 1) = 0$  and the general solution is  $y = c_1 + c_2 x$ . The initial conditions imply  $c_1 = y_0$  and  $c_2 = y_1$ , so  $y = y_0 + y_1 x$ . The initial conditions are satisfied for all real values of  $y_0$  and  $y_1$ .

For  $x^2 y'' - 2xy' + 2y = 0$  the auxiliary equation is  $m^2 - 3m + 2 = (m - 1)(m - 2) = 0$  and the general solution is  $y = c_1 x + c_2 x^2$ . The initial condition  $y(0) = y_0$  implies  $0 = y_0$  and the condition  $y'(0) = y_1$  implies  $c_1 = y_1$ . Thus, the initial conditions are satisfied for  $y_0 = 0$  and for all real values of  $y_1$ .

For  $x^2 y'' - 4xy' + 6y = 0$  the auxiliary equation is  $m^2 - 5m + 6 = (m - 2)(m - 3) = 0$  and the general solution is  $y = c_1 x^2 + c_2 x^3$ . The initial conditions imply  $y(0) = 0 = y_0$  and  $y'(0) = 0$ . Thus, the initial conditions are satisfied only for  $y_0 = y_1 = 0$ .

40. The function  $y(x) = -\sqrt{x} \cos(\ln x)$  is defined for  $x > 0$  and has  $x$ -intercepts where  $\ln x = \pi/2 + k\pi$  for  $k$  an integer or where  $x = e^{\pi/2+k\pi}$ . Solving  $\pi/2 + k\pi = 0.5$  we get  $k \approx -0.34$ , so  $e^{\pi/2+k\pi} < 0.5$  for all negative integers and the graph has infinitely many  $x$ -intercepts in  $(0, 0.5)$ .

41. The auxiliary equation is  $2m(m - 1)(m - 2) - 10.98m(m - 1) + 8.5m + 1.3 = 0$ , so that  $m_1 = -0.053299$ ,  $m_2 = 1.81164$ ,  $m_3 = 6.73166$ , and

$$y = c_1 x^{-0.053299} + c_2 x^{1.81164} + c_3 x^{6.73166}.$$

42. The auxiliary equation is  $m(m - 1)(m - 2) + 4m(m - 1) + 5m - 9 = 0$ , so that  $m_1 = 1.40819$  and the two complex roots are  $-1.20409 \pm 2.22291i$ . The general solution of the differential equation is

$$y = c_1 x^{1.40819} + x^{-1.20409} [c_2 \cos(2.22291 \ln x) + c_3 \sin(2.22291 \ln x)].$$

43. The auxiliary equation is  $m(m - 1)(m - 2)(m - 3) + 6m(m - 1)(m - 2) + 3m(m - 1) - 3m + 4 = 0$ , so that  $m_1 = m_2 = \sqrt{2}$  and  $m_3 = m_4 = -\sqrt{2}$ . The general solution of the differential equation is

$$y = c_1 x^{\sqrt{2}} + c_2 x^{\sqrt{2}} \ln x + c_3 x^{-\sqrt{2}} + c_4 x^{-\sqrt{2}} \ln x.$$

44. The auxiliary equation is  $m(m - 1)(m - 2)(m - 3) - 6m(m - 1)(m - 2) + 33m(m - 1) - 105m + 169 = 0$ , so that  $m_1 = m_2 = 3 + 2i$  and  $m_3 = m_4 = 3 - 2i$ . The general solution of the differential equation is

$$y = x^3 [c_1 \cos(2 \ln x) + c_2 \sin(2 \ln x)] + x^3 \ln x [c_3 \cos(2 \ln x) + c_4 \sin(2 \ln x)].$$

---

**Exercises 4.8**

---

1. From  $Dx = 2x - y$  and  $Dy = x$  we obtain  $y = 2x - Dx$ ,  $Dy = 2Dx - D^2x$ , and  $(D^2 - 2D + 1)x = 0$ . Then

$$x = c_1 e^t + c_2 t e^t \quad \text{and} \quad y = (c_1 - c_2)e^t + c_2 t e^t.$$

2. From  $Dx = 4x + 7y$  and  $Dy = x - 2y$  we obtain  $y = \frac{1}{7}Dx - \frac{4}{7}x$ ,  $Dy = \frac{1}{7}D^2x - \frac{4}{7}Dx$ , and  $(D^2 - 2D - 15)x = 0$ . Then

$$x = c_1 e^{5t} + c_2 e^{-3t} \quad \text{and} \quad y = \frac{1}{7}c_1 e^{5t} - c_2 e^{-3t}.$$

3. From  $Dx = -y + t$  and  $Dy = x - t$  we obtain  $y = t - Dx$ ,  $Dy = 1 - D^2x$ , and  $(D^2 + 1)x = 1 + t$ . Then

$$x = c_1 \cos t + c_2 \sin t + 1 + t$$

and

$$y = c_1 \sin t - c_2 \cos t + t - 1.$$

4. From  $Dx - 4y = 1$  and  $x + Dy = 2$  we obtain  $y = \frac{1}{4}Dx - \frac{1}{4}$ ,  $Dy = \frac{1}{4}D^2x$ , and  $(D^2 + 1)x = 2$ . Then

$$x = c_1 \cos t + c_2 \sin t + 2$$

and

$$y = \frac{1}{4}c_2 \cos t - \frac{1}{4}c_1 \sin t - \frac{1}{4}c_1 \sin t - \frac{1}{4}.$$

5. From  $(D^2 + 5)x - 2y = 0$  and  $-2x + (D^2 + 2)y = 0$  we obtain  $y = \frac{1}{2}(D^2 + 5)x$ ,  $D^2y = \frac{1}{2}(D^4 + 5D^2)x$ , and  $(D^2 + 1)(D^2 + 6)x = 0$ . Then

$$x = c_1 \cos t + c_2 \sin t + c_3 \cos \sqrt{6}t + c_4 \sin \sqrt{6}t$$

and

$$y = 2c_1 \cos t + 2c_2 \sin t - \frac{1}{2}c_3 \cos \sqrt{6}t - \frac{1}{2}c_4 \sin \sqrt{6}t.$$

6. From  $(D + 1)x + (D - 1)y = 2$  and  $3x + (D + 2)y = -1$  we obtain  $x = -\frac{1}{3} - \frac{1}{3}(D + 2)y$ ,  $Dx = -\frac{1}{3}(D^2 + 2D)y$ , and  $(D^2 + 5)y = -7$ . Then

$$y = c_1 \cos \sqrt{5}t + c_2 \sin \sqrt{5}t - \frac{7}{5}$$

and

$$x = \left(-\frac{2}{3}c_1 - \frac{\sqrt{5}}{3}c_2\right) \cos \sqrt{5}t + \left(\frac{\sqrt{5}}{3}c_1 - \frac{2}{3}c_2\right) \sin \sqrt{5}t + \frac{3}{5}.$$

7. From  $D^2x = 4y + e^t$  and  $D^2y = 4x - e^t$  we obtain  $y = \frac{1}{4}D^2x - \frac{1}{4}e^t$ ,  $D^2y = \frac{1}{4}D^4x - \frac{1}{4}e^t$ , and

### Exercises 4.8

$(D^2 + 4)(D - 2)(D + 2)x = -3e^t$ . Then

$$x = c_1 \cos 2t + c_2 \sin 2t + c_3 e^{2t} + c_4 e^{-2t} + \frac{1}{5} e^t$$

and

$$y = -c_1 \cos 2t - c_2 \sin 2t + c_3 e^{2t} + c_4 e^{-2t} - \frac{1}{5} e^t.$$

8. From  $(D^2 + 5)x + Dy = 0$  and  $(D + 1)x + (D - 4)y = 0$  we obtain  $(D - 5)(D^2 + 4)x = 0$  and  $(D - 5)(D^2 + 4)y = 0$ . Then

$$x = c_1 e^{5t} + c_2 \cos 2t + c_3 \sin 2t$$

and

$$y = c_4 e^{5t} + c_5 \cos 2t + c_6 \sin 2t.$$

Substituting into  $(D + 1)x + (D - 4)y = 0$  gives

$$(6c_1 + c_4)e^{5t} + (c_2 + 2c_3 - 4c_5 + 2c_6) \cos 2t + (-2c_2 + c_3 - 2c_5 - 4c_6) \sin 2t = 0$$

so that  $c_4 = -6c_1$ ,  $c_5 = \frac{1}{2}c_3$ ,  $c_6 = -\frac{1}{2}c_2$ , and

$$y = -6c_1 e^{5t} + \frac{1}{2}c_3 \cos 2t - \frac{1}{2}c_2 \sin 2t.$$

9. From  $Dx + D^2y = e^{3t}$  and  $(D + 1)x + (D - 1)y = 4e^{3t}$  we obtain  $D(D^2 + 1)x = 34e^{3t}$  and  $D(D^2 + 1)y = -8e^{3t}$ . Then

$$y = c_1 + c_2 \sin t + c_3 \cos t - \frac{4}{15} e^{3t}$$

and

$$x = c_4 + c_5 \sin t + c_6 \cos t + \frac{17}{15} e^{3t}.$$

Substituting into  $(D + 1)x + (D - 1)y = 4e^{3t}$  gives

$$(c_4 - c_1) + (c_5 - c_6 - c_3 - c_2) \sin t + (c_6 + c_5 + c_2 - c_3) \cos t = 0$$

so that  $c_4 = c_1$ ,  $c_5 = c_3$ ,  $c_6 = -c_2$ , and

$$x = c_1 - c_2 \cos t + c_3 \sin t + \frac{17}{15} e^{3t}.$$

10. From  $D^2x - Dy = t$  and  $(D + 3)x + (D + 3)y = 2$  we obtain  $D(D + 1)(D + 3)x = 1 + 3t$  and  $D(D + 1)(D + 3)y = -1 - 3t$ . Then

$$x = c_1 + c_2 e^{-t} + c_3 e^{-3t} - t + \frac{1}{2} t^2$$

and

$$y = c_4 + c_5 e^{-t} + c_6 e^{-3t} + t - \frac{1}{2} t^2.$$

Exercises 4.8

Substituting into  $(D + 3)x + (D + 3)y = 2$  and  $D^2x - Dy = t$  gives

$$3(c_1 + c_4) + 2(c_2 + c_5)e^{-t} = 2$$

and

$$(c_2 + c_5)e^{-t} + 3(3c_3 + c_6)e^{-3t} = 0$$

so that  $c_4 = -c_1$ ,  $c_5 = -c_2$ ,  $c_6 = -3c_3$ , and

$$y = -c_1 - c_2e^{-t} - 3c_3e^{-3t} + t - \frac{1}{2}t^2.$$

11. From  $(D^2 - 1)x - y = 0$  and  $(D - 1)x + Dy = 0$  we obtain  $y = (D^2 - 1)x$ ,  $Dy = (D^3 - D)x$ , and  $(D - 1)(D^2 + D + 1)x = 0$ . Then

$$x = c_1e^t + e^{-t/2} \left[ c_2 \cos \frac{\sqrt{3}}{2}t + c_3 \sin \frac{\sqrt{3}}{2}t \right]$$

and

$$y = \left( -\frac{3}{2}c_2 - \frac{\sqrt{3}}{2}c_3 \right) e^{-t/2} \cos \frac{\sqrt{3}}{2}t + \left( \frac{\sqrt{3}}{2}c_2 - \frac{3}{2}c_3 \right) e^{-t/2} \sin \frac{\sqrt{3}}{2}t.$$

12. From  $(2D^2 - D - 1)x - (2D + 1)y = 1$  and  $(D - 1)x + Dy = -1$  we obtain  $(2D + 1)(D - 1)(D + 1)x = -1$  and  $(2D + 1)(D + 1)y = -2$ . Then

$$x = c_1e^{-t/2} + c_2e^{-t} + c_3e^t + 1$$

and

$$y = c_4e^{-t/2} + c_5e^{-t} - 2.$$

Substituting into  $(D - 1)x + Dy = -1$  gives

$$\left( -\frac{3}{2}c_1 - \frac{1}{2}c_4 \right) e^{-t/2} + (-2c_2 - c_5)e^{-t} = 0$$

so that  $c_4 = -3c_1$ ,  $c_5 = -2c_2$ , and

$$y = -3c_1e^{-t/2} - 2c_2e^{-t} - 2.$$

13. From  $(2D - 5)x + Dy = e^t$  and  $(D - 1)x + Dy = 5e^t$  we obtain  $Dy = (5 - 2D)x + e^t$  and  $(4 - D)x = 4e^t$ . Then

$$x = c_1e^{4t} + \frac{4}{3}e^t$$

and  $Dy = -3c_1e^{4t} + 5e^t$  so that

$$y = -\frac{3}{4}c_1e^{4t} + c_2 + 5e^t.$$

14. From  $Dx + Dy = e^t$  and  $(-D^2 + D + 1)x + y = 0$  we obtain  $y = (D^2 - D - 1)x$ ,  $Dy = (D^3 - D^2 - D)x$ , and  $D^2(D - 1)x = e^t$ . Then

$$x = c_1 + c_2t + c_3e^t + te^t$$

and

### Exercises 4.8

$$y = -c_1 - c_2 - c_2t - c_3e^t - te^t + e^t.$$

15. Multiplying the first equation by  $D + 1$  and the second equation by  $D^2 + 1$  and subtracting we obtain  $(D^4 - D^2)x = 1$ . Then

$$x = c_1 + c_2t + c_3e^t + c_4e^{-t} - \frac{1}{2}t^2.$$

Multiplying the first equation by  $D + 1$  and subtracting we obtain  $D^2(D + 1)y = 1$ . Then

$$y = c_5 + c_6t + c_7e^{-t} - \frac{1}{2}t^2.$$

Substituting into  $(D - 1)x + (D^2 + 1)y = 1$  gives

$$(-c_1 + c_2 + c_5 - 1) + (-2c_4 + 2c_7)e^{-t} + (-1 - c_2 + c_6)t = 1$$

so that  $c_5 = c_1 - c_2 + 2$ ,  $c_6 = c_2 + 1$ , and  $c_7 = c_4$ . The solution of the system is

$$x = c_1 + c_2t + c_3e^t + c_4e^{-t} - \frac{1}{2}t^2$$

$$y = (c_1 - c_2 + 2) + (c_2 + 1)t + c_4e^{-t} - \frac{1}{2}t^2.$$

16. From  $D^2x - 2(D^2 + D)y = \sin t$  and  $x + Dy = 0$  we obtain  $x = -Dy$ ,  $D^2x = -D^3y$ , and  $D(D^2 + 2D + 2)y = -\sin t$ . Then

$$y = c_1 + c_2e^{-t} \cos t + c_3e^{-t} \sin t + \frac{1}{5} \cos t + \frac{2}{5} \sin t$$

and

$$x = (c_2 + c_3)e^{-t} \sin t + (c_2 - c_3)e^{-t} \cos t + \frac{1}{5} \sin t - \frac{2}{5} \cos t.$$

17. From  $Dx = y$ ,  $Dy = z$ , and  $Dz = x$  we obtain  $x = D^2y = D^3x$  so that  $(D - 1)(D^2 + D + 1)x = 0$ ,

$$x = c_1e^t + e^{-t/2} \left[ c_2 \sin \frac{\sqrt{3}}{2}t + c_3 \cos \frac{\sqrt{3}}{2}t \right],$$

$$y = c_1e^t + \left( -\frac{1}{2}c_2 - \frac{\sqrt{3}}{2}c_3 \right) e^{-t/2} \sin \frac{\sqrt{3}}{2}t + \left( \frac{\sqrt{3}}{2}c_2 - \frac{1}{2}c_3 \right) e^{-t/2} \cos \frac{\sqrt{3}}{2}t,$$

and

$$z = c_1e^t + \left( -\frac{1}{2}c_2 + \frac{\sqrt{3}}{2}c_3 \right) e^{-t/2} \sin \frac{\sqrt{3}}{2}t + \left( -\frac{\sqrt{3}}{2}c_2 - \frac{1}{2}c_3 \right) e^{-t/2} \cos \frac{\sqrt{3}}{2}t.$$

18. From  $Dx + z = e^t$ ,  $(D - 1)x + Dy + Dz = 0$ , and  $x + 2y + Dz = e^t$  we obtain  $z = -Dx + e^t$ ,  $Dz = -D^2x + e^t$ , and the system  $(-D^2 + D - 1)x + Dy = -e^t$  and  $(-D^2 + 1)x + 2y = 0$ . Then  $y = \frac{1}{2}(D^2 - 1)x$ ,  $Dy = \frac{1}{2}D(D^2 - 1)x$ , and  $(D - 2)(D^2 + 1)x = -2e^t$  so that

$$x = c_1e^{2t} + c_2 \cos t + c_3 \sin t + e^t,$$

$$y = \frac{3}{2}c_1e^{2t} - c_2 \cos t - c_3 \sin t,$$

and

$$z = -2c_1 e^{2t} - c_3 \cos t + c_2 \sin t.$$

19. Write the system in the form

$$Dx - 6y = 0$$

$$x - Dy + z = 0$$

$$x + y - Dz = 0.$$

Multiplying the second equation by  $D$  and adding to the third equation we obtain  $(D+1)x - (D^2-1)y = 0$ . Eliminating  $y$  between this equation and  $Dx - 6y = 0$  we find

$$(D^3 - D - 6D - 6)x = (D+1)(D+2)(D-3)x = 0.$$

Thus

$$x = c_1 e^{-t} + c_2 e^{-2t} + c_3 e^{3t},$$

and, successively substituting into the first and second equations, we get

$$y = -\frac{1}{6}c_1 e^{-t} - \frac{1}{3}c_2 e^{-2t} + \frac{1}{2}c_3 e^{3t}$$

$$z = -\frac{5}{6}c_1 e^{-t} - \frac{1}{3}c_2 e^{-2t} + \frac{1}{2}c_3 e^{3t}.$$

20. Write the system in the form

$$(D+1)x - z = 0$$

$$(D+1)y - z = 0$$

$$x - y + Dz = 0.$$

Multiplying the third equation by  $D+1$  and adding to the second equation we obtain  $(D+1)x + (D^2+D-1)z = 0$ . Eliminating  $z$  between this equation and  $(D+1)x - z = 0$  we find  $D(D+1)^2x = 0$ .

Thus

$$x = c_1 + c_2 e^{-t} + c_3 t e^{-t},$$

and, successively substituting into the first and third equations, we get

$$y = c_1 + (c_2 - c_3)e^{-t} + c_3 t e^{-t}$$

$$z = c_1 + c_3 e^{-t}.$$

21. From  $(D+5)x + y = 0$  and  $4x - (D+1)y = 0$  we obtain  $y = -(D+5)x$  so that  $Dy = -(D^2+5D)x$ . Then  $4x + (D^2+5D)x + (D+5)x = 0$  and  $(D+3)^2x = 0$ . Thus

$$x = c_1 e^{-3t} + c_2 t e^{-3t}$$

and

$$y = -(2c_1 + c_2)e^{-3t} - 2c_2 t e^{-3t}.$$

### Exercises 4.8

Using  $x(1) = 0$  and  $y(1) = 1$  we obtain

$$c_1 e^{-3} + c_2 e^{-3} = 0$$

$$-(2c_1 + c_2)e^{-3} - 2c_2 e^{-3} = 1$$

or

$$c_1 + c_2 = 0$$

$$2c_1 + 3c_2 = -e^3.$$

Thus  $c_1 = e^3$  and  $c_2 = -e^3$ . The solution of the initial value problem is

$$x = e^{-3t+3} - te^{-3t+3}$$

$$y = -e^{-3t+3} + 2te^{-3t+3}.$$

22. From  $Dx - y = -1$  and  $3x + (D - 2)y = 0$  we obtain  $x = -\frac{1}{3}(D - 2)y$  so that  $Dx = -\frac{1}{3}(D^2 - 2D)y$ . Then  $-\frac{1}{3}(D^2 - 2D)y = y - 1$  and  $(D^2 - 2D + 3)y = 3$ . Thus

$$y = e^t (c_1 \cos \sqrt{2}t + c_2 \sin \sqrt{2}t) + 1$$

and

$$x = \frac{1}{3}e^t [(c_1 - \sqrt{2}c_2) \cos \sqrt{2}t + (\sqrt{2}c_1 + c_2) \sin \sqrt{2}t] + \frac{2}{3}.$$

Using  $x(0) = y(0) = 0$  we obtain

$$c_1 + 1 = 0$$

$$\frac{1}{3}(c_1 - \sqrt{2}c_2) + \frac{2}{3} = 0.$$

Thus  $c_1 = -1$  and  $c_2 = \sqrt{2}/2$ . The solution of the initial value problem is

$$x = e^t \left( -\frac{2}{3} \cos \sqrt{2}t - \frac{\sqrt{2}}{6} \sin \sqrt{2}t \right) + \frac{2}{3}$$

$$y = e^t \left( -\cos \sqrt{2}t + \frac{\sqrt{2}}{2} \sin \sqrt{2}t \right) + 1.$$

23. Equating Newton's law with the net forces in the  $x$ - and  $y$ -directions gives  $m \frac{d^2x}{dt^2} = 0$  and  $m \frac{d^2y}{dt^2} = -mg$ , respectively. From  $mD^2x = 0$  we obtain  $x(t) = c_1t + c_2$ , and from  $mD^2y = -mg$  or  $D^2y = -g$  we obtain  $y(t) = -\frac{1}{2}gt^2 + c_3t + c_4$ .

24. From Newton's second law in the  $x$ -direction we have

$$m \frac{d^2x}{dt^2} = -k \cos \theta = -k \frac{1}{v} \frac{dx}{dt} = -|c| \frac{dx}{dt}.$$

In the  $y$ -direction we have

$$m \frac{d^2y}{dt^2} = -mg - k \sin \theta = -mg - k \frac{1}{v} \frac{dy}{dt} = -mg - |c| \frac{dy}{dt}.$$



From  $mD^2x + |c|Dx = 0$  we have  $D(mD + |c|x) = 0$  so that  $(mD + |c|x) = c_1$ . This is a first-order linear equation. An integrating factor is  $e^{\int |c|dt/m} e^{|c|t/m}$  so that

$$\frac{d}{dt}[e^{|c|t/m}x] = c_1 e^{|c|t/m}$$

and  $e^{|c|t}x = (c_1 m/|c|)e^{|c|t/m} + c_2$ . The general solution of this equation is  $x(t) = c_3 + c_2 e^{|c|t/m}$ . From  $(mD^2 + |c|D)y = -mg$  we have  $D(mD + |c|)y = -mg$  so that  $(mD + |c|)y = -mgt + c_1$ . This is a first-order linear equation with integrating factor  $e^{|c|t/m}$ . Thus

$$\frac{d}{dt}[e^{|c|t/m}y] = (-mgt + c_1)e^{|c|t/m}$$

$$e^{|c|t/m}y = -\frac{m^2g}{|c|}te^{|c|t/m} + \frac{m^3g}{c^2}e^{|c|t/m} + \frac{c_1m}{|c|}e^{|c|t/m} + c_2$$

and

$$y(t) = -\frac{m^2g}{|c|}t + \frac{m^3g}{c^2} + c_3 + c_2 e^{-|c|t/m}.$$

25. Multiplying the first equation by  $D + 1$  and the second equation by  $D$  we obtain

$$D(D + 1)x - 2D(D + 1)y = 2t + t^2$$

$$D(D + 1)x - 2D(D + 1)y = 0.$$

This leads to  $2t + t^2 = 0$ , so the system has no solution.

## Exercises 4.9

1. We have  $y'_1 = y''_1 = e^x$ , so

$$(y''_1)^2 = (e^x)^2 = e^{2x} = y_1^2.$$

Also,  $y'_2 = -\sin x$  and  $y''_2 = -\cos x$ , so

$$(y''_2)^2 = (-\cos x)^2 = \cos^2 x = y_2^2.$$

However, if  $y = c_1 y_1 + c_2 y_2$ , we have  $(y'')^2 = (c_1 e^x - c_2 \cos x)^2$  and  $y^2 = (c_1 e^x + c_2 \cos x)^2$ . Thus  $(y'')^2 \neq y^2$ .

2. We have  $y'_1 = y''_1 = 0$ , so

$$y_1 y''_1 = 1 \cdot 0 = 0 = \frac{1}{2}(0)^2 = \frac{1}{2}(y'_1)^2.$$

Also,  $y'_2 = 2x$  and  $y''_2 = 2$ , so

$$y_2 y''_2 = x^2(2) = 2x^2 = \frac{1}{2}(2x)^2 = \frac{1}{2}(y'_2)^2.$$

However, if  $y = c_1 y_1 + c_2 y_2$ , we have  $yy'' = (c_1 \cdot 1 + c_2 x^2)(c_1 \cdot 0 + 2c_2) = 2c_2(c_1 + c_2 x^2)$  and  $\frac{1}{2}(y')^2 = \frac{1}{2}[c_1 \cdot 0 + c_2(2x)]^2 = 2c_2^2 x^2$ . Thus  $yy'' \neq \frac{1}{2}(y')^2$ .

### Exercises 4.9

3. Let  $u = y'$  so that  $u' = y''$ . The equation becomes  $u' = -u - 1$  which is separable. Thus

$$\frac{du}{u^2 + 1} = -dx \implies \tan^{-1} u = -x + c_1 \implies y' = \tan(c_1 - x) \implies y = \ln |\cos(c_1 - x)| + c_2.$$

4. Let  $u = y'$  so that  $u' = y''$ . The equation becomes  $u' = 1 + u^2$ . Separating variables we obtain

$$\frac{du}{1 + u^2} = dx \implies \tan^{-1} u = x + c_1 \implies u = \tan(x + c_1) \implies y = -\ln |\cos(x + c_1)| + c_2.$$

5. Let  $u = y'$  so that  $u' = y''$ . The equation becomes  $x^2 u' + u^2 = 0$ . Separating variables we obtain

$$\begin{aligned} \frac{du}{u^2} &= -\frac{dx}{x^2} \implies -\frac{1}{u} = \frac{1}{x} + c_1 = \frac{c_1 x + 1}{x} \implies u = -\frac{1}{c_1} \left( \frac{x}{x + 1/c_1} \right) = \frac{1}{c_1} \left( \frac{1}{c_1 x + 1} - 1 \right) \\ &\implies y = \frac{1}{c_1^2} \ln |c_1 x + 1| - \frac{1}{c_1} x + c_2. \end{aligned}$$

6. Let  $u = y'$  so that  $y'' = u \frac{du}{dy}$ . The equation becomes  $(y + 1)u \frac{du}{dy} = u^2$ . Separating variables we obtain

$$\begin{aligned} \frac{du}{u} &= \frac{dy}{y + 1} \implies \ln |u| = \ln |y + 1| + \ln c_1 \implies u = c_1(y + 1) \\ &\implies \frac{dy}{dx} = c_1(y + 1) \implies \frac{dy}{y + 1} = c_1 dx \\ &\implies \ln |y + 1| = c_1 x + c_2 \implies y + 1 = c_3 e^{c_1 x}. \end{aligned}$$

7. Let  $u = y'$  so that  $y'' = u \frac{du}{dy}$ . The equation becomes  $u \frac{du}{dy} + 2yu^3 = 0$ . Separating variables we obtain

$$\begin{aligned} \frac{du}{u^2} + 2y dy = 0 &\implies -\frac{1}{u} + y^2 = c \implies u = \frac{1}{y^2 + c_1} \implies y' = \frac{1}{y^2 + c_1} \\ &\implies (y^2 + c_1) dy = dx \implies \frac{1}{3} y^3 + c_1 y = x + c_2. \end{aligned}$$

8. Let  $u = y'$  so that  $y'' = u \frac{du}{dy}$ . The equation becomes  $y^2 u \frac{du}{dy} = u$ . Separating variables we obtain

$$\begin{aligned} du &= \frac{dy}{y^2} \implies u = -\frac{1}{y} + c_1 \implies y' = \frac{c_1 y - 1}{y} \implies \frac{y}{c_1 y - 1} dy = dx \\ &\implies \frac{1}{c_1} \left( 1 + \frac{1}{c_1 y - 1} \right) dy = dx \text{ (for } c_1 \neq 0) \implies \frac{1}{c_1} y + \frac{1}{c_1^2} \ln |y - 1| = x + c_2. \end{aligned}$$

If  $c_1 = 0$ , then  $y dy = -dx$  and another solution is  $\frac{1}{2} y^2 = -x + c_2$ .

9. (a)

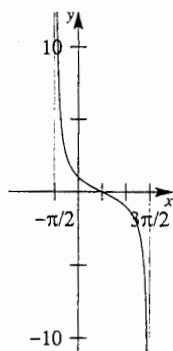

(b) Let  $u = y'$  so that  $y'' = u \frac{du}{dy}$ . The equation becomes  $u \frac{du}{dy} + yu = 0$ . Separating variables we obtain

$$du = -y dy \implies u = -\frac{1}{2}y^2 + c_1 \implies y' = -\frac{1}{2}y^2 + c_1.$$

When  $x = 0$ ,  $y = 1$  and  $y' = -1$  so  $-1 = -\frac{1}{2} + c_1$  and  $c_1 = -\frac{1}{2}$ . Then

$$\begin{aligned} \frac{dy}{dx} = -\frac{1}{2}y^2 - \frac{1}{2} &\implies \frac{dy}{y^2 + 1} = -\frac{1}{2} dx \implies \tan^{-1} y = -\frac{1}{2}x + c_2 \\ &\implies y = \tan\left(-\frac{1}{2}x + c_2\right). \end{aligned}$$

When  $x = 0$ ,  $y = 1$  so  $1 = \tan c_2$  and  $c_2 = \pi/4$ . The solution of the initial-value problem is

$$y = \tan\left(\frac{\pi}{4} - \frac{1}{2}x\right).$$

The graph is shown in part (a).

(c) The interval of definition is  $-\pi/2 < \pi/4 - x/2 < \pi/2$  or  $-\pi/2 < x < 3\pi/2$ .

### Exercises 4.9

10. Let  $u = y'$  so that  $u' = y''$ . The equation becomes  $(u')^2 + u^2 = 1$  which results in  $u' = \pm\sqrt{1-u^2}$ . To solve  $u' = \sqrt{1-u^2}$  we separate variables:

$$\begin{aligned} \frac{du}{\sqrt{1-u^2}} = dx &\implies \sin^{-1} u = x + c_1 \implies u = \sin(x + c_1) \\ &\implies y' = \sin(x + c_1). \end{aligned}$$

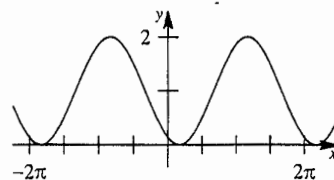

When  $x = \frac{\pi}{2}$ ,  $y' = \frac{\sqrt{3}}{2}$ , so  $\frac{\sqrt{3}}{2} = \sin\left(\frac{\pi}{2} + c_1\right)$  and  $c_1 = -\frac{\pi}{6}$ .

Thus

$$y' = \sin\left(x - \frac{\pi}{6}\right) \implies y = -\cos\left(x - \frac{\pi}{6}\right) + c_2.$$

When  $x = \frac{\pi}{2}$ ,  $y = \frac{1}{2}$ , so  $\frac{1}{2} = -\cos\left(\frac{\pi}{2} - \frac{\pi}{6}\right) + c_2 = -\frac{1}{2} + c_2$  and  $c_2 = 1$ . The solution of the initial-value problem is  $y = 1 - \cos\left(x - \frac{\pi}{6}\right)$ .

To solve  $u' = -\sqrt{1-u^2}$  we separate variables:

$$\begin{aligned} \frac{du}{\sqrt{1-u^2}} = -dx &\implies \cos^{-1} u = x + c_1 \\ &\implies u = \cos(x + c_1) \implies y' = \cos(x + c_1). \end{aligned}$$

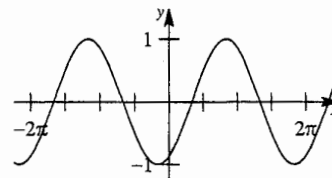

When  $x = \frac{\pi}{2}$ ,  $y' = \frac{\sqrt{3}}{2}$ , so  $\frac{\sqrt{3}}{2} = \cos\left(\frac{\pi}{2} + c_1\right)$  and  $c_1 = -\frac{\pi}{3}$ . Thus

$$y' = \cos\left(x - \frac{\pi}{3}\right) \implies y = \sin\left(x - \frac{\pi}{3}\right) + c_2.$$

When  $x = \frac{\pi}{2}$ ,  $y = \frac{1}{2}$ , so  $\frac{1}{2} = \sin\left(\frac{\pi}{2} - \frac{\pi}{3}\right) + c_2 = \frac{1}{2} + c_2$  and  $c_2 = 0$ . The solution of the initial-value problem is  $y = \sin\left(x - \frac{\pi}{3}\right)$ .

11. Let  $u = y'$  so that  $u' = y''$ . The equation becomes  $u' - \frac{1}{x}u = \frac{1}{x}u^3$ , which is Bernoulli. Using  $w = u^{-2}$  we obtain  $\frac{dw}{dx} + \frac{2}{x}w = -\frac{2}{x}$ . An integrating factor is  $x^2$ , so

$$\begin{aligned} \frac{d}{dx}[x^2w] = -2x &\implies x^2w = -x^2 + c_1 \implies w = -1 + \frac{c_1}{x^2} \\ &\implies u^{-2} = -1 + \frac{c_1}{x^2} \implies u = \frac{x}{\sqrt{c_1 - x^2}} \\ &\implies \frac{dy}{dx} = \frac{x}{\sqrt{c_1 - x^2}} \implies y = -\sqrt{c_1 - x^2} + c_2 \\ &\implies c_1 - x^2 = (c_2 - y)^2 \implies x^2 + (c_2 - y)^2 = c_1. \end{aligned}$$

Exercises 4.9

12. Let  $u = y'$  so that  $u' = y''$ . The equation becomes  $u' - \frac{1}{x}u = u^2$ , which is Bernoulli. Using the substitution  $w = u^{-1}$  we obtain  $\frac{dw}{dx} + \frac{1}{x}w = -1$ . An integrating factor is  $x$ , so
- $$\frac{d}{dx}[xw] = -x \implies w = -\frac{1}{2}x + \frac{1}{x}c \implies \frac{1}{u} = \frac{c_1 - x^2}{2x} \implies u = \frac{2x}{c_1 - x^2} \implies y = -\ln|c_1 - x^2| + c_2.$$

In Problems 13-16 the thinner curve is obtained using a numerical solver, while the thicker curve is the graph of the Taylor polynomial.

13. We look for a solution of the form

$$y(x) = y(0) + y'(0)x + \frac{1}{2}y''(0)x^2 + \frac{1}{3!}y'''(0)x^3 + \frac{1}{4!}y^{(4)}(x)x^4 + \frac{1}{5!}y^{(5)}(x)x^5.$$

From  $y''(x) = x + y^2$  we compute

$$y'''(x) = 1 + 2yy'$$

$$y^{(4)}(x) = 2yy'' + 2(y')^2$$

$$y^{(5)}(x) = 2yy''' + 6y'y''.$$

Using  $y(0) = 1$  and  $y'(0) = 1$  we find

$$y''(0) = 1, \quad y'''(0) = 3, \quad y^{(4)}(0) = 4, \quad y^{(5)}(0) = 12.$$

An approximate solution is

$$y(x) = 1 + x + \frac{1}{2}x^2 + \frac{1}{2}x^3 + \frac{1}{6}x^4 + \frac{1}{10}x^5.$$

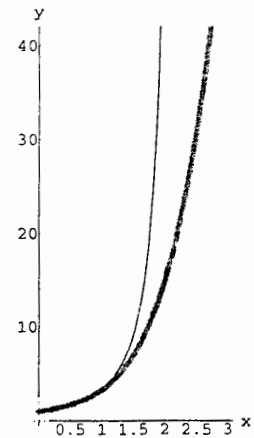

14. We look for a solution of the form

$$y(x) = y(0) + y'(0)x + \frac{1}{2}y''(0)x^2 + \frac{1}{3!}y'''(0)x^3 + \frac{1}{4!}y^{(4)}(x)x^4 + \frac{1}{5!}y^{(5)}(x)x^5.$$

From  $y''(x) = 1 - y^2$  we compute

$$y'''(x) = -2yy'$$

$$y^{(4)}(x) = -2yy'' - 2(y')^2$$

$$y^{(5)}(x) = -2yy''' - 6y'y''.$$

Using  $y(0) = 2$  and  $y'(0) = 3$  we find

$$y''(0) = -3, \quad y'''(0) = -12, \quad y^{(4)}(0) = -6, \quad y^{(5)}(0) = 102.$$

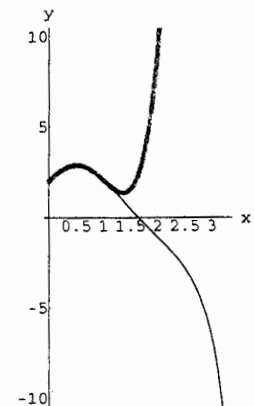

### Exercises 4.9

An approximate solution is

$$y(x) = 2 + 3x - \frac{3}{2}x^2 - 2x^3 - \frac{1}{4}x^4 + \frac{17}{20}x^5.$$

15. We look for a solution of the form

$$y(x) = y(0) + y'(0)x + \frac{1}{2}y''(0)x^2 + \frac{1}{3!}y'''(0)x^3 + \frac{1}{4!}y^{(4)}(x)x^4 + \frac{1}{5!}y^{(5)}(x)x^5.$$

From  $y''(x) = x^2 + y^2 - 2y'$  we compute

$$y'''(x) = 2x + 2yy' - 2y''$$

$$y^{(4)}(x) = 2 + 2(y')^2 + 2yy'' - 2y'''$$

$$y^{(5)}(x) = 6y'y'' + 2yy''' - 2y^{(4)}.$$

Using  $y(0) = 1$  and  $y'(0) = 1$  we find

$$y''(0) = -1, \quad y'''(0) = 4, \quad y^{(4)}(0) = -6, \quad y^{(5)}(0) = 14.$$

An approximate solution is

$$y(x) = 1 + x - \frac{1}{2}x^2 + \frac{2}{3}x^3 - \frac{1}{4}x^4 + \frac{7}{60}x^5.$$

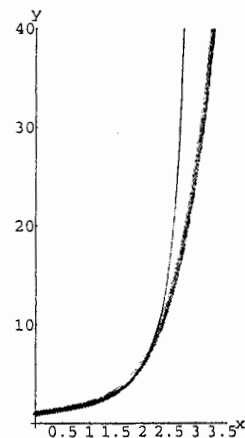

16. We look for a solution of the form

$$y(x) = y(0) + y'(0)x + \frac{1}{2}y''(0)x^2 + \frac{1}{3!}y'''(0)x^3 + \frac{1}{4!}y^{(4)}(x)x^4 + \frac{1}{5!}y^{(5)}(x)x^5 + \frac{1}{6!}y^{(6)}(x)x^6.$$

From  $y''(x) = e^y$  we compute

$$y'''(x) = e^y y'$$

$$y^{(4)}(x) = e^y (y')^2 + e^y y''$$

$$y^{(5)}(x) = e^y (y')^3 + 3e^y y' y'' + e^y y'''$$

$$y^{(6)}(x) = e^y (y')^4 + 6e^y (y')^2 y'' + 3e^y (y'')^2 + 4e^y y' y''' + e^y y^{(4)}.$$

Using  $y(0) = 0$  and  $y'(0) = -1$  we find

$$y''(0) = 1, \quad y'''(0) = -1, \quad y^{(4)}(0) = 2, \quad y^{(5)}(0) = -5, \quad y^{(6)}(0) = 16.$$

An approximate solution is

$$y(x) = -x + \frac{1}{2}x^2 - \frac{1}{6}x^3 + \frac{1}{12}x^4 + \frac{1}{24}x^5 + \frac{1}{45}x^6.$$

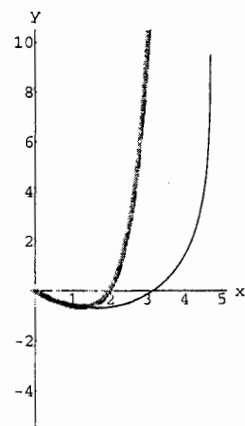

17. We need to solve  $[1 + (y')^2]^{3/2} = y''$ . Let  $u = y'$  so that  $u' = y''$ . The equation becomes  $(1 + u^2)^{3/2} = u'$  or  $(1 + u^2)^{3/2} = \frac{du}{dx}$ . Separating variables and using the substitution  $u = \tan \theta$

we have

$$\begin{aligned} \frac{du}{(1+u^2)^{3/2}} = dx &\implies \int \frac{\sec^2 \theta}{(1+\tan^2 \theta)^{3/2}} d\theta = x \implies \int \frac{\sec^2 \theta}{\sec^3 \theta} d\theta = x \\ &\implies \int \cos \theta d\theta = x \implies \sin \theta = x \implies \frac{u}{\sqrt{1+u^2}} = x \\ &\implies \frac{y'}{\sqrt{1+(y')^2}} = x \implies (y')^2 = x^2 [1+(y')^2] = \frac{x^2}{1-x^2} \\ &\implies y' = \frac{x}{\sqrt{1-x^2}} \quad (\text{for } x > 0) \implies y = -\sqrt{1-x^2}. \end{aligned}$$

18. Let  $u = \frac{dx}{dt}$  so that  $\frac{d^2x}{dt^2} = u \frac{du}{dx}$ . The equation becomes  $u \frac{du}{dx} = \frac{-k^2}{x^2}$ . Separating variables we obtain

$$u du = -\frac{k^2}{x^2} dx \implies \frac{1}{2}u^2 = \frac{k^2}{x} + c \implies \frac{1}{2}v^2 = \frac{k^2}{x} + c.$$

When  $t = 0$ ,  $x = x_0$  and  $v = 0$  so  $0 = \frac{k^2}{x_0} + c$  and  $c = -\frac{k^2}{x_0}$ . Then

$$\frac{1}{2}v^2 = k^2 \left( \frac{1}{x} - \frac{1}{x_0} \right) \quad \text{and} \quad \frac{dx}{dt} = -k\sqrt{2} \sqrt{\frac{x_0 - x}{xx_0}}.$$

Separating variables we have

$$-\sqrt{\frac{xx_0}{x_0 - x}} dx = k\sqrt{2} dt \implies t = -\frac{1}{k} \sqrt{\frac{x_0}{2}} \int \sqrt{\frac{x}{x_0 - x}} dx.$$

Using *Mathematica* to integrate we obtain

$$\begin{aligned} t &= -\frac{1}{k} \sqrt{\frac{x_0}{2}} \left[ -\sqrt{x(x_0 - x)} - \frac{x_0}{2} \tan^{-1} \frac{(x_0 - 2x)}{2x} \sqrt{\frac{x}{x_0 - x}} \right] \\ &= \frac{1}{k} \sqrt{\frac{x_0}{2}} \left[ \sqrt{x(x_0 - x)} + \frac{x_0}{2} \tan^{-1} \frac{x_0 - 2x}{2\sqrt{x(x_0 - x)}} \right]. \end{aligned}$$

19.

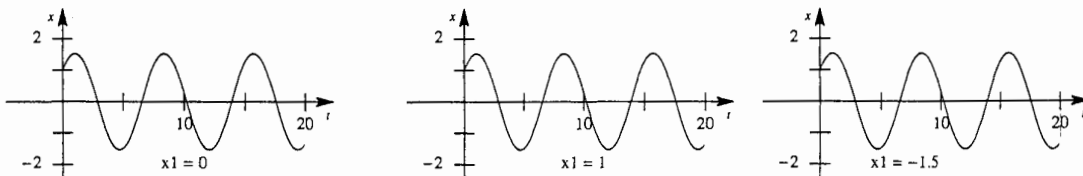

For  $\frac{d^2x}{dt^2} + \sin x = 0$  the motion appears to be periodic with amplitude 1 when  $x_1 = 0$ . The amplitude and period are larger for larger magnitudes of  $x_1$ .

### Exercises 4.9

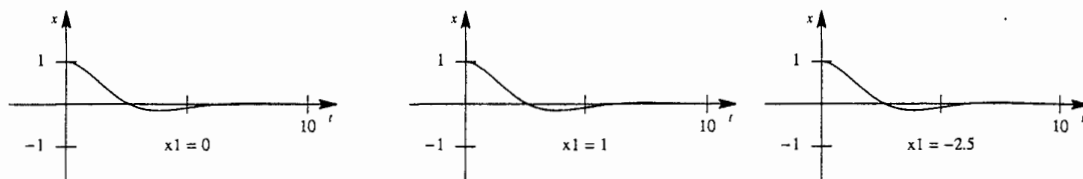

For  $\frac{d^2x}{dt^2} + \frac{dx}{dt} + \sin x = 0$  the motion appears to be periodic with decreasing amplitude. The  $dx/dt$  term could be said to have a damping effect.

20. When  $y = \sin x$ ,  $y' = \cos x$ ,  $y'' = -\sin x$ , and

$$(y'')^2 - y^2 = \sin^2 x - \sin^2 x = 0.$$

When  $y = e^{-x}$ ,  $y' = -e^{-x}$ ,  $y'' = e^{-x}$ , and

$$(y'')^2 - y^2 = e^{-2x} - e^{-2x} = 0.$$

From  $(y'')^2 - y^2 = 0$  we have  $y'' = \pm y$ , which can be treated as two linear equations. Since linear combinations of solutions of linear homogeneous differential equations are also solutions, we see that  $y = c_1 e^x + c_2 e^{-x}$  and  $y = c_3 \cos x + c_4 \sin x$  must satisfy the differential equation. However, linear combinations that involve both exponential and trigonometric functions will not be solutions since the differential equation is not linear and each type of function satisfies a different linear differential equation that is part of the original differential equation.

21. Letting  $u = y''$ , separating variables, and integrating we have

$$\frac{du}{dx} = \sqrt{1+u^2}, \quad \frac{du}{\sqrt{1+u^2}} = dx, \quad \text{and} \quad \sinh^{-1} u = x + c_1.$$

Then

$$u = y'' = \sinh(x + c_1), \quad y' = \cosh(x + c_1) + c_2, \quad \text{and} \quad y = \sinh(x + c_1) + c_2 x + c_3.$$

## Chapter 4 Review Exercises

- $y = 0$
- Since  $y_c = c_1 e^x + c_2 e^{-x}$ , a particular solution for  $y'' - y = 1 + e^x$  is  $y_p = A + Bxe^x$ .
- True
- True
- They are linearly independent over  $(-\infty, \infty)$  and linearly dependent over  $(0, \infty)$ .
- (a) Since  $f_2(x) = 2 \ln x = 2f_1(x)$ , the functions are linearly dependent.



## Chapter 4 Review Exercises

- (b) Since  $x^{n+1}$  is not a constant multiple of  $x^n$ , the functions are linearly independent.
- (c) Since  $x + 1$  is not a constant multiple of  $x$ , the functions are linearly independent.
- (d) Since  $f_1(x) = \cos x \cos(\pi/2) - \sin x \sin(\pi/2) = -\sin x = -f_2(x)$ , the functions are linearly dependent.
- (e) Since  $f_1(x) = 0 \cdot f_2(x)$ , the functions are linearly dependent.
- (f) Since  $2x$  is not a constant multiple of  $2$ , the functions are linearly independent.
- (g) Since  $3(x^2) + 2(1 - x^2) - (2 + x^2) = 0$ , the functions are linearly dependent.
- (h) Since  $xe^{x+1} + 0(4x - 5)e^x - exe^x = 0$ , the functions are linearly dependent.
7. (a) The auxiliary equation is  $(m - 3)(m + 5)(m - 1) = m^3 + m^2 - 17m + 15 = 0$ , so the differential equation is  $y''' + y'' - 17y' + 15y = 0$ .
- (b) The form of the auxiliary equation is

$$m(m - 1)(m - 2) + bm(m - 1) + cm + d = m^3 + (b - 3)m^2 + (c - b + 2)m + d = 0.$$

Since  $(m - 3)(m + 5)(m - 1) = m^3 + m^2 - 17m + 15 = 0$ , we have  $b - 3 = 1$ ,  $c - b + 2 = -17$ , and  $d = 15$ . Thus,  $b = 4$  and  $c = -15$ , so the differential equation is  $y''' + 4y'' - 15y' + 15y = 0$ .

8. Variation of parameters will work for all choices of  $g(x)$ , although the integral involved may not always be able to be expressed in terms of elementary functions. The method of undetermined coefficients will work for the functions in (b), (c), and (e).
9. From  $m^2 - 2m - 2 = 0$  we obtain  $m = 1 \pm \sqrt{3}$  so that

$$y = c_1 e^{(1+\sqrt{3})x} + c_2 e^{(1-\sqrt{3})x}.$$

10. From  $2m^2 + 2m + 3 = 0$  we obtain  $m = -1/2 \pm \sqrt{5}/2$  so that

$$y = e^{-x/2} \left( c_1 \cos \frac{\sqrt{5}}{2} x + c_2 \sin \frac{\sqrt{5}}{2} x \right).$$

11. From  $m^3 + 10m^2 + 25m = 0$  we obtain  $m = 0$ ,  $m = -5$ , and  $m = -5$  so that

$$y = c_1 + c_2 e^{-5x} + c_3 x e^{-5x}.$$

12. From  $2m^3 + 9m^2 + 12m + 5 = 0$  we obtain  $m = -1$ ,  $m = -1$ , and  $m = -5/2$  so that

$$y = c_1 e^{-5x/2} + c_2 e^{-x} + c_3 x e^{-x}.$$

13. From  $3m^3 + 10m^2 + 15m + 4 = 0$  we obtain  $m = -1/3$  and  $m = -3/2 \pm \sqrt{7}/2$  so that

$$y = c_1 e^{-x/3} + e^{-3x/2} \left( c_2 \cos \frac{\sqrt{7}}{2} x + c_3 \sin \frac{\sqrt{7}}{2} x \right).$$

### Chapter 4 Review Exercises

14. From  $2m^4 + 3m^3 + 2m^2 + 6m - 4 = 0$  we obtain  $m = 1/2$ ,  $m = -2$ , and  $m = \pm\sqrt{2}i$  so that

$$y = c_1 e^{x/2} + c_2 e^{-2x} + c_3 \cos \sqrt{2}x + c_4 \sin \sqrt{2}x.$$

15. Applying  $D^4$  to the differential equation we obtain  $D^4(D^2 - 3D + 5) = 0$ . Then

$$y = e^{3x/2} \underbrace{\left( c_1 \cos \frac{\sqrt{11}}{2}x + c_2 \sin \frac{\sqrt{11}}{2}x \right)}_{y_c} + c_3 + c_4x + c_5x^2 + c_6x^3$$

and  $y_p = A + Bx + Cx^2 + Dx^3$ . Substituting  $y_p$  into the differential equation yields

$$(5A - 3B + 2C) + (5B - 6C + 6D)x + (5C - 9D)x^2 + 5Dx^3 = -2x + 4x^3.$$

Equating coefficients gives  $A = -222/625$ ,  $B = 46/125$ ,  $C = 36/25$ , and  $D = 4/5$ . The general solution is

$$y = e^{3x/2} \left( c_1 \cos \frac{\sqrt{11}}{2}x + c_2 \sin \frac{\sqrt{11}}{2}x \right) - \frac{222}{625} + \frac{46}{125}x + \frac{36}{25}x^2 + \frac{4}{5}x^3.$$

16. Applying  $(D - 1)^3$  to the differential equation we obtain  $(D - 1)^3(D - 2D + 1) = (D - 1)^5 = 0$ . Then

$$y = \underbrace{c_1 e^x + c_2 x e^x}_{y_c} + c_3 x^2 e^x + c_4 x^3 e^x + c_5 x^4 e^x$$

and  $y_p = Ax^2 e^x + Bx^3 e^x + Cx^4 e^x$ . Substituting  $y_p$  into the differential equation yields

$$12Cx^2 e^x + 6Bx e^x + 2Ae^x = x^2 e^x.$$

Equating coefficients gives  $A = 0$ ,  $B = 0$ , and  $C = 1/12$ . The general solution is

$$y = c_1 e^x + c_2 x e^x + \frac{1}{12} x^4 e^x.$$

17. Applying  $D(D^2 + 1)$  to the differential equation we obtain

$$D(D^2 + 1)(D^3 - 5D^2 + 6D) = D^2(D^2 + 1)(D - 2)(D - 3) = 0.$$

Then

$$y = \underbrace{c_1 + c_2 e^{2x} + c_3 e^{3x}}_{y_c} + c_4 x + c_5 \cos x + c_6 \sin x$$

and  $y_p = Ax + B \cos x + C \sin x$ . Substituting  $y_p$  into the differential equation yields

$$6A + (5B + 5C) \cos x + (-5B + 5C) \sin x = 8 + 2 \sin x.$$

Equating coefficients gives  $A = 4/3$ ,  $B = -1/5$ , and  $C = 1/5$ . The general solution is

$$y = c_1 + c_2 e^{2x} + c_3 e^{3x} + \frac{4}{3}x - \frac{1}{5} \cos x + \frac{1}{5} \sin x.$$

Chapter 4 Review Exercises

18. Applying  $D$  to the differential equation we obtain  $D(D^3 - D^2) = D^3(D - 1) = 0$ . Then

$$y = \underbrace{c_1 + c_2x + c_3e^x}_{y_c} + c_4x^2$$

and  $y_p = Ax^2$ . Substituting  $y_p$  into the differential equation yields  $-2A = 6$ . Equating coefficients gives  $A = -3$ . The general solution is

$$y = c_1 + c_2x + c_3e^x - 3x^2.$$

19. The auxiliary equation is  $m^2 - 2m + 2 = [m - (1 + i)][m - (1 - i)] = 0$ , so  $y_c = c_1e^x \sin x + c_2e^x \cos x$  and

$$W = \begin{vmatrix} e^x \sin x & e^x \cos x \\ e^x \cos x + e^x \sin x & -e^x \sin x + e^x \cos x \end{vmatrix} = -e^{2x}.$$

Identifying  $f(x) = e^x \tan x$  we obtain

$$u_1' = -\frac{(e^x \cos x)(e^x \tan x)}{-e^{2x}} = \sin x$$

$$u_2' = \frac{(e^x \sin x)(e^x \tan x)}{-e^{2x}} = -\frac{\sin^2 x}{\cos x} = \cos x - \sec x.$$

Then  $u_1 = -\cos x$ ,  $u_2 = \sin x - \ln |\sec x + \tan x|$ , and

$$y = c_1e^x \sin x + c_2e^x \cos x - e^x \sin x \cos x + e^x \sin x \cos x - e^x \cos x \ln |\sec x + \tan x|$$

$$= c_1e^x \sin x + c_2e^x \cos x - e^x \cos x \ln |\sec x + \tan x|.$$

20. The auxiliary equation is  $m^2 - 1 = 0$ , so  $y_c = c_1e^x + c_2e^{-x}$  and

$$W = \begin{vmatrix} e^x & e^{-x} \\ e^x & -e^{-x} \end{vmatrix} = -2.$$

Identifying  $f(x) = 2e^x/(e^x + e^{-x})$  we obtain

$$u_1' = \frac{1}{e^x + e^{-x}} = \frac{e^x}{1 + e^{2x}}$$

$$u_2' = -\frac{e^{2x}}{e^x + e^{-x}} = -\frac{e^{3x}}{1 + e^{2x}} = -e^x + \frac{e^x}{1 + e^{2x}}.$$

Then  $u_1 = \tan^{-1} e^x$ ,  $u_2 = -e^x + \tan^{-1} e^x$ , and

$$y = c_1e^x + c_2e^{-x} + e^x \tan^{-1} e^x - 1 + e^{-x} \tan^{-1} e^x.$$

21. The auxiliary equation is  $6m^2 - m - 1 = 0$  so that

$$y = c_1x^{1/2} + c_2x^{-1/3}.$$

### Chapter 4 Review Exercises

22. The auxiliary equation is  $2m^3 + 13m^2 + 24m + 9 = (m + 3)^2(m + 1/2) = 0$  so that

$$y = c_1x^{-3} + c_2x^{-3} \ln x + \frac{1}{4}x^3.$$

23. The auxiliary equation is  $m^2 - 5m + 6 = (m - 2)(m - 3) = 0$  and a particular solution is  $y_p = x^4 - x^2 \ln x$  so that

$$y = c_1x^2 + c_2x^3 + x^4 - x^2 \ln x.$$

24. The auxiliary equation is  $m^2 - 2m + 1 = (m - 1)^2 = 0$  and a particular solution is  $y_p = \frac{1}{4}x^3$  so that

$$y = c_1x + c_2x \ln x + \frac{1}{4}x^3.$$

25. (a) The auxiliary equation is  $m^2 + \omega^2 = 0$ , so  $y_c = c_1 \cos \omega t + c_2 \sin \omega t$ . When  $\omega \neq \alpha$ ,  $y_p = A \cos \alpha t + B \sin \alpha t$  and

$$y = c_1 \cos \omega t + c_2 \sin \omega t + A \cos \alpha t + B \sin \alpha t.$$

When  $\omega = \alpha$ ,  $y_p = At \cos \alpha t + Bt \sin \alpha t$  and

$$y = c_1 \cos \omega t + c_2 \sin \omega t + At \cos \alpha t + Bt \sin \alpha t.$$

- (b) The auxiliary equation is  $m^2 - \omega^2 = 0$ , so  $y_c = c_1 e^{\omega t} + c_2 e^{-\omega t}$ . When  $\omega \neq \alpha$ ,  $y_p = Ae^{\alpha t}$  and

$$y = c_1 e^{\omega t} + c_2 e^{-\omega t} + Ae^{\alpha t}.$$

When  $\omega = \alpha$ ,  $y_p = Ate^{\alpha t}$  and

$$y = c_1 e^{\omega t} + c_2 e^{-\omega t} + Ate^{\alpha t}.$$

26. (a) If  $y = \sin x$  is a solution then so is  $y = \cos x$  and  $m^2 + 1$  is a factor of the auxiliary equation  $m^4 + 2m^3 + 11m^2 + 2m + 10 = 0$ . Dividing by  $m^2 + 1$  we get  $m^2 + 2m + 10$ , which has roots  $-1 \pm 3i$ . The general solution of the differential equation is

$$y = c_1 \cos x + c_2 \sin x + e^{-x}(c_3 \cos 3x + c_4 \sin 3x).$$

- (b) The auxiliary equation is  $m(m + 1) = m^2 + m = 0$ , so the associated homogeneous differential equation is  $y'' + y' = 0$ . Letting  $y = c_1 + c_2 e^{-x} + \frac{1}{2}x^2 - x$  and computing  $y'' + y'$  we get  $x$ . Thus, the differential equation is  $y'' + y' = x$ .

27. (a) The auxiliary equation is  $m^4 - 2m^2 + 1 = (m^2 - 1)^2 = 0$ , so the general solution of the differential equation is

$$y = c_1 \sinh x + c_2 \cosh x + c_3 x \sinh x + c_4 x \cosh x.$$

- (b) Since both  $\sinh x$  and  $x \sinh x$  are solutions of the associated homogeneous differential equation, a particular solution of  $y^{(4)} - 2y'' + y = \sinh x$  has the form  $y_p = Ax^2 \sinh x + Bx^2 \cosh x$ .

## Chapter 4 Review Exercises

28. Since  $y_1' = 1$  and  $y_1'' = 0$ ,  $x^2y_1'' - (x^2 + 2x)y_1' + (x + 2)y_1 = -x^2 - 2x + x^2 + 2x = 0$ , and  $y_1 = x$  is a solution of the associated homogeneous equation. Using the method of reduction of order, we let  $y = ux$ . Then  $y' = xu' + u$  and  $y'' = xu'' + 2u'$ , so

$$\begin{aligned} x^2y'' - (x^2 + 2x)y' + (x + 2)y &= x^3u'' + 2x^2u' - x^3u' - 2x^2u' - x^2u - 2xu + x^2u + 2xu \\ &= x^3u'' - x^3u' = x^3(u'' - u'). \end{aligned}$$

To find a second solution of the homogeneous equation we note that  $u = e^x$  is a solution of  $u'' - u' = 0$ . Thus,  $y_c = c_1x + c_2xe^x$ . To find a particular solution we set  $x^3(u'' - u') = x^3$  so that  $u'' - u' = 1$ . This differential equation has a particular solution of the form  $Ax$ . Substituting, we find  $A = -1$ , so a particular solution of the original differential equation is  $y_p = -x^2$  and the general solution is  $y = c_1x + c_2xe^x - x^2$ .

29. The auxiliary equation is  $m^2 - 2m + 2 = 0$  so that  $m = 1 \pm i$  and  $y = e^x(c_1 \cos x + c_2 \sin x)$ . Setting  $y(\pi/2) = 0$  and  $y(\pi) = -1$  we obtain  $c_1 = e^{-\pi}$  and  $c_2 = 0$ . Thus,  $y = e^{x-\pi} \cos x$ .
30. The auxiliary equation is  $m^2 + 2m + 1 = (m + 1)^2 = 0$ , so that  $y = c_1e^{-x} + c_2xe^{-x}$ . Setting  $y(-1) = 0$  and  $y'(0) = 0$  we get  $c_1e - c_2e = 0$  and  $-c_1 + c_2 = 0$ . Thus  $c_1 = c_2$  and  $y = ce^{-x} + cxe^{-x}$  is a solution of the boundary-value problem for any real number  $c$ .
31. The auxiliary equation is  $m^2 - 1 = (m - 1)(m + 1) = 0$  so that  $m = \pm 1$  and  $y = c_1e^x + c_2e^{-x}$ . Assuming  $y_p = Ax + B + C \sin x$  and substituting into the differential equation we find  $A = -1$ ,  $B = 0$ , and  $C = -\frac{1}{2}$ . Thus  $y_p = -x - \frac{1}{2} \sin x$  and

$$y = c_1e^x + c_2e^{-x} - x - \frac{1}{2} \sin x.$$

Setting  $y(0) = 2$  and  $y'(0) = 3$  we obtain

$$c_1 + c_2 = 2$$

$$c_1 - c_2 - \frac{3}{2} = 3.$$

Solving this system we find  $c_1 = \frac{13}{4}$  and  $c_2 = -\frac{5}{4}$ . The solution of the initial-value problem is

$$y = \frac{13}{4}e^x - \frac{5}{4}e^{-x} - x - \frac{1}{2} \sin x.$$

32. The auxiliary equation is  $m^2 + 1 = 0$ , so  $y_c = c_1 \cos x + c_2 \sin x$  and

$$W = \begin{vmatrix} \cos x & \sin x \\ -\sin x & \cos x \end{vmatrix} = 1.$$

Identifying  $f(x) = \sec^3 x$  we obtain

$$u_1' = -\sin x \sec^3 x = -\frac{\sin x}{\cos^3 x}$$

$$u_2' = \cos x \sec^3 x = \sec^2 x.$$

## Chapter 4 Review Exercises

Then

$$u_1 = -\frac{1}{2} \frac{1}{\cos^2 x} = -\frac{1}{2} \sec^2 x$$

$$u_2 = \tan x.$$

Thus

$$\begin{aligned} y &= c_1 \cos x + c_2 \sin x - \frac{1}{2} \cos x \sec^2 x + \sin x \tan x \\ &= c_1 \cos x + c_2 \sin x - \frac{1}{2} \sec x + \frac{1 - \cos^2 x}{\cos x} \\ &= c_3 \cos x + c_2 \sin x + \frac{1}{2} \sec x. \end{aligned}$$

and

$$y'_p = -c_3 \sin x + c_2 \cos x + \frac{1}{2} \sec x \tan x.$$

The initial conditions imply

$$c_3 + \frac{1}{2} = 1$$

$$c_2 = \frac{1}{2}.$$

Thus  $c_3 = c_2 = 1/2$  and

$$y = \frac{1}{2} \cos x + \frac{1}{2} \sin x + \frac{1}{2} \sec x.$$

33. Let  $u = y'$  so that  $u' = y''$ . The equation becomes  $u \frac{du}{dx} = 4x$ . Separating variables we obtain

$$u \, du = 4x \, dx \implies \frac{1}{2} u^2 = 2x^2 + c_1 \implies u^2 = 4x^2 + c_2.$$

When  $x = 1$ ,  $y' = u = 2$ , so  $4 = 4 + c_2$  and  $c_2 = 0$ . Then

$$\begin{aligned} u^2 = 4x^2 &\implies \frac{dy}{dx} = 2x \quad \text{or} \quad \frac{dy}{dx} = -2x \\ &\implies y = x^2 + c_3 \quad \text{or} \quad y = -x^2 + c_4. \end{aligned}$$

When  $x = 1$ ,  $y = 5$ , so  $5 = 1 + c_3$  and  $5 = -1 + c_4$ . Thus  $c_3 = 4$  and  $c_4 = 6$ . We have  $y = x^2 + 4$  and  $y = -x^2 + 6$ . Note however that when  $y = -x^2 + 6$ ,  $y' = -2x$  and  $y'(1) = -2 \neq 2$ . Thus, the solution of the initial-value problem is  $y = x^2 + 4$ .

34. Let  $u = y'$  so that  $y'' = u \frac{du}{dy}$ . The equation becomes  $2u \frac{du}{dy} = 3y^2$ . Separating variables we obtain

$$2u \, dy = 3y^2 \, dy \implies u^2 = y^3 + c_1.$$

## Chapter 4 Review Exercises

When  $x = 0$ ,  $y = 1$  and  $y' = u = 1$  so  $1 = 1 + c_1$  and  $c_1 = 0$ . Then

$$\begin{aligned} u^2 = y^3 &\implies \left(\frac{dy}{dx}\right)^2 = y^3 \implies \frac{dy}{dx} = y^{3/2} \implies y^{-3/2} dy = dx \\ &\implies -2y^{-1/2} = x + c_2 \implies y = \frac{4}{(x + c_2)^2}. \end{aligned}$$

When  $x = 0$ ,  $y = 1$ , so  $1 = \frac{4}{c_2^2} \implies c_2 = \pm 2$ . Thus,  $y = \frac{4}{(x+2)^2}$  and  $y = \frac{4}{(x-2)^2}$ . Note however that when  $y = \frac{4}{(x+2)^2}$ ,  $y' = -\frac{8}{(x+2)^3}$  and  $y'(0) = -1 \neq 1$ . Thus, the solution of the initial-value problem is  $y = \frac{4}{(x-2)^2}$ .

35. (a) The auxiliary equation is  $12m^4 + 64m^3 + 59m^2 - 23m - 12 = 0$  and has roots  $-4$ ,  $-3/2$ ,  $-1/3$ , and  $1/2$ . The general solution is

$$y = c_1 e^{-4x} + c_2 e^{-3x/2} + c_3 e^{-x/3} + c_4 e^{x/2}.$$

- (b) The system of equations is

$$\begin{aligned} c_1 + c_2 + c_3 + c_4 &= -1 \\ -4c_1 - \frac{3}{2}c_2 - \frac{1}{3}c_3 + \frac{1}{2}c_4 &= 2 \\ 16c_1 + \frac{9}{4}c_2 + \frac{1}{9}c_3 + \frac{1}{4}c_4 &= 5 \\ -64c_1 - \frac{27}{8}c_2 - \frac{1}{27}c_3 + \frac{1}{8}c_4 &= 0. \end{aligned}$$

Using a CAS we find  $c_1 = -\frac{73}{495}$ ,  $c_2 = \frac{109}{35}$ ,  $c_3 = -\frac{3726}{385}$ , and  $c_4 = \frac{257}{45}$ . The solution of the initial-value problem is

$$y = -\frac{73}{495}e^{-4x} + \frac{109}{35}e^{-3x/2} - \frac{3726}{385}e^{-x/3} + \frac{257}{45}e^{x/2}.$$

## Chapter 4 Review Exercises

36. Consider  $xy'' + y' = 0$  and look for a solution of the form  $y = x^m$ .

Substituting into the differential equation we have

$$xy'' + y' = m(m-1)x^{m-1} + mx^{m-1} = m^2x.$$

Thus, the general solution of  $xy'' + y' = 0$  is  $y_c = c_1 + c_2 \ln x$ . To find a particular solution of  $xy'' + y' = -\sqrt{x}$  we use variation of parameters.

The Wronskian is

$$W = \begin{vmatrix} 1 & \ln x \\ 0 & 1/x \end{vmatrix} = \frac{1}{x}.$$

Identifying  $f(x) = -x^{-1/2}$  we obtain

$$u_1' = \frac{x^{-1/2} \ln x}{1/x} = \sqrt{x} \ln x \quad \text{and} \quad u_2' = \frac{-x^{-1/2}}{1/x} = -\sqrt{x},$$

so that

$$u_1 = x^{3/2} \left( \frac{2}{3} \ln x - \frac{4}{9} \right) \quad \text{and} \quad u_2 = -\frac{2}{3} x^{3/2}.$$

Then  $y_p = x^{3/2} \left( \frac{2}{3} \ln x - \frac{4}{9} \right) - \frac{2}{3} x^{3/2} \ln x = -\frac{4}{9} x^{3/2}$  and the general solution of the differential equation is  $y = c_1 + c_2 \ln x - \frac{4}{9} x^{3/2}$ . The initial conditions are  $y(1) = 0$  and  $y'(1) = 0$ . These imply that  $c_1 = \frac{4}{9}$  and  $c_2 = \frac{2}{3}$ . The solution of the initial-value problem is  $y = \frac{4}{9} + \frac{2}{3} \ln x - \frac{4}{9} x^{3/2}$ .

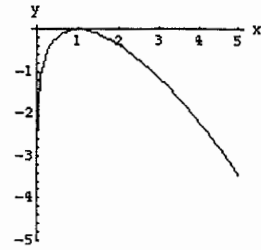

37. From  $(D-2)x + (D-2)y = 1$  and  $Dx + (2D-1)y = 3$  we obtain  $(D-1)(D-2)y = -6$  and  $Dx = 3 - (2D-1)y$ . Then

$$y = c_1 e^{2t} + c_2 e^t - 3 \quad \text{and} \quad x = -c_2 e^t - \frac{3}{2} c_1 e^{2t} + c_3.$$

Substituting into  $(D-2)x + (D-2)y = 1$  gives  $c_3 = 5/2$  so that

$$x = -c_2 e^t - \frac{3}{2} c_1 e^{2t} + \frac{5}{2}.$$

38. From  $(D-2)x - y = t - 2$  and  $-3x + (D-4)y = -4t$  we obtain  $(D-1)(D-5)x = 9 - 8t$ . Then

$$x = c_1 e^t + c_2 e^{5t} - \frac{8}{5}t - \frac{3}{25}$$

and

$$y = (D-2)x - t + 2 = -c_1 e^t + 3c_2 e^{5t} + \frac{16}{25} + \frac{11}{25}t.$$

39. From  $(D-2)x - y = -e^t$  and  $-3x + (D-4)y = -7e^t$  we obtain  $(D-1)(D-5)x = -4e^t$  so that

$$x = c_1 e^t + c_2 e^{5t} + te^t.$$

Then

$$y = (D-2)x + e^t = -c_1 e^t + 3c_2 e^{5t} - te^t + 2e^t.$$



Chapter 4 Review Exercises

40. From  $(D+2)x+(D+1)y = \sin 2t$  and  $5x+(D+3)y = \cos 2t$  we obtain  $(D^2+5)y = 2 \cos 2t - 7 \sin 2t$ .

Then

$$y = c_1 \cos t + c_2 \sin t - \frac{2}{3} \cos 2t + \frac{7}{3} \sin 2t$$

and

$$x = -\frac{1}{5}(D+3)y + \frac{1}{5} \cos 2t$$

$$= \left(\frac{1}{5}c_1 - \frac{3}{5}c_2\right) \sin t + \left(-\frac{1}{5}c_2 - \frac{3}{5}c_1\right) \cos t - \frac{5}{3} \sin 2t - \frac{1}{3} \cos 2t.$$

# 5 Modeling with Higher-Order Differential Equations

## Exercises 5.1

1. From  $\frac{1}{8}x'' + 16x = 0$  we obtain

$$x = c_1 \cos 8\sqrt{2}t + c_2 \sin 8\sqrt{2}t$$

so that the period of motion is  $2\pi/8\sqrt{2} = \sqrt{2}\pi/8$  seconds.

2. From  $20x'' + kx = 0$  we obtain

$$x = c_1 \cos \frac{1}{2}\sqrt{\frac{k}{5}}t + c_2 \sin \frac{1}{2}\sqrt{\frac{k}{5}}t$$

so that the frequency  $2/\pi = \frac{1}{4}\sqrt{k/5}\pi$  and  $k = 320$  N/m. If  $80x'' + 320x = 0$  then  $x = c_1 \cos 2t + c_2 \sin 2t$  so that the frequency is  $2/2\pi = 1/\pi$  vibrations/second.

3. From  $\frac{3}{4}x'' + 72x = 0$ ,  $x(0) = -1/4$ , and  $x'(0) = 0$  we obtain  $x = -\frac{1}{4} \cos 4\sqrt{6}t$ .
4. From  $\frac{3}{4}x'' + 72x = 0$ ,  $x(0) = 0$ , and  $x'(0) = 2$  we obtain  $x = \frac{\sqrt{6}}{12} \sin 4\sqrt{6}t$ .
5. From  $\frac{5}{8}x'' + 40x = 0$ ,  $x(0) = 1/2$ , and  $x'(0) = 0$  we obtain  $x = \frac{1}{2} \cos 8t$ .
- (a)  $x(\pi/12) = -1/4$ ,  $x(\pi/8) = -1/2$ ,  $x(\pi/6) = -1/4$ ,  $x(\pi/8) = 1/2$ ,  $x(9\pi/32) = \sqrt{2}/4$ .
- (b)  $x' = -4 \sin 8t$  so that  $x'(3\pi/16) = 4$  ft/s directed downward.
- (c) If  $x = \frac{1}{2} \cos 8t = 0$  then  $t = (2n+1)\pi/16$  for  $n = 0, 1, 2, \dots$ .
6. From  $50x'' + 200x = 0$ ,  $x(0) = 0$ , and  $x'(0) = -10$  we obtain  $x = -5 \sin 2t$  and  $x' = -10 \cos 2t$ .
7. From  $20x'' + 20x = 0$ ,  $x(0) = 0$ , and  $x'(0) = -10$  we obtain  $x = -10 \sin t$  and  $x' = -10 \cos t$ .
- (a) The 20 kg mass has the larger amplitude.
- (b) 20 kg:  $x'(\pi/4) = -5\sqrt{2}$  m/s,  $x'(\pi/2) = 0$  m/s; 50 kg:  $x'(\pi/4) = 0$  m/s,  $x'(\pi/2) = 10$  m/s
- (c) If  $-5 \sin 2t = -10 \sin t$  then  $2 \sin t(\cos t - 1) = 0$  so that  $t = n\pi$  for  $n = 0, 1, 2, \dots$ , placing both masses at the equilibrium position. The 50 kg mass is moving upward; the 20 kg mass is moving upward when  $n$  is even and downward when  $n$  is odd.
8. From  $x'' + 16x = 0$ ,  $x(0) = -1$ , and  $x'(0) = -2$  we obtain

$$x = -\cos 4t - \frac{1}{2} \sin 4t = \frac{\sqrt{5}}{2} \cos(4t - 3.6).$$

Exercises 5.1

The period is  $\pi/2$  seconds and the amplitude is  $\sqrt{5}/2$  feet. In  $4\pi$  seconds it will make 8 complete vibrations.

9. From  $\frac{1}{4}x'' + x = 0$ ,  $x(0) = 1/2$ , and  $x'(0) = 3/2$  we obtain

$$x = \frac{1}{2} \cos 2t + \frac{3}{4} \sin 2t = \frac{\sqrt{13}}{4} \sin(2t + 0.588).$$

10. From  $1.6x'' + 40x = 0$ ,  $x(0) = -1/3$ , and  $x'(0) = 5/4$  we obtain

$$x = -\frac{1}{3} \cos 5t + \frac{1}{4} \sin 5t = \frac{5}{12} \sin(5t + 0.927).$$

If  $x = 5/24$  then  $t = \frac{1}{5} \left( \frac{\pi}{6} + 0.927 + 2n\pi \right)$  and  $t = \frac{1}{5} \left( \frac{5\pi}{6} + 0.927 + 2n\pi \right)$  for  $n = 0, 1, 2, \dots$

11. From  $2x'' + 200x = 0$ ,  $x(0) = -2/3$ , and  $x'(0) = 5$  we obtain
- $x = -\frac{2}{3} \cos 10t + \frac{1}{2} \sin 10t = \frac{5}{6} \sin(10t - 0.927)$ .
  - The amplitude is  $5/6$  ft and the period is  $2\pi/10 = \pi/5$
  - $3\pi = \pi k/5$  and  $k = 15$  cycles.
  - If  $x = 0$  and the weight is moving downward for the second time, then  $10t - 0.927 = 2\pi$  or  $t = 0.721$  s.
  - If  $x' = \frac{25}{3} \cos(10t - 0.927) = 0$  then  $10t - 0.927 = \pi/2 + n\pi$  or  $t = (2n + 1)\pi/20 + 0.0927$  for  $n = 0, 1, 2, \dots$
  - $x(3) = -0.597$  ft
  - $x'(3) = -5.814$  ft/s
  - $x''(3) = 59.702$  ft/s<sup>2</sup>
  - If  $x = 0$  then  $t = \frac{1}{10}(0.927 + n\pi)$  for  $n = 0, 1, 2, \dots$  and  $x'(t) = \pm \frac{25}{3}$  ft/s.
  - If  $x = 5/12$  then  $t = \frac{1}{10}(\pi/6 + 0.927 + 2n\pi)$  and  $t = \frac{1}{10}(5\pi/6 + 0.927 + 2n\pi)$  for  $n = 0, 1, 2, \dots$
  - If  $x = 5/12$  and  $x' < 0$  then  $t = \frac{1}{10}(5\pi/6 + 0.927 + 2n\pi)$  for  $n = 0, 1, 2, \dots$
12. From  $x'' + 9x = 0$ ,  $x(0) = -1$ , and  $x'(0) = -\sqrt{3}$  we obtain

$$x = -\cos 3t - \frac{\sqrt{3}}{3} \sin 3t = \frac{2}{\sqrt{3}} \sin \left( 3t + \frac{4\pi}{3} \right)$$

and  $x' = 2\sqrt{3} \cos(3t + 4\pi/3)$ . If  $x' = 3$  then  $t = -7\pi/18 + 2n\pi/3$  and  $t = -\pi/2 + 2n\pi/3$  for  $n = 1, 2, 3, \dots$

13. From  $k_1 = 40$  and  $k_2 = 120$  we compute the effective spring constant  $k = 4(40)(120)/160 = 120$ . Now,  $m = 20/32$  so  $k/m = 120(32)/20 = 192$  and  $x'' + 192x = 0$ . Using  $x(0) = 0$  and  $x'(0) = 2$  we obtain  $x(t) = \frac{\sqrt{3}}{12} \sin 8\sqrt{3}t$ .
14. Let  $m$  denote the mass in slugs of the first weight. Let  $k_1$  and  $k_2$  be the spring constants and  $k = 4k_1k_2/(k_1 + k_2)$  the effective spring constant of the system. Now, the numerical value of the

### Exercises 5.1

first weight is  $W = mg = 32m$ , so

$$32m = k_1 \left( \frac{1}{3} \right) \quad \text{and} \quad 32m = k_2 \left( \frac{1}{2} \right).$$

From these equations we find  $2k_1 = 3k_2$ . The given period of the combined system is  $2\pi/\omega = \pi/15$ , so  $\omega = 30$ . Since the mass of an 8-pound weight is  $1/4$  slug, we have from  $\omega^2 = k/m$

$$30^2 = \frac{k}{1/4} = 4k \quad \text{or} \quad k = 225.$$

We now have the system of equations

$$\frac{4k_1 k_2}{k_1 + k_2} = 225$$

$$2k_1 = 3k_2.$$

Solving the second equation for  $k_1$  and substituting in the first equation, we obtain

$$\frac{4(3k_2/2)k_2}{3k_2/2 + k_2} = \frac{12k_2^2}{5k_2} = \frac{12k_2}{5} = 225.$$

Thus,  $k_2 = 375/4$  and  $k_1 = 1125/8$ . Finally, the value of the first weight is

$$W = 32m = \frac{k_1}{3} = \frac{1125/8}{3} = \frac{375}{8} \approx 46.88 \text{ lb.}$$

15. For large values of  $t$  the differential equation is approximated by  $x'' = 0$ . The solution of this equation is the linear function  $x = c_1 t + c_2$ . Thus, for large time, the restoring force will have decayed to the point where the spring is incapable of returning the mass, and the spring will simply keep on stretching.
16. As  $t$  becomes larger the spring constant increases; that is, the spring is stiffening. It would seem that the oscillations would become periodic and the spring would oscillate more rapidly. It is likely that the amplitudes of the oscillations would decrease as  $t$  increases.
17. (a) above (b) heading upward
18. (a) below (b) from rest
19. (a) below (b) heading upward
20. (a) above (b) heading downward
21. From  $\frac{1}{8}x'' + x' + 2x = 0$ ,  $x(0) = -1$ , and  $x'(0) = 8$  we obtain  $x = 4te^{-4t} - e^{-4t}$  and  $x' = 8e^{-4t} - 16te^{-4t}$ . If  $x = 0$  then  $t = 1/4$  second. If  $x' = 0$  then  $t = 1/2$  second and the extreme displacement is  $x = e^{-2}$  feet.

Exercises 5.1

22. From  $\frac{1}{4}x'' + \sqrt{2}x' + 2x = 0$ ,  $x(0) = 0$ , and  $x'(0) = 5$  we obtain  $x = 5te^{-2\sqrt{2}t}$  and  $x' = 5e^{-2\sqrt{2}t}(1 - 2\sqrt{2}t)$ . If  $x' = 0$  then  $t = \sqrt{2}/4$  second and the extreme displacement is  $x = 5\sqrt{2}e^{-1}/4$  feet.
23. (a) From  $x'' + 10x' + 16x = 0$ ,  $x(0) = 1$ , and  $x'(0) = 0$  we obtain  $x = \frac{4}{3}e^{-2t} - \frac{1}{3}e^{-8t}$ .
- (b) From  $x'' + x' + 16x = 0$ ,  $x(0) = 1$ , and  $x'(0) = -12$  then  $x = -\frac{2}{3}e^{-2t} + \frac{5}{3}e^{-8t}$ .
24. (a)  $x = \frac{1}{3}e^{-8t}(4e^{6t} - 1)$  is never zero; the extreme displacement is  $x(0) = 1$  meter.
- (b)  $x = \frac{1}{3}e^{-8t}(5 - 2e^{6t}) = 0$  when  $t = \frac{1}{6} \ln \frac{5}{2} \approx 0.153$  second; if  $x' = \frac{4}{3}e^{-8t}(e^{6t} - 10) = 0$  then  $t = \frac{1}{6} \ln 10 \approx 0.384$  second and the extreme displacement is  $x = -0.232$  meter.
25. (a) From  $0.1x'' + 0.4x' + 2x = 0$ ,  $x(0) = -1$ , and  $x'(0) = 0$  we obtain  $x = e^{-2t}[-\cos 4t - \frac{1}{2}\sin 4t]$ .
- (b)  $x = e^{-2t} \frac{\sqrt{5}}{2} \left[ -\frac{2}{\sqrt{5}} \cos 4t - \frac{1}{\sqrt{5}} \sin 4t \right] = \frac{\sqrt{5}}{2} e^{-2t} \sin(4t + 4.25)$ .
- (c) If  $x = 0$  then  $4t + 4.25 = 2\pi, 3\pi, 4\pi, \dots$  so that the first time heading upward is  $t = 1.294$  seconds.
26. (a) From  $\frac{1}{4}x'' + x' + 5x = 0$ ,  $x(0) = 1/2$ , and  $x'(0) = 1$  we obtain  $x = e^{-2t}(\frac{1}{2}\cos 4t + \frac{1}{2}\sin 4t)$ .
- (b)  $x = e^{-2t} \frac{1}{\sqrt{2}} \left( \frac{\sqrt{2}}{2} \cos 4t + \frac{\sqrt{2}}{2} \sin 4t \right) = \frac{1}{\sqrt{2}} e^{-2t} \sin\left(4t + \frac{\pi}{4}\right)$ .
- (c) If  $x = 0$  then  $4t + \pi/4 = \pi, 2\pi, 3\pi, \dots$  so that the times heading downward are  $t = (7+8n)\pi/16$  for  $n = 0, 1, 2, \dots$ .

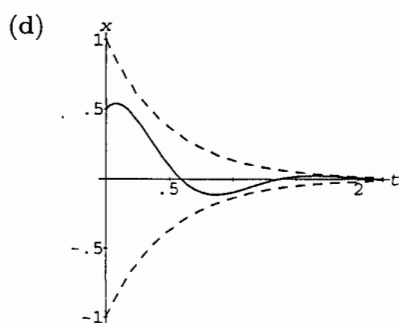

27. From  $\frac{5}{16}x'' + \beta x' + 5x = 0$  we find that the roots of the auxiliary equation are  $m = -\frac{8}{5}\beta \pm \frac{4}{5}\sqrt{4\beta^2 - 25}$ .
- (a) If  $4\beta^2 - 25 > 0$  then  $\beta > 5/2$ .
- (b) If  $4\beta^2 - 25 = 0$  then  $\beta = 5/2$ .
- (c) If  $4\beta^2 - 25 < 0$  then  $0 < \beta < 5/2$ .

### Exercises 5.1

28. From  $0.75x'' + \beta x' + 6x = 0$  and  $\beta > 3\sqrt{2}$  we find that the roots of the auxiliary equation are

$$m = -\frac{2}{3}\beta \pm \frac{2}{3}\sqrt{\beta^2 - 18} \text{ and}$$

$$x = e^{-2\beta t/3} \left[ c_1 \cosh \frac{2}{3}\sqrt{\beta^2 - 18} t + c_2 \sinh \frac{2}{3}\sqrt{\beta^2 - 18} t \right].$$

If  $x(0) = 0$  and  $x'(0) = -2$  then  $c_1 = 0$  and  $c_2 = -3/\sqrt{\beta^2 - 18}$ .

29. If  $\frac{1}{2}x'' + \frac{1}{2}x' + 6x = 10 \cos 3t$ ,  $x(0) = -2$ , and  $x'(0) = 0$  then

$$x_c = e^{-t/2} \left( c_1 \cos \frac{\sqrt{47}}{2} t + c_2 \sin \frac{\sqrt{47}}{2} t \right)$$

and  $x_p = \frac{10}{3}(\cos 3t + \sin 3t)$  so that the equation of motion is

$$x = e^{-t/2} \left( -\frac{4}{3} \cos \frac{\sqrt{47}}{2} t - \frac{64}{3\sqrt{47}} \sin \frac{\sqrt{47}}{2} t \right) + \frac{10}{3}(\cos 3t + \sin 3t).$$

30. (a) If  $x'' + 2x' + 5x = 12 \cos 2t + 3 \sin 2t$ ,  $x(0) = -1$ , and  $x'(0) = 5$  then  $x_c = e^{-t}(c_1 \cos 2t + c_2 \sin 2t)$  and  $x_p = 3 \sin 2t$  so that the equation of motion is

$$x = e^{-t} \cos 2t + 3 \sin 2t.$$

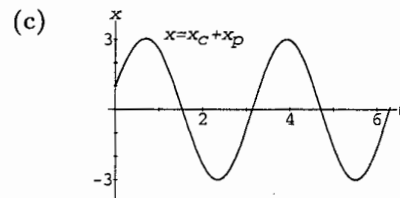
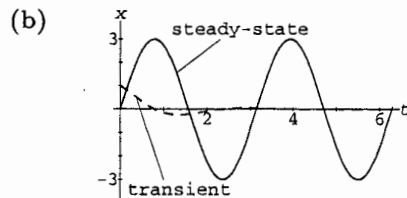

31. From  $x'' + 8x' + 16x = 8 \sin 4t$ ,  $x(0) = 0$ , and  $x'(0) = 0$  we obtain  $x_c = c_1 e^{-4t} + c_2 t e^{-4t}$  and  $x_p = -\frac{1}{4} \cos 4t$  so that the equation of motion is

$$x = \frac{1}{4} e^{-4t} + t e^{-4t} - \frac{1}{4} \cos 4t.$$

32. From  $x'' + 8x' + 16x = e^{-t} \sin 4t$ ,  $x(0) = 0$ , and  $x'(0) = 0$  we obtain  $x_c = c_1 e^{-4t} + c_2 t e^{-4t}$  and  $x_p = -\frac{24}{625} e^{-t} \cos 4t - \frac{7}{625} e^{-t} \sin 4t$  so that

$$x = \frac{1}{625} e^{-4t} (24 + 100t) - \frac{1}{625} e^{-t} (24 \cos 4t + 7 \sin 4t).$$

As  $t \rightarrow \infty$  the displacement  $x \rightarrow 0$ .

33. From  $2x'' + 32x = 68e^{-2t} \cos 4t$ ,  $x(0) = 0$ , and  $x'(0) = 0$  we obtain  $x_c = c_1 \cos 4t + c_2 \sin 4t$  and  $x_p = \frac{1}{2} e^{-2t} \cos 4t - 2e^{-2t} \sin 4t$  so that

$$x = -\frac{1}{2} \cos 4t + \frac{9}{4} \sin 4t + \frac{1}{2} e^{-2t} \cos 4t - 2e^{-2t} \sin 4t.$$

Exercises 5.1

34. Since  $x = \frac{\sqrt{85}}{4} \sin(4t - 0.219) - \frac{\sqrt{17}}{2} e^{-2t} \sin(4t - 2.897)$ , the amplitude approaches  $\sqrt{85}/4$  as  $t \rightarrow \infty$ .

35. (a) By Hooke's law the external force is  $F(t) = kh(t)$  so that  $mx'' + \beta x' + kx = kh(t)$ .

(b) From  $\frac{1}{2}x'' + 2x' + 4x = 20 \cos t$ ,  $x(0) = 0$ , and  $x'(0) = 0$  we obtain  $x_c = e^{-2t}(c_1 \cos 2t + c_2 \sin 2t)$  and  $x_p = \frac{56}{13} \cos t + \frac{32}{13} \sin t$  so that

$$x = e^{-2t} \left( -\frac{56}{13} \cos 2t - \frac{72}{13} \sin 2t \right) + \frac{56}{13} \cos t + \frac{32}{13} \sin t.$$

36. (a) From  $100x'' + 1600x = 1600 \sin 8t$ ,  $x(0) = 0$ , and  $x'(0) = 0$  we obtain  $x_c = c_1 \cos 4t + c_2 \sin 4t$  and  $x_p = -\frac{1}{3} \sin 8t$  so that

$$x = \frac{2}{3} \sin 4t - \frac{1}{3} \sin 8t.$$

(b) If  $x = \frac{1}{3} \sin 4t(2 - 2 \cos 4t) = 0$  then  $t = n\pi/4$  for  $n = 0, 1, 2, \dots$ .

(c) If  $x' = \frac{8}{3} \cos 4t - \frac{8}{3} \cos 8t = \frac{8}{3}(1 - \cos 4t)(1 + 2 \cos 4t) = 0$  then  $t = \pi/3 + n\pi/2$  and  $t = \pi/6 + n\pi/2$  for  $n = 0, 1, 2, \dots$  at the extreme values. *Note:* There are many other values of  $t$  for which  $x' = 0$ .

(d)  $x(\pi/6 + n\pi/2) = \sqrt{3}/2$  cm. and  $x(\pi/3 + n\pi/2) = -\sqrt{3}/2$  cm.

(e)

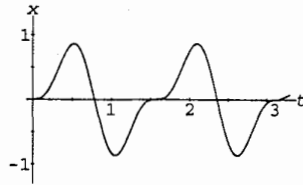

37. From  $x'' + 4x = -5 \sin 2t + 3 \cos 2t$ ,  $x(0) = -1$ , and  $x'(0) = 1$  we obtain  $x_c = c_1 \cos 2t + c_2 \sin 2t$ ,  $x_p = \frac{3}{4}t \sin 2t + \frac{5}{4}t \cos 2t$ , and

$$x = -\cos 2t - \frac{1}{8} \sin 2t + \frac{3}{4}t \sin 2t + \frac{5}{4}t \cos 2t.$$

38. From  $x'' + 9x = 5 \sin 3t$ ,  $x(0) = 2$ , and  $x'(0) = 0$  we obtain  $x_c = c_1 \cos 3t + c_2 \sin 3t$ ,  $x_p = -\frac{5}{6}t \cos 3t$ , and

$$x = 2 \cos 3t + \frac{5}{18} \sin 3t - \frac{5}{6}t \cos 3t.$$

39. (a) From  $x'' + \omega^2 x = F_0 \cos \gamma t$ ,  $x(0) = 0$ , and  $x'(0) = 0$  we obtain  $x_c = c_1 \cos \omega t + c_2 \sin \omega t$  and  $x_p = (F_0 \cos \gamma t)/(\omega^2 - \gamma^2)$  so that

$$x = -\frac{F_0}{\omega^2 - \gamma^2} \cos \omega t + \frac{F_0}{\omega^2 - \gamma^2} \cos \gamma t.$$

### Exercises 5.1

$$(b) \lim_{\gamma \rightarrow \omega} \frac{F_0}{\omega^2 - \gamma^2} (\cos \gamma t - \cos \omega t) = \lim_{\gamma \rightarrow \omega} \frac{-F_0 t \sin \gamma t}{-2\gamma} = \frac{F_0}{2\omega} t \sin \omega t.$$

40. From  $x'' + \omega^2 x = F_0 \cos \omega t$ ,  $x(0) = 0$ , and  $x'(0) = 0$  we obtain  $x_c = c_1 \cos \omega t + c_2 \sin \omega t$  and  $x_p = (F_0 t / 2\omega) \sin \omega t$  so that  $x = (F_0 t / 2\omega) \sin \omega t$  and  $\lim_{\gamma \rightarrow \omega} \frac{F_0}{2\omega} t \sin \omega t = \frac{F_0}{2\omega} t \sin \omega t$ .

41. (a) From  $\cos(u - v) = \cos u \cos v + \sin u \sin v$  and  $\cos(u + v) = \cos u \cos v - \sin u \sin v$  we obtain  $\sin u \sin v = \frac{1}{2}[\cos(u - v) - \cos(u + v)]$ . Letting  $u = \frac{1}{2}(\gamma - \omega)t$  and  $v = \frac{1}{2}(\gamma + \omega)t$ , the result follows.

(b) If  $\epsilon = \frac{1}{2}(\gamma - \omega)$  then  $\gamma \approx \omega$  so that  $x = (F_0 / 2\epsilon\gamma) \sin \epsilon t \sin \gamma t$ .

42. See the article "Distinguished Oscillations of a Forced Harmonic Oscillator" by T.G. Procter in *The College Mathematics Journal*, March, 1995. In this article the author illustrates that for  $F_0 = 1$ ,  $\lambda = 0.01$ ,  $\gamma = 22/9$ , and  $\omega = 2$  the system exhibits beats oscillations on the interval  $[0, 9\pi]$ , but that this phenomenon is transient as  $t \rightarrow \infty$ .



43. (a) The general solution of the homogeneous equation is

$$\begin{aligned} x_c(t) &= c_1 e^{-\lambda t} \cos(\sqrt{\omega^2 - \lambda^2} t) + c_2 e^{-\lambda t} \sin(\sqrt{\omega^2 - \lambda^2} t) \\ &= A e^{-\lambda t} \sin[\sqrt{\omega^2 - \lambda^2} t + \phi], \end{aligned}$$

where  $A = \sqrt{c_1^2 + c_2^2}$ ,  $\sin \phi = c_1/A$ , and  $\cos \phi = c_2/A$ . Now

$$x_p(t) = \frac{F_0(\omega^2 - \gamma^2)}{(\omega^2 - \gamma^2)^2 + 4\lambda^2\gamma^2} \sin \gamma t + \frac{F_0(-2\lambda\gamma)}{(\omega^2 - \gamma^2)^2 + 4\lambda^2\gamma^2} \cos \gamma t = A \sin(\gamma t + \theta),$$

where

$$\sin \theta = \frac{\frac{F_0(-2\lambda\gamma)}{(\omega^2 - \gamma^2)^2 + 4\lambda^2\gamma^2}}{\frac{F_0}{\sqrt{(\omega^2 - \gamma^2)^2 + 4\lambda^2\gamma^2}}} = \frac{-2\lambda\gamma}{\sqrt{(\omega^2 - \gamma^2)^2 + 4\lambda^2\gamma^2}}$$

and

$$\cos \theta = \frac{\frac{F_0(\omega^2 - \gamma^2)}{(\omega^2 - \gamma^2)^2 + 4\lambda^2\gamma^2}}{\frac{F_0}{\sqrt{(\omega^2 - \gamma^2)^2 + 4\lambda^2\gamma^2}}} = \frac{\omega^2 - \gamma^2}{\sqrt{(\omega^2 - \gamma^2)^2 + 4\lambda^2\gamma^2}}.$$



Exercises 5.1

- (b) If  $g'(\gamma) = 0$  then  $\gamma(\gamma^2 + 2\lambda^2 - \omega^2) = 0$  so that  $\gamma = 0$  or  $\gamma = \sqrt{\omega^2 - 2\lambda^2}$ . The first derivative test shows that  $g$  has a maximum value at  $\gamma = \sqrt{\omega^2 - 2\lambda^2}$ . The maximum value of  $g$  is

$$g\left(\sqrt{\omega^2 - 2\lambda^2}\right) = F_0/2\lambda\sqrt{\omega^2 - \lambda^2}.$$

- (c) We identify  $\omega^2 = k/m = 4$ ,  $\lambda = \beta/2$ , and  $\gamma_1 = \sqrt{\omega^2 - 2\lambda^2} = \sqrt{4 - \beta^2/2}$ . As  $\beta \rightarrow 0$ ,  $\gamma_1 \rightarrow 2$  and the resonance curve grows without bound at  $\gamma_1 = 2$ . That is, the system approaches pure resonance.

$\beta$	$\gamma_1$	$g$
2.00	1.41	0.58
1.00	1.87	1.03
0.75	1.93	1.36
0.50	1.97	2.02
0.25	1.99	4.01

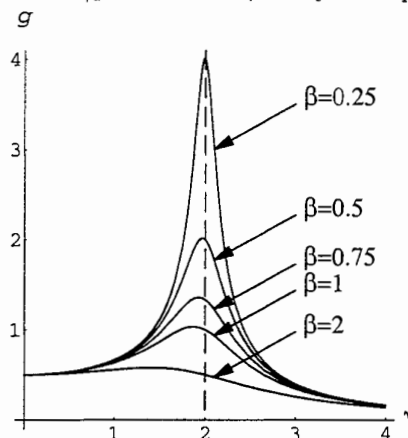

44. (a) For  $n = 2$ ,  $\sin^2 \gamma t = \frac{1}{2}(1 - \cos 2\gamma t)$ . The system is in pure resonance when  $2\gamma_1/2\pi = \omega/2\pi$ , or when  $\gamma_1 = \omega/2$ .
- (b) Note that

$$\sin^3 \gamma t = \sin \gamma t \sin^2 \gamma t = \frac{1}{2}[\sin \gamma t - \sin \gamma t \cos 2\gamma t].$$

Now

$$\sin(A + B) + \sin(A - B) = 2 \sin A \cos B$$

so

$$\sin \gamma t \cos 2\gamma t = \frac{1}{2}[\sin 3\gamma t - \sin \gamma t]$$

and

$$\sin^3 \gamma t = \frac{3}{4} \sin \gamma t - \frac{1}{4} \sin 3\gamma t.$$

Thus

$$x'' + \omega^2 x = \frac{3}{4} \sin \gamma t - \frac{1}{4} \sin 3\gamma t.$$

The frequency of free vibration is  $\omega/2\pi$ . Thus, when  $\gamma_1/2\pi = \omega/2\pi$  or  $\gamma_1 = \omega$ , and when  $3\gamma_2/2\pi = \omega/2\pi$  or  $3\gamma_2 = \omega$  or  $\gamma_3 = \omega/3$ , the system will be in pure resonance.

### Exercises 5.1

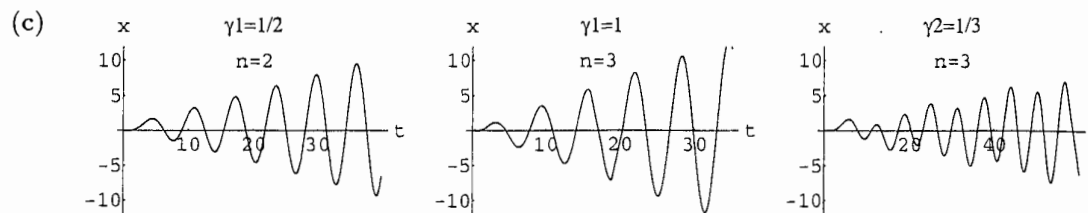

45. Solving  $\frac{1}{20}q'' + 2q' + 100q = 0$  we obtain  $q(t) = e^{-20t}(c_1 \cos 40t + c_2 \sin 40t)$ . The initial conditions  $q(0) = 5$  and  $q'(0) = 0$  imply  $c_1 = 5$  and  $c_2 = 5/2$ . Thus

$$q(t) = e^{-20t} \left( 5 \cos 40t + \frac{5}{2} \sin 40t \right) \approx \sqrt{25 + 25/4} e^{-20t} \sin(40t + 1.1071)$$

and  $q(0.01) \approx 4.5676$  coulombs. The charge is zero for the first time when  $40t + 0.4636 = \pi$  or  $t \approx 0.0509$  second.

46. Solving  $\frac{1}{4}q'' + 20q' + 300q = 0$  we obtain  $q(t) = c_1 e^{-20t} + c_2 e^{-60t}$ . The initial conditions  $q(0) = 4$  and  $q'(0) = 0$  imply  $c_1 = 6$  and  $c_2 = -2$ . Thus

$$q(t) = 6e^{-20t} - 2e^{-60t}.$$

Setting  $q = 0$  we find  $e^{40t} = 1/3$  which implies  $t < 0$ . Therefore the charge is never 0.

47. Solving  $\frac{5}{3}q'' + 10q' + 30q = 300$  we obtain  $q(t) = e^{-3t}(c_1 \cos 3t + c_2 \sin 3t) + 10$ . The initial conditions  $q(0) = q'(0) = 0$  imply  $c_1 = c_2 = -10$ . Thus

$$q(t) = 10 - 10e^{-3t}(\cos 3t + \sin 3t) \quad \text{and} \quad i(t) = 60e^{3t} \sin 3t.$$

Solving  $i(t) = 0$  we see that the maximum charge occurs when  $t = \pi/3$  and  $q(\pi/3) \approx 10.432$ .

48. Solving  $q'' + 100q' + 2500q = 30$  we obtain  $q(t) = c_1 e^{-50t} + c_2 t e^{-50t} + 0.012$ . The initial conditions  $q(0) = 0$  and  $q'(0) = 2$  imply  $c_1 = -0.012$  and  $c_2 = 1.4$ . Thus

$$q(t) = -0.012e^{-50t} + 1.4te^{-50t} + 0.012 \quad \text{and} \quad i(t) = 2e^{-50t} - 70te^{-50t}.$$

Solving  $i(t) = 0$  we see that the maximum charge occurs when  $t = 1/35$  and  $q(1/35) \approx 0.01871$ .

49. Solving  $q'' + 2q' + 4q = 0$  we obtain  $y_c = e^{-t}(\cos \sqrt{3}t + \sin \sqrt{3}t)$ . The steady-state charge has the form  $y_p = A \cos t + B \sin t$ . Substituting into the differential equation we find

$$(3A + 2B) \cos t + (3B - 2A) \sin t = 50 \cos t.$$

Thus,  $A = 150/13$  and  $B = 100/13$ . The steady-state charge is

$$q_p(t) = \frac{150}{13} \cos t + \frac{100}{13} \sin t$$

and the steady-state current is

$$i_p(t) = -\frac{150}{13} \sin t + \frac{100}{13} \cos t.$$

50. From

$$i_p(t) = \frac{E_0}{Z} \left( \frac{R}{Z} \sin \gamma t - \frac{X}{Z} \cos \gamma t \right)$$

and  $Z = \sqrt{X^2 + R^2}$  we see that the amplitude of  $i_p(t)$  is

$$A = \sqrt{\frac{E_0^2 R^2}{Z^4} + \frac{E_0^2 X^2}{Z^4}} = \frac{E_0}{Z^2} \sqrt{R^2 + X^2} = \frac{E_0}{Z}.$$

51. The differential equation is  $\frac{1}{2}q'' + 20q' + 1000q = 100 \sin t$ . To use Example 10 in the text we identify  $E_0 = 100$  and  $\gamma = 60$ . Then

$$X = L\gamma - \frac{1}{c\gamma} = \frac{1}{2}(60) - \frac{1}{0.001(60)} \approx 13.3333,$$

$$Z = \sqrt{X^2 + R^2} = \sqrt{X^2 + 400} \approx 24.0370,$$

and

$$\frac{E_0}{Z} = \frac{100}{Z} \approx 4.1603.$$

From Problem 50, then

$$i_p(t) \approx 4.1603(60t + \phi)$$

where  $\sin \phi = -X/Z$  and  $\cos \phi = R/Z$ . Thus  $\tan \phi = -X/R \approx -0.6667$  and  $\phi$  is a fourth quadrant angle. Now  $\phi \approx -0.5880$  and

$$i_p(t) \approx 4.1603(60t - 0.5880).$$

52. Solving  $\frac{1}{2}q'' + 20q' + 1000q = 0$  we obtain  $q_c(t) = (c_1 \cos 40t + c_2 \sin 40t)$ . The steady-state charge has the form  $q_p(t) = A \sin 60t + B \cos 60t + C \sin 40t + D \cos 40t$ . Substituting into the differential equation we find

$$\begin{aligned} & (-1600A - 2400B) \sin 60t + (2400A - 1600B) \cos 60t \\ & + (400C - 1600D) \sin 40t + (1600C + 400D) \cos 40t \\ & = 200 \sin 60t + 400 \cos 40t. \end{aligned}$$

Equating coefficients we obtain  $A = -1/26$ ,  $B = -3/52$ ,  $C = 4/17$ , and  $D = 1/17$ . The steady-state charge is

$$q_p(t) = -\frac{1}{26} \sin 60t - \frac{3}{52} \cos 60t + \frac{4}{17} \sin 40t + \frac{1}{17} \cos 40t$$

and the steady-state current is

$$i_p(t) = -\frac{30}{13} \cos 60t + \frac{45}{13} \sin 60t + \frac{160}{17} \cos 40t - \frac{40}{17} \sin 40t.$$

### Exercises 5.1

53. Solving  $\frac{1}{2}q'' + 10q' + 100q = 150$  we obtain  $q(t) = e^{-10t}(c_1 \cos 10t + c_2 \sin 10t) + 3/2$ . The initial conditions  $q(0) = 1$  and  $q'(0) = 0$  imply  $c_1 = c_2 = -1/2$ . Thus

$$q(t) = -\frac{1}{2}e^{-10t}(\cos 10t + \sin 10t) + \frac{3}{2}.$$

As  $t \rightarrow \infty$ ,  $q(t) \rightarrow 3/2$ .

54. By Problem 50 the amplitude of the steady-state current is  $E_0/Z$ , where  $Z = \sqrt{X^2 + R^2}$  and  $X = L\gamma - 1/C\gamma$ . Since  $E_0$  is constant the amplitude will be a maximum when  $Z$  is a minimum. Since  $R$  is constant,  $Z$  will be a minimum when  $X = 0$ . Solving  $L\gamma - 1/C\gamma = 0$  for  $\gamma$  we obtain  $\gamma = 1/\sqrt{LC}$ . The maximum amplitude will be  $E_0/R$ .
55. By Problem 50 the amplitude of the steady-state current is  $E_0/Z$ , where  $Z = \sqrt{X^2 + R^2}$  and  $X = L\gamma - 1/C\gamma$ . Since  $E_0$  is constant the amplitude will be a maximum when  $Z$  is a minimum. Since  $R$  is constant,  $Z$  will be a minimum when  $X = 0$ . Solving  $L\gamma - 1/C\gamma = 0$  for  $C$  we obtain  $C = 1/L\gamma^2$ .
56. Solving  $0.1q'' + 10q = 100 \sin \gamma t$  we obtain  $q(t) = c_1 \cos 10t + c_2 \sin 10t + q_p(t)$  where  $q_p(t) = A \sin \gamma t + B \cos \gamma t$ . Substituting  $q_p(t)$  into the differential equation we find

$$(100 - \gamma^2)A \sin \gamma t + (100 - \gamma^2)B \cos \gamma t = 100 \sin \gamma t.$$

Equating coefficients we obtain  $A = 100/(100 - \gamma^2)$  and  $B = 0$ . Thus,  $q_p(t) = \frac{100}{100 - \gamma^2} \sin \gamma t$ . The initial conditions  $q(0) = q'(0) = 0$  imply  $c_1 = 0$  and  $c_2 = -10\gamma/(100 - \gamma^2)$ . The charge is

$$q(t) = \frac{10}{100 - \gamma^2}(10 \sin \gamma t - \gamma \sin 10t)$$

and the current is

$$i(t) = \frac{100\gamma}{100 - \gamma^2}(\cos \gamma t - \cos 10t).$$

57. In an  $L$ - $C$  series circuit there is no resistor, so the differential equation is

$$L \frac{d^2q}{dt^2} + \frac{1}{C} q = E(t).$$

Then  $q(t) = c_1 \cos(t/\sqrt{LC}) + c_2 \sin(t/\sqrt{LC}) + q_p(t)$  where  $q_p(t) = A \sin \gamma t + B \cos \gamma t$ . Substituting  $q_p(t)$  into the differential equation we find

$$\left(\frac{1}{C} - L\gamma^2\right) A \sin \gamma t + \left(\frac{1}{C} - L\gamma^2\right) B \cos \gamma t = E_0 \cos \gamma t.$$

Equating coefficients we obtain  $A = 0$  and  $B = E_0 C / (1 - LC\gamma^2)$ . Thus, the charge is

$$q(t) = c_1 \cos \frac{1}{\sqrt{LC}} t + c_2 \sin \frac{1}{\sqrt{LC}} t + \frac{E_0 C}{1 - LC\gamma^2} \cos \gamma t.$$

## Exercises 5.2

The initial conditions  $q(0) = q_0$  and  $q'(0) = i_0$  imply  $c_1 = q_0 - E_0C/(1 - LC\gamma^2)$  and  $c_2 = i_0\sqrt{LC}$ . The current is

$$\begin{aligned} i(t) &= -\frac{c_1}{\sqrt{LC}} \sin \frac{1}{\sqrt{LC}} t + \frac{c_2}{\sqrt{LC}} \cos \frac{1}{\sqrt{LC}} t - \frac{E_0C\gamma}{1 - LC\gamma^2} \sin \gamma t \\ &= i_0 \cos \frac{1}{\sqrt{LC}} t - \frac{1}{\sqrt{LC}} \left( q_0 - \frac{E_0C}{1 - LC\gamma^2} \right) \sin \frac{1}{\sqrt{LC}} t - \frac{E_0C\gamma}{1 - LC\gamma^2} \sin \gamma t. \end{aligned}$$

58. When the circuit is in resonance the form of  $q_p(t)$  is  $q_p(t) = At \cos kt + Bt \sin kt$  where  $k = 1/\sqrt{LC}$ . Substituting  $q_p(t)$  into the differential equation we find

$$q_p'' + k^2 q_p = -2kA \sin kt + 2kB \cos kt = \frac{E_0}{L} \cos kt.$$

Equating coefficients we obtain  $A = 0$  and  $B = E_0/2kL$ . The charge is

$$q(t) = c_1 \cos kt + c_2 \sin kt + \frac{E_0}{2kL} t \sin kt.$$

The initial conditions  $q(0) = q_0$  and  $q'(0) = i_0$  imply  $c_1 = q_0$  and  $c_2 = i_0/k$ . The current is

$$\begin{aligned} i(t) &= -c_1 k \sin kt + c_2 k \cos kt + \frac{E_0}{2kL} (kt \cos kt + \sin kt) \\ &= \left( \frac{E_0}{2kL} - q_0 k \right) \sin kt + i_0 \cos kt + \frac{E_0}{2L} t \cos kt. \end{aligned}$$

---

## Exercises 5.2

---

1. (a) The general solution is

$$y(x) = c_1 + c_2 x + c_3 x^2 + c_4 x^3 + \frac{w_0}{24EI} x^4.$$

The boundary conditions are  $y(0) = 0$ ,  $y'(0) = 0$ ,  $y''(L) = 0$ ,  $y'''(L) = 0$ . The first two conditions give  $c_1 = 0$  and  $c_2 = 0$ . The conditions at  $x = L$  give the system

$$\begin{aligned} 2c_3 + 6c_4 L + \frac{w_0}{2EI} L^2 &= 0 \\ 6c_4 + \frac{w_0}{EI} L &= 0. \end{aligned}$$

Solving, we obtain  $c_3 = w_0 L^2/4EI$  and  $c_4 = -w_0 L/6EI$ . The deflection is

$$y(x) = \frac{w_0}{24EI} (6L^2 x^2 - 4L x^3 + x^4).$$

### Exercises 5.2

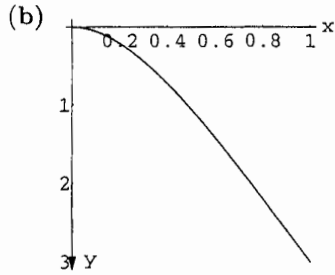

2. (a) The general solution is

$$y(x) = c_1 + c_2x + c_3x^2 + c_4x^3 + \frac{w_0}{24EI}x^4.$$

The boundary conditions are  $y(0) = 0$ ,  $y'(0) = 0$ ,  $y(L) = 0$ ,  $y'(L) = 0$ . The first two conditions give  $c_1 = 0$  and  $c_3 = 0$ . The conditions at  $x = L$  give the system

$$\begin{aligned} c_2L + c_4L^3 + \frac{w_0}{24EI}L^4 &= 0 \\ 6c_4L + \frac{w_0}{2EI}L^2 &= 0. \end{aligned}$$

Solving, we obtain  $c_2 = w_0L^3/24EI$  and  $c_4 = -w_0L/12EI$ . The deflection is

$$y(x) = \frac{w_0}{24EI}(L^3x - 2Lx^3 + x^4).$$

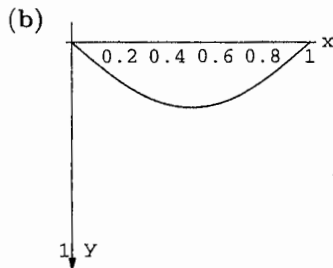

3. (a) The general solution is

$$y(x) = c_1 + c_2x + c_3x^2 + c_4x^3 + \frac{w_0}{24EI}x^4.$$

The boundary conditions are  $y(0) = 0$ ,  $y'(0) = 0$ ,  $y(L) = 0$ ,  $y'(L) = 0$ . The first two conditions give  $c_1 = 0$  and  $c_2 = 0$ . The conditions at  $x = L$  give the system

$$\begin{aligned} c_3L^2 + c_4L^3 + \frac{w_0}{24EI}L^4 &= 0 \\ 2c_3 + 6c_4L + \frac{w_0}{2EI}L^2 &= 0. \end{aligned}$$

Exercises 5.2

Solving, we obtain  $c_3 = w_0L^2/16EI$  and  $c_4 = -5w_0L/48EI$ . The deflection is

$$y(x) = \frac{w_0}{48EI}(3L^2x^2 - 5Lx^3 + 2x^4).$$

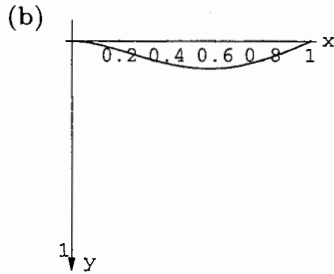

4. (a) The general solution is

$$y(x) = c_1 + c_2x + c_3x^2 + c_4x^3 + \frac{w_0L^4}{EI\pi^4} \sin \frac{\pi}{L}x.$$

The boundary conditions are  $y(0) = 0$ ,  $y'(0) = 0$ ,  $y(L) = 0$ ,  $y''(L) = 0$ . The first two conditions give  $c_1 = 0$  and  $c_2 = -w_0L^3/EI\pi^3$ . The conditions at  $x = L$  give the system

$$c_3L^2 + c_4L^3 + \frac{w_0}{EI\pi^3}L^4 = 0$$

$$2c_3 + 6c_4L = 0.$$

Solving, we obtain  $c_3 = 3w_0L^2/2EI\pi^3$  and  $c_4 = -w_0L/2EI\pi^3$ . The deflection is

$$y(x) = \frac{w_0L}{2EI\pi^3} \left( -2L^2x + 3Lx^2 - x^3 + \frac{2L^3}{\pi} \sin \frac{\pi}{L}x \right).$$

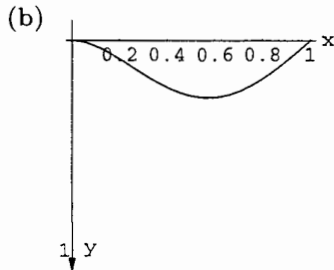

(c) Using a CAS we find the maximum deflection to be 0.270806 when  $x = 0.572536$ .

5. (a) The general solution is

$$y(x) = c_1 + c_2x + c_3x^2 + c_4x^3 + \frac{w_0}{120EI}x^5.$$

## Exercises 5.2

The boundary conditions are  $y(0) = 0$ ,  $y''(0) = 0$ ,  $y(L) = 0$ ,  $y''(L) = 0$ . The first two conditions give  $c_1 = 0$  and  $c_3 = 0$ . The conditions at  $x = L$  give the system

$$c_2L + c_4L^3 + \frac{w_0}{120EI}L^5 = 0.$$

$$6c_4L + \frac{w_0}{6EI}L^3 = 0.$$

Solving, we obtain  $c_2 = 7w_0L^4/360EI$  and  $c_4 = -w_0L^2/36EI$ . The deflection is

$$y(x) = \frac{w_0}{360EI}(7L^4x - 10L^2x^3 + 3x^5).$$

(b)

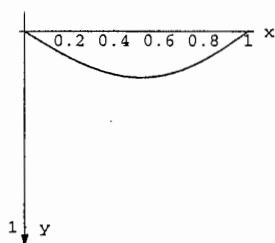

(c) Using a CAS we find the maximum deflection to be 0.234799 when  $x = 0.51933$ .

6. (a)  $y_{\max} = y(L) = \frac{w_0L^4}{8EI}$   
 (b) Replacing both  $L$  and  $x$  by  $L/2$  in  $y(x)$  we obtain  $w_0L^4/128EI$ , which is  $1/16$  of the maximum deflection when the length of the beam is  $L$ .  
 (c)  $y_{\max} = y(L/2) = \frac{5w_0L^4}{384EI}$   
 (d) The maximum deflection in Example 1 is  $y(L/2) = (w_0/24EI)L^4/16 = w_0L^4/384EI$ , which is  $1/5$  of the maximum displacement of the beam in Problem 2.
7. The general solution of the differential equation is

$$y = c_1 \cosh \sqrt{\frac{P}{EI}} x + c_2 \sinh \sqrt{\frac{P}{EI}} x + \frac{w_0}{2P} x^2 + \frac{w_0EI}{P^2}.$$

Setting  $y(0) = 0$  we obtain  $c_1 = -w_0EI/P^2$ , so that

$$y = -\frac{w_0EI}{P^2} \cosh \sqrt{\frac{P}{EI}} x + c_2 \sinh \sqrt{\frac{P}{EI}} x + \frac{w_0}{2P} x^2 + \frac{w_0EI}{P^2}.$$

Setting  $y'(L) = 0$  we find

$$c_2 = \left( \sqrt{\frac{P}{EI}} \frac{w_0EI}{P^2} \sinh \sqrt{\frac{P}{EI}} L - \frac{w_0L}{P} \right) / \sqrt{\frac{P}{EI}} \cosh \sqrt{\frac{P}{EI}} L.$$



8. The general solution of the differential equation is

$$y = c_1 \cos \sqrt{\frac{P}{EI}} x + c_2 \sin \sqrt{\frac{P}{EI}} x + \frac{w_0}{2P} x^2 + \frac{w_0 EI}{P^2}.$$

Setting  $y(0) = 0$  we obtain  $c_1 = -w_0 EI/P^2$ , so that

$$y = -\frac{w_0 EI}{P^2} \cos \sqrt{\frac{P}{EI}} x + c_2 \sin \sqrt{\frac{P}{EI}} x + \frac{w_0}{2P} x^2 + \frac{w_0 EI}{P^2}.$$

Setting  $y'(L) = 0$  we find

$$c_2 = \left( -\sqrt{\frac{P}{EI}} \frac{w_0 EI}{P^2} \sin \sqrt{\frac{P}{EI}} L - \frac{w_0 L}{P} \right) / \left( \sqrt{\frac{P}{EI}} \cos \sqrt{\frac{P}{EI}} L \right).$$

9. For  $\lambda \leq 0$  the only solution of the boundary-value problem is  $y = 0$ . For  $\lambda > 0$  we have

$$y = c_1 \cos \sqrt{\lambda} x + c_2 \sin \sqrt{\lambda} x.$$

Now  $y(0) = 0$  implies  $c_1 = 0$ , so

$$y(\pi) = c_2 \sin \sqrt{\lambda} \pi = 0$$

gives

$$\sqrt{\lambda} \pi = n\pi \quad \text{or} \quad \lambda = n^2, \quad n = 1, 2, 3, \dots$$

The eigenvalues  $n^2$  correspond to the eigenfunctions  $\sin nx$  for  $n = 1, 2, 3, \dots$

10. For  $\lambda \leq 0$  the only solution of the boundary-value problem is  $y = 0$ . For  $\lambda > 0$  we have

$$y = c_1 \cos \sqrt{\lambda} x + c_2 \sin \sqrt{\lambda} x.$$

Now  $y(0) = 0$  implies  $c_1 = 0$ , so

$$y\left(\frac{\pi}{4}\right) = c_2 \sin \sqrt{\lambda} \frac{\pi}{4} = 0$$

gives

$$\sqrt{\lambda} \frac{\pi}{4} = n\pi \quad \text{or} \quad \lambda = 16n^2, \quad n = 1, 2, 3, \dots$$

The eigenvalues  $16n^2$  correspond to the eigenfunctions  $\sin 4nx$  for  $n = 1, 2, 3, \dots$

11. For  $\lambda \leq 0$  the only solution of the boundary-value problem is  $y = 0$ . For  $\lambda > 0$  we have

$$y = c_1 \cos \sqrt{\lambda} x + c_2 \sin \sqrt{\lambda} x.$$

Now

$$y'(x) = -c_1 \sqrt{\lambda} \sin \sqrt{\lambda} x + c_2 \sqrt{\lambda} \cos \sqrt{\lambda} x$$

and  $y'(0) = 0$  implies  $c_2 = 0$ , so

$$y(L) = c_1 \cos \sqrt{\lambda} L = 0$$

## Exercises 5.2

gives

$$\sqrt{\lambda}L = \frac{(2n-1)\pi}{2} \quad \text{or} \quad \lambda = \frac{(2n-1)^2\pi^2}{4L^2}, \quad n = 1, 2, 3, \dots$$

The eigenvalues  $(2n-1)^2\pi^2/4L^2$  correspond to the eigenfunctions  $\cos \frac{(2n-1)\pi}{2L}x$  for  $n = 1, 2, 3, \dots$

12. For  $\lambda \leq 0$  the only solution of the boundary-value problem is  $y = 0$ . For  $\lambda > 0$  we have

$$y = c_1 \cos \sqrt{\lambda}x + c_2 \sin \sqrt{\lambda}x.$$

Now  $y(0) = 0$  implies  $c_1 = 0$ , so

$$y' \left( \frac{\pi}{2} \right) = c_2 \sqrt{\lambda} \cos \sqrt{\lambda} \frac{\pi}{2} = 0$$

gives

$$\sqrt{\lambda} \frac{\pi}{2} = \frac{(2n-1)\pi}{2} \quad \text{or} \quad \lambda = (2n-1)^2, \quad n = 1, 2, 3, \dots$$

The eigenvalues  $(2n-1)^2$  correspond to the eigenfunctions  $\sin(2n-1)x$ .

13. For  $\lambda < 0$  the only solution of the boundary-value problem is  $y = 0$ . For  $\lambda = 0$  we have  $y = c_1x + c_2$ . Now  $y' = c_1$  and  $y'(0) = 0$  implies  $c_1 = 0$ . Then  $y = c_2$  and  $y'(\pi) = 0$ . Thus,  $\lambda = 0$  is an eigenvalue with corresponding eigenfunction  $y = 1$ .

For  $\lambda > 0$  we have

$$y = c_1 \cos \sqrt{\lambda}x + c_2 \sin \sqrt{\lambda}x.$$

Now

$$y'(x) = -c_1 \sqrt{\lambda} \sin \sqrt{\lambda}x + c_2 \sqrt{\lambda} \cos \sqrt{\lambda}x$$

and  $y'(0) = 0$  implies  $c_2 = 0$ , so

$$y'(\pi) = -c_1 \sqrt{\lambda} \sin \sqrt{\lambda}\pi = 0$$

gives

$$\sqrt{\lambda}\pi = n\pi \quad \text{or} \quad \lambda = n^2, \quad n = 1, 2, 3, \dots$$

The eigenvalues  $n^2$  correspond to the eigenfunctions  $\cos nx$  for  $n = 0, 1, 2, \dots$

14. For  $\lambda \leq 0$  the only solution of the boundary-value problem is  $y = 0$ . For  $\lambda > 0$  we have

$$y = c_1 \cos \sqrt{\lambda}x + c_2 \sin \sqrt{\lambda}x.$$

Now  $y(-\pi) = y(\pi) = 0$  implies

$$c_1 \cos \sqrt{\lambda}\pi - c_2 \sin \sqrt{\lambda}\pi = 0$$

$$c_1 \cos \sqrt{\lambda}\pi + c_2 \sin \sqrt{\lambda}\pi = 0.$$

(1)

This homogeneous system will have a nontrivial solution when

$$\begin{vmatrix} \cos \sqrt{\lambda} \pi & -\sin \sqrt{\lambda} \pi \\ \cos \sqrt{\lambda} \pi & \sin \sqrt{\lambda} \pi \end{vmatrix} = 2 \sin \sqrt{\lambda} \pi \cos \sqrt{\lambda} \pi = \sin 2\sqrt{\lambda} \pi = 0.$$

Then

$$2\sqrt{\lambda} \pi = n\pi \quad \text{or} \quad \lambda = \frac{n^2}{4}; \quad n = 1, 2, 3, \dots$$

When  $n = 2k - 1$  is odd, the eigenvalues are  $(2k - 1)^2/4$ . Since  $\cos(2k - 1)\pi/2 = 0$  and  $\sin(2k - 1)\pi/2 \neq 0$ , we see from either equation in (1) that  $c_2 = 0$ . Thus, the eigenfunctions corresponding to the eigenvalues  $(2k - 1)^2/4$  are  $y = \cos(2k - 1)x/2$  for  $k = 1, 2, 3, \dots$ . Similarly, when  $n = 2k$  is even, the eigenvalues are  $k^2$  with corresponding eigenfunctions  $y = \sin kx$  for  $k = 1, 2, 3, \dots$ .

15. The auxiliary equation has solutions

$$m = \frac{1}{2} \left( -2 \pm \sqrt{4 - 4(\lambda + 1)} \right) = -1 \pm \sqrt{-\lambda}.$$

For  $\lambda < 0$  we have

$$y = e^{-x} (c_1 \cosh \sqrt{-\lambda} x + c_2 \sinh \sqrt{-\lambda} x).$$

The boundary conditions imply

$$y(0) = c_1 = 0$$

$$y(5) = c_2 e^{-5} \sinh 5\sqrt{-\lambda} = 0$$

so  $c_1 = c_2 = 0$  and the only solution of the boundary-value problem is  $y = 0$ .

For  $\lambda = 0$  we have

$$y = c_1 e^{-x} + c_2 x e^{-x}$$

and the only solution of the boundary-value problem is  $y = 0$ .

For  $\lambda > 0$  we have

$$y = e^{-x} (c_1 \cos \sqrt{\lambda} x + c_2 \sin \sqrt{\lambda} x).$$

Now  $y(0) = 0$  implies  $c_1 = 0$ , so

$$y(5) = c_2 e^{-5} \sin 5\sqrt{\lambda} = 0$$

gives

$$5\sqrt{\lambda} = n\pi \quad \text{or} \quad \lambda = \frac{n^2 \pi^2}{25}, \quad n = 1, 2, 3, \dots$$

The eigenvalues  $n^2 \pi^2/25$  correspond to the eigenfunctions  $e^{-x} \sin \frac{n\pi}{5} x$  for  $n = 1, 2, 3, \dots$ .

16. For  $\lambda < -1$  the only solution of the boundary-value problem is  $y = 0$ . For  $\lambda = -1$  we have  $y = c_1 x + c_2$ . Now  $y' = c_1$  and  $y'(0) = 0$  implies  $c_1 = 0$ . Then  $y = c_2$  and  $y'(1) = 0$ . Thus,  $\lambda = -1$  is an eigenvalue with corresponding eigenfunction  $y = 1$ .

## Exercises 5.2

For  $\lambda > -1$  we have

$$y = c_1 \cos \sqrt{\lambda + 1} x + c_2 \sin \sqrt{\lambda + 1} x.$$

Now

$$y' = -c_1 \sqrt{\lambda + 1} \sin \sqrt{\lambda + 1} x + c_2 \sqrt{\lambda + 1} \cos \sqrt{\lambda + 1} x$$

and  $y'(0) = 0$  implies  $c_2 = 0$ , so

$$y'(1) = -c_1 \sqrt{\lambda + 1} \sin \sqrt{\lambda + 1} = 0$$

gives

$$\sqrt{\lambda + 1} = n\pi \quad \text{or} \quad \lambda = n^2\pi^2 - 1, \quad n = 1, 2, 3, \dots$$

The eigenvalues  $n^2\pi^2 - 1$  correspond to the eigenfunctions  $\cos n\pi x$  for  $n = 0, 1, 2, \dots$ .

17. For  $\lambda = 0$  the only solution of the boundary-value problem is  $y = 0$ . For  $\lambda \neq 0$  we have

$$y = c_1 \cos \lambda x + c_2 \sin \lambda x.$$

Now  $y(0) = 0$  implies  $c_1 = 0$ , so

$$y(L) = c_2 \sin \lambda L = 0$$

gives

$$\lambda L = n\pi \quad \text{or} \quad \lambda = \frac{n\pi}{L}, \quad n = 1, 2, 3, \dots$$

The eigenvalues  $n\pi/L$  correspond to the eigenfunctions  $\sin \frac{n\pi}{L} x$  for  $n = 1, 2, 3, \dots$ .

18. For  $\lambda = 0$  the only solution of the boundary-value problem is  $y = 0$ . For  $\lambda \neq 0$  we have

$$y = c_1 \cos \lambda x + c_2 \sin \lambda x.$$

Now  $y(0) = 0$  implies  $c_1 = 0$ , so

$$y'(3\pi) = c_2 \lambda \cos 3\pi \lambda = 0$$

gives

$$3\pi\lambda = \frac{(2n-1)\pi}{2} \quad \text{or} \quad \lambda = \frac{2n-1}{6}, \quad n = 1, 2, 3, \dots$$

The eigenvalues  $(2n-1)/6$  correspond to the eigenfunctions  $\sin \frac{2n-1}{6} x$  for  $n = 1, 2, 3, \dots$ .

19. For  $\lambda > 0$  a general solution of the given differential equation is

$$y = c_1 \cos(\sqrt{\lambda} \ln x) + c_2 \sin(\sqrt{\lambda} \ln x).$$

Since  $\ln 1 = 0$ , the boundary condition  $y(1) = 0$  implies  $c_1 = 0$ . Therefore

$$y = c_2 \sin(\sqrt{\lambda} \ln x).$$

Using  $\ln e^\pi = \pi$  we find that  $y(e^\pi) = 0$  implies

$$c_2 \sin \sqrt{\lambda} \pi = 0$$

## Exercises 5.2

or  $\sqrt{\lambda}\pi = n\pi$ ,  $n = 1, 2, 3, \dots$ . The eigenvalues and eigenfunctions are, in turn,

$$\lambda = n^2, \quad n = 1, 2, 3, \dots \quad \text{and} \quad y = \sin(n \ln x).$$

For  $\lambda \leq 0$  the only solution of the boundary-value problem is  $y = 0$ .

To obtain the self-adjoint form we note that the integrating factor is  $(1/x^2)e^{\int dx/x} = 1/x$ . That is, the self-adjoint form is

$$\frac{d}{dx}[xy'] + \frac{\lambda}{x}y = 0.$$

Identifying the weight function  $p(x) = 1/x$  we can then write the orthogonality relation

$$\int_1^{e^\pi} \frac{1}{x} \sin(n \ln x) \sin(m \ln x) dx = 0, \quad m \neq n.$$

20. For  $\lambda = 0$  the general solution is  $y = c_1 + c_2 \ln x$ . Now  $y' = c_2/x$ , so  $y'(e^{-1}) = c_2e = 0$  implies  $c_2 = 0$ . Then  $y = c_1$  and  $y(1) = 0$  gives  $c_1 = 0$ . Thus  $y(x) = 0$ .

For  $\lambda < 0$ ,  $y = c_1x^{-\sqrt{-\lambda}} + c_2x^{\sqrt{-\lambda}}$ . The initial conditions give  $c_2 = c_1e^{2\sqrt{-\lambda}}$  and  $c_1 = 0$ , so that  $c_2 = 0$  and  $y(x) = 0$ .

For  $\lambda > 0$ ,  $y = c_1 \cos(\sqrt{\lambda} \ln x) + c_2 \sin(\sqrt{\lambda} \ln x)$ . From  $y(1) = 0$  we obtain  $c_1 = 0$  and  $y = c_2 \sin(\sqrt{\lambda} \ln x)$ . Now  $y' = c_2(\sqrt{\lambda}/x) \cos(\sqrt{\lambda} \ln x)$ , so  $y'(e^{-1}) = c_2e\sqrt{\lambda} \cos\sqrt{\lambda} = 0$  implies  $\cos\sqrt{\lambda} = 0$  or  $\lambda = (2n-1)^2\pi^2/4$  for  $n = 1, 2, 3, \dots$ . The corresponding eigenfunctions are

$$y = \sin\left(\frac{2n-1}{2}\pi \ln x\right).$$

21. For  $\lambda = 0$  the general solution is  $y = c_1 + c_2 \ln x$ . Now  $y' = c_2/x$ , so  $y'(1) = c_2 = 0$  and  $y = c_1$ . Since  $y'(e^2) = 0$  for any  $c_1$  we see that  $y(x) = 1$  is an eigenfunction corresponding to the eigenvalue  $\lambda = 0$ .

For  $\lambda < 0$ ,  $y = c_1x^{-\sqrt{-\lambda}} + c_2x^{\sqrt{-\lambda}}$ . The initial conditions imply  $c_1 = c_2 = 0$ , so  $y(x) = 0$ .

For  $\lambda > 0$ ,  $y = c_1 \cos(\sqrt{\lambda} \ln x) + c_2 \sin(\sqrt{\lambda} \ln x)$ . Now

$$y' = -c_1 \frac{\sqrt{\lambda}}{x} \sin(\sqrt{\lambda} \ln x) + c_2 \frac{\sqrt{\lambda}}{x} \cos(\sqrt{\lambda} \ln x),$$

and  $y'(1) = c_2\sqrt{\lambda} = 0$  implies  $c_2 = 0$ . Finally,  $y'(e^2) = -(c_1\sqrt{\lambda}/e^2) \sin(2\sqrt{\lambda}) = 0$  implies  $\lambda = n^2\pi^2/4$  for  $n = 1, 2, 3, \dots$ . The corresponding eigenfunctions are

$$y = \cos\left(\frac{n\pi}{2} \ln x\right).$$

22. For  $\lambda > 1/4$  a general solution of the given differential equation is

$$y = c_1x^{-1/2} \cos\left(\frac{\sqrt{4\lambda-1}}{2} \ln x\right) + c_2x^{-1/2} \sin\left(\frac{\sqrt{4\lambda-1}}{2} \ln x\right).$$

### Exercises 5.2

Since  $\ln 1 = 0$ , the boundary condition  $y(1) = 0$  implies  $c_1 = 0$ . Therefore

$$y = c_2 x^{-1/2} \sin\left(\frac{\sqrt{4\lambda - 1}}{2} \ln x\right).$$

Using  $\ln e^2 = 2$  we find that  $y(e^2) = 0$  implies

$$c_2 e^{-1} \sin(\sqrt{4\lambda - 1}) = 0$$

or  $\sqrt{4\lambda - 1} = n\pi$ ,  $n = 1, 2, 3, \dots$ . The eigenvalues and eigenfunctions are, in turn,

$$\lambda = (n^2\pi^2 + 1)/4, \quad n = 1, 2, 3, \dots \quad \text{and} \quad y = x^{-1/2} \sin\left(\frac{n\pi}{2} \ln x\right).$$

For  $\lambda < 0$  the only solution of the boundary-value problem is  $y = 0$ .

For  $\lambda = 1/4$  a general solution of the differential equation is

$$y = c_1 x^{-1/2} + c_2 x^{-1/2} \ln x.$$

From  $y(1) = 0$  we obtain  $c_1 = 0$ , so  $y = c_2 x^{-1/2} \ln x$ . From  $y(e^2) = 0$  we obtain  $2c_2 e^{-1} = 0$  or  $c_2 = 0$ . Thus, there are no eigenvalues and eigenfunctions in this case.

To obtain the self-adjoint form we note that the integrating factor is

$$(1/x^2)e^{\int(2/x)dx} = (1/x^2) \cdot x^2 = 1.$$

That is, the self-adjoint form is

$$\frac{d}{dx} [x^2 y'] + \lambda y = 0.$$

Identifying the weight function  $p(x) = 1$  we can then write the orthogonality relation

$$\int_1^{e^2} 1 \cdot x^{-1/2} \sin\left(\frac{m\pi}{2} \ln x\right) x^{-1/2} \sin\left(\frac{n\pi}{2} \ln x\right) dx = 0, \quad m \neq n,$$

or

$$\int_1^{e^2} x^{-1} \sin\left(\frac{m\pi}{2} \ln x\right) \sin\left(\frac{n\pi}{2} \ln x\right) dx = 0, \quad m \neq n.$$

23. If restraints are put on the column at  $x = L/4$ ,  $x = L/2$ , and  $x = 3L/4$ , then the critical load will be  $P_4$ .



24. (a) The general solution of the differential equation is

$$y = c_1 \cos \sqrt{\frac{P}{EI}} x + c_2 \sin \sqrt{\frac{P}{EI}} x + \delta.$$

## Exercises 5.2

Since the column is embedded at  $x = 0$ , the initial conditions are  $y(0) = y'(0) = 0$ . If  $\delta = 0$  this implies that  $c_1 = c_2 = 0$  and  $y(x) = 0$ . That is, there is no deflection.

(b) If  $\delta \neq 0$ , the initial conditions give, in turn,  $c_1 = -\delta$  and  $c_2 = 0$ . Then

$$y = \delta \left( 1 - \cos \sqrt{\frac{P}{EI}} x \right).$$

In order to satisfy the condition  $y(L) = \delta$  we must have

$$\delta = \delta \left( 1 - \cos \sqrt{\frac{P}{EI}} L \right) \quad \text{or} \quad \cos \sqrt{\frac{P}{EI}} L = 0.$$

This gives  $\sqrt{P/EI} L = n\pi/2$  for  $n = 1, 2, 3, \dots$ . The smallest value of  $P_n$ , the Euler load, is then

$$\sqrt{\frac{P_1}{EI}} L = \frac{\pi}{2} \quad \text{or} \quad P_1 = \frac{1}{4} \left( \frac{\pi^2 EI}{L^2} \right).$$

25. The general solution is

$$y = c_1 \cos \sqrt{\frac{\rho\omega^2}{T}} x + c_2 \sin \sqrt{\frac{\rho\omega^2}{T}} x.$$

From  $y(0) = 0$  we obtain  $c_1 = 0$ . Setting  $y(L) = 0$  we find  $\sqrt{\rho\omega^2/T} L = n\pi$ ,  $n = 1, 2, 3, \dots$ . Thus, critical speeds are  $\omega_n = n\pi\sqrt{T}/L\sqrt{\rho}$ ,  $n = 1, 2, 3, \dots$ . The corresponding deflection curves are

$$y(x) = c_2 \sin \frac{n\pi}{L} x, \quad n = 1, 2, 3, \dots,$$

where  $c_2 \neq 0$ .

26. (a) When  $T(x) = x^2$  the given differential equation is the Cauchy-Euler equation

$$x^2 y'' + 2xy' + \rho\omega^2 y = 0.$$

The solutions of the auxiliary equation

$$m(m-1) + 2m + \rho\omega^2 = m^2 + m + \rho\omega^2 = 0$$

are

$$m_1 = -\frac{1}{2} - \frac{1}{2}\sqrt{4\rho\omega^2 - 1}i, \quad m_2 = -\frac{1}{2} + \frac{1}{2}\sqrt{4\rho\omega^2 - 1}i$$

when  $\rho\omega^2 > 0.25$ . Thus

$$y = c_1 x^{-1/2} \cos(\lambda \ln x) + c_2 x^{-1/2} \sin(\lambda \ln x)$$

where  $\lambda = \sqrt{4\rho\omega^2 - 1}/2$ . Applying  $y(1) = 0$  gives  $c_1 = 0$  and consequently

$$y = c_2 x^{-1/2} \sin(\lambda \ln x).$$

### Exercises 5.2

The condition  $y(e) = 0$  requires  $c_2 e^{-1/2} \sin \lambda = 0$ . We obtain a nontrivial solution when  $\lambda_n = n\pi$ ,  $n = 1, 2, 3, \dots$ . But

$$\lambda_n = \sqrt{4\rho\omega_n^2 - 1}/2 = n\pi.$$

Solving for  $\omega_n$  gives

$$\omega_n = \frac{1}{2} \sqrt{(4n^2\pi^2 + 1)/\rho}.$$

The corresponding solutions are

$$y_n(x) = c_2 x^{-1/2} \sin(n\pi \ln x).$$

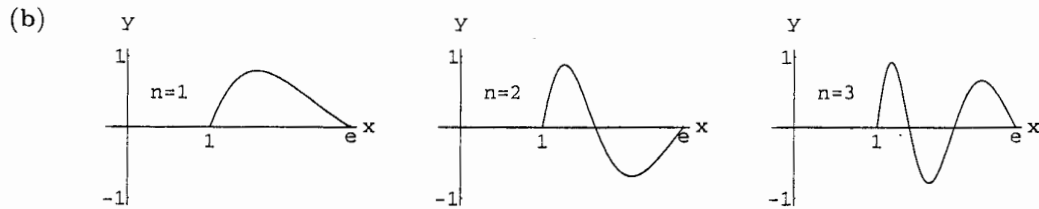

27. The auxiliary equation is  $m^2 + m = m(m + 1) = 0$  so that  $u(r) = c_1 r^{-1} + c_2$ . The boundary conditions  $u(a) = u_0$  and  $u(b) = u_1$  yield the system  $c_1 a^{-1} + c_2 = u_0$ ,  $c_1 b^{-1} + c_2 = u_1$ . Solving gives

$$c_1 = \left( \frac{u_0 - u_1}{b - a} \right) ab \quad \text{and} \quad c_2 = \frac{u_1 b - u_0 a}{b - a}.$$

Thus

$$u(r) = \left( \frac{u_0 - u_1}{b - a} \right) \frac{ab}{r} + \frac{u_1 b - u_0 a}{b - a}.$$

28. The auxiliary equation is  $m^2 = 0$  so that  $u(r) = c_1 + c_2 \ln r$ . The boundary conditions  $u(a) = u_0$  and  $u(b) = u_1$  yield the system  $c_1 + c_2 \ln a = u_0$ ,  $c_1 + c_2 \ln b = u_1$ . Solving gives

$$c_1 = \frac{u_1 \ln a - u_0 \ln b}{\ln(a/b)} \quad \text{and} \quad c_2 = \frac{u_0 - u_1}{\ln(a/b)}.$$

Thus

$$u(r) = \frac{u_1 \ln a - u_0 \ln b}{\ln(a/b)} + \frac{u_0 - u_1}{\ln(a/b)} \ln r = \frac{u_0 \ln(r/b) - u_1 \ln(r/a)}{\ln(a/b)}.$$

29. (a) The general solution of the differential equation is  $y = c_1 \cos 4x + c_2 \sin 4x$ . From  $y_0 = y(0) = c_1$  we see that  $y = y_0 \cos 4x + c_2 \sin 4x$ . From  $y_1 = y(\pi/2) = y_0$  we see that any solution must satisfy  $y_0 = y_1$ . We also see that when  $y_0 = y_1$ ,  $y = y_0 \cos 4x + c_2 \sin 4x$  is a solution of the boundary-value problem for any choice of  $c_2$ . Thus, the boundary-value problem does not have a unique solution for any choice of  $y_0$  and  $y_1$ .

(b) Whenever  $y_0 = y_1$  there are infinitely many solutions.

(c) When  $y_0 \neq y_1$  there will be no solutions.



- (d) The boundary-value problem will have the trivial solution when  $y_0 = y_1 = 0$ . This solution will not be unique.
30. (a) The general solution of the differential equation is  $y = c_1 \cos 4x + c_2 \sin 4x$ . From  $1 = y(0) = c_1$  we see that  $y = \cos 4x + c_2 \sin 4x$ . From  $1 = y(L) = \cos 4L + c_2 \sin 4L$  we see that  $c_2 = (1 - \cos 4L)/\sin 4L$ . Thus,

$$y = \cos 4x + \left( \frac{1 - \cos 4L}{\sin 4L} \right) \sin 4x$$

will be a unique solution when  $\sin 4L \neq 0$ ; that is, when  $L \neq k\pi/4$  where  $k = 1, 2, 3, \dots$ .

- (b) There will be infinitely many solutions when  $\sin 4L = 0$  and  $1 - \cos 4L = 0$ ; that is, when  $L = k\pi/2$  where  $k = 1, 2, 3, \dots$ .
- (c) There will be no solution when  $\sin 4L \neq 0$  and  $1 - \cos 4L \neq 0$ ; that is, when  $L = k\pi/4$  where  $k = 1, 3, 5, \dots$ .
- (d) There can be no trivial solution since it would fail to satisfy the boundary conditions.
31. (a) A solution curve has the same  $y$ -coordinate at both ends of the interval  $[-\pi, \pi]$  and the tangent lines at the endpoints of the interval are parallel.
- (b) For  $\lambda = 0$  the solution of  $y'' = 0$  is  $y = c_1x + c_2$ . From the first boundary condition we have

$$y(-\pi) = -c_1\pi + c_2 = y(\pi) = c_1\pi + c_2$$

or  $2c_1\pi = 0$ . Thus,  $c_1 = 0$  and  $y = c_2$ . This constant solution is seen to satisfy the boundary-value problem.

For  $\lambda < 0$  we have  $y = c_1 \cosh \lambda x + c_2 \sinh \lambda x$ . In this case the first boundary condition gives

$$\begin{aligned} y(-\pi) &= c_1 \cosh(-\lambda\pi) + c_2 \sinh(-\lambda\pi) \\ &= c_1 \cosh \lambda\pi - c_2 \sinh \lambda\pi \\ &= y(\pi) = c_1 \cosh \lambda\pi + c_2 \sinh \lambda\pi \end{aligned}$$

or  $2c_2 \sinh \lambda\pi = 0$ . Thus  $c_2 = 0$  and  $y = c_1 \cosh \lambda x$ . The second boundary condition implies in a similar fashion that  $c_1 = 0$ . Thus, for  $\lambda < 0$ , the only solution of the boundary-value problem is  $y = 0$ .

For  $\lambda > 0$  we have  $y = c_1 \cos \lambda x + c_2 \sin \lambda x$ . The first boundary condition implies

$$\begin{aligned} y(-\pi) &= c_1 \cos(-\lambda\pi) + c_2 \sin(-\lambda\pi) \\ &= c_1 \cos \lambda\pi - c_2 \sin \lambda\pi \\ &= y(\pi) = c_1 \cos \lambda\pi + c_2 \sin \lambda\pi \end{aligned}$$

### Exercises 5.2

or  $2c_2 \sin \lambda\pi = 0$ . Similarly, the second boundary condition implies  $2c_1 \lambda \sin \lambda\pi = 0$ . If  $c_1 = c_2 = 0$  the solution is  $y = 0$ . However, if  $c_1 \neq 0$  or  $c_2 \neq 0$ , then  $\sin \lambda\pi = 0$ , which implies that  $\lambda$  must be an integer,  $n$ . Therefore, for  $c_1$  and  $c_2$  not both 0,  $y = c_1 \cos nx + c_2 \sin nx$  is a nontrivial solution of the boundary-value problem. Since  $\cos(-nx) = \cos nx$  and  $\sin(-nx) = -\sin nx$ , we may assume without loss of generality that the eigenvalues are  $\lambda_n = n$ , for  $n$  a positive integer. The corresponding eigenfunctions are  $y_n = \cos nx$  and  $y_n = \sin nx$ .

(c)

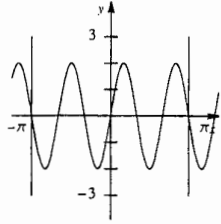

$$y = 2 \sin 3x$$

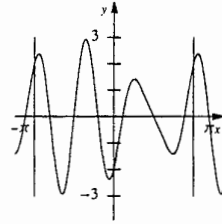

$$y = \sin 4x - 2 \cos 3x$$

32. (a) For  $\lambda > 0$  the general solution is  $y = c_1 \cos \sqrt{\lambda}x + c_2 \sin \sqrt{\lambda}x$ . Setting  $y(0) = 0$  we find  $c_1 = 0$ , so that  $y = c_2 \sin \sqrt{\lambda}x$ . The boundary condition  $y(1) + y'(1) = 0$  implies

$$c_2 \sin \sqrt{\lambda} + c_2 \sqrt{\lambda} \cos \sqrt{\lambda} = 0.$$

Taking  $c_2 \neq 0$ , this equation is equivalent to  $\tan \sqrt{\lambda} = -\sqrt{\lambda}$ . Thus, the eigenvalues are  $\lambda_n = x_n^2$ ,  $n = 1, 2, 3, \dots$ , where the  $x_n$  are the consecutive positive roots of  $\tan \sqrt{\lambda} = -\sqrt{\lambda}$ .

- (b) We see from the graph that  $\tan x = -x$  has infinitely many roots. Since  $\lambda_n = x_n^2$ , there are no new eigenvalues when  $x_n < 0$ . For  $\lambda = 0$ , the differential equation  $y'' = 0$  has general solution  $y = c_1x + c_2$ . The boundary conditions imply  $c_1 = c_2 = 0$ , so  $y = 0$ .

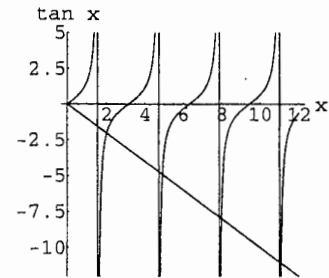

- (c) Using a CAS we find that the first four nonnegative roots of  $\tan x = -x$  are approximately 2.02876, 4.91318, 7.97867, and 11.0855. The corresponding eigenvalues are 4.11586, 24.1393, 63.6591, and 122.889, with eigenfunctions  $\sin(2.02876x)$ ,  $\sin(4.91318x)$ ,  $\sin(7.97867x)$ , and  $\sin(11.0855x)$ .

## Exercises 5.3

1. The period corresponding to  $x(0) = 1, x'(0) = 1$  is approximately 5.6. The period corresponding to  $x(0) = 1/2, x'(0) = -1$  is approximately 6.2.

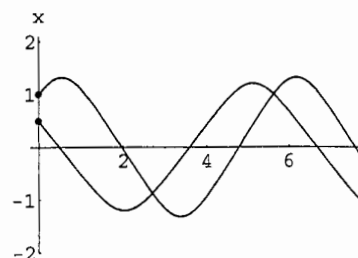

2. The solutions are not periodic.

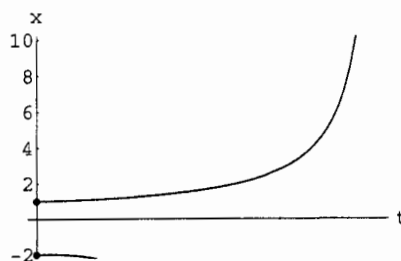

3. The period corresponding to  $x(0) = 1, x'(0) = 1$  is approximately 5.8. The second initial-value problem does not have a periodic solution.

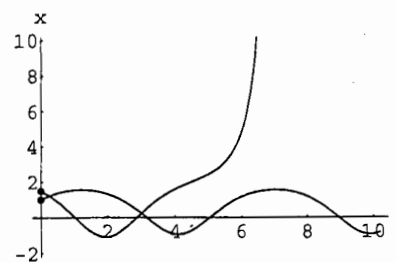

4. Both solutions have periods of approximately 6.3.

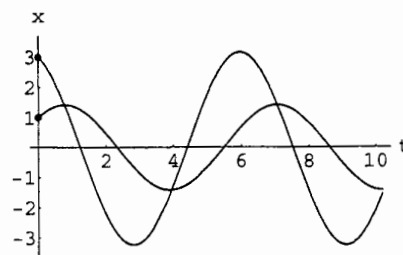

### Exercises 5.3

5. From the graph we see that  $|x_1| \approx 1.2$ .

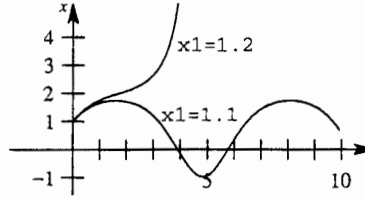

6. From the graphs we see that the interval is approximately  $(-0.8, 1.1)$ .

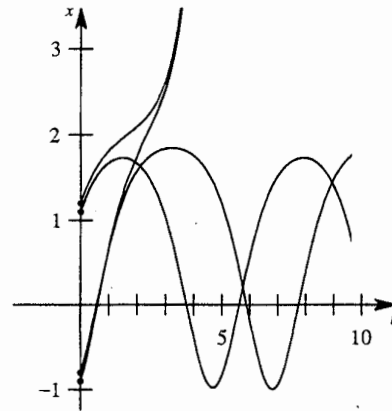

7. Since

$$xe^{0.01x} = x\left[1 + 0.01x + \frac{1}{2!}(0.01x)^2 + \dots\right] \approx x$$

for small values of  $x$ , a linearization is  $\frac{d^2x}{dt^2} + x = 0$ .

- 8.

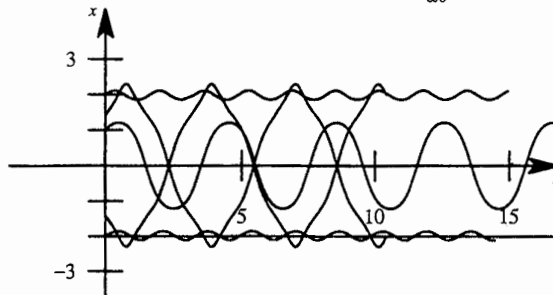

For  $x(0) = 1$  and  $x'(0) = 1$  the oscillations are symmetric about the line  $x = 0$  with amplitude slightly greater than 1.

For  $x(0) = -2$  and  $x'(0) = 0.5$  the oscillations are symmetric about the line  $x = -2$  with small amplitude.

For  $x(0) = \sqrt{2}$  and  $x'(0) = 1$  the oscillations are symmetric about the line  $x = 0$  with amplitude a

Exercises 5.3

little greater than 2.

For  $x(0) = 2$  and  $x'(0) = 0.5$  the oscillations are symmetric about the line  $x = 2$  with small amplitude.

For  $x(0) = -2$  and  $x'(0) = 0$  there is no oscillation; the solution is constant.

For  $x(0) = -\sqrt{2}$  and  $x'(0) = -1$  the oscillations are symmetric about the line  $x = 0$  with amplitude a little greater than 2.

9. This is a damped hard spring, so all solutions should be oscillatory with  $x \rightarrow 0$  as  $t \rightarrow \infty$ .

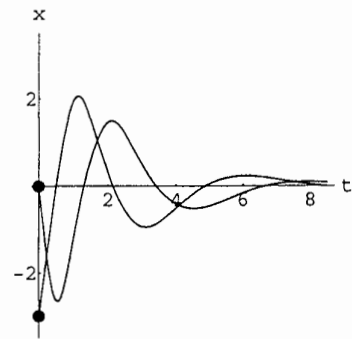

10. This is a damped soft spring, so so we expect no oscillatory solutions.

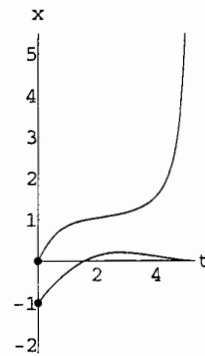

Exercises 5.3

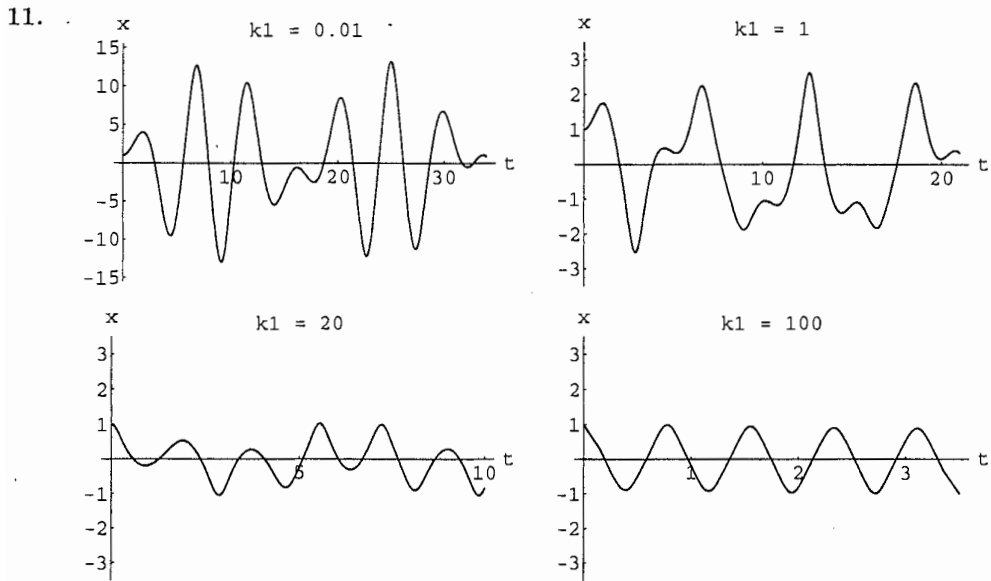

When  $k_1$  is very small the effect of the nonlinearity is greatly diminished, and the system is close to pure resonance.

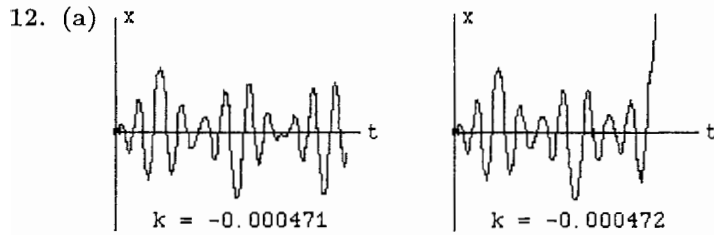

The system appears to be oscillatory for  $-0.000471 \leq k_1 < 0$  and nonoscillatory for  $k_1 \leq -0.000472$ .

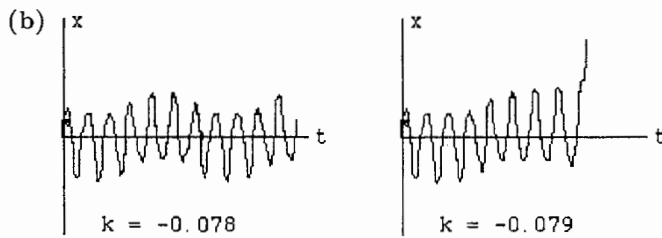

The system appears to be oscillatory for  $-0.077 \leq k_1 < 0$  and nonoscillatory for  $k_1 \leq 0.078$ .

13. For  $\lambda^2 - \omega^2 > 0$  we choose  $\lambda = 2$  and  $\omega = 1$  with  $x(0) = 1$  and  $x'(0) = 2$ . For  $\lambda^2 - \omega^2 < 0$  we choose  $\lambda = 1/3$  and  $\omega = 1$  with  $x(0) = -2$  and  $x'(0) = 4$ . In both cases the motion corresponds to the overdamped and underdamped cases for spring/mass systems.

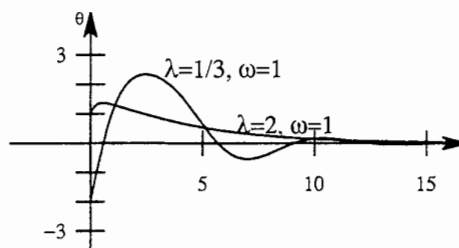

14. (a) Setting  $dy/dt = v$ , the differential equation in (13) becomes  $dv/dt = -gR^2/y^2$ . But, by the chain rule,  $dv/dt = (dv/dy)(dy/dt) = v dv/dy$ , so  $v dv/dy = -gR^2/y^2$ . Separating variables and integrating we obtain

$$v dv = -gR^2 \frac{dy}{y^2} \quad \text{and} \quad \frac{1}{2}v^2 = \frac{gR^2}{y} + c.$$

Setting  $v = v_0$  and  $y = R$  we find  $c = -gR + \frac{1}{2}v_0^2$  and

$$v^2 = 2g \frac{R^2}{y} - 2gR + v_0^2.$$

- (b) As  $y \rightarrow \infty$  we assume that  $v \rightarrow 0^+$ . Then  $v_0^2 = 2gR$  and  $v_0 = \sqrt{2gR}$ .

- (c) Using  $g = 32$  ft/s and  $R = 4000(5280)$  ft we find

$$v_0 = \sqrt{2(32)(4000)(5280)} \approx 36765.2 \text{ ft/s} \approx 25067 \text{ mi/hr.}$$

- (d)  $v_0 = \sqrt{2(0.165)(32)(1080)} \approx 7760 \text{ ft/s} \approx 5291 \text{ mi/hr}$

15. (a) Intuitively, one might expect that only half of a 10-pound chain could be lifted by a 5-pound force.

- (b) Since  $x = 0$  when  $t = 0$ , and  $v = dx/dt = \sqrt{160 - 64x/3}$ , we have  $v(0) = \sqrt{160} \approx 12.65$  ft/s.

- (c) Since  $x$  should always be positive, we solve  $x(t) = 0$ , getting  $t = 0$  and  $t = \frac{3}{2}\sqrt{5/2} \approx 2.3717$ . Since the graph of  $x(t)$  is a parabola, the maximum value occurs at  $t_m = \frac{3}{4}\sqrt{5/2}$ . (This can also be obtained by solving  $x'(t) = 0$ .) At this time the height of the chain is  $x(t_m) \approx 7.5$  ft. This is higher than predicted because

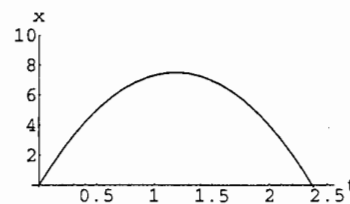

of the momentum generated by the force. When the chain is 5 feet high it still has a positive velocity of about 7.3 ft/s, which keeps it going higher for a while.

16. (a) Setting  $dx/dt = v$ , the differential equation becomes  $(L-x)dv/dt - v^2 = Lg$ . But, by the chain rule,  $dv/dt = (dv/dx)(dx/dt) = v dv/dx$ , so  $(L-x)v dv/dx - v^2 = Lg$ . Separating variables

### Exercises 5.3

and integrating we obtain

$$\frac{v}{v^2 + Lg} dv = \frac{1}{L-x} dx \quad \text{and} \quad \frac{1}{2} \ln(v^2 + Lg) = -\ln(L-x) + \ln c,$$

so  $\sqrt{v^2 + Lg} = c/(L-x)$ . When  $x = 0$ ,  $v = 0$ , and  $c = L\sqrt{Lg}$ . Solving for  $v$  and simplifying we get

$$\frac{dx}{dt} = v(x) = \frac{\sqrt{Lg(2Lx - x^2)}}{L-x}.$$

Again, separating variables and integrating we obtain

$$\frac{L-x}{\sqrt{Lg(2Lx - x^2)}} dx = dt \quad \text{and} \quad \frac{\sqrt{2Lx - x^2}}{\sqrt{Lg}} = t + c_1.$$

Since  $x(0) = 0$ , we have  $c_1 = 0$  and  $\sqrt{2Lx - x^2}/\sqrt{Lg} = t$ . Solving for  $x$  we get

$$x(t) = L - \sqrt{L^2 - Lgt^2} \quad \text{and} \quad v(t) = \frac{dx}{dt} = \frac{\sqrt{Lgt}}{\sqrt{L - gt^2}}.$$

- (b) The chain will be completely on the ground when  $x(t) = L$  or  $t = \sqrt{L/g}$ .
- (c) The predicted velocity of the upper end of the chain when it hits the ground is infinity.
17. (a) The weight of  $x$  feet of the chain is  $2x$ , so the corresponding mass is  $m = 2x/32 = x/16$ . The only force acting on the chain is the weight of the portion of the chain hanging over the edge of the platform. Thus, by Newton's second law,

$$\frac{d}{dt}(mv) = \frac{d}{dt}\left(\frac{x}{16}v\right) = \frac{1}{16}\left(x\frac{dv}{dt} + v\frac{dx}{dt}\right) = \frac{1}{16}\left(x\frac{dv}{dt} + v^2\right) = 2x$$

and  $x dv/dt + v^2 = 32x$ . Now, by the chain rule,  $dv/dt = (dv/dx)(dx/dt) = v dv/dx$ , so  $xv dv/dx + v^2 = 32x$ .

- (b) We separate variables and write the differential equation as  $(v^2 - 32x) dx + xv dv = 0$ . This is not an exact form, but  $\mu(x) = x$  is an integrating factor. Multiplying by  $x$  we get  $(xv^2 - 32x^2) dx + x^2v dv = 0$ . This form is the total differential of  $u = \frac{1}{2}x^2v^2 - \frac{32}{3}x^3$ , so an implicit solution is  $\frac{1}{2}x^2v^2 - \frac{32}{3}x^3 = c$ . Letting  $x = 3$  and  $v = 0$  we find  $c = -288$ . Solving for  $v$  we get

$$\frac{dx}{dt} = v = \frac{8\sqrt{x^3 - 27}}{\sqrt{3}x}, \quad 3 \leq x \leq 8.$$

- (c) Separating variables and integrating we obtain

$$\frac{x}{\sqrt{x^3 - 27}} dx = \frac{8}{\sqrt{3}} dt \quad \text{and} \quad \int_3^x \frac{s}{\sqrt{s^3 - 27}} ds = \frac{8}{\sqrt{3}} t + c.$$



Exercises 5.3

Since  $x = 3$  when  $t = 0$ , we see that  $c = 0$  and

$$t = \frac{\sqrt{3}}{8} \int_3^x \frac{s}{\sqrt{s^3 - 27}} ds.$$

We want to find  $t$  when  $x = 7$ . Using a CAS we find  $t(7) = 0.576$  seconds.

18. (a) There are two forces acting on the chain as it falls from the platform. One is the force due to gravity on the portion of the chain hanging over the edge of the platform. This is  $F_1 = 2x$ . The second is due to the motion of the portion of the chain stretched out on the platform. By Newton's second law this is

$$\begin{aligned} F_2 &= \frac{d}{dt}[mv] = \frac{d}{dt} \left[ \frac{(8-x)2}{32} v \right] = \frac{d}{dt} \left[ \frac{8-x}{16} v \right] \\ &= \frac{8-x}{16} \frac{dv}{dt} - \frac{1}{16} v \frac{dx}{dt} = \frac{1}{16} \left[ (8-x) \frac{dv}{dt} - v^2 \right]. \end{aligned}$$

From  $\frac{d}{dt}[mv] = F_1 - F_2$  we have

$$\begin{aligned} \frac{d}{dt} \left[ \frac{2x}{32} v \right] &= 2x - \frac{1}{16} \left[ (8-x) \frac{dv}{dt} - v^2 \right] \\ \frac{x}{16} \frac{dv}{dt} + \frac{1}{16} v \frac{dx}{dt} &= 2x - \frac{1}{16} \left[ (8-x) \frac{dv}{dt} - v^2 \right] \\ x \frac{dv}{dt} + v^2 &= 32x - (8-x) \frac{dv}{dt} + v^2 \\ x \frac{dv}{dt} &= 32x - 8 \frac{dv}{dt} + x \frac{dv}{dt} \\ 8 \frac{dv}{dt} &= 32x. \end{aligned}$$

By the chain rule,  $dv/dt = (dv/dx)(dx/dt) = v dv/dx$ , so

$$8 \frac{dv}{dt} = 8v \frac{dv}{dx} = 32x \quad \text{and} \quad v \frac{dv}{dx} = 4x.$$

- (b) Integrating  $v dv = 4x dx$  we get  $\frac{1}{2}v^2 = 2x^2 + c$ . Since  $v = 0$  when  $x = 3$ , we have  $c = -18$ . Then  $v^2 = 4x^2 - 36$  and  $v = \sqrt{4x^2 - 36}$ . Using  $v = dx/dt$ , separating variables, and integrating we obtain

$$\frac{dx}{\sqrt{x^2 - 9}} = 2 dt \quad \text{and} \quad \cosh^{-1} \frac{x}{3} = 2t + c_1.$$

Solving for  $x$  we get  $x(t) = 3 \cosh(2t + c_1)$ . Since  $x = 3$  when  $t = 0$ , we have  $\cosh c_1 = 1$  and  $c_1 = 0$ . Thus,  $x(t) = 3 \cosh 2t$ . Differentiating, we find  $v(t) = dx/dt = 6 \sinh 2t$ .

- (c) To find when the back end of the chain will leave the platform we solve  $x(t) = 3 \cosh 2t = 8$ . This gives  $t_1 = \frac{1}{2} \cosh^{-1} \frac{8}{3} \approx 0.8184$  seconds. The velocity at this instant is  $v(t_1) = 6 \sinh(\cosh^{-1} \frac{8}{3}) = 2\sqrt{55} \approx 14.83$  ft/s.

### Exercises 5.3

(d) Replacing 8 with  $L$  and 32 with  $g$  in part (a) we have  $L dv/dt = gx$ . Then

$$L \frac{dv}{dt} = Lv \frac{dv}{dx} = gx \quad \text{and} \quad v \frac{dv}{dx} = \frac{g}{L} x.$$

Integrating we get  $\frac{1}{2}v^2 = \frac{g}{2L}x^2 + c$ . Setting  $x = x_0$  and  $v = 0$ , we find  $c = -\frac{g}{2L}x_0^2$ . Solving for  $v$  we find

$$v(x) = \sqrt{\frac{g}{L}x^2 - \frac{g}{L}x_0^2}.$$

Then the velocity at which the end of the chain leaves the edge of the platform is

$$v(L) = \sqrt{\frac{g}{L}(L^2 - x_0^2)}.$$

19. Let  $(x, y)$  be the coordinates of  $S_2$  on the curve  $C$ . The slope at  $(x, y)$  is then

$$dy/dx = (v_1t - y)/(0 - x) = (y - v_1t)/x \quad \text{or} \quad xy' - y = -v_1t.$$

Differentiating with respect to  $x$  and using  $r = v_1/v_2$  gives

$$\begin{aligned} xy'' + y' - y' &= -v_1 \frac{dt}{dx} \\ xy'' &= -v_1 \frac{dt}{ds} \frac{ds}{dx} \\ xy'' &= -v_1 \frac{1}{v_2} (-\sqrt{1 + (y')^2}) \\ xy'' &= r\sqrt{1 + (y')^2}. \end{aligned}$$

Letting  $u = y'$  and separating variables, we obtain

$$\begin{aligned} x \frac{du}{dx} &= r\sqrt{1 + u^2} \\ \frac{du}{\sqrt{1 + u^2}} &= \frac{r}{x} dx \\ \sinh^{-1} u &= r \ln x + \ln c = \ln(cx^r) \\ u &= \sinh(\ln cx^r) \end{aligned}$$

$$\frac{dy}{dx} = \frac{1}{2} \left( cx^r - \frac{1}{cx^r} \right).$$

At  $t = 0$ ,  $dy/dx = 0$  and  $x = a$ , so  $0 = ca^r - 1/ca^r$ . Thus  $c = 1/a^r$  and

$$\frac{dy}{dx} = \frac{1}{2} \left[ \left( \frac{x}{a} \right)^r - \left( \frac{a}{x} \right)^r \right] = \frac{1}{2} \left[ \left( \frac{x}{a} \right)^r - \left( \frac{x}{a} \right)^{-r} \right].$$

If  $r > 1$  or  $r < 1$ , integrating gives

$$y = \frac{a}{2} \left[ \frac{1}{1+r} \left( \frac{x}{a} \right)^{1+r} - \frac{1}{1-r} \left( \frac{x}{a} \right)^{1-r} \right] + c_1.$$

### Exercises 5.3

When  $t = 0$ ,  $y = 0$  and  $x = a$ , so  $0 = (a/2)[1/(1+r) - 1/(1-r)] + c_1$ . Thus  $c_1 = ar/(1-r^2)$  and

$$y = \frac{a}{2} \left[ \frac{1}{1+r} \left(\frac{x}{a}\right)^{1+r} - \frac{1}{1-r} \left(\frac{x}{a}\right)^{1-r} \right] + \frac{ar}{1-r^2}.$$

To see if the paths ever intersect we first note that if  $r > 1$ , then  $v_1 > v_2$  and  $y \rightarrow \infty$  as  $x \rightarrow 0^+$ . In other words,  $S_2$  always lags behind  $S_1$ . Next, if  $r < 1$ , then  $v_1 < v_2$  and  $y = ar/(1-r^2)$  when  $x = 0$ . In other words, when the submarine's speed is greater than the ship's, their paths will intersect at the point  $(0, ar/(1-r^2))$ .

Finally, if  $r = 1$ , then integration gives

$$y = \frac{1}{2} \left[ \frac{x^2}{2a} - \frac{1}{a} \ln x \right] + c_2.$$

When  $t = 0$ ,  $y = 0$  and  $x = a$ , so  $0 = (1/2)[a/2 - (1/a) \ln a] + c_2$ . Thus  $c_2 = -(1/2)[a/2 - (1/a) \ln a]$  and

$$y = \frac{1}{2} \left[ \frac{x^2}{2a} - \frac{1}{a} \ln x \right] - \frac{1}{2} \left[ \frac{a}{2} - \frac{1}{a} \ln a \right] = \frac{1}{2} \left[ \frac{1}{2a}(x^2 - a^2) + \frac{1}{a} \ln \frac{a}{x} \right].$$

Since  $y \rightarrow \infty$  as  $x \rightarrow 0^+$ ,  $S_2$  will never catch up with  $S_1$ .

20. (a) Let  $(r, \theta)$  denote the polar coordinates of the destroyer  $S_1$ . When  $S_1$  travels the 6 miles from  $(9, 0)$  to  $(3, 0)$  it stands to reason, since  $S_2$  travels half as fast as  $S_1$ , that the polar coordinates of  $S_2$  are  $(3, \theta_2)$ , where  $\theta_2$  is unknown. In other words, the distances of the ships from  $(0, 0)$  are the same and  $r(t) = 15t$  then gives the radial distance of both ships. This is necessary if  $S_1$  is to intercept  $S_2$ .

- (b) The differential of arc length in polar coordinates is  $(ds)^2 = (r d\theta)^2 + (dr)^2$ , so that

$$\left(\frac{ds}{dt}\right)^2 = r^2 \left(\frac{d\theta}{dt}\right)^2 + \left(\frac{dr}{dt}\right)^2.$$

Using  $ds/dt = 30$  and  $dr/dt = 15$  then gives

$$900 = 225t^2 \left(\frac{d\theta}{dt}\right)^2 + 225$$

$$675 = 225t^2 \left(\frac{d\theta}{dt}\right)^2$$

$$\frac{d\theta}{dt} = \frac{\sqrt{3}}{t}$$

$$\theta(t) = \sqrt{3} \ln t + c = \sqrt{3} \ln \frac{r}{15} + c.$$

When  $r = 3$ ,  $\theta = 0$ , so  $c = -\sqrt{3} \ln(1/5)$  and

$$\theta(t) = \sqrt{3} \left( \ln \frac{r}{15} - \ln \frac{1}{5} \right) = \sqrt{3} \ln \frac{r}{3}.$$

### Exercises 5.3

Thus  $r = 3e^{\theta/\sqrt{3}}$ , whose graph is a logarithmic spiral.

- (c) The time for  $S_1$  to go from  $(9, 0)$  to  $(3, 0) = \frac{1}{5}$  hour. Now  $S_1$  must intercept the path of  $S_2$  for some angle  $\beta$ , where  $0 < \beta < 2\pi$ . At the time of interception  $t_2$  we have  $15t_2 = 3e^{\beta/\sqrt{3}}$  or  $t = e^{\beta/\sqrt{3}}/5$ . The total time is then

$$t = \frac{1}{5} + \frac{1}{5}e^{\beta/\sqrt{3}} < \frac{1}{5}(1 + e^{2\pi/\sqrt{3}}).$$

21. Since  $(dx/dt)^2$  is always positive, it is necessary to use  $|dx/dt|(dx/dt)$  in order to account for the fact that the motion is oscillatory and the velocity (or its square) should be negative when the spring is contracting.
22. (a) The approximation is accurate to two decimal places for  $\theta_1 = 0.3$ , and accurate to one decimal place for  $\theta_1 = 0.6$ .

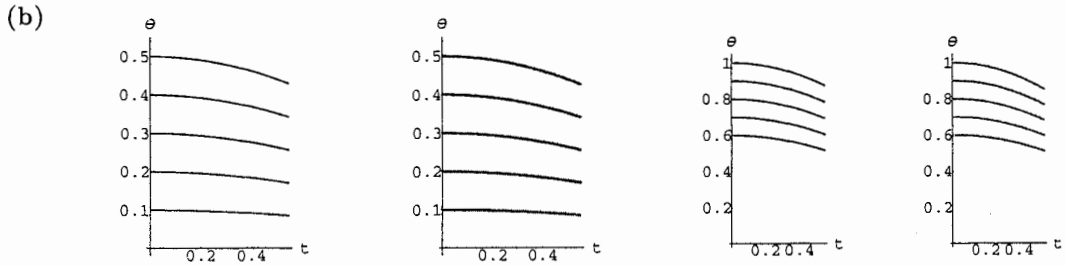
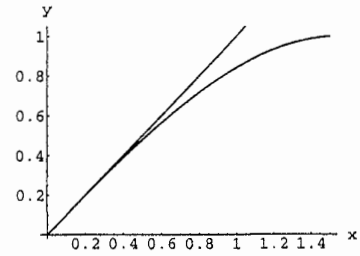

The thinner curves are solutions of the nonlinear differential equation, while the thicker curves are solutions of the linear differential equation.

23. (a) Write the differential equation as

$$\frac{d^2\theta}{dt^2} + \omega^2 \sin \theta = 0,$$

where  $\omega^2 = g/l$ . To test for differences between the earth and the moon we take  $l = 3$ ,  $\theta(0) = 1$ , and  $\theta'(0) = 2$ . Using  $g = 32$  on the earth and  $g = 5.5$  on the moon we obtain the graphs shown in the figure.

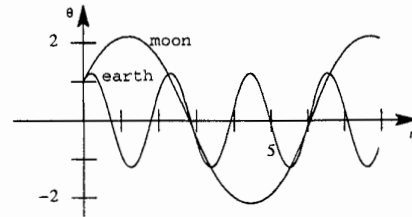

Comparing the apparent periods of the graphs, we see that the pendulum oscillates faster on the earth than on the moon.

- (b) The amplitude is greater on the moon than on the earth.  
 (c) The linear model is

$$\frac{d^2\theta}{dt^2} + \omega^2\theta = 0,$$

where  $\omega^2 = g/\ell$ . When  $g = 32$ ,  $\ell = 3$ ,  $\theta(0) = 1$ , and  $\theta'(0) = 2$ , the general solution is

$$\theta(t) = \cos 3.266t + 0.612 \sin 3.266t.$$

When  $g = 5.5$  the general solution is

$$\theta(t) = \cos 1.354t + 1.477 \sin 1.354t.$$

As in the nonlinear case, the pendulum oscillates faster on the earth than on the moon and still has greater amplitude on the moon.

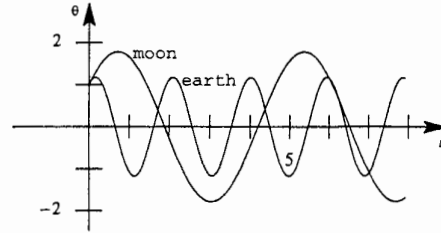

24. (a) The general solution of

$$\frac{d^2\theta}{dt^2} + \theta = 0$$

is  $\theta(t) = c_1 \cos t + c_2 \sin t$ . From  $\theta(0) = \pi/12$  and  $\theta'(0) = -1/3$  we find

$$\theta(t) = (\pi/12) \cos t - (1/3) \sin t.$$

Setting  $\theta(t) = 0$  we have  $\tan t = \pi/4$  which implies  $t_1 = \tan^{-1}(\pi/4) \approx 0.66577$ .

- (b) We set  $\theta(t) = \theta(0) + \theta'(0)t + \frac{1}{2}\theta''(0)t^2 + \frac{1}{6}\theta'''(0)t^3 + \dots$  and use  $\theta''(t) = -\sin\theta(t)$  together with  $\theta(0) = \pi/12$  and  $\theta'(0) = -1/3$ . Then

$$\theta''(0) = -\sin(\pi/12) = -\sqrt{2}(\sqrt{3}-1)/4$$

and

$$\theta'''(0) = -\cos\theta(0) \cdot \theta'(0) = -\cos(\pi/12)(-1/3) = \sqrt{2}(\sqrt{3}+1)/12.$$

Thus

$$\theta(t) = \frac{\pi}{12} - \frac{1}{3}t - \frac{\sqrt{2}(\sqrt{3}-1)}{8}t^2 + \frac{\sqrt{2}(\sqrt{3}+1)}{72}t^3 + \dots$$

- (c) Setting  $\pi/12 - t/3 = 0$  we obtain  $t_1 = \pi/4 \approx 0.785398$ .  
 (d) Setting

$$\frac{\pi}{12} - \frac{1}{3}t - \frac{\sqrt{2}(\sqrt{3}-1)}{8}t^2 = 0$$

and using the positive root we obtain  $t_1 \approx 0.63088$ .

- (e) Setting

$$\frac{\pi}{12} - \frac{1}{3}t - \frac{\sqrt{2}(\sqrt{3}-1)}{8}t^2 + \frac{\sqrt{2}(\sqrt{3}+1)}{72}t^3 = 0$$

**Exercises 5.3**

we find  $t_1 \approx 0.661973$  to be the first positive root.

- (f) From the output we see that  $y(t)$  is an interpolating function on the interval  $0 \leq t \leq 5$ , whose graph is shown. The positive root of  $y(t) = 0$  near  $t = 1$  is  $t_1 = 0.666404$ .

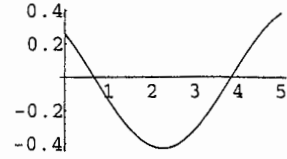

- (g) To find the next two positive roots we change the interval used in **NDSolve** and **Plot** from  $\{t, 0, 5\}$  to  $\{t, 0, 10\}$ . We see from the graph that the second and third positive roots are near 4 and 7, respectively. Replacing  $\{t, 1\}$  in **FindRoot** with  $\{t, 4\}$  and then  $\{t, 7\}$  we obtain  $t_2 = 3.84411$  and  $t_3 = 7.0218$ .

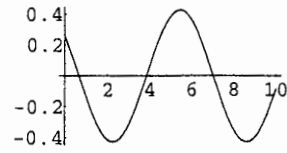

25. From the table below we see that the pendulum first passes the vertical position between 1.7 and 1.8 seconds. To refine our estimate of  $t_1$  we estimate the solution of the differential equation on  $[1.7, 1.8]$  using a step size of  $h = 0.01$ . From the resulting table we see that  $t_1$  is between 1.76 and 1.77 seconds. Repeating the process with  $h = 0.001$  we conclude that  $t_1 \approx 1.767$ . Then the period of the pendulum is approximately  $4t_1 = 7.068$ . The error when using  $t_1 = 2\pi$  is  $7.068 - 6.283 = 0.785$  and the percentage relative error is  $(0.785/7.068)100 = 11.1$ .

h=0.1		h=0.01	
$t_n$	$\theta_n$	$t_n$	$\theta_n$
0.00	0.78540	1.70	0.07706
0.10	0.78523	1.71	0.06572
0.20	0.78407	1.72	0.05428
0.30	0.78092	1.73	0.04275
0.40	0.77482	1.74	0.03111
0.50	0.76482	1.75	0.01938
0.60	0.75004	1.76	0.00755
0.70	0.72962	1.77	-0.00438
0.80	0.70275	1.78	-0.01641
0.90	0.66872	1.79	-0.02854
1.00	0.62687	1.80	-0.04076
1.10	0.57660		
1.20	0.51744		
1.30	0.44895		
1.40	0.37085		
1.50	0.28289		
1.60	0.18497		
1.70	0.07706		
1.80	-0.04076		
1.90	-0.16831		
2.00	-0.30531		

h=0.001	
$t_n$	$\theta_n$
1.763	0.00398
1.764	0.00279
1.765	0.00160
1.766	0.00040
1.767	-0.00079
1.768	-0.00199
1.769	-0.00318
1.770	-0.00438

## Chapter 5 Review Exercises

1. 8 ft., since  $k = 4$ .
2.  $2\pi/5$ , since  $\frac{1}{4}x'' + 6.25x = 0$ .
3.  $5/4$  m, since  $x = -\cos 4t + \frac{3}{4}\sin 4t$ .
4. True
5. False; since an external force may exist.
6. False
7. overdamped
8. From  $x(0) = (\sqrt{2}/2)\sin\phi = -1/2$  we see that  $\sin\phi = -1/\sqrt{2}$ , so  $\phi$  is an angle in the third or fourth quadrant. Since  $x'(t) = \sqrt{2}\cos(2t + \phi)$ ,  $x'(0) = \sqrt{2}\cos\phi = 1$  and  $\cos\phi > 0$ . Thus  $\phi$  is in the fourth quadrant and  $\phi = -\pi/4$ .
9. The period of a spring mass system is given by  $T = 2\pi/\omega$  where  $\omega^2 = k/m = kg/W$ , where  $k$  is the spring constant,  $W$  is the weight of the mass attached to the spring, and  $g$  is the acceleration due to gravity. Thus, the period of oscillation is  $T = (2\pi/\sqrt{kg})\sqrt{W}$ . If the weight of the original mass is  $W$ , then  $(2\pi/\sqrt{kg})\sqrt{W} = 3$  and  $(2\pi/\sqrt{kg})\sqrt{W-8} = 2$ . Dividing, we get  $\sqrt{W}/\sqrt{W-8} = 3/2$  or  $W = \frac{9}{4}(W-8)$ . Solving for  $W$  we find that the weight of the original mass was 14.4 pounds.
10. (a) Solving  $\frac{3}{8}x'' + 6x = 0$  subject to  $x(0) = 1$  and  $x'(0) = -4$  we obtain
 
$$x = \cos 4t - \sin 4t = \sqrt{2}\sin(4t + 3\pi/4).$$
  - (b) The amplitude is  $\sqrt{2}$ , period is  $\pi/2$ , and frequency is  $2/\pi$ .
  - (c) If  $x = 1$  then  $t = n\pi/2$  and  $t = -\pi/8 + n\pi/2$  for  $n = 1, 2, 3, \dots$
  - (d) If  $x = 0$  then  $t = \pi/16 + n\pi/4$  for  $n = 0, 1, 2, \dots$ . The motion is upward for  $n$  even and downward for  $n$  odd.
  - (e)  $x'(3\pi/16) = 0$
  - (f) If  $x' = 0$  then  $4t + 3\pi/4 = \pi/2 + n\pi$  or  $t = 3\pi/16 + n\pi$ .
11. From  $\frac{1}{4}x'' + \frac{3}{2}x' + 2x = 0$ ,  $x(0) = 1/3$ , and  $x'(0) = 0$  we obtain  $x = \frac{2}{3}e^{-2t} - \frac{1}{3}e^{-4t}$ .
12. From  $x'' + \beta x' + 64x = 0$  we see that oscillatory motion results if  $\beta^2 - 256 < 0$  or  $0 < |\beta| < 16$ .
13. From  $mx'' + 4x' + 2x = 0$  we see that non-oscillatory motion results if  $16 - 8m \geq 0$  or  $0 < m \leq 2$ .
14. From  $\frac{1}{4}x'' + x' + x = 0$ ,  $x(0) = 4$ , and  $x'(0) = 2$  we obtain  $x = 4e^{-2t} + 10te^{-2t}$ . If  $x'(t) = 0$ , then  $t = 1/10$ , so that the maximum displacement is  $x = 5e^{-0.2} \approx 4.094$ .
15. Writing  $\frac{1}{8}x'' + \frac{8}{3}x = \cos\gamma t + \sin\gamma t$  in the form  $x'' + \frac{64}{3}x = 8\cos\gamma t + 8\sin\gamma t$  we identify  $\lambda = 0$  and  $\omega^2 = 64/3$ . The system is in a state of pure resonance when  $\gamma = \omega = \sqrt{64/3} = 8/\sqrt{3}$ .

## Chapter 5 Review Exercises

16. Clearly  $x_p = A/\omega^2$  suffices.

17. From  $\frac{1}{8}x'' + x' + 3x = e^{-t}$ ,  $x(0) = 2$ , and  $x'(0) = 0$  we obtain  $x_c = e^{-4t}(c_1 \cos 2\sqrt{2}t + c_2 \sin 2\sqrt{2}t)$ ,  
 $x_p = \frac{8}{17}e^{-t}$ , and

$$x = e^{-4t} \left( \frac{26}{17} \cos 2\sqrt{2}t + \frac{28\sqrt{2}}{17} \sin 2\sqrt{2}t \right) + \frac{8}{17}e^{-t}.$$

18. (a) Let  $k$  be the effective spring constant and  $x_1$  and  $x_2$  the elongation of springs  $k_1$  and  $k_2$ . The restoring forces satisfy  $k_1x_1 = k_2x_2$  so  $x_2 = (k_1/k_2)x_1$ . From  $k(x_1 + x_2) = k_1x_1$  we have

$$k \left( x_1 + \frac{k_1}{k_2} x_2 \right) = k_1 x_1$$

$$k \left( \frac{k_2 + k_1}{k_2} \right) = k_1$$

$$k = \frac{k_1 k_2}{k_1 + k_2}$$

$$\frac{1}{k} = \frac{1}{k_1} + \frac{1}{k_2}.$$

(b) From  $k_1 = 2W$  and  $k_2 = 4W$  we find  $1/k = 1/2W + 1/4W = 3/4W$ . Then  $k = 4W/3 = 4mg/3$ .  
 The differential equation  $mx'' + kx = 0$  then becomes  $x'' + (4g/3)x = 0$ . The solution is

$$x(t) = c_1 \cos 2\sqrt{\frac{g}{3}}t + c_2 \sin 2\sqrt{\frac{g}{3}}t.$$

The initial conditions  $x(0) = 1$  and  $x'(0) = 2/3$  imply  $c_1 = 1$  and  $c_2 = 1/\sqrt{3g}$ .

(c) To compute the maximum speed of the weight we compute

$$x'(t) = 2\sqrt{\frac{g}{3}} \sin 2\sqrt{\frac{g}{3}}t + \frac{2}{3} \cos 2\sqrt{\frac{g}{3}}t \quad \text{and} \quad |x'(t)| = \sqrt{4\frac{g}{3} + \frac{4}{9}} = \frac{2}{3}\sqrt{3g+1}.$$

19. From  $q'' + 10^4q = 100 \sin 50t$ ,  $q(0) = 0$ , and  $q'(0) = 0$  we obtain  $q_c = c_1 \cos 100t + c_2 \sin 100t$ ,  
 $q_p = \frac{1}{75} \sin 50t$ , and

(a)  $q = -\frac{1}{150} \sin 100t + \frac{1}{75} \sin 50t$ ,

(b)  $i = -\frac{2}{3} \cos 100t + \frac{2}{3} \cos 50t$ , and

(c)  $q = 0$  when  $\sin 50t(1 - \cos 50t) = 0$  or  $t = n\pi/50$  for  $n = 0, 1, 2, \dots$ .

20. (a) By Kirchoff's second law,

$$L \frac{d^2q}{dt^2} + R \frac{dq}{dt} + \frac{1}{C} q = E(t).$$

Using  $q'(t) = i(t)$  we can write the differential equation in the form

$$L \frac{di}{dt} + Ri + \frac{1}{C} q = E(t).$$



Then differentiating we obtain

$$L \frac{d^2 i}{dt^2} + R \frac{di}{dt} + \frac{1}{C} i = E'(t).$$

- (b) From  $Li'(t) + Ri(t) + (1/C)q(t) = E(t)$  we find  $Li'(0) + Ri(0) + (1/C)q(0) = E(0)$  or  $Li'(0) + Ri_0 + (1/C)q_0 = E(0)$ . Solving for  $i'(0)$  we get

$$i'(0) = \frac{1}{L} \left[ E(0) - \frac{1}{C} q_0 - Ri_0 \right].$$

21. For  $\lambda > 0$  the general solution is  $y = c_1 \cos \sqrt{\lambda} x + c_2 \sin \sqrt{\lambda} x$ . Now  $y(0) = c_1$  and  $y(2\pi) = c_1 \cos 2\pi\sqrt{\lambda} + c_2 \sin 2\pi\sqrt{\lambda}$ , so the condition  $y(0) = y(2\pi)$  implies

$$c_1 = c_1 \cos 2\pi\sqrt{\lambda} + c_2 \sin 2\pi\sqrt{\lambda}$$

which is true when  $\sqrt{\lambda} = n$  or  $\lambda = n^2$  for  $n = 1, 2, 3, \dots$ . Since

$$y' = -\sqrt{\lambda} c_1 \sin \sqrt{\lambda} x + \sqrt{\lambda} c_2 \cos \sqrt{\lambda} x = -nc_1 \sin nx + nc_2 \cos nx,$$

we see that  $y'(0) = nc_2 = y'(2\pi)$  for  $n = 1, 2, 3, \dots$ . Thus, the eigenvalues are  $n^2$  for  $n = 1, 2, 3, \dots$ , with corresponding eigenfunctions  $\cos nx$  and  $\sin nx$ . When  $\lambda = 0$ , the general solution is  $y = c_1 x + c_2$  and the corresponding eigenfunction is  $y = 1$ .

For  $\lambda < 0$  the general solution is  $y = c_1 \cosh \sqrt{-\lambda} x + c_2 \sinh \sqrt{-\lambda} x$ . In this case  $y(0) = c_1$  and  $y(2\pi) = c_1 \cosh 2\pi\sqrt{-\lambda} + c_2 \sinh 2\pi\sqrt{-\lambda}$ , so  $y(0) = y(2\pi)$  can only be valid for  $\lambda = 0$ . Thus, there are no eigenvalues corresponding to  $\lambda < 0$ .

22. (a) The differential equation is  $d^2 r/dt^2 - \omega^2 r = -g \sin \omega t$ . The auxiliary equation is  $m^2 - \omega^2 = 0$ , so  $r_c = c_1 e^{\omega t} + c_2 e^{-\omega t}$ . A particular solution has the form  $r_p = A \sin \omega t + B \cos \omega t$ . Substituting into the differential equation we find  $-2A\omega^2 \sin \omega t - 2B\omega^2 \cos \omega t = -g \sin \omega t$ . Thus,  $B = 0$ ,  $A = g/2\omega^2$ , and  $r_p = (g/2\omega^2) \sin \omega t$ . The general solution of the differential equation is  $r(t) = c_1 e^{\omega t} + c_2 e^{-\omega t} + (g/2\omega^2) \sin \omega t$ . The initial conditions imply  $c_1 + c_2 = r_0$  and  $g/2\omega - \omega c_1 + \omega c_2 = v_0$ . Solving for  $c_1$  and  $c_2$  we get

$$c_1 = (2\omega^2 r_0 + 2\omega v_0 - g)/4\omega^2 \quad \text{and} \quad c_2 = (2\omega^2 r_0 - 2\omega v_0 + g)/4\omega^2,$$

so that

$$r(t) = \frac{2\omega^2 r_0 + 2\omega v_0 - g}{4\omega^2} e^{\omega t} + \frac{2\omega^2 r_0 - 2\omega v_0 + g}{4\omega^2} e^{-\omega t} + \frac{g}{2\omega^2} \sin \omega t.$$

- (b) The bead will exhibit simple harmonic motion when the exponential terms are missing. Solving  $c_1 = 0$ ,  $c_2 = 0$  for  $r_0$  and  $v_0$  we find  $r_0 = 0$  and  $v_0 = g/2\omega$ .

To find the minimum length of rod that will accommodate simple harmonic motion we determine the amplitude of  $r(t)$  and double it. Thus  $L = g/\omega^2$ .

## Chapter 5 Review Exercises

- (c) As  $t$  increases,  $e^{\omega t}$  approaches infinity and  $e^{-\omega t}$  approaches 0. Since  $\sin \omega t$  is bounded, the distance,  $r(t)$ , of the bead from the pivot point increases without bound and the distance of the bead from  $P$  will eventually exceed  $L/2$ .

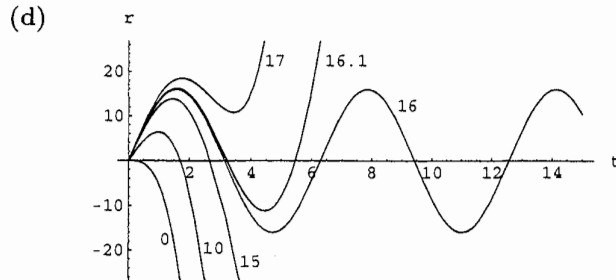

- (e) For each  $v_0$  we want to find the smallest value of  $t$  for which  $r(t) = \pm 20$ . Whether we look for  $r(t) = -20$  or  $r(t) = 20$  is determined by looking at the graphs in part (d). The total times that the bead stays on the rod is shown in the table below.

$v_0$	0	10	15	16.1	17
$r$	-20	-20	-20	20	20
$t$	1.55007	2.35494	3.43088	6.11627	4.22339

When  $v_0 = 16$  the bead never leaves the rod.

## Chapter 5 Related Exercises

1. (a) The auxiliary equation is  $m^2 + 4 = 0$  so  $x_c = c_1 \cos 2t + c_2 \sin 2t$ . Letting  $x_p = A \sin 4t + B \cos 4t$  and substituting into the differential equation, we get  $-12A \sin 4t - 12B \cos 4t = \sin 4t$ . Thus,  $A = -\frac{1}{12}$ ,  $B = 0$ , and  $x_p = -\frac{1}{12} \sin 4t$ . The general solution of the differential equation is  $x = c_1 \cos 2t + c_2 \sin 2t - \frac{1}{12} \sin 4t$ . The initial conditions imply  $c_1 = 0$  and  $c_2 = \frac{1}{2}(\alpha + \frac{1}{3})$ . Thus

$$\begin{aligned} x(t) &= \frac{1}{2} \left( \alpha + \frac{1}{3} \right) \sin 2t - \frac{1}{12} \sin 4t \\ &= \frac{1}{2} \left( \alpha + \frac{1}{3} \right) \sin 2t - \frac{1}{12} (2 \sin 2t \cos 2t) \\ &= \sin 2t \left[ \frac{1}{2} \left( \alpha + \frac{1}{3} \right) - \frac{1}{6} \cos 2t \right], \quad 0 \leq t \leq \frac{\pi}{2}. \end{aligned}$$

For  $x'' + x = \sin 4t$  the auxiliary equation is  $m^2 + 1 = 0$ , so  $x_c = c_1 \cos t + c_2 \sin t$ . Letting  $x_p = A \sin 4t + B \cos 4t$  and substituting into the differential equation we get  $-15A \sin 4t - 15B \cos 4t = \sin 4t$ . Thus,  $A = -\frac{1}{15}$ ,  $B = 0$ , and  $x_p = -\frac{1}{15} \sin 4t$ . The general solution of

Chapter 5 Related Exercises

the differential equation is  $x = c_1 \cos t + c_2 \sin t - \frac{1}{15} \sin 4t$ . The initial conditions  $x(\pi/2) = 0$ ,  $x'(\pi/2) = -(\alpha + \frac{2}{3})$  imply  $c_1 = \alpha + \frac{2}{5}$  and  $c_2 = 0$ . Thus

$$\begin{aligned} x(t) &= \left(\alpha + \frac{2}{5}\right) \cos t - \frac{1}{15} \sin 4t \\ &= \left(\alpha + \frac{2}{5}\right) \cos t - \frac{1}{15} (2 \sin 2t \cos 2t) \\ &= \left(\alpha + \frac{2}{5}\right) \cos t - \frac{2}{15} (2 \sin t \cos t \cos 2t) \\ &= \cos t \left[ \left(\alpha + \frac{2}{5}\right) - \frac{4}{15} \sin t \cos 2t \right], \quad \frac{\pi}{2} \leq t \leq \frac{3\pi}{2}. \end{aligned}$$

(b) The velocity at the start of the second cycle is  $x'(3\pi/2) = \alpha + \frac{2}{15}$ .

(c) Using results from part (a),  $x = c_1 \cos 2t + c_2 \sin 2t - \frac{1}{12} \sin 4t$ . The initial conditions are now  $x(3\pi/2) = 0$  and  $x'(3\pi/2) = \alpha + \frac{2}{15}$ , which imply  $c_1 = 0$  and  $c_2 = -\frac{1}{2}(\alpha + \frac{7}{15})$ . Thus

$$\begin{aligned} x(t) &= -\frac{1}{2} \left(\alpha + \frac{7}{15}\right) \sin 2t - \frac{1}{12} \sin 4t \\ &= -\frac{1}{2} \left(\alpha + \frac{7}{15}\right) \sin 2t - \frac{1}{12} (2 \sin 2t \cos 2t) \\ &= \sin 2t \left[ -\frac{1}{2} \left(\alpha + \frac{7}{15}\right) - \frac{1}{6} \cos 2t \right], \quad \frac{3\pi}{2} \leq t \leq 2\pi. \end{aligned}$$

For  $t \geq 2\pi$  we have  $x = c_1 \cos t + c_2 \sin t - \frac{1}{15} \sin 4t$ , as in part (a). The initial conditions are  $x(2\pi) = 0$  and  $x'(2\pi) = -(\alpha + \frac{4}{5})$ , which imply  $c_1 = 0$  and  $c_2 = -(\alpha + \frac{8}{15})$ . Thus

$$\begin{aligned} x(t) &= -\left(\alpha + \frac{8}{15}\right) \sin t - \frac{1}{15} \sin 4t \\ &= -\left(\alpha + \frac{8}{15}\right) \sin t - \frac{1}{15} (2 \sin 2t \cos 2t) \\ &= -\left(\alpha + \frac{8}{15}\right) \sin t - \frac{2}{15} (2 \sin t \cos t \cos 2t) \\ &= \sin t \left[ -\left(\alpha + \frac{8}{15}\right) - \frac{4}{15} \cos t \cos 2t \right], \quad 2\pi \leq t \leq 3\pi. \end{aligned}$$

(d)

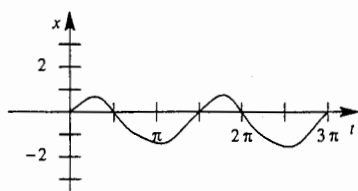

$\alpha = 1$

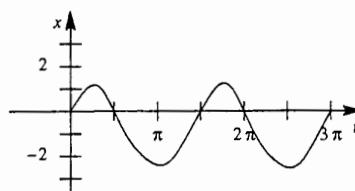

$\alpha = 2$

## Chapter 5 Related Exercises

2. (a) We have  $x_c = c_1 \cos t + c_2 \sin t$  and we let  $x_p = At \cos t + Bt \sin t$ . Substituting into the differential equation we get  $2B \cos t - 2A \sin t = \cos t$ . Thus  $A = 0$ ,  $B = -\frac{1}{2}$ , and  $x_p = \frac{1}{2}t \sin t$ . The general solution of the differential equation is  $x(t) = c_1 \cos t + c_2 \sin t + \frac{1}{2}t \sin t$ . The initial conditions imply  $c_1 = 0$  and  $c_2 = 0$ , so the solution of the initial-value problem is  $x(t) = \frac{1}{2}t \sin t$ .
- (b) We have  $x_c = c_1 \cos t + c_2 \sin t$  and we let  $x_p = A \cos 2t + B \sin 2t$ . Substituting into the differential equation we get  $-3A \cos 2t - 3B \sin 2t = \cos 2t$ . Thus  $A = -\frac{1}{3}$ ,  $B = 0$ , and  $x_p = -\frac{1}{3} \cos 2t$ . The general solution of the differential equation is  $x(t) = c_1 \cos t + c_2 \sin t - \frac{1}{3} \cos 2t$ . The initial conditions imply  $c_1 = \frac{1}{3}$  and  $c_2 = 0$ , so the solution of the initial-value problem is  $x(t) = \frac{1}{3} \cos t - \frac{1}{3} \cos 2t$ .
3. (a) In the first case the differential equations are  $x'' + x = \sin 4t$  when  $x \geq 0$  and  $x'' + 4x = \sin 4t$  when  $x < 0$ . Since the initial velocity is positive, we solve first for  $x \geq 0$ . The solution of  $x'' + x = \sin 4t$  is  $x(t) = c_1 \cos t + c_2 \sin t - \frac{1}{15} \sin 4t$ , as seen in Problem 1(a). The initial conditions  $x(0) = 0$  and  $x'(0) = 1$  imply  $c_1 = 0$  and  $c_2 = \frac{19}{15}$ , so the solution of the initial-value problem is

$$\begin{aligned} x(t) &= \frac{19}{15} \sin t - \frac{1}{15} \sin 4t \\ &= \frac{19}{15} \sin t - \frac{1}{15} (2 \sin 2t \cos 2t) \\ &= \frac{19}{15} \sin t - \frac{2}{15} (2 \sin t \cos t \cos 2t) \\ &= (\sin t) \left( \frac{19}{15} - \frac{4}{15} \cos t \cos 2t \right), \quad 0 \leq t \leq \pi. \end{aligned}$$

The first positive value of  $t$  for which  $x(t)$  is zero is  $t = \pi$ , at which time  $x'(\pi) = -\frac{23}{15} < 0$ , so  $x < 0$  immediately after  $t = \pi$ . The new initial-value problem is then  $x'' + 4x = \sin 4t$ ,  $x(\pi) = 0$ ,  $x'(\pi) = -\frac{23}{15}$ . The solution of this initial-value problem is

$$x(t) = -\frac{3}{5} \sin 2t - \frac{1}{12} \sin 4t = (\sin 2t) \left( -\frac{3}{5} - \frac{1}{6} \cos 2t \right), \quad \pi \leq t \leq \frac{3\pi}{2}.$$

The next value of  $t$  for which  $x(t) = 0$  is  $t = 3\pi/2$ , at which time  $x'(3\pi/2) = \frac{13}{15} > 0$ , so  $x > 0$  immediately after  $t = 3\pi/2$ . The next initial-value problem is then  $x'' + x = \sin 4t$ ,  $x(3\pi/2) = 0$ ,  $x'(3\pi/2) = \frac{13}{15}$ . The solution of this initial-value problem is

$$x(t) = \frac{17}{15} \cos t - \frac{1}{15} \sin 4t = (\cos t) \left( \frac{17}{15} - \frac{4}{15} \sin t \cos 2t \right), \quad \frac{3\pi}{2} \leq t \leq \frac{5\pi}{2}.$$

The next value of  $t$  for which  $x(t) = 0$  is  $t = 5\pi/2$ , at which time  $x'(5\pi/2) = -\frac{7}{5} < 0$ , so  $x < 0$  immediately after  $t = 5\pi/2$ . The next initial-value problem is then  $x'' + 4x = \sin 4t$ ,  $x(5\pi/2) = 0$ ,  $x'(5\pi/2) = -\frac{7}{5}$ . The solution of this initial-value problem is

$$x(t) = \frac{1}{15} \sin 2t - \frac{1}{12} \sin 4t = (\sin 2t) \left( \frac{1}{15} - \frac{1}{6} \cos 2t \right), \quad \frac{5\pi}{2} \leq t \leq b$$

where  $b$  is the value of  $t$  for which  $x(t) = 0$ . In this case,  $\frac{1}{15} - \frac{1}{6} \cos 2t$  is 0 for  $t = 8.84514$ , which is between  $5\pi/2$  and  $3\pi$ . Thus, for the first two cycles,

$$x(t) = \begin{cases} (\sin t)\left(\frac{19}{15} - \frac{4}{15} \cos t \cos 2t\right), & 0 \leq t \leq \pi \\ (\sin 2t)\left(-\frac{3}{5} - \frac{1}{6} \cos 2t\right), & \pi \leq t \leq \frac{3\pi}{2} \\ (\cos t)\left(\frac{17}{15} - \frac{4}{15} \sin t \cos 2t\right), & \frac{3\pi}{2} \leq t \leq \frac{5\pi}{2} \\ (\sin 2t)\left(\frac{1}{15} - \frac{1}{6} \cos 2t\right), & \frac{5\pi}{2} \leq t \leq 8.84514. \end{cases}$$

The first part of the next cycle is the solution of the initial-value problem  $x'' + x = \sin 4t$ ,  $x(8.84514) = 0$ ,  $x'(8.84514) = 0.28$ . This solution is approximately  $x(t) = -0.013 \cos t - 0.109 \sin t - 0.067 \sin 4t$  and is positive on  $(8.84514, 9.42478)$  with amplitude 0.042.

In the second case, the differential equations are  $x'' + 64x = \sin 4t$  when  $x \geq 0$  and  $x'' + 4x = \sin 4t$  when  $x < 0$ . Since the initial velocity is positive we solve first for  $x \geq 0$ . [The following computations are done with the aid of a CAS having a differential equation solver and graphing capability.] The solution of  $x'' + 64x = \sin 4t$ ,  $x(0) = 0$ ,  $x'(0) = 1$  is

$$x(t) = \frac{1}{48} \left( \sin 4t + \frac{11}{2} \sin 8t \right), \quad 0 \leq t \leq r_1,$$

where  $r_1 = 0.415458$  is found using the root-finding capability of the CAS. The next initial-value problem is  $x'' + 4x = \sin 4t$ ,  $x(r_1) = 0$ ,  $x'(r_1) = -0.909091$ . The solution is

$$x(t) = 0.403 \cos 2t - 0.255 \sin 2t - 0.083 \sin 4t, \quad r_1 \leq t \leq r_2,$$

where  $r_2 = 2.1403$ . The next initial-value problem is  $x'' + 64x = \sin 4t$ ,  $x(r_2) = 0$ ,  $x'(r_2) = 1.16206$ . The solution is

$$x(t) = 0.153 \cos 8t + 0.021 \sin 4t - 0.008 \sin 8t, \quad r_2 \leq t \leq r_3,$$

where  $r_3 = 2.53479$ . The next initial-value problem is  $x'' + 4x = \sin 4t$ ,  $x(r_3) = 0$ ,  $x'(r_3) = -1.28086$ . The solution is

$$x(t) = -0.737 \cos 2t - 0.217 \sin 2t - 0.083 \sin 4t, \quad r_3 \leq t \leq r_4,$$

where  $r_4 = 4.0453$ .

In the third case, the differential equations are  $x'' + 36x = \sin 4t$  when  $x \geq 0$  and  $x'' + 25x = \sin 4t$  when  $x < 0$ . Since the initial velocity is positive, we solve first for  $x \geq 0$ . The solution of  $x'' + 36x = \sin 4t$ ,  $x(0) = 0$ ,  $x'(0) = 1$  is

$$x(t) = \frac{1}{20} \sin 4t + \frac{2}{15} \sin 6t, \quad 0 \leq t \leq r_1,$$

## Chapter 5 Related Exercises

where  $r_1 = 0.571447$ . Subsequent solutions are

$$x(t) = 0.115 \cos 5t + 0.111 \sin 4t + 0.093 \sin 5t, \quad r_1 \leq t \leq r_2 = 1.24203$$

$$x(t) = -0.068 \cos 6t + 0.05 \sin 4t + 0.082 \sin 6t, \quad r_2 \leq t \leq r_3 = 1.73555$$

$$x(t) = 0.159 \cos 5t + 0.111 \sin 4t + 0.072 \sin 6t, \quad r_3 \leq t \leq r_4 = 2.21355.$$

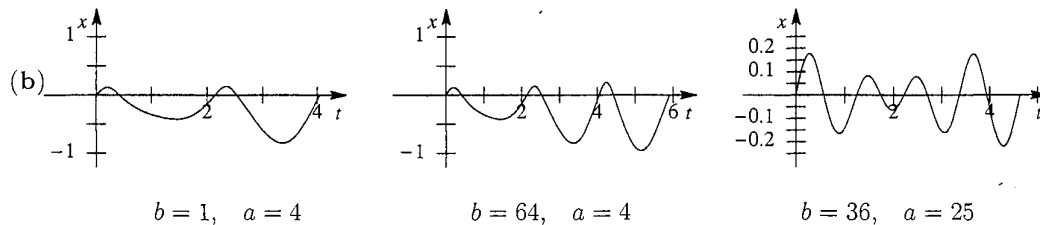

In each case it appears that  $x(t)$  has increasing amplitude as  $t$  increases.

(c) When  $\alpha = 0.5$  the following graphs are obtained.

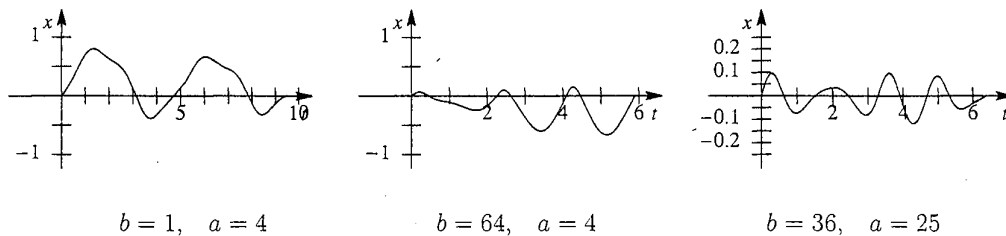

When  $\alpha = 3$  the following graphs are obtained.

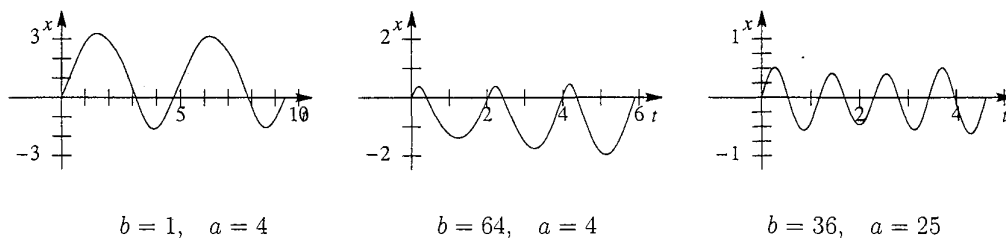

In both situations, it appears that the amplitude decreases for  $b = 1$  and  $a = 4$ , but increases in the other two cases.

Chapter 5 Related Exercises

4. (a) The solutions are obtained numerically in CAS and plotted below in part (b). Since  $x'(0) = 1 > 0$ , in each case the first differential equation used is  $x'' + \beta x' + 4x = \sin 4t$ , followed by  $x'' + \beta x' + x = \sin 4t$ , and alternating thereafter.

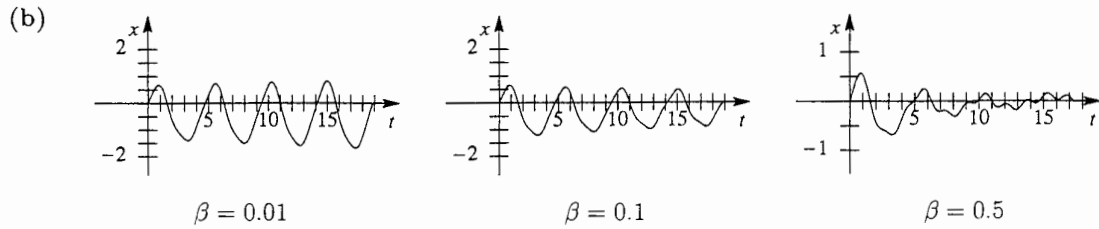

As  $t$  increases, the amplitude appears to increase for  $\beta = 0.01$  and decrease for  $\beta = 0.1$  and  $\beta = 0.5$ .

# 6 Series Solutions of Linear Equations

## Exercises 6.1

$$1. \lim_{n \rightarrow \infty} \left| \frac{a_{n+1}}{a_n} \right| = \lim_{n \rightarrow \infty} \left| \frac{2^{n+1}x^{n+1}/(n+1)}{2^n x^n/n} \right| = \lim_{n \rightarrow \infty} \frac{2n}{n+1} |x| = 2|x|$$

The series is absolutely convergent for  $2|x| < 1$  or  $|x| < 1/2$ . At  $x = -1/2$ , the series  $\sum_{n=1}^{\infty} \frac{(-1)^n}{n}$  converges by the alternating series test. At  $x = 1/2$ , the series  $\sum_{n=1}^{\infty} \frac{1}{n}$  is the harmonic series which diverges. Thus, the given series converges on  $[-1/2, 1/2)$ .

$$2. \lim_{n \rightarrow \infty} \left| \frac{a_{n+1}}{a_n} \right| = \lim_{n \rightarrow \infty} \left| \frac{100^{n+1}(x+7)^{n+1}/(n+1)!}{100^n(x+7)^n/n!} \right| = \lim_{n \rightarrow \infty} \frac{100}{n+1} |x+7| = 0$$

The series is absolutely convergent on  $(-\infty, \infty)$ .

$$3. \lim_{k \rightarrow \infty} \left| \frac{a_{k+1}}{a_k} \right| = \lim_{k \rightarrow \infty} \left| \frac{(x-5)^{k+1}/10^{k+1}}{(x-5)^k/10^k} \right| = \lim_{k \rightarrow \infty} \frac{1}{10} |x-5| = \frac{1}{10} |x-5|$$

The series is absolutely convergent for  $\frac{1}{10}|x-5| < 1$ ,  $|x-5| < 10$ , or on  $(-5, 15)$ . At  $x = -5$ , the series  $\sum_{k=1}^{\infty} \frac{(-1)^k(-10)^k}{10^k} = \sum_{k=1}^{\infty} 1$  diverges by the  $k$ -th term test. At  $x = 15$ , the series  $\sum_{k=1}^{\infty} \frac{(-1)^k 10^k}{10^k} = \sum_{k=1}^{\infty} (-1)^k$  diverges by the  $k$ -th term test. Thus, the series converges on  $(-5, 15)$ .

$$4. \lim_{k \rightarrow \infty} \left| \frac{a_{k+1}}{a_k} \right| = \lim_{k \rightarrow \infty} \left| \frac{(k+1)!(x-1)^{k+1}}{k!(x-1)^k} \right| = \lim_{k \rightarrow \infty} (k+1)|x-1| = \infty, \quad x \neq 1$$

The radius of convergence is 0 and the series converges only for  $x = 1$ .

$$5. \sin x \cos x = \left( x - \frac{x^3}{6} + \frac{x^5}{120} - \frac{x^7}{5040} + \dots \right) \left( 1 - \frac{x^2}{2} + \frac{x^4}{24} - \frac{x^6}{720} + \dots \right) = x - \frac{2x^3}{3} + \frac{2x^5}{15} - \frac{4x^7}{315} + \dots$$

$$6. e^{-x} \cos x = \left( 1 - x + \frac{x^2}{2} - \frac{x^3}{6} + \frac{x^4}{24} - \dots \right) \left( 1 - \frac{x^2}{2} + \frac{x^4}{24} - \dots \right) = 1 - x + \frac{x^3}{3} - \frac{x^4}{6} + \dots$$

$$7. \frac{1}{\cos x} = \frac{1}{1 - \frac{x^2}{2} + \frac{x^4}{4!} - \frac{x^6}{6!} + \dots} = 1 + \frac{x^2}{2} + \frac{5x^4}{4!} + \frac{61x^6}{6!} + \dots$$



Since  $\cos(\pi/2) = \cos(-\pi/2) = 0$ , the series converges on  $(-\pi/2, \pi/2)$ .

$$8. \frac{1-x}{2+x} = \frac{1}{2} - \frac{3}{4}x + \frac{3}{8}x^2 - \frac{3}{16}x^3 + \dots$$

Since the function is undefined at  $x = -2$ , the series converges on  $(-2, 2)$ .

$$\begin{aligned} 9. \sum_{n=1}^{\infty} 2nc_nx^{n-1} + \sum_{n=0}^{\infty} 6c_nx^{n+1} &= 2 \cdot 1 \cdot c_1x^0 + \underbrace{\sum_{n=2}^{\infty} 2nc_nx^{n-1}}_{k=n-1} + \underbrace{\sum_{n=0}^{\infty} 6c_nx^{n+1}}_{k=n+1} \\ &= 2c_1 + \sum_{k=1}^{\infty} 2(k+1)c_{k+1}x^k + \sum_{k=1}^{\infty} 6c_{k-1}x^k \\ &= 2c_1 + \sum_{k=1}^{\infty} [2(k+1)c_{k+1} + 6c_{k-1}]x^k \end{aligned}$$

$$\begin{aligned} 10. \sum_{n=2}^{\infty} n(n-1)c_nx^n + 2 \sum_{n=2}^{\infty} n(n-1)c_nx^{n-2} + 3 \sum_{n=1}^{\infty} nc_nx^n \\ &= 2 \cdot 2 \cdot 1c_2x^0 + 2 \cdot 3 \cdot 2c_3x^1 + 3 \cdot 1 \cdot c_1x^1 + \underbrace{\sum_{n=2}^{\infty} n(n-1)c_nx^n}_{k=n} + 2 \underbrace{\sum_{n=4}^{\infty} n(n-1)c_nx^{n-2}}_{k=n-2} + 3 \underbrace{\sum_{n=2}^{\infty} nc_nx^n}_{k=n} \\ &= 4c_2 + (12c_3 + (12c_3 + 3c_1)x + \sum_{n=2}^{\infty} k(k-1)c_kx^k + 2 \sum_{n=2}^{\infty} (k+2)(k+1)c_{k+2}x^k + 3 \sum_{n=2}^{\infty} kc_kx^k \\ &= 4c_2 + (3c_1 + 12c_3)x + \sum_{n=2}^{\infty} ([k(k-1) + 3k]c_k + 2(k+2)(k+1)c_{k+2})x^k \\ &= 4c_2 + (3c_1 + 12c_3)x + \sum_{n=2}^{\infty} [k(k+2)c_k + 2(k+1)(k+2)c_{k+2}]x^k \end{aligned}$$

$$11. y' = \sum_{n=1}^{\infty} (-1)^{n+1}x^{n-1}, \quad y'' = \sum_{n=2}^{\infty} (-1)^{n+1}(n-1)x^{n-2}$$

$$\begin{aligned} (x+1)y'' + y' &= (x+1) \sum_{n=2}^{\infty} (-1)^{n+1}(n-1)x^{n-2} + \sum_{n=1}^{\infty} (-1)^{n+1}x^{n-1} \\ &= \sum_{n=2}^{\infty} (-1)^{n+1}(n-1)x^{n-1} + \sum_{n=2}^{\infty} (-1)^{n+1}(n-1)x^{n-2} + \sum_{n=1}^{\infty} (-1)^{n+1}x^{n-1} \\ &= -x^0 + x^0 + \underbrace{\sum_{n=2}^{\infty} (-1)^{n+1}(n-1)x^{n-1}}_{k=n-1} + \underbrace{\sum_{n=3}^{\infty} (-1)^{n+1}(n-1)x^{n-2}}_{k=n-2} + \underbrace{\sum_{n=2}^{\infty} (-1)^{n+1}x^{n-1}}_{k=n-1} \end{aligned}$$

Exercises 6.1

$$\begin{aligned}
 &= \sum_{k=1}^{\infty} (-1)^{k+2} k x^k + \sum_{k=1}^{\infty} (-1)^{k+3} (k+1) x^k + \sum_{k=1}^{\infty} (-1)^{k+2} x^k \\
 &= \sum_{k=1}^{\infty} [(-1)^{k+2} k - (-1)^{k+2} k - (-1)^{k+2} + (-1)^{k+2}] x^k = 0
 \end{aligned}$$

12.  $y' = \sum_{n=1}^{\infty} \frac{(-1)^n 2n}{2^{2n} (n!)^2} x^{2n-1}$ ,  $y'' = \sum_{n=1}^{\infty} \frac{(-1)^n 2n(2n-1)}{2^{2n} (n!)^2} x^{2n-2}$

$$\begin{aligned}
 xy'' + y' + xy &= \underbrace{\sum_{n=1}^{\infty} \frac{(-1)^n 2n(2n-1)}{2^{2n} (n!)^2} x^{2n-1}}_{k=n} + \underbrace{\sum_{n=1}^{\infty} \frac{(-1)^n 2n}{2^{2n} (n!)^2} x^{2n-1}}_{k=n} + \underbrace{\sum_{n=0}^{\infty} \frac{(-1)^n}{2^{2n} (n!)^2} x^{2n+1}}_{k=n+1} \\
 &= \sum_{k=1}^{\infty} \left[ \frac{(-1)^k 2k(2k-1)}{2^{2k} (k!)^2} + \frac{(-1)^k 2k}{2^{2k} (k!)^2} + \frac{(-1)^{k-1}}{2^{2k-2} [(k-1)!]^2} \right] x^{2k-1} \\
 &= \sum_{k=1}^{\infty} \left[ \frac{(-1)^k (2k)^2}{2^{2k} (k!)^2} - \frac{(-1)^k}{2^{2k-2} [(k-1)!]^2} \right] x^{2k-1} \\
 &= \sum_{k=1}^{\infty} (-1)^k \left[ \frac{(2k)^2 - 2^2 k^2}{2^{2k} (k!)^2} \right] x^{2k-1} = 0
 \end{aligned}$$

13. Substituting  $y = \sum_{n=0}^{\infty} c_n x^n$  into the differential equation we have

$$\begin{aligned}
 y'' - xy &= \underbrace{\sum_{n=2}^{\infty} n(n-1)c_n x^{n-2}}_{k=n-2} - \underbrace{\sum_{n=0}^{\infty} c_n x^{n+1}}_{k=n+1} = \sum_{k=0}^{\infty} (k+2)(k+1)c_{k+2} x^k - \sum_{k=1}^{\infty} c_{k-1} x^k \\
 &= 2c_2 + \sum_{k=1}^{\infty} [(k+2)(k+1)c_{k+2} - c_{k-1}] x^k = 0.
 \end{aligned}$$

Thus

$$c_2 = 0$$

$$(k+2)(k+1)c_{k+2} - c_{k-1} = 0$$

and

$$c_{k+2} = \frac{1}{(k+2)(k+1)} c_{k-1}, \quad k = 1, 2, 3, \dots$$

Choosing  $c_0 = 1$  and  $c_1 = 0$  we find

$$c_3 = \frac{1}{6}$$

$$c_4 = c_5 = 0$$

$$c_6 = \frac{1}{180}$$

and so on. For  $c_0 = 0$  and  $c_1 = 1$  we obtain

$$\begin{aligned}c_3 &= 0 \\c_4 &= \frac{1}{12} \\c_5 &= c_6 = 0 \\c_7 &= \frac{1}{504}\end{aligned}$$

and so on. Thus, two solutions are

$$y_1 = 1 + \frac{1}{6}x^3 + \frac{1}{180}x^6 + \dots \quad \text{and} \quad y_2 = x + \frac{1}{12}x^4 + \frac{1}{504}x^7 + \dots$$

14. Substituting  $y = \sum_{n=0}^{\infty} c_n x^n$  into the differential equation we have

$$\begin{aligned}y'' + x^2 y &= \sum_{n=2}^{\infty} \underbrace{n(n-1)c_n x^{n-2}}_{k=n-2} + \sum_{n=0}^{\infty} \underbrace{c_n x^{n+2}}_{k=n+2} = \sum_{k=0}^{\infty} (k+2)(k+1)c_{k+2} x^k + \sum_{k=2}^{\infty} c_{k-2} x^k \\&= 2c_2 + 6c_3 x + \sum_{k=2}^{\infty} [(k+2)(k+1)c_{k+2} + c_{k-2}] x^k = 0.\end{aligned}$$

Thus

$$c_2 = c_3 = 0$$

$$(k+2)(k+1)c_{k+2} + c_{k-2} = 0$$

and

$$c_{k+2} = -\frac{1}{(k+2)(k+1)} c_{k-2}, \quad k = 2, 3, 4, \dots$$

Choosing  $c_0 = 1$  and  $c_1 = 0$  we find

$$\begin{aligned}c_4 &= -\frac{1}{12} \\c_5 &= c_6 = c_7 = 0 \\c_8 &= \frac{1}{672}\end{aligned}$$

and so on. For  $c_0 = 0$  and  $c_1 = 1$  we obtain

$$\begin{aligned}c_4 &= 0 \\c_5 &= -\frac{1}{20} \\c_6 &= c_7 = c_8 = 0 \\c_9 &= \frac{1}{1440}\end{aligned}$$

### Exercises 6.1

and so on. Thus, two solutions are

$$y_1 = 1 - \frac{1}{12}x^4 + \frac{1}{672}x^8 - \dots \quad \text{and} \quad y_2 = x - \frac{1}{20}x^5 + \frac{1}{1440}x^9 - \dots$$

15. Substituting  $y = \sum_{n=0}^{\infty} c_n x^n$  into the differential equation we have

$$\begin{aligned} y'' - 2xy' + y &= \sum_{n=2}^{\infty} \underbrace{n(n-1)c_n x^{n-2}}_{k=n-2} - 2 \sum_{n=1}^{\infty} \underbrace{nc_n x^n}_{k=n} + \sum_{n=0}^{\infty} \underbrace{c_n x^n}_{k=n} \\ &= \sum_{k=0}^{\infty} (k+2)(k+1)c_{k+2}x^k - 2 \sum_{k=1}^{\infty} kc_k x^k + \sum_{k=0}^{\infty} c_k x^k \\ &= 2c_2 + c_0 + \sum_{k=1}^{\infty} [(k+2)(k+1)c_{k+2} - (2k-1)c_k]x^k = 0. \end{aligned}$$

Thus

$$2c_2 + c_0 = 0$$

$$(k+2)(k+1)c_{k+2} - (2k-1)c_k = 0$$

and

$$c_2 = -\frac{1}{2}c_0$$

$$c_{k+2} = \frac{2k-1}{(k+2)(k+1)} c_k, \quad k = 1, 2, 3, \dots$$

Choosing  $c_0 = 1$  and  $c_1 = 0$  we find

$$c_2 = -\frac{1}{2}$$

$$c_3 = c_5 = c_7 = \dots = 0$$

$$c_4 = -\frac{1}{8}$$

$$c_6 = -\frac{7}{336}$$

and so on. For  $c_0 = 0$  and  $c_1 = 1$  we obtain

$$c_2 = c_4 = c_6 = \dots = 0$$

$$c_3 = \frac{1}{6}$$

$$c_5 = \frac{1}{24}$$

$$c_7 = \frac{1}{112}$$

and so on. Thus, two solutions are

$$y_1 = 1 - \frac{1}{2}x^2 - \frac{1}{8}x^4 - \frac{7}{336}x^6 - \dots \quad \text{and} \quad y_2 = x + \frac{1}{6}x^3 + \frac{1}{24}x^5 + \frac{1}{112}x^7 + \dots$$

16. Substituting  $y = \sum_{n=0}^{\infty} c_n x^n$  into the differential equation we have

$$\begin{aligned} y'' - xy' + 2y &= \underbrace{\sum_{n=2}^{\infty} n(n-1)c_n x^{n-2}}_{k=n-2} - \underbrace{\sum_{n=1}^{\infty} n c_n x^n}_{k=n} + 2 \underbrace{\sum_{n=0}^{\infty} c_n x^n}_{k=n} \\ &= \sum_{k=0}^{\infty} (k+2)(k+1)c_{k+2} x^k - \sum_{k=1}^{\infty} k c_k x^k + 2 \sum_{k=0}^{\infty} c_k x^k \\ &= 2c_2 + 2c_0 + \sum_{k=1}^{\infty} [(k+2)(k+1)c_{k+2} - (k-2)c_k] x^k = 0. \end{aligned}$$

Thus

$$2c_2 + 2c_0 = 0$$

$$(k+2)(k+1)c_{k+2} - (k-2)c_k = 0$$

and

$$c_2 = -c_0$$

$$c_{k+2} = \frac{k-2}{(k+2)(k+1)} c_k, \quad k = 1, 2, 3, \dots$$

Choosing  $c_0 = 1$  and  $c_1 = 0$  we find

$$c_2 = -1$$

$$c_3 = c_5 = c_7 = \dots = 0$$

$$c_4 = 0$$

$$c_6 = c_8 = c_{10} = \dots = 0.$$

For  $c_0 = 0$  and  $c_1 = 1$  we obtain

$$c_2 = c_4 = c_6 = \dots = 0$$

$$c_3 = -\frac{1}{6}$$

$$c_5 = -\frac{1}{120}$$

and so on. Thus, two solutions are

$$y_1 = 1 - x^2 \quad \text{and} \quad y_2 = x - \frac{1}{6}x^3 - \frac{1}{120}x^5 - \dots$$

### Exercises 6.1

17. Substituting  $y = \sum_{n=0}^{\infty} c_n x^n$  into the differential equation we have

$$\begin{aligned} y'' + x^2 y' + xy &= \underbrace{\sum_{n=2}^{\infty} n(n-1)c_n x^{n-2}}_{k=n-2} + \underbrace{\sum_{n=1}^{\infty} n c_n x^{n+1}}_{k=n+1} + \underbrace{\sum_{n=0}^{\infty} c_n x^{n+1}}_{k=n+1} \\ &= \sum_{k=0}^{\infty} (k+2)(k+1)c_{k+2} x^k + \sum_{k=2}^{\infty} (k-1)c_{k-1} x^k + \sum_{k=1}^{\infty} c_{k-1} x^k \\ &= 2c_2 + (6c_3 + c_0)x + \sum_{k=2}^{\infty} [(k+2)(k+1)c_{k+2} + k c_{k-1}] x^k = 0. \end{aligned}$$

Thus

$$\begin{aligned} c_2 &= 0, 6c_3 + c_0 = 0 \\ (k+2)(k+1)c_{k+2} + k c_{k-1} &= 0 \end{aligned}$$

and

$$\begin{aligned} c_3 &= -\frac{1}{6}c_0 \\ c_{k+2} &= -\frac{k}{(k+2)(k+1)} c_{k-1}, \quad k = 2, 3, 4, \dots \end{aligned}$$

Choosing  $c_0 = 1$  and  $c_1 = 0$  we find

$$\begin{aligned} c_3 &= -\frac{1}{6} \\ c_4 &= c_5 = 0 \\ c_6 &= \frac{1}{45} \end{aligned}$$

and so on. For  $c_0 = 0$  and  $c_1 = 1$  we obtain

$$\begin{aligned} c_3 &= 0 \\ c_4 &= -\frac{1}{6} \\ c_5 &= c_6 = 0 \\ c_7 &= \frac{5}{252} \end{aligned}$$

and so on. Thus, two solutions are

$$y_1 = 1 - \frac{1}{6}x^3 + \frac{1}{45}x^6 - \dots \quad \text{and} \quad y_2 = x - \frac{1}{6}x^4 + \frac{5}{232}x^7 - \dots$$

18. Substituting  $y = \sum_{n=0}^{\infty} c_n x^n$  into the differential equation we have

$$\begin{aligned} y'' + 2xy' + 2y &= \sum_{n=2}^{\infty} \underbrace{n(n-1)c_n x^{n-2}}_{k=n-2} + 2 \sum_{n=1}^{\infty} \underbrace{nc_n x^n}_{k=n} + 2 \sum_{n=0}^{\infty} \underbrace{c_n x^n}_{k=n} \\ &= \sum_{k=0}^{\infty} (k+2)(k+1)c_{k+2} x^k + 2 \sum_{k=1}^{\infty} kc_k x^k + 2 \sum_{k=0}^{\infty} c_k x^k \\ &= 2c_2 + 2c_0 + \sum_{k=1}^{\infty} [(k+2)(k+1)c_{k+2} + 2(k+1)c_k] x^k = 0. \end{aligned}$$

Thus

$$2c_2 + 2c_0 = 0$$

$$(k+2)(k+1)c_{k+2} + 2(k+1)c_k = 0$$

and

$$c_2 = -c_0$$

$$c_{k+2} = -\frac{2}{k+2} c_k, \quad k = 1, 2, 3, \dots$$

Choosing  $c_0 = 1$  and  $c_1 = 0$  we find

$$c_2 = -1$$

$$c_3 = c_5 = c_7 = \dots = 0$$

$$c_4 = \frac{1}{2}$$

$$c_6 = -\frac{1}{6}$$

and so on. For  $c_0 = 0$  and  $c_1 = 1$  we obtain

$$c_2 = c_4 = c_6 = \dots = 0$$

$$c_3 = -\frac{2}{3}$$

$$c_5 = \frac{4}{15}$$

$$c_7 = -\frac{8}{105}$$

and so on. Thus, two solutions are

$$y_1 = 1 - x^2 + \frac{1}{2}x^4 - \frac{1}{6}x^6 + \dots \quad \text{and} \quad y_2 = x - \frac{2}{3}x^3 + \frac{4}{15}x^5 - \frac{8}{105}x^7 + \dots$$

### Exercises 6.1

19. Substituting  $y = \sum_{n=0}^{\infty} c_n x^n$  into the differential equation we have

$$\begin{aligned} (x-1)y'' + y' &= \underbrace{\sum_{n=2}^{\infty} n(n-1)c_n x^{n-1}}_{k=n-1} - \underbrace{\sum_{n=2}^{\infty} n(n-1)c_n x^{n-2}}_{k=n-2} + \underbrace{\sum_{n=1}^{\infty} n c_n x^{n-1}}_{k=n-1} \\ &= \sum_{k=1}^{\infty} (k+1)k c_{k+1} x^k - \sum_{k=0}^{\infty} (k+2)(k+1)c_{k+2} x^k + \sum_{k=0}^{\infty} (k+1)c_{k+1} x^k \\ &= -2c_2 + c_1 + \sum_{k=1}^{\infty} [(k+1)k c_{k+1} - (k+2)(k+1)c_{k+2} + (k+1)c_{k+1}] x^k = 0. \end{aligned}$$

Thus

$$-2c_2 + c_1 = 0$$

$$(k+1)^2 c_{k+1} - (k+2)(k+1)c_{k+2} = 0$$

and

$$c_2 = \frac{1}{2}c_1$$

$$c_{k+2} = \frac{k+1}{k+2} c_{k+1}, \quad k = 1, 2, 3, \dots$$

Choosing  $c_0 = 1$  and  $c_1 = 0$  we find  $c_2 = c_3 = c_4 = \dots = 0$ . For  $c_0 = 0$  and  $c_1 = 1$  we obtain

$$c_2 = \frac{1}{2}, \quad c_3 = \frac{1}{3}, \quad c_4 = \frac{1}{4},$$

and so on. Thus, two solutions are

$$y_1 = 1 \quad \text{and} \quad y_2 = x + \frac{1}{2}x^2 + \frac{1}{3}x^3 + \frac{1}{4}x^4 + \dots$$

20. Substituting  $y = \sum_{n=0}^{\infty} c_n x^n$  into the differential equation we have

$$\begin{aligned} (x+2)y'' + xy' - y &= \underbrace{\sum_{n=2}^{\infty} n(n-1)c_n x^{n-1}}_{k=n-1} + \underbrace{\sum_{n=2}^{\infty} 2n(n-1)c_n x^{n-2}}_{k=n-2} + \underbrace{\sum_{n=1}^{\infty} n c_n x^n}_{k=n} - \underbrace{\sum_{n=0}^{\infty} c_n x^n}_{k=n} \\ &= \sum_{k=1}^{\infty} (k+1)k c_{k+1} x^k + \sum_{k=0}^{\infty} 2(k+2)(k+1)c_{k+2} x^k + \sum_{k=1}^{\infty} k c_k x^k - \sum_{k=0}^{\infty} c_k x^k \\ &= 4c_2 - c_0 + \sum_{k=1}^{\infty} [(k+1)k c_{k+1} + 2(k+2)(k+1)c_{k+2} + (k-1)c_k] x^k = 0. \end{aligned}$$

Thus

$$4c_2 - c_0 = 0$$

$$(k+1)k c_{k+1} + 2(k+2)(k+1)c_{k+2} + (k-1)c_k = 0, \quad k = 1, 2, 3, \dots$$



and

$$c_2 = \frac{1}{4}c_0$$

$$c_{k+2} = -\frac{(k+1)kc_{k+1} + (k-1)c_k}{2(k+2)(k+1)}, \quad k = 1, 2, 3, \dots$$

Choosing  $c_0 = 1$  and  $c_1 = 0$  we find

$$c_1 = 0, \quad c_2 = \frac{1}{4}, \quad c_3 = -\frac{1}{24}, \quad c_4 = 0, \quad c_5 = \frac{1}{480}$$

and so on. For  $c_0 = 0$  and  $c_1 = 1$  we obtain

$$c_2 = 0$$

$$c_3 = 0$$

$$c_4 = c_5 = c_6 = \dots = 0.$$

Thus, two solutions are

$$y_1 = c_0 \left[ 1 + \frac{1}{4}x^2 - \frac{1}{24}x^3 + \frac{1}{480}x^5 + \dots \right] \quad \text{and} \quad y_2 = c_1 x.$$

21. Substituting  $y = \sum_{n=0}^{\infty} c_n x^n$  into the differential equation we have

$$y'' - (x+1)y' - y = \sum_{n=2}^{\infty} \underbrace{n(n-1)c_n x^{n-2}}_{k=n-2} - \sum_{n=1}^{\infty} \underbrace{nc_n x^n}_{k=n} - \sum_{n=1}^{\infty} \underbrace{nc_n x^{n-1}}_{k=n-1} - \sum_{n=0}^{\infty} \underbrace{c_n x^n}_{k=n}$$

$$= \sum_{k=0}^{\infty} (k+2)(k+1)c_{k+2}x^k - \sum_{k=1}^{\infty} kc_k x^k - \sum_{k=0}^{\infty} (k+1)c_{k+1}x^k - \sum_{k=0}^{\infty} c_k x^k$$

$$= 2c_2 - c_1 - c_0 + \sum_{k=1}^{\infty} [(k+2)(k+1)c_{k+2} - (k+1)c_{k+1} - (k+1)c_k]x^k = 0.$$

Thus

$$2c_2 - c_1 - c_0 = 0$$

$$(k+2)(k+1)c_{k+2} - (k-1)(c_{k+1} + c_k) = 0$$

and

$$c_2 = \frac{c_1 + c_0}{2}$$

$$c_{k+2} = \frac{c_{k+1} + c_k}{k+2} c_k, \quad k = 2, 3, 4, \dots$$

Choosing  $c_0 = 1$  and  $c_1 = 0$  we find

$$c_2 = \frac{1}{2}, \quad c_3 = \frac{1}{6}, \quad c_4 = \frac{1}{6}$$

### Exercises 6.1

and so on. For  $c_0 = 0$  and  $c_1 = 1$  we obtain

$$c_2 = \frac{1}{2}, \quad c_3 = \frac{1}{2}, \quad c_4 = \frac{1}{4}$$

and so on. Thus, two solutions are

$$y_1 = 1 + \frac{1}{2}x^2 + \frac{1}{6}x^3 + \frac{1}{6}x^4 + \cdots \quad \text{and} \quad y_2 = x + \frac{1}{2}x^2 + \frac{1}{2}x^3 + \frac{1}{4}x^4 + \cdots$$

22. Substituting  $y = \sum_{n=0}^{\infty} c_n x^n$  into the differential equation we have

$$\begin{aligned} (x^2 + 1)y'' - 6y &= \underbrace{\sum_{n=2}^{\infty} n(n-1)c_n x^n}_{k=n} + \underbrace{\sum_{n=2}^{\infty} n(n-1)c_n x^{n-2}}_{k=n-2} - 6 \underbrace{\sum_{n=0}^{\infty} c_n x^n}_{k=n} \\ &= \sum_{k=2}^{\infty} k(k-1)c_k x^k + \sum_{k=0}^{\infty} (k+2)(k+1)c_{k+2} x^k - 6 \sum_{k=0}^{\infty} c_k x^k \\ &= 2c_2 - 6c_0 + (6c_3 - 6c_1)x + \sum_{k=2}^{\infty} [(k^2 - k - 6)c_k + (k+2)(k+1)c_{k+2}] x^k = 0. \end{aligned}$$

Thus

$$2c_2 - 6c_0 = 0$$

$$6c_3 - 6c_1 = 0$$

$$(k-3)(k+2)c_k + (k+2)(k+1)c_{k+2} = 0$$

and

$$c_2 = 3c_0$$

$$c_3 = c_1$$

$$c_{k+2} = -\frac{k-3}{k+1}c_k, \quad k = 2, 3, 4, \dots$$

Choosing  $c_0 = 1$  and  $c_1 = 0$  we find

$$c_2 = 3$$

$$c_3 = c_5 = c_7 = \cdots = 0$$

$$c_4 = 1$$

$$c_6 = -\frac{1}{5}$$

and so on. For  $c_0 = 0$  and  $c_1 = 1$  we obtain

$$c_2 = c_4 = c_6 = \cdots = 0$$

$$c_3 = 1$$

$$c_5 = c_7 = c_9 = \cdots = 0.$$

Thus, two solutions are

$$y_1 = 1 + 3x^2 + x^4 - \frac{1}{5}x^6 + \cdots \quad \text{and} \quad y_2 = x + x^3.$$

23. Substituting  $y = \sum_{n=0}^{\infty} c_n x^n$  into the differential equation we have

$$\begin{aligned} (x^2 + 2)y'' + 3xy' - y &= \sum_{n=2}^{\infty} \underbrace{n(n-1)c_n}_{k=n} x^n + 2 \sum_{n=2}^{\infty} \underbrace{n(n-1)c_n}_{k=n-2} x^{n-2} + 3 \sum_{n=1}^{\infty} \underbrace{nc_n}_{k=n} x^n - \sum_{n=0}^{\infty} \underbrace{c_n}_{k=n} x^n \\ &= \sum_{k=2}^{\infty} k(k-1)c_k x^k + 2 \sum_{k=0}^{\infty} (k+2)(k+1)c_{k+2} x^k + 3 \sum_{k=1}^{\infty} kc_k x^k - \sum_{k=0}^{\infty} c_k x^k \\ &= (4c_2 - c_0) + (12c_3 + 2c_1)x + \sum_{k=2}^{\infty} [2(k+2)(k+1)c_{k+2} + (k^2 + 2k - 1)c_k] x^k = 0. \end{aligned}$$

Thus

$$4c_2 - c_0 = 0$$

$$12c_3 + 2c_1 = 0$$

$$2(k+2)(k+1)c_{k+2} + (k^2 + 2k - 1)c_k = 0$$

and

$$c_2 = \frac{1}{4}c_0$$

$$c_3 = -\frac{1}{6}c_1$$

$$c_{k+2} = -\frac{k^2 + 2k - 1}{2(k+2)(k+1)} c_k, \quad k = 2, 3, 4, \dots$$

Choosing  $c_0 = 1$  and  $c_1 = 0$  we find

$$c_2 = \frac{1}{4}$$

$$c_3 = c_5 = c_7 = \cdots = 0$$

$$c_4 = -\frac{7}{96}$$

### Exercises 6.1

and so on. For  $c_0 = 0$  and  $c_1 = 1$  we obtain

$$\begin{aligned}c_2 &= c_4 = c_6 = \cdots = 0 \\c_3 &= -\frac{1}{6} \\c_5 &= \frac{7}{120}\end{aligned}$$

and so on. Thus, two solutions are

$$y_1 = 1 + \frac{1}{4}x^2 - \frac{7}{96}x^4 + \cdots \quad \text{and} \quad y_2 = x - \frac{1}{6}x^3 + \frac{7}{120}x^5 - \cdots$$

24. Substituting  $y = \sum_{n=0}^{\infty} c_n x^n$  into the differential equation we have

$$\begin{aligned}(x^2 - 1)y'' + xy' - y &= \underbrace{\sum_{n=2}^{\infty} n(n-1)c_n x^n}_{k=n} - \underbrace{\sum_{n=2}^{\infty} n(n-1)c_n x^{n-2}}_{k=n-2} + \underbrace{\sum_{n=1}^{\infty} n c_n x^n}_{k=n} - \underbrace{\sum_{n=0}^{\infty} c_n x^n}_{k=n} \\&= \sum_{k=2}^{\infty} k(k-1)c_k x^k - \sum_{k=0}^{\infty} (k+2)(k+1)c_{k+2} x^k + \sum_{k=1}^{\infty} k c_k x^k - \sum_{k=0}^{\infty} c_k x^k \\&= (-2c_2 - c_0) - 6c_3 x + \sum_{k=2}^{\infty} [-(k+2)(k+1)c_{k+2} + (k^2 - 1)c_k] x^k = 0.\end{aligned}$$

Thus

$$\begin{aligned}-2c_2 - c_0 &= 0 \\-6c_3 &= 0 \\-(k+2)(k+1)c_{k+2} + (k-1)(k+1)c_k &= 0\end{aligned}$$

and

$$\begin{aligned}c_2 &= -\frac{1}{2}c_0 \\c_3 &= 0 \\c_{k+2} &= \frac{k-1}{k+2}c_k, \quad k = 2, 3, 4, \dots\end{aligned}$$

Choosing  $c_0 = 1$  and  $c_1 = 0$  we find

$$\begin{aligned}c_2 &= -\frac{1}{2} \\c_3 &= c_5 = c_7 = \cdots = 0 \\c_4 &= -\frac{1}{8}\end{aligned}$$

and so on. For  $c_0 = 0$  and  $c_1 = 1$  we obtain

$$c_2 = c_4 = c_6 = \cdots = 0$$

$$c_3 = c_5 = c_7 = \cdots = 0.$$

Thus, two solutions are

$$y_1 = 1 - \frac{1}{2}x^2 - \frac{1}{8}x^4 - \cdots \quad \text{and} \quad y_2 = x.$$

25. Substituting  $y = \sum_{n=0}^{\infty} c_n x^n$  into the differential equation we have

$$\begin{aligned} (x-1)y'' - xy' + y &= \underbrace{\sum_{n=2}^{\infty} n(n-1)c_n x^{n-1}}_{k=n-1} - \underbrace{\sum_{n=2}^{\infty} n(n-1)c_n x^{n-2}}_{k=n-2} - \underbrace{\sum_{n=1}^{\infty} n c_n x^n}_{k=n} + \underbrace{\sum_{n=0}^{\infty} c_n x^n}_{k=n} \\ &= \sum_{k=1}^{\infty} (k+1)k c_{k+1} x^k - \sum_{k=0}^{\infty} (k+2)(k+1)c_{k+2} x^k - \sum_{k=1}^{\infty} k c_k x^k + \sum_{k=0}^{\infty} c_k x^k \\ &= -2c_2 + c_0 + \sum_{k=1}^{\infty} [-(k+2)(k+1)c_{k+2} + (k+1)k c_{k+1} - (k-1)c_k] x^k = 0. \end{aligned}$$

Thus

$$-2c_2 + c_0 = 0$$

$$-(k+2)(k+1)c_{k+2} + (k+1)k c_{k+1} - (k-1)c_k = 0$$

and

$$c_2 = \frac{1}{2}c_0$$

$$c_{k+2} = \frac{k c_{k+1}}{k+2} - \frac{(k-1)c_k}{(k+2)(k+1)}, \quad k = 1, 2, 3, \dots$$

Choosing  $c_0 = 1$  and  $c_1 = 0$  we find

$$c_2 = \frac{1}{2}, \quad c_3 = \frac{1}{6}, \quad c_4 = 0$$

and so on. For  $c_0 = 0$  and  $c_1 = 1$  we obtain  $c_2 = c_3 = c_4 = \cdots = 0$ . Thus,

$$y = C_1 \left( 1 + \frac{1}{2}x^2 + \frac{1}{6}x^3 + \cdots \right) + C_2 x$$

and

$$y' = C_1 \left( x + \frac{1}{2}x^2 + \cdots \right) + C_2.$$

The initial conditions imply  $C_1 = -2$  and  $C_2 = 6$ , so

$$y = -2 \left( 1 + \frac{1}{2}x^2 + \frac{1}{6}x^3 + \cdots \right) + 6x = 8x - 2e^x.$$

### Exercises 6.1

26. Substituting  $y = \sum_{n=0}^{\infty} c_n x^n$  into the differential equation we have

$$\begin{aligned}
 & (x+1)y'' - (2-x)y' + y \\
 &= \sum_{n=2}^{\infty} \underbrace{n(n-1)c_n x^{n-1}}_{k=n-1} + \sum_{n=2}^{\infty} \underbrace{n(n-1)c_n x^{n-2}}_{k=n-2} - 2 \sum_{n=1}^{\infty} \underbrace{nc_n x^{n-1}}_{k=n-1} + \sum_{n=1}^{\infty} \underbrace{nc_n x^n}_{k=n} + \sum_{n=0}^{\infty} \underbrace{c_n x^n}_{k=n} \\
 &= \sum_{k=1}^{\infty} (k+1)kc_{k+1}x^k + \sum_{k=0}^{\infty} (k+2)(k+1)c_{k+2}x^k - 2 \sum_{k=0}^{\infty} (k+1)c_{k+1}x^k + \sum_{k=1}^{\infty} kc_k x^k + \sum_{k=0}^{\infty} c_k x^k \\
 &= 2c_2 - 2c_1 + c_0 + \sum_{k=1}^{\infty} [(k+2)(k+1)c_{k+2} - (k+1)c_{k+1} + (k+1)c_k]x^k = 0.
 \end{aligned}$$

Thus

$$2c_2 - 2c_1 + c_0 = 0$$

$$(k+2)(k+1)c_{k+2} - (k+1)c_{k+1} + (k+1)c_k = 0$$

and

$$c_2 = c_1 - \frac{1}{2}c_0$$

$$c_{k+2} = \frac{1}{k+2}c_{k+1} - \frac{1}{k+2}c_k, \quad k = 1, 2, 3, \dots$$

Choosing  $c_0 = 1$  and  $c_1 = 0$  we find

$$c_2 = -\frac{1}{2}, \quad c_3 = -\frac{1}{6}, \quad c_4 = \frac{1}{12}$$

and so on. For  $c_0 = 0$  and  $c_1 = 1$  we obtain

$$c_2 = 1, \quad c_3 = 0, \quad c_4 = -\frac{1}{4}$$

and so on. Thus,

$$y = C_1 \left( 1 - \frac{1}{2}x^2 - \frac{1}{6}x^3 + \frac{1}{12}x^4 + \dots \right) + C_2 \left( x + x^2 - \frac{1}{4}x^4 + \dots \right)$$

and

$$y' = C_1 \left( -x - \frac{1}{2}x^2 + \frac{1}{3}x^3 + \dots \right) + C_2 (1 + 2x - x^3 + \dots).$$

The initial conditions imply  $C_1 = 2$  and  $C_2 = -1$ , so

$$\begin{aligned}
 y &= 2 \left( 1 - \frac{1}{2}x^2 - \frac{1}{6}x^3 + \frac{1}{12}x^4 + \dots \right) - \left( x + x^2 - \frac{1}{4}x^4 + \dots \right) \\
 &= 2 - x - 2x^2 - \frac{1}{3}x^3 + \frac{5}{12}x^4 + \dots
 \end{aligned}$$

27. Substituting  $y = \sum_{n=0}^{\infty} c_n x^n$  into the differential equation we have

$$\begin{aligned} y'' - 2xy' + 8y &= \sum_{n=2}^{\infty} \underbrace{n(n-1)c_n x^{n-2}}_{k=n-2} - 2 \sum_{n=1}^{\infty} \underbrace{nc_n x^n}_{k=n} + 8 \sum_{n=0}^{\infty} \underbrace{c_n x^n}_{k=n} \\ &= \sum_{k=0}^{\infty} (k+2)(k+1)c_{k+2} x^k - 2 \sum_{k=1}^{\infty} kc_k x^k + 8 \sum_{k=0}^{\infty} c_k x^k \\ &= 2c_2 + 8c_0 + \sum_{k=1}^{\infty} [(k+2)(k+1)c_{k+2} + (8-2k)c_k] x^k = 0. \end{aligned}$$

Thus

$$2c_2 + 8c_0 = 0$$

$$(k+2)(k+1)c_{k+2} + (8-2k)c_k = 0$$

and

$$c_2 = -4c_0$$

$$c_{k+2} = \frac{2k-8}{(k+2)(k+1)} c_k, \quad k = 1, 2, 3, \dots$$

Choosing  $c_0 = 1$  and  $c_1 = 0$  we find

$$c_2 = -4$$

$$c_3 = c_5 = c_7 = \dots = 0$$

$$c_4 = \frac{4}{3}$$

$$c_6 = c_8 = c_{10} = \dots = 0.$$

For  $c_0 = 0$  and  $c_1 = 1$  we obtain

$$c_2 = c_4 = c_6 = \dots = 0$$

$$c_3 = -1$$

$$c_5 = \frac{1}{10}$$

and so on. Thus,

$$y = C_1 \left( 1 - 4x^2 + \frac{4}{3}x^4 \right) + C_2 \left( x - x^3 + \frac{1}{10}x^5 + \dots \right)$$

and

$$y' = C_1 \left( -8x + \frac{16}{3}x^3 \right) + C_2 \left( 1 - 3x^2 + \frac{1}{2}x^4 + \dots \right).$$

### Exercises 6.1

The initial conditions imply  $C_1 = 3$  and  $C_2 = 0$ , so

$$y = 3 \left( 1 - 4x^2 + \frac{4}{3}x^4 \right) = 3 - 12x^2 + 4x^4.$$

28. Substituting  $y = \sum_{n=0}^{\infty} c_n x^n$  into the differential equation we have

$$\begin{aligned} (x^2 + 1)y'' + 2xy' &= \underbrace{\sum_{n=2}^{\infty} n(n-1)c_n x^n}_{k=n} + \underbrace{\sum_{n=2}^{\infty} n(n-1)c_n x^{n-2}}_{k=n-2} + \underbrace{\sum_{n=1}^{\infty} 2nc_n x^n}_{k=n} \\ &= \sum_{k=2}^{\infty} k(k-1)c_k x^k + \sum_{k=0}^{\infty} (k+2)(k+1)c_{k+2} x^k + \sum_{k=1}^{\infty} 2kc_k x^k \\ &= 2c_2 + (6c_3 + 2c_1)x + \sum_{k=2}^{\infty} [k(k+1)c_k + (k+2)(k+1)c_{k+2}]x^k = 0. \end{aligned}$$

Thus

$$2c_2 = 0$$

$$6c_3 + 2c_1 = 0$$

$$k(k+1)c_k + (k+2)(k+1)c_{k+2} = 0$$

and

$$c_2 = 0$$

$$c_3 = -\frac{1}{3}c_1$$

$$c_{k+2} = -\frac{k}{k+2}c_k, \quad k = 2, 3, 4, \dots$$

Choosing  $c_0 = 1$  and  $c_1 = 0$  we find  $c_3 = c_4 = c_5 = \dots = 0$ . For  $c_0 = 0$  and  $c_1 = 1$  we obtain

$$c_3 = -\frac{1}{3}$$

$$c_4 = c_6 = c_8 = \dots = 0$$

$$c_5 = -\frac{1}{5}$$

$$c_7 = \frac{1}{7}$$

and so on. Thus

$$y = c_0 + c_1 \left( x - \frac{1}{3}x^3 + \frac{1}{5}x^5 - \frac{1}{7}x^7 + \dots \right)$$

and

$$y' = c_1 (1 - x^2 + x^4 - x^6 + \dots).$$



The initial conditions imply  $c_0 = 0$  and  $c_1 = 1$ , so

$$y = x - \frac{1}{3}x^3 + \frac{1}{5}x^5 - \frac{1}{7}x^7 + \dots$$

29. Substituting  $y = \sum_{n=0}^{\infty} c_n x^n$  into the differential equation we have

$$\begin{aligned} y'' + (\sin x)y &= \sum_{n=2}^{\infty} n(n-1)c_n x^{n-2} + \left(x - \frac{1}{6}x^3 + \frac{1}{120}x^5 - \dots\right)(c_0 + c_1x + c_2x^2 + \dots) \\ &= [2c_2 + 6c_3x + 12c_4x^2 + 20c_5x^3 + \dots] + [c_0x + c_1x^2 + (c_2 - \frac{1}{6}c_0)x^3 + \dots] \\ &= 2c_2 + (6c_3 + c_0)x + (12c_4 + c_1)x^2 + \left(20c_5 + c_2 - \frac{1}{6}c_0\right)x^3 + \dots = 0. \end{aligned}$$

Thus

$$\begin{aligned} 2c_2 &= 0 \\ 6c_3 + c_0 &= 0 \\ 12c_4 + c_1 &= 0 \\ 20c_5 + c_2 - \frac{1}{6}c_0 &= 0 \end{aligned}$$

and

$$\begin{aligned} c_2 &= 0 \\ c_3 &= -\frac{1}{6}c_0 \\ c_4 &= -\frac{1}{12}c_1 \\ c_5 &= -\frac{1}{20}c_2 + \frac{1}{120}c_0. \end{aligned}$$

Choosing  $c_0 = 1$  and  $c_1 = 0$  we find

$$c_2 = 0, \quad c_3 = -\frac{1}{6}, \quad c_4 = 0, \quad c_5 = \frac{1}{120}$$

and so on. For  $c_0 = 0$  and  $c_1 = 1$  we obtain

$$c_2 = 0, \quad c_3 = 0, \quad c_4 = -\frac{1}{12}, \quad c_5 = 0$$

and so on. Thus, two solutions are

$$y_1 = 1 - \frac{1}{6}x^3 + \frac{1}{120}x^5 + \dots \quad \text{and} \quad y_2 = x - \frac{1}{12}x^4 + \dots$$

### Exercises 6.1

30. Substituting  $y = \sum_{n=0}^{\infty} c_n x^n$  into the differential equation we have

$$\begin{aligned} y'' + e^x y' - y &= \sum_{n=2}^{\infty} n(n-1)c_n x^{n-2} \\ &\quad + \left(1 + x + \frac{1}{2}x^2 + \frac{1}{6}x^3 + \dots\right) (c_1 + 2c_2x + 3c_3x^2 + 4c_4x^3 + \dots) - \sum_{n=0}^{\infty} c_n x^n \\ &= [2c_2 + 6c_3x + 12c_4x^2 + 20c_5x^3 + \dots] \\ &\quad + \left[c_1 + (2c_2 + c_1)x + \left(3c_3 + 2c_2 + \frac{1}{2}c_1\right)x^2 + \dots\right] - [c_0 + c_1x + c_2x^2 + \dots] \\ &= (2c_2 + c_1 - c_0) + (6c_3 + 2c_2)x + \left(12c_4 + 3c_3 + c_2 + \frac{1}{2}c_1\right)x^2 + \dots = 0. \end{aligned}$$

Thus

$$\begin{aligned} 2c_2 + c_1 - c_0 &= 0 \\ 6c_3 + 2c_2 &= 0 \\ 12c_4 + 3c_3 + c_2 + \frac{1}{2}c_1 &= 0 \end{aligned}$$

and

$$\begin{aligned} c_2 &= \frac{1}{2}c_0 - \frac{1}{2}c_1 \\ c_3 &= -\frac{1}{3}c_2 \\ c_4 &= -\frac{1}{4}c_3 + \frac{1}{12}c_2 - \frac{1}{24}c_1. \end{aligned}$$

Choosing  $c_0 = 1$  and  $c_1 = 0$  we find

$$c_2 = \frac{1}{2}, \quad c_3 = -\frac{1}{6}, \quad c_4 = 0$$

and so on. For  $c_0 = 0$  and  $c_1 = 1$  we obtain

$$c_2 = -\frac{1}{2}, \quad c_3 = \frac{1}{6}, \quad c_4 = -\frac{1}{24}$$

and so on. Thus, two solutions are

$$y_1 = 1 + \frac{1}{2}x^2 - \frac{1}{6}x^3 + \dots \quad \text{and} \quad y_2 = x - \frac{1}{2}x^2 + \frac{1}{6}x^3 - \frac{1}{24}x^4 + \dots$$

31. Substituting  $y = \sum_{n=0}^{\infty} c_n x^n$  into the first differential equation leads to

$$\begin{aligned} y'' - xy &= \underbrace{\sum_{n=2}^{\infty} n(n-1)c_n x^{n-2}}_{k=n-2} - \underbrace{\sum_{n=0}^{\infty} c_n x^{n+1}}_{k=n+1} = \sum_{k=0}^{\infty} (k+2)(k+1)c_{k+2}x^k - \sum_{k=1}^{\infty} c_{k-1}x^k \\ &= 2c_2 + \sum_{k=1}^{\infty} [(k+2)(k+1)c_{k+2} - c_{k-1}]x^k = 1. \end{aligned}$$

Thus

$$2c_2 = 1$$

$$(k+2)(k+1)c_{k+2} - c_{k-1} = 0$$

and

$$c_2 = \frac{1}{2}$$

$$c_{k+2} = \frac{c_{k-1}}{(k+2)(k+1)}, \quad k = 1, 2, 3, \dots$$

Let  $c_0$  and  $c_1$  be arbitrary and iterate to find

$$c_2 = \frac{1}{2}$$

$$c_3 = \frac{1}{6}c_0$$

$$c_4 = \frac{1}{12}c_1$$

$$c_5 = \frac{1}{20}c_2 = \frac{1}{40}$$

and so on. The solution is

$$\begin{aligned} y &= c_0 + c_1x + \frac{1}{2}x^2 + \frac{1}{6}c_0x^3 + \frac{1}{12}c_1x^4 + \frac{1}{40}c_5 + \dots \\ &= c_0 \left( 1 + \frac{1}{6}x^3 + \dots \right) + c_1 \left( x + \frac{1}{12}x^4 + \dots \right) + \frac{1}{2}x^2 + \frac{1}{40}x^5 + \dots \end{aligned}$$

Substituting  $y = \sum_{n=0}^{\infty} c_n x^n$  into the second differential equation leads to

$$y'' - 4xy' - 4y = \underbrace{\sum_{n=2}^{\infty} n(n-1)c_n x^{n-2}}_{k=n-2} - \underbrace{\sum_{n=1}^{\infty} 4nc_n x^n}_{k=n} - \underbrace{\sum_{n=0}^{\infty} 4c_n x^n}_{k=n}$$

### Exercises 6.1

$$\begin{aligned}
 &= \sum_{k=0}^{\infty} (k+2)(k+1)c_{k+2}x^k - \sum_{k=1}^{\infty} 4kc_kx^k - \sum_{k=0}^{\infty} 4c_kx^k \\
 &= 2c_2 - 4c_0 + \sum_{k=1}^{\infty} [(k+2)(k+1)c_{k+2} - 4(k+1)c_k]x^k \\
 &= e^x = 1 + \sum_{k=1}^{\infty} \frac{1}{k!}x^k.
 \end{aligned}$$

Thus

$$2c_2 - 4c_0 = 1$$

$$(k+2)(k+1)c_{k+2} - 4(k+1)c_k = \frac{1}{k!}$$

and

$$c_2 = \frac{1}{2} + 2c_0$$

$$c_{k+2} = \frac{1}{(k+2)!} + \frac{4}{k+2}c_k, \quad k = 1, 2, 3, \dots$$

Let  $c_0$  and  $c_1$  be arbitrary and iterate to find

$$c_2 = \frac{1}{2} + 2c_0$$

$$c_3 = \frac{1}{3!} + \frac{4}{3}c_1 = \frac{1}{3!} + \frac{4}{3}c_1$$

$$c_4 = \frac{1}{4!} + \frac{4}{4}c_2 = \frac{1}{4!} + \frac{1}{2} + 2c_0 = \frac{13}{4!} + 2c_0$$

$$c_5 = \frac{1}{5!} + \frac{4}{5}c_3 = \frac{1}{5!} + \frac{4}{5 \cdot 3!} + \frac{16}{15}c_1 = \frac{17}{5!} + \frac{16}{15}c_1$$

$$c_6 = \frac{1}{6!} + \frac{4}{6}c_4 = \frac{1}{6!} + \frac{4 \cdot 13}{6 \cdot 4!} + \frac{8}{6}c_0 = \frac{261}{6!} + \frac{4}{3}c_0$$

$$c_7 = \frac{1}{7!} + \frac{4}{7}c_5 = \frac{1}{7!} + \frac{4 \cdot 17}{7 \cdot 5!} + \frac{64}{105}c_1 = \frac{409}{7!} + \frac{64}{105}c_1$$

and so on. The solution is

$$\begin{aligned}
y &= c_0 + c_1x + \left(\frac{1}{2} + 2c_0\right)x^2 + \left(\frac{1}{3!} + \frac{4}{3}c_1\right)x^3 - \left(\frac{13}{4!} + 2c_0\right)x^4 + \left(\frac{17}{5!} + \frac{16}{15}c_1\right)x^5 \\
&\quad + \left(\frac{261}{6!} + \frac{4}{3}c_0\right)x^6 + \left(\frac{409}{7!} + \frac{64}{105}c_1\right)x^7 + \cdots \\
&= c_0 \left[1 + 2x^2 + 2x^4 + \frac{4}{3}x^6 + \cdots\right] + c_1 \left[x + \frac{4}{3}x^3 + \frac{16}{15}x^5 + \frac{64}{105}x^7 + \cdots\right] \\
&\quad + \frac{1}{2}x^2 + \frac{1}{3!}x^3 + \frac{13}{4!}x^4 + \frac{17}{5!}x^5 + \frac{261}{6!}x^6 + \frac{409}{7!}x^7 + \cdots
\end{aligned}$$

32. We identify  $P(x) = 0$  and  $Q(x) = \sin x/x$ . The Taylor series representation for  $\sin x/x$  is  $1 - x^2/3! + x^4/5! - \cdots$ , for  $|x| < \infty$ . Thus,  $Q(x)$  is analytic at  $x = 0$  and  $x = 0$  is an ordinary point of the differential equation.
33. The differential equation  $xy'' = 0$  has a singular point at  $x = 0$ . It also has two solutions,  $y_1 = 1$  and  $y_2 = x$ , that are analytic at  $x = 0$ .
34. If  $x > 0$  and  $y > 0$ , then  $y'' = -xy < 0$  and the graph of a solution curve is concave down. Thus, whatever portion of a solution curve lies in the first quadrant is concave down. When  $x > 0$  and  $y < 0$ ,  $y'' = -xy > 0$ , so whatever portion of a solution curve lies in the fourth quadrant is concave up.
35. (a) Substituting  $y = \sum_{n=0}^{\infty} c_n x^n$  into the differential equation we have

$$\begin{aligned}
y'' + xy' + y &= \underbrace{\sum_{n=2}^{\infty} n(n-1)c_n x^{n-2}}_{k=n-2} + \underbrace{\sum_{n=1}^{\infty} n c_n x^n}_{k=n} + \underbrace{\sum_{n=0}^{\infty} c_n x^n}_{k=n} \\
&= \sum_{k=0}^{\infty} (k+2)(k+1)c_{k+2} x^k + \sum_{k=1}^{\infty} k c_k x^k + \sum_{k=0}^{\infty} c_k x^k \\
&= (2c_2 + c_0) + \sum_{k=1}^{\infty} [(k+2)(k+1)c_{k+2} + (k+1)c_k] x^k = 0.
\end{aligned}$$

Thus

$$2c_2 + c_0 = 0$$

$$(k+2)(k+1)c_{k+2} + (k+1)c_k = 0$$

and

$$c_2 = -\frac{1}{2}c_0$$

$$c_{k+2} = -\frac{1}{k+2}c_k.$$

Choosing  $c_0 = 1$  and  $c_1 = 0$  we find

Exercises 6.1

$$c_2 = -\frac{1}{2}$$

$$c_3 = c_5 = c_7 = \dots = 0$$

$$c_4 = -\frac{1}{4}\left(-\frac{1}{2}\right) = \frac{1}{2^2 \cdot 2}$$

$$c_6 = -\frac{1}{6}\left(\frac{1}{2^2 \cdot 2}\right) = -\frac{1}{2^3 \cdot 3!}$$

and so on. For  $c_0 = 0$  and  $c_1 = 1$  we obtain

$$c_2 = c_4 = c_6 = \dots = 0$$

$$c_3 = -\frac{1}{3} = -\frac{2}{3!}$$

$$c_5 = -\frac{1}{5}\left(-\frac{1}{3}\right) = \frac{1}{5 \cdot 3} = \frac{4 \cdot 2}{5!}$$

$$c_7 = -\frac{1}{7}\left(\frac{4 \cdot 2}{5!}\right) = -\frac{6 \cdot 4 \cdot 2}{7!}$$

and so on. Thus, two solutions are

$$y_1 = \sum_{k=0}^{\infty} \frac{(-1)^k}{2^k \cdot k!} x^{2k} \quad \text{and} \quad y_2 = \sum_{k=0}^{\infty} \frac{(-1)^k 2^k k!}{(2k+1)!} x^{2k+1}.$$

(b) For  $y_1$ ,  $S_3 = S_2$  and  $S_5 = S_4$ , so we plot  $S_2, S_4, S_6, S_8$ , and  $S_{10}$ .

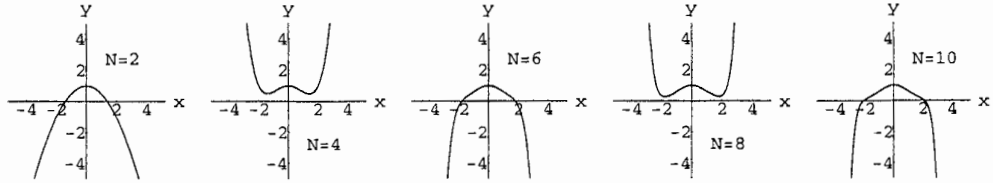

For  $y_2$ ,  $S_3 = S_4$  and  $S_5 = S_6$ , so we plot  $S_2, S_4, S_6, S_8$ , and  $S_{10}$ .

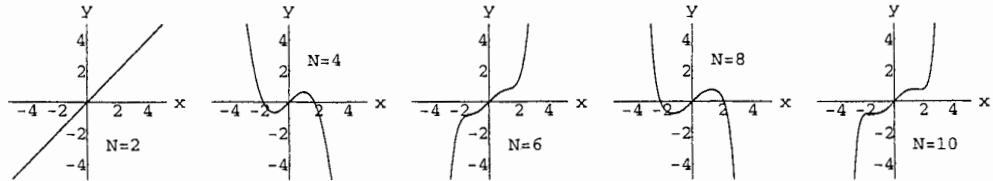

(c)

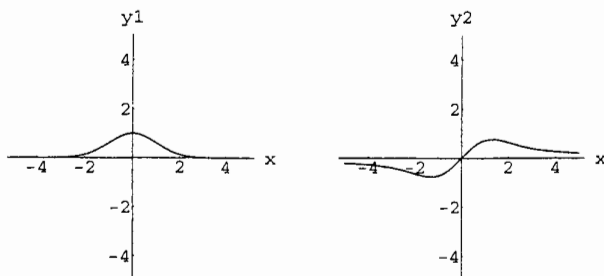

The graphs of  $y_1$  and  $y_2$  obtained from a numerical solver are shown. We see that the partial sum representations indicate the even and odd natures of the solution, but don't really give a very accurate representation of the true solution. Increasing  $N$  to about 20 gives a much more accurate representation on  $[-4, 4]$ .

(d) From  $e^x = \sum_{k=0}^{\infty} x^k/k!$  we see that  $e^{-x^2/2} = \sum_{k=0}^{\infty} (-x^2/2)^k/k! = \sum_{k=0}^{\infty} (-1)^k x^{2k}/2^k k!$ . From (5) of Section 4.2 we have

$$\begin{aligned}
 y_2 &= y_1 \int \frac{e^{-\int x dx}}{y_1^2} dx = e^{-x^2/2} \int \frac{e^{-x^2/2}}{(e^{-x^2/2})^2} dx = e^{-x^2/2} \int \frac{e^{-x^2/2}}{e^{-x^2}} dx = e^{-x^2/2} \int e^{x^2/2} dx \\
 &= \sum_{k=0}^{\infty} \frac{(-1)^k}{2^k k!} x^{2k} \int \sum_{k=0}^{\infty} \frac{1}{2^k k!} x^{2k} dx = \left( \sum_{k=0}^{\infty} \frac{(-1)^k}{2^k k!} x^{2k} \right) \left( \sum_{k=0}^{\infty} \int \frac{1}{2^k k!} x^{2k} dx \right) \\
 &= \left( \sum_{k=0}^{\infty} \frac{(-1)^k}{2^k k!} x^{2k} \right) \left( \sum_{k=0}^{\infty} \frac{1}{(2k+1)2^k k!} x^{2k+1} \right) \\
 &= \left( 1 - \frac{1}{2}x^2 + \frac{1}{2^2 \cdot 2}x^4 - \frac{1}{2^3 \cdot 3!}x^6 + \dots \right) \left( x + \frac{1}{3 \cdot 2}x^3 + \frac{1}{5 \cdot 2^2 \cdot 2}x^5 + \frac{1}{7 \cdot 2^3 \cdot 3!}x^7 + \dots \right) \\
 &= x - \frac{2}{3!}x^3 + \frac{4 \cdot 2}{5!}x^5 - \frac{6 \cdot 4 \cdot 2}{7!}x^7 + \dots = \sum_{k=0}^{\infty} \frac{(-1)^k 2^k k!}{(2k+1)!} x^{2k+1}.
 \end{aligned}$$

36. (a) We have

$$\begin{aligned}
 y'' + (\cos x)y &= 2c_2 + 6c_3x + 12c_4x^2 + 20c_5x^3 + 30c_6x^4 + 42c_7x^5 \\
 &\quad + \left( 1 - \frac{x^2}{2!} + \frac{x^4}{4!} - \frac{x^6}{6!} + \dots \right) (c_0 + c_1x + c_2x^2 + c_3x^3 + c_4x^4 + c_5x^5 + \dots) \\
 &= (2c_2 + c_0) + (6c_3 + c_1)x + \left( 12c_4 + c_2 - \frac{1}{2}c_0 \right)x^2 + \left( 20c_5 + c_3 - \frac{1}{2}c_1 \right)x^3 \\
 &\quad + \left( 30c_6 + c_4 + \frac{1}{24}c_0 - \frac{1}{2}c_2 \right)x^4 + \left( 42c_7 + c_5 + \frac{1}{24}c_1 - \frac{1}{2}c_3 \right)x^5 + \dots
 \end{aligned}$$

### Exercises 6.1

Then

$$30c_6 + c_4 + \frac{1}{24}c_0 - \frac{1}{2}c_2 = 0 \quad \text{and} \quad 42c_7 + c_5 + \frac{1}{24}c_1 - \frac{1}{2}c_3 = 0,$$

which gives  $c_6 = -c_0/80$  and  $c_7 = -19c_1/5040$ . Thus

$$y_1(x) = 1 - \frac{1}{2}x^2 + \frac{1}{12}x^4 - \frac{1}{80}x^6 + \dots$$

and

$$y_2(x) = x - \frac{1}{6}x^3 + \frac{1}{30}x^5 - \frac{19}{5040}x^7 + \dots$$

(b) From part (a) the general solution of the differential equation is  $y = c_1y_1 + c_2y_2$ . Then  $y(0) = c_1 + c_2 \cdot 0 = c_1$  and  $y'(0) = c_1 \cdot 0 + c_2 = c_2$ , so the solution of the initial-value problem is

$$y = y_1 + y_2 = 1 + x - \frac{1}{2}x^2 - \frac{1}{6}x^3 + \frac{1}{12}x^4 + \frac{1}{30}x^5 - \frac{1}{80}x^6 - \frac{19}{5040}x^7 + \dots$$

(c)

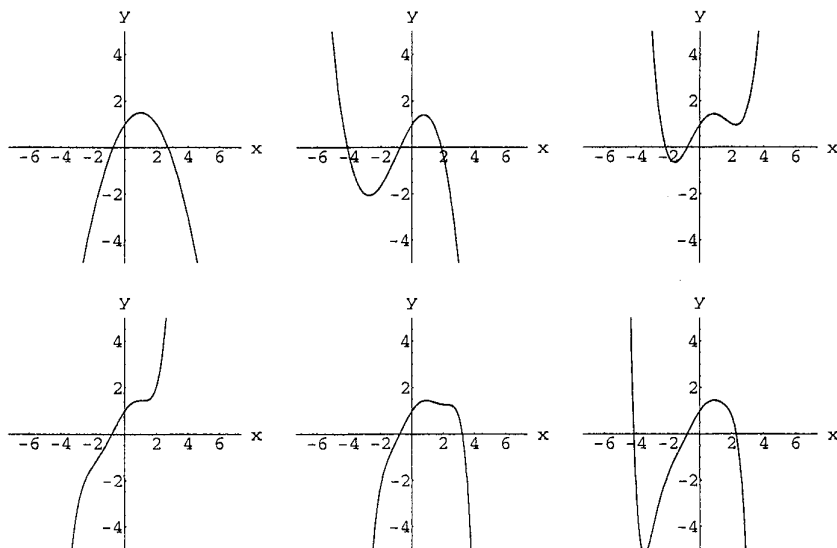

(d)

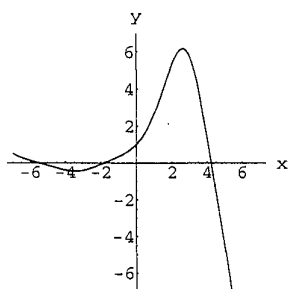



---

**Exercises 6.2**

---

1. Irregular singular point:  $x = 0$
2. Regular singular points:  $x = 0, -3$
3. Irregular singular point:  $x = 3$ ; regular singular point:  $x = -3$
4. Irregular singular point:  $x = 1$ ; regular singular point:  $x = 0$
5. Regular singular points:  $x = 0, \pm 2i$
6. Irregular singular point:  $x = 5$ ; regular singular point:  $x = 0$
7. Regular singular points:  $x = -3, 2$
8. Regular singular points:  $x = 0, \pm i$
9. Irregular singular point:  $x = 0$ ; regular singular points:  $x = 2, \pm 5$
10. Irregular singular point:  $x = -1$ ; regular singular points:  $x = 0, 3$
11. Writing the differential equation in the form

$$y'' + \frac{5}{x-1}y' + \frac{x}{x+1}y = 0$$

we see that  $x_0 = 1$  and  $x_0 = -1$  are regular singular points. For  $x_0 = 1$  the differential equation can be put in the form

$$(x-1)^2y'' + 5(x-1)y' + \frac{x(x-1)^2}{x+1}y = 0.$$

In this case  $p(x) = 5$  and  $q(x) = x(x-1)^2/(x+1)$ . For  $x_0 = -1$  the differential equation can be put in the form

$$(x+1)^2y'' + 5(x+1)\frac{x+1}{x-1}y' + x(x+1)y = 0.$$

In this case  $p(x) = (x+1)/(x-1)$  and  $q(x) = x(x+1)$ .

12. Writing the differential equation in the form

$$y'' + \frac{x+3}{x}y' + 7xy = 0$$

we see that  $x_0 = 0$  is a regular singular point. Multiplying by  $x^2$ , the differential equation can be put in the form

$$x^2y'' + x(x+3)y' + 7x^3y = 0.$$

We identify  $p(x) = x+3$  and  $q(x) = 7x^3$ .

13. We identify  $P(x) = 5/3x + 1$  and  $Q(x) = -1/3x^2$ , so that  $p(x) = xP(x) = \frac{5}{3} + x$  and  $q(x) = x^2Q(x) = -\frac{1}{3}$ . Then  $a_0 = \frac{5}{3}$ ,  $b_0 = -\frac{1}{3}$ , and the indicial equation is

$$r(r-1) + \frac{5}{3}r - \frac{1}{3} = r^2 + \frac{2}{3}r - \frac{1}{3} = \frac{1}{3}(3r^2 + 2r - 1) = \frac{1}{3}(3r-1)(r+1) = 0.$$

## Exercises 6.2

The indicial roots are  $\frac{1}{3}$  and  $-1$ . Since these do not differ by an integer we expect to find two series solutions using the method of Frobenius.

14. We identify  $P(x) = 1/x$  and  $Q(x) = 10/x$ , so that  $p(x) = xP(x) = 1$  and  $q(x) = x^2Q(x) = 10x$ . Then  $a_0 = 1$ ,  $b_0 = 0$ , and the indicial equation is

$$r(r-1) + r = r^2 = 0.$$

The indicial roots are 0 and 0. Since these are equal, we expect the method of Frobenius to yield a single series solution.

15. Substituting  $y = \sum_{n=0}^{\infty} c_n x^{n+r}$  into the differential equation and collecting terms, we obtain

$$2xy'' - y' + 2y = (2r^2 - 3r)c_0 x^{r-1} + \sum_{k=1}^{\infty} [2(k+r-1)(k+r)c_k - (k+r)c_k + 2c_{k-1}]x^{k+r-1} = 0,$$

which implies

$$2r^2 - 3r = r(2r - 3) = 0$$

and

$$(k+r)(2k+2r-3)c_k + 2c_{k-1} = 0.$$

The indicial roots are  $r = 0$  and  $r = 3/2$ . For  $r = 0$  the recurrence relation is

$$c_k = -\frac{2c_{k-1}}{k(2k-3)}, \quad k = 1, 2, 3, \dots,$$

and

$$c_1 = 2c_0, \quad c_2 = -2c_0, \quad c_3 = \frac{4}{9}c_0.$$

For  $r = 3/2$  the recurrence relation is

$$c_k = -\frac{2c_{k-1}}{(2k+3)k}, \quad k = 1, 2, 3, \dots,$$

and

$$c_1 = -\frac{2}{5}c_0, \quad c_2 = \frac{2}{35}c_0, \quad c_3 = -\frac{4}{945}c_0.$$

The general solution on  $(0, \infty)$  is

$$y = C_1 \left( 1 + 2x - 2x^2 + \frac{4}{9}x^3 + \dots \right) + C_2 x^{3/2} \left( 1 - \frac{2}{5}x + \frac{2}{35}x^2 - \frac{4}{945}x^3 + \dots \right).$$

16. Substituting  $y = \sum_{n=0}^{\infty} c_n x^{n+r}$  into the differential equation and collecting terms, we obtain

$$\begin{aligned} 2xy'' + 5y' + xy &= (2r^2 + 3r)c_0 x^{r-1} + (2r^2 + 7r + 5)c_1 x^r \\ &+ \sum_{k=2}^{\infty} [2(k+r)(k+r-1)c_k + 5(k+r)c_k + c_{k-2}]x^{k+r-1} \\ &= 0, \end{aligned}$$

which implies

$$2r^2 + 3r = r(2r + 3) = 0,$$

$$(2r^2 + 7r + 5) c_1 = 0,$$

and

$$(k + r)(2k + 2r + 3)c_k + c_{k-2} = 0.$$

The indicial roots are  $r = -3/2$  and  $r = 0$ , so  $c_1 = 0$ . For  $r = -3/2$  the recurrence relation is

$$c_k = -\frac{c_{k-2}}{(2k-3)k}, \quad k = 2, 3, 4, \dots,$$

and

$$c_2 = -\frac{1}{2}c_0, \quad c_3 = 0, \quad c_4 = \frac{1}{40}c_0.$$

For  $r = 0$  the recurrence relation is

$$c_k = -\frac{c_{k-2}}{k(2k+3)}, \quad k = 2, 3, 4, \dots,$$

and

$$c_2 = -\frac{1}{14}c_0, \quad c_3 = 0, \quad c_4 = \frac{1}{616}c_0.$$

The general solution on  $(0, \infty)$  is

$$y = C_1 x^{-3/2} \left( 1 - \frac{1}{2}x^2 + \frac{1}{40}x^4 + \dots \right) + C_2 \left( 1 - \frac{1}{14}x^2 + \frac{1}{616}x^4 + \dots \right).$$

17. Substituting  $y = \sum_{n=0}^{\infty} c_n x^{n+r}$  into the differential equation and collecting terms, we obtain

$$4xy'' + \frac{1}{2}y' + y = \left( 4r^2 - \frac{7}{2}r \right) c_0 x^{r-1} + \sum_{k=1}^{\infty} \left[ 4(k+r)(k+r-1)c_k + \frac{1}{2}(k+r)c_k + c_{k-1} \right] x^{k+r-1}$$

$$= 0,$$

which implies

$$4r^2 - \frac{7}{2}r = r \left( 4r - \frac{7}{2} \right) = 0$$

and

$$\frac{1}{2}(k+r)(8k+8r-7)c_k + c_{k-1} = 0.$$

The indicial roots are  $r = 0$  and  $r = 7/8$ . For  $r = 0$  the recurrence relation is

$$c_k = -\frac{2c_{k-1}}{k(8k-7)}, \quad k = 1, 2, 3, \dots,$$

and

$$c_1 = -2c_0, \quad c_2 = \frac{2}{9}c_0, \quad c_3 = -\frac{4}{459}c_0.$$

### Exercises 6.2

For  $r = 7/8$  the recurrence relation is

$$c_k = -\frac{2c_{k-1}}{(8k+7)k}, \quad k = 1, 2, 3, \dots,$$

and

$$c_1 = -\frac{2}{15}c_0, \quad c_2 = \frac{2}{345}c_0, \quad c_3 = -\frac{4}{32,085}c_0.$$

The general solution on  $(0, \infty)$  is

$$y = C_1 \left( 1 - 2x + \frac{2}{9}x^2 - \frac{4}{459}x^3 + \dots \right) + C_2 x^{7/8} \left( 1 - \frac{2}{15}x + \frac{2}{345}x^2 - \frac{4}{32,085}x^3 + \dots \right).$$

18. Substituting  $y = \sum_{n=0}^{\infty} c_n x^{n+r}$  into the differential equation and collecting terms, we obtain

$$\begin{aligned} 2x^2 y'' - xy' + (x^2 + 1)y &= (2r^2 - 3r + 1)c_0 x^r + (2r^2 + r)c_1 x^{r+1} \\ &+ \sum_{k=2}^{\infty} [2(k+r)(k+r-1)c_k - (k+r)c_k + c_k + c_{k-2}] x^{k+r} \\ &= 0, \end{aligned}$$

which implies

$$\begin{aligned} 2r^2 - 3r + 1 &= (2r - 1)(r - 1) = 0, \\ (2r^2 + r)c_1 &= 0, \end{aligned}$$

and

$$[(k+r)(2k+2r-3) + 1]c_k + c_{k-2} = 0.$$

The indicial roots are  $r = 1/2$  and  $r = 1$ , so  $c_1 = 0$ . For  $r = 1/2$  the recurrence relation is

$$c_k = -\frac{c_{k-2}}{k(2k-1)}, \quad k = 2, 3, 4, \dots,$$

and

$$c_2 = -\frac{1}{6}c_0, \quad c_3 = 0, \quad c_4 = \frac{1}{168}c_0.$$

For  $r = 1$  the recurrence relation is

$$c_k = -\frac{c_{k-2}}{k(2k+1)}, \quad k = 2, 3, 4, \dots,$$

and

$$c_2 = -\frac{1}{10}c_0, \quad c_3 = 0, \quad c_4 = \frac{1}{360}c_0.$$

The general solution on  $(0, \infty)$  is

$$y = C_1 x^{1/2} \left( 1 - \frac{1}{6}x^2 + \frac{1}{168}x^4 + \dots \right) + C_2 x \left( 1 - \frac{1}{10}x^2 + \frac{1}{360}x^4 + \dots \right).$$

Exercises 6.2

19. Substituting  $y = \sum_{n=0}^{\infty} c_n x^{n+r}$  into the differential equation and collecting terms, we obtain

$$\begin{aligned} 3xy'' + (2-x)y' - y &= (3r^2 - r)c_0 x^{r-1} \\ &+ \sum_{k=1}^{\infty} [3(k+r-1)(k+r)c_k + 2(k+r)c_k - (k+r)c_{k-1}] x^{k+r-1} \\ &= 0, \end{aligned}$$

which implies

$$3r^2 - r = r(3r - 1) = 0$$

and

$$(k+r)(3k+3r-1)c_k - (k+r)c_{k-1} = 0.$$

The indicial roots are  $r = 0$  and  $r = 1/3$ . For  $r = 0$  the recurrence relation is

$$c_k = \frac{c_{k-1}}{(3k-1)}, \quad k = 1, 2, 3, \dots,$$

and

$$c_1 = \frac{1}{2}c_0, \quad c_2 = \frac{1}{10}c_0, \quad c_3 = \frac{1}{80}c_0.$$

For  $r = 1/3$  the recurrence relation is

$$c_k = \frac{c_{k-1}}{3k}, \quad k = 1, 2, 3, \dots,$$

and

$$c_1 = \frac{1}{3}c_0, \quad c_2 = \frac{1}{18}c_0, \quad c_3 = \frac{1}{162}c_0.$$

The general solution on  $(0, \infty)$  is

$$y = C_1 \left( 1 + \frac{1}{2}x + \frac{1}{10}x^2 + \frac{1}{80}x^3 + \dots \right) + C_2 x^{1/3} \left( 1 + \frac{1}{3}x + \frac{1}{18}x^2 + \frac{1}{162}x^3 + \dots \right).$$

20. Substituting  $y = \sum_{n=0}^{\infty} c_n x^{n+r}$  into the differential equation and collecting terms, we obtain

$$\begin{aligned} x^2 y'' - \left(x - \frac{2}{9}\right)y &= \left(r^2 - r + \frac{2}{9}\right)c_0 x^r + \sum_{k=1}^{\infty} \left[ (k+r)(k+r-1)c_k + \frac{2}{9}c_k - c_{k-1} \right] x^{k+r} \\ &= 0, \end{aligned}$$

which implies

$$r^2 - r + \frac{2}{9} = \left(r - \frac{2}{3}\right)\left(r - \frac{1}{3}\right) = 0$$

and

$$\left[ (k+r)(k+r-1) + \frac{2}{9} \right] c_k - c_{k-1} = 0.$$

## Exercises 6.2

The indicial roots are  $r = 2/3$  and  $r = 1/3$ . For  $r = 2/3$  the recurrence relation is

$$c_k = \frac{3c_{k-1}}{3k^2 + k}, \quad k = 1, 2, 3, \dots,$$

and

$$c_1 = \frac{3}{4}c_0, \quad c_2 = \frac{9}{56}c_0, \quad c_3 = \frac{9}{560}c_0.$$

For  $r = 1/3$  the recurrence relation is

$$c_k = \frac{3c_{k-1}}{3k^2 - k}, \quad k = 1, 2, 3, \dots,$$

and

$$c_1 = \frac{3}{2}c_0, \quad c_2 = \frac{9}{20}c_0, \quad c_3 = \frac{9}{160}c_0.$$

The general solution on  $(0, \infty)$  is

$$y = C_1 x^{2/3} \left( 1 + \frac{3}{4}x + \frac{9}{56}x^2 + \frac{9}{560}x^3 + \dots \right) + C_2 x^{1/3} \left( 1 + \frac{3}{2}x + \frac{9}{20}x^2 + \frac{9}{160}x^3 + \dots \right).$$

21. Substituting  $y = \sum_{n=0}^{\infty} c_n x^{n+r}$  into the differential equation and collecting terms, we obtain

$$\begin{aligned} 2xy'' - (3+2x)y' + y &= (2r^2 - 5r)c_0 x^{r-1} + \sum_{k=1}^{\infty} [2(k+r)(k+r-1)c_k \\ &\quad - 3(k+r)c_k - 2(k+r-1)c_{k-1} + c_{k-1}] x^{k+r-1} \\ &= 0, \end{aligned}$$

which implies

$$2r^2 - 5r = r(2r - 5) = 0$$

and

$$(k+r)(2k+2r-5)c_k - (2k+2r-3)c_{k-1} = 0.$$

The indicial roots are  $r = 0$  and  $r = 5/2$ . For  $r = 0$  the recurrence relation is

$$c_k = \frac{(2k-3)c_{k-1}}{k(2k-5)}, \quad k = 1, 2, 3, \dots,$$

and

$$c_1 = \frac{1}{3}c_0, \quad c_2 = -\frac{1}{6}c_0, \quad c_3 = -\frac{1}{6}c_0.$$

For  $r = 5/2$  the recurrence relation is

$$c_k = \frac{2(k+1)c_{k-1}}{k(2k+5)}, \quad k = 1, 2, 3, \dots,$$

and

$$c_1 = \frac{4}{7}c_0, \quad c_2 = \frac{4}{21}c_0, \quad c_3 = \frac{32}{693}c_0.$$

The general solution on  $(0, \infty)$  is

$$y = C_1 \left( 1 + \frac{1}{3}x - \frac{1}{6}x^2 - \frac{1}{6}x^3 + \cdots \right) + C_2 x^{5/2} \left( 1 + \frac{4}{7}x + \frac{4}{21}x^2 + \frac{32}{693}x^3 + \cdots \right).$$

22. Substituting  $y = \sum_{n=0}^{\infty} c_n x^{n+r}$  into the differential equation and collecting terms, we obtain

$$\begin{aligned} x^2 y'' + x y' + \left( x^2 - \frac{4}{9} \right) y &= \left( r^2 - \frac{4}{9} \right) c_0 x^r + \left( r^2 + 2r + \frac{5}{9} \right) c_1 x^{r+1} \\ &+ \sum_{k=2}^{\infty} \left[ (k+r)(k+r-1)c_k + (k+r)c_k - \frac{4}{9}c_k + c_{k-2} \right] x^{k+r} \\ &= 0, \end{aligned}$$

which implies

$$\begin{aligned} r^2 - \frac{4}{9} &= \left( r + \frac{2}{3} \right) \left( r - \frac{2}{3} \right) = 0, \\ \left( r^2 + 2r + \frac{5}{9} \right) c_1 &= 0, \end{aligned}$$

and

$$\left[ (k+r)^2 - \frac{4}{9} \right] c_k + c_{k-2} = 0.$$

The indicial roots are  $r = -2/3$  and  $r = 2/3$ , so  $c_1 = 0$ . For  $r = -2/3$  the recurrence relation is

$$c_k = -\frac{9c_{k-2}}{3k(3k-4)}, \quad k = 2, 3, 4, \dots,$$

and

$$c_2 = -\frac{3}{4}c_0, \quad c_3 = 0, \quad c_4 = \frac{9}{128}c_0.$$

For  $r = 2/3$  the recurrence relation is

$$c_k = -\frac{9c_{k-2}}{3k(3k+4)}, \quad k = 2, 3, 4, \dots,$$

and

$$c_2 = -\frac{3}{20}c_0, \quad c_3 = 0, \quad c_4 = \frac{9}{1,280}c_0.$$

The general solution on  $(0, \infty)$  is

$$y = C_1 x^{-2/3} \left( 1 - \frac{3}{4}x^2 + \frac{9}{128}x^4 + \cdots \right) + C_2 x^{2/3} \left( 1 - \frac{3}{20}x^2 + \frac{9}{1,280}x^4 + \cdots \right).$$

### Exercises 6.2

23. Substituting  $y = \sum_{n=0}^{\infty} c_n x^{n+r}$  into the differential equation and collecting terms, we obtain

$$\begin{aligned} 9x^2 y'' + 9x^2 y' + 2y &= (9r^2 - 9r + 2) c_0 x^r \\ &+ \sum_{k=1}^{\infty} [9(k+r)(k+r-1)c_k + 2c_k + 9(k+r-1)c_{k-1}] x^{k+r} \\ &= 0, \end{aligned}$$

which implies

$$9r^2 - 9r + 2 = (3r - 1)(3r - 2) = 0$$

and

$$[9(k+r)(k+r-1) + 2]c_k + 9(k+r-1)c_{k-1} = 0.$$

The indicial roots are  $r = 1/3$  and  $r = 2/3$ . For  $r = 1/3$  the recurrence relation is

$$c_k = -\frac{(3k-2)c_{k-1}}{k(3k-1)}, \quad k = 1, 2, 3, \dots,$$

and

$$c_1 = -\frac{1}{2}c_0, \quad c_2 = \frac{1}{5}c_0, \quad c_3 = -\frac{7}{120}c_0.$$

For  $r = 2/3$  the recurrence relation is

$$c_k = -\frac{(3k-1)c_{k-1}}{k(3k+1)}, \quad k = 1, 2, 3, \dots,$$

and

$$c_1 = -\frac{1}{2}c_0, \quad c_2 = \frac{5}{28}c_0, \quad c_3 = -\frac{1}{21}c_0.$$

The general solution on  $(0, \infty)$  is

$$y = C_1 x^{1/3} \left( 1 - \frac{1}{2}x + \frac{1}{5}x^2 - \frac{7}{120}x^3 + \dots \right) + C_2 x^{2/3} \left( 1 - \frac{1}{2}x + \frac{5}{28}x^2 - \frac{1}{21}x^3 + \dots \right).$$

24. Substituting  $y = \sum_{n=0}^{\infty} c_n x^{n+r}$  into the differential equation and collecting terms, we obtain

$$\begin{aligned} 2x^2 y'' + 3xy' + (2x - 1)y &= (2r^2 + r - 1) c_0 x^r \\ &+ \sum_{k=1}^{\infty} [2(k+r)(k+r-1)c_k + 3(k+r)c_k - c_k + 2c_{k-1}] x^{k+r} \\ &= 0, \end{aligned}$$

which implies

$$2r^2 + r - 1 = (2r - 1)(r + 1) = 0$$

and

$$[(k+r)(2k+2r+1) - 1]c_k + 2c_{k-1} = 0.$$



The indicial roots are  $r = -1$  and  $r = 1/2$ . For  $r = -1$  the recurrence relation is

$$c_k = -\frac{2c_{k-1}}{k(2k-3)}, \quad k = 1, 2, 3, \dots,$$

and

$$c_1 = 2c_0, \quad c_2 = -2c_0, \quad c_3 = \frac{4}{9}c_0.$$

For  $r = 1/2$  the recurrence relation is

$$c_k = -\frac{2c_{k-1}}{k(2k+3)}, \quad k = 1, 2, 3, \dots,$$

and

$$c_1 = -\frac{2}{5}c_0, \quad c_2 = \frac{2}{35}c_0, \quad c_3 = -\frac{4}{945}c_0.$$

The general solution on  $(0, \infty)$  is

$$y = C_1 x^{-1} \left( 1 + 2x - 2x^2 + \frac{4}{9}x^3 + \dots \right) + C_2 x^{1/2} \left( 1 - \frac{2}{5}x + \frac{2}{35}x^2 - \frac{4}{945}x^3 + \dots \right).$$

25. Substituting  $y = \sum_{n=0}^{\infty} c_n x^{n+r}$  into the differential equation and collecting terms, we obtain

$$\begin{aligned} xy'' + 2y' - xy &= (r^2 + r)c_0 x^{r-1} + (r^2 + 3r + 2)c_1 x^r \\ &+ \sum_{k=2}^{\infty} [(k+r)(k+r-1)c_k + 2(k+r)c_k - c_{k-2}] x^{k+r-1} \\ &= 0, \end{aligned}$$

which implies

$$r^2 + r = r(r+1) = 0,$$

$$(r^2 + 3r + 2)c_1 = 0,$$

and

$$(k+r)(k+r+1)c_k - c_{k-2} = 0.$$

The indicial roots are  $r_1 = 0$  and  $r_2 = -1$ , so  $c_1 = 0$ . For  $r_1 = 0$  the recurrence relation is

$$c_k = \frac{c_{k-2}}{k(k+1)}, \quad k = 2, 3, 4, \dots,$$

and

$$c_2 = \frac{1}{3!}c_0$$

$$c_3 = c_5 = c_7 = \dots = 0$$

$$c_4 = \frac{1}{5!}c_0$$

$$c_{2n} = \frac{1}{(2n+1)!}c_0.$$

## Exercises 6.2

For  $r_2 = -1$  the recurrence relation is

$$c_k = \frac{c_{k-2}}{k(k-1)}, \quad k = 2, 3, 4, \dots,$$

and

$$c_2 = \frac{1}{2!}c_0$$

$$c_3 = c_5 = c_7 = \dots = 0$$

$$c_4 = \frac{1}{4!}c_0$$

$$c_{2n} = \frac{1}{(2n)!}c_0.$$

The general solution on  $(0, \infty)$  is

$$\begin{aligned} y &= C_1 \sum_{n=0}^{\infty} \frac{1}{(2n+1)!} x^{2n} + C_2 x^{-1} \sum_{n=0}^{\infty} \frac{1}{(2n)!} x^{2n} \\ &= \frac{1}{x} \left[ C_1 \sum_{n=0}^{\infty} \frac{1}{(2n+1)!} x^{2n+1} + C_2 \sum_{n=0}^{\infty} \frac{1}{(2n)!} x^{2n} \right] \\ &= \frac{1}{x} [C_1 \sinh x + C_2 \cosh x]. \end{aligned}$$

26. Substituting  $y = \sum_{n=0}^{\infty} c_n x^{n+r}$  into the differential equation and collecting terms, we obtain

$$\begin{aligned} x^2 y'' + xy' + \left(x^2 - \frac{1}{4}\right)y &= \left(r^2 - \frac{1}{4}\right)c_0 x^r + \left(r^2 + 2r + \frac{3}{4}\right)c_1 x^{r+1} \\ &\quad + \sum_{k=2}^{\infty} \left[ (k+r)(k+r-1)c_k + (k+r)c_k - \frac{1}{4}c_k + c_{k-2} \right] x^{k+r} \\ &= 0, \end{aligned}$$

which implies

$$r^2 - \frac{1}{4} = \left(r - \frac{1}{2}\right)\left(r + \frac{1}{2}\right) = 0,$$

$$\left(r^2 + 2r + \frac{3}{4}\right)c_1 = 0,$$

and

$$\left[ (k+r)^2 - \frac{1}{4} \right] c_k + c_{k-2} = 0.$$

The indicial roots are  $r_1 = 1/2$  and  $r_2 = -1/2$ , so  $c_1 = 0$ . For  $r_1 = 1/2$  the recurrence relation is

$$c_k = -\frac{c_{k-2}}{k(k+1)}, \quad k = 2, 3, 4, \dots,$$

and

$$\begin{aligned}c_2 &= -\frac{1}{3!}c_0 \\c_3 &= c_5 = c_7 = \cdots = 0 \\c_4 &= \frac{1}{5!}c_0 \\c_{2n} &= \frac{(-1)^n}{(2n+1)!}c_0.\end{aligned}$$

For  $r_2 = -1/2$  the recurrence relation is

$$c_k = -\frac{c_{k-2}}{k(k-1)}, \quad k = 2, 3, 4, \dots,$$

and

$$\begin{aligned}c_2 &= -\frac{1}{2!}c_0 \\c_3 &= c_5 = c_7 = \cdots = 0 \\c_4 &= \frac{1}{4!}c_0 \\c_{2n} &= \frac{(-1)^n}{(2n)!}c_0.\end{aligned}$$

The general solution on  $(0, \infty)$  is

$$\begin{aligned}y &= C_1 x^{1/2} \sum_{n=0}^{\infty} \frac{(-1)^n}{(2n+1)!} x^{2n} + C_2 x^{-1/2} \sum_{n=0}^{\infty} \frac{(-1)^n}{(2n)!} x^{2n} \\&= C_1 x^{-1/2} \sum_{n=0}^{\infty} \frac{(-1)^n}{(2n+1)!} x^{2n+1} + C_2 x^{-1/2} \sum_{n=0}^{\infty} \frac{(-1)^n}{(2n)!} x^{2n} \\&= x^{-1/2} [C_1 \sin x + C_2 \cos x].\end{aligned}$$

27. Substituting  $y = \sum_{n=0}^{\infty} c_n x^{n+r}$  into the differential equation and collecting terms, we obtain

$$xy'' - xy' + y = (r^2 - r)c_0 x^{r-1} + \sum_{k=0}^{\infty} [(k+r+1)(k+r)c_{k+1} - (k+r)c_k + c_k] x^{k+r} = 0$$

which implies

$$r^2 - r = r(r-1) = 0$$

and

$$(k+r+1)(k+r)c_{k+1} - (k+r-1)c_k = 0.$$

The indicial roots are  $r_1 = 1$  and  $r_2 = 0$ . For  $r_1 = 1$  the recurrence relation is

$$c_{k+1} = \frac{kc_k}{(k+2)(k+1)}, \quad k = 0, 1, 2, \dots,$$

## Exercises 6.2

and one solution is  $y_1 = c_0x$ . A second solution is

$$\begin{aligned} y_2 &= x \int \frac{e^{-\int -dx}}{x^2} dx = x \int \frac{e^x}{x^2} dx = x \int \frac{1}{x^2} \left( 1 + x + \frac{1}{2}x^2 + \frac{1}{3!}x^3 + \dots \right) dx \\ &= x \int \left( \frac{1}{x^2} + \frac{1}{x} + \frac{1}{2} + \frac{1}{3!}x + \frac{1}{4!}x^2 + \dots \right) dx = x \left[ -\frac{1}{x} + \ln x + \frac{1}{2}x + \frac{1}{12}x^2 + \frac{1}{72}x^3 + \dots \right] \\ &= x \ln x - 1 + \frac{1}{2}x^2 + \frac{1}{12}x^3 + \frac{1}{72}x^4 + \dots \end{aligned}$$

The general solution on  $(0, \infty)$  is

$$y = C_1x + C_2y_2(x).$$

28. Substituting  $y = \sum_{n=0}^{\infty} c_n x^{n+r}$  into the differential equation and collecting terms, we obtain

$$\begin{aligned} y'' + \frac{3}{x}y' - 2y &= (r^2 + 2r)c_0x^{r-2} + (r^2 + 4r + 3)c_1x^{r-1} \\ &\quad + \sum_{k=2}^{\infty} [(k+r)(k+r-1)c_k + 3(k+r)c_k - 2c_{k-2}]x^{k+r-2} \\ &= 0, \end{aligned}$$

which implies

$$\begin{aligned} r^2 + 2r &= r(r+2) = 0 \\ (r^2 + 4r + 3)c_1 &= 0 \\ (k+r)(k+r+2)c_k - 2c_{k-2} &= 0. \end{aligned}$$

The indicial roots are  $r_1 = 0$  and  $r_2 = -2$ , so  $c_1 = 0$ . For  $r_1 = 0$  the recurrence relation is

$$c_k = \frac{2c_{k-2}}{k(k+2)}, \quad k = 2, 3, 4, \dots,$$

and

$$\begin{aligned} c_2 &= \frac{1}{4}c_0 \\ c_3 &= c_5 = c_7 = \dots = 0 \\ c_4 &= \frac{1}{48}c_0 \\ c_6 &= \frac{1}{1,152}c_0. \end{aligned}$$

The result is

$$y_1 = c_0 \left( 1 + \frac{1}{4}x^2 + \frac{1}{48}x^4 + \frac{1}{1,152}c_6 + \dots \right).$$

A second solution is

$$\begin{aligned}
 y_2 &= y_1 \int \frac{e^{-\int(3/x)dx}}{y_1^2} dx = y_1 \int \frac{dx}{x^3 \left(1 + \frac{1}{4}x^2 + \frac{1}{48}x^4 + \dots\right)^2} \\
 &= y_1 \int \frac{dx}{x^3 \left(1 + \frac{1}{2}x^2 + \frac{5}{48}x^4 + \frac{7}{576}x^6 + \dots\right)} = y_1 \int \frac{1}{x^3} \left(1 - \frac{1}{2}x^2 + \frac{7}{48}x^4 + \frac{19}{576}x^6 + \dots\right) \\
 &= y_1 \int \left(\frac{1}{x^3} - \frac{1}{2x} + \frac{7}{48}x - \frac{19}{576}x^3 + \dots\right) dx = y_1 \left[-\frac{1}{2x^2} - \frac{1}{2} \ln x + \frac{7}{96}x^2 - \frac{19}{2,304}x^4 + \dots\right] \\
 &= -\frac{1}{2}y_1 \ln x + y_1 \left[-\frac{1}{2x^2} + \frac{7}{96}x^2 - \frac{19}{2,304}x^4 + \dots\right].
 \end{aligned}$$

The general solution on  $(0, \infty)$  is

$$y = C_1 y_1(x) + C_2 y_2(x).$$

29. Substituting  $y = \sum_{n=0}^{\infty} c_n x^{n+r}$  into the differential equation and collecting terms, we obtain

$$xy'' + (1-x)y' - y = r^2 c_0 x^{r-1} + \sum_{k=0}^{\infty} [(k+r)(k+r-1)c_k + (k+r)c_k - (k+r)c_{k-1}] x^{k+r-1} = 0,$$

which implies  $r^2 = 0$  and

$$(k+r)^2 c_k - (k+r)c_{k-1} = 0.$$

The indicial roots are  $r_1 = r_2 = 0$  and the recurrence relation is

$$c_k = \frac{c_{k-1}}{k}, \quad k = 1, 2, 3, \dots$$

One solution is

$$y_1 = c_0 \left(1 + x + \frac{1}{2}x^2 + \frac{1}{3!}x^3 + \dots\right) = c_0 e^x.$$

A second solution is

$$\begin{aligned}
 y_2 &= y_1 \int \frac{e^{-\int(1/x-1)dx}}{e^{2x}} dx = e^x \int \frac{e^x/x}{e^{2x}} dx = e^x \int \frac{1}{x} e^{-x} dx \\
 &= e^x \int \frac{1}{x} \left(1 - x + \frac{1}{2}x^2 - \frac{1}{3!}x^3 + \dots\right) dx = e^x \int \left(\frac{1}{x} - 1 + \frac{1}{2}x - \frac{1}{3!}x^2 + \dots\right) dx \\
 &= e^x \left[\ln x - x + \frac{1}{2 \cdot 2}x^2 - \frac{1}{3 \cdot 3!}x^3 + \dots\right] = e^x \ln x - e^x \sum_{n=1}^{\infty} \frac{(-1)^{n+1}}{n \cdot n!} x^n.
 \end{aligned}$$

The general solution on  $(0, \infty)$  is

$$y = C_1 e^x + C_2 e^x \left(\ln x - \sum_{n=1}^{\infty} \frac{(-1)^{n+1}}{n \cdot n!} x^n\right).$$

## Exercises 6.2

30. Substituting  $y = \sum_{n=0}^{\infty} c_n x^{n+r}$  into the differential equation and collecting terms, we obtain

$$xy'' + y' + y = r^2 c_0 x^{r-1} + \sum_{k=1}^{\infty} [(k+r)(k+r-1)c_k + (k+r)c_k + c_{k-1}]x^{k+r-1} = 0$$

which implies  $r^2 = 0$  and

$$(k+r)^2 c_k + c_{k-1} = 0.$$

The indicial roots are  $r_1 = r_2 = 0$  and the recurrence relation is

$$c_k = -\frac{c_{k-1}}{k^2}, \quad k = 1, 2, 3, \dots$$

One solution is

$$y_1 = c_0 \left( 1 - x + \frac{1}{2^2}x^2 - \frac{1}{(3!)^2}x^3 + \frac{1}{(4!)^2}x^4 - \dots \right) = c_0 \sum_{n=0}^{\infty} \frac{(-1)^n}{(n!)^2} x^n.$$

A second solution is

$$\begin{aligned} y_2 &= y_1 \int \frac{e^{-\int(1/x)dx}}{y_1^2} dx = y_1 \int \frac{dx}{x \left( 1 - x + \frac{1}{4}x^2 - \frac{1}{36}x^3 + \dots \right)^2} \\ &= y_1 \int \frac{dx}{x \left( 1 - 2x + \frac{3}{2}x^2 - \frac{5}{9}x^3 + \frac{35}{288}x^4 - \dots \right)} \\ &= y_1 \int \frac{1}{x} \left( 1 + 2x + \frac{5}{2}x^2 + \frac{23}{9}x^3 + \frac{677}{288}x^4 + \dots \right) dx \\ &= y_1 \int \left( \frac{1}{x} + 2 + \frac{5}{2}x + \frac{23}{9}x^2 + \frac{677}{288}x^3 + \dots \right) dx \\ &= y_1 \left[ \ln x + 2x + \frac{5}{4}x^2 + \frac{23}{27}x^3 + \frac{677}{1,152}x^4 + \dots \right] \\ &= y_1 \ln x + y_1 \left( 2x + \frac{5}{4}x^2 + \frac{23}{27}x^3 + \frac{677}{1,152}x^4 + \dots \right). \end{aligned}$$

The general solution on  $(0, \infty)$  is

$$y = C_1 y_1(x) + C_2 y_2(x).$$

31. Substituting  $y = \sum_{n=0}^{\infty} c_n x^{n+r}$  into the differential equation and collecting terms, we obtain

$$\begin{aligned} xy'' + (x-6)y' - 3y &= (r^2 - 7r)c_0 x^{r-1} + \sum_{k=1}^{\infty} [(k+r)(k+r-1)c_k + (k+r-1)c_{k-1} \\ &\quad - 6(k+r)c_k - 3c_{k-1}]x^{k+r-1} = 0, \end{aligned}$$

which implies

$$r^2 - 7r = r(r-7) = 0$$

and

$$(k+r)(k+r-7)c_k + (k+r-4)c_{k-1} = 0.$$

The indicial roots are  $r_1 = 7$  and  $r_2 = 0$ . For  $r_1 = 7$  the recurrence relation is

$$(k+7)kc_k + (k+3)c_{k-1} = 0, \quad k = 1, 2, 3, \dots,$$

or

$$c_k = -\frac{k+3}{k+7}c_{k-1}, \quad k = 1, 2, 3, \dots$$

Taking  $c_0 \neq 0$  we obtain

$$c_1 = -\frac{1}{2}c_0$$

$$c_2 = \frac{5}{18}c_0$$

$$c_3 = -\frac{1}{6}c_0,$$

and so on. Thus, the indicial root  $r_1 = 7$  yields a single solution. Now, for  $r_2 = 0$  the recurrence relation is

$$k(k-7)c_k + (k-4)c_{k-1} = 0, \quad k = 1, 2, 3, \dots$$

Then

$$-6c_1 - 3c_0 = 0$$

$$-10c_2 - 2c_1 = 0$$

$$-12c_3 - c_2 = 0$$

$$-12c_4 + 0c_3 = 0 \implies c_4 = 0$$

$$-10c_5 + c_4 = 0 \implies c_5 = 0$$

$$-6c_6 + 2c_5 = 0 \implies c_6 = 0$$

$$0c_7 + 3c_6 = 0 \implies c_7 \text{ is arbitrary}$$

and

$$c_k = -\frac{k-4}{k(k-7)}c_{k-1}, \quad k = 8, 9, 10, \dots$$

## Exercises 6.2

Taking  $c_0 \neq 0$  and  $c_7 = 0$  we obtain

$$c_1 = -\frac{1}{2}c_0$$

$$c_2 = \frac{1}{10}c_0$$

$$c_3 = -\frac{1}{120}c_0$$

$$c_4 = c_5 = c_6 = \cdots = 0.$$

Taking  $c_0 = 0$  and  $c_7 \neq 0$  we obtain

$$c_1 = c_2 = c_3 = c_4 = c_5 = c_6 = 0$$

$$c_8 = -\frac{1}{2}c_7$$

$$c_9 = \frac{5}{36}c_7$$

$$c_{10} = -\frac{1}{36}c_7.$$

In this case we obtain the two solutions

$$y_1 = 1 - \frac{1}{2}x + \frac{1}{10}x^2 - \frac{1}{120}x^3 \quad \text{and} \quad y_2 = x^7 - \frac{1}{2}x^8 + \frac{5}{36}x^9 - \frac{1}{36}x^{10} + \cdots$$

32. Substituting  $y = \sum_{n=0}^{\infty} c_n x^{n+r}$  into the differential equation and collecting terms, we obtain

$$\begin{aligned} x(x-1)y'' + 3y' - 2y &= (4r - r^2)c_0 x^{r-1} + \sum_{k=1}^{\infty} [(k+r-1)(k+r-12)c_{k-1} - (k+r)(k+r-1)c_k \\ &\quad + 3(k+r)c_k - 2c_{k-1}]x^{k+r-1} \\ &= 0, \end{aligned}$$

which implies

$$4r - r^2 = r(4 - r) = 0$$

and

$$-(k+r)(k+r-4)c_k + [(k+r-1)(k+r-2) - 2]c_{k-1} = 0.$$

The indicial roots are  $r_1 = 4$  and  $r_2 = 0$ . For  $r_1 = 4$  the recurrence relation is

$$-(k+4)kc_k + [(k+3)(k+2) - 2]c_{k-1} = 0$$

or

$$c_k = (k+1)c_{k-1}, \quad k = 1, 2, 3, \dots$$



Exercises 6.2

Taking  $c_0 \neq 0$  we obtain

$$c_1 = 2c_0$$

$$c_2 = 3!c_0$$

$$c_3 = 4!c_0,$$

and so on. Thus, the indicial root  $r_1 = 4$  yields a single solution. For  $r_2 = 0$  the recurrence relation is

$$-k(k-4)c_k + k(k-3)c_{k-1} = 0, \quad k = 1, 2, 3, \dots,$$

or

$$-(k-4)c_k + (k-3)c_{k-1} = 0, \quad k = 1, 2, 3, \dots.$$

Then

$$3c_1 - 2c_0 = 0$$

$$2c_2 - c_1 = 0$$

$$c_3 + 0c_2 = 0 \Rightarrow c_3 = 0$$

$$0c_4 + c_3 = 0 \Rightarrow c_4 \text{ is arbitrary}$$

and

$$c_k = \frac{(k-3)c_{k-1}}{c-4}, \quad k = 5, 6, 7, \dots.$$

Taking  $c_0 \neq 0$  and  $c_4 = 0$  we obtain

$$c_1 = \frac{2}{3}c_0$$

$$c_2 = \frac{1}{3}c_0$$

$$c_3 = c_4 = c_5 = \dots = 0.$$

Taking  $c_0 = 0$  and  $c_4 \neq 0$  we obtain

$$c_1 = c_2 = c_3 = 0$$

$$c_5 = 2c_4$$

$$c_6 = 3c_4$$

$$c_7 = 4c_4.$$

In this case we obtain the two solutions

$$y_1 = 1 + \frac{2}{3}x + \frac{1}{3}x^2 \quad \text{and} \quad y_2 = x^4 + 2x^5 + 3x^6 + 4x^7 + \dots.$$

33. (a) From  $t = 1/x$  we have  $dt/dx = -1/x^2 = -t^2$ . Then

## Exercises 6.2

$$\frac{dy}{dx} = \frac{dy}{dt} \frac{dt}{dx} = -t^2 \frac{dy}{dt}$$

and

$$\frac{d^2y}{dx^2} = \frac{d}{dx} \left( \frac{dy}{dx} \right) = \frac{d}{dx} \left( -t^2 \frac{dy}{dt} \right) = -t^2 \frac{d^2y}{dt^2} \frac{dt}{dx} - \frac{dy}{dt} \left( 2t \frac{dt}{dx} \right) = t^4 \frac{d^2y}{dt^2} + 2t^3 \frac{dy}{dt}.$$

Now

$$x^4 \frac{d^2y}{dx^2} + \lambda y = \frac{1}{t^4} \left( t^4 \frac{d^2y}{dt^2} + 2t^3 \frac{dy}{dt} \right) + \lambda y = \frac{d^2y}{dt^2} + \frac{2}{t} \frac{dy}{dt} + \lambda y = 0$$

becomes

$$t \frac{d^2y}{dt^2} + 2 \frac{dy}{dt} + \lambda ty = 0.$$

(b) Substituting  $y = \sum_{n=0}^{\infty} c_n t^{n+r}$  into the differential equation and collecting terms, we obtain

$$\begin{aligned} t \frac{d^2y}{dt^2} + 2 \frac{dy}{dt} + \lambda ty &= (r^2 + r)c_0 t^{r-1} + (r^2 + 3r + 2)c_1 t^r \\ &+ \sum_{k=2}^{\infty} [(k+r)(k+r-1)c_k + 2(k+r)c_k + \lambda c_{k-2}] t^{k+r-1} \\ &= 0, \end{aligned}$$

which implies

$$r^2 + r = r(r+1) = 0,$$

$$(r^2 + 3r + 2)c_1 = 0,$$

and

$$(k+r)(k+r+1)c_k + \lambda c_{k-2} = 0.$$

The indicial roots are  $r_1 = 0$  and  $r_2 = -1$ , so  $c_1 = 0$ . For  $r_1 = 0$  the recurrence relation is

$$c_k = -\frac{\lambda c_{k-2}}{k(k+1)}, \quad k = 2, 3, 4, \dots,$$

and

$$c_2 = -\frac{\lambda}{3!} c_0$$

$$c_3 = c_5 = c_7 = \dots = 0$$

$$c_4 = \frac{\lambda^2}{5!} c_0$$

$$c_{2n} = (-1)^n \frac{\lambda^n}{(2n+1)!} c_0.$$

For  $r_2 = -1$  the recurrence relation is

$$c_k = -\frac{\lambda c_{k-2}}{k(k-1)}, \quad k = 2, 3, 4, \dots,$$

and

$$c_2 = -\frac{\lambda}{2!}c_0$$

$$c_3 = c_5 = c_7 = \dots = 0$$

$$c_4 = \frac{\lambda^2}{4!}c_0$$

$$c_{2n} = (-1)^n \frac{\lambda^n}{(2n)!}c_0.$$

The general solution on  $(0, \infty)$  is

$$\begin{aligned} y(t) &= C_1 \sum_{n=0}^{\infty} \frac{(-1)^n}{(2n+1)!} (\sqrt{\lambda}t)^{2n} + C_2 t^{-1} \sum_{n=0}^{\infty} \frac{(-1)^n}{(2n)!} (\sqrt{\lambda}t)^{2n} \\ &= \frac{1}{t} \left[ C_1 \sum_{n=0}^{\infty} \frac{(-1)^n}{(2n+1)!} (\sqrt{\lambda}t)^{2n+1} + C_2 \sum_{n=0}^{\infty} \frac{(-1)^n}{(2n)!} (\sqrt{\lambda}t)^{2n} \right] \\ &= \frac{1}{t} [C_1 \sin \sqrt{\lambda}t + C_2 \cos \sqrt{\lambda}t]. \end{aligned}$$

(c) Using  $t = 1/x$ , the solution of the original equation is

$$y(x)C_1x \sin \frac{\sqrt{\lambda}}{x} + C_2x \cos \frac{\sqrt{\lambda}}{x}.$$

34. (a) From the boundary conditions  $y(a) = 0$ ,  $y(b) = 0$  we find

$$C_1 \sin \frac{\sqrt{\lambda}}{a} + C_2 \cos \frac{\sqrt{\lambda}}{a} = 0$$

$$C_1 \sin \frac{\sqrt{\lambda}}{b} + C_2 \cos \frac{\sqrt{\lambda}}{b} = 0.$$

Since this is a homogeneous system of linear equations, it will have nontrivial solutions if

$$\begin{aligned} \begin{vmatrix} \sin \frac{\sqrt{\lambda}}{a} & \cos \frac{\sqrt{\lambda}}{a} \\ \sin \frac{\sqrt{\lambda}}{b} & \cos \frac{\sqrt{\lambda}}{b} \end{vmatrix} &= \sin \frac{\sqrt{\lambda}}{a} \cos \frac{\sqrt{\lambda}}{b} - \cos \frac{\sqrt{\lambda}}{a} \sin \frac{\sqrt{\lambda}}{b} \\ &= \sin \left( \frac{\sqrt{\lambda}}{a} - \frac{\sqrt{\lambda}}{b} \right) = \sin \sqrt{\lambda} \left( \frac{b-a}{ab} \right) = 0. \end{aligned}$$

## Exercises 6.2

This will be the case if

$$\sqrt{\lambda} \left( \frac{b-a}{ab} \right) = n\pi \quad \text{or} \quad \sqrt{\lambda} = \frac{n\lambda ab}{b-a} = \frac{n\lambda ab}{L}, \quad n = 1, 2, \dots,$$

or, if

$$\lambda_n = \frac{n^2 \pi^2 a^2 b^2}{L^2} = \frac{P_n b^4}{EI}.$$

The critical loads are then  $P_n = n^2 \pi^2 (a/b)^2 EI_0 / L^2$ . Using  $C_2 = -C_1 \sin(\sqrt{\lambda}/a) / \cos(\sqrt{\lambda}/a)$  we have

$$\begin{aligned} y &= C_1 x \left[ \sin \frac{\sqrt{\lambda}}{x} - \frac{\sin(\sqrt{\lambda}/a)}{\cos(\sqrt{\lambda}/a)} \cos \frac{\sqrt{\lambda}}{x} \right] \\ &= C_3 x \left[ \sin \frac{\sqrt{\lambda}}{x} \cos \frac{\sqrt{\lambda}}{a} - \cos \frac{\sqrt{\lambda}}{x} \sin \frac{\sqrt{\lambda}}{a} \right] \\ &= C_3 x \sin \sqrt{\lambda} \left( \frac{1}{x} - \frac{1}{a} \right), \end{aligned}$$

and

$$y_n(x) = C_3 x \sin \frac{n\pi ab}{L} \left( \frac{1}{x} - \frac{1}{a} \right) = C_4 x \sin \frac{n\pi ab}{L} \left( 1 - \frac{a}{x} \right).$$

- (b) When  $n = 1$ ,  $b = 11$ , and  $a = 1$ , we have,  
for  $C_4 = 1$ ,

$$y_1(x) = x \sin 1.1\pi \left( 1 - \frac{1}{x} \right).$$

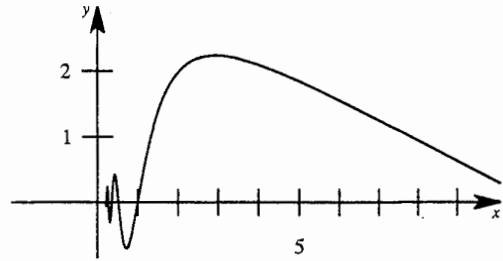

35. Express the differential equation in standard form:

$$y''' + P(x)y'' + Q(x)y' + R(x)y = 0.$$

Suppose  $x_0$  is a singular point of the differential equation. Then we say that  $x_0$  is a regular singular point if  $(x - x_0)P(x)$ ,  $(x - x_0)^2Q(x)$ , and  $(x - x_0)^3R(x)$  are analytic at  $x = x_0$ .

36. Substituting  $y = \sum_{n=0}^{\infty} c_n x^{n+r}$  into the first differential equation and collecting terms, we obtain

$$x^3 y'' + y = c_0 x^r + \sum_{k=1}^{\infty} [c_k + (k+r-1)(k+r-2)c_{k-1}] x^{k+r} = 0.$$

It follows that  $c_0 = 0$  and

$$c_k = -(k+r-1)(k+r-2)c_{k-1}.$$

The only solution we obtain is  $y(x) = 0$ .

### Exercises 6.3

Substituting  $y = \sum_{n=0}^{\infty} c_n x^{n+r}$  into the second differential equation and collecting terms, we obtain

$$x^2 y'' + (3x - 1)y' + y = -rc_0 + \sum_{k=0}^{\infty} [(k+r+1)^2 c_k - (k+r+1)c_{k+1}] x^{k+r} = 0,$$

which implies

$$-rc_0 = 0$$

$$(k+r+1)^2 c_k - (k+r+1)c_{k+1} = 0.$$

If  $c_0 = 0$ , then the solution of the differential equation is  $y = 0$ . Thus, we take  $r = 0$ , from which we obtain

$$c_{k+1} = (k+1)c_k, \quad k = 0, 1, 2, \dots$$

Letting  $c_0 = 1$  we get  $c_1 = 2$ ,  $c_2 = 3!$ ,  $c_3 = 4!$ , and so on. The solution of the differential equation is then  $y = \sum_{n=0}^{\infty} (n+1)! x^n$ , which converges only at  $x = 0$ .

37. We write the differential equation in the form  $x^2 y'' + (b/a)xy' + (c/a)y = 0$  and identify  $a_0 = b/a$  and  $b_0 = c/a$  as in (12) in the text. Then the indicial equation is

$$r(r-1) + \frac{b}{a}r + \frac{c}{a} = 0 \quad \text{or} \quad ar^2 + (b-a)r + c = 0,$$

which is also the auxiliary equation of  $ax^2 y'' + bxy' + cy = 0$ .

---

### Exercises 6.3

---

1. Since  $\nu^2 = 1/9$  the general solution is  $y = c_1 J_{1/3}(x) + c_2 J_{-1/3}(x)$ .
2. Since  $\nu^2 = 1$  the general solution is  $y = c_1 J_1(x) + c_2 Y_1(x)$ .
3. Since  $\nu^2 = 25/4$  the general solution is  $y = c_1 J_{5/2}(x) + c_2 J_{-5/2}(x)$ .
4. Since  $\nu^2 = 1/16$  the general solution is  $y = c_1 J_{1/4}(x) + c_2 J_{-1/4}(x)$ .
5. Since  $\nu^2 = 0$  the general solution is  $y = c_1 J_0(x) + c_2 Y_0(x)$ .
6. Since  $\nu^2 = 4$  the general solution is  $y = c_1 J_2(x) + c_2 Y_2(x)$ .
7. Since  $\nu^2 = 2$  the general solution is  $y = c_1 J_2(3x) + c_2 Y_2(3x)$ .
8. Since  $\nu^2 = 1/4$  the general solution is  $y = c_1 J_{1/2}(6x) + c_2 J_{-1/2}(6x)$ .
9. If  $y = x^{-1/2}v(x)$  then

$$y' = x^{-1/2}v'(x) - \frac{1}{2}x^{-3/2}v(x),$$

$$y'' = x^{-1/2}v''(x) - x^{-3/2}v'(x) + \frac{3}{4}x^{-5/2}v(x),$$

### Exercises 6.3

and

$$x^2 y'' + 2xy' + \lambda^2 x^2 y = x^{3/2} v'' + x^{1/2} v' + \left( \lambda^2 x^{3/2} - \frac{1}{4} x^{-1/2} \right) v.$$

Multiplying by  $x^{1/2}$  we obtain

$$x^2 v'' + xv' + \left( \lambda^2 x^2 - \frac{1}{4} \right) v = 0,$$

whose solution is  $v = c_1 J_{1/2}(\lambda x) + c_2 J_{-1/2}(\lambda x)$ . Then  $y = c_1 x^{-1/2} J_{1/2}(\lambda x) + c_2 x^{-1/2} J_{-1/2}(\lambda x)$ .

10. From  $y = x^n J_n(x)$  we find

$$y' = x^n J_n' + nx^{n-1} J_n \quad \text{and} \quad y'' = x^n J_n'' + 2nx^{n-1} J_n' + n(n-1)x^{n-2} J_n.$$

Substituting into the differential equation, we have

$$\begin{aligned} x^{n+1} J_n'' + 2nx^n J_n' + n(n-1)x^{n-1} J_n + (1-2n)(x^n J_n' + nx^{n-1} J_n) + x^{n+1} J_n \\ = x^{n+1} J_n'' + (2n+1-2n)x^n J_n' + (n^2 - n + n - 2n^2)x^{n-1} J_n + x^{n+1} J_n \\ = x^{n+1} [x^2 J_n'' + x J_n' - n^2 J_n + x^2 J_n] \\ = x^{n+1} [x^2 J_n'' + x J_n' + (x^2 - n^2) J_n] \\ = x^{n-1} \cdot 0 \quad (\text{since } J_n \text{ is a solution of Bessel's equation}) \\ = 0. \end{aligned}$$

Therefore,  $x^n J_n$  is a solution of the original equation.

11. From  $y = x^{-n} J_n$  we find

$$y' = x^{-n} J_n' - nx^{-n-1} J_n \quad \text{and} \quad y'' = x^{-n} J_n'' - 2nx^{-n-1} J_n' + n(n+1)x^{-n-2} J_n.$$

Substituting into the differential equation, we have

$$\begin{aligned} xy'' + (1+2n)y' + xy = x^{-n-1} [x^2 J_n'' + x J_n' + (x^2 - n^2) J_n] \\ = x^{-n-1} \cdot 0 \quad (\text{since } J_n \text{ is a solution of Bessel's equation}) \\ = 0. \end{aligned}$$

Therefore,  $x^{-n} J_n$  is a solution of the original equation.

12. From  $y = \sqrt{x} J_\nu(\lambda x)$  we find

$$y' = \lambda \sqrt{x} J_\nu'(\lambda x) + \frac{1}{2} x^{-1/2} J_\nu(\lambda x)$$

and

$$y'' = \lambda^2 \sqrt{x} J_\nu''(\lambda x) + \lambda x^{-1/2} J_\nu'(\lambda x) - \frac{1}{4} x^{-3/2} J_\nu(\lambda x).$$

Exercises 6.3

Substituting into the differential equation, we have

$$\begin{aligned} x^2 y'' + \left( \lambda^2 x^2 - \nu^2 + \frac{1}{4} \right) y &= \sqrt{x} \left[ \lambda^2 x^2 J_\nu''(\lambda x) + \lambda x J_\nu'(\lambda x) + (\lambda^2 x^2 - \nu^2) J_\nu(\lambda x) \right] \\ &= \sqrt{x} \cdot 0 \quad (\text{since } J_n \text{ is a solution of Bessel's equation}) \\ &= 0. \end{aligned}$$

Therefore,  $\sqrt{x} J_\nu(\lambda x)$  is a solution of the original equation.

13. From Problem 10 with  $n = 1/2$  we find  $y = x^{1/2} J_{1/2}(x)$ . From Problem 11 with  $n = -1/2$  we find  $y = x^{1/2} J_{-1/2}(x)$ .
14. From Problem 10 with  $n = 1$  we find  $y = x J_1(x)$ . From Problem 11 with  $n = -1$  we find  $y = x J_{-1}(x) = -x J_1(x)$ .
15. From Problem 10 with  $n = -1$  we find  $y = x^{-1} J_{-1}(x)$ . From Problem 11 with  $n = 1$  we find  $y = x^{-1} J_1(x) = -x^{-1} J_{-1}(x)$ .
16. From Problem 12 with  $\lambda = 2$  and  $\nu = 0$  we find  $y = \sqrt{x} J_0(2x)$ .
17. From Problem 12 with  $\lambda = 1$  and  $\nu = \pm 3/2$  we find  $y = \sqrt{x} J_{3/2}(x)$  and  $y = \sqrt{x} J_{-3/2}(x)$ .
18. From Problem 10 with  $n = 3$  we find  $y = x^3 J_3(x)$ . From Problem 11 with  $n = -3$  we find  $y = x^3 J_{-3}(x) = -x^3 J_3(x)$ .
19. (a) The recurrence relation follows from

$$\begin{aligned} -\nu J_\nu(x) + x J_{\nu-1}(x) &= -\sum_{n=0}^{\infty} \frac{(-1)^n \nu}{n! \Gamma(1 + \nu + n)} \left(\frac{x}{2}\right)^{2n+\nu} + x \sum_{n=0}^{\infty} \frac{(-1)^n}{n! \Gamma(\nu + n)} \left(\frac{x}{2}\right)^{2n+\nu-1} \\ &= -\sum_{n=0}^{\infty} \frac{(-1)^n \nu}{n! \Gamma(1 + \nu + n)} \left(\frac{x}{2}\right)^{2n+\nu} + \sum_{n=0}^{\infty} \frac{(-1)^n (\nu + n)}{n! \Gamma(1 + \nu + n)} \cdot 2 \left(\frac{x}{2}\right) \left(\frac{x}{2}\right)^{2n+\nu-1} \\ &= \sum_{n=0}^{\infty} \frac{(-1)^n (2n + \nu)}{n! \Gamma(1 + \nu + n)} \left(\frac{x}{2}\right)^{2n+\nu} = x J_\nu'(x). \end{aligned}$$

- (b) The formula in part (a) is a linear first-order differential equation in  $J_\nu(x)$ . An integrating factor for this equation is  $x^\nu$ , so

$$\frac{d}{dx} [x^\nu J_\nu(x)] = x^\nu J_{\nu-1}(x).$$

20. Subtracting the formula in part (a) of Problem 19 from the formula in Example 4 we obtain

$$0 = 2\nu J_\nu(x) - x J_{\nu+1}(x) - x J_{\nu-1}(x) \quad \text{or} \quad 2\nu J_\nu(x) = x J_{\nu+1}(x) + x J_{\nu-1}(x).$$

21. Letting  $\nu = 1$  in (15) in the text we have

$$x J_0(x) = \frac{d}{dx} [x J_1(x)] \quad \text{so} \quad \int_0^x r J_0(r) dr = r J_1(r) \Big|_{r=0}^{r=x} = x J_1(x).$$

### Exercises 6.3

22. From (14) we obtain  $J_0'(x) = -J_1(x)$ , and from (15) we obtain  $J_0'(x) = J_{-1}(x)$ . Thus  $J_0'(x) = J_{-1}(x) = -J_1(x)$ .

23. Since

$$\Gamma\left(1 - \frac{1}{2} + n\right) = \frac{(2n-1)!}{(n-1)!2^{2n-1}}$$

we obtain

$$J_{-1/2}(x) = \sum_{n=0}^{\infty} \frac{(-1)^n 2^{1/2} x^{-1/2}}{2n(2n-1)! \sqrt{\pi}} x^{2n} = \sqrt{\frac{2}{\pi x}} \cos x.$$

24. (a) By Problem 20, with  $\nu = 1/2$ , we obtain  $J_{1/2}(x) = xJ_{3/2}(x) + xJ_{-1/2}(x)$  so that

$$J_{3/2}(x) = \sqrt{\frac{2}{\pi x}} \left( \frac{\sin x}{x} - \cos x \right);$$

with  $\nu = -1/2$  we obtain  $-J_{-1/2}(x) = xJ_{1/2}(x) + xJ_{-3/2}(x)$  so that

$$J_{-3/2}(x) = -\sqrt{\frac{2}{\pi x}} \left( \frac{\cos x}{x} + \sin x \right);$$

and with  $\nu = 3/2$  we obtain  $3J_{3/2}(x) = xJ_{5/2}(x) + xJ_{1/2}(x)$  so that

$$J_{5/2}(x) = \sqrt{\frac{2}{\pi x}} \left( \frac{3 \sin x}{x^2} - \frac{3 \cos x}{x} - \sin x \right).$$

(b)

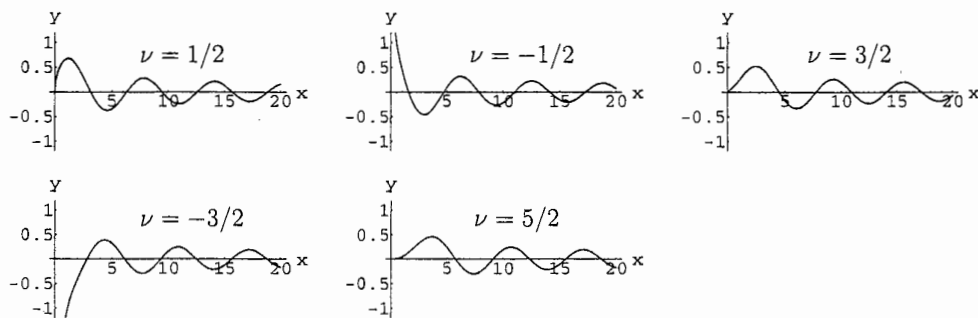

25. Letting

$$s = \frac{2}{\alpha} \sqrt{\frac{k}{m}} e^{-\alpha t/2},$$

we have

$$\frac{dx}{dt} = \frac{dx}{ds} \frac{ds}{dt} = \frac{dx}{ds} \left[ \frac{2}{\alpha} \sqrt{\frac{k}{m}} \left( -\frac{\alpha}{2} \right) e^{-\alpha t/2} \right] = \frac{dx}{ds} \left( -\sqrt{\frac{k}{m}} e^{-\alpha t/2} \right)$$



and

$$\begin{aligned}\frac{d^2x}{dt^2} &= \frac{d}{dt} \left( \frac{dx}{dt} \right) = \frac{dx}{ds} \left( \frac{\alpha \sqrt{k}}{2m} e^{-\alpha t/2} \right) + \frac{d}{dt} \left( \frac{dx}{ds} \right) \left( -\sqrt{\frac{k}{m}} e^{-\alpha t/2} \right) \\ &= \frac{dx}{ds} \left( \frac{\alpha \sqrt{k}}{2m} e^{-\alpha t/2} \right) + \frac{d^2x}{ds^2} \frac{ds}{dt} \left( -\sqrt{\frac{k}{m}} e^{-\alpha t/2} \right) \\ &= \frac{dx}{ds} \left( \frac{\alpha \sqrt{k}}{2m} e^{-\alpha t/2} \right) + \frac{d^2x}{ds^2} \left( \frac{k}{m} e^{-\alpha t} \right).\end{aligned}$$

Then

$$m \frac{d^2x}{dt^2} + ke^{-\alpha t}x = ke^{-\alpha t} \frac{d^2x}{ds^2} + \frac{m\alpha}{2} \sqrt{\frac{k}{m}} e^{-\alpha t/2} \frac{dx}{dt} + ke^{-\alpha t}x = 0.$$

Multiplying by  $2^2/\alpha^2m$  we have

$$\frac{2^2}{\alpha^2} \frac{k}{m} e^{-\alpha t} \frac{d^2x}{ds^2} + \frac{2}{\alpha} \sqrt{\frac{k}{m}} e^{-\alpha t/2} \frac{dx}{dt} + \frac{2}{\alpha^2} \frac{k}{m} e^{-\alpha t}x = 0$$

or, since  $s = (2/\alpha)\sqrt{k/m}e^{-\alpha t/2}$ ,

$$s^2 \frac{d^2x}{ds^2} + s \frac{dx}{ds} + s^2x = 0.$$

26. Differentiating  $y = x^{1/2}w \left( \frac{2}{3}\alpha x^{3/2} \right)$  with respect to  $\frac{2}{3}\alpha x^{3/2}$  we obtain

$$y' = x^{1/2}w' \left( \frac{2}{3}\alpha x^{3/2} \right) \alpha x^{1/2} + \frac{1}{2}x^{-1/2}w \left( \frac{2}{3}\alpha x^{3/2} \right)$$

and

$$\begin{aligned}y'' &= \alpha x w'' \left( \frac{2}{3}\alpha x^{3/2} \right) \alpha x^{1/2} + \alpha w' \left( \frac{2}{3}\alpha x^{3/2} \right) \\ &\quad + \frac{1}{2} \alpha w' \left( \frac{2}{3}\alpha x^{3/2} \right) - \frac{1}{4} x^{-3/2} w \left( \frac{2}{3}\alpha x^{3/2} \right).\end{aligned}$$

Then, after combining terms and simplifying, we have

$$y'' + \alpha^2 x y = \alpha \left[ \alpha x^{3/2} w'' + \frac{3}{2} w' + \left( \alpha x^{3/2} - \frac{1}{4\alpha x^{3/2}} \right) w \right] = 0.$$

Letting  $t = \frac{2}{3}\alpha x^{3/2}$  or  $\alpha x^{3/2} = \frac{3}{2}t$  this differential equation becomes

$$\frac{3}{2} \frac{\alpha}{t} \left[ t^2 w''(t) + t w'(t) + \left( t^2 - \frac{1}{9} \right) w(t) \right] = 0, \quad t > 0.$$

27. The general solution of Bessel's equation is

$$w(t) = c_1 J_{1/3}(t) + c_2 J_{-1/3}(t), \quad t > 0.$$

Thus, the general solution of Airy's equation for  $x > 0$  is

$$y = x^{1/2}w \left( \frac{2}{3}\alpha x^{3/2} \right) = c_1 x^{1/2} J_{1/3} \left( \frac{2}{3}\alpha x^{3/2} \right) + c_2 x^{1/2} J_{-1/3} \left( \frac{2}{3}\alpha x^{3/2} \right).$$

### Exercises 6.3

28. Setting  $y = \sqrt{x} J_1(2\sqrt{x})$  and differentiating we obtain

$$y' = \sqrt{x} J_1'(2\sqrt{x}) \frac{2}{2\sqrt{x}} + \frac{1}{2\sqrt{x}} J_1(2\sqrt{x}) = J_1'(2\sqrt{x}) + \frac{1}{2\sqrt{x}} J_1(2\sqrt{x})$$

and

$$\begin{aligned} y'' &= J_1''(2\sqrt{x}) \frac{2}{2\sqrt{x}} + \frac{1}{2\sqrt{x}} J_1'(2\sqrt{x}) \frac{2}{2\sqrt{x}} - \frac{1}{4x^{3/2}} J_1(2\sqrt{x}) \\ &= \frac{1}{\sqrt{x}} J_1''(2\sqrt{x}) + \frac{1}{2x} J_1'(2\sqrt{x}) - \frac{1}{4x^{3/2}} J_1(2\sqrt{x}). \end{aligned}$$

Substituting into the differential equation and letting  $t = 2\sqrt{x}$  we have

$$\begin{aligned} xy'' + y &= \sqrt{x} J_1''(2\sqrt{x}) + \frac{1}{2} J_1'(2\sqrt{x}) - \frac{1}{4\sqrt{x}} J_1(2\sqrt{x}) + \sqrt{x} J_1(2\sqrt{x}) \\ &= \frac{1}{\sqrt{x}} \left[ x J_1''(2\sqrt{x}) + \frac{\sqrt{x}}{2} J_1'(2\sqrt{x}) + \left(x - \frac{1}{4}\right) J_1(2\sqrt{x}) \right] \\ &= \frac{2}{t} \left[ \frac{t^2}{4} J_1''(t) + \frac{t}{4} J_1'(t) + \left(\frac{t^2}{4} - \frac{1}{4}\right) J_1(t) \right] \\ &= \frac{1}{2t} [t^2 J_1''(t) + t J_1'(t) + (t^2 - 1) J_1(t)]. \end{aligned}$$

Since  $J_1(t)$  is a solution of  $t^2 y'' + t y' + (t^2 - 1)y = 0$ , we see that the last expression above is 0 and  $y = \sqrt{x} J_1(2\sqrt{x})$  is a solution of  $xy'' + y = 0$ .

29. (a) Using the expressions for the two linearly independent power series solutions,  $y_1(x)$  and  $y_2(x)$ , given in the text we obtain

$$P_6(x) = \frac{1}{16} (231x^6 - 315x^4 + 105x^2 - 5)$$

and

$$P_7(x) = \frac{1}{16} (429x^7 - 693x^5 + 315x^3 - 35x).$$

(b)  $P_6(x)$  satisfies  $(1 - x^2)y'' - 2xy' + 42y = 0$  and  $P_7(x)$  satisfies  $(1 - x^2)y'' - 2xy' + 56y = 0$ .

30. The recurrence relation can be written

$$P_{k+1}(x) = \frac{2k+1}{k+1} x P_k(x) - \frac{k}{k+1} P_{k-1}(x), \quad k = 2, 3, 4, \dots$$

$$k = 1: P_2(x) = \frac{3}{2}x^2 - \frac{1}{2}$$

$$k = 2: P_3(x) = \frac{5}{3}x \left(\frac{3}{2}x^2 - \frac{1}{2}\right) - \frac{2}{3}x = \frac{5}{2}x^3 - \frac{3}{2}x$$

$$k = 3: P_4(x) = \frac{7}{4}x \left(\frac{5}{2}x^3 - \frac{3}{2}x\right) - \frac{3}{4} \left(\frac{3}{2}x^2 - \frac{1}{2}\right) = \frac{35}{8}x^4 - \frac{30}{8}x^2 + \frac{3}{8}$$

$$k = 4: P_5(x) = \frac{9}{5}x \left(\frac{35}{8}x^4 - \frac{30}{8}x^2 + \frac{3}{8}\right) - \frac{4}{5} \left(\frac{5}{2}x^3 - \frac{3}{2}x\right) = \frac{63}{8}x^5 - \frac{35}{4}x^3 + \frac{15}{8}x$$

Exercises 6.3

$$k = 5: P_6(x) = \frac{11}{6}x \left( \frac{63}{8}x^5 - \frac{35}{4}x^3 + \frac{15}{8}x \right) - \frac{5}{6} \left( \frac{35}{8}x^4 - \frac{30}{8}x^2 + \frac{3}{8} \right) = \frac{231}{16}x^6 - \frac{315}{16}x^4 + \frac{105}{16}x^2 - \frac{5}{16}$$

$$k = 6: P_7(x) = \frac{13}{7}x \left( \frac{231}{16}x^6 - \frac{315}{16}x^4 + \frac{105}{16}x^2 - \frac{5}{16} \right) - \frac{5}{6} \left( \frac{63}{8}x^5 - \frac{35}{4}x^3 + \frac{15}{8}x \right) \\ = \frac{429}{16}x^7 - \frac{693}{16}x^5 + \frac{315}{16}x^3 - \frac{35}{16}x$$

31. If  $x = \cos \theta$  then

$$\frac{dy}{d\theta} = -\sin \theta \frac{dy}{dx},$$

$$\frac{d^2y}{d\theta^2} = \sin^2 \theta \frac{d^2y}{dx^2} - \cos \theta \frac{dy}{dx},$$

and

$$\sin \theta \frac{d^2y}{d\theta^2} + \cos \theta \frac{dy}{d\theta} + n(n+1)(\sin \theta)y = \sin \theta \left[ (1 - \cos^2 \theta) \frac{d^2y}{dx^2} - 2 \cos \theta \frac{dy}{dx} + n(n+1)y \right] = 0.$$

That is,

$$(1 - x^2) \frac{d^2y}{dx^2} - 2x \frac{dy}{dx} + n(n+1)y = 0.$$

32. From  $y = u/\sqrt{x}$  we find

$$y' = \frac{2xu' - u}{2x^{3/2}} \quad \text{and} \quad y'' = \frac{4x^{5/2} - 4x^{3/2}u' + 3x^{1/2}u}{4x^3}.$$

Then

$$x^2y'' + xy' + (x^2 - \nu^2)y = \frac{4x^{5/2}u'' - 4x^{3/2}u' + 3x^{1/2}u}{4x} + \frac{2xu' - u}{2x^{1/2}} + \frac{(x^2 - \nu^2)u}{x^{1/2}} \\ = x^{3/2}u'' + \frac{1}{4}x^{-1/2}u + x^{3/2}u - \nu^2x^{-1/2}u = 0.$$

Multiplying by  $x^{1/2}$  we obtain

$$x^2u'' + \frac{1}{4}u + x^2u - \nu^2u = 0$$

or

$$\frac{d^2u}{dx^2} + \left( 1 - \frac{\nu^2 - 1/4}{x^2} \right) u = 0.$$

For large values of  $x$  this equation can be approximated by  $u'' + u = 0$  whose solutions are  $\sin x$  and  $\cos x$ . Thus, we expect the solutions to oscillate with increasing frequency for larger  $x$ .

33. Rolle's theorem states that for a differentiable function  $f(x)$ , for which  $f(a) = f(b) = 0$ , there exists a number  $c$  between  $a$  and  $b$  such that  $f'(c) = 0$ . From Problem 20 with  $\nu = 0$  we have  $J_0'(x) = J_1(x)$ . Thus, if  $a$  and  $b$  are successive zeros of  $J_0(x)$ , then there exists a  $c$  between  $a$  and  $b$  for which  $J_1(x) = J_0'(x) = 0$ .

### Exercises 6.3

34. Since  $\left| \int_a^b f(x) dx \right| \leq \int_a^b |f(x)| dx$ , we have

$$|J_n(x)| \leq \frac{1}{\pi} \int_0^\pi |\cos(x \sin t - nt)| dt \leq \frac{1}{\pi} \int_0^\pi 1 dt = 1.$$

35. (a) We identify  $m = 4$ ,  $k = 1$ , and  $\alpha = 0.1$ . Then

$$x(t) = c_1 J_0(10e^{-0.05t}) + c_2 Y_0(10e^{-0.05t})$$

and

$$x'(t) = -0.5c_1 J_0'(10e^{-0.05t}) - 0.5c_2 Y_0'(10e^{-0.05t}).$$

Now  $x(0) = 1$  and  $x'(0) = -1/2$  imply

$$c_1 J_0(10) + c_2 Y_0(10) = 1$$

$$c_1 J_0'(10) + c_2 Y_0'(10) = 1.$$

Using Cramer's rule we obtain

$$c_1 = \frac{Y_0'(10) - Y_0(10)}{J_0(10)Y_0'(10) - J_0'(10)Y_0(10)}$$

and

$$c_2 = \frac{J_0(10) - J_0'(10)}{J_0(10)Y_0'(10) - J_0'(10)Y_0(10)}.$$

Using  $Y_0' = -Y_1$  and  $J_0' = -J_1$  and Table 6.1 we find  $c_1 = -4.7860$  and  $c_2 = -3.1803$ . Thus

$$x(t) = -4.7860 J_0(10e^{-0.05t}) - 3.1803 Y_0(10e^{-0.05t}).$$

(b)

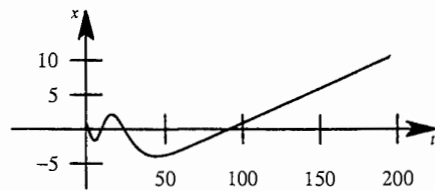

36. (a) Identifying  $\alpha = \frac{1}{2}$ , the general solution of  $x'' + \frac{1}{4}tx = 0$  is

$$x(t) = c_1 x^{1/2} J_{1/3} \left( \frac{1}{3} x^{3/2} \right) + c_2 x^{1/2} J_{-1/3} \left( \frac{1}{3} x^{3/2} \right).$$

Solving the system  $x(0.1) = 1$ ,  $x'(0.1) = -\frac{1}{2}$  we find  $c_1 = -0.809264$  and  $c_2 = 0.782397$ .

(b)

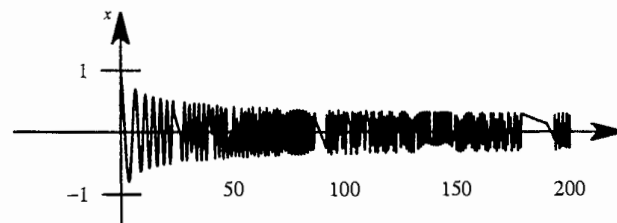

37. (a) Letting  $t = L - x$ , the boundary-value problem becomes

$$\frac{d^2\theta}{dt^2} + \alpha^2 t\theta = 0, \quad \theta'(0) = 0, \quad \theta(L) = 0,$$

where  $\alpha^2 = \delta g/EI$ . This is Airy's differential equation, so by Problem 27 its solution is

$$y = c_1 t^{1/2} J_{1/3}\left(\frac{2}{3}\alpha t^{3/2}\right) + c_2 t^{1/2} J_{-1/3}\left(\frac{2}{3}\alpha t^{3/2}\right) = c_1 \theta_1(t) + c_2 \theta_2(t).$$

- (b) Looking at the series forms of  $\theta_1$  and  $\theta_2$  we see that  $\theta_1'(0) \neq 0$ , while  $\theta_2'(0) = 0$ . Thus, the boundary condition  $\theta'(0) = 0$  implies  $c_1 = 0$ , and so

$$\theta(t) = c_2 \sqrt{t} J_{-1/3}\left(\frac{2}{3}\alpha t^{3/2}\right).$$

From  $\theta(L) = 0$  we have

$$c_2 \sqrt{L} J_{-1/3}\left(\frac{2}{3}\alpha L^{3/2}\right) = 0,$$

so either  $c_2 = 0$ , in which case  $\theta(t) = 0$ , or  $J_{-1/3}\left(\frac{2}{3}\alpha L^{3/2}\right) = 0$ . The column will just start to bend when  $L$  is the length corresponding to the smallest positive zero of  $J_{-1/3}$ . Using *Mathematica*, the first positive root of  $J_{-1/3}(x)$  is  $x_1 \approx 1.86635$ . Thus  $\frac{2}{3}\alpha L^{3/2} = 1.86635$  implies

$$\begin{aligned} L &= \left(\frac{3(1.86635)}{2\alpha}\right)^{2/3} = \left[\frac{9EI}{4\delta g}(1.86635)^2\right]^{1/3} \\ &= \left[\frac{9(2.6 \times 10^7)\pi(0.05)^4/4}{4(0.28)\pi(0.05)^2}(1.86635)^2\right]^{1/3} \approx 76.9 \text{ in.} \end{aligned}$$

38. (a) Writing the differential equation in the form  $xy'' + (PL/M)y = 0$ , we identify  $\lambda = PL/M$ . From Problem 28 the solution of this differential equation is

$$y = c_1 \sqrt{x} J_1\left(2\sqrt{PLx/M}\right) + c_2 \sqrt{x} Y_1\left(2\sqrt{PLx/M}\right).$$

Now  $J_1(0) = 0$ , so  $y(0) = 0$  implies  $c_2 = 0$  and

$$y = c_1 \sqrt{x} J_1\left(2\sqrt{PLx/M}\right).$$

- (b) From  $y(L) = 0$  we have  $y = J_1(2L\sqrt{PM}) = 0$ . The first positive zero of  $J_1$  is 3.8317 so, solving  $2L\sqrt{P_1/M} = 3.8317$ , we find  $P_1 = 3.6705M/L^2$ . Therefore,

$$y_1(x) = c_1 \sqrt{x} J_1\left(2\sqrt{\frac{3.6705x}{L}}\right) = c_1 \sqrt{x} J_1\left(\frac{3.8317}{L}\sqrt{x}\right).$$

### Exercises 6.3

- (c) For  $c_1 = 1$  and  $L = 1$  the graph of  $y_1 = \sqrt{x} J_1(3.8317\sqrt{x})$  is shown.

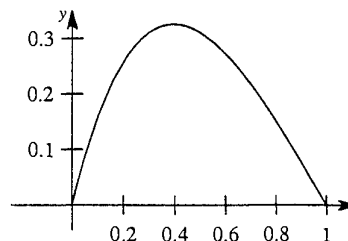

39.

Zeros and differences of  $J_0$ ,  $J_1$ , and  $J_2$

$J_0$	$\Delta J_0$	$J_1$	$\Delta J_1$	$J_2$	$\Delta J_2$
2.4048		0.0000		0.0000	
5.5201	3.1153	3.8317	3.8317	5.1356	5.1356
8.6537	3.1336	7.0156	3.1839	8.4172	3.2816
11.7915	3.1378	10.1735	3.1579	11.6198	3.2026
14.9309	3.1394	13.3237	3.1502	14.7960	3.1762

Successive zeros of  $J_n$  for  $n = 0, 1, 2$  appear to be approximately equally spaced for larger values of  $x$ . Furthermore, this spacing appears to be approximately  $\pi$ . To check this conjecture a CAS can be used to determine that successive roots of  $J_0$  near  $x = 200$  are 200.277156 and 203.418739, with difference 3.141583. This is consistent with the observation in Problem 32 that the frequency of the solutions for large  $x$  is approximately  $1/2\pi$ .

40. (a) Using a CAS we find

$$P_1(x) = \frac{1}{2} \frac{d^1}{dx^1} (x^2 - 1)^1 = x$$

$$P_2(x) = \frac{1}{2 \cdot 2!} \frac{d^2}{dx^2} (x^2 - 1)^2 = \frac{1}{2} (3x^2 - 1)$$

$$P_3(x) = \frac{1}{2 \cdot 3!} \frac{d^3}{dx^3} (x^2 - 1)^3 = \frac{1}{2} (5x^3 - 3x)$$

$$P_4(x) = \frac{1}{2 \cdot 4!} \frac{d^4}{dx^4} (x^2 - 1)^4 = \frac{1}{8} (35x^4 - 30x^2 + 3)$$

$$P_5(x) = \frac{1}{2 \cdot 5!} \frac{d^5}{dx^5} (x^2 - 1)^5 = \frac{1}{8} (63x^5 - 70x^3 + 15x)$$

$$P_6(x) = \frac{1}{2 \cdot 6!} \frac{d^6}{dx^6} (x^2 - 1)^6 = \frac{1}{16} (231x^6 - 315x^4 + 105x^2 - 5)$$

$$P_7(x) = \frac{1}{2 \cdot 7!} \frac{d^7}{dx^7} (x^2 - 1)^7 = \frac{1}{16} (429x^7 - 693x^5 + 315x^3 - 35x)$$

(b)

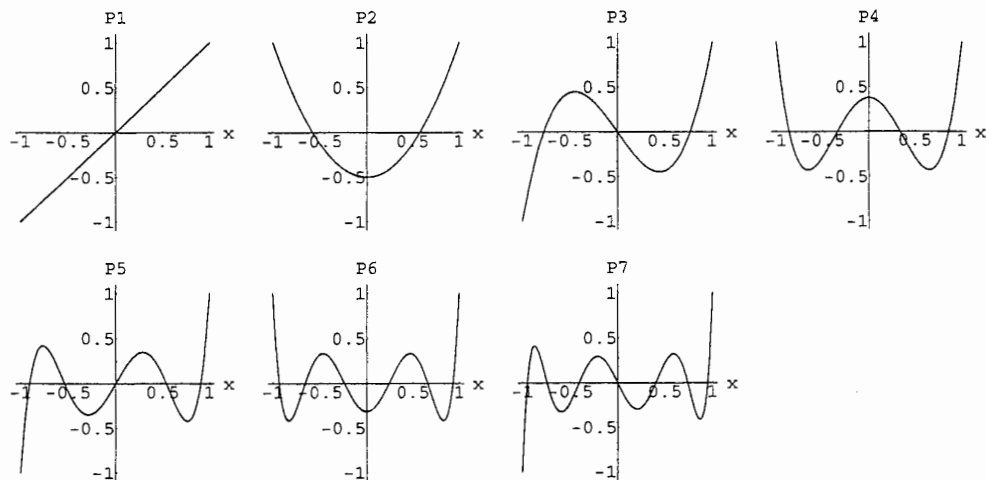

(c) Zeros of Legendre polynomials

$$P_1(x) : 0$$

$$P_2(x) : \pm 0.57735$$

$$P_3(x) : 0, \pm 0.77460$$

$$P_4(x) : \pm 0.33998, \pm 0.86115$$

$$P_5(x) : 0, \pm 0.53847, \pm 0.90618$$

$$P_6(x) : \pm 0.23862, \pm 0.66121, \pm 0.93247$$

$$P_7(x) : 0, \pm 0.40585, \pm 0.74153, \pm 0.94911$$

$$P_{10}(x) : \pm 0.14887, \pm 0.43340, \pm 0.67941, \pm 0.86506, \pm 0.097391$$

The zeros of any Legendre polynomial are in the interval  $(-1, 1)$  and are symmetric with respect to 0.

## Chapter 6 Review Exercises

- The interval of convergence is centered at 4. Since the series converges at  $-2$ , it converges at least on the interval  $[-2, 10)$ . Since it diverges at 13, it converges at most on the interval  $[-5, 13)$ . Thus, at  $-7$  it does not converge, at 0 and 7 it does converge, and at 10 and 11 it might converge.
- We have

$$f(x) = \frac{\sin x}{\cos x} = \frac{x - \frac{x^3}{6} + \frac{x^5}{120} - \dots}{1 - \frac{x^2}{2} + \frac{x^4}{24} - \dots} = x + \frac{x^3}{3} + \frac{2x^5}{15} + \dots$$

- Solving  $x^2 - 2x + 10 = 0$  we obtain  $x = 1 \pm \sqrt{11}$ , which are singular points. Thus, the minimum radius of convergence is  $|1 - \sqrt{11}| = \sqrt{11} - 1$ .
- Setting  $1 - \sin x = 0$  we see the singular points closest to 0 are  $-3\pi/2$  and  $\pi/2$ . Thus, the minimum radius of convergence is  $\pi/2$ .
- The differential equation  $(x^3 - x^2)y'' + y' + y = 0$  has a regular singular point at  $x = 1$  and an irregular singular point at  $x = 1$ .
- The differential equation  $(x - 1)(x + 3)y'' + y = 0$  has regular singular points at  $x = 1$  and  $x = -3$ .
- Substituting  $y = \sum_{n=0}^{\infty} c_n x^{n+r}$  into the differential equation we obtain

$$2xy'' + y' + y = (2r^2 - r)c_0 x^{r-1} + \sum_{k=1}^{\infty} [2(k+r)(k+r-1)c_k + (k+r)c_k + c_{k-1}]x^{k+r-1} = 0$$

which implies

$$2r^2 - r = r(2r - 1) = 0$$

and

$$(k+r)(2k+2r-1)c_k + c_{k-1} = 0.$$

The indicial roots are  $r = 0$  and  $r = 1/2$ . For  $r = 0$  the recurrence relation is

$$c_k = -\frac{c_{k-1}}{k(2k-1)}, \quad k = 1, 2, 3, \dots,$$

so

$$c_1 = -c_0, \quad c_2 = \frac{1}{6}c_0, \quad c_3 = -\frac{1}{90}c_0.$$

For  $r = 1/2$  the recurrence relation is

$$c_k = -\frac{c_{k-1}}{k(2k+1)}, \quad k = 1, 2, 3, \dots,$$

so

$$c_1 = -\frac{1}{3}c_0, \quad c_2 = \frac{1}{30}c_0, \quad c_3 = -\frac{1}{630}c_0.$$



Two linearly independent solutions are

$$y_1 = C_1 \left( 1 - x + \frac{1}{6}x^2 - \frac{1}{90}x^3 + \dots \right)$$

and

$$y_2 = C_2 x^{1/2} \left( 1 - \frac{1}{3}x + \frac{1}{30}x^2 - \frac{1}{630}x^3 + \dots \right).$$

8. Substituting  $y = \sum_{n=0}^{\infty} c_n x^n$  into the differential equation we have

$$\begin{aligned} y'' - xy' - y &= \underbrace{\sum_{n=2}^{\infty} n(n-1)c_n x^{n-2}}_{k=n-2} - \underbrace{\sum_{n=1}^{\infty} n c_n x^n}_{k=n} - \underbrace{\sum_{n=0}^{\infty} c_n x^n}_{k=n} \\ &= \sum_{k=0}^{\infty} (k+2)(k+1)c_{k+2} x^k - \sum_{k=1}^{\infty} k c_k x^k - \sum_{k=0}^{\infty} c_k x^k \\ &= 2c_2 - c_0 + \sum_{k=1}^{\infty} [(k+2)(k+1)c_{k+2} - (k+1)c_k] x^k = 0. \end{aligned}$$

Thus

$$2c_2 - c_0 = 0$$

$$(k+2)(k+1)c_{k+2} - (k+1)c_k = 0$$

and

$$c_2 = \frac{1}{2}c_0$$

$$c_{k+2} = \frac{1}{k+2} c_k, \quad k = 1, 2, 3, \dots$$

Choosing  $c_0 = 1$  and  $c_1 = 0$  we find

$$c_2 = \frac{1}{2}$$

$$c_3 = c_5 = c_7 = \dots = 0$$

$$c_4 = \frac{1}{8}$$

$$c_6 = \frac{1}{48}$$

## Chapter 6 Review Exercises

and so on. For  $c_0 = 0$  and  $c_1 = 1$  we obtain

$$c_2 = c_4 = c_6 = \dots = 0$$

$$c_3 = \frac{1}{3}$$

$$c_5 = \frac{1}{15}$$

$$c_7 = \frac{1}{105}$$

and so on. Thus, two solutions are

$$y_1 = 1 + \frac{1}{2}x^2 + \frac{1}{8}x^4 + \frac{1}{48}x^6 + \dots$$

and

$$y_2 = x + \frac{1}{3}x^3 + \frac{1}{15}x^5 + \frac{1}{105}x^7 + \dots$$

9. Substituting  $y = \sum_{n=0}^{\infty} c_n x^n$  into the differential equation we obtain

$$(x-1)y'' + 3y = (-2c_2 + 3c_0) + \sum_{k=3}^{\infty} [(k-1)(k-2)c_{k-1} - k(k-1)c_k + 3c_{k-2}]x^{k-2} = 0$$

which implies  $c_2 = 3c_0/2$  and

$$c_k = \frac{(k-1)(k-2)c_{k-1} + 3c_{k-2}}{k(k-1)}, \quad k = 3, 4, 5, \dots$$

Choosing  $c_0 = 1$  and  $c_1 = 0$  we find

$$c_2 = \frac{3}{2}, \quad c_3 = \frac{1}{2}, \quad c_4 = \frac{5}{8}$$

and so on. For  $c_0 = 0$  and  $c_1 = 1$  we obtain

$$c_2 = 0, \quad c_3 = \frac{1}{2}, \quad c_4 = \frac{1}{4}$$

and so on. Thus, two solutions are

$$y_1 = C_1 \left( 1 + \frac{3}{2}x^2 + \frac{1}{2}x^3 + \frac{5}{8}x^4 + \dots \right)$$

and

$$y_2 = C_2 \left( x + \frac{1}{2}x^3 + \frac{1}{4}x^4 + \dots \right).$$

10. Substituting  $y = \sum_{n=0}^{\infty} c_n x^n$  into the differential equation we obtain

$$y'' - x^2 y' + xy = 2c_2 + (6c_3 + c_0)x + \sum_{k=1}^{\infty} [(k+3)(k+2)c_{k+3} - (k-1)c_k]x^{k+1} = 0$$

which implies  $c_2 = 0$ ,  $c_3 = -c_0/6$ , and

$$c_{k+3} = \frac{k-1}{(k+3)(k+2)}c_k, \quad k = 1, 2, 3, \dots$$

Choosing  $c_0 = 1$  and  $c_1 = 0$  we find

$$\begin{aligned}c_3 &= -\frac{1}{6} \\c_4 &= c_7 = c_{10} = \cdots = 0 \\c_5 &= c_8 = c_{11} = \cdots = 0 \\c_6 &= -\frac{1}{90}\end{aligned}$$

and so on. For  $c_0 = 0$  and  $c_1 = 1$  we obtain

$$\begin{aligned}c_3 &= c_6 = c_9 = \cdots = 0 \\c_4 &= c_7 = c_{10} = \cdots = 0 \\c_5 &= c_8 = c_{11} = \cdots = 0\end{aligned}$$

and so on. Thus, two solutions are

$$y_1 = c_0 \left( 1 - \frac{1}{6}x^3 - \frac{1}{90}x^6 - \cdots \right) \quad \text{and} \quad y_2 = c_1 x.$$

11. Substituting  $y = \sum_{n=0}^{\infty} c_n x^{n+r}$  into the differential equation, we obtain

$$\begin{aligned}xy'' - (x+2)y' + 2y &= (r^2 - 3r)c_0 x^{r-1} + \sum_{k=1}^{\infty} [(k+r)(k+r-3)c_k \\ &\quad - (k+r-3)c_{k-1}]x^{k+r-1} = 0,\end{aligned}$$

which implies

$$r^2 - 3r = r(r-3) = 0$$

and

$$(k+r)(k+r-3)c_k - (k+r-3)c_{k-1} = 0.$$

The indicial roots are  $r_1 = 3$  and  $r_2 = 0$ . For  $r_2 = 0$  the recurrence relation is

$$k(k-3)c_k - (k-3)c_{k-1} = 0, \quad k = 1, 2, 3, \dots$$

Then

$$c_1 - c_0 = 0$$

$$2c_2 - c_1 = 0$$

$$0c_3 - 0c_2 = 0 \implies c_3 \text{ is arbitrary}$$

and

$$c_k = \frac{1}{k}c_{k-1}, \quad k = 4, 5, 6, \dots$$

## Chapter 6 Review Exercises

Taking  $c_0 \neq 0$  and  $c_3 = 0$  we obtain

$$c_1 = c_0$$

$$c_2 = \frac{1}{2}c_0$$

$$c_3 = c_4 = c_5 = \dots = 0.$$

Taking  $c_0 = 0$  and  $c_3 \neq 0$  we obtain

$$c_0 = c_1 = c_2 = 0$$

$$c_4 = \frac{1}{4}c_3 = \frac{6}{4!}c_3$$

$$c_5 = \frac{1}{5 \cdot 4}c_3 = \frac{6}{5!}c_3$$

$$c_6 = \frac{1}{6 \cdot 5 \cdot 4}c_3 = \frac{6}{6!}c_3,$$

and so on. In this case we obtain the two solutions

$$y_1 = 1 + x + \frac{1}{2}x^2$$

and

$$y_2 = x^3 + \frac{6}{4!}x^4 + \frac{6}{5!}x^5 + \frac{6}{6!}x^6 + \dots = 6e^x - 6\left(1 + x + \frac{1}{2}x^2\right).$$

12. Substituting  $y = \sum_{n=0}^{\infty} c_n x^n$  into the differential equation we have

$$\begin{aligned}(\cos x)y'' + y &= \left(1 - \frac{1}{2}x^2 + \frac{1}{24}x^4 - \frac{1}{720}x^6 + \dots\right)(2c_2 + 6c_3x + 12c_4x^2 + 20c_5x^3 + 30c_6x^4 + \dots) \\ &\quad + \sum_{n=0}^{\infty} c_n x^n \\ &= \left[2c_2 + 6c_3x + (12c_4 - c_2)x^2 + (20c_5 - 3c_3)x^3 + \left(30c_6 - 6c_4 + \frac{1}{12}c_2\right)x^4 + \dots\right] \\ &\quad + [c_0 + c_1x + c_2x^2 + c_3x^3 + c_4x^4 + \dots] \\ &= (c_0 + 2c_2) + (c_1 + 6c_3)x + 12c_4x^2 + (20c_5 - 2c_3)x^3 + \left(30c_6 - 5c_4 + \frac{1}{12}c_2\right)x^4 + \dots \\ &= 0.\end{aligned}$$

Thus

$$c_0 + 2c_2 = 0$$

$$c_1 + 6c_3 = 0$$

$$12c_4 = 0$$

$$20c_5 - 2c_3 = 0$$

$$30c_6 - 5c_4 + \frac{1}{12}c_2 = 0$$

and

$$c_2 = -\frac{1}{2}c_0$$

$$c_3 = -\frac{1}{6}c_1$$

$$c_4 = 0$$

$$c_5 = \frac{1}{10}c_3$$

$$c_6 = \frac{1}{6}c_4 - \frac{1}{360}c_2.$$

Choosing  $c_0 = 1$  and  $c_1 = 0$  we find

$$c_2 = -\frac{1}{2}, \quad c_3 = 0, \quad c_4 = 0, \quad c_5 = 0, \quad c_6 = \frac{1}{720}$$

and so on. For  $c_0 = 0$  and  $c_1 = 1$  we find

$$c_2 = 0, \quad c_3 = -\frac{1}{6}, \quad c_4 = 0, \quad c_5 = -\frac{1}{60}, \quad c_6 = 0$$

and so on. Thus, two solutions are

$$y_1 = 1 - \frac{1}{2}x^2 + \frac{1}{720}x^6 + \dots \quad \text{and} \quad y_2 = x - \frac{1}{6}x^3 - \frac{1}{60}x^5 + \dots$$

13. Substituting  $y = \sum_{n=0}^{\infty} c_n x^n$  into the differential equation we have

$$\begin{aligned} y'' + xy' + 2y &= \underbrace{\sum_{n=2}^{\infty} n(n-1)c_n x^{n-2}}_{k=n-2} + \underbrace{\sum_{n=1}^{\infty} n c_n x^n}_{k=n} + 2 \underbrace{\sum_{n=0}^{\infty} c_n x^n}_{k=n} \\ &= \sum_{k=0}^{\infty} (k+2)(k+1)c_{k+2} x^k + \sum_{k=1}^{\infty} k c_k x^k + 2 \sum_{k=0}^{\infty} c_k x^k \\ &= 2c_2 + 2c_0 + \sum_{k=1}^{\infty} [(k+2)(k+1)c_{k+2} + (k+2)c_k] x^k = 0. \end{aligned}$$

Thus

$$2c_2 + 2c_0 = 0$$

$$(k+2)(k+1)c_{k+2} + (k+2)c_k = 0$$

and

$$c_2 = -c_0$$

$$c_{k+2} = -\frac{1}{k+1} c_k, \quad k = 1, 2, 3, \dots$$

## Chapter 6 Review Exercises

Choosing  $c_0 = 1$  and  $c_1 = 0$  we find

$$c_2 = -1$$

$$c_3 = c_5 = c_7 = \cdots = 0$$

$$c_4 = \frac{1}{3}$$

$$c_6 = -\frac{1}{15}$$

and so on. For  $c_0 = 0$  and  $c_1 = 1$  we obtain

$$c_2 = c_4 = c_6 = \cdots = 0$$

$$c_3 = -\frac{1}{2}$$

$$c_5 = \frac{1}{8}$$

$$c_7 = -\frac{1}{48}$$

and so on. Thus, the general solution is

$$y = c_0 \left( 1 - x^2 + \frac{1}{3}x^4 - \frac{1}{15}x^6 + \cdots \right) + c_1 \left( x - \frac{1}{2}x^3 + \frac{1}{8}x^5 - \frac{1}{48}x^7 + \cdots \right)$$

and

$$y' = c_0 \left( -2x + \frac{4}{3}x^3 - \frac{2}{5}x^5 + \cdots \right) + c_1 \left( 1 - \frac{3}{2}x^2 + \frac{5}{8}x^4 - \frac{7}{48}x^6 + \cdots \right).$$

Setting  $y(0) = 3$  and  $y'(0) = -2$  we find  $c_0 = 3$  and  $c_1 = -2$ . Therefore, the solution of the initial-value problem is

$$y = 3 - 2x - 3x^2 + x^3 + x^4 - \frac{1}{4}x^5 - \frac{1}{5}x^6 + \frac{1}{24}x^7 + \cdots$$

14. Substituting  $y = \sum_{n=0}^{\infty} c_n x^n$  into the differential equation we have

$$\begin{aligned} (x+2)y'' + 3y &= \underbrace{\sum_{n=2}^{\infty} n(n-1)c_n x^{n-1}}_{k=n-1} + 2 \underbrace{\sum_{n=2}^{\infty} n(n-1)c_n x^{n-2}}_{k=n-2} + 3 \underbrace{\sum_{n=0}^{\infty} c_n x^n}_{k=n} \\ &= \sum_{k=1}^{\infty} (k+1)k c_{k+1} x^k + 2 \sum_{k=0}^{\infty} (k+2)(k+1)c_{k+2} x^k + 3 \sum_{k=0}^{\infty} c_k x^k \\ &= 4c_2 + 3c_0 + \sum_{k=1}^{\infty} [(k+1)k c_{k+1} + 2(k+2)(k+1)c_{k+2} + 3c_k] x^k = 0. \end{aligned}$$

Thus

$$4c_2 + 3c_0 = 0$$

$$(k+1)k c_{k+1} + 2(k+2)(k+1)c_{k+2} + 3c_k = 0$$

and

$$c_2 = -\frac{3}{4}c_0$$

$$c_{k+2} = -\frac{k}{2(k+2)}c_{k+1} - \frac{3}{2(k+2)(k+1)}c_k, \quad k = 1, 2, 3, \dots$$

Choosing  $c_0 = 1$  and  $c_1 = 0$  we find

$$c_2 = -\frac{3}{4}$$

$$c_3 = \frac{1}{8}$$

$$c_4 = \frac{1}{16}$$

$$c_5 = -\frac{9}{320}$$

and so on. For  $c_0 = 0$  and  $c_1 = 1$  we obtain

$$c_2 = 0$$

$$c_3 = -\frac{1}{4}$$

$$c_4 = \frac{1}{16}$$

$$c_5 = 0$$

and so on. Thus, the general solution is

$$y = c_0 \left( 1 - \frac{3}{4}x^2 + \frac{1}{8}x^3 + \frac{1}{16}x^4 - \frac{9}{320}x^5 + \dots \right) + c_1 \left( x - \frac{1}{4}x^3 + \frac{1}{16}x^4 + \dots \right)$$

and

$$y' = c_0 \left( -\frac{3}{2}x + \frac{3}{8}x^2 + \frac{1}{4}x^3 - \frac{9}{64}x^4 + \dots \right) + c_1 \left( 1 - \frac{3}{4}x^2 + \frac{1}{4}x^3 + \dots \right).$$

Setting  $y(0) = 0$  and  $y'(0) = 1$  we find  $c_0 = 0$  and  $c_1 = 1$ . Therefore, the solution of the initial-value problem is

$$y = x - \frac{1}{4}x^3 + \frac{1}{16}x^4 + \dots$$

15. Writing the differential equation in the form

$$y'' + \left( \frac{1 - \cos x}{x} \right) y' + xy = 0,$$

and noting that

$$\frac{1 - \cos x}{x} = \frac{x}{2} - \frac{x^3}{24} + \frac{x^5}{720} - \dots$$

is analytic at  $x = 0$ , we conclude that  $x = 0$  is an ordinary point of the differential equation.

## Chapter 6 Review Exercises

16. Writing the differential equation in the form

$$y'' + \left( \frac{x}{e^x - 1 - x} \right) y = 0$$

and noting that

$$\frac{x}{e^x - 1 - x} = \frac{2}{x} - \frac{2}{3} + \frac{x}{18} + \frac{x^2}{270} - \dots$$

we see that  $x = 0$  is a singular point of the differential equation. Since

$$x^2 \left( \frac{x}{e^x - 1 - x} \right) = 2x - \frac{2x^2}{3} + \frac{x^3}{18} + \frac{x^4}{270} - \dots,$$

we conclude that  $x = 0$  is a regular singular point.

17. Substituting  $y = \sum_{n=0}^{\infty} c_n x^n$  into the differential equation we have

$$\begin{aligned} y'' + x^2 y' + 2xy &= \underbrace{\sum_{n=2}^{\infty} n(n-1)c_n x^{n-2}}_{k=n-2} + \underbrace{\sum_{n=1}^{\infty} n c_n x^{n+1}}_{k=n+1} + 2 \underbrace{\sum_{n=0}^{\infty} c_n x^{n+1}}_{k=n+1} \\ &= \sum_{k=0}^{\infty} (k+2)(k+1)c_{k+2} x^k + \sum_{k=2}^{\infty} (k-1)c_{k-1} x^k + 2 \sum_{k=1}^{\infty} c_{k-1} x^k \\ &= 2c_2 + (6c_3 + 2c_0)x + \sum_{k=2}^{\infty} [(k+2)(k+1)c_{k+2} + (k+1)c_{k-1}] x^k = 5 - 2x + 10x^3. \end{aligned}$$

Thus

$$2c_2 = 5$$

$$6c_3 + 2c_0 = -2$$

$$12c_4 + 3c_1 = 0$$

$$20c_5 + 4c_2 = 10$$

$$(k+2)(k+1)c_{k+2} + (k+1)c_{k-1} = 0, \quad k = 4, 5, 6, \dots,$$

and

$$c_2 = \frac{5}{2}$$

$$c_3 = -\frac{1}{3}c_0 - \frac{1}{3}$$

$$c_4 = -\frac{1}{4}c_1$$

$$c_5 = \frac{1}{2} - \frac{1}{5}c_2 = \frac{1}{2} - \frac{1}{5} \left( \frac{5}{2} \right) = 0$$

$$c_{k+2} = -\frac{1}{k+2} c_{k-1}.$$



Using the recurrence relation, we find

$$c_6 = -\frac{1}{6}c_3 = \frac{1}{3 \cdot 6}(c_0 + 1) = \frac{1}{3^2 \cdot 2!}c_0 + \frac{1}{3^2 \cdot 2!}$$

$$c_7 = -\frac{1}{7}c_4 = \frac{1}{4 \cdot 7}c_1$$

$$c_8 = c_{11} = c_{14} = \dots = 0$$

$$c_9 = -\frac{1}{9}c_6 = -\frac{1}{3^3 \cdot 3!}c_0 - \frac{1}{3^3 \cdot 3!}$$

$$c_{10} = -\frac{1}{10}c_7 = -\frac{1}{4 \cdot 7 \cdot 10}c_1$$

$$c_{12} = -\frac{1}{12}c_9 = \frac{1}{3^4 \cdot 4!}c_0 + \frac{1}{3^4 \cdot 4!}$$

$$c_{13} = -\frac{1}{13}c_{10} = \frac{1}{4 \cdot 7 \cdot 10 \cdot 13}c_1$$

and so on. Thus

$$\begin{aligned} y = & c_0 \left[ 1 - \frac{1}{3}x^3 + \frac{1}{3^2 \cdot 2!}x^6 - \frac{1}{3^3 \cdot 3!}x^9 + \frac{1}{3^4 \cdot 4!}x^{12} - \dots \right] \\ & + c_1 \left[ x - \frac{1}{4}x^4 + \frac{1}{4 \cdot 7}x^7 - \frac{1}{4 \cdot 7 \cdot 10}x^{10} + \frac{1}{4 \cdot 7 \cdot 10 \cdot 13}x^{13} - \dots \right] \\ & + \left[ \frac{5}{2}x^2 - \frac{1}{3}x^3 + \frac{1}{3^2 \cdot 2!}x^6 - \frac{1}{3^3 \cdot 3!}x^9 + \frac{1}{3^4 \cdot 4!}x^{12} - \dots \right]. \end{aligned}$$

18. (a) From  $y = -\frac{1}{u} \frac{du}{dx}$  we obtain

$$\frac{dy}{dx} = -\frac{1}{u} \frac{d^2u}{dx^2} + \frac{1}{u^2} \left( \frac{du}{dx} \right)^2.$$

Then  $dy/dx = x^2 + y^2$  becomes

$$-\frac{1}{u} \frac{d^2u}{dx^2} + \frac{1}{u^2} \left( \frac{du}{dx} \right)^2 = x^2 + \frac{1}{u^2} \left( \frac{du}{dx} \right)^2,$$

so  $\frac{d^2u}{dx^2} + x^2u = 0$ .

- (b) If  $u = x^{1/2}w(\frac{1}{2}x^2)$  then

$$u' = x^{3/2}w' \left( \frac{1}{2}x^2 \right) + \frac{1}{2}x^{-1/2}w \left( \frac{1}{2}x^2 \right)$$

and

$$u'' = x^{5/2}w'' \left( \frac{1}{2}x^2 \right) + 2x^{1/2}w' \left( \frac{1}{2}x^2 \right) - \frac{1}{4}x^{-3/2}w \left( \frac{1}{2}x^2 \right),$$

## Chapter 6 Review Exercises

so

$$u'' + x^2 u = x^{1/2} \left[ x^2 w'' \left( \frac{1}{2} x^2 \right) + 2w' \left( \frac{1}{2} x^2 \right) + \left( x^2 - \frac{1}{4} x^{-2} \right) w \left( \frac{1}{2} x^2 \right) \right] = 0.$$

Letting  $t = \frac{1}{2} x^2$  we have

$$\sqrt{2t} \left[ 2tw''(t) + 2w'(t) + \left( 2t - \frac{1}{4 \cdot 2t} \right) w(t) \right] = 0$$

or

$$t^2 w''(t) + tw'(t) + \left( t^2 - \frac{1}{16} \right) w(t) = 0.$$

This is Bessel's equation with  $\nu = 1/4$ , so

$$w(t) = c_1 J_{1/4}(t) + c_2 J_{-1/4}(t).$$

(c) We have

$$\begin{aligned} y &= -\frac{1}{u} \frac{du}{dx} = -\frac{1}{x^{1/2} w(t)} \frac{d}{dx} x^{1/2} w(t) \\ &= -\frac{1}{x^{1/2} w} \left[ x^{1/2} \frac{dw}{dt} \frac{dt}{dx} + \frac{1}{2} x^{-1/2} w \right] \\ &= -\frac{1}{x^{1/2} w} \left[ x^{3/2} \frac{dw}{dt} + \frac{1}{2x^{1/2}} w \right] \\ &= -\frac{1}{2xw} \left[ 2x^2 \frac{dw}{dt} + w \right] = -\frac{1}{2xw} \left[ 4t \frac{dw}{dt} + w \right]. \end{aligned}$$

Now

$$\begin{aligned} 4t \frac{dw}{dt} + w &= 4t \frac{d}{dt} [c_1 J_{1/4}(t) + c_2 J_{-1/4}(t)] + c_1 J_{1/4}(t) + c_2 J_{-1/4}(t) \\ &= 4t \left[ c_1 \left( J_{-3/4}(t) - \frac{1}{4t} J_{1/4}(t) \right) + c_2 \left( -\frac{1}{4t} J_{-1/4}(t) - J_{3/4}(t) \right) \right] \\ &\quad + c_1 J_{1/4}(t) + c_2 J_{-1/4}(t) \\ &= 4c_1 t J_{-3/4}(t) - 4c_2 t J_{3/4}(t) \\ &= 2c_1 x^2 J_{-3/4} \left( \frac{1}{2} x^2 \right) - 2c_2 x^2 J_{3/4} \left( \frac{1}{2} x^2 \right), \end{aligned}$$

so

$$\begin{aligned} y &= -\frac{2c_1 x^2 J_{-3/4}(\frac{1}{2} x^2) - 2c_2 x^2 J_{3/4}(\frac{1}{2} x^2)}{2x [c_1 J_{1/4}(\frac{1}{2} x^2) + c_2 J_{-1/4}(\frac{1}{2} x^2)]} \\ &= x \frac{-c_1 J_{-3/4}(\frac{1}{2} x^2) + c_2 J_{3/4}(\frac{1}{2} x^2)}{c_1 J_{1/4}(\frac{1}{2} x^2) + c_2 J_{-1/4}(\frac{1}{2} x^2)}. \end{aligned}$$

Letting  $c = c_1/c_2$  we have

$$y = x \frac{J_{3/4}(\frac{1}{2}x^2) - cJ_{-3/4}(\frac{1}{2}x^2)}{cJ_{1/4}(\frac{1}{2}x^2) + J_{-1/4}(\frac{1}{2}x^2)}.$$

19. Let

$$y_2 = \frac{1}{2}x[\ln(1+x) - \ln(1-x)] - 1$$

so that

$$y_2' = \frac{1}{2}x \left[ \frac{1}{1+x} + \frac{1}{1-x} \right] + \frac{1}{2}[\ln(1+x) - \ln(1-x)]$$

and

$$\begin{aligned} y_2'' &= \frac{1}{2}x \left[ -\frac{1}{(1+x)^2} + \frac{1}{(1-x)^2} \right] + \frac{1}{2} \left[ \frac{1}{1+x} + \frac{1}{1-x} \right] + \frac{1}{2} \left[ \frac{1}{1+x} + \frac{1}{1-x} \right] \\ &= \frac{1}{2}x \left[ -\frac{1}{(1+x)^2} + \frac{1}{(1-x)^2} \right] + \frac{1}{1+x} + \frac{1}{1-x}. \end{aligned}$$

Then

$$(1-x)(1+x)y_2'' - 2xy_2' + 2y_2 = 0.$$

20. (a) By the binomial theorem we have

$$\left[1 + (t^2 - 2xt)\right]^{-1/2} = 1 - \frac{1}{2}(t^2 - 2xt) + \frac{3}{8}(t^2 - 2xt)^2 + \dots = 1 + xt + \frac{1}{2}(3x^2 - 1)t^2 + \dots$$

(b) Letting  $x = 1$  in  $(1 - 2xt + t^2)^{-1/2}$ , we have

$$\begin{aligned} (1 - 2t + t^2)^{-1/2} &= (1-t)^{-1} = \frac{1}{1-t} = 1 + t + t^2 + t^3 + \dots \quad (|t| < 1) \\ &= \sum_{n=0}^{\infty} t^n. \end{aligned}$$

From part (a) in the text we have

$$\sum_{n=0}^{\infty} P_n(1)t^n = (1 - 2t + t^2)^{-1/2} = \sum_{n=0}^{\infty} t^n.$$

Equating the coefficients of corresponding terms in the two series, we see that  $P_n(1) = 1$ .

Similarly, letting  $x = -1$  we have

$$\begin{aligned} (1 + 2t + t^2)^{-1/2} &= (1+t)^{-1} = \frac{1}{1+t} = 1 - t + t^2 - 3t^3 + \dots \quad (|t| < 1) \\ &= \sum_{n=0}^{\infty} (-1)^n t^n = \sum_{n=0}^{\infty} P_n(-1)t^n, \end{aligned}$$

so that  $P_n(-1) = (-1)^n$ .

# 7 The Laplace Transform

## Exercises 7.1

1. 
$$\begin{aligned}\mathcal{L}\{f(t)\} &= \int_0^1 -e^{-st} dt + \int_1^\infty e^{-st} dt = \frac{1}{s}e^{-st} \Big|_0^1 - \frac{1}{s}e^{-st} \Big|_1^\infty \\ &= \frac{1}{s}e^{-s} - \frac{1}{s} - \left(0 - \frac{1}{s}e^{-s}\right) = \frac{2}{s}e^{-s} - \frac{1}{s}, \quad s > 0\end{aligned}$$
2. 
$$\mathcal{L}\{f(t)\} = \int_0^2 4e^{-st} dt = -\frac{4}{s}e^{-st} \Big|_0^2 = -\frac{4}{s}(e^{-2s} - 1), \quad s > 0$$
3. 
$$\begin{aligned}\mathcal{L}\{f(t)\} &= \int_0^1 te^{-st} dt + \int_1^\infty e^{-st} dt = \left(-\frac{1}{s}te^{-st} - \frac{1}{s^2}e^{-st}\right) \Big|_0^1 - \frac{1}{s}e^{-st} \Big|_1^\infty \\ &= \left(-\frac{1}{s}e^{-s} - \frac{1}{s^2}e^{-s}\right) - \left(0 - \frac{1}{s^2}\right) - \frac{1}{s}(0 - e^{-s}) = \frac{1}{s^2}(1 - e^{-s}), \quad s > 0\end{aligned}$$
4. 
$$\begin{aligned}\mathcal{L}\{f(t)\} &= \int_0^1 (2t+1)e^{-st} dt = \left(-\frac{2}{s}te^{-st} - \frac{2}{s^2}e^{-st} - \frac{1}{s}e^{-st}\right) \Big|_0^1 \\ &= \left(-\frac{2}{s}e^{-s} - \frac{2}{s^2}e^{-s} - \frac{1}{s}e^{-s}\right) - \left(0 - \frac{2}{s^2} - \frac{1}{s}\right) = \frac{1}{s}(1 - 3e^{-s}) + \frac{2}{s^2}(1 - e^{-s}), \quad s > 0\end{aligned}$$
5. 
$$\begin{aligned}\mathcal{L}\{f(t)\} &= \int_0^\pi (\sin t)e^{-st} dt = \left(-\frac{s}{s^2+1}e^{-st} \sin t - \frac{1}{s^2+1}e^{-st} \cos t\right) \Big|_0^\pi \\ &= \left(0 + \frac{1}{s^2+1}e^{-\pi s}\right) - \left(0 - \frac{1}{s^2+1}\right) = \frac{1}{s^2+1}(e^{-\pi s} + 1), \quad s > 0\end{aligned}$$
6. 
$$\begin{aligned}\mathcal{L}\{f(t)\} &= \int_{\pi/2}^\infty (\cos t)e^{-st} dt = \left(-\frac{s}{s^2+1}e^{-st} \cos t + \frac{1}{s^2+1}e^{-st} \sin t\right) \Big|_{\pi/2}^\infty \\ &= 0 - \left(0 + \frac{1}{s^2+1}e^{-\pi s/2}\right) = -\frac{1}{s^2+1}e^{-\pi s/2}, \quad s > 0\end{aligned}$$
7. 
$$f(t) = \begin{cases} 0, & 0 < t < 1 \\ t, & t > 1 \end{cases}$$
  

$$\mathcal{L}\{f(t)\} = \int_1^\infty te^{-st} dt = \left(-\frac{1}{s}te^{-st} - \frac{1}{s^2}e^{-st}\right) \Big|_1^\infty = \frac{1}{s}e^{-s} + \frac{1}{s^2}e^{-s}, \quad s > 0$$
8. 
$$f(t) = \begin{cases} 0, & 0 < t < 1 \\ 2t - 2, & t > 1 \end{cases}$$
  

$$\mathcal{L}\{f(t)\} = 2 \int_1^\infty (t-1)e^{-st} dt = 2 \left(-\frac{1}{s}(t-1)e^{-st} - \frac{1}{s^2}e^{-st}\right) \Big|_1^\infty = \frac{2}{s^2}e^{-s}, \quad s > 0$$

Exercises 7.1

$$9. f(t) = \begin{cases} 1-t, & 0 < t < 1 \\ 0, & t > 0 \end{cases}$$

$$\mathcal{L}\{f(t)\} = \int_0^1 (1-t)e^{-st} dt = \left( -\frac{1}{s}(1-t)e^{-st} + \frac{1}{s^2}e^{-st} \right) \Big|_0^1 = \frac{1}{s^2}e^{-s} + \frac{1}{s} - \frac{1}{s^2}, \quad s > 0$$

$$10. f(t) = \begin{cases} 0, & 0 < t < a \\ c, & a < t < b; \\ 0, & t > b \end{cases} \quad \mathcal{L}\{f(t)\} = \int_a^b ce^{-st} dt = -\frac{c}{s}e^{-st} \Big|_a^b = \frac{c}{s}(e^{-sa} - e^{-sb}), \quad s > 0$$

$$11. \mathcal{L}\{f(t)\} = \int_0^\infty e^{t+7}e^{-st} dt = e^7 \int_0^\infty e^{(1-s)t} dt = \frac{e^7}{1-s}e^{(1-s)t} \Big|_0^\infty = 0 - \frac{e^7}{1-s} = \frac{e^7}{s-1}, \quad s > 1$$

$$12. \mathcal{L}\{f(t)\} = \int_0^\infty e^{-2t-5}e^{-st} dt = e^{-5} \int_0^\infty e^{-(s+2)t} dt = -\frac{e^{-5}}{s+2}e^{-(s+2)t} \Big|_0^\infty = \frac{e^{-5}}{s+2}, \quad s > -2$$

$$13. \mathcal{L}\{f(t)\} = \int_0^\infty te^{4t}e^{-st} dt = \int_0^\infty te^{(4-s)t} dt = \left( \frac{1}{4-s}te^{(4-s)t} - \frac{1}{(4-s)^2}e^{(4-s)t} \right) \Big|_0^\infty \\ = \frac{1}{(4-s)^2}, \quad s > 4$$

$$14. \mathcal{L}\{f(t)\} = \int_0^\infty t^2 e^{-2t} e^{-st} dt = \int_0^\infty t^2 e^{-(s+2)t} dt \\ = \left( -\frac{1}{s+2}t^2 e^{-(s+2)t} - \frac{2}{(s+2)^2}te^{-(s+2)t} - \frac{2}{(s+2)^3}e^{-(s+2)t} \right) \Big|_0^\infty = \frac{2}{(s+2)^3}, \quad s > -2$$

$$15. \mathcal{L}\{f(t)\} = \int_0^\infty e^{-t}(\sin t)e^{-st} dt = \int_0^\infty (\sin t)e^{-(s+1)t} dt \\ = \left( \frac{-(s+1)}{(s+1)^2+1}e^{-(s+1)t} \sin t - \frac{1}{(s+1)^2+1}e^{-(s+1)t} \cos t \right) \Big|_0^\infty \\ = \frac{1}{(s+1)^2+1} = \frac{1}{s^2+2s+2}, \quad s > -1$$

$$16. \mathcal{L}\{f(t)\} = \int_0^\infty e^t(\cos t)e^{-st} dt = \int_0^\infty (\cos t)e^{(1-s)t} dt \\ = \left( \frac{1-s}{(1-s)^2+1}e^{(1-s)t} \cos t + \frac{1}{(1-s)^2+1}e^{(1-s)t} \sin t \right) \Big|_0^\infty \\ = -\frac{1-s}{(1-s)^2+1} = \frac{s-1}{s^2-2s+2}, \quad s > 1$$

### Exercises 7.1

$$\begin{aligned}
 17. \quad \mathcal{L}\{f(t)\} &= \int_0^{\infty} t(\cos t)e^{-st} dt \\
 &= \left[ \left( -\frac{st}{s^2+1} - \frac{s^2-1}{(s^2+1)^2} \right) (\cos t)e^{-st} + \left( \frac{t}{s^2+1} + \frac{2s}{(s^2+1)^2} \right) (\sin t)e^{-st} \right]_0^{\infty} \\
 &= \frac{s^2-1}{(s^2+1)^2}, \quad s > 0
 \end{aligned}$$

$$\begin{aligned}
 18. \quad \mathcal{L}\{f(t)\} &= \int_0^{\infty} t(\sin t)e^{-st} dt \\
 &= \left[ \left( -\frac{t}{s^2+1} - \frac{2s}{(s^2+1)^2} \right) (\cos t)e^{-st} - \left( \frac{st}{s^2+1} + \frac{s^2-1}{(s^2+1)^2} \right) (\sin t)e^{-st} \right]_0^{\infty} \\
 &= \frac{2s}{(s^2+1)^2}, \quad s > 0
 \end{aligned}$$

$$19. \quad \mathcal{L}\{2t^4\} = 2 \frac{4!}{s^5}$$

$$20. \quad \mathcal{L}\{t^5\} = \frac{5!}{s^6}$$

$$21. \quad \mathcal{L}\{4t - 10\} = \frac{4}{s^2} - \frac{10}{s}$$

$$22. \quad \mathcal{L}\{7t + 3\} = \frac{7}{s^2} + \frac{3}{s}$$

$$23. \quad \mathcal{L}\{t^2 + 6t - 3\} = \frac{2}{s^3} + \frac{6}{s^2} - \frac{3}{s}$$

$$24. \quad \mathcal{L}\{-4t^2 + 16t + 9\} = -4 \frac{2}{s^3} + \frac{16}{s^2} + \frac{9}{s}$$

$$25. \quad \mathcal{L}\{t^3 + 3t^2 + 3t + 1\} = \frac{3!}{s^4} + 3 \frac{2}{s^3} + \frac{3}{s^2} + \frac{1}{s}$$

$$26. \quad \mathcal{L}\{8t^3 - 12t^2 + 6t - 1\} = 8 \frac{3!}{s^4} - 12 \frac{2}{s^3} + \frac{6}{s^2} - \frac{1}{s}$$

$$27. \quad \mathcal{L}\{1 + e^{4t}\} = \frac{1}{s} + \frac{1}{s-4}$$

$$28. \quad \mathcal{L}\{t^2 - e^{-9t} + 5\} = \frac{2}{s^3} - \frac{1}{s+9} + \frac{5}{s}$$

$$29. \quad \mathcal{L}\{1 + 2e^{2t} + e^{4t}\} = \frac{1}{s} + \frac{2}{s-2} + \frac{1}{s-4}$$

$$30. \quad \mathcal{L}\{e^{2t} - 2 + e^{-2t}\} = \frac{1}{s-2} - \frac{2}{s} + \frac{1}{s+2}$$

$$31. \quad \mathcal{L}\{4t^2 - 5 \sin 3t\} = 4 \frac{2}{s^3} - 5 \frac{3}{s^2+9}$$

$$32. \quad \mathcal{L}\{\cos 5t + \sin 2t\} = \frac{s}{s^2+25} + \frac{2}{s^2+4}$$

$$33. \quad \mathcal{L}\{\sinh kt\} = \frac{k}{s^2 - k^2}$$

$$34. \quad \mathcal{L}\{\cosh kt\} = \frac{s}{s^2 - k^2}$$

$$35. \quad \mathcal{L}\{e^t \sinh t\} = \mathcal{L}\left\{e^t \frac{e^t - e^{-t}}{2}\right\} = \mathcal{L}\left\{\frac{1}{2}e^{2t} - \frac{1}{2}\right\} = \frac{1}{2(s-2)} - \frac{1}{2s}$$

$$36. \quad \mathcal{L}\{e^{-t} \cosh t\} = \mathcal{L}\left\{e^{-t} \frac{e^t + e^{-t}}{2}\right\} = \mathcal{L}\left\{\frac{1}{2} + \frac{1}{2}e^{-2t}\right\} = \frac{1}{2s} + \frac{1}{2(s+2)}$$

$$37. \quad \mathcal{L}\{\sin 2t \cos 2t\} = \mathcal{L}\left\{\frac{1}{2} \sin 4t\right\} = \frac{2}{s^2+16}$$

$$38. \mathcal{L}\{\cos^2 t\} = \mathcal{L}\left\{\frac{1}{2} + \frac{1}{2}\cos 2t\right\} = \frac{1}{2s} + \frac{1}{2}\frac{s}{s^2+4}$$

39. (a) Using integration by parts for  $\alpha > 0$ ,

$$\Gamma(\alpha + 1) = \int_0^\infty t^\alpha e^{-t} dt = -t^\alpha e^{-t} \Big|_0^\infty + \alpha \int_0^\infty t^{\alpha-1} e^{-t} dt = \alpha \Gamma(\alpha).$$

(b) Let  $u = st$  so that  $du = s dt$ . Then

$$\mathcal{L}\{t^\alpha\} = \int_0^\infty e^{-st} t^\alpha dt = \int_0^\infty e^{-u} \left(\frac{u}{s}\right)^\alpha \frac{1}{s} du = \frac{1}{s^{\alpha+1}} \Gamma(\alpha + 1), \quad \alpha > -1.$$

$$40. (a) \mathcal{L}\{t^{-1/2}\} = \frac{\Gamma(1/2)}{s^{1/2}} = \sqrt{\frac{\pi}{s}}$$

$$(b) \mathcal{L}\{t^{1/2}\} = \frac{\Gamma(3/2)}{s^{3/2}} = \frac{\sqrt{\pi}}{2s^{3/2}}$$

$$(c) \mathcal{L}\{t^{3/2}\} = \frac{\Gamma(5/2)}{s^{5/2}} = \frac{3\sqrt{\pi}}{4s^{5/2}}$$

41. Identifying  $f(t) = t^n$  we have  $f'(t) = nt^{n-1}$ ,  $n = 1, 2, 3, \dots$ . Then, since  $f(0) = 0$ ,

$$n \mathcal{L}\{t^{n-1}\} = \mathcal{L}\{nt^{n-1}\} = s \mathcal{L}\{t^n\} \quad \text{and} \quad \mathcal{L}\{t^n\} = \frac{n}{s} \mathcal{L}\{t^{n-1}\}.$$

$$\text{For } n = 1, \quad \mathcal{L}\{t\} = \frac{1}{s} \mathcal{L}\{1\} = \frac{1}{s^2}.$$

$$\text{For } n = 2, \quad \mathcal{L}\{t^2\} = \frac{2}{s} \mathcal{L}\{t\} = \frac{2}{s^3}.$$

$$\text{For } n = 3, \quad \mathcal{L}\{t^3\} = \frac{3}{s} \mathcal{L}\{t^2\} = \frac{6}{s^4}.$$

42. Let  $F(t) = t^{1/3}$ . Then  $F(t)$  is of exponential order, but  $f(t) = F'(t) = \frac{1}{3}t^{-2/3}$  is unbounded near  $t = 0$  and hence is not of exponential order.

### Exercises 7.1

Let  $f(t) = 2te^{t^2} \cos e^{t^2} = \frac{d}{dt} \sin e^{t^2}$ . This function is not of exponential order, but we can show that its Laplace transform exists. Using integration by parts we have

$$\begin{aligned} \mathcal{L}\{2te^{t^2} \cos e^{t^2}\} &= \int_0^\infty e^{-st} \left( \frac{d}{dt} \sin e^{t^2} \right) dt = \lim_{a \rightarrow \infty} \left[ e^{-st} \sin e^{t^2} \Big|_0^a + s \int_0^a e^{-st} \sin e^{t^2} dt \right] \\ &= s \int_0^\infty e^{-st} \sin e^{t^2} dt = s \mathcal{L}\{\sin e^{t^2}\}. \end{aligned}$$

Since  $\sin e^{t^2}$  is continuous and of exponential order,  $\mathcal{L}\{\sin e^{t^2}\}$  exists, and therefore  $\mathcal{L}\{2te^{t^2} \cos e^{t^2}\}$  exists.

43. The relation will be valid when  $s$  is greater than the maximum of  $c_1$  and  $c_2$ .
44. Since  $e^t$  is an increasing function and  $t^2 > \ln M + ct$  for  $M > 0$  we have  $e^{t^2} > e^{\ln M + ct} = Me^{ct}$  for  $t$  sufficiently large and for any  $c$ . Thus,  $e^{t^2}$  is not of exponential order.
45. By part (c) of Theorem 7.1

$$\mathcal{L}\{e^{(a+ib)t}\} = \frac{1}{s - (a+ib)} = \frac{1}{(s-a) - ib} \frac{(s-a) + ib}{(s-a) + ib} = \frac{s-a+ib}{(s-a)^2 + b^2}.$$

By Euler's formula,  $e^{i\theta} = \cos \theta + i \sin \theta$ , so

$$\begin{aligned} \mathcal{L}\{e^{(a+ib)t}\} &= \mathcal{L}\{e^{at}e^{ibt}\} = \mathcal{L}\{e^{at}(\cos bt + i \sin bt)\} \\ &= \mathcal{L}\{e^{at} \cos bt\} + i \mathcal{L}\{e^{at} \sin bt\} \\ &= \frac{s-a}{(s-a)^2 + b^2} + i \frac{b}{(s-a)^2 + b^2}. \end{aligned}$$

Equating real and imaginary parts we get

$$\mathcal{L}\{e^{at} \cos bt\} = \frac{s-a}{(s-a)^2 + b^2} \quad \text{and} \quad \mathcal{L}\{e^{at} \sin bt\} = \frac{b}{(s-a)^2 + b^2}.$$

46. We want  $f(\alpha x + \beta y) = \alpha f(x) + \beta f(y)$  or

$$m(\alpha x + \beta y) + b = \alpha(mx + b) + \beta(my + b) = m(\alpha x + \beta y) + (\alpha + \beta)b$$

for all real numbers  $\alpha$  and  $\beta$ . Taking  $\alpha = \beta = 1$  we see that  $b = 2b$ , so  $b = 0$ . Thus,  $f(x) = mx + b$  will be a linear transformation when  $b = 0$ .



---

**Exercises 7.2**

---

1.  $\mathcal{L}^{-1}\left\{\frac{1}{s^3}\right\} = \frac{1}{2}\mathcal{L}^{-1}\left\{\frac{2}{s^3}\right\} = \frac{1}{2}t^2$
2.  $\mathcal{L}^{-1}\left\{\frac{1}{s^4}\right\} = \frac{1}{6}\mathcal{L}^{-1}\left\{\frac{3!}{s^4}\right\} = \frac{1}{6}t^3$
3.  $\mathcal{L}^{-1}\left\{\frac{1}{s^2} - \frac{48}{s^5}\right\} = \mathcal{L}^{-1}\left\{\frac{1}{s^2} - \frac{48}{24} \cdot \frac{4!}{s^5}\right\} = t - 2t^4$
4.  $\mathcal{L}^{-1}\left\{\left(\frac{2}{s} - \frac{1}{s^3}\right)^2\right\} = \mathcal{L}^{-1}\left\{4 \cdot \frac{1}{s^2} - \frac{4}{6} \cdot \frac{3!}{s^4} + \frac{1}{120} \cdot \frac{5!}{s^6}\right\} = 4t - \frac{2}{3}t^3 + \frac{1}{120}t^5$
5.  $\mathcal{L}^{-1}\left\{\frac{(s+1)^3}{s^4}\right\} = \mathcal{L}^{-1}\left\{\frac{1}{s} + 3 \cdot \frac{1}{s^2} + \frac{3}{2} \cdot \frac{2}{s^3} + \frac{1}{6} \cdot \frac{3!}{s^4}\right\} = 1 + 3t + \frac{3}{2}t^2 + \frac{1}{6}t^3$
6.  $\mathcal{L}^{-1}\left\{\frac{(s+2)^2}{s^3}\right\} = \mathcal{L}^{-1}\left\{\frac{1}{s} + 4 \cdot \frac{1}{s^2} + 2 \cdot \frac{2}{s^3}\right\} = 1 + 4t + 2t^2$
7.  $\mathcal{L}^{-1}\left\{\frac{1}{s^2} - \frac{1}{s} + \frac{1}{s-2}\right\} = t - 1 + e^{2t}$
8.  $\mathcal{L}^{-1}\left\{\frac{4}{s} + \frac{6}{s^5} - \frac{1}{s+8}\right\} = \mathcal{L}^{-1}\left\{4 \cdot \frac{1}{s} + \frac{1}{4} \cdot \frac{4!}{s^5} - \frac{1}{s+8}\right\} = 4 + \frac{1}{4}t^4 - e^{-8t}$
9.  $\mathcal{L}^{-1}\left\{\frac{1}{4s+1}\right\} = \mathcal{L}^{-1}\left\{\frac{1}{4} \cdot \frac{1}{s+1/4}\right\} = \frac{1}{4}e^{-t/4}$
10.  $\mathcal{L}^{-1}\left\{\frac{1}{5s-2}\right\} = \mathcal{L}^{-1}\left\{\frac{1}{5} \cdot \frac{1}{s-2/5}\right\} = \frac{1}{5}e^{2t/5}$
11.  $\mathcal{L}^{-1}\left\{\frac{5}{s^2+49}\right\} = \mathcal{L}^{-1}\left\{\frac{5}{7} \cdot \frac{7}{s^2+49}\right\} = \frac{5}{7}\sin 7t$
12.  $\mathcal{L}^{-1}\left\{\frac{10s}{s^2+16}\right\} = 10\cos 4t$
13.  $\mathcal{L}^{-1}\left\{\frac{4s}{4s^2+1}\right\} = \mathcal{L}^{-1}\left\{\frac{s}{s^2+1/4}\right\} = \cos \frac{1}{2}t$
14.  $\mathcal{L}^{-1}\left\{\frac{1}{4s^2+1}\right\} = \mathcal{L}^{-1}\left\{\frac{1}{2} \cdot \frac{1/2}{s^2+1/4}\right\} = \frac{1}{2}\sin \frac{1}{2}t$
15.  $\mathcal{L}^{-1}\left\{\frac{2s-6}{s^2+9}\right\} = \mathcal{L}^{-1}\left\{2 \cdot \frac{s}{s^2+9} - 2 \cdot \frac{3}{s^2+9}\right\} = 2\cos 3t - 2\sin 3t$

### Exercises 7.2

16.  $\mathcal{L}^{-1}\left\{\frac{s+1}{s^2+2}\right\} = \mathcal{L}^{-1}\left\{\frac{s}{s^2+2} + \frac{1}{\sqrt{2}} \cdot \frac{\sqrt{2}}{s^2+2}\right\} = \cos \sqrt{2}t + \frac{\sqrt{2}}{2} \sin \sqrt{2}t$
17.  $\mathcal{L}^{-1}\left\{\frac{1}{s^2+3s}\right\} = \mathcal{L}^{-1}\left\{\frac{1}{3} \cdot \frac{1}{s} - \frac{1}{3} \cdot \frac{1}{s+3}\right\} = \frac{1}{3} - \frac{1}{3}e^{-3t}$
18.  $\mathcal{L}^{-1}\left\{\frac{s+1}{s^2-4s}\right\} = \mathcal{L}^{-1}\left\{-\frac{1}{4} \cdot \frac{1}{s} + \frac{5}{4} \cdot \frac{1}{s-4}\right\} = -\frac{1}{4} + \frac{5}{4}e^{4t}$
19.  $\mathcal{L}^{-1}\left\{\frac{s}{s^2+2s-3}\right\} = \mathcal{L}^{-1}\left\{\frac{1}{4} \cdot \frac{1}{s-1} + \frac{3}{4} \cdot \frac{1}{s+3}\right\} = \frac{1}{4}e^t + \frac{3}{4}e^{-3t}$
20.  $\mathcal{L}^{-1}\left\{\frac{1}{s^2+s-20}\right\} = \mathcal{L}^{-1}\left\{\frac{1}{9} \cdot \frac{1}{s-4} - \frac{1}{9} \cdot \frac{1}{s+5}\right\} = \frac{1}{9}e^{4t} - \frac{1}{9}e^{-5t}$
21.  $\mathcal{L}^{-1}\left\{\frac{0.9s}{(s-0.1)(s+0.2)}\right\} = \mathcal{L}^{-1}\left\{(0.3) \cdot \frac{1}{s-0.1} + (0.6) \cdot \frac{1}{s+0.2}\right\} = 0.3e^{0.1t} + 0.6e^{-0.2t}$
22.  $\mathcal{L}^{-1}\left\{\frac{s-3}{(s-\sqrt{3})(s+\sqrt{3})}\right\} = \mathcal{L}^{-1}\left\{\frac{s}{s^2-3} - \sqrt{3} \cdot \frac{\sqrt{3}}{s^2-3}\right\} = \cosh \sqrt{3}t - \sqrt{3} \sinh \sqrt{3}t$
23.  $\mathcal{L}^{-1}\left\{\frac{s}{(s-2)(s-3)(s-6)}\right\} = \mathcal{L}^{-1}\left\{\frac{1}{2} \cdot \frac{1}{s-2} - \frac{1}{s-3} + \frac{1}{2} \cdot \frac{1}{s-6}\right\} = \frac{1}{2}e^{2t} - e^{3t} + \frac{1}{2}e^{6t}$
24.  $\mathcal{L}^{-1}\left\{\frac{s^2+1}{s(s-1)(s+1)(s-2)}\right\} = \mathcal{L}^{-1}\left\{\frac{1}{2} \cdot \frac{1}{s} - \frac{1}{s-1} - \frac{1}{3} \cdot \frac{1}{s+1} + \frac{5}{6} \cdot \frac{1}{s-2}\right\}$   
 $= \frac{1}{2} - e^t - \frac{1}{3}e^{-t} + \frac{5}{6}e^{2t}$
25.  $\mathcal{L}^{-1}\left\{\frac{1}{s^3+5s}\right\} = \mathcal{L}^{-1}\left\{\frac{1}{s(s^2+5)}\right\} = \mathcal{L}^{-1}\left\{\frac{1}{5} \cdot \frac{1}{s} - \frac{1}{5} \cdot \frac{s}{s^2+5}\right\} = \frac{1}{5} - \frac{1}{5} \cos \sqrt{5}t$
26.  $\mathcal{L}^{-1}\left\{\frac{s}{(s^2+4)(s+2)}\right\} = \mathcal{L}^{-1}\left\{\frac{1}{4} \cdot \frac{s}{s^2+4} + \frac{1}{4} \cdot \frac{2}{s^2+4} - \frac{1}{4} \cdot \frac{1}{s+2}\right\} = \frac{1}{4} \cos 2t + \frac{1}{4} \sin 2t - \frac{1}{4}e^{-2t}$
27.  $\mathcal{L}^{-1}\left\{\frac{2s-4}{(s^2+s)(s^2+1)}\right\} = \mathcal{L}^{-1}\left\{\frac{2s-4}{s(s^2+1)^2}\right\} = \mathcal{L}^{-1}\left\{-\frac{4}{s} + \frac{3}{s+1} + \frac{s}{s^2+1} + \frac{3}{s^2+1}\right\}$   
 $= -4 + 3e^{-t} + \cos t + 3 \sin t$
28.  $\mathcal{L}^{-1}\left\{\frac{1}{s^4-9}\right\} = \mathcal{L}^{-1}\left\{\frac{1}{6\sqrt{3}} \cdot \frac{\sqrt{3}}{s^2-3} - \frac{1}{6\sqrt{3}} \cdot \frac{\sqrt{3}}{s^2-3}\right\} = \frac{1}{6\sqrt{3}} \sinh \sqrt{3}t - \frac{1}{6\sqrt{3}} \sin \sqrt{3}t$
29.  $\mathcal{L}^{-1}\left\{\frac{s}{(s^2+4)(s+2)}\right\} = \mathcal{L}^{-1}\left\{\frac{1}{4} \cdot \frac{s}{s^2+4} + \frac{1}{4} \cdot \frac{2}{s^2+4} - \frac{1}{4} \cdot \frac{1}{s+2}\right\} = \frac{1}{4} \cos 2t + \frac{1}{4} \sin 2t - \frac{1}{4}e^{-2t}$

$$30. \quad \mathcal{L}^{-1}\left\{\frac{6s+3}{(s^2+1)(s^2+4)}\right\} = \mathcal{L}^{-1}\left\{2 \cdot \frac{s}{s^2+1} + \frac{1}{s^2+1} - 2 \cdot \frac{s}{s^2+4} - \frac{1}{2} \cdot \frac{2}{s^2+4}\right\}$$

$$= 2 \cos t + \sin t - 2 \cos 2t - \frac{1}{2} \sin 2t$$

31. The Laplace transform of the differential equation is

$$s\mathcal{L}\{y\} - y(0) - \mathcal{L}\{y\} = \frac{1}{s}.$$

Solving for  $\mathcal{L}\{y\}$  we obtain

$$\mathcal{L}\{y\} = -\frac{1}{s} + \frac{1}{s-1}.$$

Thus

$$y = -1 + e^t.$$

32. The Laplace transform of the differential equation is

$$2s\mathcal{L}\{y\} - 2y(0) = \mathcal{L}\{y\} = 0.$$

Solving for  $\mathcal{L}\{y\}$  we obtain

$$\mathcal{L}\{y\} = \frac{6}{2s+1} = \frac{3}{s+1/2}.$$

Thus

$$y = 3e^{-t/2}.$$

33. The Laplace transform of the differential equation is

$$s\mathcal{L}\{y\} - y(0) + 6\mathcal{L}\{y\} = \frac{1}{s-4}.$$

Solving for  $\mathcal{L}\{y\}$  we obtain

$$\mathcal{L}\{y\} = \frac{1}{(s-4)(s+6)} + \frac{2}{s+6} = \frac{1}{10} \cdot \frac{1}{s-4} + \frac{19}{10} \cdot \frac{1}{s+6}.$$

Thus

$$y = \frac{1}{10}e^{4t} + \frac{19}{10}e^{-6t}.$$

34. The Laplace transform of the differential equation is

$$s\mathcal{L}\{y\} - \mathcal{L}\{y\} = \frac{2s}{s^2+25}.$$

Solving for  $\mathcal{L}\{y\}$  we obtain

$$\mathcal{L}\{y\} = \frac{2}{(s-1)(s^2+25)} = \frac{1}{13} \cdot \frac{1}{s-1} - \frac{1}{13} \cdot \frac{s}{s^2+25} + \frac{5}{13} \cdot \frac{5}{s^2+25}.$$

Thus

$$y = \frac{1}{13}e^t - \frac{1}{13} \cos 5t + \frac{5}{13} \sin 5t.$$

## Exercises 7.2

35. The Laplace transform of the differential equation is

$$s^2 \mathcal{L}\{y\} - sy(0) - y'(0) + 5[s \mathcal{L}\{y\} - y(0)] + 4 \mathcal{L}\{y\} = 0.$$

Solving for  $\mathcal{L}\{y\}$  we obtain

$$\mathcal{L}\{y\} = \frac{s+5}{s^2+5s+4} = \frac{4}{3} \frac{1}{s+1} - \frac{1}{3} \frac{1}{s+4}.$$

Thus

$$y = \frac{4}{3}e^{-t} - \frac{1}{3}e^{-4t}.$$

36. The Laplace transform of the differential equation is

$$s^2 \mathcal{L}\{y\} - sy(0) - y'(0) - 4[s \mathcal{L}\{y\} - y(0)] = \frac{6}{s-3} - \frac{3}{s+1}.$$

Solving for  $\mathcal{L}\{y\}$  we obtain

$$\begin{aligned} \mathcal{L}\{y\} &= \frac{6}{(s-3)(s^2-4s)} - \frac{3}{(s+1)(s^2-4s)} + \frac{s-5}{s^2-4s} \\ &= \frac{5}{2} \cdot \frac{1}{s} - \frac{2}{s-3} - \frac{3}{5} \cdot \frac{1}{s+1} + \frac{11}{10} \cdot \frac{1}{s-4}. \end{aligned}$$

Thus

$$y = \frac{5}{2} - 2e^{3t} - \frac{3}{5}e^{-t} + \frac{11}{10}e^{4t}.$$

37. The Laplace transform of the differential equation is

$$s^2 \mathcal{L}\{y\} - sy(0) + \mathcal{L}\{y\} = \frac{2}{s^2+2}.$$

Solving for  $\mathcal{L}\{y\}$  we obtain

$$\mathcal{L}\{y\} = \frac{2}{(s^2+1)(s^2+2)} + \frac{10s}{s^2+1} = \frac{10s}{s^2+1} + \frac{2}{s^2+1} - \frac{2}{s^2+2}.$$

Thus

$$y = 10 \cos t + 2 \sin t - \sqrt{2} \sin \sqrt{2}t.$$

38. The Laplace transform of the differential equation is

$$s^2 \mathcal{L}\{y\} + 9 \mathcal{L}\{y\} = \frac{1}{s-1}.$$

Solving for  $\mathcal{L}\{y\}$  we obtain

$$\mathcal{L}\{y\} = \frac{1}{(s-1)(s^2+9)} = \frac{1}{10} \cdot \frac{1}{s-1} - \frac{1}{10} \cdot \frac{1}{s^2+9} - \frac{1}{10} \cdot \frac{s}{s^2+9}.$$

Thus

$$y = \frac{1}{10}e^t - \frac{1}{30} \sin 3t - \frac{1}{10} \cos 3t.$$

39. The Laplace transform of the differential equation is

$$2[s^3 \mathcal{L}\{y\} - s^2(0) - sy'(0) - y''(0)] + 3[s^2 \mathcal{L}\{y\} - sy(0) - y'(0)] - 3[s \mathcal{L}\{y\} - y(0)] - 2 \mathcal{L}\{y\} = \frac{1}{s+1}.$$

Solving for  $\mathcal{L}\{y\}$  we obtain

$$\mathcal{L}\{y\} = \frac{2s+3}{(s+1)(s-1)(2s+1)(s+2)} = \frac{1}{2} \cdot \frac{1}{s+1} + \frac{5}{18} \cdot \frac{1}{s-1} - \frac{8}{9} \cdot \frac{1}{s+1/2} + \frac{1}{9} \cdot \frac{1}{s+2}.$$

Thus

$$y = \frac{1}{2}e^{-t} + \frac{5}{18}e^t - \frac{8}{9}e^{-t/2} + \frac{1}{9}e^{-2t}.$$

40. The Laplace transform of the differential equation is

$$s^3 \mathcal{L}\{y\} - s^2(0) - sy'(0) - y''(0) + 2[s^2 \mathcal{L}\{y\} - sy(0) - y'(0)] - [s \mathcal{L}\{y\} - y(0)] - 2 \mathcal{L}\{y\} = \frac{3}{s^2+9}.$$

Solving for  $\mathcal{L}\{y\}$  we obtain

$$\begin{aligned} \mathcal{L}\{y\} &= \frac{s^2+12}{(s-1)(s+1)(s+2)(s^2+9)} \\ &= \frac{13}{60} \cdot \frac{1}{s-1} - \frac{13}{20} \cdot \frac{1}{s+1} + \frac{16}{39} \cdot \frac{1}{s+2} + \frac{3}{130} \cdot \frac{s}{s^2+9} - \frac{1}{65} \cdot \frac{3}{s^2+9}. \end{aligned}$$

Thus

$$y = \frac{13}{60}e^t - \frac{13}{20}e^{-t} + \frac{16}{39}e^{-2t} + \frac{3}{130} \cos 3t - \frac{1}{65} \sin 3t.$$

41. Let  $f(t) = 1$  and  $g(t) = \begin{cases} 1, & t \geq 0, t \neq 1 \\ 0, & t = 1 \end{cases}$ . Then  $\mathcal{L}\{f(t)\} = \mathcal{L}\{g(t)\} = 1/s$ , but  $f(t) \neq g(t)$ .

42. The Laplace transform of the differential equation is

$$s \mathcal{L}\{y\} + \mathcal{L}\{y\} = \frac{s+3}{(s+3)^2+4} = \frac{s+3}{s^2+6s+13}.$$

Solving for  $\mathcal{L}\{y\}$  we obtain

$$\begin{aligned} \mathcal{L}\{y\} &= \frac{s+3}{(s+1)(s^2+6s+13)} = \frac{1}{4} \cdot \frac{1}{s+1} - \frac{1}{4} \cdot \frac{s+1}{s^2+6s+13} \\ &= \frac{1}{4} \cdot \frac{1}{s+1} - \frac{1}{4} \left( \frac{s+3}{(s+3)^2+4} - \frac{2}{(s+3)^2+4} \right). \end{aligned}$$

Thus

$$y = \frac{1}{4}e^{-t} - e^{-3t} \cos 2t + \frac{1}{4}e^{-3t} \sin 2t.$$

43. For  $y'' - 4y' = 6e^{3t} - 3e^{-t}$  the transfer function is  $W(s) = 1/(s^2 - 4s)$ . The zero-input response is

$$y_0(t) = \mathcal{L}^{-1} \left\{ \frac{s-5}{s^2-4s} \right\} = \mathcal{L}^{-1} \left\{ \frac{5}{4} \cdot \frac{1}{s} - \frac{1}{4} \cdot \frac{1}{s-4} \right\} = \frac{5}{4} - \frac{1}{4}e^{4t},$$

## Exercises 7.2

and the zero-state response is

$$\begin{aligned} y_1(t) &= \mathcal{L}^{-1} \left\{ \frac{6}{(s-3)(s^2-4s)} - \frac{3}{(s+1)(s^2-4s)} \right\} \\ &= \mathcal{L}^{-1} \left\{ \frac{27}{20} \cdot \frac{1}{s-4} - \frac{2}{s-3} + \frac{5}{4} \cdot \frac{1}{s} - \frac{3}{5} \cdot \frac{1}{s+1} \right\} \\ &= \frac{27}{20} e^{4t} - 2e^{3t} + \frac{5}{4} - \frac{3}{5} e^{-t}. \end{aligned}$$

---

## Exercises 7.3

---

1.  $\mathcal{L}\{te^{10t}\} = \frac{1}{(s-10)^2}$
2.  $\mathcal{L}\{te^{-6t}\} = \frac{1}{(s+6)^2}$
3.  $\mathcal{L}\{t^3e^{-2t}\} = \frac{3!}{(s+2)^4}$
4.  $\mathcal{L}\{t^{10}e^{-7t}\} = \frac{10!}{(s+7)^{11}}$
5.  $\mathcal{L}\{t(e^t + e^{2t})^2\} = \mathcal{L}\{te^{2t} + 2te^{3t} + te^{4t}\} = \frac{1}{(s-2)^2} + \frac{2}{(s-3)^2} + \frac{1}{(s-4)^2}$
6.  $\mathcal{L}\{e^{2t}(t-1)^2\} = \mathcal{L}\{t^2e^{2t} - 2te^{2t} + e^{2t}\} = \frac{2}{(s-2)^3} - \frac{2}{(s-2)^2} + \frac{1}{s-2}$
7.  $\mathcal{L}\{e^t \sin 3t\} = \frac{3}{(s-1)^2 + 9}$
8.  $\mathcal{L}\{e^{-2t} \cos 4t\} = \frac{s+2}{(s+2)^2 + 16}$
9.  $\mathcal{L}\{(1 - e^t + 3e^{-4t}) \cos 5t\} = \mathcal{L}\{\cos 5t - e^t \cos 5t + 3e^{-4t} \cos 5t\}$   

$$= \frac{s}{s^2 + 25} - \frac{s-1}{(s-1)^2 + 25} + \frac{3(s+4)}{(s+4)^2 + 25}$$
10.  $\mathcal{L}\left\{e^{3t}\left(9 - 4t + 10 \sin \frac{t}{2}\right)\right\} = \mathcal{L}\left\{9e^{3t} - 4te^{3t} + 10e^{3t} \sin \frac{t}{2}\right\} = \frac{9}{s-3} - \frac{4}{(s-3)^2} + \frac{5}{(s-3)^2 + 1/4}$
11.  $\mathcal{L}^{-1}\left\{\frac{1}{(s+2)^3}\right\} = \mathcal{L}^{-1}\left\{\frac{1}{2} \frac{2}{(s+2)^3}\right\} = \frac{1}{2} t^2 e^{-2t}$

12.  $\mathcal{L}^{-1}\left\{\frac{1}{(s-1)^4}\right\} = \mathcal{L}^{-1}\left\{\frac{1}{6} \frac{3!}{(s-1)^4}\right\} = \frac{1}{6}t^3e^t$
13.  $\mathcal{L}^{-1}\left\{\frac{1}{s^2-6s+10}\right\} = \mathcal{L}^{-1}\left\{\frac{1}{(s-3)^2+1^2}\right\} = e^{3t}\sin t$
14.  $\mathcal{L}^{-1}\left\{\frac{1}{s^2+2s+5}\right\} = \mathcal{L}^{-1}\left\{\frac{1}{2} \frac{2}{(s+1)^2+2^2}\right\} = \frac{1}{2}e^{-t}\sin 2t$
15.  $\mathcal{L}^{-1}\left\{\frac{s}{s^2+4s+5}\right\} = \mathcal{L}^{-1}\left\{\frac{(s+2)}{(s+2)^2+1^2} - 2\frac{1}{(s+2)^2+1^2}\right\} = e^{-2t}\cos t - 2e^{-2t}\sin t$
16.  $\mathcal{L}^{-1}\left\{\frac{2s+5}{s^2+6s+34}\right\} = \mathcal{L}^{-1}\left\{2\frac{(s+3)}{(s+3)^2+5^2} - \frac{1}{5}\frac{5}{(s+3)^2+5^2}\right\} = 2e^{-3t}\cos 5t - \frac{1}{5}e^{-3t}\sin 5t$
17.  $\mathcal{L}^{-1}\left\{\frac{s}{(s+1)^2}\right\} = \mathcal{L}^{-1}\left\{\frac{s+1-1}{(s+1)^2}\right\} = \mathcal{L}^{-1}\left\{\frac{1}{s+1} - \frac{1}{(s+1)^2}\right\} = e^{-t} - te^{-t}$
18.  $\mathcal{L}^{-1}\left\{\frac{5s}{(s-2)^2}\right\} = \mathcal{L}^{-1}\left\{\frac{5(s-2)+10}{(s-2)^2}\right\} = \mathcal{L}^{-1}\left\{\frac{5}{s-2} + \frac{10}{(s-2)^2}\right\} = 5e^{2t} + 10te^{2t}$
19.  $\mathcal{L}^{-1}\left\{\frac{2s-1}{s^2(s+1)^3}\right\} = \mathcal{L}^{-1}\left\{\frac{5}{s} - \frac{1}{s^2} - \frac{5}{s+1} - \frac{4}{(s+1)^2} - \frac{3}{2}\frac{2}{(s+1)^3}\right\} = 5-t-5e^{-t}-4te^{-t}-\frac{3}{2}t^2e^{-t}$
20.  $\mathcal{L}^{-1}\left\{\frac{(s+1)^2}{(s+2)^4}\right\} = \mathcal{L}^{-1}\left\{\frac{1}{(s+2)^2} - \frac{2}{(s+2)^3} + \frac{1}{6}\frac{3!}{(s+2)^4}\right\} = te^{-2t} - t^2e^{-2t} + \frac{1}{6}t^3e^{-2t}$

21. The Laplace transform of the differential equation is

$$s\mathcal{L}\{y\} - y(0) + 4\mathcal{L}\{y\} = \frac{1}{s+4}.$$

Solving for  $\mathcal{L}\{y\}$  we obtain  $\mathcal{L}\{y\} = \frac{1}{(s+4)^2} + \frac{2}{s+4}$ . Thus

$$y = te^{-4t} + 2e^{-4t}.$$

22. The Laplace transform of the differential equation is

$$s\mathcal{L}\{y\} - \mathcal{L}\{y\} = \frac{1}{s} + \frac{1}{(s-1)^2}.$$

Solving for  $\mathcal{L}\{y\}$  we obtain

$$\mathcal{L}\{y\} = \frac{1}{s(s-1)} + \frac{1}{(s-1)^3} = -\frac{1}{s} + \frac{1}{s-1} + \frac{1}{(s-1)^3}.$$

Thus

$$y = -1 + e^t + \frac{1}{2}t^2e^t.$$

### Exercises 7.3

23. The Laplace transform of the differential equation is

$$s^2 \mathcal{L}\{y\} - sy(0) - y'(0) + 2[s \mathcal{L}\{y\} - y(0)] + \mathcal{L}\{y\} = 0.$$

Solving for  $\mathcal{L}\{y\}$  we obtain

$$\mathcal{L}\{y\} = \frac{s+3}{(s+1)^2} = \frac{1}{s+1} + \frac{2}{(s+1)^2}.$$

Thus

$$y = e^{-t} + 2te^{-t}.$$

24. The Laplace transform of the differential equation is

$$s^2 \mathcal{L}\{y\} - sy(0) - y'(0) - 4[s \mathcal{L}\{y\} - y(0)] + 4 \mathcal{L}\{y\} = \frac{6}{(s-2)^4}.$$

Solving for  $\mathcal{L}\{y\}$  we obtain  $\mathcal{L}\{y\} = \frac{1}{20} \frac{5!}{(s-2)^6}$ . Thus,  $y = \frac{1}{20} t^5 e^{2t}$ .

25. The Laplace transform of the differential equation is

$$s^2 \mathcal{L}\{y\} - sy(0) - y'(0) - 6[s \mathcal{L}\{y\} - y(0)] + 9 \mathcal{L}\{y\} = \frac{1}{s^2}.$$

Solving for  $\mathcal{L}\{y\}$  we obtain

$$\mathcal{L}\{y\} = \frac{1+s^2}{s^2(s-3)^2} = \frac{2}{27} \frac{1}{s} + \frac{1}{9} \frac{1}{s^2} - \frac{2}{27} \frac{1}{s-3} + \frac{10}{9} \frac{1}{(s-3)^2}.$$

Thus

$$y = \frac{2}{27} + \frac{1}{9}t - \frac{2}{27}e^{3t} + \frac{10}{9}te^{3t}.$$

26. The Laplace transform of the differential equation is

$$s^2 \mathcal{L}\{y\} - sy(0) - y'(0) - 4[s \mathcal{L}\{y\} - y(0)] + 4 \mathcal{L}\{y\} = \frac{6}{s^4}.$$

Solving for  $\mathcal{L}\{y\}$  we obtain

$$\mathcal{L}\{y\} = \frac{s^5 - 4s^4 + 6}{s^4(s-2)^2} = \frac{3}{4} \frac{1}{s} + \frac{9}{8} \frac{1}{s^2} + \frac{3}{4} \frac{2}{s^3} + \frac{1}{4} \frac{3!}{s^4} + \frac{1}{4} \frac{1}{s-2} - \frac{13}{8} \frac{1}{(s-2)^2}.$$

Thus

$$y = \frac{3}{4} + \frac{9}{8}t + \frac{3}{4}t^2 + \frac{1}{4}t^3 + \frac{1}{4}e^{2t} - \frac{13}{8}te^{2t}.$$

27. The Laplace transform of the differential equation is

$$s^2 \mathcal{L}\{y\} - sy(0) - y'(0) - 6[s \mathcal{L}\{y\} - y(0)] + 13 \mathcal{L}\{y\} = 0.$$

Solving for  $\mathcal{L}\{y\}$  we obtain

$$\mathcal{L}\{y\} = -\frac{3}{s^2 - 6s + 13} = -\frac{3}{2} \frac{2}{(s-3)^2 + 2^2}.$$



Thus

$$y = -\frac{3}{2}e^{3t} \sin 2t.$$

28. The Laplace transform of the differential equation is

$$2[s^2 \mathcal{L}\{y\} - sy(0)] + 20[s \mathcal{L}\{y\} - y(0)] + 51 \mathcal{L}\{y\} = 0.$$

Solving for  $\mathcal{L}\{y\}$  we obtain

$$\mathcal{L}\{y\} = \frac{4s + 40}{2s^2 + 20s + 51} = \frac{2s + 20}{(s + 5)^2 + 1/2} = \frac{2(s + 5)}{(s + 5)^2 + 1/2} + \frac{10}{(s + 5)^2 + 1/2}.$$

Thus

$$y = 2e^{-5t} \cos(t/\sqrt{2}) + 10\sqrt{2}e^{-5t} \sin(t/\sqrt{2}).$$

29. The Laplace transform of the differential equation is

$$s^2 \mathcal{L}\{y\} - sy(0) - y'(0) - [s \mathcal{L}\{y\} - y(0)] = \frac{s - 1}{(s - 1)^2 + 1}.$$

Solving for  $\mathcal{L}\{y\}$  we obtain

$$\mathcal{L}\{y\} = \frac{1}{s(s^2 - 2s + 2)} = \frac{1}{2} \frac{1}{s} - \frac{1}{2} \frac{s - 1}{(s - 1)^2 + 1} + \frac{1}{2} \frac{1}{(s - 1)^2 + 1}.$$

Thus

$$y = \frac{1}{2} - \frac{1}{2}e^t \cos t + \frac{1}{2}e^t \sin t.$$

30. The Laplace transform of the differential equation is

$$s^2 \mathcal{L}\{y\} - sy(0) - y'(0) - 2[s \mathcal{L}\{y\} - y(0)] + 5 \mathcal{L}\{y\} = \frac{1}{s} + \frac{1}{s^2}.$$

Solving for  $\mathcal{L}\{y\}$  we obtain

$$\begin{aligned} \mathcal{L}\{y\} &= \frac{4s^2 + s + 1}{s^2(s^2 - 2s + 5)} = \frac{7}{25} \frac{1}{s} + \frac{1}{5} \frac{1}{s^2} + \frac{-7s/25 + 109/25}{s^2 - 2s + 5} \\ &= \frac{7}{25} \frac{1}{s} + \frac{1}{5} \frac{1}{s^2} - \frac{7}{25} \frac{s - 1}{(s - 1)^2 + 2^2} + \frac{51}{25} \frac{2}{(s - 1)^2 + 2^2}. \end{aligned}$$

Thus

$$y = \frac{7}{25} + \frac{1}{5}t - \frac{7}{25}e^t \cos 2t + \frac{51}{25}e^t \sin 2t.$$

31. Taking the Laplace transform of both sides of the differential equation and letting  $c = y(0)$  we

### Exercises 7.3

obtain

$$\begin{aligned}\mathcal{L}\{y''\} + \mathcal{L}\{2y'\} + \mathcal{L}\{y\} &= 0 \\ s^2\mathcal{L}\{y\} - sy(0) - y'(0) + 2s\mathcal{L}\{y\} - 2y(0) + \mathcal{L}\{y\} &= 0 \\ s^2\mathcal{L}\{y\} - cs - 2 + 2s\mathcal{L}\{y\} - 2c + \mathcal{L}\{y\} &= 0 \\ (s^2 + 2s + 1)\mathcal{L}\{y\} &= cs + 2c + 2 \\ \mathcal{L}\{y\} &= \frac{cs}{(s+1)^2} + \frac{2c+2}{(s+1)^2} \\ &= c\frac{s+1-1}{(s+1)^2} + \frac{2c+2}{(s+1)^2} \\ &= \frac{c}{s+1} + \frac{c+2}{(s+1)^2}.\end{aligned}$$

Therefore,

$$y(t) = c\mathcal{L}^{-1}\left\{\frac{1}{s+1}\right\} + (c+2)\mathcal{L}^{-1}\left\{\frac{1}{(s+1)^2}\right\} = ce^{-t} + (c+2)te^{-t}.$$

To find  $c$  we let  $y(1) = 2$ . Then  $2 = ce^{-1} + (c+2)e^{-1} = 2(c+1)e^{-1}$  and  $c = e - 1$ . Thus

$$y(t) = (e-1)e^{-t} + (e+1)te^{-t}.$$

32. Taking the Laplace transform of both sides of the differential equation and letting  $c = y'(0)$  we obtain

$$\begin{aligned}\mathcal{L}\{y''\} + \mathcal{L}\{8y'\} + \mathcal{L}\{20y\} &= 0 \\ s^2\mathcal{L}\{y\} - y'(0) + 8s\mathcal{L}\{y\} + 20\mathcal{L}\{y\} &= 0 \\ s^2\mathcal{L}\{y\} - c + 8s\mathcal{L}\{y\} + 20\mathcal{L}\{y\} &= 0 \\ (s^2 + 8s + 20)\mathcal{L}\{y\} &= c \\ \mathcal{L}\{y\} &= \frac{c}{s^2 + 8s + 20} = \frac{c}{(s+4)^2 + 4}.\end{aligned}$$

Therefore,

$$y(t) = \mathcal{L}^{-1}\left\{\frac{c}{(s+4)^2 + 4}\right\} = ce^{-4t} \sin 2t.$$

To find  $c$  we let  $y'(\pi) = 0$ . Then  $0 = y'(\pi) = ce^{-4\pi}$  and  $c = 0$ . Thus,  $y(t) = 0$ . (Since the differential equation is homogeneous and both boundary conditions are 0, we can see immediately that  $y(t) = 0$  is a solution. We have shown that it is the only solution.)

33. Recall from Section 5.1 that  $mx'' = -kx - \beta x'$ . Now  $m = W/g = 4/32 = \frac{1}{8}$  slug, and  $4 = 2k$  so that  $k = 2$  lb/ft. Thus, the differential equation is  $x'' + 7x' + 16x = 0$ . The initial conditions are  $x(0) = -3/2$  and  $x'(0) = 0$ . The Laplace transform of the differential equation is

$$s^2 \mathcal{L}\{x\} + \frac{3}{2}s + 7s \mathcal{L}\{x\} + \frac{21}{2} + 16 \mathcal{L}\{x\} = 0.$$

Solving for  $\mathcal{L}\{x\}$  we obtain

$$\mathcal{L}\{x\} = \frac{-3s/2 - 21/2}{s^2 + 7s + 16} = -\frac{3}{2} \frac{s + 7/2}{(s + 7/2)^2 + (\sqrt{15}/2)^2} - \frac{7\sqrt{15}}{10} \frac{\sqrt{15}/2}{(s + 7/2)^2 + (\sqrt{15}/2)^2}.$$

Thus

$$x = -\frac{3}{2} e^{-7t/2} \cos \frac{\sqrt{15}}{2} t - \frac{7\sqrt{15}}{10} e^{-7t/2} \sin \frac{\sqrt{15}}{2} t.$$

34. The differential equation is

$$\frac{d^2 q}{dt^2} + 20 \frac{dq}{dt} + 200q = 150, \quad q(0) = q'(0) = 0.$$

The Laplace transform of this equation is

$$s^2 \mathcal{L}\{q\} + 20s \mathcal{L}\{q\} + 200 \mathcal{L}\{q\} = \frac{150}{s}.$$

Solving for  $\mathcal{L}\{q\}$  we obtain

$$\mathcal{L}\{q\} = \frac{150}{s(s^2 + 20s + 200)} = \frac{3}{4} \frac{1}{s} - \frac{3}{4} \frac{s + 10}{(s + 10)^2 + 10^2} - \frac{3}{4} \frac{10}{(s + 10)^2 + 10^2}.$$

Thus

$$q(t) = \frac{3}{4} - \frac{3}{4} e^{-10t} \cos 10t - \frac{3}{4} e^{-10t} \sin 10t$$

and

$$i(t) = q'(t) = 15e^{-10t} \sin 10t.$$

35. The differential equation is

$$\frac{d^2 q}{dt^2} + 2\lambda \frac{dq}{dt} + \omega^2 q = \frac{E_0}{L}, \quad q(0) = q'(0) = 0.$$

The Laplace transform of this equation is

$$s^2 \mathcal{L}\{q\} + 2\lambda s \mathcal{L}\{q\} + \omega^2 \mathcal{L}\{q\} = \frac{E_0}{L} \frac{1}{s}$$

or

$$(s^2 + 2\lambda s + \omega^2) \mathcal{L}\{q\} = \frac{E_0}{L} \frac{1}{s}.$$

Solving for  $\mathcal{L}\{q\}$  and using partial fractions we obtain

$$\mathcal{L}\{q\} = \frac{E_0}{L} \left( \frac{1/\omega^2}{s} - \frac{(1/\omega^2)s + 2\lambda/\omega^2}{s^2 + 2\lambda s + \omega^2} \right) = \frac{E_0}{L\omega^2} \left( \frac{1}{s} - \frac{s + 2\lambda}{s^2 + 2\lambda s + \omega^2} \right).$$

### Exercises 7.3

For  $\lambda > \omega$  we write  $s^2 + 2\lambda s + \omega^2 = (s + \lambda)^2 - (\lambda^2 - \omega^2)$ , so (recalling that  $\omega^2 = 1/LC$ )

$$\mathcal{L}\{q\} = E_0 C \left( \frac{1}{s} - \frac{s + \lambda}{(s + \lambda)^2 - (\lambda^2 - \omega^2)} - \frac{\lambda}{(s + \lambda)^2 - (\lambda^2 - \omega^2)} \right).$$

Thus for  $\lambda > \omega$ ,

$$q(t) = E_0 C \left( 1 - e^{-\lambda t} \cosh \sqrt{\lambda^2 - \omega^2} t - \frac{\lambda}{\sqrt{\lambda^2 - \omega^2}} \sinh \sqrt{\lambda^2 - \omega^2} t \right).$$

For  $\lambda < \omega$  we write  $s^2 + 2\lambda s + \omega^2 = (s + \lambda)^2 + (\omega^2 - \lambda^2)$ , so

$$\mathcal{L}\{q\} = E_0 \left( \frac{1}{s} - \frac{s + \lambda}{(s + \lambda)^2 + (\omega^2 - \lambda^2)} - \frac{\lambda}{(s + \lambda)^2 + (\omega^2 - \lambda^2)} \right).$$

Thus for  $\lambda < \omega$ ,

$$q(t) = E_0 C \left( 1 - e^{-\lambda t} \cos \sqrt{\omega^2 - \lambda^2} t - \frac{\lambda}{\sqrt{\omega^2 - \lambda^2}} \sin \sqrt{\omega^2 - \lambda^2} t \right).$$

For  $\lambda = \omega$ ,  $s^2 + 2\lambda s + \omega^2 = (s + \lambda)^2$  and

$$\mathcal{L}\{q\} = \frac{E_0}{L} \frac{1}{s(s + \lambda)^2} = \frac{E_0}{L} \left( \frac{1/\lambda^2}{s} - \frac{1/\lambda^2}{s + \lambda} - \frac{1/\lambda}{(s + \lambda)^2} \right) = \frac{E_0}{L\lambda^2} \left( \frac{1}{s} - \frac{1}{s + \lambda} - \frac{\lambda}{(s + \lambda)^2} \right).$$

Thus for  $\lambda = \omega$ ,

$$q(t) = E_0 C (1 - e^{-\lambda t} - \lambda t e^{-\lambda t}).$$

36. The differential equation is

$$R \frac{dq}{dt} + \frac{1}{C} q = E_0 e^{-kt}, \quad q(0) = 0.$$

The Laplace transform of this equation is

$$R \mathcal{L}\{q\} + \frac{1}{C} \mathcal{L}\{q\} = E_0 \frac{1}{s + k}.$$

Solving for  $\mathcal{L}\{q\}$  we obtain

$$\mathcal{L}\{q\} = \frac{E_0 C}{(s + k)(RCs + 1)} = \frac{E_0/R}{(s + k)(s + 1/RC)}.$$

When  $1/RC \neq k$  we have by partial fractions

$$\mathcal{L}\{q\} = \frac{E_0}{R} \left( \frac{1/(1/RC - k)}{s + k} - \frac{1/(1/RC - k)}{s + 1/RC} \right) = \frac{E_0}{R} \frac{1}{1/RC - k} \left( \frac{1}{s + k} - \frac{1}{s + 1/RC} \right).$$

Thus

$$q(t) = \frac{E_0 C}{1 - kRC} (e^{-kt} - e^{-t/RC}).$$

When  $1/RC = k$  we have

$$\mathcal{L}\{q\} = \frac{E_0}{R} \frac{1}{(s + k)^2}.$$

Thus

$$q(t) = \frac{E_0}{R} te^{-kt} = \frac{E_0}{R} te^{-t/RC}.$$

$$37. \mathcal{L}\{(t-1)u(t-1)\} = \frac{e^{-s}}{s^2}$$

$$38. \mathcal{L}\{e^{2-t}u(t-2)\} = \mathcal{L}\{e^{-(t-2)}u(t-2)\} = \frac{e^{-2s}}{s+1}$$

$$39. \mathcal{L}\{t^2u(t-2)\} = \mathcal{L}\{(t-2)^2u(t-2) + 2(t-2)u(t-2) + u(t-2)\} = \frac{e^{-2s}}{s^2} + \frac{2e^{-2s}}{s}$$

$$40. \mathcal{L}\{(3t+1)u(t-1)\} = 3\mathcal{L}\{(t-1)u(t-1)\} + 4\mathcal{L}\{u(t-1)\} = \frac{e^{-s}}{s^2} + \frac{4e^{-s}}{s}$$

$$41. \mathcal{L}\{\cos 2t u(t-\pi)\} = \mathcal{L}\{\cos 2(t-\pi)u(t-\pi)\} = \frac{se^{-\pi s}}{s^2+4}$$

$$42. \mathcal{L}\left\{\sin t u\left(t-\frac{\pi}{2}\right)\right\} = \mathcal{L}\left\{\cos\left(t-\frac{\pi}{2}\right)u\left(t-\frac{\pi}{2}\right)\right\} = \frac{se^{-\pi s}}{s^2+1}$$

$$43. \mathcal{L}^{-1}\left\{\frac{e^{-2s}}{s^3}\right\} = \mathcal{L}^{-1}\left\{\frac{1}{2} \cdot \frac{2}{s^3}e^{-2s}\right\} = \frac{1}{2}(t-2)^2u(t-2)$$

$$44. \mathcal{L}^{-1}\left\{\frac{(1+e^{-2s})^2}{s+2}\right\} = \mathcal{L}^{-1}\left\{\frac{1}{s+2} + \frac{2e^{-2s}}{s+2} + \frac{e^{-4s}}{s+2}\right\} = e^{-2t} + 2e^{-2(t-2)}u(t-2) + e^{-2(t-4)}u(t-4)$$

$$45. \mathcal{L}^{-1}\left\{\frac{e^{-\pi s}}{s^2+1}\right\} = \sin(t-\pi)u(t-\pi)$$

$$46. \mathcal{L}^{-1}\left\{\frac{se^{-\pi s/2}}{s^2+4}\right\} = \cos 2\left(t-\frac{\pi}{2}\right)u\left(t-\frac{\pi}{2}\right)$$

$$47. \mathcal{L}^{-1}\left\{\frac{e^{-s}}{s(s+1)}\right\} = \mathcal{L}^{-1}\left\{\frac{e^{-s}}{s} - \frac{e^{-s}}{s+1}\right\} = u(t-1) - e^{-(t-1)}u(t-1)$$

$$48. \mathcal{L}^{-1}\left\{\frac{e^{-2s}}{s^2(s-1)}\right\} = \mathcal{L}^{-1}\left\{-\frac{e^{-2s}}{s} - \frac{e^{-2s}}{s^2} + \frac{e^{-2s}}{s-1}\right\} = -u(t-2) - (t-2)u(t-2) + e^{t-2}u(t-2)$$

49. (c)

50. (e)

51. (f)

52. (b)

53. (a)

54. (d)

$$55. \mathcal{L}\{2-4u(t-3)\} = \frac{2}{s} - \frac{4}{s}e^{-3s}$$

$$56. \mathcal{L}\{1-u(t-4)+u(t-5)\} = \frac{1}{s} - \frac{e^{-4s}}{s} + \frac{e^{-5s}}{s}$$

$$57. \mathcal{L}\{t^2u(t-1)\} = \mathcal{L}\{[(t-1)^2+2t-1]u(t-1)\} = \mathcal{L}\{[(t-1)^2+2(t-1)-1]u(t-1)\}$$

### Exercises 7.3

$$= \left( \frac{2}{s^3} + \frac{2}{s^2} + \frac{1}{s} \right) e^{-s}$$

$$58. \mathcal{L}\left\{\sin t \mathcal{U}\left(t - \frac{3\pi}{2}\right)\right\} = \mathcal{L}\left\{-\cos\left(t - \frac{3\pi}{2}\right) \mathcal{U}\left(t - \frac{3\pi}{2}\right)\right\} = -\frac{se^{-3\pi s/2}}{s^2 + 1}$$

$$59. \mathcal{L}\{t - t \mathcal{U}(t - 2)\} = \mathcal{L}\{t - (t - 2)\mathcal{U}(t - 2) - 2\mathcal{U}(t - 2)\} = \frac{1}{s^2} - \frac{e^{-2s}}{s^2} - \frac{2e^{-2s}}{s}$$

$$60. \mathcal{L}\{\sin t - \sin t \mathcal{U}(t - 2\pi)\} = \mathcal{L}\{\sin t - \sin(t - 2\pi) \mathcal{U}(t - 2\pi)\} = \frac{1}{s^2 + 1} - \frac{e^{-2\pi s}}{s^2 + 1}$$

$$61. \mathcal{L}\{f(t)\} = \mathcal{L}\{\mathcal{U}(t - a) - \mathcal{U}(t - b)\} = \frac{e^{-as}}{s} - \frac{e^{-bs}}{s}$$

$$62. \mathcal{L}\{f(t)\} = \mathcal{L}\{\mathcal{U}(t - 1) + \mathcal{U}(t - 2) + \mathcal{U}(t - 3) + \dots\} = \frac{e^{-s}}{s} + \frac{e^{-2s}}{s} + \frac{e^{-3s}}{s} + \dots = \frac{1}{s} \frac{e^{-s}}{1 - e^{-s}}$$

63. The Laplace transform of the differential equation is

$$s \mathcal{L}\{y\} - y(0) + \mathcal{L}\{y\} = \frac{5}{s} e^{-s}.$$

Solving for  $\mathcal{L}\{y\}$  we obtain

$$\mathcal{L}\{y\} = \frac{5e^{-s}}{s(s+1)} = 5e^{-s} \left[ \frac{1}{s} - \frac{1}{s+1} \right].$$

Thus

$$y = 5 \mathcal{U}(t - 1) - 5e^{-(t-1)} \mathcal{U}(t - 1).$$

64. The Laplace transform of the differential equation is

$$s \mathcal{L}\{y\} - y(0) + \mathcal{L}\{y\} = \frac{1}{s} - \frac{2}{s} e^{-s}.$$

Solving for  $\mathcal{L}\{y\}$  we obtain

$$\mathcal{L}\{y\} = \frac{1}{s(s+1)} - \frac{2e^{-s}}{s(s+1)} = \frac{1}{s} - \frac{1}{s+1} - 2e^{-s} \left[ \frac{1}{s} - \frac{1}{s+1} \right].$$

Thus

$$y = 1 - e^{-t} - 2[1 - e^{-(t-1)}] \mathcal{U}(t - 1).$$

65. The Laplace transform of the differential equation is

$$s \mathcal{L}\{y\} - y(0) + 2 \mathcal{L}\{y\} = \frac{1}{s^2} - e^{-s} \frac{s+1}{s^2}.$$

Solving for  $\mathcal{L}\{y\}$  we obtain

$$\mathcal{L}\{y\} = \frac{1}{s^2(s+2)} - e^{-s} \frac{s+1}{s^2(s+1)} = -\frac{1}{4} \frac{1}{s} + \frac{1}{2} \frac{1}{s^2} + \frac{1}{4} \frac{1}{s+2} - e^{-s} \left[ \frac{1}{4} \frac{1}{s} + \frac{1}{2} \frac{1}{s^2} - \frac{1}{4} \frac{1}{s+2} \right].$$

Thus

$$y = -\frac{1}{4} + \frac{1}{2}t + \frac{1}{4}e^{-2t} - \left[ \frac{1}{4} + \frac{1}{2}(t-1) - \frac{1}{4}e^{-2(t-1)} \right] \mathcal{U}(t-1).$$

66. The Laplace transform of the differential equation is

$$s^2 \mathcal{L}\{y\} - sy(0) - y'(0) + 4 \mathcal{L}\{y\} = \frac{1}{s} - \frac{e^{-s}}{s}.$$

Solving for  $\mathcal{L}\{y\}$  we obtain

$$\mathcal{L}\{y\} = \frac{1-s}{s(s^2+4)} - e^{-s} \frac{1}{s(s^2+4)} = \frac{1}{4} \frac{1}{s} - \frac{1}{4} \frac{s}{s^2+4} - \frac{1}{2} \frac{2}{s^2+4} - e^{-s} \left[ \frac{1}{4} \frac{1}{s} - \frac{1}{4} \frac{s}{s^2+4} \right].$$

Thus

$$y = \frac{1}{4} - \frac{1}{4} \cos 2t - \frac{1}{2} \sin 2t - \left[ \frac{1}{4} - \frac{1}{4} \cos 2(t-1) \right] \mathcal{U}(t-1).$$

67. The Laplace transform of the differential equation is

$$s^2 \mathcal{L}\{y\} - sy(0) - y'(0) + 4 \mathcal{L}\{y\} = e^{-2\pi s} \frac{1}{s^2+1}.$$

Solving for  $\mathcal{L}\{y\}$  we obtain

$$\mathcal{L}\{y\} = \frac{s}{s^2+4} + e^{-2\pi s} \left[ \frac{1}{3} \frac{1}{s^2+1} - \frac{1}{6} \frac{2}{s^2+4} \right].$$

Thus

$$y = \cos 2t + \left[ \frac{1}{3} \sin(t-2\pi) - \frac{1}{6} \sin 2(t-2\pi) \right] \mathcal{U}(t-2\pi).$$

68. The Laplace transform of the differential equation is

$$s^2 \mathcal{L}\{y\} - sy(0) - y'(0) - 5[s \mathcal{L}\{y\} - y(0)] + 6 \mathcal{L}\{y\} = \frac{e^{-s}}{s}.$$

Solving for  $\mathcal{L}\{y\}$  we obtain

$$\begin{aligned} \mathcal{L}\{y\} &= e^{-s} \frac{1}{s(s-2)(s-3)} + \frac{1}{(s-2)(s-3)} \\ &= e^{-s} \left[ \frac{1}{6} \frac{1}{s} - \frac{1}{2} \frac{1}{s-2} + \frac{1}{3} \frac{1}{s-3} \right] - \frac{1}{s-2} + \frac{1}{s-3}. \end{aligned}$$

Thus

$$y = \left[ \frac{1}{6} - \frac{1}{2} e^{2(t-1)} + \frac{1}{3} e^{3(t-1)} \right] \mathcal{U}(t-1) + e^{3t} - e^{2t}.$$

69. The Laplace transform of the differential equation is

$$s^2 \mathcal{L}\{y\} - sy(0) - y'(0) + \mathcal{L}\{y\} = \frac{e^{-\pi s}}{s} - \frac{e^{-2\pi s}}{s}.$$

Solving for  $\mathcal{L}\{y\}$  we obtain

$$\mathcal{L}\{y\} = e^{-\pi s} \left[ \frac{1}{s} - \frac{s}{s^2+1} \right] - e^{-2\pi s} \left[ \frac{1}{s} - \frac{s}{s^2+1} \right] + \frac{1}{s^2+1}.$$

### Exercises 7.3

Thus

$$y = [1 - \cos(t - \pi)]\mathcal{U}(t - \pi) - [1 - \cos(t - 2\pi)]\mathcal{U}(t - 2\pi) + \sin t.$$

70. The Laplace transform of the differential equation is

$$s^2 \mathcal{L}\{y\} - sy(0) - y'(0) + 4[s \mathcal{L}\{y\} - y(0)] + 3 \mathcal{L}\{y\} = \frac{1}{s} - \frac{e^{-2s}}{s} - \frac{e^{-4s}}{s} + \frac{e^{-6s}}{s}.$$

Solving for  $\mathcal{L}\{y\}$  we obtain

$$\begin{aligned} \mathcal{L}\{y\} &= \frac{1}{3} \frac{1}{s} - \frac{1}{2} \frac{1}{s+1} + \frac{1}{6} \frac{1}{s+3} - e^{-2s} \left[ \frac{1}{3} \frac{1}{s} - \frac{1}{2} \frac{1}{s+1} + \frac{1}{6} \frac{1}{s+3} \right] \\ &\quad - e^{-4s} \left[ \frac{1}{3} \frac{1}{s} - \frac{1}{2} \frac{1}{s+1} + \frac{1}{6} \frac{1}{s+3} \right] + e^{-6s} \left[ \frac{1}{3} \frac{1}{s} - \frac{1}{2} \frac{1}{s+1} + \frac{1}{6} \frac{1}{s+3} \right]. \end{aligned}$$

Thus

$$\begin{aligned} y &= \frac{1}{3} - \frac{1}{2}e^{-t} + \frac{1}{6}e^{-3t} - \left[ \frac{1}{3} - \frac{1}{2}e^{-(t-2)} + \frac{1}{6}e^{-3(t-2)} \right] \mathcal{U}(t-2) \\ &\quad - \left[ \frac{1}{3} - \frac{1}{2}e^{-(t-4)} + \frac{1}{6}e^{-3(t-4)} \right] \mathcal{U}(t-4) + \left[ \frac{1}{3} - \frac{1}{2}e^{-(t-6)} + \frac{1}{6}e^{-3(t-6)} \right] \mathcal{U}(t-6). \end{aligned}$$

71. Recall from Section 5.1 that  $mx'' = -kx + f(t)$ . Now  $m = W/g = 32/32 = 1$  slug, and  $32 = 2k$  so that  $k = 16$  lb/ft. Thus, the differential equation is  $x'' + 16x = f(t)$ . The initial conditions are  $x(0) = 0$ ,  $x'(0) = 0$ . Also, since

$$f(t) = \begin{cases} 20t, & 0 \leq t < 5 \\ 0, & t \geq 5 \end{cases}$$

and  $20t = 20(t-5) + 100$  we can write

$$f(t) = 20t - 20t\mathcal{U}(t-5) = 20t - 20(t-5)\mathcal{U}(t-5) - 100\mathcal{U}(t-5).$$

The Laplace transform of the differential equation is

$$s^2 \mathcal{L}\{x\} + 16 \mathcal{L}\{x\} = \frac{20}{s^2} - \frac{20}{s^2} e^{-5s} - \frac{100}{s} e^{-5s}.$$

Solving for  $\mathcal{L}\{x\}$  we obtain

$$\begin{aligned} \mathcal{L}\{x\} &= \frac{20}{s^2(s^2+16)} - \frac{20}{s^2(s^2+16)} e^{-5s} - \frac{100}{s(s^2+16)} e^{-5s} \\ &= \left( \frac{5}{4} \cdot \frac{1}{s^2} - \frac{5}{16} \cdot \frac{4}{s^2+16} \right) (1 - e^{-5s}) - \left( \frac{25}{4} \cdot \frac{1}{s} - \frac{25}{4} \cdot \frac{s}{s^2+16} \right) e^{-5s}. \end{aligned}$$

Thus

$$\begin{aligned} x(t) &= \frac{5}{4}t - \frac{5}{16} \sin 4t - \left[ \frac{5}{4}(t-5) - \frac{5}{16} \sin 4(t-5) \right] \mathcal{U}(t-5) - \left[ \frac{25}{4} - \frac{25}{4} \cos 4(t-5) \right] \mathcal{U}(t-5) \\ &= \frac{5}{4}t - \frac{5}{16} \sin 4t - \frac{5}{4}t\mathcal{U}(t-5) + \frac{5}{16} \sin 4(t-5)\mathcal{U}(t-5) + \frac{25}{4} \cos 4(t-5)\mathcal{U}(t-5). \end{aligned}$$



Exercises 7.3

72. Recall from Section 5.1 that  $mx'' = -kx + f(t)$ . Now  $m = W/g = 32/32 = 1$  slug, and  $32 = 2k$  so that  $k = 16$  lb/ft. Thus, the differential equation is  $x'' + 16x = f(t)$ . The initial conditions are  $x(0) = 0$ ,  $x'(0) = 0$ . Also, since

$$f(t) = \begin{cases} \sin t, & 0 \leq t < 2\pi \\ 0, & t \geq 2\pi \end{cases}$$

and  $\sin t = \sin(t - 2\pi)$  we can write

$$f(t) = \sin t - \sin(t - 2\pi)\mathcal{U}(t - 2\pi).$$

The Laplace transform of the differential equation is

$$s^2\mathcal{L}\{x\} + 16\mathcal{L}\{x\} = \frac{1}{s^2 + 1} - \frac{1}{s^2 + 1}e^{-2\pi s}.$$

Solving for  $\mathcal{L}\{x\}$  we obtain

$$\begin{aligned} \mathcal{L}\{x\} &= \frac{1}{(s^2 + 16)(s^2 + 1)} - \frac{1}{(s^2 + 16)(s^2 + 1)}e^{-2\pi s} \\ &= \frac{-1/15}{s^2 + 16} + \frac{1/15}{s^2 + 1} - \left[ \frac{-1/15}{s^2 + 16} + \frac{1/15}{s^2 + 1} \right] e^{-2\pi s}. \end{aligned}$$

Thus

$$\begin{aligned} x(t) &= -\frac{1}{60}\sin 4t + \frac{1}{15}\sin t + \frac{1}{60}\sin 4(t - 2\pi)\mathcal{U}(t - 2\pi) - \frac{1}{15}\sin(t - 2\pi)\mathcal{U}(t - 2\pi) \\ &= \begin{cases} -\frac{1}{60}\sin 4t + \frac{1}{15}\sin t, & 0 \leq t < 2\pi \\ 0, & t \geq 2\pi. \end{cases} \end{aligned}$$

73. The differential equation is

$$2.5 \frac{dq}{dt} + 12.5q = 5\mathcal{U}(t - 3).$$

The Laplace transform of this equation is

$$s\mathcal{L}\{q\} + 5\mathcal{L}\{q\} = \frac{2}{s}e^{-3s}.$$

Solving for  $\mathcal{L}\{q\}$  we obtain

$$\mathcal{L}\{q\} = \frac{2}{s(s + 5)}e^{-3s} = \left( \frac{2}{5} \cdot \frac{1}{s} - \frac{2}{5} \cdot \frac{1}{s + 5} \right) e^{-3s}.$$

Thus

$$q(t) = \frac{2}{5}\mathcal{U}(t - 3) - \frac{2}{5}e^{-5(t-3)}\mathcal{U}(t - 3).$$

74. The differential equation is

$$10 \frac{dq}{dt} + 10q = 30e^t - 30e^t\mathcal{U}(t - 1.5).$$

### Exercises 7.3

The Laplace transform of this equation is

$$s\mathcal{L}\{q\} - q_0 + \mathcal{L}\{q\} = \frac{3}{s-1} - \frac{3e^{1.5}}{s-1.5}e^{-1.5s}.$$

Solving for  $\mathcal{L}\{q\}$  we obtain

$$\mathcal{L}\{q\} = \left(q_0 - \frac{3}{2}\right) \cdot \frac{1}{s+1} + \frac{3}{2} \cdot \frac{1}{s-1} 3e^{1.5} \left(\frac{-2/5}{s+1} + \frac{2/5}{s-1.5}\right) e^{-1.5s}.$$

Thus

$$q(t) = \left(q_0 - \frac{3}{2}\right) e^{-t} + \frac{3}{2} e^t + \frac{6}{5} e^{1.5} \left(e^{-(t-1.5)} - e^{1.5(t-1.5)}\right) \mathcal{U}(t-1.5).$$

75. (a) The differential equation is

$$\frac{di}{dt} + 10i = \sin t + \cos\left(t - \frac{3\pi}{2}\right) \mathcal{U}\left(t - \frac{3\pi}{2}\right), \quad i(0) = 0.$$

The Laplace transform of this equation is

$$s\mathcal{L}\{i\} + 10\mathcal{L}\{i\} = \frac{1}{s^2+1} + \frac{se^{-3\pi s/2}}{s^2+1}.$$

Solving for  $\mathcal{L}\{i\}$  we obtain

$$\begin{aligned} \mathcal{L}\{i\} &= \frac{1}{(s^2+1)(s+10)} + \frac{s}{(s^2+1)(s+10)} e^{-3\pi s/2} \\ &= \frac{1}{101} \left(\frac{1}{s+10} - \frac{s}{s^2+1} + \frac{10}{s^2+1}\right) + \frac{1}{101} \left(\frac{-10}{s+10} + \frac{10s}{s^2+1} + \frac{1}{s^2+1}\right) e^{-3\pi s/2}. \end{aligned}$$

Thus

$$\begin{aligned} i(t) &= \frac{1}{101} \left(e^{-10t} - \cos t + 10 \sin t\right) \\ &\quad + \frac{1}{101} \left[-10e^{-10(t-3\pi/2)} + 10 \cos\left(t - \frac{3\pi}{2}\right) + \sin\left(t - \frac{3\pi}{2}\right)\right] \mathcal{U}\left(t - \frac{3\pi}{2}\right). \end{aligned}$$

(b)

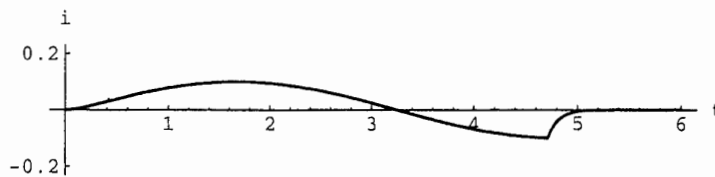

The maximum value of  $i(t)$  is approximately 0.1 at  $t = 1.7$ , the minimum is approximately -0.1 at 4.7.

76. (a) The differential equation is

$$50 \frac{dq}{dt} + \frac{1}{0.01} q = E_0 [\mathcal{U}(t-1) - \mathcal{U}(t-3)], \quad q(0) = 0$$

or

$$50 \frac{dq}{dt} + 100q = E_0[\mathcal{U}(t-1) - \mathcal{U}(t-3)], \quad q(0) = 0.$$

The Laplace transform of this equation is

$$50s \mathcal{L}\{q\} + 100 \mathcal{L}\{q\} = E_0 \left( \frac{1}{s} e^{-s} - \frac{1}{s} e^{-3s} \right).$$

Solving for  $\mathcal{L}\{q\}$  we obtain

$$\mathcal{L}\{q\} = \frac{E_0}{50} \left[ \frac{e^{-s}}{s(s+2)} - \frac{e^{-3s}}{s(s+2)} \right] = \frac{E_0}{50} \left[ \frac{1}{2} \left( \frac{1}{s} - \frac{1}{s+2} \right) e^{-s} - \frac{1}{2} \left( \frac{1}{s} - \frac{1}{s+2} \right) e^{-3s} \right].$$

Thus

$$q(t) = \frac{E_0}{100} \left[ (1 - e^{-2(t-1)})\mathcal{U}(t-1) - (1 - e^{-2(t-3)})\mathcal{U}(t-3) \right].$$

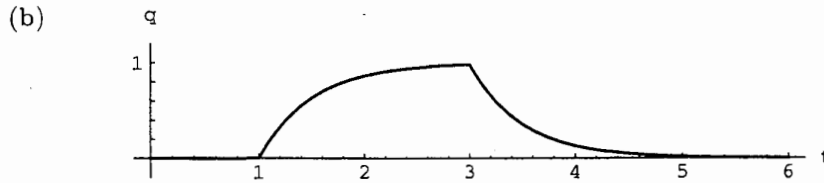

The maximum value of  $q(t)$  is approximately 1 at  $t = 3$ .

77. The differential equation is

$$EI \frac{d^4 y}{dx^4} = w_0[1 - \mathcal{U}(x - L/2)].$$

Taking the Laplace transform of both sides and using  $y(0) = y'(0) = 0$  we obtain

$$s^4 \mathcal{L}\{y\} - sy''(0) - y'''(0) = \frac{w_0}{EI} \frac{1}{s} (1 - e^{-Ls/2}).$$

Letting  $y''(0) = c_1$  and  $y'''(0) = c_2$  we have

$$\mathcal{L}\{y\} = \frac{c_1}{s^3} + \frac{c_2}{s^4} + \frac{w_0}{EI} \frac{1}{s^5} (1 - e^{-Ls/2})$$

so that

$$y(x) = \frac{1}{2}c_1x^2 + \frac{1}{6}c_2x^3 + \frac{1}{24} \frac{w_0}{EI} \left[ x^4 - \left(x - \frac{L}{2}\right)^4 \mathcal{U}\left(x - \frac{L}{2}\right) \right].$$

To find  $c_1$  and  $c_2$  we compute

$$y''(x) = c_1 + c_2x + \frac{1}{2} \frac{w_0}{EI} \left[ x^2 - \left(x - \frac{L}{2}\right)^2 \mathcal{U}\left(x - \frac{L}{2}\right) \right]$$

and

$$y'''(x) = c_2 + \frac{w_0}{EI} \left[ x - \left(x - \frac{L}{2}\right) \mathcal{U}\left(x - \frac{L}{2}\right) \right].$$

### Exercises 7.3

Then  $y''(L) = y'''(L) = 0$  yields the system.

$$c_1 + c_2L + \frac{1}{2} \frac{w_0}{EI} \left[ L^2 - \left( \frac{L}{2} \right)^2 \right] = c_1 + c_2L + \frac{3}{8} \frac{w_0L^2}{EI} = 0$$

$$c_2 + \frac{w_0}{EI} \left( \frac{L}{2} \right) = c_2 + \frac{1}{2} \frac{w_0L}{EI} = 0.$$

Solving for  $c_1$  and  $c_2$  we obtain  $c_1 = \frac{1}{8}w_0L^2/EI$  and  $c_2 = -\frac{1}{2}w_0L/EI$ . Thus

$$y(x) = \frac{w_0}{EI} \left( \frac{1}{16}L^2x^2 - \frac{1}{12}Lx^3 + \frac{1}{24}x^4 - \frac{1}{24} \left( x - \frac{L}{2} \right)^4 \mathcal{U} \left( x - \frac{L}{2} \right) \right).$$

78. The differential equation is

$$EI \frac{d^4y}{dx^4} = w_0[\mathcal{U}(x - L/3) - \mathcal{U}(x - 2L/3)].$$

Taking the Laplace transform of both sides and using  $y(0) = y'(0) = 0$  we obtain

$$s^4 \mathcal{L}\{y\} - sy''(0) - y'''(0) = \frac{w_0}{EI} \frac{1}{s} (e^{-Ls/3} - e^{-2Ls/3}).$$

Letting  $y''(0) = c_1$  and  $y'''(0) = c_2$  we have

$$\mathcal{L}\{y\} = \frac{c_1}{s^3} + \frac{c_2}{s^4} + \frac{w_0}{EI} \frac{1}{s^5} (e^{-Ls/3} - e^{-2Ls/3})$$

so that

$$y(x) = \frac{1}{2}c_1x^2 + \frac{1}{6}c_2x^3 + \frac{1}{24} \frac{w_0}{EI} \left[ \left( x - \frac{L}{3} \right)^4 \mathcal{U} \left( x - \frac{L}{3} \right) - \left( x - \frac{2L}{3} \right)^4 \mathcal{U} \left( x - \frac{2L}{3} \right) \right].$$

To find  $c_1$  and  $c_2$  we compute

$$y''(x) = c_1 + c_2x + \frac{1}{2} \frac{w_0}{EI} \left[ \left( x - \frac{L}{3} \right)^2 \mathcal{U} \left( x - \frac{L}{3} \right) - \left( x - \frac{2L}{3} \right)^2 \mathcal{U} \left( x - \frac{2L}{3} \right) \right]$$

and

$$y'''(x) = c_2 + \frac{w_0}{EI} \left[ \left( x - \frac{L}{3} \right) \mathcal{U} \left( x - \frac{L}{3} \right) - \left( x - \frac{2L}{3} \right) \mathcal{U} \left( x - \frac{2L}{3} \right) \right].$$

Then  $y''(L) = y'''(L) = 0$  yields the system

$$c_1 + c_2L + \frac{1}{2} \frac{w_0}{EI} \left[ \left( \frac{2L}{3} \right)^2 - \left( \frac{L}{3} \right)^2 \right] = c_1 + c_2L + \frac{1}{6} \frac{w_0L^2}{EI} = 0$$

$$c_2 + \frac{w_0}{EI} \left[ \frac{2L}{3} - \frac{L}{3} \right] = c_2 + \frac{1}{3} \frac{w_0L}{EI} = 0.$$

Solving for  $c_1$  and  $c_2$  we obtain  $c_1 = \frac{1}{6}w_0L^2/EI$  and  $c_2 = -\frac{1}{3}w_0L/EI$ . Thus

$$y(x) = \frac{w_0}{EI} \left( \frac{1}{12}L^2x^2 - \frac{1}{18}Lx^3 + \frac{1}{24} \left[ \left( x - \frac{L}{3} \right)^4 \mathcal{U} \left( x - \frac{L}{3} \right) - \left( x - \frac{2L}{3} \right)^4 \mathcal{U} \left( x - \frac{2L}{3} \right) \right] \right).$$

79. The differential equation is

$$EI \frac{d^4 y}{dx^4} = \frac{2w_0}{L} \left[ \frac{L}{2} - x + \left( x - \frac{L}{2} \right) \mathcal{U} \left( x - \frac{L}{2} \right) \right].$$

Taking the Laplace transform of both sides and using  $y(0) = y'(0) = 0$  we obtain

$$s^4 \mathcal{L}\{y\} - sy''(0) - y'''(0) = \frac{2w_0}{EIL} \left[ \frac{L}{2s} - \frac{1}{s^2} + \frac{1}{s^2} e^{-Ls/2} \right].$$

Letting  $y''(0) = c_1$  and  $y'''(0) = c_2$  we have

$$\mathcal{L}\{y\} = \frac{c_1}{s^3} + \frac{c_2}{s^4} + \frac{2w_0}{EIL} \left[ \frac{L}{2s^5} - \frac{1}{s^6} + \frac{1}{s^6} e^{-Ls/2} \right]$$

so that

$$\begin{aligned} y(x) &= \frac{1}{2}c_1x^2 + \frac{1}{6}c_2x^3 + \frac{2w_0}{EIL} \left[ \frac{L}{48}x^4 - \frac{1}{120}x^5 + \frac{1}{120} \left( x - \frac{L}{2} \right) \mathcal{U} \left( x - \frac{L}{2} \right) \right] \\ &= \frac{1}{2}c_1x^2 + \frac{1}{6}c_2x^3 + \frac{w_0}{60EIL} \left[ \frac{5L}{2}x^4 - x^5 + \left( x - \frac{L}{2} \right)^5 \mathcal{U} \left( x - \frac{L}{2} \right) \right]. \end{aligned}$$

To find  $c_1$  and  $c_2$  we compute

$$y''(x) = c_1 + c_2x + \frac{w_0}{60EIL} \left[ 30Lx^2 - 20x^3 + 20 \left( x - \frac{L}{2} \right)^3 \mathcal{U} \left( x - \frac{L}{2} \right) \right]$$

and

$$y'''(x) = c_2 + \frac{w_0}{60EIL} \left[ 60Lx - 60x^2 + 60 \left( x - \frac{L}{2} \right)^2 \mathcal{U} \left( x - \frac{L}{2} \right) \right].$$

Then  $y''(L) = y'''(L) = 0$  yields the system

$$\begin{aligned} c_1 + c_2L + \frac{w_0}{60EIL} \left[ 30L^3 - 20L^3 + \frac{5}{2}L^3 \right] &= c_1 + c_2L + \frac{5w_0L^2}{24EI} = 0 \\ c_2 + \frac{w_0}{60EIL} [60L^2 - 60L^2 + 15L^2] &= c_2 + \frac{w_0L}{4EI} = 0. \end{aligned}$$

Solving for  $c_1$  and  $c_2$  we obtain  $c_1 = w_0L^2/24EI$  and  $c_2 = -w_0L/4EI$ . Thus

$$y(x) = \frac{w_0L^2}{48EI}x^2 - \frac{w_0L}{24EI} + \frac{w_0}{60EIL} \left[ \frac{5L}{2}x^4 - x^5 + \left( x - \frac{L}{2} \right)^5 \mathcal{U} \left( x - \frac{L}{2} \right) \right].$$

80. The differential equation is

$$EI \frac{d^4 y}{dx^4} = w_0[1 - \mathcal{U}(x - L/2)].$$

Taking the Laplace transform of both sides and using  $y(0) = y'(0) = 0$  we obtain

$$s^4 \mathcal{L}\{y\} - sy''(0) - y'''(0) = \frac{w_0}{EI} \frac{1}{s} (1 - e^{-Ls/2}).$$

Letting  $y''(0) = c_1$  and  $y'''(0) = c_2$  we have

$$\mathcal{L}\{y\} = \frac{c_1}{s^3} + \frac{c_2}{s^4} + \frac{w_0}{EI} \frac{1}{s^5} (1 - e^{-Ls/2})$$

### Exercises 7.3

so that

$$y(x) = \frac{1}{2}c_1x^2 + \frac{1}{6}c_2x^3 + \frac{1}{24} \frac{w_0}{EI} \left[ x^4 - \left(x - \frac{L}{2}\right)^4 \mathcal{U}\left(x - \frac{L}{2}\right) \right].$$

To find  $c_1$  and  $c_2$  we compute

$$y''(x) = c_1 + c_2x + \frac{1}{2} \frac{w_0}{EI} \left[ x^2 - \left(x - \frac{L}{2}\right)^2 \mathcal{U}\left(x - \frac{L}{2}\right) \right].$$

Then  $y(L) = y''(L) = 0$  yields the system

$$\frac{1}{2}c_1L^2 + \frac{1}{6}c_2L^3 + \frac{1}{24} \frac{w_0}{EI} \left[ L^4 - \left(\frac{L}{2}\right)^4 \right] = \frac{1}{2}c_1L^2 + \frac{1}{6}c_2L^3 + \frac{5w_0}{128EI}L^4 = 0$$

$$c_1 + c_2L + \frac{1}{2} \frac{w_0}{EI} \left[ L^2 - \left(\frac{L}{2}\right)^2 \right] = c_1 + c_2L + \frac{3w_0}{8EI}L^2 = 0.$$

Solving for  $c_1$  and  $c_2$  we obtain  $c_1 = \frac{9}{128}w_0L^2/EI$  and  $c_2 = -\frac{57}{128}w_0L/EI$ . Thus

$$y(x) = \frac{w_0}{EI} \left( \frac{9}{256}L^2x^2 - \frac{19}{256}Lx^3 + \frac{1}{24}x^4 - \frac{1}{24} \left(x - \frac{L}{2}\right)^4 \mathcal{U}\left(x - \frac{L}{2}\right) \right).$$

81. In order to apply Theorem 7.7 we need the function to have the form  $f(t-a)\mathcal{U}(t-a)$ . To accomplish this rewrite the functions given in the forms shown below.

(a)  $2t + 1 = 2(t - 1 + 1) + 1 = 2(t - 1) + 3$

(b)  $e^t = e^{t-5+5} = e^5e^{t-5}$

(c)  $\cos t = -\cos(t - \pi)$

(d)  $t^2 - 3t = (t - 2)^2 + (t - 2) - 2$

82. (a) From Theorem 7.6 we have  $\mathcal{L}\{te^{kti}\} = 1/(s - ki)^2$ . Then, using Euler's formula,

$$\begin{aligned} \mathcal{L}\{te^{kti}\} &= \mathcal{L}\{t \cos kt + it \sin kt\} = \mathcal{L}\{t \cos kt\} + i \mathcal{L}\{t \sin kt\} \\ &= \frac{1}{(s - ki)^2} = \frac{(s + ki)^2}{(s^2 + k^2)^2} = \frac{s^2 - k^2}{(s^2 + k^2)^2} + i \frac{2ks}{(s^2 + k^2)^2}. \end{aligned}$$

Equating real and imaginary parts we have

$$\mathcal{L}\{t \cos kt\} = \frac{s^2 - k^2}{(s^2 + k^2)^2} \quad \text{and} \quad \mathcal{L}\{t \sin kt\} = \frac{2ks}{(s^2 + k^2)^2}.$$

(b) The Laplace transform of the differential equation is

$$s^2 \mathcal{L}\{x\} + \omega^2 \mathcal{L}\{x\} = \frac{s}{s^2 + \omega^2}.$$

Solving for  $\mathcal{L}\{x\}$  we obtain  $\mathcal{L}\{x\} = s/(s^2 + \omega^2)^2$ . Thus  $x = (1/2\omega)t \sin \omega t$ .

---

**Exercises 7.4**

---

$$1. \mathcal{L}\{t \cos 2t\} = -\frac{d}{ds} \left( \frac{s}{s^2 + 4} \right) = \frac{s^2 - 4}{(s^2 + 4)^2}$$

$$2. \mathcal{L}\{t \sinh 3t\} = -\frac{d}{ds} \left( \frac{3}{s^2 - 9} \right) = \frac{6s}{(s^2 - 9)^2}$$

$$3. \mathcal{L}\{t^2 \sinh t\} = \frac{d^2}{ds^2} \left( \frac{1}{s^2 - 1} \right) = \frac{6s^2 + 2}{(s^2 - 1)^3}$$

$$4. \mathcal{L}\{t^2 \cos t\} = \frac{d^2}{ds^2} \left( \frac{s}{s^2 + 1} \right) = \frac{d}{ds} \left( \frac{1 - s^2}{(s^2 + 1)^2} \right) = \frac{2s(s^2 - 3)}{(s^2 + 1)^3}$$

$$5. \mathcal{L}\{te^{2t} \sin 6t\} = -\frac{d}{ds} \left( \frac{6}{(s - 2)^2 + 36} \right) = \frac{12(s - 2)}{[(s - 2)^2 + 36]^2}$$

$$6. \mathcal{L}\{te^{-3t} \cos 3t\} = -\frac{d}{ds} \left( \frac{s + 3}{(s + 3)^2 + 9} \right) = \frac{(s + 3)^2 - 9}{[(s + 3)^2 + 9]^2}$$

$$7. \mathcal{L}\{1 * t^3\} = \frac{1}{s} \frac{3!}{s^4} = \frac{6}{s^5}$$

$$8. \mathcal{L}\{t^2 * te^t\} = \frac{2}{s^3(s - 1)^2}$$

$$9. \mathcal{L}\{e^{-t} * e^t \cos t\} = \frac{s - 1}{(s + 1)[(s - 1)^2 + 1]}$$

$$10. \mathcal{L}\{e^{2t} * \sin t\} = \frac{1}{(s - 2)(s^2 + 1)}$$

$$11. \mathcal{L}\left\{ \int_0^t e^\tau d\tau \right\} = \frac{1}{s} \mathcal{L}\{e^t\} = \frac{1}{s(s - 1)}$$

$$12. \mathcal{L}\left\{ \int_0^t \cos \tau d\tau \right\} = \frac{1}{s} \mathcal{L}\{\cos t\} = \frac{s}{s(s^2 + 1)} = \frac{1}{s^2 + 1}$$

$$13. \mathcal{L}\left\{ \int_0^t e^{-\tau} \cos \tau d\tau \right\} = \frac{1}{s} \mathcal{L}\{e^{-t} \cos t\} = \frac{1}{s} \frac{s + 1}{(s + 1)^2 + 1} = \frac{s + 1}{s(s^2 + 2s + 2)}$$

$$14. \mathcal{L}\left\{ \int_0^t \tau \sin \tau d\tau \right\} = \frac{1}{s} \mathcal{L}\{t \sin t\} = \frac{1}{s} \left( -\frac{d}{ds} \frac{1}{s^2 + 1} \right) = -\frac{1}{s} \frac{-2s}{(s^2 + 1)^2} = \frac{2}{(s^2 + 1)^2}$$

$$15. \mathcal{L}\left\{ \int_0^t \tau e^{t-\tau} d\tau \right\} = \mathcal{L}\{t\} \mathcal{L}\{e^t\} = \frac{1}{s^2(s - 1)}$$

### Exercises 7.4

16.  $\mathcal{L}\left\{\int_0^t \sin \tau \cos(t-\tau) d\tau\right\} = \mathcal{L}\{\sin t\} \mathcal{L}\{\cos t\} = \frac{s}{(s^2+1)^2}$
17.  $\mathcal{L}\left\{t \int_0^t \sin \tau d\tau\right\} = -\frac{d}{ds} \mathcal{L}\left\{\int_0^t \sin \tau d\tau\right\} = -\frac{d}{ds} \left(\frac{1}{s} \frac{1}{s^2+1}\right) = \frac{3s^2+1}{s^2(s^2+1)^2}$
18.  $\mathcal{L}\left\{t \int_0^t \tau e^{-\tau} d\tau\right\} = -\frac{d}{ds} \mathcal{L}\left\{t \int_0^t \tau e^{-\tau} d\tau\right\} = -\frac{d}{ds} \left(\frac{1}{s} \frac{1}{(s+1)^2}\right) = \frac{3s+1}{s^2(s+1)^3}$
19. (a)  $\mathcal{L}^{-1}\left\{\frac{1}{s(s-1)}\right\} = \mathcal{L}^{-1}\left\{\frac{1/(s-1)}{s}\right\} = \int_0^t e^\tau d\tau = e^t - 1$
- (b)  $\mathcal{L}^{-1}\left\{\frac{1}{s^2(s-1)}\right\} = \mathcal{L}^{-1}\left\{\frac{1/s(s-1)}{s}\right\} = \int_0^t (e^\tau - 1) d\tau = e^t - t - 1$
- (c)  $\mathcal{L}^{-1}\left\{\frac{1}{s^3(s-1)}\right\} = \mathcal{L}^{-1}\left\{\frac{1/s^2(s-1)}{s}\right\} = \int_0^t (e^\tau - \tau - 1) d\tau = e^t - \frac{1}{2}t^2 - t - 1$
20. (a) The result in (4) is  $\mathcal{L}^{-1}\{F(s)G(s)\} = f * g$ , so identify

$$F(s) = \frac{2k^3}{(s^2+k^2)^2} \quad \text{and} \quad G(s) = \frac{4s}{s^2+k^2}.$$

Then

$$f(t) = \sin kt - kt \cos kt \quad \text{and} \quad g(t) = 4 \cos kt$$

so

$$\begin{aligned} \mathcal{L}^{-1}\left\{\frac{8k^3s}{(s^2+k^2)^2}\right\} &= \mathcal{L}^{-1}\{F(s)G(s)\} = f * g = 4 \int_0^t f(\tau)g(t-\tau) d\tau \\ &= 4 \int_0^t (\sin k\tau - k\tau \cos k\tau) \cos k(t-\tau) d\tau. \end{aligned}$$

Using a CAS to evaluate the integral we get

$$\mathcal{L}^{-1}\left\{\frac{8k^3s}{(s^2+k^2)^3}\right\} = t \sin kt - kt^2 \cos kt.$$

- (b) Observe from part (a) that

$$\mathcal{L}\{t(\sin kt - kt \cos kt)\} = \frac{8k^3s}{(s^2+k^2)^3},$$

and from Theorem 7.8 that  $\mathcal{L}\{tf(t)\} = -F'(s)$ . We saw in (5) that  $\mathcal{L}\{\sin kt - kt \cos kt\} = 2k^3/(s^2+k^2)^2$ , so

$$\mathcal{L}\{t(\sin kt - kt \cos kt)\} = -\frac{d}{ds} \frac{2k^3}{(s^2+k^2)^2} = \frac{8k^3s}{(s^2+k^2)^3}.$$



$$21. \mathcal{L}\{f(t)\} = \frac{1}{1 - e^{-2as}} \left[ \int_0^a e^{-st} dt - \int_a^{2a} e^{-st} dt \right] = \frac{(1 - e^{-as})^2}{s(1 - e^{-2as})} = \frac{1 - e^{-as}}{s(1 + e^{-as})}$$

$$22. \mathcal{L}\{f(t)\} = \frac{1}{1 - e^{-2as}} \int_0^a e^{-st} dt = \frac{1}{s(1 + e^{-as})}$$

$$23. \mathcal{L}\{f(t)\} = \frac{1}{1 - e^{-bs}} \int_0^b \frac{a}{b} t e^{-st} dt = \frac{a}{s} \left( \frac{1}{bs} - \frac{1}{e^{bs} - 1} \right)$$

$$24. \mathcal{L}\{f(t)\} = \frac{1}{1 - e^{-2s}} \left[ \int_0^1 t e^{-st} dt + \int_1^2 (2 - t) e^{-st} dt \right] = \frac{1 - e^{-s}}{s^2(1 - e^{-2s})}$$

$$25. \mathcal{L}\{f(t)\} = \frac{1}{1 - e^{-\pi s}} \int_0^\pi e^{-st} \sin t dt = \frac{1}{s^2 + 1} \cdot \frac{e^{\pi s/2} + e^{-\pi s/2}}{e^{\pi s/2} - e^{-\pi s/2}} = \frac{1}{s^2 + 1} \coth \frac{\pi s}{2}$$

$$26. \mathcal{L}\{f(t)\} = \frac{1}{1 - e^{-2\pi s}} \int_0^\pi e^{-st} \sin t dt = \frac{1}{s^2 + 1} \cdot \frac{1}{1 - e^{-\pi s}}$$

27. The Laplace transform of the differential equation is

$$s \mathcal{L}\{y\} + \mathcal{L}\{y\} = \frac{2s}{(s^2 + 1)^2}.$$

Solving for  $\mathcal{L}\{y\}$  we obtain

$$\mathcal{L}\{y\} = \frac{2s}{(s+1)(s^2+1)^2} = -\frac{1}{2} \frac{1}{s+1} - \frac{1}{2} \frac{1}{s^2+1} + \frac{1}{2} \frac{s}{s^2+1} + \frac{1}{(s^2+1)^2} + \frac{s}{(s^2+1)^2}.$$

Thus

$$\begin{aligned} y(t) &= -\frac{1}{2} e^{-t} - \frac{1}{2} \sin t + \frac{1}{2} \cos t + \frac{1}{2} (\sin t - t \cos t) + \frac{1}{2} t \sin t \\ &= -\frac{1}{2} e^{-t} + \frac{1}{2} \cos t - \frac{1}{2} t \cos t + \frac{1}{2} t \sin t. \end{aligned}$$

28. The Laplace transform of the differential equation is

$$s \mathcal{L}\{y\} - \mathcal{L}\{y\} = \frac{2(s-1)}{((s-1)^2 + 1)^2}.$$

Solving for  $\mathcal{L}\{y\}$  we obtain

$$\mathcal{L}\{y\} = \frac{2}{((s-1)^2 + 1)^2}.$$

Thus

$$y = e^t \sin t - t e^t \cos t.$$

29. The Laplace transform of the differential equation is

$$s^2 \mathcal{L}\{y\} - s y(0) - y'(0) + 9 \mathcal{L}\{y\} = \frac{s}{s^2 + 9}.$$

### Exercises 7.4

Letting  $y(0) = 2$  and  $y'(0) = 5$  and solving for  $\mathcal{L}\{y\}$  we obtain

$$\mathcal{L}\{y\} = \frac{2s^3 + 5s^2 + 19s - 45}{(s^2 + 9)^2} = \frac{2s}{s^2 + 9} + \frac{5}{s^2 + 9} + \frac{s}{(s^2 + 9)^2}.$$

Thus

$$y = 2 \cos 3t + \frac{5}{3} \sin 3t + \frac{1}{6}t \sin 3t.$$

30. The Laplace transform of the differential equation is

$$s^2 \mathcal{L}\{y\} - sy(0) - y'(0) + \mathcal{L}\{y\} = \frac{1}{s^2 + 1}.$$

Solving for  $\mathcal{L}\{y\}$  we obtain

$$\mathcal{L}\{y\} = \frac{s^3 - s^2 + s}{(s^2 + 1)^2} = \frac{s}{s^2 + 1} - \frac{1}{s^2 + 1} + \frac{1}{(s^2 + 1)^2}.$$

Thus

$$y = \cos t - \frac{1}{2} \sin t - \frac{1}{2}t \cos t.$$

31. The Laplace transform of the differential equation is

$$s^2 \mathcal{L}\{y\} - sy(0) - y'(0) + 16 \mathcal{L}\{y\} = \mathcal{L}\{\cos 4t - \cos 4t \mathcal{U}(t - \pi)\}$$

or

$$\begin{aligned} (s^2 + 16) \mathcal{L}\{y\} &= 1 + \frac{s}{s^2 + 16} - e^{-\pi s} \mathcal{L}\{\cos 4(t + \pi)\} \\ &= 1 + \frac{s}{s^2 + 16} - e^{-\pi s} \mathcal{L}\{\cos 4t\} \\ &= 1 + \frac{s}{s^2 + 16} - \frac{s}{s^2 + 16} e^{-\pi s}. \end{aligned}$$

Thus

$$\mathcal{L}\{y\} = \frac{1}{s^2 + 16} + \frac{s}{(s^2 + 16)^2} - \frac{s}{(s^2 + 16)^2} e^{-\pi s}$$

and

$$y = \frac{1}{4} \sin 4t + \frac{1}{8}t \sin 4t - \frac{1}{8}(t - \pi) \sin 4(t - \pi) \mathcal{U}(t - \pi).$$

32. The Laplace transform of the differential equation is

$$s^2 \mathcal{L}\{y\} - sy(0) - y'(0) + \mathcal{L}\{y\} = \mathcal{L}\left\{1 - \mathcal{U}\left(t - \frac{\pi}{2}\right) + \sin t \mathcal{U}\left(t - \frac{\pi}{2}\right)\right\}$$

or

$$\begin{aligned} (s^2 + 1) \mathcal{L}\{y\} &= s + \frac{1}{s} - \frac{1}{s} e^{-\pi s/2} + e^{-\pi s/2} \mathcal{L}\left\{\sin\left(t + \frac{\pi}{2}\right)\right\} \\ &= s + \frac{1}{s} - \frac{1}{s} e^{-\pi s/2} + e^{-\pi s/2} \mathcal{L}\{\cos t\} \\ &= s + \frac{1}{s} - \frac{1}{s} e^{-\pi s/2} + \frac{s}{s^2 + 1} e^{-\pi s/2}. \end{aligned}$$

Thus

$$\begin{aligned}\mathcal{L}\{y\} &= \frac{s}{s^2+1} + \frac{1}{s(s^2+1)} - \frac{1}{s(s^2+1)}e^{-\pi s/2} + \frac{s}{(s^2+1)^2}e^{-\pi s/2} \\ &= \frac{s}{s^2+1} + \frac{1}{s} - \frac{s}{s^2+1} - \left(\frac{1}{s} - \frac{s}{s^2+1}\right)e^{-\pi s/2} + \frac{s}{(s^2+1)^2}e^{-\pi s/2} \\ &= \frac{1}{s} - \left(\frac{1}{s} - \frac{s}{s^2+1}\right)e^{-\pi s/2} + \frac{s}{(s^2+1)^2}e^{-\pi s/2}\end{aligned}$$

and

$$\begin{aligned}y &= 1 - \left[1 - \cos\left(t - \frac{\pi}{2}\right)\right] \mathcal{U}\left(t - \frac{\pi}{2}\right) + \frac{1}{2}\left(t - \frac{\pi}{2}\right) \sin\left(t - \frac{\pi}{2}\right) \mathcal{U}\left(t - \frac{\pi}{2}\right) \\ &= 1 - (1 - \sin t) \mathcal{U}\left(t - \frac{\pi}{2}\right) + \frac{1}{2}\left(t - \frac{\pi}{2}\right) \cos t \mathcal{U}\left(t - \frac{\pi}{2}\right).\end{aligned}$$

33. The Laplace transform of the differential equation is

$$s^2 \mathcal{L}\{y\} + \mathcal{L}\{y\} = \frac{1}{(s^2+1)} + \frac{2s}{(s^2+1)^2}.$$

Thus

$$\mathcal{L}\{y\} = \frac{1}{(s^2+1)^2} + \frac{2s}{(s^2+1)^3}$$

and, using Problem 20,

$$y = \frac{1}{2}(\sin t - t \cos t) + \frac{1}{4}(t \sin t - t^2 \cos t).$$

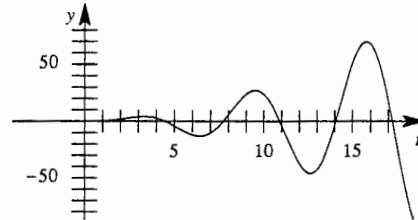

34. (a)

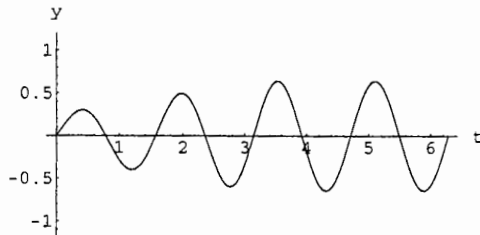

(b)

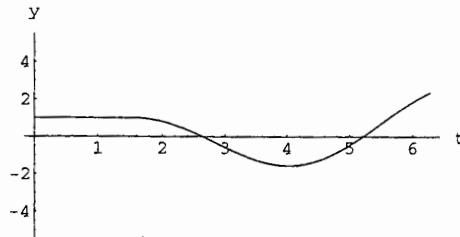

### Exercises 7.4

35. The Laplace transform of the given equation is

$$\mathcal{L}\{f\} + \mathcal{L}\{t\}\mathcal{L}\{f\} = \mathcal{L}\{t\}.$$

Solving for  $\mathcal{L}\{f\}$  we obtain  $\mathcal{L}\{f\} = \frac{1}{s^2 + 1}$ . Thus,  $f(t) = \sin t$ .

36. The Laplace transform of the given equation is

$$\mathcal{L}\{f\} = \mathcal{L}\{2t\} - 4\mathcal{L}\{\sin t\}\mathcal{L}\{f\}.$$

Solving for  $\mathcal{L}\{f\}$  we obtain

$$\mathcal{L}\{f\} = \frac{2s^2 + 2}{s^2(s^2 + 5)} = \frac{2}{5} \frac{1}{s^2} + \frac{8}{5\sqrt{5}} \frac{\sqrt{5}}{s^2 + 5}.$$

Thus

$$f(t) = \frac{2}{5}t + \frac{8}{5\sqrt{5}} \sin \sqrt{5}t.$$

37. The Laplace transform of the given equation is

$$\mathcal{L}\{f\} = \mathcal{L}\{te^t\} + \mathcal{L}\{t\}\mathcal{L}\{f\}.$$

Solving for  $\mathcal{L}\{f\}$  we obtain

$$\mathcal{L}\{f\} = \frac{s^2}{(s-1)^3(s+1)} = \frac{1}{8} \frac{1}{s-1} + \frac{3}{4} \frac{1}{(s-1)^2} + \frac{1}{4} \frac{2}{(s-1)^3} - \frac{1}{8} \frac{1}{s+1}.$$

Thus

$$f(t) = \frac{1}{8}e^t + \frac{3}{4}te^t + \frac{1}{4}t^2e^t - \frac{1}{8}e^{-t}$$

38. The Laplace transform of the given equation is

$$\mathcal{L}\{f\} + 2\mathcal{L}\{\cos t\}\mathcal{L}\{f\} = 4\mathcal{L}\{e^{-t}\} + \mathcal{L}\{\sin t\}.$$

Solving for  $\mathcal{L}\{f\}$  we obtain

$$\mathcal{L}\{f\} = \frac{4s^2 + s + 5}{(s+1)^3} = \frac{4}{s+1} - \frac{7}{(s+1)^2} + 4\frac{2}{(s+1)^3}.$$

Thus

$$f(t) = 4e^{-t} - 7te^{-t} + 4t^2e^{-t}.$$

39. The Laplace transform of the given equation is

$$\mathcal{L}\{f\} + \mathcal{L}\{1\}\mathcal{L}\{f\} = \mathcal{L}\{1\}.$$

Solving for  $\mathcal{L}\{f\}$  we obtain  $\mathcal{L}\{f\} = \frac{1}{s+1}$ . Thus,  $f(t) = e^{-t}$ .

40. The Laplace transform of the given equation is

$$\mathcal{L}\{f\} = \mathcal{L}\{\cos t\} + \mathcal{L}\{e^{-t}\}\mathcal{L}\{f\}.$$

Solving for  $\mathcal{L}\{f\}$  we obtain

$$\mathcal{L}\{f\} = \frac{s}{s^2+1} + \frac{1}{s^2+1}.$$

Thus

$$f(t) = \cos t + \sin t.$$

41. The Laplace transform of the given equation is

$$\mathcal{L}\{f\} = \mathcal{L}\{1\} + \mathcal{L}\{t\} - \frac{8}{3}\mathcal{L}\{t^3\}\mathcal{L}\{f\}.$$

Solving for  $\mathcal{L}\{f\}$  we obtain

$$\mathcal{L}\{f\} = \frac{s^2(s+1)}{s^4+16} = \frac{s^3}{s^4+16} + \frac{s^2}{s^4+16}.$$

Thus

$$f(t) = \cos \sqrt{2}t \cosh \sqrt{2}t + \frac{1}{2\sqrt{2}}(\sin \sqrt{2}t \cosh \sqrt{2}t + \cos \sqrt{2}t \sinh \sqrt{2}t).$$

42. The Laplace transform of the given equation is

$$\mathcal{L}\{t\} - 2\mathcal{L}\{f\} = \mathcal{L}\{e^t - e^{-t}\}\mathcal{L}\{f\}.$$

Solving for  $\mathcal{L}\{f\}$  we obtain

$$\mathcal{L}\{f\} = \frac{s^2-1}{2s^4} = \frac{1}{2} \frac{1}{s^2} - \frac{1}{12} \frac{3!}{s^4}.$$

Thus

$$f(t) = \frac{1}{2}t - \frac{1}{12}t^3.$$

43. The Laplace transform of the given equation is

$$s\mathcal{L}\{y\} - y(0) = \mathcal{L}\{1\} - \mathcal{L}\{\sin t\} - \mathcal{L}\{1\}\mathcal{L}\{y\}.$$

Solving for  $\mathcal{L}\{y\}$  we obtain

$$\mathcal{L}\{y\} = \frac{s^3 - s^2 + s}{s(s^2+1)^2} = \frac{1}{s^2+1} + \frac{1}{2} \frac{2s}{(s^2+1)^2}.$$

Thus

$$y = \sin t - \frac{1}{2}t \sin t.$$

44. The Laplace transform of the given equation is

$$s\mathcal{L}\{y\} - y(0) + 6\mathcal{L}\{y\} + 9\mathcal{L}\{1\}\mathcal{L}\{y\} = \mathcal{L}\{1\}.$$

### Exercises 7.4

Solving for  $\mathcal{L}\{f\}$  we obtain  $\mathcal{L}\{y\} = \frac{1}{(s+3)^2}$ . Thus,  $y = te^{-3t}$ .

45. The differential equation is

$$0.1 \frac{di}{dt} + 3i + \frac{1}{0.05} \int_0^t i(\tau) d\tau = 100[\mathcal{U}(t-1) - \mathcal{U}(t-2)]$$

or

$$\frac{di}{st} + 30i + 200 \int_0^t i(\tau) d\tau = 1000[\mathcal{U}(t-1) - \mathcal{U}(t-2)],$$

where  $i(0) = 0$ . The Laplace transform of the differential equation is

$$s \mathcal{L}\{i\} - y(0) + 30 \mathcal{L}\{i\} + \frac{200}{s} \mathcal{L}\{i\} = \frac{1000}{s} (e^{-s} - e^{-2s}).$$

Solving for  $\mathcal{L}\{i\}$  we obtain

$$\mathcal{L}\{i\} = \frac{1000e^{-s} - 1000e^{-2s}}{s^2 + 30s + 200} = \left( \frac{100}{s+10} - \frac{100}{s+20} \right) (e^{-s} - e^{-2s}).$$

Thus

$$i(t) = 100(e^{-10(t-1)} - e^{-20(t-1)}) \mathcal{U}(t-1) - 100(e^{-10(t-2)} - e^{-20(t-2)}) \mathcal{U}(t-2).$$

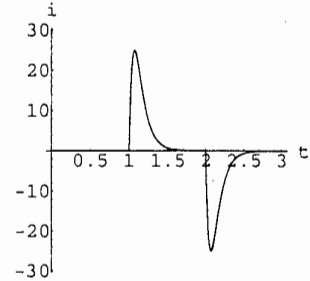

46. The differential equation is

$$0.005 \frac{di}{dt} + i + \frac{1}{0.02} \int_0^t i(\tau) d\tau = 100[t - (t-1) \mathcal{U}(t-1)]$$

or

$$\frac{di}{st} + 200i + 10,000 \int_0^t i(\tau) d\tau = 20,000[t - (t-1) \mathcal{U}(t-1)],$$

where  $i(0) = 0$ . The Laplace transform of the differential equation is

$$s \mathcal{L}\{i\} + 200 \mathcal{L}\{i\} + \frac{10,000}{s} \mathcal{L}\{i\} = 20,000 \left( \frac{1}{s^2} - \frac{1}{s^2} e^{-s} \right).$$

Solving for  $\mathcal{L}\{i\}$  we obtain

$$\mathcal{L}\{i\} = \frac{20,000}{s(s+100)^2} (1 - e^{-s}) = \left[ \frac{2}{s} - \frac{2}{s+100} - \frac{200}{(s+100)^2} \right] (1 - e^{-s}).$$

Thus

$$i(t) = 2 - 2e^{-100t} - 200te^{-100t} - 2\mathcal{U}(t-1) + 2e^{-100(t-1)} \mathcal{U}(t-1) + 200(t-1)e^{-100(t-1)} \mathcal{U}(t-1).$$

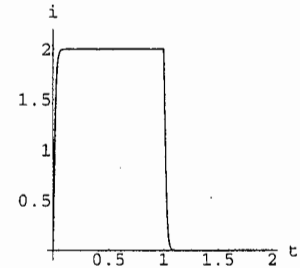

47. The differential equation is

$$\frac{di}{dt} + i = E(t),$$

where  $i(0) = 0$ . The Laplace transform of this equation is

$$s \mathcal{L}\{i\} + \mathcal{L}\{i\} = \mathcal{L}\{E(t)\}.$$

From Problem 21 we have

$$\mathcal{L}\{E(t)\} = \frac{1 - e^{-s}}{s(1 + e^{-s})}.$$

Thus

$$(s + 1) \mathcal{L}\{i\} = \frac{1 - e^{-s}}{s(1 + e^{-s})}$$

and

$$\begin{aligned} \mathcal{L}\{i\} &= \frac{1 - e^{-s}}{s(s + 1)(1 + e^{-s})} = \frac{1 - e^{-s}}{s(s + 1)} \frac{1}{1 + e^{-s}} \\ &= \left(\frac{1}{s} - \frac{1}{s + 1}\right) (1 - e^{-s})(1 - e^{-s} + e^{-2s} - e^{-3s} + e^{-4s} - \dots) \\ &= \left(\frac{1}{s} - \frac{1}{s + 1}\right) (1 - 2e^{-s} + 2e^{-2s} - 2e^{-3s} + 2e^{-4s} - \dots). \end{aligned}$$

Therefore

$$\begin{aligned} i(t) &= [1 - 2\mathcal{U}(t - 1) + 2\mathcal{U}(t - 2) - 2\mathcal{U}(t - 3) + 2\mathcal{U}(t - 4) - \dots] \\ &\quad - [e^{-t} + 2e^{-(t-1)}\mathcal{U}(t - 1) - 2e^{-(t-2)}\mathcal{U}(t - 2) \\ &\quad + 2e^{-(t-3)}\mathcal{U}(t - 3) - 2e^{-(t-4)}\mathcal{U}(t - 4) + \dots] \\ &= 1 - e^{-t} + 2 \sum_{n=1}^{\infty} (-1)^n (1 - e^{-(t-n)}) \mathcal{U}(t - n). \end{aligned}$$

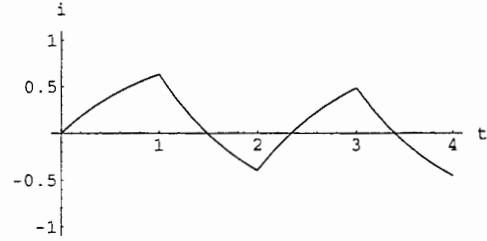

### Exercises 7.4

48. The differential equation is

$$\frac{di}{dt} + i = E(t),$$

where  $i(0) = 0$ . The Laplace transform of this equation is

$$s \mathcal{L}\{i\} + \mathcal{L}\{i\} = \mathcal{L}\{E(t)\}.$$

From Problem 23 we have

$$\mathcal{L}\{E(t)\} = \frac{1}{s} \left( \frac{1}{s} - \frac{1}{e^s - 1} \right) = \frac{1}{s^2} - \frac{1}{s} \frac{1}{e^s - 1}.$$

Thus

$$(s+1) \mathcal{L}\{i\} = \frac{1}{s^2} - \frac{1}{s} \frac{1}{e^s - 1}$$

and

$$\begin{aligned} \mathcal{L}\{i\} &= \frac{1}{s^2(s+1)} - \frac{1}{s(s+1)} \frac{1}{e^s - 1} \\ &= \left( \frac{1}{s^2} - \frac{1}{s} + \frac{1}{s+1} \right) - \left( \frac{1}{s} - \frac{1}{s+1} \right) \frac{1}{e^s - 1} \\ &= \left( \frac{1}{s^2} - \frac{1}{s} + \frac{1}{s+1} \right) - \left( \frac{1}{s} - \frac{1}{s+1} \right) (e^{-s} + e^{-2s} + e^{-3s} + e^{-4s} - \dots). \end{aligned}$$

Therefore

$$\begin{aligned} i(t) &= (t-1 + e^{-t}) - (1 - e^{-(t-1)}) \mathcal{U}(t-1) - (1 - e^{-(t-2)}) \mathcal{U}(t-2) \\ &\quad - (1 - e^{-(t-3)}) \mathcal{U}(t-3) - (1 - e^{-(t-4)}) \mathcal{U}(t-4) - \dots \\ &= (t-1 + e^{-t}) - \sum_{n=1}^{\infty} (1 - e^{-(t-n)}) \mathcal{U}(t-n). \end{aligned}$$

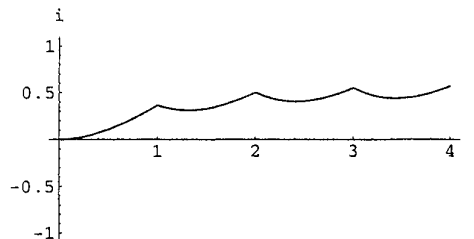

49. The differential equation is  $x'' + 2x' + 10x = 20f(t)$ , where  $f(t)$  is the meander function with  $a = \pi$ . Using the initial conditions  $x(0) = x'(0) = 0$  and taking the Laplace transform we obtain

$$\begin{aligned} (s^2 + 2s + 10) \mathcal{L}\{x(t)\} &= \frac{20}{s} (1 - e^{-\pi s}) \frac{1}{1 + e^{-\pi s}} \\ &= \frac{20}{s} (1 - e^{-\pi s}) (1 - e^{-\pi s} + e^{-2\pi s} - e^{-3\pi s} + \dots) \\ &= \frac{20}{s} (1 - 2e^{-\pi s} + 2e^{-2\pi s} - 2e^{-3\pi s} + \dots) \\ &= \frac{20}{s} + \frac{40}{s} \sum_{n=1}^{\infty} (-1)^n e^{-n\pi s}. \end{aligned}$$



Then

$$\begin{aligned}\mathcal{L}\{x(t)\} &= \frac{20}{s(s^2 + 2s + 10)} + \frac{40}{s(s^2 + 2s + 10)} \sum_{n=1}^{\infty} (-1)^n e^{-n\pi s} \\ &= \frac{2}{s} - \frac{2s + 4}{s^2 + 2s + 10} + \sum_{n=1}^{\infty} (-1)^n \left[ \frac{4}{s} - \frac{4s + 8}{s^2 + 2s + 10} \right] e^{-n\pi s} \\ &= \frac{2}{s} - \frac{2(s+1) + 2}{(s+1)^2 + 9} + 4 \sum_{n=1}^{\infty} (-1)^n \left[ \frac{1}{s} - \frac{(s+1) + 1}{(s+1)^2 + 9} \right] e^{-n\pi s}\end{aligned}$$

and

$$\begin{aligned}x(t) &= 2 \left( 1 - e^{-t} \cos 3t - \frac{1}{3} e^{-t} \sin 3t \right) + 4 \sum_{n=1}^{\infty} (-1)^n \left[ 1 - e^{-(t-n\pi)} \cos 3(t-n\pi) \right. \\ &\quad \left. - \frac{1}{3} e^{-(t-n\pi)} \sin 3(t-n\pi) \right] \mathcal{U}(t-n\pi).\end{aligned}$$

The graph of  $x(t)$  on the interval  $[0, 2\pi)$  is shown below.

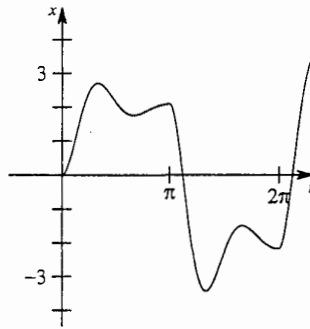

50. The differential equation is  $x'' + 2x' + x = 5f(t)$ , where  $f(t)$  is the square wave function with  $a = \pi$ . Using the initial conditions  $x(0) = x'(0) = 0$  and taking the Laplace transform, we obtain

$$\begin{aligned}(s^2 + 2s + 1) \mathcal{L}\{x(t)\} &= \frac{5}{s} \frac{1}{1 + e^{-\pi s}} = \frac{5}{s} (1 - e^{-\pi s} + e^{-2\pi s} - e^{-3\pi s} + e^{-4\pi s} - \dots) \\ &= \frac{5}{s} \sum_{n=0}^{\infty} (-1)^n e^{-n\pi s}.\end{aligned}$$

Then

$$\mathcal{L}\{x(t)\} = \frac{5}{s(s+1)^2} \sum_{n=0}^{\infty} (-1)^n e^{-n\pi s} = 5 \sum_{n=0}^{\infty} (-1)^n \left( \frac{1}{s} - \frac{1}{s+1} - \frac{1}{(s+1)^2} \right) e^{-n\pi s}$$

and

$$x(t) = 5 \sum_{n=0}^{\infty} (-1)^n (1 - e^{-(t-n\pi)} - (t-n\pi)e^{-(t-n\pi)}) \mathcal{U}(t-n\pi).$$

### Exercises 7.4

The graph of  $x(t)$  on the interval  $[0, 4\pi]$  is shown below.

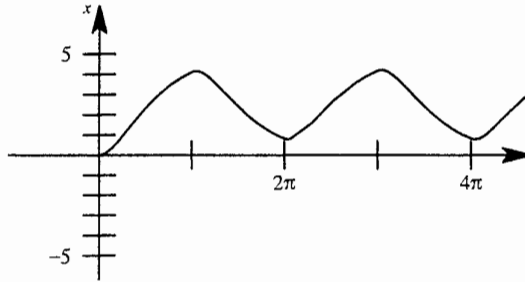

$$51. f(t) = -\frac{1}{t} \mathcal{L}^{-1} \left\{ \frac{d}{ds} [\ln(s-3) - \ln(s+1)] \right\} = -\frac{1}{t} \mathcal{L}^{-1} \left\{ \frac{1}{s-3} - \frac{1}{s+1} \right\} = -\frac{1}{t} (e^{3t} - e^{-t})$$

52. By definition,  $t * \mathcal{U}(t-a) = \int_0^t (t-\tau) \mathcal{U}(\tau-a) d\tau$ . We consider separately the cases when  $a < t$  and when  $a > t$ . When  $a < t$ , then

$$\int_0^t (t-\tau) \mathcal{U}(\tau-a) d\tau = \int_a^t (t-\tau) d\tau = -\frac{(t-\tau)^2}{2} \Big|_a^t = \frac{1}{2}(t-a)^2.$$

When  $a > t$ , then  $\mathcal{U}(\tau-a) = 0$  since  $\tau < t < a$  and

$$\int_0^t (t-\tau) \mathcal{U}(\tau-a) d\tau = 0.$$

Therefore

$$t * \mathcal{U}(t-a) = \begin{cases} \frac{1}{2}(t-a)^2, & t > a \\ 0, & t < a \end{cases} = \frac{1}{2}(t-a)^2 \mathcal{U}(t-a).$$

53. First method: By the definition of the Laplace transform and integration by parts we have

$$\begin{aligned} \mathcal{L} \left\{ \int_0^t f(\tau) d\tau \right\} &= \int_0^\infty e^{-st} \left( \int_0^t f(\tau) d\tau \right) dt \\ &= -\frac{e^{-st}}{s} \int_0^t f(\tau) d\tau \Big|_0^\infty + \frac{1}{s} \int_0^\infty e^{-st} f(t) dt \\ &= \frac{1}{s} \int_0^\infty e^{-st} f(t) dt = \frac{F(s)}{s}. \end{aligned}$$

Second Method: Let  $g(t) = \int_0^t f(\tau) d\tau$ ; then  $g'(t) = f(t)$  and  $g(0) = 0$ . By Theorem 7.8

$$\mathcal{L}\{g'(t)\} = s \mathcal{L}\{g(t)\} - g(0) = s \mathcal{L}\{g(t)\},$$

so

$$\mathcal{L}\{f(t)\} = s \mathcal{L} \left\{ \int_0^t f(\tau) d\tau \right\},$$

and

$$\mathcal{L} \left\{ \int_0^t f(\tau) d\tau \right\} = \frac{1}{s} \mathcal{L}\{f(t)\} = \frac{F(s)}{s}.$$

54. Let  $u = t - \tau$  so that  $du = d\tau$  and

$$f * g = \int_0^t f(\tau)g(t - \tau) d\tau = - \int_t^0 f(t - u)g(u)du = g * f.$$

55. (a) Using Theorem 7.8, the Laplace transform of the differential equation is

$$\begin{aligned} -\frac{d}{ds} [s^2 Y - sy(0) - y'(0)] + sY - y(0) + \frac{d}{ds} [sY - y(0)] + nY \\ = -\frac{d}{ds} [s^2 Y] + sY + \frac{d}{ds} [sY] + nY \\ = -s^2 \left( \frac{d}{ds} Y \right) - 2sY + sY + s \left( \frac{d}{ds} Y \right) + Y + nY \\ = (s - s^2) \left( \frac{d}{ds} Y \right) + (1 + n - s)Y = 0. \end{aligned}$$

Separating variables, we find

$$\begin{aligned} \frac{dY}{Y} &= \frac{1 + n - s}{s^2 - s} ds = \left( \frac{n}{s - 1} - \frac{1 + n}{s} \right) ds \\ \ln Y &= n \ln(s - 1) - (1 + n) \ln s + c \\ Y &= c_1 \frac{(s - 1)^n}{s^{1+n}}. \end{aligned}$$

Since the differential equation is homogeneous, any constant multiple of a solution will still be a solution, so for convenience we take  $c_1 = 1$ . The following polynomials are solutions of Laguerre's differential equation:

$$\begin{aligned} n = 0: \quad L_0(t) &= \mathcal{L}^{-1} \left\{ \frac{1}{s} \right\} = 1 \\ n = 1: \quad L_1(t) &= \mathcal{L}^{-1} \left\{ \frac{s - 1}{s^2} \right\} = \mathcal{L}^{-1} \left\{ \frac{1}{s} - \frac{1}{s^2} \right\} = 1 - t \\ n = 2: \quad L_2(t) &= \mathcal{L}^{-1} \left\{ \frac{(s - 1)^2}{s^3} \right\} = \mathcal{L}^{-1} \left\{ \frac{1}{s} - \frac{2}{s^2} + \frac{1}{s^3} \right\} = 1 - 2t + \frac{1}{2}t^2 \\ n = 3: \quad L_3(t) &= \mathcal{L}^{-1} \left\{ \frac{(s - 1)^3}{s^4} \right\} = \mathcal{L}^{-1} \left\{ \frac{1}{s} - \frac{3}{s^2} + \frac{3}{s^3} - \frac{1}{s^4} \right\} = 1 - 3t + \frac{3}{2}t^2 - \frac{1}{6}t^3 \\ n = 4: \quad L_4(t) &= \mathcal{L}^{-1} \left\{ \frac{(s - 1)^4}{s^5} \right\} = \mathcal{L}^{-1} \left\{ \frac{1}{s} - \frac{4}{s^2} + \frac{6}{s^3} - \frac{4}{s^4} + \frac{1}{s^5} \right\} \\ &= 1 - 4t + 3t^2 - \frac{2}{3}t^3 + \frac{1}{24}t^4. \end{aligned}$$

(b) Letting  $f(t) = t^n e^{-t}$  we note that  $f^{(k)}(0) = 0$  for  $k = 1, 2, 3, \dots, n - 1$  and  $f^{(n)}(0) = n!$ .

### Exercises 7.4

Now, by the first translation theorem,

$$\begin{aligned} \mathcal{L}\left\{\frac{e^t}{n!} \frac{d^n}{dt^n} t^n e^{-t}\right\} &= \frac{1}{n!} \mathcal{L}\{e^t f^{(n)}(t)\} = \frac{1}{n!} \mathcal{L}\{f^{(n)}(t)\} \Big|_{s \rightarrow s-1} \\ &= \frac{1}{n!} \left[ s^n \mathcal{L}\{t^n e^{-t}\} - s^{n-1} f(0) - s^{n-2} f'(0) - \dots - f^{(n-1)}(0) \right]_{s \rightarrow s-1} \\ &= \frac{1}{n!} \left[ s^n \mathcal{L}\{t^n e^{-t}\} \right]_{s \rightarrow s-1} \\ &= \frac{1}{n!} \left[ s^n \frac{n!}{(s+1)^{n+1}} \right]_{s \rightarrow s-1} = \frac{(s-1)^n}{s^{n+1}} = Y, \end{aligned}$$

where  $Y = \mathcal{L}\{L_n(t)\}$ . Thus

$$L_n(t) = \frac{e^t}{n!} \frac{d^n}{dt^n} (t^n e^{-t}), \quad n = 0, 1, 2, \dots$$

56. (a) The output for the first three lines of the program are

$$\begin{aligned} 9y[t] + 6y'[t] + y''[t] &= t \sin[t] \\ 1 - 2s + 9Y + s^2 Y + 6(-2 + sY) &= \frac{2s}{(1 + s^2)^2} \\ Y \rightarrow - \left( \frac{-11 - 4s - 22s^2 - 4s^3 - 11s^4 - 2s^5}{(1 + s^2)^2(9 + 6s + s^2)} \right) \end{aligned}$$

The fourth line is the same as the third line with  $Y \rightarrow$  removed. The final line of output shows a solution involving complex coefficients of  $e^{it}$  and  $e^{-it}$ . To get the solution in more standard form write the last line as two lines:

```
euler = {E^(I t) -> Cos[t] + I Sin[t], E^(-I t) -> Cos[t] - I Sin[t]}
InverseLaplaceTransform[Y,s,t]/.euler//Expand
```

We see that the solution is

$$y(t) = \left( \frac{487}{250} + \frac{247}{50}t \right) e^{-3t} + \frac{1}{250} (13 \cos t - 15t \cos t - 9 \sin t + 20t \sin t).$$

(b) The solution is

$$y(t) = \frac{1}{6} e^t - \frac{1}{6} e^{-t/2} \cos \sqrt{15} t - \frac{\sqrt{3/5}}{6} e^{-t/2} \sin \sqrt{15} t.$$

(c) The solution is

$$q(t) = 1 - \cos t + (6 - 6 \cos t) \mathcal{U}(t - 3\pi) - (4 + 4 \cos t) \mathcal{U}(t - \pi).$$

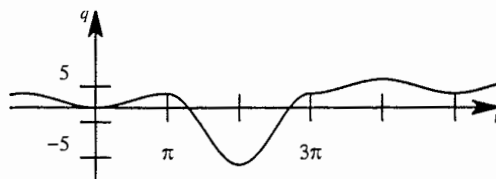

---

### Exercises 7.5

---

1. The Laplace transform of the differential equation yields

$$\mathcal{L}\{y\} = \frac{1}{s-3} e^{-2s}$$

so that

$$y = e^{3(t-2)} \mathcal{U}(t-2).$$

2. The Laplace transform of the differential equation yields

$$\mathcal{L}\{y\} = \frac{2}{s+1} + \frac{e^{-s}}{s+1}$$

so that

$$y = 2e^{-t} + e^{-(t-1)} \mathcal{U}(t-1).$$

3. The Laplace transform of the differential equation yields

$$\mathcal{L}\{y\} = \frac{1}{s^2+1} (1 + e^{-2\pi s})$$

so that

$$y = \sin t + \sin t \mathcal{U}(t-2\pi).$$

4. The Laplace transform of the differential equation yields

$$\mathcal{L}\{y\} = \frac{1}{4} \frac{4}{s^2+16} e^{-2\pi s}$$

so that

$$y = \frac{1}{4} \sin 4(t-2\pi) \mathcal{U}(t-2\pi).$$

5. The Laplace transform of the differential equation yields

$$\mathcal{L}\{y\} = \frac{1}{s^2+1} (e^{-\pi s/2} + e^{-3\pi s/2})$$

### Exercises 7.5

so that

$$\begin{aligned} y &= \sin\left(t - \frac{\pi}{2}\right)\mathcal{U}\left(t - \frac{\pi}{2}\right) + \sin\left(t - \frac{3\pi}{2}\right)\mathcal{U}\left(t - \frac{3\pi}{2}\right) \\ &= -\cos t \mathcal{U}\left(t - \frac{\pi}{2}\right) + \cos t \mathcal{U}\left(t - \frac{\pi}{2}\right). \end{aligned}$$

6. The Laplace transform of the differential equation yields

$$\mathcal{L}\{y\} = \frac{s}{s^2 + 1} + \frac{1}{s^2 + 1}(e^{-2\pi s} + e^{-4\pi s})$$

so that

$$y = \cos t + \sin t[\mathcal{U}(t - 2\pi) + \mathcal{U}(t - 4\pi)].$$

7. The Laplace transform of the differential equation yields

$$\mathcal{L}\{y\} = \frac{1}{s^2 + 2s}(1 + e^{-s}) = \left[\frac{1}{2} \frac{1}{s} - \frac{1}{2} \frac{1}{s + 2}\right](1 + e^{-s})$$

so that

$$y = \frac{1}{2} - \frac{1}{2}e^{-2t} + \left[\frac{1}{2} - \frac{1}{2}e^{-2(t-1)}\right]\mathcal{U}(t - 1).$$

8. The Laplace transform of the differential equation yields

$$\mathcal{L}\{y\} = \frac{s + 1}{s^2(s - 2)} + \frac{1}{s(s - 2)}e^{-2s} = \frac{3}{4} \frac{1}{s - 2} - \frac{3}{4} \frac{1}{s} - \frac{1}{2} \frac{1}{s^2} + \left[\frac{1}{2} \frac{1}{s - 2} - \frac{1}{2} \frac{1}{s}\right]e^{-2s}$$

so that

$$y = \frac{3}{4}e^{2t} - \frac{3}{4} - \frac{1}{2}t + \left[\frac{1}{2}e^{2(t-2)} - \frac{1}{2}\right]\mathcal{U}(t - 2).$$

9. The Laplace transform of the differential equation yields

$$\mathcal{L}\{y\} = \frac{1}{(s + 2)^2 + 1}e^{-2\pi s}$$

so that

$$y = e^{-2(t-2\pi)} \sin t \mathcal{U}(t - 2\pi).$$

10. The Laplace transform of the differential equation yields

$$\mathcal{L}\{y\} = \frac{1}{(s + 1)^2}e^{-s}$$

so that

$$y = (t - 1)e^{-(t-1)}\mathcal{U}(t - 1).$$

11. The Laplace transform of the differential equation yields

$$\begin{aligned} \mathcal{L}\{y\} &= \frac{4 + s}{s^2 + 4s + 13} + \frac{e^{-\pi s} + e^{-3\pi s}}{s^2 + 4s + 13} \\ &= \frac{2}{3} \frac{3}{(s + 2)^2 + 3^2} + \frac{s + 2}{(s + 2)^2 + 3^2} + \frac{1}{3} \frac{3}{(s + 2)^2 + 3^2} (e^{-\pi s} + e^{-3\pi s}) \end{aligned}$$

so that

$$y = \frac{2}{3}e^{-2t} \sin 3t + e^{-2t} \cos 3t + \frac{1}{3}e^{-2(t-\pi)} \sin 3(t-\pi) \mathcal{U}(t-\pi) \\ + \frac{1}{3}e^{-2(t-3\pi)} \sin 3(t-3\pi) \mathcal{U}(t-3\pi).$$

12. The Laplace transform of the differential equation yields

$$\mathcal{L}\{y\} = \frac{1}{(s-1)^2(s-6)} + \frac{e^{-2s} + e^{-4s}}{(s-1)(s-6)} \\ = -\frac{1}{25} \frac{1}{s-1} - \frac{1}{5} \frac{1}{(s-1)^2} + \frac{1}{25} \frac{1}{s-6} + \left[ -\frac{1}{5} \frac{1}{s-1} + \frac{1}{5} \frac{1}{s-6} \right] (e^{-2s} + e^{-4s})$$

so that

$$y = -\frac{1}{25}e^t - \frac{1}{5}te^t + \frac{1}{25}e^{6t} + \left[ -\frac{1}{5}e^{t-2} + \frac{1}{5}e^{6(t-2)} \right] \mathcal{U}(t-2) \\ + \left[ -\frac{1}{5}e^{t-4} + \frac{1}{5}e^{6(t-4)} \right] \mathcal{U}(t-4).$$

13. The Laplace transform of the differential equation yields

$$\mathcal{L}\{y\} = \frac{1}{2} \frac{2}{s^3} y''(0) + \frac{1}{6} \frac{3!}{s^4} y'''(0) + \frac{1}{6} \frac{P_0}{EI} \frac{3!}{s^4} e^{-Ls/2}$$

so that

$$y = \frac{1}{2} y''(0) x^2 + \frac{1}{6} y'''(0) x^3 + \frac{1}{6} \frac{P_0}{EI} \left( X - \frac{L}{2} \right)^3 \mathcal{U}\left( x - \frac{L}{2} \right).$$

Using  $y''(L) = 0$  and  $y'''(L) = 0$  we obtain

$$y = \frac{1}{4} \frac{P_0 L}{EI} x^2 - \frac{1}{6} \frac{P_0}{EI} x^3 + \frac{1}{6} \frac{P_0}{EI} \left( x - \frac{L}{2} \right)^3 \mathcal{U}\left( x - \frac{L}{2} \right) \\ = \begin{cases} \frac{P_0}{EI} \left( \frac{L}{4} x^2 - \frac{1}{6} x^3 \right), & 0 \leq x < \frac{L}{2} \\ \frac{P_0 L^2}{4EI} \left( \frac{1}{2} x - \frac{L}{12} \right), & \frac{L}{2} \leq x \leq L. \end{cases}$$

14. From Problem 13 we know that

$$y = \frac{1}{2} y''(0) x^2 + \frac{1}{6} y'''(0) x^3 + \frac{1}{6} \frac{P_0}{EI} \left( X - \frac{L}{2} \right)^3 \mathcal{U}\left( x - \frac{L}{2} \right).$$

Using  $y(L) = 0$  and  $y'(L) = 0$  we obtain

$$y = \frac{1}{16} \frac{P_0 L}{EI} x^2 - \frac{1}{12} \frac{P_0}{EI} x^3 + \frac{1}{6} \frac{P_0}{EI} \left( x - \frac{L}{2} \right)^3 \mathcal{U}\left( x - \frac{L}{2} \right) \\ = \begin{cases} \frac{P_0}{EI} \left( \frac{L}{16} x^2 - \frac{1}{12} x^3 \right), & 0 \leq x < \frac{L}{2} \\ \frac{P_0}{EI} \left( \frac{L}{16} x^2 - \frac{1}{12} x^3 \right) + \frac{1}{6} \frac{P_0}{EI} \left( x - \frac{L}{2} \right)^3, & \frac{L}{2} \leq x \leq L. \end{cases}$$

### Exercises 7.5

15. The Laplace transform of the differential equation yields

$$\mathcal{L}\{y\} = \frac{1}{s^2 + \omega^2}$$

so that  $y(t) = \sin \omega t$ . Note that  $y'(0) = 1$ , even though the initial condition was  $y'(0) = 0$ .

---

### Exercises 7.6

---

1. Taking the Laplace transform of the system gives

$$s \mathcal{L}\{x\} = -\mathcal{L}\{x\} + \mathcal{L}\{y\}$$

$$s \mathcal{L}\{y\} - 1 = 2 \mathcal{L}\{x\}$$

so that

$$\mathcal{L}\{x\} = \frac{1}{(s-1)(s+2)} = \frac{1}{3} \frac{1}{s-1} - \frac{1}{3} \frac{1}{s+2}$$

and

$$\mathcal{L}\{y\} = \frac{1}{s} + \frac{2}{s(s-1)(s+2)} = \frac{2}{3} \frac{1}{s-1} + \frac{1}{3} \frac{1}{s+2}$$

Then

$$x = \frac{1}{3}e^t - \frac{1}{3}e^{-2t} \quad \text{and} \quad y = \frac{2}{3}e^t + \frac{1}{3}e^{-2t}.$$

2. Taking the Laplace transform of the system gives

$$s \mathcal{L}\{x\} - 1 = 2 \mathcal{L}\{y\} + \frac{1}{s-1}$$

$$s \mathcal{L}\{y\} - 1 = 8 \mathcal{L}\{x\} - \frac{1}{s^2}$$

so that

$$\mathcal{L}\{y\} = \frac{s^3 + 7s^2 - s + 1}{s(s-1)(s^2-16)} = \frac{1}{16} \frac{1}{s} - \frac{8}{15} \frac{1}{s-1} + \frac{173}{96} \frac{1}{s-4} - \frac{53}{160} \frac{1}{s+4}$$

and

$$y = \frac{1}{16} - \frac{8}{15}e^t + \frac{173}{96}e^{4t} - \frac{53}{160}e^{-4t}.$$

Then

$$x = \frac{1}{8}y' + \frac{1}{8}t = \frac{1}{8}t - \frac{1}{15}e^t + \frac{173}{192}e^{4t} + \frac{53}{320}e^{-4t}.$$

3. Taking the Laplace transform of the system gives

$$s \mathcal{L}\{x\} + 1 = \mathcal{L}\{x\} - 2 \mathcal{L}\{y\}$$

$$s \mathcal{L}\{y\} - 2 = 5 \mathcal{L}\{x\} - \mathcal{L}\{y\}$$



so that

$$\mathcal{L}\{x\} = \frac{-s-5}{s^2+9} = -\frac{s}{s^2+9} - \frac{5}{3} \frac{3}{s^2+9}$$

and

$$x = -\cos 3t - \frac{5}{3} \sin 3t.$$

Then

$$y = \frac{1}{2}x - \frac{1}{2}x' = 2 \cos 3t - \frac{7}{3} \sin 3t.$$

4. Taking the Laplace transform of the system gives

$$(s+3)\mathcal{L}\{x\} + s\mathcal{L}\{y\} = \frac{1}{s}$$

$$(s-1)\mathcal{L}\{x\} + (s-1)\mathcal{L}\{y\} = \frac{1}{s-1}$$

so that

$$\mathcal{L}\{y\} = \frac{5s-1}{3s(s-1)^2} = -\frac{1}{3} \frac{1}{s} + \frac{1}{3} \frac{1}{s-1} + \frac{4}{3} \frac{1}{(s-1)^2}$$

and

$$\mathcal{L}\{x\} = \frac{1-2s}{3s(s-1)^2} = \frac{1}{3} \frac{1}{s} - \frac{1}{3} \frac{1}{s-1} - \frac{1}{3} \frac{1}{(s-1)^2}.$$

Then

$$x = \frac{1}{3} - \frac{1}{3}e^t - \frac{1}{3}te^t \quad \text{and} \quad y = -\frac{1}{3} + \frac{1}{3}e^t + \frac{4}{3}te^t.$$

5. Taking the Laplace transform of the system gives

$$(2s-2)\mathcal{L}\{x\} + s\mathcal{L}\{y\} = \frac{1}{s}$$

$$(s-3)\mathcal{L}\{x\} + (s-3)\mathcal{L}\{y\} = \frac{2}{s}$$

so that

$$\mathcal{L}\{x\} = \frac{-s-3}{s(s-2)(s-3)} = -\frac{1}{2} \frac{1}{s} + \frac{5}{2} \frac{1}{s-2} - \frac{2}{s-3}$$

and

$$\mathcal{L}\{y\} = \frac{3s-1}{s(s-2)(s-3)} = -\frac{1}{6} \frac{1}{s} - \frac{5}{2} \frac{1}{s-2} + \frac{8}{3} \frac{1}{s-3}$$

Then

$$x = -\frac{1}{2} + \frac{5}{2}e^{2t} - 2e^{3t} \quad \text{and} \quad y = -\frac{1}{6} - \frac{5}{2}e^{2t} + \frac{8}{3}e^{3t}.$$

6. Taking the Laplace transform of the system gives

$$(s+1)\mathcal{L}\{x\} - (s-1)\mathcal{L}\{y\} = -1$$

$$s\mathcal{L}\{x\} + (s+2)\mathcal{L}\{y\} = 1$$

## Exercises 7.6

so that

$$\mathcal{L}\{y\} = \frac{s + 1/2}{s^2 + s + 1} = \frac{s + 1/2}{(s + 1/2)^2 + (\sqrt{3}/2)^2}$$

and

$$\mathcal{L}\{x\} = \frac{-3/2}{s^2 + s + 1} = \frac{-3/2}{(s + 1/2)^2 + (\sqrt{3}/2)^2}.$$

Then

$$y = e^{-t/2} \cos \frac{\sqrt{3}}{2}t \quad \text{and} \quad x = e^{-t/2} \sin \frac{\sqrt{3}}{2}t.$$

7. Taking the Laplace transform of the system gives

$$(s^2 + 1)\mathcal{L}\{x\} - \mathcal{L}\{y\} = -2$$

$$-\mathcal{L}\{x\} + (s^2 + 1)\mathcal{L}\{y\} = 1$$

so that

$$\mathcal{L}\{x\} = \frac{-2s^2 - 1}{s^4 + 2s^2} = -\frac{1}{2} \frac{1}{s^2} - \frac{3}{2} \frac{1}{s^2 + 2}$$

and

$$x = -\frac{1}{2}t - \frac{3}{2\sqrt{2}} \sin \sqrt{2}t.$$

Then

$$y = x'' + x = -\frac{1}{2}t + \frac{3}{2\sqrt{2}} \sin \sqrt{2}t.$$

8. Taking the Laplace transform of the system gives

$$(s + 1)\mathcal{L}\{x\} + \mathcal{L}\{y\} = 1$$

$$4\mathcal{L}\{x\} - (s + 1)\mathcal{L}\{y\} = 1$$

so that

$$\mathcal{L}\{x\} = \frac{s + 2}{s^2 + 2s + 5} = \frac{s + 1}{(s + 1)^2 + 2^2} + \frac{1}{2} \frac{2}{(s + 1)^2 + 2^2}$$

and

$$\mathcal{L}\{y\} = \frac{-s + 3}{s^2 + 2s + 5} = -\frac{s + 1}{(s + 1)^2 + 2^2} + 2 \frac{2}{(s + 1)^2 + 2^2}.$$

Then

$$x = e^{-t} \cos 2t + \frac{1}{2}e^{-t} \sin 2t \quad \text{and} \quad y = -e^{-t} \cos 2t + 2e^{-t} \sin 2t.$$

9. Adding the equations and then subtracting them gives

$$\frac{d^2x}{dt^2} = \frac{1}{2}t^2 + 2t$$

$$\frac{d^2y}{dt^2} = \frac{1}{2}t^2 - 2t.$$

Taking the Laplace transform of the system gives

$$\mathcal{L}\{x\} = 8\frac{1}{s} + \frac{1}{24}\frac{4!}{s^5} + \frac{1}{3}\frac{3!}{s^4}$$

and

$$\mathcal{L}\{y\} = \frac{1}{24}\frac{4!}{s^5} - \frac{1}{3}\frac{3!}{s^4}$$

so that

$$x = 8 + \frac{1}{24}t^4 + \frac{1}{3}t^3 \quad \text{and} \quad y = \frac{1}{24}t^4 - \frac{1}{3}t^3.$$

10. Taking the Laplace transform of the system gives

$$(s-4)\mathcal{L}\{x\} + s^3\mathcal{L}\{y\} = \frac{6}{s^2+1}$$

$$(s+2)\mathcal{L}\{x\} - 2s^3\mathcal{L}\{y\} = 0$$

so that

$$\mathcal{L}\{x\} = \frac{4}{(s-2)(s^2+1)} = \frac{4}{5}\frac{1}{s-2} - \frac{4}{5}\frac{s}{s^2+1} - \frac{8}{5}\frac{1}{s^2+1}$$

and

$$\mathcal{L}\{y\} = \frac{2s+4}{s^3(s-2)(s^2+1)} = \frac{1}{s} - \frac{2}{s^2} - 2\frac{2}{s^3} + \frac{1}{5}\frac{1}{s-2} - \frac{6}{5}\frac{s}{s^2+1} + \frac{8}{5}\frac{1}{s^2+1}.$$

Then

$$x = \frac{4}{5}e^{2t} - \frac{4}{5}\cos t - \frac{8}{5}\sin t$$

and

$$y = 1 - 2t - 2t^2 + \frac{1}{5}e^{2t} - \frac{6}{5}\cos t + \frac{8}{5}\sin t.$$

11. Taking the Laplace transform of the system gives

$$s^2\mathcal{L}\{x\} + 3(s+1)\mathcal{L}\{y\} = 2$$

$$s^2\mathcal{L}\{x\} + 3\mathcal{L}\{y\} = \frac{1}{(s+1)^2}$$

so that

$$\mathcal{L}\{x\} = -\frac{2s+1}{s^3(s+1)} = \frac{1}{s} + \frac{1}{s^2} + \frac{1}{2}\frac{2}{s^3} - \frac{1}{s+1}.$$

Then

$$x = 1 + t + \frac{1}{2}t^2 - e^{-t}$$

and

$$y = \frac{1}{3}te^{-t} - \frac{1}{3}x'' = \frac{1}{3}te^{-t} + \frac{1}{3}e^{-t} - \frac{1}{3}.$$

### Exercises 7.6

12. Taking the Laplace transform of the system gives

$$\begin{aligned}(s-4)\mathcal{L}\{x\} + 2\mathcal{L}\{y\} &= \frac{2e^{-s}}{s} \\ -3\mathcal{L}\{x\} + (s+1)\mathcal{L}\{y\} &= \frac{1}{2} + \frac{e^{-s}}{s}\end{aligned}$$

so that

$$\begin{aligned}\mathcal{L}\{x\} &= \frac{-1/2}{(s-1)(s-2)} + e^{-s} \frac{1}{(s-1)(s-2)} \\ &= \left[ \frac{1}{2} \frac{1}{s-1} - \frac{1}{2} \frac{1}{s-2} \right] + e^{-s} \left[ -\frac{1}{s-1} + \frac{1}{s-2} \right]\end{aligned}$$

and

$$\begin{aligned}\mathcal{L}\{y\} &= \frac{e^{-s}}{s} + \frac{s/4-1}{(s-1)(s-2)} + e^{-s} \frac{-s/2+2}{(s-1)(s-2)} \\ &= \frac{3}{4} \frac{1}{s-1} - \frac{1}{2} \frac{1}{s-2} + e^{-s} \left[ \frac{1}{s} - \frac{3}{2} \frac{1}{s-1} + \frac{1}{s-2} \right].\end{aligned}$$

Then

$$x = \frac{1}{2}e^t - \frac{1}{2}e^{2t} + [-e^{t-1} + e^{2(t-1)}] \mathcal{U}(t-1)$$

and

$$y = \frac{3}{4}e^t - \frac{1}{2}e^{2t} + \left[ 1 - \frac{3}{2}e^{t-1} + e^{2(t-1)} \right] \mathcal{U}(t-1).$$

13. The system is

$$\begin{aligned}x_1'' &= -3x_1 + 2(x_2 - x_1) \\ x_2'' &= -2(x_2 - x_1) \\ x_1(0) &= 0 \\ x_1'(0) &= 1 \\ x_2(0) &= 1 \\ x_2'(0) &= 0.\end{aligned}$$

Taking the Laplace transform of the system gives

$$\begin{aligned}(s^2+5)\mathcal{L}\{x_1\} - 2\mathcal{L}\{x_2\} &= 1 \\ -2\mathcal{L}\{x_1\} + (s^2+2)\mathcal{L}\{x_2\} &= s\end{aligned}$$

so that

$$\mathcal{L}\{x_1\} = \frac{s^2+2s+2}{s^4+7s^2+6} = \frac{2}{5} \frac{s}{s^2+1} + \frac{1}{5} \frac{1}{s^2+1} - \frac{2}{5} \frac{s}{s^2+6} + \frac{4}{5\sqrt{6}} \frac{\sqrt{6}}{s^2+6}$$

and

$$\mathcal{L}\{x_2\} = \frac{s^3 + 5s + 2}{(s^2 + 1)(s^2 + 6)} = \frac{4}{5} \frac{s}{s^2 + 1} + \frac{2}{5} \frac{1}{s^2 + 1} + \frac{1}{5} \frac{s}{s^2 + 6} - \frac{2}{5\sqrt{6}} \frac{\sqrt{6}}{s^2 + 6}.$$

Then

$$x_1 = \frac{2}{5} \cos t + \frac{1}{5} \sin t - \frac{2}{5} \cos \sqrt{6}t + \frac{4}{5\sqrt{6}} \sin \sqrt{6}t$$

and

$$x_2 = \frac{4}{5} \cos t + \frac{2}{5} \sin t + \frac{1}{5} \cos \sqrt{6}t - \frac{2}{5\sqrt{6}} \sin \sqrt{6}t.$$

14. In this system  $x_1$  and  $x_2$  represent displacements of masses  $m_1$  and  $m_2$  from their equilibrium positions. Since the net forces acting on  $m_1$  and  $m_2$  are

$$-k_1x_1 + k_2(x_2 - x_1) \quad \text{and} \quad -k_2(x_2 - x_1) - k_3x_2,$$

respectively, Newton's second law of motion gives

$$m_1x_1'' = -k_1x_1 + k_2(x_2 - x_1)$$

$$m_2x_2'' = -k_2(x_2 - x_1) - k_3x_2.$$

Using  $k_1 = k_2 = k_3 = 1$ ,  $m_1 = m_2 = 1$ ,  $x_1(0) = 0$ ,  $x_1'(0) = -1$ ,  $x_2(0) = 0$ , and  $x_2'(0) = 1$ , and taking the Laplace transform of the system, we obtain

$$(2 + s^2)\mathcal{L}\{x_1\} - \mathcal{L}\{x_2\} = -1$$

$$\mathcal{L}\{x_1\} - (2 + s^2)\mathcal{L}\{x_2\} = -1$$

so that

$$\mathcal{L}\{x_1\} = -\frac{1}{s^2 + 3} \quad \text{and} \quad \mathcal{L}\{x_2\} = \frac{1}{s^2 + 3}.$$

Then

$$x_1 = -\frac{1}{\sqrt{3}} \sin \sqrt{3}t \quad \text{and} \quad x_2 = \frac{1}{\sqrt{3}} \sin \sqrt{3}t.$$

15. (a) By Kirchoff's first law we have  $i_1 = i_2 + i_3$ . By Kirchoff's second law, on each loop we have  $E(t) = Ri_1 + L_1i_2'$  and  $E(t) = Ri_1 + L_2i_3'$  or  $L_1i_2' + Ri_2 + Ri_3 = E(t)$  and  $L_2i_3' + Ri_2 + Ri_3 = E(t)$ .  
 (b) Taking the Laplace transform of the system

$$0.01i_2' + 5i_2 + 5i_3 = 100$$

$$0.0125i_3' + 5i_2 + 5i_3 = 100$$

gives

$$(s + 500)\mathcal{L}\{i_2\} + 500\mathcal{L}\{i_3\} = \frac{10,000}{s}$$

$$400\mathcal{L}\{i_2\} + (s + 400)\mathcal{L}\{i_3\} = \frac{8,000}{s}$$

### Exercises 7.6

so that

$$\mathcal{L}\{i_3\} = \frac{8,000}{s^2 + 900s} = \frac{80}{9} \frac{1}{s} - \frac{80}{9} \frac{1}{s + 900}.$$

Then

$$i_3 = \frac{80}{9} - \frac{80}{9} e^{-900t} \quad \text{and} \quad i_2 = 20 - 0.0025i_3' - i_3 = \frac{100}{9} - \frac{100}{9} e^{-900t}.$$

(c)  $i_1 = i_2 + i_3 = 20 - 20e^{-900t}$

16. (a) Taking the Laplace transform of the system

$$\begin{aligned} i_2' + i_3' + 10i_2 &= 120 - 120\mathcal{U}(t - 2) \\ -10i_2' + 5i_3' + 5i_3 &= 0 \end{aligned}$$

gives

$$\begin{aligned} (s + 10)\mathcal{L}\{i_2\} + s\mathcal{L}\{i_3\} &= \frac{120}{s}(1 - e^{-2s}) \\ -10s\mathcal{L}\{i_2\} + 5(s + 1)\mathcal{L}\{i_3\} &= 0 \end{aligned}$$

so that

$$\mathcal{L}\{i_2\} = \frac{120(s + 1)}{(3s^2 + 11s + 10)s}(1 - e^{-2s}) = \left[ \frac{48}{s + 5/3} - \frac{60}{s + 2} + \frac{12}{s} \right] (1 - e^{-2s})$$

and

$$\mathcal{L}\{i_3\} = \frac{240}{3s^2 + 11s + 10}(1 - e^{-2s}) = \left[ \frac{240}{s + 5/3} - \frac{240}{s + 2} \right] (1 - e^{-2s}).$$

Then

$$i_2 = 12 + 48e^{-5t/3} - 60e^{-2t} - [12 + 48e^{-5(t-2)/3} - 60e^{-2(t-2)}]\mathcal{U}(t - 2)$$

and

$$i_3 = 240e^{-5t/3} - 240e^{-2t} - [240e^{-5(t-2)/3} - 240e^{-2(t-2)}]\mathcal{U}(t - 2).$$

(b)  $i_1 = i_2 + i_3 = 12 + 288e^{-5t/3} - 300e^{-2t} - [12 + 288e^{-5(t-2)/3} - 300e^{-2(t-2)}]\mathcal{U}(t - 2)$

17. Taking the Laplace transform of the system

$$\begin{aligned} i_2' + 11i_2 + 6i_3 &= 50 \sin t \\ i_3' + 6i_2 + 6i_3 &= 50 \sin t \end{aligned}$$

gives

$$\begin{aligned} (s + 11)\mathcal{L}\{i_2\} + 6\mathcal{L}\{i_3\} &= \frac{50}{s^2 + 1} \\ 6\mathcal{L}\{i_2\} + (s + 6)\mathcal{L}\{i_3\} &= \frac{50}{s^2 + 1} \end{aligned}$$

so that

$$\mathcal{L}\{i_2\} = \frac{50s}{(s+2)(s+15)(s^2+1)} = -\frac{20}{13} \frac{1}{s+2} + \frac{375}{1469} \frac{1}{s+15} + \frac{145}{113} \frac{s}{s^2+1} + \frac{85}{113} \frac{1}{s^2+1}.$$

Then

$$i_2 = -\frac{20}{13}e^{-2t} + \frac{375}{1469}e^{-15t} + \frac{145}{113}\cos t + \frac{85}{113}\sin t$$

and

$$i_3 = \frac{25}{3}\sin t - \frac{1}{6}i_2' - \frac{11}{6}i_2 = \frac{30}{13}e^{-2t} + \frac{250}{1469}e^{-15t} - \frac{280}{113}\cos t + \frac{810}{113}\sin t.$$

18. Taking the Laplace transform of the system

$$0.5i_1' + 50i_2 = 60$$

$$0.005i_2' + i_2 - i_1 = 0$$

gives

$$s\mathcal{L}\{i_1\} + 100\mathcal{L}\{i_2\} = \frac{120}{s}$$

$$-200\mathcal{L}\{i_1\} + (s+200)\mathcal{L}\{i_2\} = 0$$

so that

$$\mathcal{L}\{i_2\} = \frac{24,000}{s(s^2+200s+20,000)} = \frac{6}{5} \frac{1}{s} - \frac{6}{5} \frac{s+100}{(s+100)^2+100^2} - \frac{6}{5} \frac{100}{(s+100)^2+100^2}.$$

Then

$$i_2 = \frac{6}{5} - \frac{6}{5}e^{-100t}\cos 100t - \frac{6}{5}e^{-100t}\sin 100t$$

and

$$i_1 = 0.005i_2' + i_2 = \frac{6}{5} - \frac{6}{5}e^{-100t}\cos 100t.$$

19. Taking the Laplace transform of the system

$$2i_1' + 50i_2 = 60$$

$$0.005i_2' + i_2 - i_1 = 0$$

gives

$$2s\mathcal{L}\{i_1\} + 50\mathcal{L}\{i_2\} = \frac{60}{s}$$

$$-200\mathcal{L}\{i_1\} + (s+200)\mathcal{L}\{i_2\} = 0$$

so that

$$\begin{aligned} \mathcal{L}\{i_2\} &= \frac{6,000}{s(s^2+200s+5,000)} \\ &= \frac{6}{5} \frac{1}{s} - \frac{6}{5} \frac{s+100}{(s+100)^2 - (50\sqrt{2})^2} - \frac{6\sqrt{2}}{5} \frac{50\sqrt{2}}{(s+100)^2 - (50\sqrt{2})^2}. \end{aligned}$$

### Exercises 7.6

Then

$$i_2 = \frac{6}{5} - \frac{6}{5}e^{-100t} \cosh 50\sqrt{2}t - \frac{6\sqrt{2}}{5}e^{-100t} \sinh 50\sqrt{2}t$$

and

$$i_1 = 0.005i_2' + i_2 = \frac{6}{5} - \frac{6}{5}e^{-100t} \cosh 50\sqrt{2}t - \frac{9\sqrt{2}}{10}e^{-100t} \sinh 50\sqrt{2}t.$$

20. (a) Using Kirchoff's first law we write  $i_1 = i_2 + i_3$ . Since  $i_2 = dq/dt$  we have  $i_1 - i_3 = dq/dt$ . Using Kirchoff's second law and summing the voltage drops across the shorter loop gives

$$E(t) = iR_1 + \frac{1}{C}q, \quad (1)$$

so that

$$i_1 = \frac{1}{R_1}E(t) - \frac{1}{R_1C}q.$$

Then

$$\frac{dq}{dt} = i_1 - i_3 = \frac{1}{R_1}E(t) - \frac{1}{R_1C}q - i_3$$

and

$$R_1 \frac{dq}{dt} + \frac{1}{C}q + R_1 i_3 = E(t).$$

Summing the voltage drops across the longer loop gives

$$E(t) = i_1 R_1 + L \frac{di_3}{dt} + R_2 i_3.$$

Combining this with (1) we obtain

$$i_1 R_1 + L \frac{di_3}{dt} + R_2 i_3 = i_1 R_1 + \frac{1}{C}q$$

or

$$L \frac{di_3}{dt} + R_2 i_3 - \frac{1}{C}q = 0.$$

- (b) Using  $L = R_1 = R_2 = C = 1$ ,  $E(t) = 50e^{-t}\mathcal{U}(t-1) = 50e^{-1}e^{-(t-1)}\mathcal{U}(t-1)$ ,  $q(0) = i_3(0) = 0$ , and taking the Laplace transform of the system we obtain

$$(s+1)\mathcal{L}\{q\} + \mathcal{L}\{i_3\} = \frac{50e^{-1}}{s+1}e^{-s}$$

$$(s+1)\mathcal{L}\{i_3\} - \mathcal{L}\{q\} = 0,$$

so that

$$\mathcal{L}\{q\} = \frac{50e^{-1}e^{-s}}{(s+1)^2 + 1}$$

and

$$q(t) = 50e^{-1}e^{-(t-1)} \sin(t-1)\mathcal{U}(t-1) = 50e^{-t} \sin(t-1)\mathcal{U}(t-1).$$



21. (a) Taking the Laplace transform of the system

$$4\theta_1'' + \theta_2'' + 8\theta_1 = 0$$

$$\theta_1'' + \theta_2'' + 2\theta_2 = 0$$

gives

$$4(s^2 + 2)\mathcal{L}\{\theta_1\} + s^2\mathcal{L}\{\theta_2\} = 3s$$

$$s^2\mathcal{L}\{\theta_1\} + (s^2 + 2)\mathcal{L}\{\theta_2\} = 0$$

so that

$$(3s^2 + 4)(s^2 + 4)\mathcal{L}\{\theta_2\} = -3s^3$$

or

$$\mathcal{L}\{\theta_2\} = \frac{1}{2} \frac{s}{s^2 + 4/3} - \frac{3}{2} \frac{s}{s^2 + 4}.$$

Then

$$\theta_2 = \frac{1}{2} \cos \frac{2}{\sqrt{3}}t - \frac{3}{2} \cos 2t \quad \text{and} \quad \theta_1'' = -\theta_2'' - 2\theta_2$$

so that

$$\theta_1 = \frac{1}{4} \cos \frac{2}{\sqrt{3}}t + \frac{3}{4} \cos 2t.$$

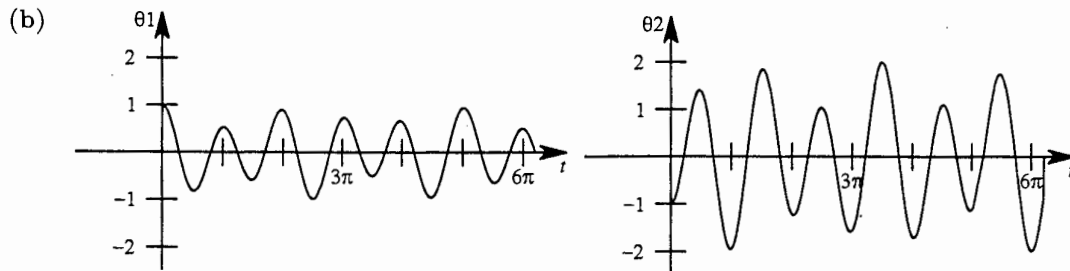

Mass  $m_2$  has extreme displacements of greater magnitude. Mass  $m_1$  first passes through its equilibrium position at about  $t = 0.87$ , and mass  $m_2$  first passes through its equilibrium position at about  $t = 0.66$ . The motion of the pendulums is not periodic since  $\cos 2t/\sqrt{3}$  has period  $\sqrt{3}\pi$ ,  $\cos 2t$  has period  $\pi$ , and the ratio of these periods is  $\sqrt{3}$ , which is not a rational number.

Exercises 7.6

(c) The Lissajous curve is plotted for  $0 \leq t \leq 30$ .

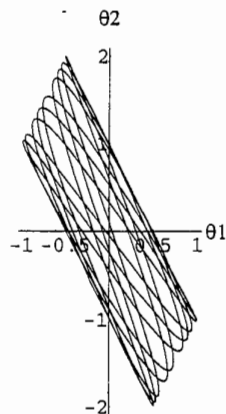

(d)

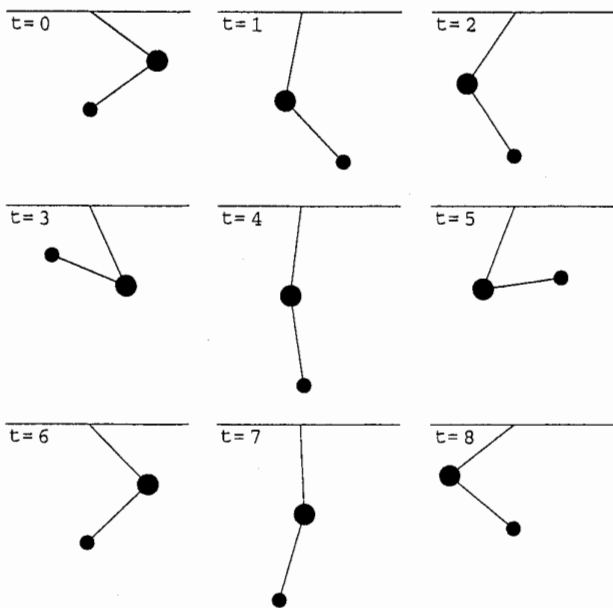

$t$	$\theta_1$	$\theta_2$
1	-0.2111	0.8263
2	-0.6585	0.6438
3	0.4830	-1.9145
4	-0.1325	0.1715
5	-0.4111	1.6951
6	0.8327	-0.8662
7	0.0458	-0.3186
8	-0.9639	0.9452
9	0.3534	-1.2741
10	0.4370	-0.3502

(e) Using a CAS to solve  $\theta_1(t) = \theta_2(t)$  we see that  $\theta_1 = \theta_2$  (so that the double pendulum is straight out) when  $t$  is about 0.75 seconds.

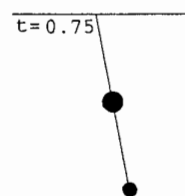

- (f) To make a movie of the pendulum it is necessary to locate the mass in the plane as a function of time. Suppose that the upper arm is attached to the origin and that the equilibrium position lies along the negative  $y$ -axis. Then mass  $m_1$  is at  $(x_1(t), y_1(t))$  and mass  $m_2$  is at  $(x_2(t), y_2(t))$ , where

$$x_1(t) = 16 \sin \theta_1(t) \quad \text{and} \quad y_1(t) = -16 \cos \theta_1(t)$$

and

$$x_2(t) = x_1(t) + 16 \sin \theta_2(t) \quad \text{and} \quad y_2(t) = y_1(t) - 16 \cos \theta_2(t).$$

A reasonable movie can be constructed by letting  $t$  range from 0 to 10 in increments of 0.1 seconds.

### Chapter 7 Review Exercises

1.  $\mathcal{L}\{f(t)\} = \int_0^1 te^{-st} dt + \int_1^\infty (2-t)e^{-st} dt = \frac{1}{s^2} - \frac{2}{s^2}e^{-s}$
2.  $\mathcal{L}\{f(t)\} = \int_2^4 e^{-st} dt = \frac{1}{s}(e^{-2s} - e^{-4s})$
3. False; consider  $f(t) = t^{-1/2}$ .
4. False, since  $f(t) = (e^t)^{10} = e^{10t}$ .
5. True, since  $\lim_{s \rightarrow \infty} F(s) = 1 \neq 0$ . (See Theorem 4.5 in the text.)
6. False; consider  $f(t) = 1$  and  $g(t) = 1$ .
7.  $\mathcal{L}\{e^{-7t}\} = \frac{1}{s+7}$
8.  $\mathcal{L}\{te^{-7t}\} = \frac{1}{(s+7)^2}$
9.  $\mathcal{L}\{\sin 2t\} = \frac{2}{s^2+4}$
10.  $\mathcal{L}\{e^{-3t} \sin 2t\} = \frac{2}{(s+3)^2+4}$
11.  $\mathcal{L}\{t \sin 2t\} = -\frac{d}{ds} \left[ \frac{2}{s^2+4} \right] = \frac{4s}{(s^2+4)^2}$
12.  $\mathcal{L}\{\sin 2t \mathcal{U}(t-\pi)\} = \mathcal{L}\{\sin 2(t-\pi) \mathcal{U}(t-\pi)\} = \frac{2}{s^2+4} e^{-\pi s}$

Chapter 7 Review Exercises

13.  $\mathcal{L}^{-1}\left\{\frac{20}{s^6}\right\} = \mathcal{L}^{-1}\left\{\frac{1}{6} \frac{5!}{s^6}\right\} = \frac{1}{6}t^5$
14.  $\mathcal{L}^{-1}\left\{\frac{1}{3s-1}\right\} = \mathcal{L}^{-1}\left\{\frac{1}{3} \frac{1}{s-1/3}\right\} = \frac{1}{3}e^{t/3}$
15.  $\mathcal{L}^{-1}\left\{\frac{1}{(s-5)^3}\right\} = \mathcal{L}^{-1}\left\{\frac{1}{2} \frac{2}{(s-5)^3}\right\} = \frac{1}{2}t^2e^{5t}$
16.  $\mathcal{L}^{-1}\left\{\frac{1}{s^2-5}\right\} = \mathcal{L}^{-1}\left\{-\frac{1}{\sqrt{5}} \frac{1}{s+\sqrt{5}} + \frac{1}{\sqrt{5}} \frac{1}{s-\sqrt{5}}\right\} = -\frac{1}{\sqrt{5}}e^{-\sqrt{5}t} + \frac{1}{\sqrt{5}}e^{\sqrt{5}t}$
17.  $\mathcal{L}^{-1}\left\{\frac{s}{s^2-10s+29}\right\} = \mathcal{L}^{-1}\left\{\frac{s-5}{(s-5)^2+2^2} + \frac{5}{2} \frac{2}{(s-5)^2+2^2}\right\} = e^{5t} \cos 2t + \frac{5}{2}e^{5t} \sin 2t$
18.  $\mathcal{L}^{-1}\left\{\frac{1}{s^2}e^{-5s}\right\} = (t-5)\mathcal{U}(t-5)$
19.  $\mathcal{L}^{-1}\left\{\frac{s+\pi}{s^2+\pi^2}e^{-s}\right\} = \mathcal{L}^{-1}\left\{\frac{s}{s^2+\pi^2}e^{-s} + \frac{\pi}{s^2+\pi^2}e^{-s}\right\}$   
 $= \cos \pi(t-1)\mathcal{U}(t-1) + \sin \pi(t-1)\mathcal{U}(t-1)$
20.  $\mathcal{L}^{-1}\left\{\frac{1}{L^2s^2+n^2\pi^2}\right\} = \frac{1}{L^2} \frac{L}{n\pi} \mathcal{L}^{-1}\left\{\frac{n\pi/L}{s^2+(n^2\pi^2)/L^2}\right\} = \frac{1}{Ln\pi} \sin \frac{n\pi}{L}t$
21.  $\mathcal{L}\{e^{-5t}\}$  exists for  $s > -5$ .
22.  $\mathcal{L}\{te^{8t}f(t)\} = -\frac{d}{ds}F(s-8)$ .
23.  $\mathcal{L}\{e^{at}f(t-k)\mathcal{U}(t-k)\} = e^{-ks} \mathcal{L}\{e^{a(t+k)}f(t)\} = e^{-ks}e^{ak} \mathcal{L}\{e^{at}f(t)\} = e^{-k(s-a)}F(s-a)$
24.  $\mathcal{L}\left\{\int_0^t e^{a\tau}f(\tau) d\tau\right\} = \frac{1}{s} \mathcal{L}\{e^{at}f(t)\} = \frac{F(s-a)}{s}$ , whereas  
 $\mathcal{L}\left\{e^{at} \int_0^t f(\tau) d\tau\right\} = \mathcal{L}\left\{\int_0^t f(\tau) d\tau\right\} \Big|_{s \rightarrow s-a} = \frac{F(s)}{s} \Big|_{s \rightarrow s-a} = \frac{F(s-a)}{s-a}$ .
25.  $f(t)\mathcal{U}(t-t_0)$
26.  $f(t) - f(t)\mathcal{U}(t-t_0)$
27.  $f(t-t_0)\mathcal{U}(t-t_0)$
28.  $f(t) - f(t)\mathcal{U}(t-t_0) + f(t)\mathcal{U}(t-t_1)$
29.  $f(t) = t - [(t-1) + 1]\mathcal{U}(t-1) + \mathcal{U}(t-1) - \mathcal{U}(t-4) = t - (t-1)\mathcal{U}(t-1) - \mathcal{U}(t-4)$   
 $\mathcal{L}\{f(t)\} = \frac{1}{s^2} - \frac{1}{s^2}e^{-s} - \frac{1}{s}e^{-4s}$

Chapter 7 Review Exercises

$$\mathcal{L}\{e^t f(t)\} = \frac{1}{(s-1)^2} - \frac{1}{(s-1)^2} e^{-(s-1)} - \frac{1}{s-1} e^{-4(s-1)}$$

30.  $f(t) = \sin t \mathcal{U}(t - \pi) - \sin t \mathcal{U}(t - 3\pi) = -\sin(t - \pi) \mathcal{U}(t - \pi) + \sin(t - 3\pi) \mathcal{U}(t - 3\pi)$

$$\mathcal{L}\{f(t)\} = -\frac{1}{s^2 + 1} e^{-\pi s} + \frac{1}{s^2 + 1} e^{-3\pi s}.$$

$$\mathcal{L}\{e^t f(t)\} = -\frac{1}{(s-1)^2 + 1} e^{-\pi(s-1)} + \frac{1}{(s-1)^2 + 1} e^{-3\pi(s-1)}$$

31.  $f(t) = 2 - 2\mathcal{U}(t - 2) + [(t - 2) + 2]\mathcal{U}(t - 2) = 2 + (t - 2)\mathcal{U}(t - 2)$

$$\mathcal{L}\{f(t)\} = \frac{2}{s} + \frac{1}{s^2} e^{-2s}$$

$$\mathcal{L}\{e^t f(t)\} = \frac{2}{s-1} + \frac{1}{(s-1)^2} e^{-2(s-1)}$$

32.  $f(t) = t - t\mathcal{U}(t - 1) + (2 - t)\mathcal{U}(t - 1) - (2 - t)\mathcal{U}(t - 2) = t - 2(t - 1)\mathcal{U}(t - 1) + (t - 2)\mathcal{U}(t - 2)$

$$\mathcal{L}\{f(t)\} = \frac{1}{s^2} - \frac{2}{s^2} e^{-s} + \frac{1}{s^2} e^{-2s}$$

$$\mathcal{L}\{e^t f(t)\} = \frac{1}{(s-1)^2} - \frac{2}{(s-1)^2} e^{-(s-1)} + \frac{1}{(s-1)^2} e^{-2(s-1)}$$

33. Taking the Laplace transform of the differential equation we obtain

$$\mathcal{L}\{y\} = \frac{5}{(s-1)^2} + \frac{1}{2} \frac{2}{(s-1)^3}$$

so that

$$y = 5te^t + \frac{1}{2}t^2e^t.$$

34. Taking the Laplace transform of the differential equation we obtain

$$\begin{aligned} \mathcal{L}\{y\} &= \frac{1}{(s-1)^2(s^2 - 8s + 20)} \\ &= \frac{6}{169} \frac{1}{s-1} + \frac{1}{13} \frac{1}{(s-1)^2} - \frac{6}{169} \frac{s-4}{(s-4)^2 + 2^2} + \frac{5}{338} \frac{2}{(s-4)^2 + 2^2} \end{aligned}$$

so that

$$y = \frac{6}{169}e^t + \frac{1}{13}te^t - \frac{6}{169}e^{4t} \cos 2t + \frac{5}{338}e^{4t} \sin 2t.$$

## Chapter 7 Review Exercises

35. Taking the Laplace transform of the given differential equation we obtain

$$\begin{aligned}\mathcal{L}\{y\} &= \frac{s^3 + 6s^2 + 1}{s^2(s+1)(s+5)} - \frac{1}{s^2(s+1)(s+5)} e^{-2s} - \frac{2}{s(s+1)(s+5)} e^{-2s} \\ &= -\frac{6}{25} \cdot \frac{1}{s} + \frac{1}{5} \cdot \frac{1}{s^2} + \frac{3}{2} \cdot \frac{1}{s+1} - \frac{13}{50} \cdot \frac{1}{s+5} \\ &\quad - \left( -\frac{6}{25} \cdot \frac{1}{s} + \frac{1}{5} \cdot \frac{1}{s^2} + \frac{1}{4} \cdot \frac{1}{s+1} - \frac{1}{100} \cdot \frac{1}{s+5} \right) e^{-2s} \\ &\quad - \left( \frac{2}{5} \cdot \frac{1}{s} - \frac{1}{2} \cdot \frac{1}{s+1} + \frac{1}{10} \cdot \frac{1}{s+5} \right) e^{-2s}\end{aligned}$$

so that

$$\begin{aligned}y &= -\frac{6}{25} + \frac{1}{5}t^2 + \frac{3}{2}e^{-t} - \frac{13}{50}e^{-5t} - \frac{4}{25}\mathcal{U}(t-2) - \frac{1}{5}(t-2)^2\mathcal{U}(t-2) \\ &\quad + \frac{1}{4}e^{-(t-2)}\mathcal{U}(t-2) - \frac{9}{100}e^{-5(t-2)}\mathcal{U}(t-2).\end{aligned}$$

36. Taking the Laplace transform of the differential equation we obtain

$$\begin{aligned}\mathcal{L}\{y\} &= \frac{s^3 + 2}{s^3(s-5)} - \frac{2 + 2s + s^2}{s^3(s-5)} e^{-s} \\ &= -\frac{2}{125} \frac{1}{s} - \frac{2}{25} \frac{1}{s^2} - \frac{1}{5} \frac{2}{s^3} + \frac{127}{125} \frac{1}{s-5} - \left[ -\frac{37}{125} \frac{1}{s} - \frac{12}{25} \frac{1}{s^2} - \frac{1}{5} \frac{2}{s^3} + \frac{37}{125} \frac{1}{s-5} \right] e^{-s}\end{aligned}$$

so that

$$y = -\frac{2}{125} - \frac{2}{25}t - \frac{1}{5}t^2 + \frac{127}{125}e^{5t} - \left[ -\frac{37}{125} - \frac{12}{25}(t-1) - \frac{1}{5}(t-1)^2 + \frac{37}{125}e^{5(t-1)} \right] \mathcal{U}(t-1).$$

37. Taking the Laplace transform of the integral equation we obtain

$$\mathcal{L}\{y\} = \frac{1}{s} + \frac{1}{s^2} + \frac{1}{2} \frac{2}{s^3}$$

so that

$$y(t) = 1 + t + \frac{1}{2}t^2.$$

38. Taking the Laplace transform of the integral equation we obtain

$$(\mathcal{L}\{f\})^2 = 6 \cdot \frac{6}{s^4} \quad \text{or} \quad \mathcal{L}\{f\} = \pm 6 \cdot \frac{1}{s^2}$$

so that  $f(t) = \pm 6t$ .

39. Taking the Laplace transform of the system gives

$$s\mathcal{L}\{x\} + \mathcal{L}\{y\} = \frac{1}{s^2} + 1$$

$$4\mathcal{L}\{x\} + s\mathcal{L}\{y\} = 2$$

so that

$$\mathcal{L}\{x\} = \frac{s^2 - 2s + 1}{s(s-2)(s+2)} = -\frac{1}{4} \frac{1}{s} + \frac{1}{8} \frac{1}{s-2} + \frac{9}{8} \frac{1}{s+2}.$$

Then

$$x = -\frac{1}{4} + \frac{1}{8}e^{2t} + \frac{9}{8}e^{-2t} \quad \text{and} \quad y = -x' + t = \frac{9}{4}e^{-2t} - \frac{1}{4}e^{2t} + t.$$

40. Taking the Laplace transform of the system gives

$$s^2 \mathcal{L}\{x\} + s^2 \mathcal{L}\{y\} = \frac{1}{s-2}$$

$$2s \mathcal{L}\{x\} + s^2 \mathcal{L}\{y\} = -\frac{1}{s-2}$$

so that

$$\mathcal{L}\{x\} = \frac{2}{s(s-2)^2} = \frac{1}{2} \frac{1}{s} - \frac{1}{2} \frac{1}{s-2} + \frac{1}{(s-2)^2}$$

and

$$\mathcal{L}\{y\} = \frac{-s-2}{s^2(s-2)^2} = -\frac{3}{4} \frac{1}{s} - \frac{1}{2} \frac{1}{s^2} + \frac{3}{4} \frac{1}{s-2} - \frac{1}{(s-2)^2}.$$

Then

$$x = \frac{1}{2} - \frac{1}{2}e^{2t} + te^{2t} \quad \text{and} \quad y = -\frac{3}{4} - \frac{1}{2}t + \frac{3}{4}e^{2t} - te^{2t}.$$

41. The integral equation is

$$10i + 2 \int_0^t i(\tau) d\tau = 2t^2 + 2t.$$

Taking the Laplace transform we obtain

$$\mathcal{L}\{i\} = \left( \frac{4}{s^3} + \frac{2}{s^2} \right) \frac{s}{10s+2} = \frac{s+2}{s^2(5s+2)} = -\frac{9}{s} + \frac{2}{s^2} + \frac{45}{5s+1} = -\frac{9}{s} + \frac{2}{s^2} + \frac{9}{s+1/5}.$$

Thus

$$i(t) = -9 + 2t + 9e^{-t/5}.$$

42. The differential equation is

$$\frac{1}{2} \frac{d^2q}{dt^2} + 10 \frac{dq}{dt} + 100q = 10 - 10^9 u(t-5).$$

Taking the Laplace transform we obtain

$$\begin{aligned} \mathcal{L}\{q\} &= \frac{20}{2(s^2 + 20s + 200)} (1 - e^{-5s}) \\ &= \left[ \frac{1}{10} \frac{1}{s} - \frac{1}{10} \frac{s+10}{(s+10)^2 + 10^2} - \frac{1}{10} \frac{10}{(s+10)^2 + 10^2} \right] (1 - e^{-5s}) \end{aligned}$$

## Chapter 7 Review Exercises

so that

$$q(t) = \frac{1}{10} - \frac{1}{10}e^{-10t} \cos 10t - \frac{1}{10}e^{-10t} \sin 10t \\ - \left[ \frac{1}{10} - \frac{1}{10}e^{-10(t-5)} \cos 10(t-5) - \frac{1}{10}e^{-10(t-5)} \sin 10(t-5) \right] \mathcal{U}(t-5).$$

43. Taking the Laplace transform of the given differential equation we obtain

$$\mathcal{L}\{y\} = \frac{2w_0}{EIL} \left( \frac{L}{48} \cdot \frac{4!}{s^5} - \frac{1}{120} \cdot \frac{5!}{s^6} + \frac{1}{120} \cdot \frac{5!}{s^6} e^{-sL/2} \right) + \frac{c_1}{2} \cdot \frac{2!}{s^3} + \frac{c_2}{6} \cdot \frac{3!}{s^4}$$

so that

$$y = \frac{2w_0}{EIL} \left[ \frac{L}{48}x^4 - \frac{1}{120}x^5 + \frac{1}{120} \left( x - \frac{L}{2} \right)^5 \mathcal{U} \left( x - \frac{L}{2} \right) + \frac{c_1}{2}x^2 + \frac{c_2}{6}x^3 \right]$$

where  $y''(0) = c_1$  and  $y'''(0) = c_2$ . Using  $y''(L) = 0$  and  $y'''(L) = 0$  we find

$$c_1 = w_0L^2/24EI, \quad c_2 = -w_0L/4EI.$$

Hence

$$y = \frac{w_0}{12EIL} \left[ -\frac{1}{5}x^5 + \frac{L}{2}x^4 - \frac{L^2}{2}x^3 + \frac{L^3}{4}x^2 + \frac{1}{5} \left( x - \frac{L}{2} \right)^5 \mathcal{U} \left( x - \frac{L}{2} \right) \right].$$

44. (a) In this case the boundary conditions are  $y(0) = y''(0) = 0$  and  $y(\pi) = y''(\pi) = 0$ . If we let  $c_1 = y'(0)$  and  $c_2 = y'''(0)$  then

$$s^4 \mathcal{L}\{y\} - s^3y(0) - s^2y'(0) - sy(0) - y'''(0) + 4 \mathcal{L}\{y\} = \mathcal{L}\{w_0/EI\}$$

and

$$\mathcal{L}\{y\} = \frac{c_1}{2} \cdot \frac{2s^2}{s^4+4} + \frac{c_2}{4} \cdot \frac{4}{s^4+4} + \frac{w_0}{8EI} \left( \frac{2}{s} - \frac{s-1}{(s-1)^2+1} - \frac{s+1}{(s+1)^2+1} \right).$$

From the table of transforms we get

$$y = \frac{c_1}{2}(\sin x \cosh x + \cos x \sinh x) + \frac{c_2}{4}(\sin x \cosh x - \cos x \sinh x) + \frac{w_0}{4EI}(1 - \cos x \cosh x)$$

Using  $y(\pi) = 0$  and  $y''(\pi) = 0$  we find

$$c_1 = \frac{w_0}{4EI}(1 + \cosh \pi) \operatorname{csch} \pi, \quad c_2 = -\frac{w_0}{2EI}(1 + \cosh \pi) \operatorname{csch} \pi.$$

Hence

$$y = \frac{w_0}{8EI}(1 + \cosh \pi) \operatorname{csch} \pi (\sin x \cosh x + \cos x \sinh x) \\ - \frac{w_0}{8EI}(1 + \cosh \pi) \operatorname{csch} \pi (\sin x \cosh x - \cos x \sinh x) + \frac{w_0}{4EI}(1 - \cos x \cosh x).$$

(b) In this case the boundary conditions are  $y(0) = y'(0) = 0$  and  $y(\pi) = y'(\pi) = 0$ . If we let  $c_1 = y''(0)$  and  $c_2 = y'''(0)$  then

$$s^4 \mathcal{L}\{y\} - s^3y(0) - s^2y'(0) - sy(0) - y'''(0) + 4 \mathcal{L}\{y\} = \mathcal{L}\{\delta(t - \pi/2)\}$$



and

$$\mathcal{L}\{y\} = \frac{c_1}{2} \cdot \frac{2s}{s^4 + 4} + \frac{c_2}{4} \cdot \frac{4}{s^4 + 4} + \frac{w_0}{4EI} \cdot \frac{4}{s^4 + 4} e^{-s\pi/2}.$$

From the table of transforms we get

$$y = \frac{c_1}{2} \sin x \sinh x + \frac{c_2}{4} (\sin x \cosh x - \cos x \sinh x) \\ + \frac{w_0}{4EI} \left[ \sin \left( x - \frac{\pi}{2} \right) \cosh \left( x - \frac{\pi}{2} \right) - \cos \left( x - \frac{\pi}{2} \right) \sinh \left( x - \frac{\pi}{2} \right) \right] \mathcal{U} \left( x - \frac{\pi}{2} \right)$$

Using  $y(\pi) = 0$  and  $y'(\pi) = 0$  we find

$$c_1 = \frac{w_0}{EI} \frac{\sinh \frac{\pi}{2}}{\sinh \pi}, \quad c_2 = -\frac{w_0}{EI} \frac{\cosh \frac{\pi}{2}}{\sinh \pi}.$$

Hence

$$y = \frac{w_0}{2EI} \frac{\sinh \frac{\pi}{2}}{\sinh \pi} \sin x \sinh x - \frac{w_0}{4EI} \frac{\cosh \frac{\pi}{2}}{\sinh \pi} (\sin x \cosh x - \cos x \sinh x) \\ + \frac{w_0}{4EI} \left[ \sin \left( x - \frac{\pi}{2} \right) \cosh \left( x - \frac{\pi}{2} \right) - \cos \left( x - \frac{\pi}{2} \right) \sinh \left( x - \frac{\pi}{2} \right) \right] \mathcal{U} \left( x - \frac{\pi}{2} \right).$$

# 8 Systems of Linear First-Order Differential Equations

## Exercises 8.1

---

1. Let  $\mathbf{X} = \begin{pmatrix} x \\ y \end{pmatrix}$ . Then

$$\mathbf{X}' = \begin{pmatrix} 3 & -5 \\ 4 & 8 \end{pmatrix} \mathbf{X}.$$

2. Let  $\mathbf{X} = \begin{pmatrix} x \\ y \end{pmatrix}$ . Then

$$\mathbf{X}' = \begin{pmatrix} 4 & -7 \\ 5 & 0 \end{pmatrix} \mathbf{X}.$$

3. Let  $\mathbf{X} = \begin{pmatrix} x \\ y \\ z \end{pmatrix}$ . Then

$$\mathbf{X}' = \begin{pmatrix} -3 & 4 & -9 \\ 6 & -1 & 0 \\ 10 & 4 & 3 \end{pmatrix} \mathbf{X}.$$

4. Let  $\mathbf{X} = \begin{pmatrix} x \\ y \\ z \end{pmatrix}$ . Then

$$\mathbf{X}' = \begin{pmatrix} 1 & -1 & 0 \\ 1 & 0 & 2 \\ -1 & 0 & 1 \end{pmatrix} \mathbf{X}.$$

5. Let  $\mathbf{X} = \begin{pmatrix} x \\ y \\ z \end{pmatrix}$ . Then

$$\mathbf{X}' = \begin{pmatrix} 1 & -1 & 1 \\ 2 & 1 & -1 \\ 1 & 1 & 1 \end{pmatrix} \mathbf{X} + \begin{pmatrix} 0 \\ -3t^2 \\ t^2 \end{pmatrix} + \begin{pmatrix} t \\ 0 \\ -t \end{pmatrix} + \begin{pmatrix} -1 \\ 0 \\ 2 \end{pmatrix}.$$

6. Let  $\mathbf{X} = \begin{pmatrix} x \\ y \\ z \end{pmatrix}$ . Then

$$\mathbf{X}' = \begin{pmatrix} -3 & 4 & 0 \\ 5 & 9 & 0 \\ 0 & 1 & 6 \end{pmatrix} \mathbf{X} + \begin{pmatrix} e^{-t} \sin 2t \\ 4e^{-t} \cos 2t \\ -e^{-t} \end{pmatrix}$$

7.  $\frac{dx}{dt} = 4x + 2y + e^t$ ;  $\frac{dy}{dt} = -x + 3y - e^t$

8.  $\frac{dx}{dt} = 7x + 5y - 9z - 8e^{-2t}$ ;  $\frac{dy}{dt} = 4x + y + z + 2e^{5t}$ ;  $\frac{dz}{dt} = -2y + 3z + e^{5t} - 3e^{-2t}$

9.  $\frac{dx}{dt} = x - y + 2z + e^{-t} - 3t$ ;  $\frac{dy}{dt} = 3x - 4y + z + 2e^{-t} + t$ ;  $\frac{dz}{dt} = -2x + 5y + 6z + 2e^{-t} - t$

10.  $\frac{dx}{dt} = 3x - 7y + 4 \sin t + (t - 4)e^{4t}$ ;  $\frac{dy}{dt} = x + y + 8 \sin t + (2t + 1)e^{4t}$

11. Since

$$\mathbf{X}' = \begin{pmatrix} -5 \\ -10 \end{pmatrix} e^{-5t} \quad \text{and} \quad \begin{pmatrix} 3 & -4 \\ 4 & -7 \end{pmatrix} \mathbf{X} = \begin{pmatrix} -5 \\ -10 \end{pmatrix} e^{-5t}$$

we see that

$$\mathbf{X}' = \begin{pmatrix} 3 & -4 \\ 4 & -7 \end{pmatrix} \mathbf{X}.$$

12. Since

$$\mathbf{X}' = \begin{pmatrix} 5 \cos t - 5 \sin t \\ 2 \cos t - 4 \sin t \end{pmatrix} e^t \quad \text{and} \quad \begin{pmatrix} -2 & 5 \\ -2 & 4 \end{pmatrix} \mathbf{X} = \begin{pmatrix} 5 \cos t - 5 \sin t \\ 2 \cos t - 4 \sin t \end{pmatrix} e^t$$

we see that

$$\mathbf{X}' = \begin{pmatrix} -2 & 5 \\ -2 & 4 \end{pmatrix} \mathbf{X}.$$

13. Since

$$\mathbf{X}' = \begin{pmatrix} 3/2 \\ -3 \end{pmatrix} e^{-3t/2} \quad \text{and} \quad \begin{pmatrix} -1 & 1/4 \\ 1 & -1 \end{pmatrix} \mathbf{X} = \begin{pmatrix} 3/2 \\ -3 \end{pmatrix} e^{-3t/2}$$

we see that

$$\mathbf{X}' = \begin{pmatrix} -1 & 1/4 \\ 1 & -1 \end{pmatrix} \mathbf{X}.$$

14. Since

$$\mathbf{X}' = \begin{pmatrix} 5 \\ -1 \end{pmatrix} e^t + \begin{pmatrix} 4 \\ -4 \end{pmatrix} te^t \quad \text{and} \quad \begin{pmatrix} 2 & 1 \\ -1 & 0 \end{pmatrix} \mathbf{X} = \begin{pmatrix} 5 \\ -1 \end{pmatrix} e^t + \begin{pmatrix} 4 \\ -4 \end{pmatrix} te^t$$

we see that

$$\mathbf{X}' = \begin{pmatrix} 2 & 1 \\ -1 & 0 \end{pmatrix} \mathbf{X}.$$

### Exercises 8.1

15. Since

$$\mathbf{X}' = \begin{pmatrix} 0 \\ 0 \\ 0 \end{pmatrix} \quad \text{and} \quad \begin{pmatrix} 1 & 2 & 1 \\ 6 & -1 & 0 \\ -1 & -2 & -1 \end{pmatrix} \mathbf{X} = \begin{pmatrix} 0 \\ 0 \\ 0 \end{pmatrix}$$

we see that

$$\mathbf{X}' = \begin{pmatrix} 1 & 2 & 1 \\ 6 & -1 & 0 \\ -1 & -2 & -1 \end{pmatrix} \mathbf{X}.$$

16. Since

$$\mathbf{X}' = \begin{pmatrix} \cos t \\ \frac{1}{2} \sin t - \frac{1}{2} \cos t \\ -\cos t - \sin t \end{pmatrix} \quad \text{and} \quad \begin{pmatrix} 1 & 0 & 1 \\ 1 & 1 & 0 \\ -2 & 0 & -1 \end{pmatrix} \mathbf{X} = \begin{pmatrix} \cos t \\ \frac{1}{2} \sin t - \frac{1}{2} \cos t \\ -\cos t - \sin t \end{pmatrix}$$

we see that

$$\mathbf{X}' = \begin{pmatrix} 1 & 0 & 1 \\ 1 & 1 & 0 \\ -2 & 0 & -1 \end{pmatrix} \mathbf{X}.$$

17. Yes, since  $W(\mathbf{X}_1, \mathbf{X}_2) = -2e^{-3t} \neq 0$  and  $\mathbf{X}_1$  and  $\mathbf{X}_2$  are linearly independent on  $-\infty < t < \infty$ .

18. Yes, since  $W(\mathbf{X}_1, \mathbf{X}_2) = 8e^{2t} \neq 0$  and  $\mathbf{X}_1$  and  $\mathbf{X}_2$  are linearly independent on  $-\infty < t < \infty$ .

19. No, since  $W(\mathbf{X}_1, \mathbf{X}_2, \mathbf{X}_3) = 0$  and  $\mathbf{X}_1$ ,  $\mathbf{X}_2$ , and  $\mathbf{X}_3$  are linearly dependent on  $-\infty < t < \infty$ .

20. Yes, since  $W(\mathbf{X}_1, \mathbf{X}_2, \mathbf{X}_3) = -84e^{-t} \neq 0$  and  $\mathbf{X}_1$ ,  $\mathbf{X}_2$ , and  $\mathbf{X}_3$  are linearly independent on  $-\infty < t < \infty$ .

21. Since

$$\mathbf{X}'_p = \begin{pmatrix} 2 \\ -1 \end{pmatrix} \quad \text{and} \quad \begin{pmatrix} 1 & 4 \\ 3 & 2 \end{pmatrix} \mathbf{X}_p + \begin{pmatrix} 2 \\ -4 \end{pmatrix} t + \begin{pmatrix} -7 \\ -18 \end{pmatrix} = \begin{pmatrix} 2 \\ -1 \end{pmatrix}$$

we see that

$$\mathbf{X}'_p = \begin{pmatrix} 1 & 4 \\ 3 & 2 \end{pmatrix} \mathbf{X}_p + \begin{pmatrix} 2 \\ -4 \end{pmatrix} t + \begin{pmatrix} -7 \\ -18 \end{pmatrix}.$$

22. Since

$$\mathbf{X}'_p = \begin{pmatrix} 0 \\ 0 \end{pmatrix} \quad \text{and} \quad \begin{pmatrix} 2 & 1 \\ 1 & -1 \end{pmatrix} \mathbf{X}_p + \begin{pmatrix} -5 \\ 2 \end{pmatrix} = \begin{pmatrix} 0 \\ 0 \end{pmatrix}$$

we see that

$$\mathbf{X}'_p = \begin{pmatrix} 2 & 1 \\ 1 & -1 \end{pmatrix} \mathbf{X}_p + \begin{pmatrix} -5 \\ 2 \end{pmatrix}.$$

23. Since

$$\mathbf{X}'_p = \begin{pmatrix} 2 \\ 0 \end{pmatrix} e^t + \begin{pmatrix} 1 \\ -1 \end{pmatrix} te^t \quad \text{and} \quad \begin{pmatrix} 2 & 1 \\ 3 & 4 \end{pmatrix} \mathbf{X}_p - \begin{pmatrix} 1 \\ 7 \end{pmatrix} e^t = \begin{pmatrix} 2 \\ 0 \end{pmatrix} e^t + \begin{pmatrix} 1 \\ -1 \end{pmatrix} te^t$$

we see that

$$\mathbf{X}'_p = \begin{pmatrix} 2 & 1 \\ 3 & 4 \end{pmatrix} \mathbf{X}_p - \begin{pmatrix} 1 \\ 7 \end{pmatrix} e^t.$$

24. Since

$$\mathbf{X}'_p = \begin{pmatrix} 3 \cos 3t \\ 0 \\ -3 \sin 3t \end{pmatrix} \quad \text{and} \quad \begin{pmatrix} 1 & 2 & 3 \\ -4 & 2 & 0 \\ -6 & 1 & 0 \end{pmatrix} \mathbf{X}_p + \begin{pmatrix} -1 \\ 4 \\ 3 \end{pmatrix} \sin 3t = \begin{pmatrix} 3 \cos 3t \\ 0 \\ -3 \sin 3t \end{pmatrix}$$

we see that

$$\mathbf{X}'_p = \begin{pmatrix} 1 & 2 & 3 \\ -4 & 2 & 0 \\ -6 & 1 & 0 \end{pmatrix} \mathbf{X}_p + \begin{pmatrix} -1 \\ 4 \\ 3 \end{pmatrix} \sin 3t.$$

25. Let

$$\mathbf{X}_1 = \begin{pmatrix} 6 \\ -1 \\ -5 \end{pmatrix} e^{-t}, \quad \mathbf{X}_2 = \begin{pmatrix} -3 \\ 1 \\ 1 \end{pmatrix} e^{-2t}, \quad \mathbf{X}_3 = \begin{pmatrix} 2 \\ 1 \\ 1 \end{pmatrix} e^{3t}, \quad \text{and} \quad \mathbf{A} = \begin{pmatrix} 0 & 6 & 0 \\ 1 & 0 & 1 \\ 1 & 1 & 0 \end{pmatrix}.$$

Then

$$\mathbf{X}'_1 = \begin{pmatrix} -6 \\ 1 \\ 5 \end{pmatrix} e^{-t} = \mathbf{A}\mathbf{X}_1,$$

$$\mathbf{X}'_2 = \begin{pmatrix} 6 \\ -2 \\ -2 \end{pmatrix} e^{-2t} = \mathbf{A}\mathbf{X}_2,$$

$$\mathbf{X}'_3 = \begin{pmatrix} 6 \\ 3 \\ 3 \end{pmatrix} e^{3t} = \mathbf{A}\mathbf{X}_3,$$

and  $W(\mathbf{X}_1, \mathbf{X}_2, \mathbf{X}_3) = 20 \neq 0$  so that  $\mathbf{X}_1, \mathbf{X}_2,$  and  $\mathbf{X}_3$  form a fundamental set for  $\mathbf{X}' = \mathbf{A}\mathbf{X}$  on  $-\infty < t < \infty$ .

26. Let

$$\mathbf{X}_1 = \begin{pmatrix} 1 \\ -1 - \sqrt{2} \end{pmatrix} e^{\sqrt{2}t},$$

$$\mathbf{X}_2 = \begin{pmatrix} 1 \\ -1 + \sqrt{2} \end{pmatrix} e^{-\sqrt{2}t},$$

$$\mathbf{X}_p = \begin{pmatrix} 1 \\ 0 \end{pmatrix} t^2 + \begin{pmatrix} -2 \\ 4 \end{pmatrix} t + \begin{pmatrix} 1 \\ 0 \end{pmatrix},$$

### Exercises 8.1

and

$$\mathbf{A} = \begin{pmatrix} -1 & -1 \\ -1 & 1 \end{pmatrix}.$$

Then

$$\mathbf{X}'_1 = \begin{pmatrix} \sqrt{2} \\ -2 - \sqrt{2} \end{pmatrix} e^{\sqrt{2}t} = \mathbf{A}\mathbf{X}_1,$$

$$\mathbf{X}'_2 = \begin{pmatrix} -\sqrt{2} \\ -2 - \sqrt{2} \end{pmatrix} e^{-\sqrt{2}t} = \mathbf{A}\mathbf{X}_2,$$

$$\mathbf{X}'_p = \begin{pmatrix} 2 \\ 0 \end{pmatrix} t + \begin{pmatrix} -2 \\ 4 \end{pmatrix} = \mathbf{A}\mathbf{X}_p + \begin{pmatrix} 1 \\ 1 \end{pmatrix} t^2 + \begin{pmatrix} 4 \\ -6 \end{pmatrix} t + \begin{pmatrix} -1 \\ 5 \end{pmatrix},$$

and  $W(\mathbf{X}_1, \mathbf{X}_2) = 2\sqrt{2} \neq 0$  so that  $\mathbf{X}_p$  is a particular solution and  $\mathbf{X}_1$  and  $\mathbf{X}_2$  form a fundamental set on  $-\infty < t < \infty$ .

---

## Exercises 8.2

---

1. The system is

$$\mathbf{X}' = \begin{pmatrix} 1 & 2 \\ 4 & 3 \end{pmatrix} \mathbf{X}$$

and  $\det(\mathbf{A} - \lambda\mathbf{I}) = (\lambda - 5)(\lambda + 1) = 0$ . For  $\lambda_1 = 5$  we obtain

$$\left( \begin{array}{cc|c} -4 & 2 & 0 \\ 4 & -2 & 0 \end{array} \right) \Rightarrow \left( \begin{array}{cc|c} 1 & -1/2 & 0 \\ 0 & 0 & 0 \end{array} \right) \text{ so that } \mathbf{K}_1 = \begin{pmatrix} 1 \\ 2 \end{pmatrix}.$$

For  $\lambda_2 = -1$  we obtain

$$\left( \begin{array}{cc|c} 2 & 2 & 0 \\ 4 & 4 & 0 \end{array} \right) \Rightarrow \left( \begin{array}{cc|c} 1 & 1 & 0 \\ 0 & 0 & 0 \end{array} \right) \text{ so that } \mathbf{K}_2 = \begin{pmatrix} -1 \\ 1 \end{pmatrix}.$$

Then

$$\mathbf{X} = c_1 \begin{pmatrix} 1 \\ 2 \end{pmatrix} e^{5t} + c_2 \begin{pmatrix} -1 \\ 1 \end{pmatrix} e^{-t}.$$

2. The system is

$$\mathbf{X}' = \begin{pmatrix} 2 & 2 \\ 1 & 3 \end{pmatrix} \mathbf{X}$$

and  $\det(\mathbf{A} - \lambda\mathbf{I}) = (\lambda - 1)(\lambda - 4) = 0$ . For  $\lambda_1 = 1$  we obtain

$$\left( \begin{array}{cc|c} 1 & 2 & 0 \\ 1 & 2 & 0 \end{array} \right) \Rightarrow \left( \begin{array}{cc|c} 1 & 2 & 0 \\ 0 & 0 & 0 \end{array} \right) \text{ so that } \mathbf{K}_1 = \begin{pmatrix} -2 \\ 1 \end{pmatrix}.$$

For  $\lambda_2 = 4$  we obtain

$$\left( \begin{array}{cc|c} -2 & 2 & 0 \\ 1 & -1 & 0 \end{array} \right) \Rightarrow \left( \begin{array}{cc|c} -1 & 1 & 0 \\ 0 & 0 & 0 \end{array} \right) \text{ so that } \mathbf{K}_2 = \begin{pmatrix} 1 \\ 1 \end{pmatrix}.$$

Then

$$\mathbf{X} = c_1 \begin{pmatrix} -2 \\ 1 \end{pmatrix} e^t + c_2 \begin{pmatrix} 1 \\ 1 \end{pmatrix} e^{4t}.$$

3. The system is

$$\mathbf{X}' = \begin{pmatrix} -4 & 2 \\ -5/2 & 2 \end{pmatrix} \mathbf{X}$$

and  $\det(\mathbf{A} - \lambda\mathbf{I}) = (\lambda - 1)(\lambda + 3) = 0$ . For  $\lambda_1 = 1$  we obtain

$$\left( \begin{array}{cc|c} -5 & 2 & 0 \\ -5/2 & 1 & 0 \end{array} \right) \Rightarrow \left( \begin{array}{cc|c} -5 & 2 & 0 \\ 0 & 0 & 0 \end{array} \right) \text{ so that } \mathbf{K}_1 = \begin{pmatrix} 2 \\ 5 \end{pmatrix}.$$

For  $\lambda_2 = -3$  we obtain

$$\left( \begin{array}{cc|c} -1 & 2 & 0 \\ -5/2 & 5 & 0 \end{array} \right) \Rightarrow \left( \begin{array}{cc|c} -1 & 2 & 0 \\ 0 & 0 & 0 \end{array} \right) \text{ so that } \mathbf{K}_2 = \begin{pmatrix} 2 \\ 1 \end{pmatrix}.$$

Then

$$\mathbf{X} = c_1 \begin{pmatrix} 2 \\ 5 \end{pmatrix} e^t + c_2 \begin{pmatrix} 2 \\ 1 \end{pmatrix} e^{-3t}.$$

4. The system is

$$\mathbf{X}' = \begin{pmatrix} -5/2 & 2 \\ 3/4 & -2 \end{pmatrix} \mathbf{X}$$

and  $\det(\mathbf{A} - \lambda\mathbf{I}) = (\lambda + 1)(2\lambda + 7) = 0$ . For  $\lambda_1 = -7/2$  we obtain

$$\left( \begin{array}{cc|c} 1 & 2 & 0 \\ 3/4 & 3/2 & 0 \end{array} \right) \Rightarrow \left( \begin{array}{cc|c} -1 & 2 & 0 \\ 0 & 0 & 0 \end{array} \right) \text{ so that } \mathbf{K}_1 = \begin{pmatrix} -2 \\ 1 \end{pmatrix}.$$

For  $\lambda_2 = -1$  we obtain

$$\left( \begin{array}{cc|c} -3/2 & 2 & 0 \\ 3/4 & -1 & 0 \end{array} \right) \Rightarrow \left( \begin{array}{cc|c} -3 & 4 & 0 \\ 0 & 0 & 0 \end{array} \right) \text{ so that } \mathbf{K}_2 = \begin{pmatrix} 4 \\ 3 \end{pmatrix}.$$

Then

$$\mathbf{X} = c_1 \begin{pmatrix} -2 \\ 1 \end{pmatrix} e^{-7t/2} + c_2 \begin{pmatrix} 4 \\ 3 \end{pmatrix} e^{-t}.$$

5. The system is

$$\mathbf{X}' = \begin{pmatrix} 10 & -5 \\ 8 & -12 \end{pmatrix} \mathbf{X}$$

and  $\det(\mathbf{A} - \lambda\mathbf{I}) = (\lambda - 8)(\lambda + 10) = 0$ . For  $\lambda_1 = 8$  we obtain

$$\left( \begin{array}{cc|c} 2 & -5 & 0 \\ 8 & -20 & 0 \end{array} \right) \Rightarrow \left( \begin{array}{cc|c} 1 & -5/2 & 0 \\ 0 & 0 & 0 \end{array} \right) \text{ so that } \mathbf{K}_1 = \begin{pmatrix} 5 \\ 2 \end{pmatrix}.$$

For  $\lambda_2 = -10$  we obtain

$$\left( \begin{array}{cc|c} 20 & -5 & 0 \\ 8 & -2 & 0 \end{array} \right) \Rightarrow \left( \begin{array}{cc|c} 1 & -1/4 & 0 \\ 0 & 0 & 0 \end{array} \right) \text{ so that } \mathbf{K}_2 = \begin{pmatrix} 1 \\ 4 \end{pmatrix}.$$

### Exercises 8.2

Then

$$\mathbf{X} = c_1 \begin{pmatrix} 5 \\ 2 \end{pmatrix} e^{8t} + c_2 \begin{pmatrix} 1 \\ 4 \end{pmatrix} e^{-10t}.$$

6. The system is

$$\mathbf{X}' = \begin{pmatrix} -6 & 2 \\ -3 & 1 \end{pmatrix} \mathbf{X}$$

and  $\det(\mathbf{A} - \lambda\mathbf{I}) = \lambda(\lambda + 5) = 0$ . For  $\lambda_1 = 0$  we obtain

$$\left( \begin{array}{cc|c} -6 & 2 & 0 \\ -3 & 1 & 0 \end{array} \right) \Rightarrow \left( \begin{array}{cc|c} 1 & -1/3 & 0 \\ 0 & 0 & 0 \end{array} \right) \text{ so that } \mathbf{K}_1 = \begin{pmatrix} 1 \\ 3 \end{pmatrix}.$$

For  $\lambda_2 = -5$  we obtain

$$\left( \begin{array}{cc|c} -1 & 2 & 0 \\ -3 & 6 & 0 \end{array} \right) \Rightarrow \left( \begin{array}{cc|c} 1 & -2 & 0 \\ 0 & 0 & 0 \end{array} \right) \text{ so that } \mathbf{K}_2 = \begin{pmatrix} 2 \\ 1 \end{pmatrix}.$$

Then

$$\mathbf{X} = c_1 \begin{pmatrix} 1 \\ 3 \end{pmatrix} + c_2 \begin{pmatrix} 2 \\ 1 \end{pmatrix} e^{-5t}.$$

7. The system is

$$\mathbf{X}' = \begin{pmatrix} 1 & 1 & -1 \\ 0 & 2 & 0 \\ 0 & 1 & -1 \end{pmatrix} \mathbf{X}$$

and  $\det(\mathbf{A} - \lambda\mathbf{I}) = (\lambda - 1)(2 - \lambda)(\lambda + 1) = 0$ . For  $\lambda_1 = 1$ ,  $\lambda_2 = 2$ , and  $\lambda_3 = -1$  we obtain

$$\mathbf{K}_1 = \begin{pmatrix} 1 \\ 0 \\ 0 \end{pmatrix}, \quad \mathbf{K}_2 = \begin{pmatrix} 2 \\ 3 \\ 1 \end{pmatrix}, \quad \text{and} \quad \mathbf{K}_3 = \begin{pmatrix} 1 \\ 0 \\ 2 \end{pmatrix},$$

so that

$$\mathbf{X} = c_1 \begin{pmatrix} 1 \\ 0 \\ 0 \end{pmatrix} e^t + c_2 \begin{pmatrix} 2 \\ 3 \\ 1 \end{pmatrix} e^{2t} + c_3 \begin{pmatrix} 1 \\ 0 \\ 2 \end{pmatrix} e^{-t}.$$

8. The system is

$$\mathbf{X}' = \begin{pmatrix} 2 & -7 & 0 \\ 5 & 10 & 4 \\ 0 & 5 & 2 \end{pmatrix} \mathbf{X}$$

and  $\det(\mathbf{A} - \lambda\mathbf{I}) = (2 - \lambda)(\lambda - 5)(\lambda - 7) = 0$ . For  $\lambda_1 = 2$ ,  $\lambda_2 = 5$ , and  $\lambda_3 = 7$  we obtain

$$\mathbf{K}_1 = \begin{pmatrix} 4 \\ 0 \\ -5 \end{pmatrix}, \quad \mathbf{K}_2 = \begin{pmatrix} -7 \\ 3 \\ 5 \end{pmatrix}, \quad \text{and} \quad \mathbf{K}_3 = \begin{pmatrix} -7 \\ 5 \\ 5 \end{pmatrix},$$



so that

$$\mathbf{X} = c_1 \begin{pmatrix} 4 \\ 0 \\ -5 \end{pmatrix} e^{2t} + c_2 \begin{pmatrix} -7 \\ 3 \\ 5 \end{pmatrix} e^{5t} + c_3 \begin{pmatrix} -7 \\ 5 \\ 5 \end{pmatrix} e^{7t}.$$

9. We have  $\det(\mathbf{A} - \lambda\mathbf{I}) = -(\lambda + 1)(\lambda - 3)(\lambda + 2) = 0$ . For  $\lambda_1 = -1$ ,  $\lambda_2 = 3$ , and  $\lambda_3 = -2$  we obtain

$$\mathbf{K}_1 = \begin{pmatrix} -1 \\ 0 \\ 1 \end{pmatrix}, \quad \mathbf{K}_2 = \begin{pmatrix} 1 \\ 4 \\ 3 \end{pmatrix}, \quad \text{and} \quad \mathbf{K}_3 = \begin{pmatrix} 1 \\ -1 \\ 3 \end{pmatrix},$$

so that

$$\mathbf{X} = c_1 \begin{pmatrix} -1 \\ 0 \\ 1 \end{pmatrix} e^{-t} + c_2 \begin{pmatrix} 1 \\ 4 \\ 3 \end{pmatrix} e^{3t} + c_3 \begin{pmatrix} 1 \\ -1 \\ 3 \end{pmatrix} e^{-2t}.$$

10. We have  $\det(\mathbf{A} - \lambda\mathbf{I}) = -\lambda(\lambda - 1)(\lambda - 2) = 0$ . For  $\lambda_1 = 0$ ,  $\lambda_2 = 1$ , and  $\lambda_3 = 2$  we obtain

$$\mathbf{K}_1 = \begin{pmatrix} 1 \\ 0 \\ -1 \end{pmatrix}, \quad \mathbf{K}_2 = \begin{pmatrix} 0 \\ 1 \\ 0 \end{pmatrix}, \quad \text{and} \quad \mathbf{K}_3 = \begin{pmatrix} 1 \\ 0 \\ 1 \end{pmatrix},$$

so that

$$\mathbf{X} = c_1 \begin{pmatrix} 1 \\ 0 \\ -1 \end{pmatrix} + c_2 \begin{pmatrix} 0 \\ 1 \\ 0 \end{pmatrix} e^t + c_3 \begin{pmatrix} 1 \\ 0 \\ 1 \end{pmatrix} e^{2t}.$$

11. We have  $\det(\mathbf{A} - \lambda\mathbf{I}) = -(\lambda + 1)(\lambda + 1/2)(\lambda + 3/2) = 0$ . For  $\lambda_1 = -1$ ,  $\lambda_2 = -1/2$ , and  $\lambda_3 = -3/2$  we obtain

$$\mathbf{K}_1 = \begin{pmatrix} 4 \\ 0 \\ -1 \end{pmatrix}, \quad \mathbf{K}_2 = \begin{pmatrix} -12 \\ 6 \\ 5 \end{pmatrix}, \quad \text{and} \quad \mathbf{K}_3 = \begin{pmatrix} 4 \\ 2 \\ -1 \end{pmatrix},$$

so that

$$\mathbf{X} = c_1 \begin{pmatrix} 4 \\ 0 \\ -1 \end{pmatrix} e^{-t} + c_2 \begin{pmatrix} -12 \\ 6 \\ 5 \end{pmatrix} e^{-t/2} + c_3 \begin{pmatrix} 4 \\ 2 \\ -1 \end{pmatrix} e^{-3t/2}.$$

12. We have  $\det(\mathbf{A} - \lambda\mathbf{I}) = (\lambda - 3)(\lambda + 5)(6 - \lambda) = 0$ . For  $\lambda_1 = 3$ ,  $\lambda_2 = -5$ , and  $\lambda_3 = 6$  we obtain

$$\mathbf{K}_1 = \begin{pmatrix} 1 \\ 1 \\ 0 \end{pmatrix}, \quad \mathbf{K}_2 = \begin{pmatrix} 1 \\ -1 \\ 0 \end{pmatrix}, \quad \text{and} \quad \mathbf{K}_3 = \begin{pmatrix} 2 \\ -2 \\ 11 \end{pmatrix},$$

## Exercises 8.2

so that

$$\mathbf{X} = c_1 \begin{pmatrix} 1 \\ 1 \\ 0 \end{pmatrix} e^{3t} + c_2 \begin{pmatrix} 1 \\ -1 \\ 0 \end{pmatrix} e^{-5t} + c_3 \begin{pmatrix} 2 \\ -2 \\ 11 \end{pmatrix} e^{6t}.$$

13. We have  $\det(\mathbf{A} - \lambda\mathbf{I}) = (\lambda + 1/2)(\lambda - 1/2) = 0$ . For  $\lambda_1 = -1/2$  and  $\lambda_2 = 1/2$  we obtain

$$\mathbf{K}_1 = \begin{pmatrix} 0 \\ 1 \end{pmatrix} \quad \text{and} \quad \mathbf{K}_2 = \begin{pmatrix} 1 \\ 1 \end{pmatrix},$$

so that

$$\mathbf{X} = c_1 \begin{pmatrix} 0 \\ 1 \end{pmatrix} e^{-t/2} + c_2 \begin{pmatrix} 1 \\ 1 \end{pmatrix} e^{t/2}.$$

If

$$\mathbf{X}(0) = \begin{pmatrix} 3 \\ 5 \end{pmatrix}$$

then  $c_1 = 2$  and  $c_2 = 3$ .

14. We have  $\det(\mathbf{A} - \lambda\mathbf{I}) = (2 - \lambda)(\lambda - 3)(\lambda + 1) = 0$ . For  $\lambda_1 = 2$ ,  $\lambda_2 = 3$ , and  $\lambda_3 = -1$  we obtain

$$\mathbf{K}_1 = \begin{pmatrix} 5 \\ -3 \\ 2 \end{pmatrix}, \quad \mathbf{K}_2 = \begin{pmatrix} 2 \\ 0 \\ 1 \end{pmatrix}, \quad \text{and} \quad \mathbf{K}_3 = \begin{pmatrix} -2 \\ 0 \\ 1 \end{pmatrix},$$

so that

$$\mathbf{X} = c_1 \begin{pmatrix} 5 \\ -3 \\ 2 \end{pmatrix} e^{2t} + c_2 \begin{pmatrix} 2 \\ 0 \\ 1 \end{pmatrix} e^{3t} + c_3 \begin{pmatrix} -2 \\ 0 \\ 1 \end{pmatrix} e^{-t}.$$

If

$$\mathbf{X}(0) = \begin{pmatrix} 1 \\ 3 \\ 0 \end{pmatrix}$$

then  $c_1 = -1$ ,  $c_2 = 5/2$ , and  $c_3 = -1/2$ .

$$15. \mathbf{X} = c_1 \begin{pmatrix} 0.382175 \\ 0.851161 \\ 0.359815 \end{pmatrix} e^{8.58979t} + c_2 \begin{pmatrix} 0.405188 \\ -0.676043 \\ 0.615458 \end{pmatrix} e^{2.25684t} + c_3 \begin{pmatrix} -0.923562 \\ -0.132174 \\ 0.35995 \end{pmatrix} e^{-0.0466321t}$$

$$16. \mathbf{X} = c_1 \begin{pmatrix} 0.0312209 \\ 0.949058 \\ 0.239535 \\ 0.195825 \\ 0.0508861 \end{pmatrix} e^{5.05452t} + c_2 \begin{pmatrix} -0.280232 \\ -0.836611 \\ -0.275304 \\ 0.176045 \\ 0.338775 \end{pmatrix} e^{4.09561t} + c_3 \begin{pmatrix} 0.262219 \\ -0.162664 \\ -0.826218 \\ -0.346439 \\ 0.31957 \end{pmatrix} e^{-2.92362t}$$

continued

$$+c_4 \begin{pmatrix} 0.313235 \\ 0.64181 \\ 0.31754 \\ 0.173787 \\ -0.599108 \end{pmatrix} e^{2.02882t} + c_5 \begin{pmatrix} -0.301294 \\ 0.466599 \\ 0.222136 \\ 0.0534311 \\ -0.799567 \end{pmatrix} e^{-0.155338t}$$

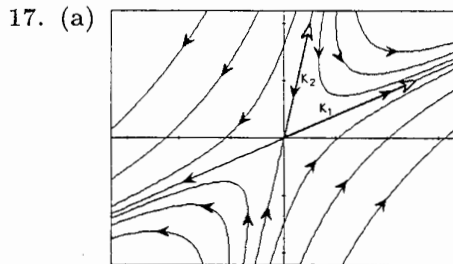

- (b) Letting  $c_1 = 1$  and  $c_2 = 0$  we get  $x = 5e^{8t}$ ,  $y = 2e^{8t}$ . Eliminating the parameter we find  $y = \frac{2}{5}x$ ,  $x > 0$ . When  $c_1 = -1$  and  $c_2 = 0$  we find  $y = \frac{2}{5}x$ ,  $x < 0$ . Letting  $c_1 = 0$  and  $c_2 = 1$  we get  $x = e^{-10t}$ ,  $y = 4e^{-10t}$ . Eliminating the parameter we find  $y = 4x$ ,  $x > 0$ . Letting  $c_1 = 0$  and  $c_2 = -1$  we find  $y = 4x$ ,  $x < 0$ .

(c) The eigenvectors  $\mathbf{K}_1 = (5, 2)$  and  $\mathbf{K}_2 = (1, 4)$  are shown in the figure in part (a).

18. In Problem 2, letting  $c_1 = 1$  and  $c_2 = 0$  we get  $x = -2e^t$ ,  $y = e^t$ . Eliminating the parameter we find  $y = -\frac{1}{2}x$ ,  $x < 0$ . When  $c_1 = -1$  and  $c_2 = 0$  we find  $y = -\frac{1}{2}x$ ,  $x > 0$ . Letting  $c_1 = 0$  and  $c_2 = 1$  we get  $x = e^{4t}$ ,  $y = e^{4t}$ . Eliminating the parameter we find  $y = x$ ,  $x > 0$ . When  $c_1 = 0$  and  $c_2 = -1$  we find  $y = x$ ,  $x < 0$ .

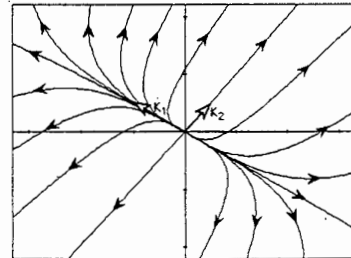

In Problem 4, letting  $c_1 = 1$  and  $c_2 = 0$  we get  $x = -2e^{-7t/2}$ ,  $y = e^{-7t/2}$ . Eliminating the parameter we find  $y = -\frac{1}{2}x$ ,  $x < 0$ . When  $c_1 = -1$  and  $c_2 = 0$  we find  $y = -\frac{1}{2}x$ ,  $x > 0$ . Letting  $c_1 = 0$  and  $c_2 = 1$  we get  $x = 4e^{-t}$ ,  $y = 3e^{-t}$ . Eliminating the parameter we find  $y = \frac{3}{4}x$ ,  $x > 0$ . When  $c_1 = 0$  and  $c_2 = -1$  we find  $y = \frac{3}{4}x$ ,  $x < 0$ .

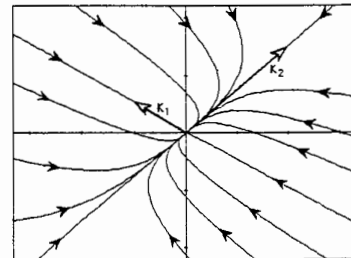

### Exercises 8.2

19. We have  $\det(\mathbf{A} - \lambda\mathbf{I}) = \lambda^2 = 0$ . For  $\lambda_1 = 0$  we obtain

$$\mathbf{K} = \begin{pmatrix} 1 \\ 3 \end{pmatrix}.$$

A solution of  $(\mathbf{A} - \lambda_1\mathbf{I})\mathbf{P} = \mathbf{K}$  is

$$\mathbf{P} = \begin{pmatrix} 1 \\ 2 \end{pmatrix}$$

so that

$$\mathbf{X} = c_1 \begin{pmatrix} 1 \\ 3 \end{pmatrix} + c_2 \left[ \begin{pmatrix} 1 \\ 3 \end{pmatrix} t + \begin{pmatrix} 1 \\ 2 \end{pmatrix} \right].$$

20. We have  $\det(\mathbf{A} - \lambda\mathbf{I}) = (\lambda + 1)^2 = 0$ . For  $\lambda_1 = -1$  we obtain

$$\mathbf{K} = \begin{pmatrix} 1 \\ 1 \end{pmatrix}.$$

A solution of  $(\mathbf{A} - \lambda_1\mathbf{I})\mathbf{P} = \mathbf{K}$  is

$$\mathbf{P} = \begin{pmatrix} 0 \\ 1/5 \end{pmatrix}$$

so that

$$\mathbf{X} = c_1 \begin{pmatrix} 1 \\ 1 \end{pmatrix} e^{-t} + c_2 \left[ \begin{pmatrix} 1 \\ 1 \end{pmatrix} t e^{-t} + \begin{pmatrix} 0 \\ 1/5 \end{pmatrix} e^{-t} \right].$$

21. We have  $\det(\mathbf{A} - \lambda\mathbf{I}) = (\lambda - 2)^2 = 0$ . For  $\lambda_1 = 2$  we obtain

$$\mathbf{K} = \begin{pmatrix} 1 \\ 1 \end{pmatrix}.$$

A solution of  $(\mathbf{A} - \lambda_1\mathbf{I})\mathbf{P} = \mathbf{K}$  is

$$\mathbf{P} = \begin{pmatrix} -1/3 \\ 0 \end{pmatrix}$$

so that

$$\mathbf{X} = c_1 \begin{pmatrix} 1 \\ 1 \end{pmatrix} e^{2t} + c_2 \left[ \begin{pmatrix} 1 \\ 1 \end{pmatrix} t e^{2t} + \begin{pmatrix} -1/3 \\ 0 \end{pmatrix} e^{2t} \right].$$

22. We have  $\det(\mathbf{A} - \lambda\mathbf{I}) = (\lambda - 6)^2 = 0$ . For  $\lambda_1 = 6$  we obtain

$$\mathbf{K} = \begin{pmatrix} 3 \\ 2 \end{pmatrix}.$$

A solution of  $(\mathbf{A} - \lambda_1\mathbf{I})\mathbf{P} = \mathbf{K}$  is

$$\mathbf{P} = \begin{pmatrix} 1/2 \\ 0 \end{pmatrix}$$

so that

$$\mathbf{X} = c_1 \begin{pmatrix} 3 \\ 2 \end{pmatrix} e^{6t} + c_2 \left[ \begin{pmatrix} 3 \\ 2 \end{pmatrix} t e^{6t} + \begin{pmatrix} 1/2 \\ 0 \end{pmatrix} e^{6t} \right].$$

23. We have  $\det(\mathbf{A} - \lambda\mathbf{I}) = (1 - \lambda)(\lambda - 2)^2 = 0$ . For  $\lambda_1 = 1$  we obtain

$$\mathbf{K}_1 = \begin{pmatrix} 1 \\ 1 \\ 1 \end{pmatrix}.$$

For  $\lambda_2 = 2$  we obtain

$$\mathbf{K}_2 = \begin{pmatrix} 1 \\ 0 \\ 1 \end{pmatrix} \quad \text{and} \quad \mathbf{K}_3 = \begin{pmatrix} 1 \\ 1 \\ 0 \end{pmatrix}.$$

Then

$$\mathbf{X} = c_1 \begin{pmatrix} 1 \\ 1 \\ 1 \end{pmatrix} e^t + c_2 \begin{pmatrix} 1 \\ 0 \\ 1 \end{pmatrix} e^{2t} + c_3 \begin{pmatrix} 1 \\ 1 \\ 0 \end{pmatrix} e^{2t}.$$

24. We have  $\det(\mathbf{A} - \lambda\mathbf{I}) = (\lambda - 8)(\lambda + 1)^2 = 0$ . For  $\lambda_1 = 8$  we obtain

$$\mathbf{K}_1 = \begin{pmatrix} 2 \\ 1 \\ 2 \end{pmatrix}.$$

For  $\lambda_2 = -1$  we obtain

$$\mathbf{K}_2 = \begin{pmatrix} 0 \\ -2 \\ 1 \end{pmatrix} \quad \text{and} \quad \mathbf{K}_3 = \begin{pmatrix} 1 \\ -2 \\ 0 \end{pmatrix}.$$

Then

$$\mathbf{X} = c_1 \begin{pmatrix} 2 \\ 1 \\ 2 \end{pmatrix} e^{8t} + c_2 \begin{pmatrix} 0 \\ -2 \\ 1 \end{pmatrix} e^{-t} + c_3 \begin{pmatrix} 1 \\ -2 \\ 0 \end{pmatrix} e^{-t}.$$

25. We have  $\det(\mathbf{A} - \lambda\mathbf{I}) = -\lambda(5 - \lambda)^2 = 0$ . For  $\lambda_1 = 0$  we obtain

$$\mathbf{K}_1 = \begin{pmatrix} -4 \\ -5 \\ 2 \end{pmatrix}.$$

For  $\lambda_2 = 5$  we obtain

$$\mathbf{K} = \begin{pmatrix} -2 \\ 0 \\ 1 \end{pmatrix}.$$

A solution of  $(\mathbf{A} - \lambda_1\mathbf{I})\mathbf{P} = \mathbf{K}$  is

$$\mathbf{P} = \begin{pmatrix} 5/2 \\ 1/2 \\ 0 \end{pmatrix}$$

### Exercises 8.2

so that

$$\mathbf{X} = c_1 \begin{pmatrix} -4 \\ -5 \\ 2 \end{pmatrix} + c_2 \begin{pmatrix} -2 \\ 0 \\ 1 \end{pmatrix} e^{5t} + c_3 \left[ \begin{pmatrix} -2 \\ 0 \\ 1 \end{pmatrix} t e^{5t} + \begin{pmatrix} 5/2 \\ 1/2 \\ 0 \end{pmatrix} e^{5t} \right].$$

26. We have  $\det(\mathbf{A} - \lambda\mathbf{I}) = (1 - \lambda)(\lambda - 2)^2 = 0$ . For  $\lambda_1 = 1$  we obtain

$$\mathbf{K}_1 = \begin{pmatrix} 1 \\ 0 \\ 0 \end{pmatrix}.$$

For  $\lambda_2 = 2$  we obtain

$$\mathbf{K} = \begin{pmatrix} 0 \\ -1 \\ 1 \end{pmatrix}.$$

A solution of  $(\mathbf{A} - \lambda_2\mathbf{I})\mathbf{P} = \mathbf{K}$  is

$$\mathbf{P} = \begin{pmatrix} 0 \\ -1 \\ 0 \end{pmatrix}$$

so that

$$\mathbf{X} = c_1 \begin{pmatrix} 1 \\ 0 \\ 0 \end{pmatrix} e^t + c_2 \begin{pmatrix} 0 \\ -1 \\ 1 \end{pmatrix} e^{2t} + c_3 \left[ \begin{pmatrix} 0 \\ -1 \\ 1 \end{pmatrix} t e^{2t} + \begin{pmatrix} 0 \\ -1 \\ 0 \end{pmatrix} e^{2t} \right].$$

27. We have  $\det(\mathbf{A} - \lambda\mathbf{I}) = -(\lambda - 1)^3 = 0$ . For  $\lambda_1 = 1$  we obtain

$$\mathbf{K} = \begin{pmatrix} 0 \\ 1 \\ 1 \end{pmatrix}.$$

Solutions of  $(\mathbf{A} - \lambda_1\mathbf{I})\mathbf{P} = \mathbf{K}$  and  $(\mathbf{A} - \lambda_1\mathbf{I})\mathbf{Q} = \mathbf{P}$  are

$$\mathbf{P} = \begin{pmatrix} 0 \\ 1 \\ 0 \end{pmatrix} \quad \text{and} \quad \mathbf{Q} = \begin{pmatrix} 1/2 \\ 0 \\ 0 \end{pmatrix}$$

so that

$$\mathbf{X} = c_1 \begin{pmatrix} 0 \\ 1 \\ 1 \end{pmatrix} + c_2 \left[ \begin{pmatrix} 0 \\ 1 \\ 1 \end{pmatrix} t e^t + \begin{pmatrix} 0 \\ 1 \\ 0 \end{pmatrix} e^t \right] + c_3 \left[ \begin{pmatrix} 0 \\ 1 \\ 1 \end{pmatrix} \frac{t^2}{2} e^t + \begin{pmatrix} 0 \\ 1 \\ 0 \end{pmatrix} t e^t + \begin{pmatrix} 1/2 \\ 0 \\ 0 \end{pmatrix} e^t \right].$$

28. We have  $\det(\mathbf{A} - \lambda\mathbf{I}) = (\lambda - 4)^3 = 0$ . For  $\lambda_1 = 4$  we obtain

$$\mathbf{K} = \begin{pmatrix} 1 \\ 0 \\ 0 \end{pmatrix}.$$

Solutions of  $(\mathbf{A} - \lambda_1 \mathbf{I})\mathbf{P} = \mathbf{K}$  and  $(\mathbf{A} - \lambda_1 \mathbf{I})\mathbf{Q} = \mathbf{P}$  are

$$\mathbf{P} = \begin{pmatrix} 0 \\ 1 \\ 0 \end{pmatrix} \quad \text{and} \quad \mathbf{Q} = \begin{pmatrix} 0 \\ 0 \\ 1 \end{pmatrix}$$

so that

$$\mathbf{X} = c_1 \begin{pmatrix} 1 \\ 0 \\ 0 \end{pmatrix} e^{4t} + c_2 \left[ \begin{pmatrix} 1 \\ 0 \\ 0 \end{pmatrix} t e^{4t} + \begin{pmatrix} 0 \\ 1 \\ 0 \end{pmatrix} e^{4t} \right] + c_3 \left[ \begin{pmatrix} 1 \\ 0 \\ 0 \end{pmatrix} \frac{t^2}{2} e^{4t} + \begin{pmatrix} 0 \\ 1 \\ 0 \end{pmatrix} t e^{4t} + \begin{pmatrix} 0 \\ 0 \\ 1 \end{pmatrix} e^{4t} \right].$$

29. We have  $\det(\mathbf{A} - \lambda \mathbf{I}) = (\lambda - 4)^2 = 0$ . For  $\lambda_1 = 4$  we obtain

$$\mathbf{K} = \begin{pmatrix} 2 \\ 1 \end{pmatrix}.$$

A solution of  $(\mathbf{A} - \lambda_1 \mathbf{I})\mathbf{P} = \mathbf{K}$  is

$$\mathbf{P} = \begin{pmatrix} 1 \\ 1 \end{pmatrix}$$

so that

$$\mathbf{X} = c_1 \begin{pmatrix} 2 \\ 1 \end{pmatrix} e^{4t} + c_2 \left[ \begin{pmatrix} 2 \\ 1 \end{pmatrix} t e^{4t} + \begin{pmatrix} 1 \\ 1 \end{pmatrix} e^{4t} \right].$$

If

$$\mathbf{X}(0) = \begin{pmatrix} -1 \\ 6 \end{pmatrix}$$

then  $c_1 = -7$  and  $c_2 = 13$ .

30. We have  $\det(\mathbf{A} - \lambda \mathbf{I}) = -(\lambda + 1)(\lambda - 1)^2 = 0$ . For  $\lambda_1 = -1$  we obtain

$$\mathbf{K}_1 = \begin{pmatrix} -1 \\ 0 \\ 1 \end{pmatrix}.$$

For  $\lambda_2 = 1$  we obtain

$$\mathbf{K}_2 = \begin{pmatrix} 1 \\ 0 \\ 1 \end{pmatrix} \quad \text{and} \quad \mathbf{K}_3 = \begin{pmatrix} 0 \\ 1 \\ 0 \end{pmatrix}$$

so that

$$\mathbf{X} = c_1 \begin{pmatrix} -1 \\ 0 \\ 1 \end{pmatrix} e^{-t} + c_2 \begin{pmatrix} 1 \\ 0 \\ 1 \end{pmatrix} e^t + c_3 \begin{pmatrix} 0 \\ 1 \\ 0 \end{pmatrix} e^t.$$

If

$$\mathbf{X}(0) = \begin{pmatrix} 1 \\ 2 \\ 5 \end{pmatrix}$$

## Exercises 8.2

then  $c_1 = 2$ ,  $c_2 = 3$ , and  $c_3 = 2$ .

31. In this case  $\det(\mathbf{A} - \lambda\mathbf{I}) = (2 - \lambda)^5$ , and  $\lambda_1 = 2$  is an eigenvalue of multiplicity 5. Linearly independent eigenvectors are

$$\mathbf{K}_1 = \begin{pmatrix} 1 \\ 0 \\ 0 \\ 0 \\ 0 \end{pmatrix}, \quad \mathbf{K}_2 = \begin{pmatrix} 0 \\ 0 \\ 1 \\ 0 \\ 0 \end{pmatrix}, \quad \text{and} \quad \mathbf{K}_3 = \begin{pmatrix} 0 \\ 0 \\ 0 \\ 1 \\ 0 \end{pmatrix}.$$

32. Letting  $c_1 = 1$  and  $c_2 = 0$  we get  $x = e^t$ ,  $y = e^t$ . Eliminating the parameter we find  $y = x$ ,  $x > 0$ . When  $c_1 = -1$  and  $c_2 = 0$  we find  $y = x$ ,  $x < 0$ .

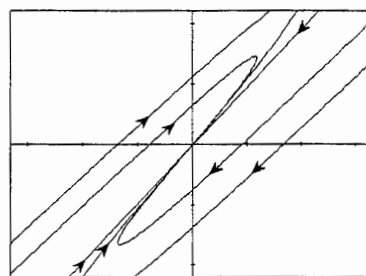

Phase portrait for Problem 20

Letting  $c_1 = 1$  and  $c_2 = 0$  we get  $x = e^{2t}$ ,  $y = e^{2t}$ . Eliminating the parameter we find  $y = x$ ,  $x > 0$ . When  $c_1 = -1$  and  $c_2 = 0$  we find  $y = x$ ,  $x < 0$ .

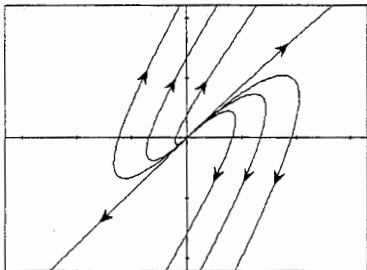

Phase portrait for Problem 21

In Problems 33-46 the form of the answer will vary according to the choice of eigenvector. For example, in Problem 33, if  $\mathbf{K}_1$  is chosen to be  $\begin{pmatrix} 1 \\ 2 - i \end{pmatrix}$  the solution has the form

$$\mathbf{X} = c_1 \begin{pmatrix} \cos t \\ 2 \cos t + \sin t \end{pmatrix} e^{4t} + c_2 \begin{pmatrix} \sin t \\ 2 \sin t - \cos t \end{pmatrix} e^{4t}.$$

33. We have  $\det(\mathbf{A} - \lambda\mathbf{I}) = \lambda^2 - 8\lambda + 17 = 0$ . For  $\lambda_1 = 4 + i$  we obtain



$$\mathbf{K}_1 = \begin{pmatrix} 2+i \\ 5 \end{pmatrix}$$

so that

$$\mathbf{X}_1 = \begin{pmatrix} 2+i \\ 5 \end{pmatrix} e^{(4+i)t} = \begin{pmatrix} 2 \cos t - \sin t \\ 5 \cos t \end{pmatrix} e^{4t} + i \begin{pmatrix} \cos t + 2 \sin t \\ 5 \sin t \end{pmatrix} e^{4t}$$

Then

$$\mathbf{X} = c_1 \begin{pmatrix} 2 \cos t - \sin t \\ 5 \cos t \end{pmatrix} e^{4t} + c_2 \begin{pmatrix} 2 \sin t + \cos t \\ 5 \sin t \end{pmatrix} e^{4t}$$

34. We have  $\det(\mathbf{A} - \lambda\mathbf{I}) = \lambda^2 + 1 = 0$ . For  $\lambda_1 = i$  we obtain

$$\mathbf{K}_1 = \begin{pmatrix} -1-i \\ 2 \end{pmatrix}$$

so that

$$\mathbf{X}_1 = \begin{pmatrix} -1-i \\ 2 \end{pmatrix} e^{it} = \begin{pmatrix} \sin t - \cos t \\ 2 \cos t \end{pmatrix} + i \begin{pmatrix} -\cos t - \sin t \\ 2 \sin t \end{pmatrix}$$

Then

$$\mathbf{X} = c_1 \begin{pmatrix} \sin t - \cos t \\ 2 \cos t \end{pmatrix} + c_2 \begin{pmatrix} -\cos t - \sin t \\ 2 \sin t \end{pmatrix}$$

35. We have  $\det(\mathbf{A} - \lambda\mathbf{I}) = \lambda^2 - 8\lambda + 17 = 0$ . For  $\lambda_1 = 4 + i$  we obtain

$$\mathbf{K}_1 = \begin{pmatrix} -1-i \\ 2 \end{pmatrix}$$

so that

$$\mathbf{X}_1 = \begin{pmatrix} -1-i \\ 2 \end{pmatrix} e^{(4+i)t} = \begin{pmatrix} \sin t - \cos t \\ 2 \cos t \end{pmatrix} e^{4t} + i \begin{pmatrix} -\sin t - \cos t \\ 2 \sin t \end{pmatrix} e^{4t}$$

Then

$$\mathbf{X} = c_1 \begin{pmatrix} \sin t - \cos t \\ 2 \cos t \end{pmatrix} e^{4t} + c_2 \begin{pmatrix} -\sin t - \cos t \\ 2 \sin t \end{pmatrix} e^{4t}$$

36. We have  $\det(\mathbf{A} - \lambda\mathbf{I}) = \lambda^2 - 10\lambda + 34 = 0$ . For  $\lambda_1 = 5 + 3i$  we obtain

$$\mathbf{K}_1 = \begin{pmatrix} 1-3i \\ 2 \end{pmatrix}$$

so that

$$\mathbf{X}_1 = \begin{pmatrix} 1-3i \\ 2 \end{pmatrix} e^{(5+3i)t} = \begin{pmatrix} \cos 3t + 3 \sin 3t \\ 2 \cos 3t \end{pmatrix} e^{5t} + i \begin{pmatrix} \sin 3t - 3 \cos 3t \\ 2 \cos 3t \end{pmatrix} e^{5t}$$

Then

$$\mathbf{X} = c_1 \begin{pmatrix} \cos 3t + 3 \sin 3t \\ 2 \cos 3t \end{pmatrix} e^{5t} + c_2 \begin{pmatrix} \sin 3t - 3 \cos 3t \\ 2 \cos 3t \end{pmatrix} e^{5t}$$

### Exercises 8.2

37. We have  $\det(\mathbf{A} - \lambda\mathbf{I}) = \lambda^2 + 9 = 0$ . For  $\lambda_1 = 3i$  we obtain

$$\mathbf{K}_1 = \begin{pmatrix} 4 + 3i \\ 5 \end{pmatrix}$$

so that

$$\mathbf{X}_1 = \begin{pmatrix} 4 + 3i \\ 5 \end{pmatrix} e^{3it} = \begin{pmatrix} 4 \cos 3t - 3 \sin 3t \\ 5 \cos 3t \end{pmatrix} + i \begin{pmatrix} 4 \sin 3t + 3 \cos 3t \\ 5 \sin 3t \end{pmatrix}.$$

Then

$$\mathbf{X} = c_1 \begin{pmatrix} 4 \cos 3t - 3 \sin 3t \\ 5 \cos 3t \end{pmatrix} + c_2 \begin{pmatrix} 4 \sin 3t + 3 \cos 3t \\ 5 \sin 3t \end{pmatrix}.$$

38. We have  $\det(\mathbf{A} - \lambda\mathbf{I}) = \lambda^2 + 2\lambda + 5 = 0$ . For  $\lambda_1 = -1 + 2i$  we obtain

$$\mathbf{K}_1 = \begin{pmatrix} 2 + 2i \\ 1 \end{pmatrix}$$

so that

$$\begin{aligned} \mathbf{X}_1 &= \begin{pmatrix} 2 + 2i \\ 1 \end{pmatrix} e^{(-1+2i)t} \\ &= (2 \cos 2t - 2 \sin 2t \cos 2t) e^{-t} + i \begin{pmatrix} 2 \cos 2t + 2 \sin 2t \\ \sin 2t \end{pmatrix} e^{-t}. \end{aligned}$$

Then

$$\mathbf{X} = c_1 \begin{pmatrix} 2 \cos 2t - 2 \sin 2t \\ \cos 2t \end{pmatrix} e^{-t} + c_2 \begin{pmatrix} 2 \cos 2t + 2 \sin 2t \\ \sin 2t \end{pmatrix} e^{-t}.$$

39. We have  $\det(\mathbf{A} - \lambda\mathbf{I}) = -\lambda(\lambda^2 + 1) = 0$ . For  $\lambda_1 = 0$  we obtain

$$\mathbf{K}_1 = \begin{pmatrix} 1 \\ 0 \\ 0 \end{pmatrix}.$$

For  $\lambda_2 = i$  we obtain

$$\mathbf{K}_2 = \begin{pmatrix} -i \\ i \\ 1 \end{pmatrix}$$

so that

$$\mathbf{X}_2 = \begin{pmatrix} -i \\ i \\ 1 \end{pmatrix} e^{it} = \begin{pmatrix} \sin t \\ -\sin t \\ \cos t \end{pmatrix} + i \begin{pmatrix} -\cos t \\ \cos t \\ \sin t \end{pmatrix}.$$

Then

$$\mathbf{X} = c_1 \begin{pmatrix} 1 \\ 0 \\ 0 \end{pmatrix} + c_2 \begin{pmatrix} \sin t \\ -\sin t \\ \cos t \end{pmatrix} + c_3 \begin{pmatrix} -\cos t \\ \cos t \\ \sin t \end{pmatrix}.$$

40. We have  $\det(\mathbf{A} - \lambda\mathbf{I}) = -(\lambda + 3)(\lambda^2 - 2\lambda + 5) = 0$ . For  $\lambda_1 = -3$  we obtain

$$\mathbf{K}_1 = \begin{pmatrix} 0 \\ -2 \\ 1 \end{pmatrix}.$$

For  $\lambda_2 = 1 + 2i$  we obtain

$$\mathbf{K}_2 = \begin{pmatrix} -2 - i \\ -3i \\ 2 \end{pmatrix}$$

so that

$$\mathbf{X}_2 = \begin{pmatrix} -2 \cos 2t + \sin 2t \\ 3 \sin 2t \\ 2 \cos 2t \end{pmatrix} e^t + i \begin{pmatrix} -\cos 2t - 2 \sin 2t \\ -3 \cos 2t \\ 2 \sin 2t \end{pmatrix} e^t.$$

Then

$$\mathbf{X} = c_1 \begin{pmatrix} 0 \\ -2 \\ 1 \end{pmatrix} e^{-3t} + c_2 \begin{pmatrix} -2 \cos 2t + \sin 2t \\ 3 \sin 2t \\ 2 \cos 2t \end{pmatrix} e^t + c_3 \begin{pmatrix} -\cos 2t - 2 \sin 2t \\ -3 \cos 2t \\ 2 \sin 2t \end{pmatrix} e^t.$$

41. We have  $\det(\mathbf{A} - \lambda\mathbf{I}) = (1 - \lambda)(\lambda^2 - 2\lambda + 2) = 0$ . For  $\lambda_1 = 1$  we obtain

$$\mathbf{K}_1 = \begin{pmatrix} 0 \\ 2 \\ 1 \end{pmatrix}.$$

For  $\lambda_2 = 1 + i$  we obtain

$$\mathbf{K}_2 = \begin{pmatrix} 1 \\ i \\ i \end{pmatrix}$$

so that

$$\mathbf{X}_2 = \begin{pmatrix} 1 \\ i \\ i \end{pmatrix} e^{(1+i)t} = \begin{pmatrix} \cos t \\ -\sin t \\ -\sin t \end{pmatrix} e^t + i \begin{pmatrix} \sin t \\ \cos t \\ \cos t \end{pmatrix} e^t.$$

Then

$$\mathbf{X} = c_1 \begin{pmatrix} 0 \\ 2 \\ 1 \end{pmatrix} e^t + c_2 \begin{pmatrix} \cos t \\ -\sin t \\ -\sin t \end{pmatrix} e^t + c_3 \begin{pmatrix} \sin t \\ \cos t \\ \cos t \end{pmatrix} e^t.$$

42. We have  $\det(\mathbf{A} - \lambda\mathbf{I}) = -(\lambda - 6)(\lambda^2 - 8\lambda + 20) = 0$ . For  $\lambda_1 = 6$  we obtain

$$\mathbf{K}_1 = \begin{pmatrix} 0 \\ 1 \\ 0 \end{pmatrix}.$$

### Exercises 8.2

For  $\lambda_2 = 4 + 2i$  we obtain

$$\mathbf{K}_2 = \begin{pmatrix} -i \\ 0 \\ 2 \end{pmatrix}$$

so that

$$\mathbf{X}_2 = \begin{pmatrix} -i \\ 0 \\ 2 \end{pmatrix} e^{(4+2i)t} = \begin{pmatrix} \sin 2t \\ 0 \\ 2 \cos 2t \end{pmatrix} e^{4t} + i \begin{pmatrix} -\cos 2t \\ 0 \\ 2 \sin 2t \end{pmatrix} e^{4t}.$$

Then

$$\mathbf{X} = c_1 \begin{pmatrix} 0 \\ 1 \\ 0 \end{pmatrix} e^{6t} + c_2 \begin{pmatrix} \sin 2t \\ 0 \\ 2 \cos 2t \end{pmatrix} e^{4t} + c_3 \begin{pmatrix} -\cos 2t \\ 0 \\ 2 \sin 2t \end{pmatrix} e^{4t}.$$

43. We have  $\det(\mathbf{A} - \lambda\mathbf{I}) = (2 - \lambda)(\lambda^2 + 4\lambda + 13) = 0$ . For  $\lambda_1 = 2$  we obtain

$$\mathbf{K}_1 = \begin{pmatrix} 28 \\ -5 \\ 25 \end{pmatrix}.$$

For  $\lambda_2 = -2 + 3i$  we obtain

$$\mathbf{K}_2 = \begin{pmatrix} 4 + 3i \\ -5 \\ 0 \end{pmatrix}$$

so that

$$\mathbf{X}_2 = \begin{pmatrix} 4 + 3i \\ -5 \\ 0 \end{pmatrix} e^{(-2+3i)t} = \begin{pmatrix} 4 \cos 3t - 3 \sin 3t \\ -5 \cos 3t \\ 0 \end{pmatrix} e^{-2t} + i \begin{pmatrix} 4 \sin 3t + 3 \cos 3t \\ -5 \sin 3t \\ 0 \end{pmatrix} e^{-2t}.$$

Then

$$\mathbf{X} = c_1 \begin{pmatrix} 28 \\ -5 \\ 25 \end{pmatrix} e^{2t} + c_2 \begin{pmatrix} 4 \cos 3t - 3 \sin 3t \\ -5 \cos 3t \\ 0 \end{pmatrix} e^{-2t} + c_3 \begin{pmatrix} 4 \sin 3t + 3 \cos 3t \\ -5 \sin 3t \\ 0 \end{pmatrix} e^{-2t}.$$

44. We have  $\det(\mathbf{A} - \lambda\mathbf{I}) = -(\lambda + 2)(\lambda^2 + 4) = 0$ . For  $\lambda_1 = -2$  we obtain

$$\mathbf{K}_1 = \begin{pmatrix} 0 \\ -1 \\ 1 \end{pmatrix}.$$

For  $\lambda_2 = 2i$  we obtain

$$\mathbf{K}_2 = \begin{pmatrix} -2 - 2i \\ 1 \\ 1 \end{pmatrix}$$

so that

$$\mathbf{X}_2 = \begin{pmatrix} -2 - 2i \\ 1 \\ 1 \end{pmatrix} e^{2it} = \begin{pmatrix} -2 \cos 2t + 2 \sin 2t \\ \cos 2t \\ \cos 2t \end{pmatrix} + i \begin{pmatrix} -2 \cos 2t - 2 \sin 2t \\ \sin 2t \\ \sin 2t \end{pmatrix}.$$

Then

$$\mathbf{X} = c_1 \begin{pmatrix} 0 \\ -1 \\ 1 \end{pmatrix} e^{-2t} + c_2 \begin{pmatrix} -2 \cos 2t + 2 \sin 2t \\ \cos 2t \\ \cos 2t \end{pmatrix} + c_3 \begin{pmatrix} -2 \cos 2t - 2 \sin 2t \\ \sin 2t \\ \sin 2t \end{pmatrix}.$$

45. We have  $\det(\mathbf{A} - \lambda\mathbf{I}) = (1 - \lambda)(\lambda^2 + 25) = 0$ . For  $\lambda_1 = 1$  we obtain

$$\mathbf{K}_1 = \begin{pmatrix} 25 \\ -7 \\ 6 \end{pmatrix}.$$

For  $\lambda_2 = 5i$  we obtain

$$\mathbf{K}_2 = \begin{pmatrix} 1 + 5i \\ 1 \\ 1 \end{pmatrix}$$

so that

$$\mathbf{X}_2 = \begin{pmatrix} 1 + 5i \\ 1 \\ 1 \end{pmatrix} e^{5it} = \begin{pmatrix} \cos 5t - 5 \sin 5t \\ \cos 5t \\ \cos 5t \end{pmatrix} + i \begin{pmatrix} \sin 5t + 5 \cos 5t \\ \sin 5t \\ \sin 5t \end{pmatrix}.$$

Then

$$\mathbf{X} = c_1 \begin{pmatrix} 25 \\ -7 \\ 6 \end{pmatrix} e^t + c_2 \begin{pmatrix} \cos 5t - 5 \sin 5t \\ \cos 5t \\ \cos 5t \end{pmatrix} + c_3 \begin{pmatrix} \sin 5t + 5 \cos 5t \\ \sin 5t \\ \sin 5t \end{pmatrix}.$$

If

$$\mathbf{X}(0) = \begin{pmatrix} 4 \\ 6 \\ -7 \end{pmatrix}$$

then  $c_1 = c_2 = -1$  and  $c_3 = 6$ .

46. We have  $\det(\mathbf{A} - \lambda\mathbf{I}) = \lambda^2 - 10\lambda + 29 = 0$ . For  $\lambda_1 = 5 + 2i$  we obtain

$$\mathbf{K}_1 = \begin{pmatrix} 1 \\ 1 - 2i \end{pmatrix}$$

so that

$$\mathbf{X}_1 = \begin{pmatrix} 1 \\ 1 - 2i \end{pmatrix} e^{(5+2i)t} = \begin{pmatrix} \cos 2t \\ \cos 2t + 2 \sin 2t \end{pmatrix} e^{5t} + i \begin{pmatrix} \sin 2t \\ \sin 2t - 2 \cos 2t \end{pmatrix} e^{5t}.$$

and

$$\mathbf{X} = c_1 \begin{pmatrix} \cos 2t \\ \cos 2t + 2 \sin 2t \end{pmatrix} e^{5t} + c_3 \begin{pmatrix} \sin 2t \\ \sin 2t - 2 \cos 2t \end{pmatrix} e^{5t}.$$

Exercises 8.2

If

$$\mathbf{X}(0) = \begin{pmatrix} -2 \\ 8 \end{pmatrix}$$

then  $c_1 = -2$  and  $c_2 = 5$ .

47.

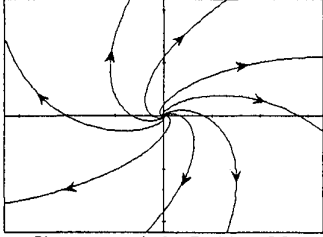

Phase portrait for Problem 36

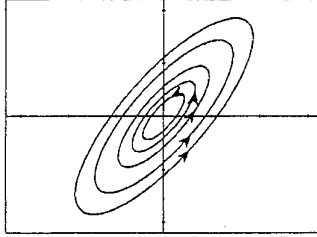

Phase portrait for Problem 37

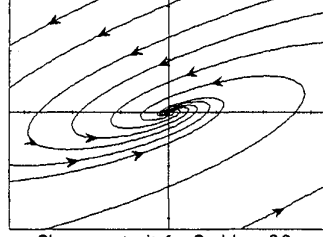

Phase portrait for Problem 38

48. (a) Letting  $x_1 = y_1$ ,  $x'_1 = y_2$ ,  $x_2 = y_3$ , and  $x'_2 = y_4$  we have

$$y'_2 = x''_1 = -10x_1 + 4x_2 = -10y_1 + 4y_3$$

$$y'_4 = x''_2 = 4x_1 - 4x_2 = 4y_1 - 4y_3.$$

The corresponding linear system is

$$y'_1 = y_2$$

$$y'_2 = -10y_1 + 4y_3$$

$$y'_3 = y_4$$

$$y'_4 = 4y_1 - 4y_3$$

or

$$\mathbf{Y}' = \begin{bmatrix} 0 & 1 & 0 & 0 \\ -10 & 0 & 4 & 0 \\ 0 & 0 & 0 & 1 \\ 4 & 0 & -4 & 0 \end{bmatrix} \mathbf{Y}.$$

Using a CAS, we find eigenvalues  $\pm\sqrt{2}i$  and  $\pm 2\sqrt{3}i$  with corresponding eigenvectors

$$\begin{bmatrix} \mp\sqrt{2}i/4 \\ 1/2 \\ \mp\sqrt{2}i/2 \\ 1 \end{bmatrix} = \begin{bmatrix} 0 \\ 1/2 \\ 0 \\ 1 \end{bmatrix} \pm i \begin{bmatrix} \mp\sqrt{2}/4 \\ 0 \\ \mp\sqrt{2}/2 \\ 0 \end{bmatrix}$$

and

$$\begin{bmatrix} \pm\sqrt{3}i/3 \\ -2 \\ \mp\sqrt{3}i/6 \\ 1 \end{bmatrix} = \begin{bmatrix} 0 \\ -2 \\ 0 \\ 1 \end{bmatrix} \pm i \begin{bmatrix} -\sqrt{3}/3 \\ 0 \\ \sqrt{3}/6 \\ 0 \end{bmatrix}.$$

Thus

$$\begin{aligned} \mathbf{Y}(t) = & c_1 \left( \begin{bmatrix} 0 \\ 1/2 \\ 0 \\ 1 \end{bmatrix} \cos \sqrt{2}t - \begin{bmatrix} -\sqrt{2}/4 \\ 0 \\ -\sqrt{2}/2 \\ 0 \end{bmatrix} \sin \sqrt{2}t \right) \\ & + c_2 \left( \begin{bmatrix} -\sqrt{2}/4 \\ 0 \\ -\sqrt{2}/2 \\ 0 \end{bmatrix} \cos \sqrt{2}t + \begin{bmatrix} 0 \\ 1/2 \\ 0 \\ 1 \end{bmatrix} \sin \sqrt{2}t \right) \\ & + c_3 \left( \begin{bmatrix} 0 \\ -2 \\ 0 \\ 1 \end{bmatrix} \cos 2\sqrt{3}t - \begin{bmatrix} \sqrt{3}/3 \\ 0 \\ -\sqrt{3}/6 \\ 0 \end{bmatrix} \sin 2\sqrt{3}t \right) \\ & + c_4 \left( \begin{bmatrix} \sqrt{3}/3 \\ 0 \\ -\sqrt{3}/6 \\ 0 \end{bmatrix} \cos 2\sqrt{3}t + \begin{bmatrix} 0 \\ -2 \\ 0 \\ 1 \end{bmatrix} \sin 2\sqrt{3}t \right). \end{aligned}$$

The initial conditions  $y_1(0) = 0$ ,  $y_2(0) = 1$ ,  $y_3(0) = 0$ , and  $y_4(0) = -1$  imply  $c_1 = -\frac{2}{5}$ ,  $c_2 = 0$ ,  $c_3 = -\frac{3}{5}$ , and  $c_4 = 0$ . Thus,

$$x_1(t) = y_1(t) = -\frac{\sqrt{2}}{10} \sin \sqrt{2}t + \frac{\sqrt{3}}{5} \sin 2\sqrt{3}t$$

$$x_2(t) = y_3(t) = -\frac{\sqrt{2}}{5} \sin \sqrt{2}t - \frac{\sqrt{3}}{10} \sin 2\sqrt{3}t.$$

(b) The second-order system is

$$x_1'' = -10x_1 + 4x_2$$

$$x_2'' = 4x_1 - 4x_2$$

or

$$\mathbf{X}'' = \begin{bmatrix} -10 & 4 \\ 4 & -4 \end{bmatrix} \mathbf{X}.$$

We assume solutions of the form  $\mathbf{X} = \mathbf{V} \cos \omega t$  and  $\mathbf{X} = \mathbf{V} \sin \omega t$ . Since the eigenvalues are  $-2$  and  $-12$ ,  $\omega_1 = \sqrt{-(-2)} = \sqrt{2}$  and  $\omega_2 = \sqrt{-(-12)} = 2\sqrt{3}$ . The corresponding eigenvectors

## Exercises 8.2

are

$$\mathbf{V}_1 = \begin{bmatrix} 1 \\ 2 \end{bmatrix} \quad \text{and} \quad \mathbf{V}_2 = \begin{bmatrix} -2 \\ 1 \end{bmatrix}.$$

Then, the general solution of the system is

$$\mathbf{X} = c_1 \begin{bmatrix} 1 \\ 2 \end{bmatrix} \cos \sqrt{2}t + c_2 \begin{bmatrix} 1 \\ 2 \end{bmatrix} \sin \sqrt{2}t + c_3 \begin{bmatrix} -2 \\ 1 \end{bmatrix} \cos 2\sqrt{3}t + c_4 \begin{bmatrix} -2 \\ 1 \end{bmatrix} \sin 2\sqrt{3}t.$$

The initial conditions

$$\mathbf{X}(0) = \begin{bmatrix} 0 \\ 0 \end{bmatrix} \quad \text{and} \quad \mathbf{X}'(0) = \begin{bmatrix} 1 \\ -1 \end{bmatrix}$$

imply  $c_1 = 0$ ,  $c_2 = -\sqrt{2}/10$ ,  $c_3 = 0$ , and  $c_4 = -\sqrt{3}/10$ . Thus

$$x_1(t) = -\frac{\sqrt{2}}{10} \sin \sqrt{2}t + \frac{\sqrt{3}}{5} \sin 2\sqrt{3}t$$

$$x_2(t) = -\frac{\sqrt{2}}{5} \sin \sqrt{2}t - \frac{\sqrt{3}}{10} \sin 2\sqrt{3}t.$$

49. (a) From  $\det(\mathbf{A} - \lambda\mathbf{I}) = \lambda(\lambda - 2) = 0$  we get  $\lambda_1 = 0$  and  $\lambda_2 = 2$ . For  $\lambda_1 = 0$  we obtain

$$\left( \begin{array}{cc|c} 1 & 1 & 0 \\ 1 & 1 & 0 \end{array} \right) \Rightarrow \left( \begin{array}{cc|c} 1 & 1 & 0 \\ 0 & 0 & 0 \end{array} \right) \quad \text{so that} \quad \mathbf{K}_1 = \begin{pmatrix} -1 \\ 1 \end{pmatrix}.$$

For  $\lambda_2 = 2$  we obtain

$$\left( \begin{array}{cc|c} -1 & 1 & 0 \\ 1 & -1 & 0 \end{array} \right) \Rightarrow \left( \begin{array}{cc|c} -1 & 1 & 0 \\ 0 & 0 & 0 \end{array} \right) \quad \text{so that} \quad \mathbf{K}_2 = \begin{pmatrix} 1 \\ 1 \end{pmatrix}.$$

Then

$$\mathbf{X} = c_1 \begin{pmatrix} -1 \\ 1 \end{pmatrix} + c_2 \begin{pmatrix} 1 \\ 1 \end{pmatrix} e^{2t}.$$

The line  $y = -x$  is not a trajectory of the system. Trajectories are  $x = -c_1 + c_2 e^{2t}$ ,  $y = c_1 + c_2 e^{2t}$  or  $y = x + 2c_1$ . This is a family of lines perpendicular to the line  $y = -x$ . All of the constant solutions of the system do, however, lie on the line  $y = -x$ .

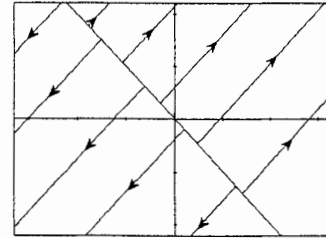

- (b) From  $\det(\mathbf{A} - \lambda\mathbf{I}) = \lambda^2 = 0$  we get  $\lambda_1 = 0$  and

$$\mathbf{K} = \begin{pmatrix} -1 \\ 1 \end{pmatrix}.$$

A solution of  $(\mathbf{A} - \lambda_1\mathbf{I})\mathbf{P} = \mathbf{K}$  is

$$\mathbf{P} = \begin{pmatrix} -1 \\ 0 \end{pmatrix}$$



so that

$$\mathbf{X} = c_1 \begin{pmatrix} -1 \\ 1 \end{pmatrix} + c_2 \left[ \begin{pmatrix} -1 \\ 1 \end{pmatrix} t + \begin{pmatrix} -1 \\ 0 \end{pmatrix} \right].$$

All trajectories are parallel to  $y = -x$ , but  $y = -x$  is not a trajectory. There are constant solutions of the system, however, that do lie on the line  $y = -x$ .

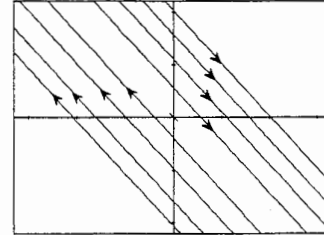

50. The system of differential equations is

$$x'_1 = 2x_1 + x_2$$

$$x'_2 = 2x_2$$

$$x'_3 = 2x_3$$

$$x'_4 = 2x_4 + x_5$$

$$x'_5 = 2x_5.$$

We see immediately that  $x_2 = c_2 e^{2t}$ ,  $x_3 = c_3 e^{2t}$ , and  $x_5 = c_5 e^{2t}$ . Then

$$x'_1 = 2x_1 + c_2 e^{2t} \implies x_1 = c_2 t e^{2t} + c_1 e^{2t}$$

and

$$x'_4 = 2x_4 + c_5 e^{2t} \implies x_4 = c_5 t e^{2t} + c_4 e^{2t}.$$

### Exercises 8.2

The general-solution of the system is

$$\begin{aligned}
 \mathbf{X} &= \begin{pmatrix} c_2te^{2t} + c_1e^{2t} \\ c_2e^{2t} \\ c_3e^{2t} \\ c_5te^{2t} + c_4e^{2t} \\ c_5e^{2t} \end{pmatrix} \\
 &= c_1 \begin{pmatrix} 1 \\ 0 \\ 0 \\ 0 \\ 0 \end{pmatrix} e^{2t} + c_2 \left[ \begin{pmatrix} 1 \\ 0 \\ 0 \\ 0 \\ 0 \end{pmatrix} te^{2t} + \begin{pmatrix} 0 \\ 1 \\ 0 \\ 0 \\ 0 \end{pmatrix} e^{2t} \right] \\
 &\quad + c_3 \begin{pmatrix} 0 \\ 0 \\ 1 \\ 0 \\ 0 \end{pmatrix} e^{2t} + c_4 \begin{pmatrix} 0 \\ 0 \\ 0 \\ 1 \\ 0 \end{pmatrix} e^{2t} + c_5 \left[ \begin{pmatrix} 0 \\ 0 \\ 0 \\ 1 \\ 0 \end{pmatrix} te^{2t} + \begin{pmatrix} 0 \\ 0 \\ 0 \\ 0 \\ 1 \end{pmatrix} e^{2t} \right] \\
 &= c_1 \mathbf{K}_1 e^{2t} + c_2 \left[ \mathbf{K}_1 te^{2t} + \begin{pmatrix} 0 \\ 1 \\ 0 \\ 0 \\ 0 \end{pmatrix} e^{2t} \right] \\
 &\quad + c_3 \mathbf{K}_2 e^{2t} + c_4 \mathbf{K}_3 e^{2t} + c_5 \left[ \mathbf{K}_3 te^{2t} + \begin{pmatrix} 0 \\ 0 \\ 0 \\ 0 \\ 1 \end{pmatrix} e^{2t} \right].
 \end{aligned}$$

There are three solutions of the form  $\mathbf{X} = \mathbf{K}e^{2t}$ , where  $\mathbf{K}$  is an eigenvector, and two solutions of the form  $\mathbf{X} = \mathbf{K}te^{2t} + \mathbf{P}e^{2t}$ . See (12) in the text. From (13) and (14) in the text

$$(\mathbf{A} - 2\mathbf{I})\mathbf{K}_1 = \mathbf{0}$$

and

$$(\mathbf{A} - 2\mathbf{I})\mathbf{K}_2 = \mathbf{K}_1.$$

This implies

$$\begin{pmatrix} 0 & 1 & 0 & 0 & 0 \\ 0 & 0 & 0 & 0 & 0 \\ 0 & 0 & 0 & 0 & 0 \\ 0 & 0 & 0 & 0 & 1 \\ 0 & 0 & 0 & 0 & 0 \end{pmatrix} \begin{pmatrix} p_1 \\ p_2 \\ p_3 \\ p_4 \\ p_5 \end{pmatrix} = \begin{pmatrix} 1 \\ 0 \\ 0 \\ 0 \\ 0 \end{pmatrix},$$

so  $p_2 = 1$  and  $p_5 = 0$ , while  $p_1, p_3$ , and  $p_4$  are arbitrary. Choosing  $p_1 = p_3 = p_4 = 0$  we have

$$\mathbf{P} = \begin{pmatrix} 1 \\ 0 \\ 0 \\ 0 \\ 0 \end{pmatrix}.$$

Therefore a solution is

$$\mathbf{X} = \begin{pmatrix} 1 \\ 0 \\ 0 \\ 0 \\ 0 \end{pmatrix} te^{2t} + \begin{pmatrix} 1 \\ 0 \\ 0 \\ 0 \\ 0 \end{pmatrix} e^{2t}.$$

Repeating for  $\mathbf{K}_3$  we find

$$\mathbf{P} = \begin{pmatrix} 0 \\ 0 \\ 0 \\ 0 \\ 1 \end{pmatrix},$$

so another solution is

$$\mathbf{X} = \begin{pmatrix} 0 \\ 0 \\ 0 \\ 1 \\ 0 \end{pmatrix} te^{2t} + \begin{pmatrix} 0 \\ 0 \\ 0 \\ 0 \\ 1 \end{pmatrix} e^{2t}.$$

51. From  $x = 2 \cos 2t - 2 \sin 2t$ ,  $y = -\cos 2t$  we find  $x + 2y = -2 \sin 2t$ . Then

$$(x + 2y)^2 = 4 \sin^2 2t = 4(1 - \cos^2 2t) = 4 - 4 \cos^2 2t = 4 - 4y^2$$

and

$$x^2 + 4xy + 4y^2 = 4 - 4y^2 \quad \text{or} \quad x^2 + 4xy + 8y^2 = 4.$$

## Exercises 8.2

This is a rotated conic section and, from the discriminant  $b^2 - 4ac = 16 - 32 < 0$ , we see that the curve is an ellipse.

52. Suppose the eigenvalues are  $\alpha \pm i\beta$ ,  $\beta > 0$ . In Problem 36 the eigenvalues are  $5 \pm 3i$ , in Problem 37 they are  $\pm 3i$ , and in Problem 38 they are  $-1 \pm 2i$ . From Problem 47 we deduce that the phase portrait will consist of a family of closed curves when  $\alpha = 0$  and spirals when  $\alpha \neq 0$ . The origin will be a repeller when  $\alpha > 0$ , and an attractor when  $\alpha < 0$ .

---

## Exercises 8.3

---

1. From

$$\mathbf{X}' = \begin{pmatrix} 3 & -3 \\ 2 & -2 \end{pmatrix} \mathbf{X} + \begin{pmatrix} 4 \\ -1 \end{pmatrix}$$

we obtain

$$\mathbf{X}_c = c_1 \begin{pmatrix} 1 \\ 1 \end{pmatrix} + c_2 \begin{pmatrix} 3 \\ 2 \end{pmatrix} e^t.$$

Then

$$\Phi = \begin{pmatrix} 1 & 3e^t \\ 1 & 2e^t \end{pmatrix} \quad \text{and} \quad \Phi^{-1} = \begin{pmatrix} -2 & 3 \\ e^{-t} & -e^{-t} \end{pmatrix}$$

so that

$$\mathbf{U} = \int \Phi^{-1} \mathbf{F} dt = \int \begin{pmatrix} -11 \\ 5e^{-t} \end{pmatrix} dt = \begin{pmatrix} -11t \\ -5e^{-t} \end{pmatrix}$$

and

$$\mathbf{X}_p = \Phi \mathbf{U} = \begin{pmatrix} -11 \\ -11 \end{pmatrix} t + \begin{pmatrix} -15 \\ -10 \end{pmatrix}.$$

2. From

$$\mathbf{X}' = \begin{pmatrix} 2 & -1 \\ 3 & -2 \end{pmatrix} \mathbf{X} + \begin{pmatrix} 0 \\ 4 \end{pmatrix} t$$

we obtain

$$\mathbf{X}_c = c_1 \begin{pmatrix} 1 \\ 1 \end{pmatrix} e^t + c_2 \begin{pmatrix} 1 \\ 3 \end{pmatrix} e^{-t}.$$

Then

$$\Phi = \begin{pmatrix} e^t & e^{-t} \\ e^t & 3e^{-t} \end{pmatrix} \quad \text{and} \quad \Phi^{-1} = \begin{pmatrix} \frac{3}{2}e^{-t} & -\frac{1}{2}e^{-t} \\ -\frac{1}{2}e^t & \frac{1}{2}e^t \end{pmatrix}$$

so that

$$\mathbf{U} = \int \Phi^{-1} \mathbf{F} dt = \int \begin{pmatrix} -2te^{-t} \\ 2te^t \end{pmatrix} dt = \begin{pmatrix} 2te^{-t} + 2e^{-t} \\ 2te^t - 2e^t \end{pmatrix}$$

and

$$\mathbf{X}_p = \Phi \mathbf{U} = \begin{pmatrix} 4 \\ 8 \end{pmatrix} t + \begin{pmatrix} 0 \\ -4 \end{pmatrix}.$$

3. From

$$\mathbf{X}' = \begin{pmatrix} 3 & -5 \\ 3/4 & -1 \end{pmatrix} \mathbf{X} + \begin{pmatrix} 1 \\ -1 \end{pmatrix} e^{t/2}$$

we obtain

$$\mathbf{X}_c = c_1 \begin{pmatrix} 10 \\ 3 \end{pmatrix} e^{3t/2} + c_2 \begin{pmatrix} 2 \\ 1 \end{pmatrix} e^{t/2}.$$

Then

$$\Phi = \begin{pmatrix} 10e^{3t/2} & 2e^{t/2} \\ 3e^{3t/2} & e^{t/2} \end{pmatrix} \quad \text{and} \quad \Phi^{-1} = \begin{pmatrix} \frac{1}{4}e^{-3t/2} & -\frac{1}{2}e^{-3t/2} \\ -\frac{3}{4}e^{-t/2} & \frac{5}{2}e^{-t/2} \end{pmatrix}$$

so that

$$\mathbf{U} = \int \Phi^{-1} \mathbf{F} dt = \int \begin{pmatrix} \frac{3}{4}e^{-t} \\ -\frac{13}{4} \end{pmatrix} dt = \begin{pmatrix} -\frac{3}{4}e^{-t} \\ -\frac{13}{4}t \end{pmatrix}$$

and

$$\mathbf{X}_p = \Phi \mathbf{U} = \begin{pmatrix} -13/2 \\ -13/4 \end{pmatrix} te^{t/2} + \begin{pmatrix} -15/2 \\ -9/4 \end{pmatrix} e^{t/2}.$$

4. From

$$\mathbf{X}' = \begin{pmatrix} 2 & -1 \\ 4 & 2 \end{pmatrix} \mathbf{X} + \begin{pmatrix} \sin 2t \\ 2 \cos 2t \end{pmatrix}$$

we obtain

$$\mathbf{X}_c = c_1 \begin{pmatrix} -\sin 2t \\ 2 \cos 2t \end{pmatrix} e^{2t} + c_2 \begin{pmatrix} \cos 2t \\ 2 \sin 2t \end{pmatrix} e^{2t}.$$

Then

$$\Phi = \begin{pmatrix} -e^{2t} \sin 2t & e^{2t} \cos 2t \\ 2e^{2t} \cos 2t & 2e^{2t} \sin 2t \end{pmatrix} \quad \text{and} \quad \Phi^{-1} = \begin{pmatrix} -\frac{1}{2}e^{-2t} \sin 2t & \frac{1}{4}e^{-2t} \cos 2t \\ \frac{1}{2}e^{-2t} \cos 2t & \frac{1}{4}e^{-2t} \sin 2t \end{pmatrix}$$

so that

$$\mathbf{U} = \int \Phi^{-1} \mathbf{F} dt = \int \begin{pmatrix} \frac{1}{2} \cos 4t \\ \frac{1}{2} \sin 4t \end{pmatrix} dt = \begin{pmatrix} \frac{1}{8} \sin 4t \\ -\frac{1}{8} \cos 4t \end{pmatrix}$$

and

$$\mathbf{X}_p = \Phi \mathbf{U} = \begin{pmatrix} -\frac{1}{8} \sin 2t \cos 4t - \frac{1}{8} \cos 2t \cos 4t \\ \frac{1}{4} \cos 2t \sin 4t - \frac{1}{4} \sin 2t \cos 4t \end{pmatrix} e^{2t}.$$

5. From

$$\mathbf{X}' = \begin{pmatrix} 0 & 2 \\ -1 & 3 \end{pmatrix} \mathbf{X} + \begin{pmatrix} 1 \\ -1 \end{pmatrix} e^t$$

we obtain

$$\mathbf{X}_c = c_1 \begin{pmatrix} 2 \\ 1 \end{pmatrix} e^t + c_2 \begin{pmatrix} 1 \\ 1 \end{pmatrix} e^{2t}.$$

Then

$$\Phi = \begin{pmatrix} 2e^t & e^{2t} \\ e^t & e^{2t} \end{pmatrix} \quad \text{and} \quad \Phi^{-1} = \begin{pmatrix} e^{-t} & -e^{-t} \\ -e^{-2t} & 2e^{-2t} \end{pmatrix}$$

### Exercises 8.3

so that

$$\mathbf{U} = \int \Phi^{-1} \mathbf{F} dt = \int \begin{pmatrix} 2 \\ -3e^{-t} \end{pmatrix} dt = \begin{pmatrix} 2t \\ 3e^{-t} \end{pmatrix}$$

and

$$\mathbf{X}_p = \Phi \mathbf{U} = \begin{pmatrix} 4 \\ 2 \end{pmatrix} te^t + \begin{pmatrix} 3 \\ 3 \end{pmatrix} e^t.$$

6. From

$$\mathbf{X}' = \begin{pmatrix} 0 & 2 \\ -1 & 3 \end{pmatrix} \mathbf{X} + \begin{pmatrix} 2 \\ e^{-3t} \end{pmatrix}$$

we obtain

$$\mathbf{X}_c = c_1 \begin{pmatrix} 2 \\ 1 \end{pmatrix} e^t + c_2 \begin{pmatrix} 1 \\ 1 \end{pmatrix} e^{2t}.$$

Then

$$\Phi = \begin{pmatrix} 2e^t & e^{2t} \\ e^t & e^{2t} \end{pmatrix} \quad \text{and} \quad \Phi^{-1} = \begin{pmatrix} e^{-t} & -e^{-t} \\ -e^{-2t} & 2e^{-2t} \end{pmatrix}$$

so that

$$\mathbf{U} = \int \Phi^{-1} \mathbf{F} dt = \int \begin{pmatrix} 2e^{-t} - e^{-4t} \\ -2e^{-2t} + 2e^{-5t} \end{pmatrix} dt = \begin{pmatrix} -2e^{-t} + \frac{1}{4}e^{-4t} \\ e^{-2t} - \frac{2}{5}e^{-5t} \end{pmatrix}$$

and

$$\mathbf{X}_p = \Phi \mathbf{U} = \begin{pmatrix} \frac{1}{10}e^{-3t} - 3 \\ -\frac{3}{20}e^{-3t} - 1 \end{pmatrix}.$$

7. From

$$\mathbf{X}' = \begin{pmatrix} 1 & 8 \\ 1 & -1 \end{pmatrix} \mathbf{X} + \begin{pmatrix} 12 \\ 12 \end{pmatrix} t$$

we obtain

$$\mathbf{X}_c = c_1 \begin{pmatrix} 4 \\ 1 \end{pmatrix} e^{3t} + c_2 \begin{pmatrix} -2 \\ 1 \end{pmatrix} e^{-3t}.$$

Then

$$\Phi = \begin{pmatrix} 4e^{3t} & -2e^{-3t} \\ e^{3t} & e^{-3t} \end{pmatrix} \quad \text{and} \quad \Phi^{-1} = \begin{pmatrix} \frac{1}{6}e^{-3t} & \frac{1}{3}e^{-3t} \\ -\frac{1}{6}e^{3t} & \frac{2}{3}e^{3t} \end{pmatrix}$$

so that

$$\mathbf{U} = \int \Phi^{-1} \mathbf{F} dt = \int \begin{pmatrix} 6te^{-3t} \\ 6te^{3t} \end{pmatrix} dt = \begin{pmatrix} -2te^{-3t} - \frac{2}{3}e^{-3t} \\ 2te^{3t} - \frac{2}{3}e^{3t} \end{pmatrix}$$

and

$$\mathbf{X}_p = \Phi \mathbf{U} = \begin{pmatrix} -12 \\ 0 \end{pmatrix} t + \begin{pmatrix} -4/3 \\ -4/3 \end{pmatrix}.$$

8. From

$$\mathbf{X}' = \begin{pmatrix} 1 & 8 \\ 1 & -1 \end{pmatrix} \mathbf{X} + \begin{pmatrix} e^{-t} \\ te^t \end{pmatrix}$$

we obtain

$$\mathbf{X}_c = c_1 \begin{pmatrix} 4 \\ 1 \end{pmatrix} e^{3t} + c_2 \begin{pmatrix} -2 \\ 1 \end{pmatrix} e^{-3t}.$$

Then

$$\Phi = \begin{pmatrix} 4e^{3t} & -2e^{3t} \\ e^{3t} & e^{-3t} \end{pmatrix} \quad \text{and} \quad \Phi^{-1} = \begin{pmatrix} \frac{1}{6}e^{-3t} & \frac{1}{3}e^{-3t} \\ -\frac{1}{6}e^{3t} & \frac{2}{3}e^{3t} \end{pmatrix}$$

so that

$$\mathbf{U} = \int \Phi^{-1} \mathbf{F} dt = \int \begin{pmatrix} \frac{1}{6}e^{-4t} + \frac{1}{3}te^{-2t} \\ -\frac{1}{6}e^{2t} + \frac{2}{3}te^{4t} \end{pmatrix} dt = \begin{pmatrix} -\frac{1}{24}e^{-4t} - \frac{1}{6}te^{-2t} - \frac{1}{12}e^{-2t} \\ -\frac{1}{12}e^{2t} + \frac{1}{6}te^{4t} - \frac{1}{24}e^{4t} \end{pmatrix}$$

and

$$\mathbf{X}_p = \Phi \mathbf{U} = \begin{pmatrix} -te^t - \frac{1}{4}e^t \\ -\frac{1}{8}e^{-t} - \frac{1}{8}e^t \end{pmatrix}.$$

9. From

$$\mathbf{X}' = \begin{pmatrix} 3 & 2 \\ -2 & -1 \end{pmatrix} \mathbf{X} + \begin{pmatrix} 2 \\ 1 \end{pmatrix} e^{-t}$$

we obtain

$$\mathbf{X}_c = c_1 \begin{pmatrix} 1 \\ -1 \end{pmatrix} e^t + c_2 \left[ \begin{pmatrix} 1 \\ -1 \end{pmatrix} te^t + \begin{pmatrix} 0 \\ 1/2 \end{pmatrix} e^t \right].$$

Then

$$\Phi = \begin{pmatrix} e^t & te^t \\ -e^t & \frac{1}{2}e^t - te^t \end{pmatrix} \quad \text{and} \quad \Phi^{-1} = \begin{pmatrix} e^{-t} - 2te^{-t} & -2te^{-t} \\ 2e^{-t} & 2e^{-t} \end{pmatrix}$$

so that

$$\mathbf{U} = \int \Phi^{-1} \mathbf{F} dt = \int \begin{pmatrix} 2e^{-2t} - 6te^{-2t} \\ 6e^{-2t} \end{pmatrix} dt = \begin{pmatrix} \frac{1}{2}e^{-2t} + 3te^{-2t} \\ -3e^{-2t} \end{pmatrix}$$

and

$$\mathbf{X}_p = \Phi \mathbf{U} = \begin{pmatrix} 1/2 \\ -2 \end{pmatrix} e^{-t}.$$

10. From

$$\mathbf{X}' = \begin{pmatrix} 3 & 2 \\ -2 & -1 \end{pmatrix} \mathbf{X} + \begin{pmatrix} 1 \\ 1 \end{pmatrix}$$

we obtain

$$\mathbf{X}_c = c_1 \begin{pmatrix} 1 \\ -1 \end{pmatrix} e^t + c_2 \left[ \begin{pmatrix} 1 \\ -1 \end{pmatrix} te^t + \begin{pmatrix} 0 \\ 1/2 \end{pmatrix} e^t \right].$$

Then

$$\Phi = \begin{pmatrix} e^t & te^t \\ -e^t & \frac{1}{2}e^t - te^t \end{pmatrix} \quad \text{and} \quad \Phi^{-1} = \begin{pmatrix} e^{-t} - 2te^{-t} & -2te^{-t} \\ 2e^{-t} & 2e^{-t} \end{pmatrix}$$

so that

$$\mathbf{U} = \int \Phi^{-1} \mathbf{F} dt = \int \begin{pmatrix} e^{-t} - 4te^{-t} \\ 2e^{-t} \end{pmatrix} dt = \begin{pmatrix} 3e^{-t} + 4te^{-t} \\ -2e^{-t} \end{pmatrix}$$

### Exercises 8.3

and

$$\mathbf{X}_p = \Phi \mathbf{U} = \begin{pmatrix} 3 \\ -5 \end{pmatrix}.$$

11. From

$$\mathbf{X}' = \begin{pmatrix} 0 & -1 \\ 1 & 0 \end{pmatrix} \mathbf{X} + \begin{pmatrix} \sec t \\ 0 \end{pmatrix}$$

we obtain

$$\mathbf{X}_c = c_1 \begin{pmatrix} \cos t \\ \sin t \end{pmatrix} + c_2 \begin{pmatrix} \sin t \\ -\cos t \end{pmatrix}.$$

Then

$$\Phi = \begin{pmatrix} \cos t & \sin t \\ \sin t & -\cos t \end{pmatrix} \quad \text{and} \quad \Phi^{-1} = \begin{pmatrix} \cos t & \sin t \\ \sin t & -\cos t \end{pmatrix}$$

so that

$$\mathbf{U} = \int \Phi^{-1} \mathbf{F} dt = \int \begin{pmatrix} 1 \\ \tan t \end{pmatrix} dt = \begin{pmatrix} t \\ \ln |\sec t| \end{pmatrix}$$

and

$$\mathbf{X}_p = \Phi \mathbf{U} = \begin{pmatrix} t \cos t + \sin t \ln |\sec t| \\ t \sin t - \cos t \ln |\sec t| \end{pmatrix}.$$

12. From

$$\mathbf{X}' = \begin{pmatrix} 1 & -1 \\ 1 & 1 \end{pmatrix} \mathbf{X} + \begin{pmatrix} 3 \\ 3 \end{pmatrix} e^t$$

we obtain

$$\mathbf{X}_c = c_1 \begin{pmatrix} -\sin t \\ \cos t \end{pmatrix} e^t + c_2 \begin{pmatrix} \cos t \\ \sin t \end{pmatrix} e^t.$$

Then

$$\Phi = \begin{pmatrix} -\sin t & \cos t \\ \cos t & \sin t \end{pmatrix} e^t \quad \text{and} \quad \Phi^{-1} = \begin{pmatrix} -\sin t & \cos t \\ \cos t & \sin t \end{pmatrix} e^{-t}$$

so that

$$\mathbf{U} = \int \Phi^{-1} \mathbf{F} dt = \int \begin{pmatrix} -3 \sin t + 3 \cos t \\ 3 \cos t + 3 \sin t \end{pmatrix} dt = \begin{pmatrix} 3 \cos t + 3 \sin t \\ 3 \sin t - 3 \cos t \end{pmatrix}$$

and

$$\mathbf{X}_p = \Phi \mathbf{U} = \begin{pmatrix} -3 \\ 3 \end{pmatrix} e^t.$$

13. From

$$\mathbf{X}' = \begin{pmatrix} 1 & -1 \\ 1 & 1 \end{pmatrix} \mathbf{X} + \begin{pmatrix} \cos t \\ \sin t \end{pmatrix} e^t$$

we obtain

$$\mathbf{X}_c = c_1 \begin{pmatrix} -\sin t \\ \cos t \end{pmatrix} e^t + c_2 \begin{pmatrix} \cos t \\ \sin t \end{pmatrix} e^t.$$



Then

$$\Phi = \begin{pmatrix} -\sin t & \cos t \\ \cos t & \sin t \end{pmatrix} e^t \quad \text{and} \quad \Phi^{-1} = \begin{pmatrix} -\sin t & \cos t \\ \cos t & \sin t \end{pmatrix} e^{-t}$$

so that

$$\mathbf{U} = \int \Phi^{-1} \mathbf{F} dt = \int \begin{pmatrix} 0 \\ 1 \end{pmatrix} dt = \begin{pmatrix} 0 \\ t \end{pmatrix}$$

and

$$\mathbf{X}_p = \Phi \mathbf{U} = \begin{pmatrix} \cos t \\ \sin t \end{pmatrix} t e^t.$$

14. From

$$\mathbf{X}' = \begin{pmatrix} 2 & -2 \\ 8 & -6 \end{pmatrix} \mathbf{X} + \begin{pmatrix} 1 \\ 3 \end{pmatrix} \frac{1}{t} e^{-2t}$$

we obtain

$$\mathbf{X}_c = c_1 \begin{pmatrix} 1 \\ 2 \end{pmatrix} e^{-2t} + c_2 \left[ \begin{pmatrix} 1 \\ 2 \end{pmatrix} t e^{-2t} + \begin{pmatrix} 1/2 \\ 1/2 \end{pmatrix} e^{-2t} \right].$$

Then

$$\Phi = \begin{pmatrix} 1 & 2t+1 \\ 2 & 4t+1 \end{pmatrix} e^{-2t} \quad \text{and} \quad \Phi^{-1} = \begin{pmatrix} -(4t+1) & 2t+1 \\ 2 & -1 \end{pmatrix} e^{2t}$$

so that

$$\mathbf{U} = \int \Phi^{-1} \mathbf{F} dt = \int \begin{pmatrix} 2t+2\ln t \\ -\ln t \end{pmatrix} dt$$

and

$$\mathbf{X}_p = \Phi \mathbf{U} = \begin{pmatrix} 2t + \ln t - 2t \ln t \\ 4t + 3 \ln t - 4t \ln t \end{pmatrix} e^{-2t}.$$

15. From

$$\mathbf{X}' = \begin{pmatrix} 0 & 1 \\ -1 & 0 \end{pmatrix} \mathbf{X} + \begin{pmatrix} 0 \\ \sec t \tan t \end{pmatrix}$$

we obtain

$$\mathbf{X}_c = c_1 \begin{pmatrix} \cos t \\ -\sin t \end{pmatrix} + c_2 \begin{pmatrix} \sin t \\ \cos t \end{pmatrix}.$$

Then

$$\Phi = \begin{pmatrix} \cos t & \sin t \\ -\sin t & \cos t \end{pmatrix} t \quad \text{and} \quad \Phi^{-1} = \begin{pmatrix} \cos t & -\sin t \\ \sin t & \cos t \end{pmatrix}$$

so that

$$\mathbf{U} = \int \Phi^{-1} \mathbf{F} dt = \int \begin{pmatrix} -\tan^2 t \\ \tan t \end{pmatrix} dt = \begin{pmatrix} t - \tan t \\ \ln |\sec t| \end{pmatrix}$$

and

$$\mathbf{X}_p = \Phi \mathbf{U} = \begin{pmatrix} \cos t \\ -\sin t \end{pmatrix} t + \begin{pmatrix} -\sin t \\ \sin t \tan t \end{pmatrix} + \begin{pmatrix} \sin t \\ \cos t \end{pmatrix} \ln |\sec t|.$$

### Exercises 8.3

16. From

$$\mathbf{X}' = \begin{pmatrix} 0 & 1 \\ -1 & 0 \end{pmatrix} \mathbf{X} + \begin{pmatrix} 1 \\ \cot t \end{pmatrix}$$

we obtain

$$\mathbf{X}_c = c_1 \begin{pmatrix} \cos t \\ -\sin t \end{pmatrix} + c_2 \begin{pmatrix} \sin t \\ \cos t \end{pmatrix}.$$

Then

$$\Phi = \begin{pmatrix} \cos t & \sin t \\ -\sin t & \cos t \end{pmatrix} \quad \text{and} \quad \Phi^{-1} = \begin{pmatrix} \cos t & -\sin t \\ \sin t & \cos t \end{pmatrix}$$

so that

$$\mathbf{U} = \int \Phi^{-1} \mathbf{F} dt = \int \begin{pmatrix} 0 \\ \csc t \end{pmatrix} dt = \begin{pmatrix} 0 \\ \ln |\csc t - \cot t| \end{pmatrix}$$

and

$$\mathbf{X}_p = \Phi \mathbf{U} = \begin{pmatrix} \sin t \ln |\csc t - \cot t| \\ \cos t \ln |\csc t - \cot t| \end{pmatrix}.$$

17. From

$$\mathbf{X}' = \begin{pmatrix} 1 & 2 \\ -1/2 & 1 \end{pmatrix} \mathbf{X} + \begin{pmatrix} \csc t \\ \sec t \end{pmatrix} e^t$$

we obtain

$$\mathbf{X}_c = c_1 \begin{pmatrix} 2 \sin t \\ \cos t \end{pmatrix} e^t + c_2 \begin{pmatrix} 2 \cos t \\ -\sin t \end{pmatrix} e^t.$$

Then

$$\Phi = \begin{pmatrix} 2 \sin t & 2 \cos t \\ \cos t & -\sin t \end{pmatrix} e^t \quad \text{and} \quad \Phi^{-1} = \begin{pmatrix} \frac{1}{2} \sin t & \cos t \\ \frac{1}{2} \cos t & -\sin t \end{pmatrix} e^{-t}$$

so that

$$\mathbf{U} = \int \Phi^{-1} \mathbf{F} dt = \int \begin{pmatrix} \frac{3}{2} \\ \frac{1}{2} \cos t - \tan t \end{pmatrix} dt = \begin{pmatrix} \frac{3}{2} t \\ \frac{1}{2} \ln |\sin t| - \ln |\sec t| \end{pmatrix}$$

and

$$\mathbf{X}_p = \Phi \mathbf{U} = \begin{pmatrix} 3 \sin t \\ \frac{3}{2} \cos t \end{pmatrix} t e^t + \begin{pmatrix} \cos t \\ -\frac{1}{2} \sin t \end{pmatrix} \ln |\sin t| + \begin{pmatrix} -2 \cos t \\ \sin t \end{pmatrix} \ln |\sec t|.$$

18. From

$$\mathbf{X}' = \begin{pmatrix} 1 & -2 \\ 1 & -1 \end{pmatrix} \mathbf{X} + \begin{pmatrix} \tan t \\ 1 \end{pmatrix}$$

we obtain

$$\mathbf{X}_c = c_1 \begin{pmatrix} \cos t - \sin t \\ \cos t \end{pmatrix} + c_2 \begin{pmatrix} \cos t + \sin t \\ \sin t \end{pmatrix}.$$

Then

$$\Phi = \begin{pmatrix} \cos t - \sin t & \cos t + \sin t \\ \cos t & \sin t \end{pmatrix} \quad \text{and} \quad \Phi^{-1} = \begin{pmatrix} -\sin t & \cos t + \sin t \\ \cos t & \sin t - \cos t \end{pmatrix}$$

so that

$$\mathbf{U} = \int \Phi^{-1} \mathbf{F} dt = \int \begin{pmatrix} 2 \cos t + \sin t - \sec t \\ 2 \sin t - \cos t \end{pmatrix} dt = \begin{pmatrix} 2 \sin t - \cos t - \ln |\sec t + \tan t| \\ -2 \cos t - \sin t \end{pmatrix}$$

and

$$\mathbf{X}_p = \Phi \mathbf{U} = \begin{pmatrix} 3 \sin t \cos t - \cos^2 t - 2 \sin^2 t + (\sin t - \cos t) \ln |\sec t + \tan t| \\ \sin^2 t - \cos^2 t - \cos t (\ln |\sec t + \tan t|) \end{pmatrix}.$$

19. From

$$\mathbf{X}' = \begin{pmatrix} 1 & 1 & 0 \\ 1 & 1 & 0 \\ 0 & 0 & 3 \end{pmatrix} \mathbf{X} + \begin{pmatrix} e^t \\ e^{2t} \\ te^{3t} \end{pmatrix}$$

we obtain

$$\mathbf{X}_c = c_1 \begin{pmatrix} 1 \\ -1 \\ 0 \end{pmatrix} + c_2 \begin{pmatrix} 1 \\ 1 \\ 0 \end{pmatrix} e^{2t} + c_3 \begin{pmatrix} 0 \\ 0 \\ 1 \end{pmatrix} e^{3t}.$$

Then

$$\Phi = \begin{pmatrix} 1 & e^{2t} & 0 \\ -1 & e^{2t} & 0 \\ 0 & 0 & e^{3t} \end{pmatrix} \quad \text{and} \quad \Phi^{-1} = \begin{pmatrix} \frac{1}{2} & -\frac{1}{2} & 0 \\ \frac{1}{2}e^{-2t} & \frac{1}{2}e^{-2t} & 0 \\ 0 & 0 & e^{-3t} \end{pmatrix}$$

so that

$$\mathbf{U} = \int \Phi^{-1} \mathbf{F} dt = \int \begin{pmatrix} \frac{1}{2}e^t - \frac{1}{2}e^{2t} \\ \frac{1}{2}e^{-t} + \frac{1}{2} \\ t \end{pmatrix} dt = \begin{pmatrix} \frac{1}{2}e^t - \frac{1}{4}e^{2t} \\ -\frac{1}{2}e^{-t} + \frac{1}{2}t \\ \frac{1}{2}t^2 \end{pmatrix}$$

and

$$\mathbf{X}_p = \Phi \mathbf{U} = \begin{pmatrix} -\frac{1}{4}e^{2t} + \frac{1}{2}te^{2t} \\ -e^t + \frac{1}{4}e^{2t} + \frac{1}{2}te^{2t} \\ \frac{1}{2}t^2e^{3t} \end{pmatrix}.$$

20. From

$$\mathbf{X}' = \begin{pmatrix} 3 & -1 & -1 \\ 1 & 1 & -1 \\ 1 & -1 & 1 \end{pmatrix} \mathbf{X} + \begin{pmatrix} 0 \\ t \\ 2e^t \end{pmatrix}$$

we obtain

$$\mathbf{X}_c = c_1 \begin{pmatrix} 1 \\ 1 \\ 1 \end{pmatrix} e^t + c_2 \begin{pmatrix} 1 \\ 1 \\ 0 \end{pmatrix} e^{2t} + c_3 \begin{pmatrix} 1 \\ 0 \\ 1 \end{pmatrix} e^{2t}.$$

Then

$$\Phi = \begin{pmatrix} e^t & e^{2t} & e^{2t} \\ e^t & e^{2t} & 0 \\ e^t & 0 & e^{2t} \end{pmatrix} \quad \text{and} \quad \Phi^{-1} = \begin{pmatrix} -e^{-t} & e^{-t} & e^{-t} \\ e^{-2t} & 0 & -e^{-2t} \\ e^{-2t} & -e^{-2t} & 0 \end{pmatrix}$$

### Exercises 8.3

so that

$$\mathbf{U} = \int \Phi^{-1} \mathbf{F} dt = \int \begin{pmatrix} te^{-t} + 2 \\ -2e^{-t} \\ -te^{-2t} \end{pmatrix} dt = \begin{pmatrix} -te^{-t} - e^{-t} + 2t \\ 2e^{-t} \\ \frac{1}{2}te^{-2t} + \frac{1}{4}e^{-2t} \end{pmatrix}$$

and

$$\mathbf{X}_p = \Phi \mathbf{U} = \begin{pmatrix} -1/2 \\ -1 \\ -1/2 \end{pmatrix} t + \begin{pmatrix} -3/4 \\ -1 \\ -3/4 \end{pmatrix} + \begin{pmatrix} 2 \\ 2 \\ 0 \end{pmatrix} e^t + \begin{pmatrix} 2 \\ 2 \\ 2 \end{pmatrix} te^t.$$

21. From

$$\mathbf{X}' = \begin{pmatrix} 3 & -1 \\ -1 & 3 \end{pmatrix} \mathbf{X} + \begin{pmatrix} 4e^{2t} \\ 4e^{4t} \end{pmatrix}$$

we obtain

$$\Phi = \begin{pmatrix} -e^{4t} & e^{2t} \\ e^{4t} & e^{2t} \end{pmatrix}, \quad \Phi^{-1} = \begin{pmatrix} -\frac{1}{2}e^{-4t} & \frac{1}{2}e^{-4t} \\ \frac{1}{2}e^{-2t} & \frac{1}{2}e^{-2t} \end{pmatrix},$$

and

$$\begin{aligned} \mathbf{X} &= \Phi \Phi^{-1}(0) \mathbf{X}(0) + \Phi \int_0^t \Phi^{-1} \mathbf{F} ds = \Phi \cdot \begin{pmatrix} 0 \\ 1 \end{pmatrix} + \Phi \cdot \begin{pmatrix} e^{-2t} + 2t - 1 \\ e^{2t} + 2t - 1 \end{pmatrix} \\ &= \begin{pmatrix} 2 \\ 2 \end{pmatrix} te^{2t} + \begin{pmatrix} -1 \\ 1 \end{pmatrix} e^{2t} + \begin{pmatrix} -2 \\ 2 \end{pmatrix} te^{4t} + \begin{pmatrix} 2 \\ 0 \end{pmatrix} e^{4t}. \end{aligned}$$

22. From

$$\mathbf{X}' = \begin{pmatrix} 1 & -1 \\ 1 & -1 \end{pmatrix} \mathbf{X} + \begin{pmatrix} 1/t \\ 1/t \end{pmatrix}$$

we obtain

$$\Phi = \begin{pmatrix} 1 & 1+t \\ 1 & t \end{pmatrix}, \quad \Phi^{-1} = \begin{pmatrix} -t & 1+t \\ 1 & -1 \end{pmatrix},$$

and

$$\mathbf{X} = \Phi \Phi^{-1}(1) \mathbf{X}(1) + \Phi \int_1^t \Phi^{-1} \mathbf{F} ds = \Phi \cdot \begin{pmatrix} -4 \\ 3 \end{pmatrix} + \Phi \cdot \begin{pmatrix} \ln t \\ 0 \end{pmatrix} = \begin{pmatrix} 3 \\ 3 \end{pmatrix} t - \begin{pmatrix} 1 \\ 4 \end{pmatrix} + \begin{pmatrix} 1 \\ 1 \end{pmatrix} \ln t.$$

23. Solving

$$\begin{vmatrix} 2 - \lambda & 3 \\ -1 & -2 - \lambda \end{vmatrix} = \lambda^2 - 1 = (\lambda - 1)(\lambda + 1) = 0$$

we obtain eigenvalues  $\lambda_1 = -1$  and  $\lambda_2 = 1$ . Corresponding eigenvectors are

$$\mathbf{K}_1 = \begin{pmatrix} -1 \\ 1 \end{pmatrix} \quad \text{and} \quad \mathbf{K}_2 = \begin{pmatrix} -3 \\ 1 \end{pmatrix}.$$

Thus

$$\mathbf{X}_c = c_1 \begin{pmatrix} -1 \\ 1 \end{pmatrix} e^{-t} + c_2 \begin{pmatrix} -3 \\ 1 \end{pmatrix} e^t.$$

Substituting

$$\mathbf{X}_p = \begin{pmatrix} a_1 \\ b_1 \end{pmatrix}$$

into the system yields

$$\begin{aligned} 2a_1 + 3b_1 &= 7 \\ -a_1 - 2b_1 &= -5, \end{aligned}$$

from which we obtain  $a_1 = -1$  and  $b_1 = 3$ . Then

$$\mathbf{X}(t) = c_1 \begin{pmatrix} -1 \\ 1 \end{pmatrix} e^{-t} + c_2 \begin{pmatrix} -3 \\ 1 \end{pmatrix} e^t + \begin{pmatrix} -1 \\ 3 \end{pmatrix}.$$

24. Solving

$$\begin{vmatrix} 6 - \lambda & 1 \\ 4 & 3 - \lambda \end{vmatrix} = \lambda^2 - 9\lambda + 14 = (\lambda - 2)(\lambda - 7) = 0$$

we obtain the eigenvalues  $\lambda_1 = 2$  and  $\lambda_2 = 7$ . Corresponding eigenvectors are

$$\mathbf{K}_1 = \begin{pmatrix} 1 \\ -4 \end{pmatrix} \quad \text{and} \quad \mathbf{K}_2 = \begin{pmatrix} 1 \\ 1 \end{pmatrix}.$$

Thus

$$\mathbf{X}_c = c_1 \begin{pmatrix} 1 \\ -4 \end{pmatrix} e^{2t} + c_2 \begin{pmatrix} 1 \\ 1 \end{pmatrix} e^{7t}.$$

Substituting

$$\mathbf{X}_p = \begin{pmatrix} a_2 \\ b_2 \end{pmatrix} t + \begin{pmatrix} a_1 \\ b_1 \end{pmatrix}$$

into the system yields

$$\begin{aligned} 6a_2 + b_2 + 6 &= 0 \\ 4a_2 + 3b_2 - 10 &= 0 \\ 6a_1 + b_1 - a_2 &= 0 \\ 4a_1 + 3b_1 - b_2 + 4 &= 0. \end{aligned}$$

Solving the first two equations simultaneously yields  $a_2 = -2$  and  $b_2 = 6$ . Substituting these two values into the second pair of equations and solving for  $a_1$  and  $b_1$  give  $a_1 = -\frac{4}{7}$  and  $b_1 = \frac{10}{7}$ . Then

$$\mathbf{X}(t) = c_1 \begin{pmatrix} 1 \\ -4 \end{pmatrix} e^{2t} + c_2 \begin{pmatrix} 1 \\ 1 \end{pmatrix} e^{7t} + \begin{pmatrix} -2 \\ 6 \end{pmatrix} t + \begin{pmatrix} -\frac{4}{7} \\ \frac{10}{7} \end{pmatrix}.$$

25. Solving

$$\begin{vmatrix} 4 - \lambda & 1/3 \\ 9 & 6 - \lambda \end{vmatrix} = \lambda^2 - 10\lambda + 21 = (\lambda - 3)(\lambda - 7) = 0$$

### Exercises 8.3

we obtain the eigenvalues  $\lambda_1 = 3$  and  $\lambda_2 = 7$ . Corresponding eigenvectors are

$$\mathbf{K}_1 = \begin{pmatrix} 1 \\ -3 \end{pmatrix} \quad \text{and} \quad \mathbf{K}_2 = \begin{pmatrix} 1 \\ 9 \end{pmatrix}.$$

Thus

$$\mathbf{X}_c = c_1 \begin{pmatrix} 1 \\ -3 \end{pmatrix} e^{3t} + c_2 \begin{pmatrix} 1 \\ 9 \end{pmatrix} e^{7t}.$$

Substituting

$$\mathbf{X}_p = \begin{pmatrix} a_1 \\ b_1 \end{pmatrix} e^t$$

into the system yields

$$3a_1 + \frac{1}{3}b_1 = 3$$

$$9a_1 + 5b_1 = -10$$

from which we obtain  $a_1 = 55/36$  and  $b_1 = -19/4$ . Then

$$\mathbf{X}(t) = c_1 \begin{pmatrix} 1 \\ -3 \end{pmatrix} e^{3t} + c_2 \begin{pmatrix} 1 \\ 9 \end{pmatrix} e^{7t} + \begin{pmatrix} 55/36 \\ -19/4 \end{pmatrix} e^t.$$

### 26. Solving

$$\begin{vmatrix} -1 - \lambda & 5 \\ -1 & 1 - \lambda \end{vmatrix} = \lambda^2 + 4 = 0$$

we obtain the eigenvalues  $\lambda_1 = 2i$  and  $\lambda_2 = -2i$ . Corresponding eigenvectors are

$$\mathbf{K}_1 = \begin{pmatrix} 5 \\ 1 + 2i \end{pmatrix} \quad \text{and} \quad \mathbf{K}_2 = \begin{pmatrix} 5 \\ 1 - 2i \end{pmatrix}.$$

Thus

$$\mathbf{X}_c = c_1 \begin{pmatrix} 5 \cos 2t \\ \cos 2t - 2 \sin 2t \end{pmatrix} + c_2 \begin{pmatrix} 5 \sin 2t \\ 2 \cos 2t + \sin 2t \end{pmatrix}.$$

Substituting

$$\mathbf{X}_p = \begin{pmatrix} a_2 \\ b_2 \end{pmatrix} \cos t + \begin{pmatrix} a_1 \\ b_1 \end{pmatrix} \sin t$$

into the system yields

$$-a_2 + 5b_2 - a_1 = 0$$

$$-a_2 + b_2 - b_1 - 2 = 0$$

$$-a_1 + 5b_1 + a_2 + 1 = 0$$

$$-a_1 + b_1 + b_2 = 0$$

from which we obtain  $a_2 = -3$ ,  $b_2 = -2/3$ ,  $a_1 = -1/3$ , and  $b_1 = 1/3$ . Then

$$\mathbf{X}(t) = c_1 \begin{pmatrix} 5 \cos 2t \\ \cos 2t - 2 \sin 2t \end{pmatrix} + c_2 \begin{pmatrix} 5 \sin 2t \\ 2 \cos 2t + \sin 2t \end{pmatrix} + \begin{pmatrix} -3 \\ -2/3 \end{pmatrix} \cos t + \begin{pmatrix} -1/3 \\ 1/3 \end{pmatrix} \sin t.$$

27. Let  $\mathbf{I} = \begin{pmatrix} i_1 \\ i_2 \end{pmatrix}$  so that

$$\mathbf{I}' = \begin{pmatrix} -11 & 3 \\ 3 & -3 \end{pmatrix} \mathbf{I} + \begin{pmatrix} 100 \sin t \\ 0 \end{pmatrix}$$

and

$$\mathbf{X}_c = c_1 \begin{pmatrix} 1 \\ 3 \end{pmatrix} e^{-2t} + c_2 \begin{pmatrix} 3 \\ -1 \end{pmatrix} e^{-12t}.$$

Then

$$\Phi = \begin{pmatrix} e^{-2t} & 3e^{-12t} \\ 3e^{-2t} & -e^{-12t} \end{pmatrix}, \quad \Phi^{-1} = \begin{pmatrix} \frac{1}{10}e^{2t} & \frac{3}{10}e^{2t} \\ \frac{3}{10}e^{12t} & -\frac{1}{10}e^{12t} \end{pmatrix},$$

$$\mathbf{U} = \int \Phi^{-1} \mathbf{F} dt = \int \begin{pmatrix} 10e^{2t} \sin t \\ 30e^{12t} \sin t \end{pmatrix} dt = \begin{pmatrix} 2e^{2t}(2 \sin t - \cos t) \\ \frac{6}{29}e^{12t}(12 \sin t - \cos t) \end{pmatrix},$$

and

$$\mathbf{I}_p = \Phi \mathbf{U} = \begin{pmatrix} \frac{332}{29} \sin t - \frac{76}{29} \cos t \\ \frac{276}{29} \sin t - \frac{168}{29} \cos t \end{pmatrix}$$

so that

$$\mathbf{I} = c_1 \begin{pmatrix} 1 \\ 3 \end{pmatrix} e^{-2t} + c_2 \begin{pmatrix} 3 \\ -1 \end{pmatrix} e^{-12t} + \mathbf{I}_p.$$

If  $\mathbf{I}(0) = \begin{pmatrix} 0 \\ 0 \end{pmatrix}$  then  $c_1 = 2$  and  $c_2 = \frac{6}{29}$ .

28. (a) Solving

$$\begin{vmatrix} 1 - \lambda & -1 \\ -1 & 1 - \lambda \end{vmatrix} = \lambda^2 - 2\lambda = \lambda(\lambda - 2) = 0$$

we obtain the eigenvalues  $\lambda_1 = 0$  and  $\lambda_2 = 2$ . Corresponding eigenvectors are

$$\mathbf{K}_1 = \begin{bmatrix} 1 \\ 1 \end{bmatrix} \quad \text{and} \quad \mathbf{K}_2 = \begin{bmatrix} -1 \\ 1 \end{bmatrix}.$$

Thus

$$\mathbf{X}_c = c_1 \begin{bmatrix} 1 \\ 1 \end{bmatrix} + c_2 \begin{bmatrix} -1 \\ 1 \end{bmatrix} e^{2t}.$$

If we substitute

$$\mathbf{X}_p = \begin{bmatrix} a_1 \\ b_1 \end{bmatrix}$$

### Exercises 8.3

into the system, we get

$$\begin{bmatrix} 0 \\ 0 \end{bmatrix} = \begin{bmatrix} 1 & -1 \\ -1 & 1 \end{bmatrix} \begin{bmatrix} a_1 \\ b_1 \end{bmatrix} + \begin{bmatrix} 3 \\ -5 \end{bmatrix} = \begin{bmatrix} a_1 - b_1 + 3 \\ -a_1 + b_1 - 5 \end{bmatrix},$$

which cannot be solved for  $a_1$  and  $b_1$ . The difference in the systems is that in Problem 23 the homogeneous system does not have a constant solution, whereas in this problem it does.

(b) Trying a solution of the form

$$\mathbf{X}_p = \begin{bmatrix} a_1 \\ b_1 \end{bmatrix} t$$

fails, so we instead try

$$\mathbf{X}_p = \begin{bmatrix} a_2 \\ b_2 \end{bmatrix} t + \begin{bmatrix} a_1 \\ b_1 \end{bmatrix}.$$

Substituting into the system, we obtain

$$(a_1 - b_1 + 3) + (a_2 - b_2)t = a_2$$

$$(-a_1 + b_1 - 5) + (-a_2 + b_2)t = b_2$$

and note that  $a_2 = b_2$ . Adding the equations, we find  $-2 = a_2 + b_2 = 2a_2$ , so  $a_2 = -1$  and hence  $b_2 = -1$ . From the first equation, we have  $a_1 - b_1 + 3 = -1$ , and from the second equation, we have  $-a_1 + b_1 - 5 = -1$ . These are both equivalent to  $a_1 - b_1 = -4$ , so we take  $a_1 = 0$  and  $b_1 = 4$ . Thus

$$\mathbf{X}_p(t) = \begin{bmatrix} -1 \\ -1 \end{bmatrix} t + \begin{bmatrix} 0 \\ 4 \end{bmatrix}.$$

29. (a) The eigenvalues are 0, 1, 3, and 4, with corresponding eigenvectors

$$\begin{pmatrix} -6 \\ -4 \\ 1 \\ 2 \end{pmatrix}, \quad \begin{pmatrix} 2 \\ 1 \\ 0 \\ 0 \end{pmatrix}, \quad \begin{pmatrix} 3 \\ 1 \\ 2 \\ 1 \end{pmatrix}, \quad \text{and} \quad \begin{pmatrix} -1 \\ 1 \\ 0 \\ 0 \end{pmatrix}.$$

$$(b) \quad \Phi = \begin{pmatrix} -6 & 2e^t & 3e^{3t} & -e^{4t} \\ -4 & e^t & e^{3t} & e^{4t} \\ 1 & 0 & 2e^{3t} & 0 \\ 2 & 0 & e^{3t} & 0 \end{pmatrix}, \quad \Phi^{-1} = \begin{pmatrix} 0 & 0 & -\frac{1}{3} & \frac{2}{3} \\ \frac{1}{3}e^{-t} & \frac{1}{3}e^{-t} & -2e^{-t} & \frac{8}{3}e^{-t} \\ 0 & 0 & \frac{2}{3}e^{-3t} & -\frac{1}{3}e^{-3t} \\ -\frac{1}{3}e^{-4t} & \frac{2}{3}e^{-4t} & 0 & \frac{1}{3}e^{-4t} \end{pmatrix}$$

$$(c) \quad \Phi^{-1}(t)\mathbf{F}(t) = \begin{pmatrix} \frac{2}{3} - \frac{1}{3}e^{2t} \\ \frac{1}{3}e^{-2t} + \frac{8}{3}e^{-t} - 2e^t + \frac{1}{3}t \\ -\frac{1}{3}e^{-3t} + \frac{2}{3}e^{-t} \\ \frac{2}{3}e^{-5t} + \frac{1}{3}e^{-4t} - \frac{1}{3}te^{-3t} \end{pmatrix},$$



$$\int \Phi^{-1}(t)F(t)dt = \begin{pmatrix} -\frac{1}{6}e^{2t} + \frac{2}{3}t \\ -\frac{1}{6}e^{-2t} - \frac{8}{3}e^{-t} - 2e^t + \frac{1}{6}t^2 \\ \frac{1}{9}e^{-3t} - \frac{2}{3}e^{-t} \\ -\frac{2}{15}e^{-5t} - \frac{1}{12}e^{-4t} + \frac{1}{27}e^{-3t} + \frac{1}{9}te^{-3t} \end{pmatrix},$$

$$\Phi(t) \int \Phi^{-1}(t)F(t)dt = \begin{pmatrix} -5e^{2t} - \frac{1}{5}e^{-t} - \frac{1}{27}e^t - \frac{1}{9}te^t + \frac{1}{3}t^2e^t - 4t - \frac{59}{12} \\ -2e^{2t} - \frac{3}{10}e^{-t} + \frac{1}{27}e^t + \frac{1}{9}te^t + \frac{1}{6}t^2e^t - \frac{8}{3}t - \frac{95}{36} \\ -\frac{3}{2}e^{2t} + \frac{2}{3}t + \frac{2}{9} \\ -e^{2t} + \frac{4}{3}t - \frac{1}{9} \end{pmatrix},$$

$$\Phi(t)C = \begin{pmatrix} -6c_1 + 2c_2e^t + 3c_3e^{3t} - c_4e^{4t} \\ -4c_1 + c_2e^t + c_3e^{3t} + c_4e^{4t} \\ c_1 + 2c_3e^{3t} \\ 2c_1 + c_3e^{3t} \end{pmatrix},$$

$$\Phi(t)C + \Phi(t) \int \Phi^{-1}(t)F(t)dt$$

$$= \begin{pmatrix} -6c_1 + 2c_2e^t + 3c_3e^{3t} - c_4e^{4t} \\ -4c_1 + c_2e^t + c_3e^{3t} + c_4e^{4t} \\ c_1 + 2c_3e^{3t} \\ 2c_1 + c_3e^{3t} \end{pmatrix} + \begin{pmatrix} -5e^{2t} - \frac{1}{5}e^{-t} - \frac{1}{27}e^t - \frac{1}{9}te^t + \frac{1}{3}t^2e^t - 4t - \frac{59}{12} \\ -2e^{2t} - \frac{3}{10}e^{-t} + \frac{1}{27}e^t + \frac{1}{9}te^t + \frac{1}{6}t^2e^t - \frac{8}{3}t - \frac{95}{36} \\ -\frac{3}{2}e^{2t} + \frac{2}{3}t + \frac{2}{9} \\ -e^{2t} + \frac{4}{3}t - \frac{1}{9} \end{pmatrix}$$

$$(d) \mathbf{X}(t) = c_1 \begin{pmatrix} -6 \\ -4 \\ 1 \\ 2 \end{pmatrix} + c_2 \begin{pmatrix} 2 \\ 1 \\ 0 \\ 0 \end{pmatrix} + c_3 \begin{pmatrix} 3 \\ 1 \\ 2 \\ 1 \end{pmatrix} + c_4 \begin{pmatrix} -1 \\ 1 \\ 0 \\ 0 \end{pmatrix}$$

$$+ \begin{pmatrix} -5e^{2t} - \frac{1}{5}e^{-t} - \frac{1}{27}e^t - \frac{1}{9}te^t + \frac{1}{3}t^2e^t - 4t - \frac{59}{12} \\ -2e^{2t} - \frac{3}{10}e^{-t} + \frac{1}{27}e^t + \frac{1}{9}te^t + \frac{1}{6}t^2e^t - \frac{8}{3}t - \frac{95}{36} \\ -\frac{3}{2}e^{2t} + \frac{2}{3}t + \frac{2}{9} \\ -e^{2t} + \frac{4}{3}t - \frac{1}{9} \end{pmatrix}$$

---

**Exercises 8.4**

---

1. For  $A = \begin{pmatrix} 1 & 0 \\ 0 & 2 \end{pmatrix}$  we have

$$A^2 = \begin{pmatrix} 1 & 0 \\ 0 & 2 \end{pmatrix} \begin{pmatrix} 1 & 0 \\ 0 & 2 \end{pmatrix} = \begin{pmatrix} 1 & 0 \\ 0 & 4 \end{pmatrix},$$

$$A^3 = AA^2 = \begin{pmatrix} 1 & 0 \\ 0 & 2 \end{pmatrix} \begin{pmatrix} 1 & 0 \\ 0 & 4 \end{pmatrix} = \begin{pmatrix} 1 & 0 \\ 0 & 8 \end{pmatrix},$$

$$A^4 = AA^3 = \begin{pmatrix} 1 & 0 \\ 0 & 2 \end{pmatrix} \begin{pmatrix} 1 & 0 \\ 0 & 8 \end{pmatrix} = \begin{pmatrix} 1 & 0 \\ 0 & 16 \end{pmatrix},$$

and so on. In general

$$A^k = \begin{pmatrix} 1 & 0 \\ 0 & 2^k \end{pmatrix} \quad \text{for } k = 1, 2, 3, \dots$$

Thus

$$\begin{aligned} e^{At} &= I + \frac{A}{1!}t + \frac{A^2}{2!}t^2 + \frac{A^3}{3!}t^3 + \dots \\ &= \begin{pmatrix} 1 & 0 \\ 0 & 1 \end{pmatrix} + \frac{1}{1!} \begin{pmatrix} 1 & 0 \\ 0 & 2 \end{pmatrix} t + \frac{1}{2!} \begin{pmatrix} 1 & 0 \\ 0 & 4 \end{pmatrix} t^2 + \frac{1}{3!} \begin{pmatrix} 1 & 0 \\ 0 & 8 \end{pmatrix} t^3 + \dots \\ &= \begin{pmatrix} 1+t+\frac{t^2}{2!}+\frac{t^3}{3!}+\dots & 0 \\ 0 & 1+t+\frac{(2t)^2}{2!}+\frac{(2t)^3}{3!}+\dots \end{pmatrix} = \begin{pmatrix} e^t & 0 \\ 0 & e^{2t} \end{pmatrix} \end{aligned}$$

and

$$e^{-At} = \begin{pmatrix} e^{-t} & 0 \\ 0 & e^{-2t} \end{pmatrix}.$$

2. For  $A = \begin{pmatrix} 0 & 1 \\ 1 & 0 \end{pmatrix}$  we have

$$A^2 = \begin{pmatrix} 0 & 1 \\ 1 & 0 \end{pmatrix} \begin{pmatrix} 0 & 1 \\ 1 & 0 \end{pmatrix} = \begin{pmatrix} 1 & 0 \\ 0 & 1 \end{pmatrix} = I$$

$$A^3 = AA^2 = \begin{pmatrix} 0 & 1 \\ 1 & 0 \end{pmatrix} I = \begin{pmatrix} 0 & 1 \\ 1 & 0 \end{pmatrix} = A$$

$$A^4 = (A^2)^2 = I$$

$$A^5 = AA^4 = AI = A$$

and so on. In general

$$\mathbf{A}^k = \begin{cases} \mathbf{A}, & k = 1, 3, 5, \dots \\ \mathbf{I}, & k = 2, 4, 6, \dots \end{cases}$$

Thus

$$\begin{aligned} e^{\mathbf{A}t} &= \mathbf{I} + \frac{\mathbf{A}}{1!}t + \frac{\mathbf{A}^2}{2!}t^2 + \frac{\mathbf{A}^3}{3!}t^3 + \dots \\ &= \mathbf{I} + \mathbf{A}t + \frac{1}{2!}\mathbf{I}t^2 + \frac{1}{3!}\mathbf{A}t^3 + \dots \\ &= \mathbf{I} \left( 1 + \frac{1}{2!}t^2 + \frac{1}{4!}t^4 + \dots \right) + \mathbf{A} \left( t + \frac{1}{3!}t^3 + \frac{1}{5!}t^5 + \dots \right) \\ &= \mathbf{I} \cosh t + \mathbf{A} \sinh t = \begin{pmatrix} \cosh t & \sinh t \\ \sinh t & \cosh t \end{pmatrix} \end{aligned}$$

and

$$e^{-\mathbf{A}t} = \begin{pmatrix} \cosh(-t) & \sinh(-t) \\ \sinh(-t) & \cosh(-t) \end{pmatrix} = \begin{pmatrix} \cosh t & -\sinh t \\ -\sinh t & \cosh t \end{pmatrix}.$$

3. For

$$\mathbf{A} = \begin{pmatrix} 1 & 1 & 1 \\ 1 & 1 & 1 \\ -2 & -2 & -2 \end{pmatrix}$$

we have

$$\mathbf{A}^2 = \begin{pmatrix} 1 & 1 & 1 \\ 1 & 1 & 1 \\ -2 & -2 & -2 \end{pmatrix} \begin{pmatrix} 1 & 1 & 1 \\ 1 & 1 & 1 \\ -2 & -2 & -2 \end{pmatrix} = \begin{pmatrix} 0 & 0 & 0 \\ 0 & 0 & 0 \\ 0 & 0 & 0 \end{pmatrix}.$$

Thus,  $\mathbf{A}^3 = \mathbf{A}^4 = \mathbf{A}^5 = \dots = \mathbf{0}$  and

$$e^{\mathbf{A}t} = \mathbf{I} + \mathbf{A}t = \begin{pmatrix} 1 & 0 & 0 \\ 0 & 1 & 0 \\ 0 & 0 & 1 \end{pmatrix} + \begin{pmatrix} t & t & t \\ t & t & t \\ -2t & -2t & -2t \end{pmatrix} = \begin{pmatrix} t+1 & t & t \\ t & t+1 & t \\ -2t & -2t & -2t+1 \end{pmatrix}.$$

4. For

$$\mathbf{A} = \begin{pmatrix} 0 & 0 & 0 \\ 3 & 0 & 0 \\ 5 & 1 & 0 \end{pmatrix}$$

we have

Exercises 8.4

$$\mathbf{A}^2 = \begin{pmatrix} 0 & 0 & 0 \\ 3 & 0 & 0 \\ 5 & 1 & 0 \end{pmatrix} \begin{pmatrix} 0 & 0 & 0 \\ 3 & 0 & 0 \\ 5 & 1 & 0 \end{pmatrix} = \begin{pmatrix} 0 & 0 & 0 \\ 0 & 0 & 0 \\ 3 & 0 & 0 \end{pmatrix}$$

$$\mathbf{A}^3 = \mathbf{A}\mathbf{A}^2 = \begin{pmatrix} 0 & 0 & 0 \\ 3 & 0 & 0 \\ 5 & 1 & 0 \end{pmatrix} \begin{pmatrix} 0 & 0 & 0 \\ 0 & 0 & 0 \\ 3 & 0 & 0 \end{pmatrix} = \begin{pmatrix} 0 & 0 & 0 \\ 0 & 0 & 0 \\ 0 & 0 & 0 \end{pmatrix}.$$

Thus,  $\mathbf{A}^4 = \mathbf{A}^5 = \mathbf{A}^6 = \dots = \mathbf{0}$  and

$$\begin{aligned} e^{\mathbf{A}t} &= \mathbf{I} + \mathbf{A}t + \frac{1}{2}\mathbf{A}^2t^2 \\ &= \begin{pmatrix} 1 & 0 & 0 \\ 0 & 1 & 0 \\ 0 & 0 & 1 \end{pmatrix} + \begin{pmatrix} 0 & 0 & 0 \\ 3t & 0 & 0 \\ 5t & t & 0 \end{pmatrix} + \begin{pmatrix} 0 & 0 & 0 \\ 0 & 0 & 0 \\ \frac{3}{2}t^2 & 0 & 0 \end{pmatrix} = \begin{pmatrix} 1 & 0 & 0 \\ 3t & 1 & 0 \\ \frac{3}{2}t^2 + 5t & t & 1 \end{pmatrix}. \end{aligned}$$

5. Using the result of Problem 1,

$$\mathbf{X} = \begin{pmatrix} e^t & 0 \\ 0 & e^{2t} \end{pmatrix} \begin{pmatrix} c_1 \\ c_2 \end{pmatrix} = c_1 \begin{pmatrix} e^t \\ 0 \end{pmatrix} + c_2 \begin{pmatrix} 0 \\ e^t \end{pmatrix}.$$

6. Using the result of Problem 2,

$$\mathbf{X} = \begin{pmatrix} \cosh t & \sinh t \\ \sinh t & \cosh t \end{pmatrix} \begin{pmatrix} c_1 \\ c_2 \end{pmatrix} = c_1 \begin{pmatrix} \cosh t \\ \sinh t \end{pmatrix} + c_2 \begin{pmatrix} \sinh t \\ \cosh t \end{pmatrix}.$$

7. Using the result of Problem 3,

$$\mathbf{X} = \begin{pmatrix} t+1 & t & t \\ t & t+1 & t \\ -2t & -2t & -2t+1 \end{pmatrix} \begin{pmatrix} c_1 \\ c_2 \\ c_3 \end{pmatrix} = c_1 \begin{pmatrix} t+1 \\ t \\ -2t \end{pmatrix} + c_2 \begin{pmatrix} t \\ t+1 \\ -2t \end{pmatrix} + c_3 \begin{pmatrix} t \\ t \\ -2t+1 \end{pmatrix}.$$

8. Using the result of Problem 4,

$$\mathbf{X} = \begin{pmatrix} 1 & 0 & 0 \\ 3t & 1 & 0 \\ \frac{3}{2}t^2 + 5t & t & 1 \end{pmatrix} \begin{pmatrix} c_1 \\ c_2 \\ c_3 \end{pmatrix} = c_1 \begin{pmatrix} 1 \\ 3t \\ \frac{3}{2}t^2 + 5t \end{pmatrix} + c_2 \begin{pmatrix} 0 \\ 1 \\ t \end{pmatrix} + c_3 \begin{pmatrix} 0 \\ 0 \\ 1 \end{pmatrix}.$$

9. To solve

$$\mathbf{X}' = \begin{pmatrix} 1 & 0 \\ 0 & 2 \end{pmatrix} \mathbf{X} + \begin{pmatrix} 3 \\ -1 \end{pmatrix}$$

Exercises 8.4

we identify  $t_0 = 0$ ,  $\mathbf{F}(s) = \begin{pmatrix} 3 \\ -1 \end{pmatrix}$ , and use the results of Problem 1 and equation (5) in the text.

$$\begin{aligned} \mathbf{X}(t) &= e^{At}\mathbf{C} + e^{At} \int_{t_0}^t e^{-As}\mathbf{F}(s) ds \\ &= \begin{pmatrix} e^t & 0 \\ 0 & e^{2t} \end{pmatrix} \begin{pmatrix} c_1 \\ c_2 \end{pmatrix} + \begin{pmatrix} e^t & 0 \\ 0 & e^{2t} \end{pmatrix} \int_0^t \begin{pmatrix} e^{-s} & 0 \\ 0 & e^{-2s} \end{pmatrix} \begin{pmatrix} 3 \\ -1 \end{pmatrix} ds \\ &= \begin{pmatrix} c_1 e^t \\ c_2 e^{2t} \end{pmatrix} + \begin{pmatrix} e^t & 0 \\ 0 & e^{2t} \end{pmatrix} \int_0^t \begin{pmatrix} 3e^{-s} \\ -e^{-2s} \end{pmatrix} ds \\ &= \begin{pmatrix} c_1 e^t \\ c_2 e^{2t} \end{pmatrix} + \begin{pmatrix} e^t & 0 \\ 0 & e^{2t} \end{pmatrix} \left. \begin{pmatrix} -3e^{-s} \\ \frac{1}{2}e^{-2s} \end{pmatrix} \right|_0^t \\ &= \begin{pmatrix} c_1 e^t \\ c_2 e^{2t} \end{pmatrix} + \begin{pmatrix} e^t & 0 \\ 0 & e^{2t} \end{pmatrix} \begin{pmatrix} -3e^{-t} - 3 \\ \frac{1}{2}e^{-2t} - \frac{1}{2} \end{pmatrix} \\ &= \begin{pmatrix} c_1 e^t \\ c_2 e^{2t} \end{pmatrix} + \begin{pmatrix} -3 - 3e^t \\ \frac{1}{2} - \frac{1}{2}e^{2t} \end{pmatrix} = c_3 \begin{pmatrix} 1 \\ 0 \end{pmatrix} e^t + c_4 \begin{pmatrix} 0 \\ 1 \end{pmatrix} e^{2t} + \begin{pmatrix} -3 \\ \frac{1}{2} \end{pmatrix}. \end{aligned}$$

10. To solve

$$\mathbf{X}' = \begin{pmatrix} 1 & 0 \\ 0 & 2 \end{pmatrix} \mathbf{X} + \begin{pmatrix} t \\ e^{4t} \end{pmatrix}$$

we identify  $t_0 = 0$ ,  $\mathbf{F}(s) = \begin{pmatrix} s \\ e^{4s} \end{pmatrix}$ , and use the results of Problem 1 and equation (5) in the text.

$$\begin{aligned} \mathbf{X}(t) &= e^{At}\mathbf{C} + e^{At} \int_{t_0}^t e^{-As}\mathbf{F}(s) ds \\ &= \begin{pmatrix} e^t & 0 \\ 0 & e^{2t} \end{pmatrix} \begin{pmatrix} c_1 \\ c_2 \end{pmatrix} + \begin{pmatrix} e^t & 0 \\ 0 & e^{2t} \end{pmatrix} \int_0^t \begin{pmatrix} e^{-s} & 0 \\ 0 & e^{-2s} \end{pmatrix} \begin{pmatrix} s \\ e^{4s} \end{pmatrix} ds \\ &= \begin{pmatrix} c_1 e^t \\ c_2 e^{2t} \end{pmatrix} + \begin{pmatrix} e^t & 0 \\ 0 & e^{2t} \end{pmatrix} \int_0^t \begin{pmatrix} se^{-s} \\ e^{2s} \end{pmatrix} ds \\ &= \begin{pmatrix} c_1 e^t \\ c_2 e^{2t} \end{pmatrix} + \begin{pmatrix} e^t & 0 \\ 0 & e^{2t} \end{pmatrix} \left. \begin{pmatrix} -se^{-s} - e^{-s} \\ \frac{1}{2}e^{2s} \end{pmatrix} \right|_0^t \\ &= \begin{pmatrix} c_1 e^t \\ c_2 e^{2t} \end{pmatrix} + \begin{pmatrix} e^t & 0 \\ 0 & e^{2t} \end{pmatrix} \begin{pmatrix} -te^{-t} - e^{-t} + 1 \\ \frac{1}{2}e^{2t} - \frac{1}{2} \end{pmatrix} \\ &= \begin{pmatrix} c_1 e^t \\ c_2 e^{2t} \end{pmatrix} + \begin{pmatrix} -t - 1 + e^t \\ \frac{1}{2}e^{4t} - \frac{1}{2}e^{2t} \end{pmatrix} = c_3 \begin{pmatrix} 1 \\ 0 \end{pmatrix} e^t + c_4 \begin{pmatrix} 0 \\ 1 \end{pmatrix} e^{2t} + \begin{pmatrix} -t - 1 \\ \frac{1}{2}e^{4t} \end{pmatrix}. \end{aligned}$$

### Exercises 8.4

11. To solve

$$\mathbf{X}' = \begin{pmatrix} 0 & 1 \\ 1 & 0 \end{pmatrix} \mathbf{X} + \begin{pmatrix} 1 \\ 1 \end{pmatrix}$$

we identify  $t_0 = 0$ ,  $\mathbf{F}(s) = \begin{pmatrix} 1 \\ 1 \end{pmatrix}$ , and use the results of Problem 2 and equation (5) in the text.

$$\begin{aligned} \mathbf{X}(t) &= e^{\mathbf{A}t} \mathbf{C} + e^{\mathbf{A}t} \int_{t_0}^t e^{-\mathbf{A}s} \mathbf{F}(s) ds \\ &= \begin{pmatrix} \cosh t & \sinh t \\ \sinh t & \cosh t \end{pmatrix} \begin{pmatrix} c_1 \\ c_2 \end{pmatrix} + \begin{pmatrix} \cosh t & \sinh t \\ \sinh t & \cosh t \end{pmatrix} \int_0^t \begin{pmatrix} \cosh s & -\sinh s \\ -\sinh s & \cosh s \end{pmatrix} \begin{pmatrix} 1 \\ 1 \end{pmatrix} ds \\ &= \begin{pmatrix} c_1 \cosh t + c_2 \sinh t \\ c_1 \sinh t + c_2 \cosh t \end{pmatrix} + \begin{pmatrix} \cosh t & \sinh t \\ \sinh t & \cosh t \end{pmatrix} \int_0^t \begin{pmatrix} \cosh s & -\sinh s \\ -\sinh s & \cosh s \end{pmatrix} ds \\ &= \begin{pmatrix} c_1 \cosh t + c_2 \sinh t \\ c_1 \sinh t + c_2 \cosh t \end{pmatrix} + \begin{pmatrix} \cosh t & \sinh t \\ \sinh t & \cosh t \end{pmatrix} \begin{pmatrix} \sinh s - \cosh s \\ -\cosh s + \sinh s \end{pmatrix} \Big|_0^t \\ &= \begin{pmatrix} c_1 \cosh t + c_2 \sinh t \\ c_1 \sinh t + c_2 \cosh t \end{pmatrix} + \begin{pmatrix} \cosh t & \sinh t \\ \sinh t & \cosh t \end{pmatrix} \begin{pmatrix} \sinh t - \cosh t \\ -\cosh t + \sinh t \end{pmatrix} \\ &= \begin{pmatrix} c_1 \cosh t + c_2 \sinh t \\ c_1 \sinh t + c_2 \cosh t \end{pmatrix} + \begin{pmatrix} \sinh^2 t - \cosh^2 t \\ \sinh^2 t - \cosh^2 t \end{pmatrix} = c_1 \begin{pmatrix} \cosh t \\ \sinh t \end{pmatrix} + c_2 \begin{pmatrix} \sinh t \\ \cosh t \end{pmatrix} - \begin{pmatrix} 1 \\ 1 \end{pmatrix}. \end{aligned}$$

12. To solve

$$\mathbf{X}' = \begin{pmatrix} 0 & 1 \\ 1 & 0 \end{pmatrix} \mathbf{X} + \begin{pmatrix} \cosh t \\ \sinh t \end{pmatrix}$$

we identify  $t_0 = 0$ ,  $\mathbf{F}(s) = \begin{pmatrix} \cosh s \\ \sinh s \end{pmatrix}$ , and use the results of Problem 2 and equation (5) in the text.

$$\begin{aligned} \mathbf{X}(t) &= e^{\mathbf{A}t} \mathbf{C} + e^{\mathbf{A}t} \int_{t_0}^t e^{-\mathbf{A}s} \mathbf{F}(s) ds \\ &= \begin{pmatrix} \cosh t & \sinh t \\ \sinh t & \cosh t \end{pmatrix} \begin{pmatrix} c_1 \\ c_2 \end{pmatrix} + \begin{pmatrix} \cosh t & \sinh t \\ \sinh t & \cosh t \end{pmatrix} \int_0^t \begin{pmatrix} \cosh s & -\sinh s \\ -\sinh s & \cosh s \end{pmatrix} \begin{pmatrix} \cosh s \\ \sinh s \end{pmatrix} ds \\ &= \begin{pmatrix} c_1 \cosh t + c_2 \sinh t \\ c_1 \sinh t + c_2 \cosh t \end{pmatrix} + \begin{pmatrix} \cosh t & \sinh t \\ \sinh t & \cosh t \end{pmatrix} \int_0^t \begin{pmatrix} 1 \\ 0 \end{pmatrix} ds \\ &= \begin{pmatrix} c_1 \cosh t + c_2 \sinh t \\ c_1 \sinh t + c_2 \cosh t \end{pmatrix} + \begin{pmatrix} \cosh t & \sinh t \\ \sinh t & \cosh t \end{pmatrix} \begin{pmatrix} s \\ 0 \end{pmatrix} \Big|_0^t \end{aligned}$$

$$\begin{aligned}
&= \begin{pmatrix} c_1 \cosh t + c_2 \sinh t \\ c_1 \sinh t + c_2 \cosh t \end{pmatrix} + \begin{pmatrix} \cosh t & \sinh t \\ \sinh t & \cosh t \end{pmatrix} \begin{pmatrix} t \\ 0 \end{pmatrix} \\
&= \begin{pmatrix} c_1 \cosh t + c_2 \sinh t \\ c_1 \sinh t + c_2 \cosh t \end{pmatrix} + \begin{pmatrix} t \cosh t \\ t \sinh t \end{pmatrix} = c_1 \begin{pmatrix} \cosh t \\ \sinh t \end{pmatrix} + c_2 \begin{pmatrix} \sinh t \\ \cosh t \end{pmatrix} + t \begin{pmatrix} \cosh t \\ \sinh t \end{pmatrix}.
\end{aligned}$$

13. We have

$$\mathbf{X}(0) = c_1 \begin{pmatrix} 1 \\ 0 \\ 0 \end{pmatrix} + c_2 \begin{pmatrix} 0 \\ 1 \\ 0 \end{pmatrix} + c_3 \begin{pmatrix} 0 \\ 0 \\ 1 \end{pmatrix} = \begin{pmatrix} c_1 \\ c_2 \\ c_3 \end{pmatrix} = \begin{pmatrix} 1 \\ -4 \\ 6 \end{pmatrix}.$$

Thus, the solution of the initial-value problem is

$$\mathbf{X} = \begin{pmatrix} t+1 \\ t \\ -2t \end{pmatrix} - 4 \begin{pmatrix} t \\ t+1 \\ -2t \end{pmatrix} + 6 \begin{pmatrix} t \\ t \\ -2t+1 \end{pmatrix}.$$

14. We have

$$\mathbf{X}(0) = c_3 \begin{pmatrix} 1 \\ 0 \end{pmatrix} + c_4 \begin{pmatrix} 0 \\ 1 \end{pmatrix} + \begin{pmatrix} -3 \\ \frac{1}{2} \end{pmatrix} = \begin{pmatrix} c_3 - 3 \\ c_4 + \frac{1}{2} \end{pmatrix} = \begin{pmatrix} 4 \\ 3 \end{pmatrix}.$$

Thus,  $c_3 = 7$  and  $c_4 = \frac{5}{2}$ , so

$$\mathbf{X} = 7 \begin{pmatrix} 1 \\ 0 \end{pmatrix} e^t + \frac{5}{2} \begin{pmatrix} 0 \\ 1 \end{pmatrix} e^{2t} + \begin{pmatrix} -3 \\ \frac{1}{2} \end{pmatrix}.$$

15. From  $s\mathbf{I} - \mathbf{A} = \begin{pmatrix} s-4 & -3 \\ 4 & s+4 \end{pmatrix}$  we find

$$(s\mathbf{I} - \mathbf{A})^{-1} = \begin{pmatrix} \frac{3/2}{s-2} - \frac{1/2}{s+2} & \frac{3/4}{s-2} - \frac{3/4}{s+2} \\ \frac{-1}{s-2} + \frac{1}{s+2} & \frac{-1/2}{s-2} + \frac{3/2}{s+2} \end{pmatrix}$$

and

$$e^{\mathbf{A}t} = \begin{pmatrix} \frac{3}{2}e^{2t} - \frac{1}{2}e^{-2t} & \frac{3}{4}e^{2t} - \frac{3}{4}e^{-2t} \\ -e^{2t} + e^{-2t} & -\frac{1}{2}e^{2t} + \frac{3}{2}e^{-2t} \end{pmatrix}.$$

The general solution of the system is then

Exercises 8.4

$$\begin{aligned}
 \mathbf{X} = e^{\mathbf{A}t}\mathbf{C} &= \begin{pmatrix} \frac{3}{2}e^{2t} - \frac{1}{2}e^{-2t} & \frac{3}{4}e^{2t} - \frac{3}{4}e^{-2t} \\ -e^{2t} + e^{-2t} & -\frac{1}{2}e^{2t} + \frac{3}{2}e^{-2t} \end{pmatrix} \begin{pmatrix} c_1 \\ c_2 \end{pmatrix} \\
 &= c_1 \begin{pmatrix} 3/2 \\ -1 \end{pmatrix} e^{2t} + c_1 \begin{pmatrix} -1/2 \\ 1 \end{pmatrix} e^{-2t} + c_2 \begin{pmatrix} 3/4 \\ -1/2 \end{pmatrix} e^{2t} + c_2 \begin{pmatrix} -3/4 \\ 3/2 \end{pmatrix} e^{-2t} \\
 &= \left(\frac{1}{2}c_1 + \frac{1}{4}c_2\right) \begin{pmatrix} 3 \\ -2 \end{pmatrix} e^{2t} + \left(-\frac{1}{2}c_1 - \frac{3}{4}c_2\right) \begin{pmatrix} 1 \\ -2 \end{pmatrix} e^{-2t} \\
 &= c_3 \begin{pmatrix} 3 \\ -2 \end{pmatrix} e^{2t} + c_4 \begin{pmatrix} 1 \\ -2 \end{pmatrix} e^{-2t}.
 \end{aligned}$$

16. From  $s\mathbf{I} - \mathbf{A} = \begin{pmatrix} s-4 & 2 \\ -1 & s-1 \end{pmatrix}$  we find

$$(s\mathbf{I} - \mathbf{A})^{-1} = \begin{pmatrix} \frac{2}{s-3} - \frac{1}{s-2} & -\frac{2}{s-3} + \frac{2}{s-2} \\ \frac{1}{s-3} - \frac{1}{s-2} & \frac{-1}{s-3} + \frac{2}{s-2} \end{pmatrix}$$

and

$$e^{\mathbf{A}t} = \begin{pmatrix} 2e^{3t} - e^{2t} & -2e^{3t} + 2e^{2t} \\ e^{3t} - e^{2t} & -e^{3t} + 2e^{2t} \end{pmatrix}.$$

The general solution of the system is then

$$\begin{aligned}
 \mathbf{X} = e^{\mathbf{A}t}\mathbf{C} &= \begin{pmatrix} 2e^{3t} - e^{2t} & -2e^{3t} + 2e^{2t} \\ e^{3t} - e^{2t} & -e^{3t} + 2e^{2t} \end{pmatrix} \begin{pmatrix} c_1 \\ c_2 \end{pmatrix} \\
 &= c_1 \begin{pmatrix} 2 \\ 1 \end{pmatrix} e^{3t} + c_1 \begin{pmatrix} -1 \\ -1 \end{pmatrix} e^{2t} + c_2 \begin{pmatrix} -2 \\ -1 \end{pmatrix} e^{3t} + c_2 \begin{pmatrix} 2 \\ 2 \end{pmatrix} e^{2t} \\
 &= (c_1 - c_2) \begin{pmatrix} 2 \\ 1 \end{pmatrix} e^{3t} + (-c_1 + 2c_2) \begin{pmatrix} 1 \\ 1 \end{pmatrix} e^{2t} \\
 &= c_3 \begin{pmatrix} 2 \\ 1 \end{pmatrix} e^{3t} + c_4 \begin{pmatrix} 1 \\ 1 \end{pmatrix} e^{2t}.
 \end{aligned}$$

17. From  $s\mathbf{I} - \mathbf{A} = \begin{pmatrix} s-5 & 9 \\ -1 & s+1 \end{pmatrix}$  we find

$$(s\mathbf{I} - \mathbf{A})^{-1} = \begin{pmatrix} \frac{1}{s-2} + \frac{3}{(s-2)^2} & -\frac{9}{(s-2)^2} \\ \frac{1}{(s-2)^2} & \frac{1}{s-2} - \frac{3}{(s-2)^2} \end{pmatrix}$$



and

$$e^{At} = \begin{pmatrix} e^{2t} + 3te^{2t} & -9te^{2t} \\ te^{2t} & e^{2t} - 3te^{2t} \end{pmatrix}.$$

The general solution of the system is then

$$\begin{aligned} \mathbf{X} &= e^{At}\mathbf{C} = \begin{pmatrix} e^{2t} + 3te^{2t} & -9te^{2t} \\ te^{2t} & e^{2t} - 3te^{2t} \end{pmatrix} \begin{pmatrix} c_1 \\ c_2 \end{pmatrix} \\ &= c_1 \begin{pmatrix} 1 \\ 0 \end{pmatrix} e^{2t} + c_1 \begin{pmatrix} 3 \\ 1 \end{pmatrix} te^{2t} + c_2 \begin{pmatrix} 0 \\ 1 \end{pmatrix} e^{2t} + c_2 \begin{pmatrix} -9 \\ -3 \end{pmatrix} te^{2t} \\ &= c_1 \begin{pmatrix} 1 + 3t \\ t \end{pmatrix} e^{2t} + c_2 \begin{pmatrix} -9t \\ 1 - 3t \end{pmatrix} e^{2t}. \end{aligned}$$

18. From  $s\mathbf{I} - \mathbf{A} = \begin{pmatrix} s & -1 \\ 2 & s+2 \end{pmatrix}$  we find

$$(s\mathbf{I} - \mathbf{A})^{-1} = \begin{pmatrix} \frac{s+1+1}{(s+1)^2+1} & \frac{1}{(s+1)^2+1} \\ \frac{-2}{(s+1)^2+1} & \frac{s+1+1}{(s+1)^2+1} \end{pmatrix}$$

and

$$e^{At} = \begin{pmatrix} e^{-t} \cos t + e^{-t} \sin t & e^{-t} \sin t \\ -2e^{-t} \sin t & e^{-t} \cos t - e^{-t} \sin t \end{pmatrix}.$$

The general solution of the system is then

$$\begin{aligned} \mathbf{X} &= e^{At}\mathbf{C} = \begin{pmatrix} e^{-t} \cos t + e^{-t} \sin t & e^{-t} \sin t \\ -2e^{-t} \sin t & e^{-t} \cos t - e^{-t} \sin t \end{pmatrix} \begin{pmatrix} c_1 \\ c_2 \end{pmatrix} \\ &= c_1 \begin{pmatrix} 1 \\ 0 \end{pmatrix} e^{-t} \cos t + c_1 \begin{pmatrix} 1 \\ -2 \end{pmatrix} e^{-t} \sin t + c_2 \begin{pmatrix} 0 \\ 1 \end{pmatrix} e^{-t} \cos t + c_2 \begin{pmatrix} 1 \\ -1 \end{pmatrix} e^{-t} \sin t \\ &= c_1 \begin{pmatrix} \cos t + \sin t \\ -2 \sin t \end{pmatrix} e^{-t} + c_2 \begin{pmatrix} \sin t \\ \cos t - \sin t \end{pmatrix} e^{-t}. \end{aligned}$$

### Exercises 8.4

19. Solving

$$\begin{vmatrix} 2-\lambda & 1 \\ -3 & 6-\lambda \end{vmatrix} = \lambda^2 - 8\lambda + 15 = (\lambda - 3)(\lambda - 5) = 0$$

we find eigenvalues  $\lambda_1 = 3$  and  $\lambda_2 = 5$ . Corresponding eigenvectors are

$$\mathbf{K}_1 = \begin{pmatrix} 1 \\ 1 \end{pmatrix} \quad \text{and} \quad \mathbf{K}_2 = \begin{pmatrix} 1 \\ 3 \end{pmatrix}.$$

Then

$$\mathbf{P} = \begin{pmatrix} 1 & 1 \\ 1 & 3 \end{pmatrix}, \quad \mathbf{P}^{-1} = \begin{pmatrix} 3/2 & -1/2 \\ -1/2 & 1/2 \end{pmatrix}, \quad \text{and} \quad \mathbf{D} = \begin{pmatrix} 3 & 0 \\ 0 & 5 \end{pmatrix},$$

so that

$$\mathbf{PDP}^{-1} = \begin{pmatrix} 2 & 1 \\ -3 & 6 \end{pmatrix}.$$

20. Solving

$$\begin{vmatrix} 2-\lambda & 1 \\ 1 & 2-\lambda \end{vmatrix} = \lambda^2 - 4\lambda + 3 = (\lambda - 1)(\lambda - 3) = 0$$

we find eigenvalues  $\lambda_1 = 1$  and  $\lambda_2 = 3$ . Corresponding eigenvectors are

$$\mathbf{K}_1 = \begin{pmatrix} -1 \\ 1 \end{pmatrix} \quad \text{and} \quad \mathbf{K}_2 = \begin{pmatrix} 1 \\ 1 \end{pmatrix}.$$

Then

$$\mathbf{P} = \begin{pmatrix} -1 & 1 \\ 1 & 1 \end{pmatrix}, \quad \mathbf{P}^{-1} = \begin{pmatrix} -1/2 & 1/2 \\ 1/2 & 1/2 \end{pmatrix}, \quad \text{and} \quad \mathbf{D} = \begin{pmatrix} 1 & 0 \\ 0 & 3 \end{pmatrix}$$

so that

$$\mathbf{PDP}^{-1} = \begin{pmatrix} 2 & 1 \\ 1 & 2 \end{pmatrix}.$$

21. From equation (3) in the text

$$\begin{aligned} e^{t\mathbf{A}} &= e^{t\mathbf{PDP}^{-1}} = \mathbf{I} + t(\mathbf{PDP}^{-1}) + \frac{1}{2!}t^2(\mathbf{PDP}^{-1})^2 + \frac{1}{3!}t^3(\mathbf{PDP}^{-1})^3 + \dots \\ &= \mathbf{P} \left[ \mathbf{I} + t\mathbf{D} + \frac{1}{2!}(t\mathbf{D})^2 + \frac{1}{3!}(t\mathbf{D})^3 + \dots \right] \mathbf{P}^{-1} = \mathbf{P}e^{t\mathbf{D}}\mathbf{P}^{-1}. \end{aligned}$$

22. From equation (3) in the text

$$\begin{aligned}
 e^{tD} &= \begin{pmatrix} 1 & 0 & \cdots & 0 \\ 0 & 1 & \cdots & 0 \\ \vdots & \vdots & \ddots & \vdots \\ 0 & 0 & \cdots & 1 \end{pmatrix} + \begin{pmatrix} \lambda_1 & 0 & \cdots & 0 \\ 0 & \lambda_2 & \cdots & 0 \\ \vdots & \vdots & \ddots & \vdots \\ 0 & 0 & \cdots & \lambda_n \end{pmatrix} + \frac{1}{2!}t^2 \begin{pmatrix} \lambda_1^2 & 0 & \cdots & 0 \\ 0 & \lambda_2^2 & \cdots & 0 \\ \vdots & \vdots & \ddots & \vdots \\ 0 & 0 & \cdots & \lambda_n^2 \end{pmatrix} \\
 &\quad + \frac{1}{3!}t^3 \begin{pmatrix} \lambda_1^3 & 0 & \cdots & 0 \\ 0 & \lambda_2^3 & \cdots & 0 \\ \vdots & \vdots & \ddots & \vdots \\ 0 & 0 & \cdots & \lambda_n^3 \end{pmatrix} + \cdots \\
 &= \begin{pmatrix} 1 + \lambda_1 t + \frac{1}{2!}(\lambda_1 t)^2 + \cdots & 0 & \cdots & 0 \\ 0 & 1 + \lambda_2 t + \frac{1}{2!}(\lambda_2 t)^2 + \cdots & \cdots & 0 \\ \vdots & \vdots & \ddots & \vdots \\ 0 & 0 & \cdots & 1 + \lambda_n t + \frac{1}{2!}(\lambda_n t)^2 + \cdots \end{pmatrix} \\
 &= \begin{pmatrix} e^{\lambda_1 t} & 0 & \cdots & 0 \\ 0 & e^{\lambda_2 t} & \cdots & 0 \\ \vdots & \vdots & \ddots & \vdots \\ 0 & 0 & \cdots & e^{\lambda_n t} \end{pmatrix}.
 \end{aligned}$$

23. From Problems 19, 21, and 22, and equation (1) in the text

$$\begin{aligned}
 \mathbf{X} &= e^{t\mathbf{A}}\mathbf{C} = \mathbf{P}e^{t\mathbf{D}}\mathbf{P}^{-1}\mathbf{C} \\
 &= \begin{pmatrix} e^{3t} & e^{5t} \\ e^{3t} & 3e^{5t} \end{pmatrix} \begin{pmatrix} e^{3t} & 0 \\ 0 & e^{5t} \end{pmatrix} \begin{pmatrix} \frac{3}{2}e^{-3t} & -\frac{1}{2}e^{-3t} \\ -\frac{1}{2}e^{-5t} & \frac{1}{2}e^{-5t} \end{pmatrix} \begin{pmatrix} c_1 \\ c_2 \end{pmatrix} \\
 &= \begin{pmatrix} \frac{3}{2}e^{3t} - \frac{1}{2}e^{5t} & -\frac{1}{2}e^{3t} + \frac{1}{2}e^{5t} \\ \frac{3}{2}e^{3t} - \frac{3}{2}e^{5t} & -\frac{1}{2}e^{3t} + \frac{3}{2}e^{5t} \end{pmatrix} \begin{pmatrix} c_1 \\ c_2 \end{pmatrix}.
 \end{aligned}$$

24. From Problems 20-22 and equation (1) in the text

$$\begin{aligned}
 \mathbf{X} &= e^{t\mathbf{A}}\mathbf{C} = \mathbf{P}e^{t\mathbf{D}}\mathbf{P}^{-1}\mathbf{C} \\
 &= \begin{pmatrix} -e^t & e^{3t} \\ e^t & e^{3t} \end{pmatrix} \begin{pmatrix} e^t & 0 \\ 0 & e^{3t} \end{pmatrix} \begin{pmatrix} -\frac{1}{2}e^{-t} & \frac{1}{2}e^{-t} \\ \frac{1}{2}e^{3t} & \frac{1}{2}e^{-3t} \end{pmatrix} \begin{pmatrix} c_1 \\ c_2 \end{pmatrix} \\
 &= \begin{pmatrix} \frac{1}{2}e^t + \frac{1}{2}e^{9t} & -\frac{1}{2}e^t + \frac{1}{2}e^{3t} \\ -\frac{1}{2}e^t + \frac{1}{2}e^{9t} & \frac{1}{2}e^t + \frac{1}{2}e^{3t} \end{pmatrix} \begin{pmatrix} c_1 \\ c_2 \end{pmatrix}.
 \end{aligned}$$

### Exercises 8.4

25. If  $\det(s\mathbf{I} - \mathbf{A}) = 0$ , then  $s$  is an eigenvalue of  $\mathbf{A}$ . Thus  $s\mathbf{I} - \mathbf{A}$  has an inverse if  $s$  is not an eigenvalue of  $\mathbf{A}$ . For the purposes of the discussion in this section, we take  $s$  to be larger than the largest eigenvalue of  $\mathbf{A}$ . Under this condition  $s\mathbf{I} - \mathbf{A}$  has an inverse.

26. Since  $\mathbf{A}^3 = \mathbf{0}$ ,  $\mathbf{A}$  is nilpotent. Since

$$e^{\mathbf{A}t} = \mathbf{I} + \mathbf{A}t + \mathbf{A}^2 \frac{t^2}{2!} + \cdots + \mathbf{A}^k \frac{t^k}{k!} + \cdots,$$

if  $\mathbf{A}$  is nilpotent and  $\mathbf{A}^m = \mathbf{0}$ , then  $\mathbf{A}^k = \mathbf{0}$  for  $k \geq m$  and

$$e^{\mathbf{A}t} = \mathbf{I} + \mathbf{A}t + \mathbf{A}^2 \frac{t^2}{2!} + \cdots + \mathbf{A}^{m-1} \frac{t^{m-1}}{(m-1)!}.$$

In this problem  $\mathbf{A}^3 = \mathbf{0}$ , so

$$\begin{aligned} e^{\mathbf{A}t} &= \mathbf{I} + \mathbf{A}t + \mathbf{A}^2 \frac{t^2}{2} = \begin{bmatrix} 1 & 0 & 0 \\ 0 & 1 & 0 \\ 0 & 0 & 1 \end{bmatrix} + \begin{bmatrix} -1 & 1 & 1 \\ -1 & 0 & 1 \\ -1 & 1 & 1 \end{bmatrix} t + \begin{bmatrix} -1 & 0 & 1 \\ 0 & 0 & 0 \\ -1 & 0 & 1 \end{bmatrix} \frac{t^2}{2} \\ &= \begin{bmatrix} 1 - t - t^2/2 & t & t + t^2/2 \\ -t & 1 & t \\ -t - t^2/2 & t & 1 + t + t^2/2 \end{bmatrix} \end{aligned}$$

and the solution of  $\mathbf{X}' = \mathbf{A}\mathbf{X}$  is

$$\mathbf{X}(t) = e^{\mathbf{A}t}\mathbf{C} = e^{\mathbf{A}t} \begin{bmatrix} c_1 \\ c_2 \\ c_3 \end{bmatrix} = \begin{bmatrix} c_1(1 - t - t^2/2) + c_2t + c_3(t + t^2/2) \\ -c_1t + c_2 + c_3t \\ c_1(-t - t^2/2) + c_2t + c_3(1 + t + t^2/2) \end{bmatrix}.$$

27. (a) The following commands can be used in *Mathematica*:

```
A={{4, 2},{3, 3}};
c={c1, c2};
m=MatrixExp[A t];
sol=Expand[m.c]
Collect[sol, {c1, c2}] // MatrixForm
```

The output gives

$$\begin{aligned} x(t) &= c_1 \left( \frac{2}{5}e^t + \frac{3}{5}e^{6t} \right) + c_2 \left( -\frac{2}{5}e^t + \frac{2}{5}e^{6t} \right) \\ y(t) &= c_1 \left( -\frac{3}{5}e^t + \frac{3}{5}e^{6t} \right) + c_2 \left( \frac{3}{5}e^t + \frac{2}{5}e^{6t} \right). \end{aligned}$$

The eigenvalues are 1 and 6 with corresponding eigenvectors

$$\begin{pmatrix} -2 \\ 3 \end{pmatrix} \quad \text{and} \quad \begin{pmatrix} 1 \\ 1 \end{pmatrix},$$

so the solution of the system is

$$\mathbf{X}(t) = b_1 \begin{pmatrix} -2 \\ 3 \end{pmatrix} e^t + b_2 \begin{pmatrix} 1 \\ 1 \end{pmatrix} e^{6t}$$

or

$$x(t) = -2b_1 e^t + b_2 e^{6t}$$

$$y(t) = 3b_1 e^t + b_2 e^{6t}.$$

If we replace  $b_1$  with  $-\frac{1}{5}c_1 + \frac{1}{5}c_2$  and  $b_2$  with  $\frac{3}{5}c_1 + \frac{2}{5}c_2$ , we obtain the solution found using the matrix exponential.

$$\begin{aligned} \text{(b)} \quad x(t) &= c_1 e^{-2t} \cos t - (c_1 + c_2) e^{-2t} \sin t \\ y(t) &= c_2 e^{-2t} \cos t + (2c_1 + c_2) e^{-2t} \sin t \end{aligned}$$

$$\begin{aligned} 28. \quad x(t) &= c_1(3e^{-2t} - 2e^{-t}) + c_3(-6e^{-2t} + 6e^{-t}) \\ y(t) &= c_2(4e^{-2t} - 3e^{-t}) + c_4(4e^{-2t} - 4e^{-t}) \\ z(t) &= c_1(e^{-2t} - e^{-t}) + c_3(-2e^{-2t} + 3e^{-t}) \\ w(t) &= c_2(-3e^{-2t} + 3e^{-t}) + c_4(-3e^{-2t} + 4e^{-t}) \end{aligned}$$

## Chapter 8 Review Exercises

1. If  $\mathbf{X} = k \begin{pmatrix} 4 \\ 5 \end{pmatrix}$ , then  $\mathbf{X}' = \mathbf{0}$  and

$$k \begin{pmatrix} 1 & 4 \\ 2 & -1 \end{pmatrix} \begin{pmatrix} 4 \\ 5 \end{pmatrix} - \begin{pmatrix} 8 \\ 1 \end{pmatrix} = k \begin{pmatrix} 24 \\ 3 \end{pmatrix} - \begin{pmatrix} 8 \\ 1 \end{pmatrix} = \begin{pmatrix} 0 \\ 0 \end{pmatrix}.$$

We see that  $k = \frac{1}{3}$ .

2. Solving for  $c_1$  and  $c_2$  we find  $c_1 = -\frac{3}{4}$  and  $c_2 = \frac{1}{4}$ .
3. Since

$$\begin{pmatrix} 4 & 6 & 6 \\ 1 & 3 & 2 \\ -1 & -4 & -3 \end{pmatrix} \begin{pmatrix} 3 \\ 1 \\ -1 \end{pmatrix} = \begin{pmatrix} 12 \\ 4 \\ -4 \end{pmatrix} = 4 \begin{pmatrix} 3 \\ 1 \\ -1 \end{pmatrix},$$

we see that  $\lambda = 4$  is an eigenvalue with eigenvector  $\mathbf{K}_3$ . The corresponding solution is  $\mathbf{X} = \mathbf{K}_3 e^{4t}$ .

4. The other eigenvalue is  $\lambda_2 = 1 - 2i$  with corresponding eigenvector  $\mathbf{K}_2 = \begin{pmatrix} 1 \\ -i \end{pmatrix}$ . The general solution is

$$\mathbf{X}(t) = c_1 \begin{pmatrix} \cos 2t \\ -\sin 2t \end{pmatrix} e^t + c_2 \begin{pmatrix} \sin 2t \\ \cos 2t \end{pmatrix} e^t.$$

Chapter 8 Review Exercises

5. We have  $\det(\mathbf{A} - \lambda\mathbf{I}) = (\lambda - 1)^2 = 0$  and  $\mathbf{K} = \begin{pmatrix} 1 \\ -1 \end{pmatrix}$ . A solution to  $(\mathbf{A} - \lambda\mathbf{I})\mathbf{P} = \mathbf{K}$  is  $\mathbf{P} = \begin{pmatrix} 0 \\ 1 \end{pmatrix}$  so that

$$\mathbf{X} = c_1 \begin{pmatrix} 1 \\ -1 \end{pmatrix} e^t + c_2 \left[ \begin{pmatrix} 1 \\ -1 \end{pmatrix} t e^t + \begin{pmatrix} 0 \\ 1 \end{pmatrix} e^t \right].$$

6. We have  $\det(\mathbf{A} - \lambda\mathbf{I}) = (\lambda + 6)(\lambda + 2) = 0$  so that

$$\mathbf{X} = c_1 \begin{pmatrix} 1 \\ -1 \end{pmatrix} e^{-6t} + c_2 \begin{pmatrix} 1 \\ 1 \end{pmatrix} e^{-2t}.$$

7. We have  $\det(\mathbf{A} - \lambda\mathbf{I}) = \lambda^2 - 2\lambda + 5 = 0$ . For  $\lambda = 1 + 2i$  we obtain  $\mathbf{K}_1 = \begin{pmatrix} 1 \\ i \end{pmatrix}$  and

$$\mathbf{X}_1 = \begin{pmatrix} 1 \\ i \end{pmatrix} e^{(1+2i)t} = \begin{pmatrix} \cos 2t \\ -\sin 2t \end{pmatrix} e^t + i \begin{pmatrix} \sin 2t \\ \cos 2t \end{pmatrix} e^t.$$

Then

$$\mathbf{X} = c_1 \begin{pmatrix} \cos 2t \\ -\sin 2t \end{pmatrix} e^t + c_2 \begin{pmatrix} \sin 2t \\ \cos 2t \end{pmatrix} e^t.$$

8. We have  $\det(\mathbf{A} - \lambda\mathbf{I}) = \lambda^2 - 2\lambda + 2 = 0$ . For  $\lambda = 1 + i$  we obtain  $\mathbf{K}_1 = \begin{pmatrix} 3 - i \\ 2 \end{pmatrix}$  and

$$\mathbf{X}_1 = \begin{pmatrix} 3 - i \\ 2 \end{pmatrix} e^{(1+i)t} = \begin{pmatrix} 3 \cos t + \sin t \\ 2 \cos t \end{pmatrix} e^t + i \begin{pmatrix} -\cos t + 3 \sin t \\ 2 \sin t \end{pmatrix} e^t.$$

Then

$$\mathbf{X} = c_1 \begin{pmatrix} 3 \cos t + \sin t \\ 2 \cos t \end{pmatrix} e^t + c_2 \begin{pmatrix} -\cos t + 3 \sin t \\ 2 \sin t \end{pmatrix} e^t.$$

9. We have  $\det(\mathbf{A} - \lambda\mathbf{I}) = -(\lambda - 2)(\lambda - 4)(\lambda + 3) = 0$  so that

$$\mathbf{X} = c_1 \begin{pmatrix} -2 \\ 3 \\ 1 \end{pmatrix} e^{2t} + c_2 \begin{pmatrix} 0 \\ 1 \\ 1 \end{pmatrix} e^{4t} + c_3 \begin{pmatrix} 7 \\ 12 \\ -16 \end{pmatrix} e^{-3t}.$$

10. We have  $\det(\mathbf{A} - \lambda\mathbf{I}) = -(s + 2)(s^2 - 2s + 3) = 0$ . The eigenvalues are  $\lambda_1 = -2$ ,  $\lambda_2 = 1 + \sqrt{2}i$ , and  $\lambda_3 = 1 - \sqrt{2}i$ , with eigenvectors

$$\mathbf{K}_1 = \begin{pmatrix} -7 \\ 5 \\ 4 \end{pmatrix}, \quad \mathbf{K}_2 = \begin{pmatrix} 1 \\ \sqrt{2}i/2 \\ 1 \end{pmatrix}, \quad \text{and} \quad \mathbf{K}_3 = \begin{pmatrix} 1 \\ -\sqrt{2}i/2 \\ 1 \end{pmatrix}.$$

Thus

$$\begin{aligned} \mathbf{X} &= c_1 \begin{pmatrix} -7 \\ 5 \\ 4 \end{pmatrix} e^{-2t} + c_2 \left[ \begin{pmatrix} 1 \\ 0 \\ 1 \end{pmatrix} \cos \sqrt{2}t - \begin{pmatrix} 0 \\ \sqrt{2}/2 \\ 0 \end{pmatrix} \sin \sqrt{2}t \right] e^t \\ &\quad + c_3 \left[ \begin{pmatrix} 0 \\ \sqrt{2}/2 \\ 0 \end{pmatrix} \cos \sqrt{2}t + \begin{pmatrix} 1 \\ 0 \\ 1 \end{pmatrix} \sin \sqrt{2}t \right] e^t \\ &= c_1 \begin{pmatrix} -7 \\ 5 \\ 4 \end{pmatrix} e^{-2t} + c_2 \begin{pmatrix} \cos \sqrt{2}t \\ -\sqrt{2} \sin \sqrt{2}t/2 \\ \cos \sqrt{2}t \end{pmatrix} e^t + c_3 \begin{pmatrix} \sin \sqrt{2}t \\ \sqrt{2} \cos \sqrt{2}t/2 \\ \sin \sqrt{2}t \end{pmatrix} e^t. \end{aligned}$$

11. We have

$$\mathbf{X}_c = c_1 \begin{pmatrix} 1 \\ 0 \end{pmatrix} e^{2t} + c_2 \begin{pmatrix} 4 \\ 1 \end{pmatrix} e^{4t}.$$

Then

$$\Phi = \begin{pmatrix} e^{2t} & 4e^{4t} \\ 0 & e^{4t} \end{pmatrix}, \quad \Phi^{-1} = \begin{pmatrix} e^{-2t} & -4e^{-2t} \\ 0 & e^{-4t} \end{pmatrix},$$

and

$$\mathbf{U} = \int \Phi^{-1} \mathbf{F} dt = \int \begin{pmatrix} 2e^{-2t} - 64te^{-2t} \\ 16te^{-4t} \end{pmatrix} dt = \begin{pmatrix} 15e^{-2t} + 32te^{-2t} \\ -e^{-4t} - 4te^{-4t} \end{pmatrix},$$

so that

$$\mathbf{X}_p = \Phi \mathbf{U} = \begin{pmatrix} 11 + 16t \\ -1 - 4t \end{pmatrix}.$$

12. We have

$$\mathbf{X}_c = c_1 \begin{pmatrix} 2 \cos t \\ -\sin t \end{pmatrix} e^t + c_2 \begin{pmatrix} 2 \sin t \\ \cos t \end{pmatrix} e^t.$$

Then

$$\Phi = \begin{pmatrix} 2 \cos t & 2 \sin t \\ -\sin t & \cos t \end{pmatrix} e^t, \quad \Phi^{-1} = \begin{pmatrix} \frac{1}{2} \cos t & -\sin t \\ \frac{1}{2} \sin t & \cos t \end{pmatrix} e^{-t},$$

and

$$\mathbf{U} = \int \Phi^{-1} \mathbf{F} dt = \int \begin{pmatrix} \cos t - \sec t \\ \sin t \end{pmatrix} dt = \begin{pmatrix} \sin t - \ln |\sec t + \tan t| \\ -\cos t \end{pmatrix},$$

so that

$$\mathbf{X}_p = \Phi \mathbf{U} = \begin{pmatrix} -2 \cos t \ln |\sec t + \tan t| \\ -1 + \sin t \ln |\sec t + \tan t| \end{pmatrix}.$$

### Chapter 8 Review Exercises

13. We have

$$\mathbf{X}_c = c_1 \begin{pmatrix} \cos t + \sin t \\ 2 \cos t \end{pmatrix} + c_2 \begin{pmatrix} \sin t - \cos t \\ 2 \sin t \end{pmatrix}.$$

Then

$$\Phi = \begin{pmatrix} \cos t + \sin t & \sin t - \cos t \\ 2 \cos t & 2 \sin t \end{pmatrix}, \quad \Phi^{-1} = \begin{pmatrix} \sin t & \frac{1}{2} \cos t - \frac{1}{2} \sin t \\ -\cos t & \frac{1}{2} \cos t + \frac{1}{2} \sin t \end{pmatrix},$$

and

$$\begin{aligned} \mathbf{U} &= \int \Phi^{-1} \mathbf{F} dt = \int \begin{pmatrix} \frac{1}{2} \sin t - \frac{1}{2} \cos t + \frac{1}{2} \csc t \\ -\frac{1}{2} \sin t - \frac{1}{2} \cos t + \frac{1}{2} \csc t \end{pmatrix} dt \\ &= \begin{pmatrix} -\frac{1}{2} \cos t - \frac{1}{2} \sin t + \frac{1}{2} \ln |\csc t - \cot t| \\ \frac{1}{2} \cos t - \frac{1}{2} \sin t + \frac{1}{2} \ln |\csc t - \cot t| \end{pmatrix}, \end{aligned}$$

so that

$$\mathbf{X}_p = \Phi \mathbf{U} = \begin{pmatrix} -1 \\ -1 \end{pmatrix} + \begin{pmatrix} \sin t \\ \sin t + \cos t \end{pmatrix} \ln |\csc t - \cot t|.$$

14. We have

$$\mathbf{X}_c = c_1 \begin{pmatrix} 1 \\ -1 \end{pmatrix} e^{2t} + c_2 \left[ \begin{pmatrix} 1 \\ -1 \end{pmatrix} t e^{2t} + \begin{pmatrix} 1 \\ 0 \end{pmatrix} e^{2t} \right].$$

Then

$$\Phi = \begin{pmatrix} e^{2t} & t e^{2t} + e^{2t} \\ -e^{2t} & -t e^{2t} \end{pmatrix}, \quad \Phi^{-1} = \begin{pmatrix} -t e^{-2t} & -t e^{-2t} - e^{-2t} \\ e^{-2t} & e^{-2t} \end{pmatrix},$$

and

$$\mathbf{U} = \int \Phi^{-1} \mathbf{F} dt = \int \begin{pmatrix} t-1 \\ -1 \end{pmatrix} dt = \begin{pmatrix} \frac{1}{2} t^2 - t \\ -t \end{pmatrix},$$

so that

$$\mathbf{X}_p = \Phi \mathbf{U} = \begin{pmatrix} -1/2 \\ 1/2 \end{pmatrix} t^2 e^{2t} + \begin{pmatrix} -2 \\ 1 \end{pmatrix} t e^{2t}.$$

15. (a) Letting

$$\mathbf{K} = \begin{pmatrix} k_1 \\ k_2 \\ k_3 \end{pmatrix}$$

we note that  $(\mathbf{A} - 2\mathbf{I})\mathbf{K} = \mathbf{0}$  implies that  $3k_1 + 3k_2 + 3k_3 = 0$ , so  $k_1 = -(k_2 + k_3)$ . Choosing  $k_2 = 0$ ,  $k_3 = 1$  and then  $k_2 = 1$ ,  $k_3 = 0$  we get

$$\mathbf{K}_1 = \begin{pmatrix} -1 \\ 0 \\ 1 \end{pmatrix} \quad \text{and} \quad \mathbf{K}_2 = \begin{pmatrix} -1 \\ 1 \\ 0 \end{pmatrix},$$



respectively. Thus,

$$\mathbf{X}_1 = \begin{pmatrix} -1 \\ 0 \\ 1 \end{pmatrix} e^{2t} \quad \text{and} \quad \mathbf{X}_2 = \begin{pmatrix} -1 \\ 1 \\ 0 \end{pmatrix} e^{2t}$$

are two solutions.

- (b) From  $\det(\mathbf{A} - \lambda\mathbf{I}) = \lambda^2(3 - \lambda) = 0$  we see that  $\lambda_1 = 3$ , and 0 is an eigenvalue of multiplicity two. Letting

$$\mathbf{K} = \begin{pmatrix} k_1 \\ k_2 \\ k_3 \end{pmatrix},$$

as in part (a), we note that  $(\mathbf{A} - 0\mathbf{I})\mathbf{K} = \mathbf{A}\mathbf{K} = \mathbf{0}$  implies that  $k_1 + k_2 + k_3 = 0$ , so  $k_1 = -(k_2 + k_3)$ . Choosing  $k_2 = 0$ ,  $k_3 = 1$ , and then  $k_2 = 1$ ,  $k_3 = 0$  we get

$$\mathbf{K}_2 = \begin{pmatrix} -1 \\ 0 \\ 1 \end{pmatrix} \quad \text{and} \quad \mathbf{K}_3 = \begin{pmatrix} -1 \\ 1 \\ 0 \end{pmatrix},$$

respectively. Since the eigenvector corresponding to  $\lambda_1 = 3$  is

$$\mathbf{K}_1 = \begin{pmatrix} 1 \\ 1 \\ 1 \end{pmatrix},$$

the general solution of the system is

$$\mathbf{X} = c_1 \begin{pmatrix} 1 \\ 1 \\ 1 \end{pmatrix} e^{3t} + c_2 \begin{pmatrix} -1 \\ 0 \\ 1 \end{pmatrix} + c_3 \begin{pmatrix} -1 \\ 1 \\ 0 \end{pmatrix}.$$

16. For  $\mathbf{X} = \begin{pmatrix} c_1 \\ c_2 \end{pmatrix} e^t$  we have  $\mathbf{X}' = \mathbf{X} = \mathbf{I}\mathbf{X}$ .

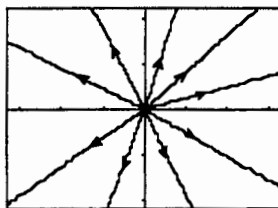

## Chapter 8 Related Exercises

1. (a) In operator notation we have

$$(D^2 + 4)x_1 - 2x_2 = 0$$

$$2x_1 - (D^2 + 2)x_2 = 0.$$

Eliminating  $x_2$  we have  $(D^4 + 6D^2 + 4)x_1 = 0$ . The roots of the auxiliary equation are  $\pm\sqrt{3 - \sqrt{5}}i$  and  $\pm\sqrt{3 + \sqrt{5}}i$ , so

$$x_1(t) = c_1 \cos \sqrt{3 - \sqrt{5}}t + c_2 \sin \sqrt{3 - \sqrt{5}}t + c_3 \cos \sqrt{3 + \sqrt{5}}t + c_4 \sin \sqrt{3 + \sqrt{5}}t.$$

Then

$$\begin{aligned} x_2(t) &= \frac{1}{2}(D^2 + 4)x_1(t) \\ &= \frac{1 + \sqrt{5}}{2}c_1 \cos \sqrt{3 - \sqrt{5}}t + \frac{1 + \sqrt{5}}{2}c_2 \sin \sqrt{3 - \sqrt{5}}t \\ &\quad + \frac{1 - \sqrt{5}}{2}c_3 \cos \sqrt{3 + \sqrt{5}}t + \frac{1 - \sqrt{5}}{2}c_4 \sin \sqrt{3 + \sqrt{5}}t. \end{aligned}$$

The frequencies are  $\omega_1 = \sqrt{3 - \sqrt{5}}$  and  $\omega_2 = \sqrt{3 + \sqrt{5}}$ .

- (b) We write the system in the form

$$\mathbf{X}'' = \begin{bmatrix} -4 & 2 \\ 2 & -2 \end{bmatrix} \mathbf{X}$$

and assume solutions of the form

$$\mathbf{X} = \mathbf{V} \cos \omega t \quad \text{and} \quad \mathbf{X} = \mathbf{V} \sin \omega t$$

Since the eigenvalues are  $-3 + \sqrt{5}$  and  $-3 - \sqrt{5}$ ,  $\omega_1 = \sqrt{3 - \sqrt{5}}$  and  $\omega_2 = \sqrt{3 + \sqrt{5}}$ . The corresponding eigenvectors are

$$\mathbf{V}_1 = \begin{bmatrix} 1 \\ (1 + \sqrt{5})/2 \end{bmatrix} \quad \text{and} \quad \begin{bmatrix} 1 \\ (1 - \sqrt{5})/2 \end{bmatrix}.$$

Then, the general solution of the system is

$$\begin{aligned} \mathbf{X}(t) &= c_1 \begin{bmatrix} 1 \\ (1 + \sqrt{5})/2 \end{bmatrix} \cos \sqrt{3 - \sqrt{5}}t + c_2 \begin{bmatrix} 1 \\ (1 + \sqrt{5})/2 \end{bmatrix} \sin \sqrt{3 - \sqrt{5}}t \\ &\quad + c_3 \begin{bmatrix} 1 \\ (1 - \sqrt{5})/2 \end{bmatrix} \cos \sqrt{3 + \sqrt{5}}t + c_4 \begin{bmatrix} 1 \\ (1 - \sqrt{5})/2 \end{bmatrix} \sin \sqrt{3 + \sqrt{5}}t. \end{aligned}$$

2. If  $\mathbf{K}$  is multiplied by a factor of 10, then

$$A = M^{-1}K = \begin{bmatrix} -10 & 2 & 0 & 0 & 0 & 0 & 0 & 0 & 0 & 0 \\ 2 & -10 & 2 & 0 & 0 & 0 & 0 & 0 & 0 & 0 \\ 0 & 2 & -10 & 2 & 0 & 0 & 0 & 0 & 0 & 0 \\ 0 & 0 & 2 & -10 & 2 & 0 & 0 & 0 & 0 & 0 \\ 0 & 0 & 0 & 2 & -10 & 2 & 0 & 0 & 0 & 0 \\ 0 & 0 & 0 & 0 & 2 & -10 & 2 & 0 & 0 & 0 \\ 0 & 0 & 0 & 0 & 0 & 2 & -10 & 2 & 0 & 0 \\ 0 & 0 & 0 & 0 & 0 & 0 & 2 & -10 & 2 & 0 \\ 0 & 0 & 0 & 0 & 0 & 0 & 0 & 2 & -10 & 2 \\ 0 & 0 & 0 & 0 & 0 & 0 & 0 & 0 & 2 & -10 \end{bmatrix}$$

The table below shows the eigenvalues  $\lambda_i$  with the corresponding frequencies  $\omega_i = \sqrt{-\lambda_i}$  and periods  $T_i = 2\pi/\omega_i$ .

$\lambda_i$	-13.8117	-13.2639	-12.4064	-11.3175	-10.0974	-8.8604	-7.7256	-6.8082	-6.2089	-1.5000
$\omega_i$	3.7164	3.6420	3.5223	3.3641	3.1776	2.9766	2.7795	2.6093	2.4918	1.2247
$T_i$	1.6907	1.7252	1.7838	1.8677	1.9773	2.1108	2.2605	2.4080	2.5216	5.1302

We see that the frequencies are higher and consequently, the periods are smaller.

3. (a) For this exercise we assume a building of four stories, each with mass 10,000 kg and restoring force constants each  $k_i = 5,000 \text{ kg/s}^2$ . Then

$$M = 10,000 \begin{bmatrix} 1 & 0 & 0 & 0 \\ 0 & 1 & 0 & 0 \\ 0 & 0 & 1 & 0 \\ 0 & 0 & 0 & 1 \end{bmatrix}, \quad K = \begin{bmatrix} -10,000 & 5,000 & 0 & 0 \\ 5,000 & -10,000 & 5,000 & 0 \\ 0 & 5,000 & -10,000 & 5,000 \\ 0 & 0 & 5,000 & -5,000 \end{bmatrix},$$

and

$$A = \begin{bmatrix} -1 & 0.5 & 0 & 0 \\ 0.5 & -1 & 0.5 & 0 \\ 0 & 0.5 & -1 & 0.5 \\ 0 & 0 & 0.5 & -0.5 \end{bmatrix}.$$

- (b) The table below shows the eigenvalues  $\lambda_i$  with the corresponding frequencies  $\omega_i = \sqrt{-\lambda_i}$  and periods  $T_i = 2\pi/\omega_i$ .

$\lambda_i$	-1.7660	-1.1737	-0.5000	-0.0603
$\omega_i$	1.3289	1.0834	0.7071	0.2456
$T_i$	4.7280	5.7998	8.8858	25.5855

## Chapter 8 Related Exercises

Since the periods are all larger than 4, the building should be safe in a period-2 earthquake.

(c) If  $k$  is multiplied by 10, then

$$\mathbf{A} = \begin{bmatrix} -100 & 50 & 0 & 0 \\ 50 & -100 & 50 & 0 \\ 0 & 50 & -100 & 50 \\ 0 & 0 & 50 & -50 \end{bmatrix}$$

From the table below we see that the periods are generally in the range from 1.5 to 3 and the building is unsafe from a period-2 earthquake.

$\lambda_i$	-17.660	-11.737	-5.000	-0.603
$\omega_i$	4.2024	3.4259	2.2361	0.7766
$T_i$	1.4951	1.8340	2.8099	8.0909

Experimenting, we see that if the building is made stiffer by a factor of 8, the periods are entering the danger zone.

$\lambda_i$	-14.128	-9.389	-4.000	-0.482
$\omega_i$	3.7588	3.0642	2.0000	0.6946
$T_i$	1.6716	2.0505	3.1416	9.0459

4. The related homogeneous system is  $\mathbf{X}'' = \mathbf{M}^{-1}\mathbf{K}\mathbf{X} = \mathbf{A}\mathbf{X}$ , where  $\mathbf{A}$  is shown in the solution of Problem 3(a). We assume solutions of the form  $\mathbf{X} = \mathbf{V} \cos \omega t$  and  $\mathbf{X} = \mathbf{V} \sin \omega t$ . The eigenvalues are  $-1.7660$ ,  $-1.1737$ ,  $-0.5$ , and  $-0.0603$  with corresponding frequencies 1.3289, 1.0834, 0.7071, and 0.2456. The eigenvectors are

$$\mathbf{V}_1 = \begin{bmatrix} -0.4285 \\ -0.6565 \\ 0.5774 \\ 0.2280 \end{bmatrix}, \quad \mathbf{V}_2 = \begin{bmatrix} 0.6565 \\ 0.2280 \\ 0.5774 \\ 0.4285 \end{bmatrix}, \quad \mathbf{V}_3 = \begin{bmatrix} -0.5774 \\ 0.5774 \\ 0 \\ 0.5774 \end{bmatrix}, \quad \text{and} \quad \mathbf{V}_4 = \begin{bmatrix} 0.2280 \\ -0.4285 \\ -0.5774 \\ 0.6565 \end{bmatrix}$$

and the general solution is

$$\begin{aligned} \mathbf{X}(t) = & c_1 \mathbf{V}_1 \cos 1.3289t + c_2 \mathbf{V}_1 \sin 1.3289t + c_3 \mathbf{V}_2 \cos 1.0834t \\ & + c_4 \mathbf{V}_2 \sin 1.0834t + c_5 \mathbf{V}_3 \cos 0.7071t + c_6 \mathbf{V}_3 \sin 0.7071t \\ & + c_7 \mathbf{V}_4 \cos 0.2456t + c_8 \mathbf{V}_4 \sin 0.2456t. \end{aligned}$$

Since

$$\mathbf{F}(t) = \begin{bmatrix} 10000 \cos 3t \\ 0 \\ 0 \\ 0 \end{bmatrix},$$

to solve the nonhomogeneous system we look for a particular solution of the form

$$\mathbf{X}_p = \begin{bmatrix} a_1 \\ a_2 \\ a_3 \\ a_4 \end{bmatrix} \cos 3t + \begin{bmatrix} b_1 \\ b_2 \\ b_3 \\ b_4 \end{bmatrix} \sin 3t.$$

Substituting into  $\mathbf{X}'' = \mathbf{A}\mathbf{X} + \mathbf{M}^{-1}\mathbf{F}(t)$  we obtain

$$\begin{array}{ll} -9a_1 = 1 - a_1 + 0.5a_2 & -9b_1 = b_1 + 0.5b_2 \\ -9a_2 = 0.5a_1 - a_2 + 0.5a_3 & -9b_2 = 0.5b_1 - b_2 + 0.5b_3 \\ -9a_3 = 0.5a_2 - a_3 + 0.5a_4 & -9b_3 = 0.5b_2 - b_3 + 0.5b_4 \\ -9a_4 = 0.5a_3 - 0.5a_4 & -9b_4 = 0.5b_3 - 0.5b_4. \end{array}$$

Solving these systems gives  $a_1 = -0.12549$ ,  $a_2 = 0.00787$ ,  $a_3 = 0.00049$ ,  $a_4 = 0.00003$ , and  $b_1 = b_2 = b_3 = b_4 = 0$ . Thus,

$$\mathbf{X}_p = \begin{bmatrix} -0.12549 \\ 0.00787 \\ -0.00049 \\ 0.00003 \end{bmatrix} \cos 3t.$$

Applying the initial conditions  $\mathbf{X}(0) = 0$  and  $\mathbf{X}'(0) = 0$ , we find  $c_1 = -0.0592$ ,  $c_2 = 0$ ,  $c_3 = -0.0839$ ,  $c_4 = 0$ ,  $c_5 = 0.0679$ ,  $c_6 = 0$ ,  $c_7 = 0.0255$ , and  $c_8 = 0$ . Thus, the solution of the initial-value problem is

$$\begin{aligned} \mathbf{X}(t) = & -0.0592 \begin{bmatrix} -0.4285 \\ -0.6565 \\ 0.5774 \\ 0.2280 \end{bmatrix} \cos 1.3289t - 0.0839 \begin{bmatrix} 0.6565 \\ 0.2280 \\ 0.5774 \\ 0.4285 \end{bmatrix} \cos 1.0834t \\ & + 0.0679 \begin{bmatrix} -0.5774 \\ 0.5774 \\ 0 \\ 0.5774 \end{bmatrix} \cos 0.0679t + 0.0255 \begin{bmatrix} 0.2280 \\ -0.4285 \\ -0.5774 \\ 0.6565 \end{bmatrix} \cos 0.2456t + \begin{bmatrix} -0.12549 \\ 0.00787 \\ -0.00049 \\ 0.00003 \end{bmatrix} \cos 3t. \end{aligned}$$

# 9 Numerical Solutions of Ordinary Differential Equations

## Exercises 9.1

All tables in this chapter were constructed in a spreadsheet program which does not support subscripts. Consequently,  $x_n$  and  $y_n$  will be indicated as  $x(n)$  and  $y(n)$ , respectively.

1.

$h = 0.1$		$h = 0.05$	
$x(n)$	$y(n)$	$x(n)$	$y(n)$
1.00	5.0000	1.00	5.0000
1.10	3.9900	1.05	4.4475
1.20	3.2546	1.10	3.9763
1.30	2.7236	1.15	3.5751
1.40	2.3451	1.20	3.2342
1.50	2.0801	1.25	2.9425
		1.30	2.7009
		1.35	2.4952
		1.40	2.3226
		1.45	2.1786
		1.50	2.0592

2.

$h = 0.1$		$h = 0.05$	
$x(n)$	$y(n)$	$x(n)$	$y(n)$
0.00	2.0000	0.00	2.0000
0.10	1.6600	0.05	1.8150
0.20	1.4172	0.10	1.6571
0.30	1.2541	0.15	1.5237
0.40	1.1564	0.20	1.4124
0.50	1.1122	0.25	1.3212
		0.30	1.2482
		0.35	1.1916
		0.40	1.1499
		0.45	1.1217
		0.50	1.1056

3.

$h = 0.1$		$h = 0.05$	
$x(n)$	$y(n)$	$x(n)$	$y(n)$
0.00	0.0000	0.00	0.0000
0.10	0.1005	0.05	0.0501
0.20	0.2030	0.10	0.1004
0.30	0.3098	0.15	0.1512
0.40	0.4234	0.20	0.2028
0.50	0.5470	0.25	0.2554
		0.30	0.3095
		0.35	0.3652
		0.40	0.4230
		0.45	0.4832
		0.50	0.5465

Exercises 9.1

4.

$h = 0.1$		$h = 0.05$	
$x(n)$	$y(n)$	$x(n)$	$y(n)$
0.00	1.0000	0.00	1.0000
0.10	1.1110	0.05	1.0526
0.20	1.2515	0.10	1.1113
0.30	1.4361	0.15	1.1775
0.40	1.6880	0.20	1.2526
0.50	2.0488	0.25	1.3388
		0.30	1.4387
		0.35	1.5556
		0.40	1.6939
		0.45	1.8598
		0.50	2.0619

5.

$h = 0.1$		$h = 0.05$	
$x(n)$	$y(n)$	$x(n)$	$y(n)$
0.00	0.0000	0.00	0.0000
0.10	0.0952	0.05	0.0488
0.20	0.1822	0.10	0.0953
0.30	0.2622	0.15	0.1397
0.40	0.3363	0.20	0.1823
0.50	0.4053	0.25	0.2231
		0.30	0.2623
		0.35	0.3001
		0.40	0.3364
		0.45	0.3715
		0.50	0.4054

6.

$h = 0.1$		$h = 0.05$	
$x(n)$	$y(n)$	$x(n)$	$y(n)$
0.00	0.0000	0.00	0.0000
0.10	0.0050	0.05	0.0013
0.20	0.0200	0.10	0.0050
0.30	0.0451	0.15	0.0113
0.40	0.0805	0.20	0.0200
0.50	0.1266	0.25	0.0313
		0.30	0.0451
		0.35	0.0615
		0.40	0.0805
		0.45	0.1022
		0.50	0.1266

7.

$h = 0.1$		$h = 0.05$	
$x(n)$	$y(n)$	$x(n)$	$y(n)$
0.00	0.5000	0.00	0.5000
0.10	0.5215	0.05	0.5116
0.20	0.5362	0.10	0.5214
0.30	0.5449	0.15	0.5294
0.40	0.5490	0.20	0.5359
0.50	0.5503	0.25	0.5408
		0.30	0.5444
		0.35	0.5469
		0.40	0.5484
		0.45	0.5492
		0.50	0.5495

### Exercises 9.1

8.

$h = 0.1$	
$x(n)$	$y(n)$
0.00	1.0000
0.10	1.1079
0.20	1.2337
0.30	1.3806
0.40	1.5529
0.50	1.7557

$h = 0.05$	
$x(n)$	$y(n)$
0.00	1.0000
0.05	1.0519
0.10	1.1079
0.15	1.1684
0.20	1.2337
0.25	1.3043
0.30	1.3807
0.35	1.4634
0.40	1.5530
0.45	1.6503
0.50	1.7560

9.

$h = 0.1$	
$x(n)$	$y(n)$
1.00	1.0000
1.10	1.0095
1.20	1.0404
1.30	1.0967
1.40	1.1866
1.50	1.3260

$h = 0.05$	
$x(n)$	$y(n)$
1.00	1.0000
1.05	1.0024
1.10	1.0100
1.15	1.0228
1.20	1.0414
1.25	1.0663
1.30	1.0984
1.35	1.1389
1.40	1.1895
1.45	1.2526
1.50	1.3315

10.

$h = 0.1$	
$x(n)$	$y(n)$
0.00	0.5000
0.10	0.5250
0.20	0.5498
0.30	0.5744
0.40	0.5986
0.50	0.6224

$h = 0.05$	
$x(n)$	$y(n)$
0.00	0.5000
0.05	0.5125
0.10	0.5250
0.15	0.5374
0.20	0.5498
0.25	0.5622
0.30	0.5744
0.35	0.5866
0.40	0.5987
0.45	0.6106
0.50	0.6224

11.

$h = 0.1$		
$x(n)$	$y(n)$	exact
0.00	2.0000	2.0000
0.10	2.1220	2.1230
0.20	2.3049	2.3085
0.30	2.5858	2.5958
0.40	3.0378	3.0650
0.50	3.8254	3.9082

$h = 0.05$		
$x(n)$	$y(n)$	exact
0.00	2.0000	2.0000
0.05	2.0553	2.0554
0.10	2.1228	2.1230
0.15	2.2056	2.2061
0.20	2.3075	2.3085
0.25	2.4342	2.4358
0.30	2.5931	2.5958
0.35	2.7953	2.7997
0.40	3.0574	3.0650
0.45	3.4057	3.4189
0.50	3.8840	3.9082



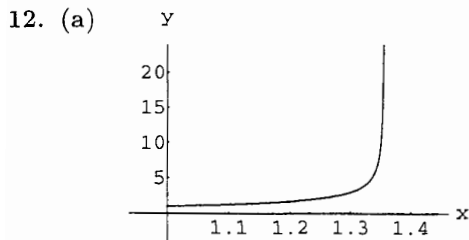

(b)

h=0.1	EULER	IMPROVED EULER
x(n)	y(n)	y(n)
1.00	1.0000	1.0000
1.10	1.2000	1.2469
1.20	1.4938	1.6668
1.30	1.9711	2.6427
1.40	2.9060	8.7988

13. (a) Using the Euler method we obtain  $y(0.1) \approx y_1 = 1.2$ .

(b) Using  $y'' = 4e^{2x}$  we see that the local truncation error is

$$y''(c) \frac{h^2}{2} = 4e^{2c} \frac{(0.1)^2}{2} = 0.02e^{2c}.$$

Since  $e^{2x}$  is an increasing function,  $e^{2c} \leq e^{2(0.1)} = e^{0.2}$  for  $0 \leq c \leq 0.1$ . Thus an upper bound for the local truncation error is  $0.02e^{0.2} = 0.0244$ .

(c) Since  $y(0.1) = e^{0.2} = 1.2214$ , the actual error is  $y(0.1) - y_1 = 0.0214$ , which is less than 0.0244.

(d) Using the Euler method with  $h = 0.05$  we obtain  $y(0.1) \approx y_2 = 1.21$ .

(e) The error in (d) is  $1.2214 - 1.21 = 0.0114$ . With global truncation error  $O(h)$ , when the step size is halved we expect the error for  $h = 0.05$  to be one-half the error when  $h = 0.1$ . Comparing 0.0114 with 0.214 we see that this is the case.

14. (a) Using the improved Euler method we obtain  $y(0.1) \approx y_1 = 1.22$ .

(b) Using  $y''' = 8e^{2x}$  we see that the local truncation error is

$$y'''(c) \frac{h^3}{6} = 8e^{2c} \frac{(0.1)^3}{6} = 0.001333e^{2c}.$$

Since  $e^{2x}$  is an increasing function,  $e^{2c} \leq e^{2(0.1)} = e^{0.2}$  for  $0 \leq c \leq 0.1$ . Thus an upper bound for the local truncation error is  $0.001333e^{0.2} = 0.001628$ .

(c) Since  $y(0.1) = e^{0.2} = 1.221403$ , the actual error is  $y(0.1) - y_1 = 0.001403$  which is less than 0.001628.

(d) Using the improved Euler method with  $h = 0.05$  we obtain  $y(0.1) \approx y_2 = 1.221025$ .

(e) The error in (d) is  $1.221403 - 1.221025 = 0.000378$ . With global truncation error  $O(h^2)$ , when the step size is halved we expect the error for  $h = 0.05$  to be one-fourth the error for  $h = 0.1$ . Comparing 0.000378 with 0.001403 we see that this is the case.

15. (a) Using the Euler method we obtain  $y(0.1) \approx y_1 = 0.8$ .

(b) Using  $y'' = 5e^{-2x}$  we see that the local truncation error is

$$5e^{-2c} \frac{(0.1)^2}{2} = 0.025e^{-2c}.$$

### Exercises 9.1

Since  $e^{-2x}$  is a decreasing function,  $e^{-2c} \leq e^0 = 1$  for  $0 \leq c \leq 0.1$ . Thus an upper bound for the local truncation error is  $0.025(1) = 0.025$ .

- (c) Since  $y(0.1) = 0.8234$ , the actual error is  $y(0.1) - y_1 = 0.0234$ , which is less than 0.025.  
 (d) Using the Euler method with  $h = 0.05$  we obtain  $y(0.1) \approx y_2 = 0.8125$ .  
 (e) The error in (d) is  $0.8234 - 0.8125 = 0.0109$ . With global truncation error  $O(h)$ , when the step size is halved we expect the error for  $h = 0.05$  to be one-half the error when  $h = 0.1$ . Comparing 0.0109 with 0.0234 we see that this is the case.

16. (a) Using the improved Euler method we obtain  $y(0.1) \approx y_1 = 0.825$ .

- (b) Using  $y''' = -10e^{-2x}$  we see that the local truncation error is

$$10e^{-2c} \frac{(0.1)^3}{6} = 0.001667e^{-2c}.$$

Since  $e^{-2x}$  is a decreasing function,  $e^{-2c} \leq e^0 = 1$  for  $0 \leq c \leq 0.1$ . Thus an upper bound for the local truncation error is  $0.001667(1) = 0.001667$ .

- (c) Since  $y(0.1) = 0.823413$ , the actual error is  $y(0.1) - y_1 = 0.001587$ , which is less than 0.001667.  
 (d) Using the improved Euler method with  $h = 0.05$  we obtain  $y(0.1) \approx y_2 = 0.823781$ .  
 (e) The error in (d) is  $|0.823413 - 0.8237181| = 0.000305$ . With global truncation error  $O(h^2)$ , when the step size is halved we expect the error for  $h = 0.05$  to be one-fourth the error when  $h = 0.1$ . Comparing 0.000305 with 0.001587 we see that this is the case.

17. (a) Using  $y'' = 38e^{-3(x-1)}$  we see that the local truncation error is

$$y''(c) \frac{h^2}{2} = 38e^{-3(c-1)} \frac{h^2}{2} = 19h^2e^{-3(c-1)}.$$

- (b) Since  $e^{-3(x-1)}$  is a decreasing function for  $1 \leq x \leq 1.5$ ,  $e^{-3(c-1)} \leq e^{-3(1-1)} = 1$  for  $1 \leq c \leq 1.5$  and

$$y''(c) \frac{h^2}{2} \leq 19(0.1)^2(1) = 0.19.$$

- (c) Using the Euler method with  $h = 0.1$  we obtain  $y(1.5) \approx 1.8207$ . With  $h = 0.05$  we obtain  $y(1.5) \approx 1.9424$ .  
 (d) Since  $y(1.5) = 2.0532$ , the error for  $h = 0.1$  is  $E_{0.1} = 0.2325$ , while the error for  $h = 0.05$  is  $E_{0.05} = 0.1109$ . With global truncation error  $O(h)$  we expect  $E_{0.1}/E_{0.05} \approx 2$ . We actually have  $E_{0.1}/E_{0.05} = 2.10$ .

18. (a) Using  $y''' = -114e^{-3(x-1)}$  we see that the local truncation error is

$$\left| y'''(c) \frac{h^3}{6} \right| = 114e^{-3(x-1)} \frac{h^3}{6} = 19h^3e^{-3(c-1)}.$$

Exercises 9.1

- (b) Since  $e^{-3(x-1)}$  is a decreasing function for  $1 \leq x \leq 1.5$ ,  $e^{-3(c-1)} \leq e^{-3(1-1)} = 1$  for  $1 \leq c \leq 1.5$  and

$$\left| y'''(c) \frac{h^3}{6} \right| \leq 19(0.1)^3(1) = 0.019.$$

- (c) Using the improved Euler method with  $h = 0.1$  we obtain  $y(1.5) \approx 2.080108$ . With  $h = 0.05$  we obtain  $y(1.5) \approx 2.059166$ .
- (d) Since  $y(1.5) = 2.053216$ , the error for  $h = 0.1$  is  $E_{0.1} = 0.026892$ , while the error for  $h = 0.05$  is  $E_{0.05} = 0.005950$ . With global truncation error  $O(h^2)$  we expect  $E_{0.1}/E_{0.05} \approx 4$ . We actually have  $E_{0.1}/E_{0.05} = 4.52$ .

19. (a) Using  $y'' = -\frac{1}{(x+1)^2}$  we see that the local truncation error is

$$\left| y''(c) \frac{h^2}{2} \right| = \frac{1}{(c+1)^2} \frac{h^2}{2}.$$

- (b) Since  $\frac{1}{(x+1)^2}$  is a decreasing function for  $0 \leq x \leq 0.5$ ,  $\frac{1}{(c+1)^2} \leq \frac{1}{(0+1)^2} = 1$  for  $0 \leq c \leq 0.5$  and

$$\left| y''(c) \frac{h^2}{2} \right| \leq (1) \frac{(0.1)^2}{2} = 0.005.$$

- (c) Using the Euler method with  $h = 0.1$  we obtain  $y(0.5) \approx 0.4198$ . With  $h = 0.05$  we obtain  $y(0.5) \approx 0.4124$ .
- (d) Since  $y(0.5) = 0.4055$ , the error for  $h = 0.1$  is  $E_{0.1} = 0.0143$ , while the error for  $h = 0.05$  is  $E_{0.05} = 0.0069$ . With global truncation error  $O(h)$  we expect  $E_{0.1}/E_{0.05} \approx 2$ . We actually have  $E_{0.1}/E_{0.05} = 2.06$ .

20. (a) Using  $y''' = \frac{2}{(x+1)^3}$  we see that the local truncation error is

$$y'''(c) \frac{h^3}{6} = \frac{1}{(c+1)^3} \frac{h^3}{3}.$$

- (b) Since  $\frac{1}{(x+1)^3}$  is a decreasing function for  $0 \leq x \leq 0.5$ ,  $\frac{1}{(c+1)^3} \leq \frac{1}{(0+1)^3} = 1$  for  $0 \leq c \leq 0.5$  and

$$y'''(c) \frac{h^3}{6} \leq (1) \frac{(0.1)^3}{3} = 0.000333.$$

- (c) Using the improved Euler method with  $h = 0.1$  we obtain  $y(0.5) \approx 0.405281$ . With  $h = 0.05$  we obtain  $y(0.5) \approx 0.405419$ .
- (d) Since  $y(0.5) = 0.405465$ , the error for  $h = 0.1$  is  $E_{0.1} = 0.000184$ , while the error for  $h = 0.05$  is  $E_{0.05} = 0.000046$ . With global truncation error  $O(h^2)$  we expect  $E_{0.1}/E_{0.05} \approx 4$ . We actually have  $E_{0.1}/E_{0.05} = 3.98$ .

### Exercises 9.1

21. Because  $y_{n+1}^*$  depends on  $y_n$  and is used to determine  $y_{n+1}$ , all of the  $y_n^*$  cannot be computed at one time independently of the corresponding  $y_n$  values. For example, the computation of  $y_4^*$  involves the value of  $y_3$ .

---

### Exercises 9.2

---

1.

h = 0.1		
x(n)	y(n)	exact
0.00	2.0000	2.0000
0.10	2.1230	2.1230
0.20	2.3085	2.3085
0.30	2.5958	2.5958
0.40	3.0649	3.0650
0.50	3.9078	3.9082

2. Setting  $\alpha = 1/4$  we find  $b = 2$ ,  $a = -1$  and  $\beta = 1/4$ . The resulting second-order Runge-Kutta method is

$$y_{n+1} = y_n - k_1 + 2k_2$$

$$k_1 = hf(x_n, y_n)$$

$$k_2 = hf(x_n + h/4, y_n + k_1/4).$$

h = 0.1	R-K	IMP EULER
x(n)	y(n)	y(n)
0.00	2.0000	2.0000
0.10	2.1205	2.1220
0.20	2.3006	2.3049
0.30	2.5759	2.5858
0.40	3.0152	3.0378
0.50	3.7693	3.8254

3.

x(n)	y(n)
1.00	5.0000
1.10	3.9724
1.20	3.2284
1.30	2.6945
1.40	2.3163
1.50	2.0533

4.

x(n)	y(n)
0.00	2.0000
0.10	1.6562
0.20	1.4110
0.30	1.2465
0.40	1.1480
0.50	1.1037

5.

x(n)	y(n)
0.00	0.0000
0.10	0.1003
0.20	0.2027
0.30	0.3093
0.40	0.4228
0.50	0.5463

6.

x(n)	y(n)
0.00	1.0000
0.10	1.1115
0.20	1.2530
0.30	1.4397
0.40	1.6961
0.50	2.0670

7.

x(n)	y(n)
0.00	0.0000
0.10	0.0953
0.20	0.1823
0.30	0.2624
0.40	0.3365
0.50	0.4055

8.

x(n)	y(n)
0.00	0.0000
0.10	0.0050
0.20	0.0200
0.30	0.0451
0.40	0.0805
0.50	0.1266

Exercises 9.2

9. 

x(n)	y(n)
0.00	0.5000
0.10	0.5213
0.20	0.5358
0.30	0.5443
0.40	0.5482
0.50	0.5493

10. 

x(n)	y(n)
0.00	1.0000
0.10	1.1079
0.20	1.2337
0.30	1.3807
0.40	1.5531
0.50	1.7561

11. 

x(n)	y(n)
1.00	1.0000
1.10	1.0101
1.20	1.0417
1.30	1.0989
1.40	1.1905
1.50	1.3333

12. 

x(n)	y(n)
0.00	0.5000
0.10	0.5250
0.20	0.5498
0.30	0.5744
0.40	0.5987
0.50	0.6225

13. (a) Write the equation in the form

$$\frac{dv}{dt} = 32 - 0.025v^2 = f(t, v).$$

t(n)	v(n)
0.0	0.0000
1.0	25.2570
2.0	32.9390
3.0	34.9772
4.0	35.5503
5.0	35.7128

(b)  $v(t)$

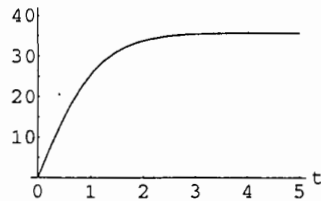

(c) Separating variables and using partial fractions we have

$$\frac{1}{2\sqrt{32}} \left( \frac{1}{\sqrt{32} - \sqrt{0.025}v} + \frac{1}{\sqrt{32} + \sqrt{0.025}v} \right) dv = dt$$

and

$$\frac{1}{2\sqrt{32}\sqrt{0.025}} (\ln|\sqrt{32} + \sqrt{0.025}v| - \ln|\sqrt{32} - \sqrt{0.025}v|) = t + c.$$

Since  $v(0) = 0$  we find  $c = 0$ . Solving for  $v$  we obtain

$$v(t) = \frac{16\sqrt{5}(e^{\sqrt{3.2}t} - 1)}{e^{\sqrt{3.2}t} + 1}$$

and  $v(5) \approx 35.7678$ .

### Exercises 9.2

14. (a) See the table in part (c) of this problem.

(b) From the graph we estimate  $A(1) \approx 1.68$ ,  $A(2) \approx 13.2$ ,  $A(3) \approx 36.8$ ,  $A(4) \approx 46.9$ , and  $A(5) \approx 48.9$ .

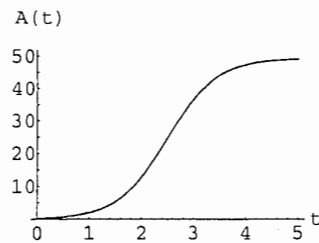

(c) Let  $\alpha = 2.128$  and  $\beta = 0.0432$ . Separating variables we obtain

$$\frac{dA}{A(\alpha - \beta A)} = dt$$

$$\frac{1}{\alpha} \left( \frac{1}{A} + \frac{\beta}{\alpha - \beta A} \right) dA = dt$$

$$\frac{1}{\alpha} [\ln A - \ln(\alpha - \beta A)] = t + c$$

$$\ln \frac{A}{\alpha - \beta A} = \alpha(t + c)$$

$$\frac{A}{\alpha - \beta A} = e^{\alpha(t+c)}$$

$$A = \alpha e^{\alpha(t+c)} - \beta A e^{\alpha(t+c)}$$

$$[1 + \beta e^{\alpha(t+c)}] A = \alpha e^{\alpha(t+c)}$$

Thus

$$A(t) = \frac{\alpha e^{\alpha(t+c)}}{1 + \beta e^{\alpha(t+c)}} = \frac{\alpha}{\beta + e^{-\alpha(t+c)}} = \frac{\alpha}{\beta + e^{-\alpha c} e^{-\alpha t}}$$

From  $A(0) = 0.24$  we obtain

$$0.24 = \frac{\alpha}{\beta + e^{-\alpha c}}$$

so that  $e^{-\alpha c} = \alpha/0.24 - \beta \approx 8.8235$  and

$$A(t) \approx \frac{2.128}{0.0432 + 8.8235e^{-2.128t}}$$

t (days)	1	2	3	4	5
A (observed)	2.78	13.53	36.30	47.50	49.40
A (approximated)	1.93	12.50	36.46	47.23	49.00
A (exact)	1.95	12.64	36.63	47.32	49.02

15. (a)

	h = 0.05	h = 0.1
x(n)	y(n)	y(n)
1.00	1.0000	1.0000
1.05	1.1112	
1.10	1.2511	1.2511
1.15	1.4348	
1.20	1.6934	1.6934
1.25	2.1047	
1.30	2.9560	2.9425
1.35	7.8981	
1.40	1.06E+15	903.0282

(b)

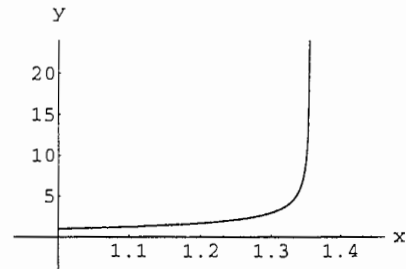

16. (a) Using the fourth-order Runge-Kutta method we obtain  $y(0.1) \approx y_1 = 1.2214$ .

(b) Using  $y^{(5)}(x) = 32e^{2x}$  we see that the local truncation error is

$$y^{(5)}(c) \frac{h^5}{120} = 32e^{2c} \frac{(0.1)^5}{120} = 0.000002667e^{2c}.$$

Since  $e^{2x}$  is an increasing function,  $e^{2c} \leq e^{2(0.1)} = e^{0.2}$  for  $0 \leq c \leq 0.1$ . Thus an upper bound for the local truncation error is  $0.000002667e^{0.2} = 0.000003257$ .

(c) Since  $y(0.1) = e^{0.2} = 1.221402758$ , the actual error is  $y(0.1) - y_1 = 0.000002758$  which is less than  $0.000003257$ .

(d) Using the fourth-order Runge-Kutta formula with  $h = 0.05$  we obtain  $y(0.1) \approx y_2 = 1.221402571$ .

(e) The error in (d) is  $1.221402758 - 1.221402571 = 0.000000187$ . With global truncation error  $O(h^4)$ , when the step size is halved we expect the error for  $h = 0.05$  to be one-sixteenth the error for  $h = 0.1$ . Comparing  $0.000000187$  with  $0.000002758$  we see that this is the case.

17. (a) Using the fourth-order Runge-Kutta method we obtain  $y(0.1) \approx y_1 = 0.823416667$ .

(b) Using  $y^{(5)}(x) = -40e^{-2x}$  we see that the local truncation error is

$$40e^{-2c} \frac{(0.1)^5}{120} = 0.000003333.$$

Since  $e^{-2x}$  is a decreasing function,  $e^{-2c} \leq e^0 = 1$  for  $0 \leq c \leq 0.1$ . Thus an upper bound for the local truncation error is  $0.000003333(1) = 0.000003333$ .

### Exercises 9.2

- (c) Since  $y(0.1) = 0.823413441$ , the actual error is  $|y(0.1) - y_1| = 0.000003225$ , which is less than  $0.000003333$ .
- (d) Using the fourth-order Runge-Kutta method with  $h = 0.05$  we obtain  $y(0.1) \approx y_2 = 0.823413627$ .
- (e) The error in (d) is  $|0.823413441 - 0.823413627| = 0.000000185$ . With global truncation error  $O(h^4)$ , when the step size is halved we expect the error for  $h = 0.05$  to be one-sixteenth the error when  $h = 0.1$ . Comparing  $0.000000185$  with  $0.000003225$  we see that this is the case.

18. (a) Using  $y^{(5)} = -1026e^{-3(x-1)}$  we see that the local truncation error is

$$\left| y^{(5)}(c) \frac{h^5}{120} \right| = 8.55h^5 e^{-3(c-1)}.$$

- (b) Since  $e^{-3(x-1)}$  is a decreasing function for  $1 \leq x \leq 1.5$ ,  $e^{-3(c-1)} \leq e^{-3(1-1)} = 1$  for  $1 \leq c \leq 1.5$  and

$$y^{(5)}(c) \frac{h^5}{120} \leq 8.55(0.1)^5(1) = 0.0000855.$$

- (c) Using the fourth-order Runge-Kutta method with  $h = 0.1$  we obtain  $y(1.5) \approx 2.053338827$ . With  $h = 0.05$  we obtain  $y(1.5) \approx 2.053222989$ .

19. (a) Using  $y^{(5)} = \frac{24}{(x+1)^5}$  we see that the local truncation error is

$$y^{(5)}(c) \frac{h^5}{120} = \frac{1}{(c+1)^5} \frac{h^5}{5}.$$

- (b) Since  $\frac{1}{(x+1)^5}$  is a decreasing function for  $0 \leq x \leq 0.5$ ,  $\frac{1}{(c+1)^5} \leq \frac{1}{(0+1)^5} = 1$  for  $0 \leq c \leq 0.5$  and

$$y^{(5)}(c) \frac{h^5}{5} \leq (1) \frac{(0.1)^5}{5} = 0.000002.$$

- (c) Using the fourth-order Runge-Kutta method with  $h = 0.1$  we obtain  $y(0.5) \approx 0.405465168$ . With  $h = 0.05$  we obtain  $y(0.5) \approx 0.405465111$ .

20. Each step of the Euler method requires only 1 function evaluation, while each step of the improved Euler method requires 2 function evaluations – once at  $(x_n, y_n)$  and again at  $(x_{n+1}, y_{n+1}^*)$ . The second-order Runge-Kutta methods require 2 function evaluations per step, while the fourth-order Runge-Kutta method requires 4 function evaluations per step. To compare the methods we approximate the solution of  $y' = (x + y - 1)^2$ ,  $y(0) = 2$ , at  $x = 0.2$  using  $h = 0.1$  for the Runge-Kutta method,  $h = 0.05$  for the improved Euler method, and  $h = 0.025$  for the Euler method. For each method a total of 8 function evaluations is required. By comparing with the exact solution we see that the fourth-order Runge-Kutta method appears to still give the most accurate result.



$x(n)$	EULER	IMP EUL	R-K	exact
	$h = 0.025$	$h = 0.05$	$h = 0.1$	
0.000	2.0000	2.0000		2.0000
0.025	2.0250			2.0263
0.050	2.0526	2.0553		2.0554
0.075	2.0830			2.0875
0.100	2.1165	2.1228	2.1230	2.1230
0.125	2.1535			2.1624
0.150	2.1943	2.2056		2.2061
0.175	2.2395			2.2546
0.200	2.2895	2.3075	2.3085	2.3085

21. (a) For  $y' + y = 10 \sin 3x$  an integrating factor is  $e^x$  so that

$$\frac{d}{dx}[e^x y] = 10e^x \sin 3x \implies e^x y = e^x \sin 3x - 3e^x \cos 3x + c$$

$$\implies y = \sin 3x - 3 \cos 3x + ce^{-x}.$$

When  $x = 0, y = 0$ , so  $0 = -3 + c$  and  $c = 3$ . The solution is  $y = \sin 3x - 3 \cos 3x + 3e^{-x}$ . Using Newton's method we find that  $x = 1.53235$  is the only positive root in  $[0, 2]$ .

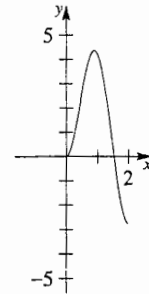

(b) Using the fourth-order Runge-Kutta method with  $h = 0.1$  we obtain the table of values shown. These values are used to obtain an interpolating function in *Mathematica*. The graph of the interpolating function is shown. Using *Mathematica*'s root finding capability we see that the only positive root in  $[0, 2]$  is  $x = 1.53236$ .

$x(n)$	$y(n)$	$x(n)$	$y(n)$
0.0	0.0000	1.0	4.2147
0.1	0.1440	1.1	3.8033
0.2	0.5448	1.2	3.1513
0.3	1.1409	1.3	2.3076
0.4	1.8559	1.4	1.3390
0.5	2.6049	1.5	0.3243
0.6	3.3019	1.6	-0.6530
0.7	3.8675	1.7	-1.5117
0.8	4.2356	1.8	-2.1809
0.9	4.3593	1.9	-2.6061
1.0	4.2147	2.0	-2.7539

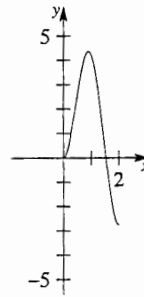

---

**Exercises 9.3**

---

1. For  $y' - y = x - 1$  an integrating factor is  $e^{-\int dx} = e^{-x}$ , so that

$$\frac{d}{dx}[e^{-x}y] = (x - 1)e^{-x}$$

and

$$y = e^x(-xe^{-x} + c) = -x + ce^x.$$

From  $y(0) = 1$  we find  $c = 1$  and  $y = -x + e^x$ . Comparing exact values with approximations obtained in Example 1, we find  $y(0.2) \approx 1.02140276$  compared to  $y_1 = 1.02140000$ ,  $y(0.4) \approx 1.09182470$  compared to  $y_2 = 1.09181796$ ,  $y(0.6) \approx 1.22211880$  compared to  $y_3 = 1.22210646$ , and  $y(0.8) \approx 1.42554093$  compared to  $y_4 = 1.42552788$ .

2. 100 REM ADAMS-BASHFORTH/ADAMS-MOULTON  
 110 REM METHOD TO SOLVE Y'=FNF(X,Y)  
 120 REM DEFINE FNF(X,Y) HERE  
 130 REM GET INPUTS  
 140 PRINT  
 150 INPUT "STEP SIZE=", H  
 160 INPUT "NUMBER OF STEPS (AT LEAST 4)=", N  
 170 IF N < 4 GOTO 160  
 180 INPUT "X0 =", X  
 190 INPUT "Y0 =", Y  
 200 PRINT  
 210 REM SET UP TABLE  
 220 PRINT "X", "Y"  
 230 PRINT  
 240 REM COMPUTE 3 ITERATES USING RUNGE-KUTTA  
 250 DIM Z(4)  
 260 Z(1)=Y  
 270 FOR I=1 TO 3  
 280 K1=H\*FNF(X,Y)  
 290 K2=H\*FNF(X+H/2,Y+K1/2)  
 300 K3=H\*FNF(X+H/2,Y+K2/2)  
 310 K4=H\*FNF(X+H,Y+K3)  
 320 Y=Y+(K1+2\*K2+2\*K3+K4)/6  
 330 Z(I+1)+Y

```

340 X=X+H
350 PRINT X,Y
360 NEXT I
370 REM COMPUTE REMAINING X AND Y VALUES
380 FOR I=4 TO N
390 YP=Y+H*(55*FNF(X,Z(4))-59*FNF(X-H,Z(3))+37*FNF(X-2*H,Z(2))
      -9*FNF(X-3*H,Z(1)))/24
400 Y=Y+H*(9*FNF(X+H,YP)+19*FNF(X,Z(4))-5*FNF(X-H,Z(3))+FNF(X-2*H,Z(2)))/24
410 X=X+H
420 PRINT X,Y
430 Z(1)=Z(2)
440 Z(2)=Z(3)
450 Z(3)=Z(4)
460 Z(4)=Y
470 NEXT I
480 END

```

3.

$x(n)$	$y(n)$	
0.00	1.0000	initial condition
0.20	0.7328	Runge-Kutta
0.40	0.6461	Runge-Kutta
0.60	0.6585	Runge-Kutta
	0.7332	predictor
0.80	0.7232	corrector

4.

$x(n)$	$y(n)$	
0.00	2.0000	initial condition
0.20	1.4112	Runge-Kutta
0.40	1.1483	Runge-Kutta
0.60	1.1039	Runge-Kutta
	1.2109	predictor
0.80	1.2049	corrector

Exercises 9.3

5.

$x(n)$	$y(n)$	
0.00	0.0000	initial condition
0.20	0.2027	Runge-Kutta
0.40	0.4228	Runge-Kutta
0.60	0.6841	Runge-Kutta
	1.0234	<i>predictor</i>
0.80	1.0297	corrector
	1.5376	<i>predictor</i>
1.00	1.5569	corrector

$x(n)$	$y(n)$	
0.00	0.0000	initial condition
0.10	0.1003	Runge-Kutta
0.20	0.2027	Runge-Kutta
0.30	0.3093	Runge-Kutta
	0.4227	<i>predictor</i>
0.40	0.4228	corrector
	0.5462	<i>predictor</i>
0.50	0.5463	corrector
	0.6840	<i>predictor</i>
0.60	0.6842	corrector
	0.8420	<i>predictor</i>
0.70	0.8423	corrector
	1.0292	<i>predictor</i>
0.80	1.0297	corrector
	1.2592	<i>predictor</i>
0.90	1.2603	corrector
	1.5555	<i>predictor</i>
1.00	1.5576	corrector

6.

$x(n)$	$y(n)$	
0.00	1.0000	initial condition
0.20	1.4414	Runge-Kutta
0.40	1.9719	Runge-Kutta
0.60	2.6028	Runge-Kutta
	3.3483	<i>predictor</i>
0.80	3.3486	corrector
	4.2276	<i>predictor</i>
1.00	4.2280	corrector

$x(n)$	$y(n)$	
0.00	1.0000	initial condition
0.10	1.2102	Runge-Kutta
0.20	1.4414	Runge-Kutta
0.30	1.6949	Runge-Kutta
	1.9719	<i>predictor</i>
0.40	1.9719	corrector
	2.2740	<i>predictor</i>
0.50	2.2740	corrector
	2.6028	<i>predictor</i>
0.60	2.6028	corrector
	2.9603	<i>predictor</i>
0.70	2.9603	corrector
	3.3486	<i>predictor</i>
0.80	3.3486	corrector
	3.7703	<i>predictor</i>
0.90	3.7703	corrector
	4.2280	<i>predictor</i>
1.00	4.2280	corrector

Exercises 9.3

7.

$x(n)$	$y(n)$	
0.00	0.0000	initial condition
0.20	0.0026	Runge-Kutta
0.40	0.0201	Runge-Kutta
0.60	0.0630	Runge-Kutta
	0.1362	<i>predictor</i>
0.80	0.1360	corrector
	0.2379	<i>predictor</i>
1.00	0.2385	corrector

$x(n)$	$y(n)$	
0.00	0.0000	initial condition
0.10	0.0003	Runge-Kutta
0.20	0.0026	Runge-Kutta
0.30	0.0087	Runge-Kutta
	0.0201	<i>predictor</i>
0.40	0.0200	corrector
	0.0379	<i>predictor</i>
0.50	0.0379	corrector
	0.0630	<i>predictor</i>
0.60	0.0629	corrector
	0.0956	<i>predictor</i>
0.70	0.0956	corrector
	0.1359	<i>predictor</i>
0.80	0.1360	corrector
	0.1837	<i>predictor</i>
0.90	0.1837	corrector
	0.2384	<i>predictor</i>
1.00	0.2384	corrector

8.

$x(n)$	$y(n)$	
0.00	1.0000	initial condition
0.20	1.2337	Runge-Kutta
0.40	1.5531	Runge-Kutta
0.60	1.9961	Runge-Kutta
	2.6180	<i>predictor</i>
0.80	2.6214	corrector
	3.5151	<i>predictor</i>
1.00	3.5208	corrector

$x(n)$	$y(n)$	
0.00	1.0000	initial condition
0.10	1.1079	Runge-Kutta
0.20	1.2337	Runge-Kutta
0.30	1.3807	Runge-Kutta
	1.5530	<i>predictor</i>
0.40	1.5531	corrector
	1.7560	<i>predictor</i>
0.50	1.7561	corrector
	1.9960	<i>predictor</i>
0.60	1.9961	corrector
	2.2811	<i>predictor</i>
0.70	2.2812	corrector
	2.6211	<i>predictor</i>
0.80	2.6213	corrector
	3.0289	<i>predictor</i>
0.90	3.0291	corrector
	3.5203	<i>predictor</i>
1.00	3.5207	corrector

Exercises 9.4

**Exercises 9.4**

1. The substitution  $y' = u$  leads to the iteration formulas

$$y_{n+1} = y_n + hu_n, \quad u_{n+1} = u_n + h(4u_n - 4y_n).$$

The initial conditions are  $y_0 = -2$  and  $u_0 = 1$ . Then

$$y_1 = y_0 + 0.1u_0 = -2 + 0.1(1) = -1.9$$

$$u_1 = u_0 + 0.1(4u_0 - 4y_0) = 1 + 0.1(4 + 8) = 2.2$$

$$y_2 = y_1 + 0.1u_1 = -1.9 + 0.1(2.2) = -1.68.$$

The general solution of the differential equation is  $y = c_1e^{2x} + c_2xe^{2x}$ . From the initial conditions we find  $c_1 = -2$  and  $c_2 = 5$ . Thus  $y = -2e^{2x} + 5xe^{2x}$  and  $y(0.2) \approx 1.4918$ .

2. The substitution  $y' = u$  leads to the iteration formulas

$$y_{n+1} = y_n + hu_n, \quad u_{n+1} = u_n + h\left(\frac{2}{x}u_n - \frac{2}{x^2}y_n\right).$$

The initial conditions are  $y_0 = 4$  and  $u_0 = 9$ . Then

$$y_1 = y_0 + 0.1u_0 = 4 + 0.1(9) = 4.9$$

$$u_1 = u_0 + 0.1\left(\frac{2}{1}u_0 - \frac{2}{1}y_0\right) = 9 + 0.1[2(9) - 2(4)] = 10$$

$$y_2 = y_1 + 0.1u_1 = 4.9 + 0.1(10) = 5.9.$$

The general solution of the Cauchy-Euler differential equation is  $y = c_1x + c_2x^2$ . From the initial conditions we find  $c_1 = -1$  and  $c_2 = 5$ . Thus  $y = -x + 5x^2$  and  $y(1.2) = 6$ .

3. The substitution  $y' = u$  leads to the system

$$y' = u, \quad u' = 4u - 4y.$$

Using formula (4) in the text with  $x$  corresponding to  $t$ ,  $y$  corresponding to  $x$ , and  $u$  corresponding to  $y$ , we obtain

Runge-Kutta method with h=0.2										
m1	m2	m3	m4	k1	k2	k3	k4	x	y	u
								0.00	-2.0000	1.0000
0.2000	0.4400	0.5280	0.9072	2.4000	3.2800	3.5360	4.8064	0.20	-1.4928	4.4731

Runge-Kutta method with h=0.1										
m1	m2	m3	m4	k1	k2	k3	k4	x	y	u
								0.00	-2.0000	1.0000
0.1000	0.1600	0.1710	0.2452	1.2000	1.4200	1.4520	1.7124	0.10	-1.8321	2.4427
0.2443	0.3298	0.3444	0.4487	1.7099	2.0031	2.0446	2.3900	0.20	-1.4919	4.4753

Exercises 9.4

4. The substitution  $y' = u$  leads to the system

$$y' = u, \quad u' = \frac{2}{x}u - \frac{2}{x^2}y.$$

Using formula (4) in the text with  $x$  corresponding to  $t$ ,  $y$  corresponding to  $x$ , and  $u$  corresponding to  $y$ , we obtain

Runge-Kutta method with h=0.2										
m1	m2	m3	m4	k1	k2	k3	k4	x	y	u
								1.00	4.0000	9.0000
1.8000	2.0000	2.0017	2.1973	2.0000	2.0165	1.9865	1.9950	1.20	6.0001	11.0002

Runge-Kutta method with h=0.1										
m1	m2	m3	m4	k1	k2	k3	k4	x	y	u
								1.00	4.0000	9.0000
0.9000	0.9500	0.9501	0.9998	1.0000	1.0023	0.9979	0.9996	1.10	4.9500	10.0000
1.0000	1.0500	1.0501	1.0998	1.0000	1.0019	0.9983	0.9997	1.20	6.0000	11.0000

5. The substitution  $y' = u$  leads to the system

$$y' = u, \quad u' = 2u - 2y + e^t \cos t.$$

Using formula (4) in the text with  $y$  corresponding to  $x$  and  $u$  corresponding to  $y$ , we obtain

Runge-Kutta method with h=0.2										
m1	m2	m3	m4	k1	k2	k3	k4	t	y	u
								0.00	1.0000	2.0000
0.4000	0.4600	0.4660	0.5320	0.6000	0.6599	0.6599	0.7170	0.20	1.4640	2.6594

Runge-Kutta method with h=0.1										
m1	m2	m3	m4	k1	k2	k3	k4	t	y	u
								0.00	1.0000	2.0000
0.2000	0.2150	0.2157	0.2315	0.3000	0.3150	0.3150	0.3298	0.10	1.2155	2.3150
0.2315	0.2480	0.2487	0.2659	0.3299	0.3446	0.3444	0.3587	0.20	1.4640	2.6594

- 6.

Runge-Kutta method with h=0.1										
m1	m2	m3	m4	k1	k2	k3	k4	t	i1	i2
								0.00	0.0000	0.0000
10.0000	0.0000	12.5000	-20.0000	0.0000	5.0000	-5.0000	22.5000	0.10	2.5000	3.7500
8.7500	-2.5000	13.4375	-28.7500	-5.0000	4.3750	-10.6250	29.6875	0.20	2.8125	5.7813
10.1563	-4.3750	17.0703	-40.0000	-8.7500	5.0781	-16.0156	40.3516	0.30	2.0703	7.4023
13.2617	-6.3672	22.9443	-55.1758	-12.7344	6.6309	-22.5488	55.3076	0.40	0.6104	9.1919
17.9712	-8.8867	31.3507	-75.9326	-17.7734	8.9856	-31.2024	75.9821	0.50	-1.5619	11.4877

### Exercises 9.4

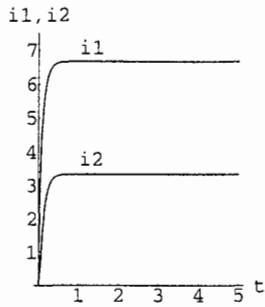

As  $t \rightarrow \infty$  we see that  $i_1(t) \rightarrow 6.75$  and  $i_2(t) \rightarrow 3.4$ .

7.

Runge-Kutta method with  $h=0.2$

$m1$	$m2$	$m3$	$m4$	$k1$	$k2$	$k3$	$k4$	$t$	$x$	$y$
								0.00	6.0000	2.0000
2.0000	2.2800	2.3160	2.6408	1.2000	1.4000	1.4280	1.6632	0.20	8.3055	3.4199

Runge-Kutta method with  $h=0.1$

$m1$	$m2$	$m3$	$m4$	$k1$	$k2$	$k3$	$k4$	$t$	$x$	$y$
								0.00	6.0000	2.0000
1.0000	1.0700	1.0745	1.1496	0.6000	0.6500	0.6535	0.7075	0.10	7.0731	2.6524
1.1494	1.2289	1.2340	1.3193	0.7073	0.7648	0.7688	0.8307	0.20	8.3055	3.4199

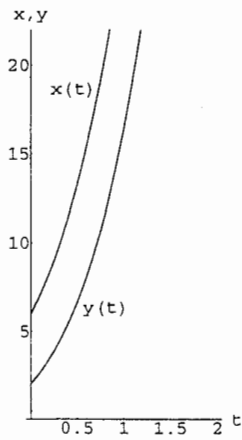



Exercises 9.4

8. Runge-Kutta method with  $h=0.2$

$m_1$	$m_2$	$m_3$	$m_4$	$k_1$	$k_2$	$k_3$	$k_4$	$t$	$x$	$y$
								0.00	1.0000	1.0000
0.6000	0.9400	1.1060	1.7788	1.4000	2.0600	2.3940	3.7212	0.20	2.0785	3.3382

Runge-Kutta method with  $h=0.1$

$m_1$	$m_2$	$m_3$	$m_4$	$k_1$	$k_2$	$k_3$	$k_4$	$t$	$x$	$y$
								0.00	1.0000	1.0000
0.3000	0.3850	0.4058	0.5219	0.7000	0.8650	0.9068	1.1343	0.10	1.4006	1.8963
0.5193	0.6582	0.6925	0.8828	1.1291	1.4024	1.4711	1.8474	0.20	2.0845	3.3502

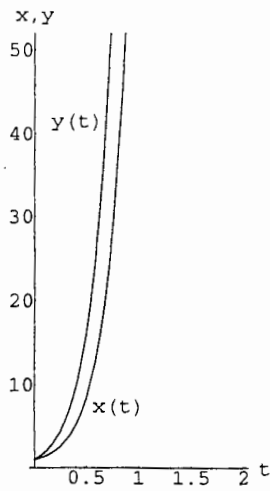

9. Runge-Kutta method with  $h=0.2$

$m_1$	$m_2$	$m_3$	$m_4$	$k_1$	$k_2$	$k_3$	$k_4$	$t$	$x$	$y$
								0.00	-3.0000	5.0000
-1.0000	-0.9200	-0.9080	-0.8176	-0.6000	-0.7200	-0.7120	-0.8216	0.20	-3.9123	4.2857

Runge-Kutta method with  $h=0.1$

$m_1$	$m_2$	$m_3$	$m_4$	$k_1$	$k_2$	$k_3$	$k_4$	$t$	$x$	$y$
								0.00	-3.0000	5.0000
-0.5000	-0.4800	-0.4785	-0.4571	-0.3000	-0.3300	-0.3290	-0.3579	0.10	-3.4790	4.6707
-0.4571	-0.4342	-0.4328	-0.4086	-0.3579	-0.3858	-0.3846	-0.4112	0.20	-3.9123	4.2857

Exercises 9.4

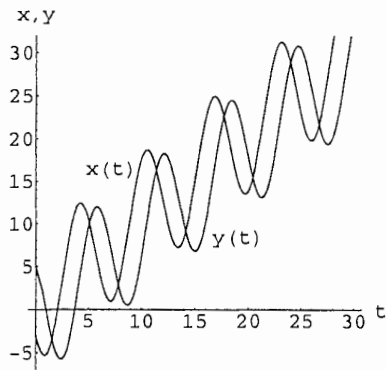

10.

Runge-Kutta method with  $h=0.2$

$m_1$	$m_2$	$m_3$	$m_4$	$k_1$	$k_2$	$k_3$	$k_4$	$t$	$x$	$y$
								0.00	0.5000	0.2000
0.6400	1.2760	1.7028	3.3558	1.3200	1.7720	2.1620	3.5794	0.20	2.1589	2.3279

Runge-Kutta method with  $h=0.1$

$m_1$	$m_2$	$m_3$	$m_4$	$k_1$	$k_2$	$k_3$	$k_4$	$t$	$x$	$y$
								0.00	0.5000	0.2000
0.3200	0.4790	0.5324	0.7816	0.6600	0.7730	0.8218	1.0195	0.10	1.0207	1.0115
0.7736	1.0862	1.1929	1.6862	1.0117	1.2682	1.3692	1.7996	0.20	2.1904	2.3592

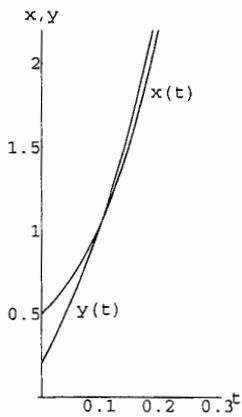

11. Solving for  $x'$  and  $y'$  we obtain the system

$$x' = -2x + y + 5t$$

$$y' = 2x + y - 2t.$$

Exercises 9.4

Runge-Kutta method with h=0.2

m1	m2	m3	m4	k1	k2	k3	k4	t	x	y
								0.00	1.0000	-2.0000
-0.8000	-0.5400	-0.6120	-0.3888	0.0000	-0.2000	-0.1680	-0.3584	0.20	0.4179	-2.1824

Runge-Kutta method with h=0.1

m1	m2	m3	m4	k1	k2	k3	k4	t	x	y
								0.00	1.0000	-2.0000
-0.4000	-0.3350	-0.3440	-0.2858	0.0000	-0.0500	-0.0460	-0.0934	0.10	0.6594	-2.0476
-0.2866	-0.2376	-0.2447	-0.2010	-0.0929	-0.1362	-0.1335	-0.1752	0.20	0.4173	-2.1821

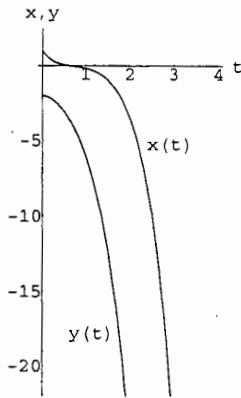

12. Solving for  $x'$  and  $y'$  we obtain the system

$$x' = \frac{1}{2}y - 3t^2 + 2t - 5$$

$$y' = -\frac{1}{2}y + 3t^2 + 2t + 5.$$

Runge-Kutta method with h=0.2

m1	m2	m3	m4	k1	k2	k3	k4	t	x	y
								0.00	3.0000	-1.0000
-1.1000	-1.0110	-1.0115	-0.9349	1.1000	1.0910	1.0915	1.0949	0.20	1.9867	0.0933

Runge-Kutta method with h=0.1

m1	m2	m3	m4	k1	k2	k3	k4	t	x	y
								0.00	3.0000	-1.0000
-0.5500	-0.5270	-0.5271	-0.5056	0.5500	0.5470	0.5471	0.5456	0.10	2.4727	-0.4527
-0.5056	-0.4857	-0.4857	-0.4673	0.5456	0.5457	0.5457	0.5473	0.20	1.9867	0.0933

### Exercises 9.4

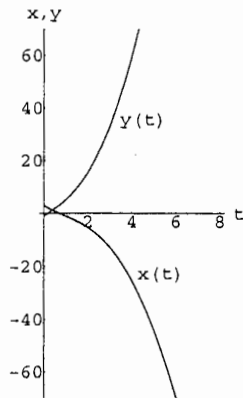

---

### Exercises 9.5

---

1. We identify  $P(x) = 0$ ,  $Q(x) = 9$ ,  $f(x) = 0$ , and  $h = (2 - 0)/4 = 0.5$ . Then the finite difference equation is

$$y_{i+1} + 0.25y_i + y_{i-1} = 0.$$

The solution of the corresponding linear system gives

$x$	0.0	0.5	1.0	1.5	2.0
$y$	4.0000	-5.6774	-2.5807	6.3226	1.0000

2. We identify  $P(x) = 0$ ,  $Q(x) = -1$ ,  $f(x) = x^2$ , and  $h = (1 - 0)/4 = 0.25$ . Then the finite difference equation is

$$y_{i+1} - 2.0625y_i + y_{i-1} = 0.0625x_i^2.$$

The solution of the corresponding linear system gives

$x$	0.00	0.25	0.50	0.75	1.00
$y$	0.0000	-0.0172	-0.0316	-0.0324	0.0000

3. We identify  $P(x) = 2$ ,  $Q(x) = 1$ ,  $f(x) = 5x$ , and  $h = (1 - 0)/5 = 0.2$ . Then the finite difference equation is

$$1.2y_{i+1} - 1.96y_i + 0.8y_{i-1} = 0.04(5x_i).$$

The solution of the corresponding linear system gives

$x$	0.0	0.2	0.4	0.6	0.8	1.0
$y$	0.0000	-0.2259	-0.3356	-0.3308	-0.2167	0.0000

Exercises 9.5

4. We identify  $P(x) = -10$ ,  $Q(x) = 25$ ,  $f(x) = 1$ , and  $h = (1 - 0)/5 = 0.2$ . Then the finite difference equation is

$$-y_i + 2y_{i-1} = 0.04.$$

The solution of the corresponding linear system gives

x	0.0	0.2	0.4	0.6	0.8	1.0
y	1.0000	1.9600	3.8800	7.7200	15.4000	0.0000

5. We identify  $P(x) = -4$ ,  $Q(x) = 4$ ,  $f(x) = (1 + x)e^{2x}$ , and  $h = (1 - 0)/6 = 0.1667$ . Then the finite difference equation is

$$0.6667y_{i+1} - 1.8889y_i + 1.3333y_{i-1} = 0.2778(1 + x_i)e^{2x_i}.$$

The solution of the corresponding linear system gives

x	0.0000	0.1667	0.3333	0.5000	0.6667	0.8333	1.0000
y	3.0000	3.3751	3.6306	3.6448	3.2355	2.1411	0.0000

6. We identify  $P(x) = 5$ ,  $Q(x) = 0$ ,  $f(x) = 4\sqrt{x}$ , and  $h = (2 - 1)/6 = 0.1667$ . Then the finite difference equation is

$$1.4167y_{i+1} - 2y_i + 0.5833y_{i-1} = 0.2778(4\sqrt{x_i}).$$

The solution of the corresponding linear system gives

x	1.0000	1.1667	1.3333	1.5000	1.6667	1.8333	2.0000
y	1.0000	-0.5918	-1.1626	-1.3070	-1.2704	-1.1541	-1.0000

7. We identify  $P(x) = 3/x$ ,  $Q(x) = 3/x^2$ ,  $f(x) = 0$ , and  $h = (2 - 1)/8 = 0.125$ . Then the finite difference equation is

$$\left(1 + \frac{0.1875}{x_i}\right)y_{i+1} + \left(-2 + \frac{0.0469}{x_i^2}\right)y_i + \left(1 - \frac{0.1875}{x_i}\right)y_{i-1} = 0.$$

The solution of the corresponding linear system gives

x	1.000	1.125	1.250	1.375	1.500	1.625	1.750	1.875	2.000
y	5.0000	3.8842	2.9640	2.2064	1.5826	1.0681	0.6430	0.2913	0.0000

8. We identify  $P(x) = -1/x$ ,  $Q(x) = x^{-2}$ ,  $f(x) = \ln x/x^2$ , and  $h = (2 - 1)/8 = 0.125$ . Then the finite difference equation is

$$\left(1 - \frac{0.0625}{x_i}\right)y_{i+1} + \left(-2 + \frac{0.0156}{x_i^2}\right)y_i + \left(1 + \frac{0.0625}{x_i}\right)y_{i-1} = 0.0156 \ln x_i.$$

The solution of the corresponding linear system gives

x	1.000	1.125	1.250	1.375	1.500	1.625	1.750	1.875	2.000
y	0.0000	-0.1988	-0.4168	-0.6510	-0.8992	-1.1594	-1.4304	-1.7109	-2.0000

### Exercises 9.5

9. We identify  $P(x) = 1 - x$ ,  $Q(x) = x$ ,  $f(x) = x$ , and  $h = (1 - 0)/10 = 0.1$ . Then the finite difference equation is

$$[1 + 0.05(1 - x_i)]y_{i+1} + [-2 + 0.01x_i]y_i + [1 - 0.05(1 - x_i)]y_{i-1} = 0.01x_i.$$

The solution of the corresponding linear system gives

x	0.0	0.1	0.2	0.3	0.4	0.5	0.6
y	0.0000	0.2660	0.5097	0.7357	0.9471	1.1465	1.3353

0.7	0.8	0.9	1.0
1.5149	1.6855	1.8474	2.0000

10. We identify  $P(x) = x$ ,  $Q(x) = 1$ ,  $f(x) = x$ , and  $h = (1 - 0)/10 = 0.1$ . Then the finite difference equation is

$$(1 + 0.05x_i)y_{i+1} - 1.99y_i + (1 - 0.05x_i)y_{i-1} = 0.01x_i.$$

The solution of the corresponding linear system gives

x	0.0	0.1	0.2	0.3	0.4	0.5	0.6
y	1.0000	0.8929	0.7789	0.6615	0.5440	0.4296	0.3216

0.7	0.8	0.9	1.0
0.2225	0.1347	0.0601	0.0000

11. We identify  $P(x) = 0$ ,  $Q(x) = -4$ ,  $f(x) = 0$ , and  $h = (1 - 0)/8 = 0.125$ . Then the finite difference equation is

$$y_{i+1} - 2.0625y_i + y_{i-1} = 0.$$

The solution of the corresponding linear system gives

x	0.000	0.125	0.250	0.375	0.500	0.625	0.750	0.875	1.000
y	0.0000	0.3492	0.7202	1.1363	1.6233	2.2118	2.9386	3.8490	5.0000

12. We identify  $P(r) = 2/r$ ,  $Q(r) = 0$ ,  $f(r) = 0$ , and  $h = (4 - 1)/6 = 0.5$ . Then the finite difference equation is

$$\left(1 + \frac{0.5}{r_i}\right)u_{i+1} - 2u_i + \left(1 - \frac{0.5}{r_i}\right)u_{i-1} = 0.$$

The solution of the corresponding linear system gives

r	1.0	1.5	2.0	2.5	3.0	3.5	4.0
u	50.0000	72.2222	83.3333	90.0000	94.4444	97.6190	100.0000

13. (a) The difference equation

$$\left(1 + \frac{h}{2}P_i\right)y_{i+1} + (-2 + h^2Q_i)y_i + \left(1 - \frac{h}{2}P_i\right)y_{i-1} = h^2f_i$$

is the same as the one derived on page 434 in the text. The equations are the same because the derivation was based only on the differential equation, not the boundary conditions. If we

Chapter 9 Review Exercises

allow  $i$  to range from 0 to  $n - 1$  we obtain  $n$  equations in the  $n + 1$  unknowns  $y_{-1}, y_0, y_1, \dots, y_{n-1}$ . Since  $y_n$  is one of the given boundary conditions, it is not an unknown.

- (b) Identifying  $y_0 = y(0)$ ,  $y_{-1} = y(0 - h)$ , and  $y_1 = y(0 + h)$  we have from (5) in the text

$$\frac{1}{2h}[y_1 - y_{-1}] = y'(0) = 1 \quad \text{or} \quad y_1 - y_{-1} = 2h.$$

The difference equation corresponding to  $i = 0$ ,

$$\left(1 + \frac{h}{2}P_0\right)y_1 + (-2 + h^2Q_0)y_0 + \left(1 - \frac{h}{2}P_0\right)y_{-1} = h^2f_0$$

becomes, with  $y_{-1} = y_1 - 2h$ ,

$$\left(1 + \frac{h}{2}P_0\right)y_1 + (-2 + h^2Q_0)y_0 + \left(1 - \frac{h}{2}P_0\right)(y_1 - 2h) = h^2f_0$$

or

$$2y_1 + (-2 + h^2Q_0)y_0 = h^2f_0 + 2h - P_0.$$

Alternatively, we may simply add the equation  $y_1 - y_{-1} = 2h$  to the list of  $n$  difference equations obtaining  $n + 1$  equations in the  $n + 1$  unknowns  $y_{-1}, y_0, y_1, \dots, y_{n-1}$ .

- (c) Using  $n = 5$  we obtain

x	0.0	0.2	0.4	0.6	0.8	1.0
y	-2.2755	-2.0755	-1.8589	-1.6126	-1.3275	-1.0000

14. Using  $h = 0.1$  and, after shooting a few times,  $y'(0) = 0.43535$  we obtain the following table with the fourth-order Runge-Kutta method.

x	0.0	0.1	0.2	0.3	0.4	0.5	0.6
y	1.00000	1.04561	1.09492	1.14714	1.20131	1.25633	1.31096

	0.7	0.8	0.9	1.0
	1.36392	1.41388	1.45962	1.50003

Chapter 9 Review Exercises

1.

h=0.1				h=0.05			
x(n)	EULER	IMPROVED EULER	RUNGE KUTTA	x(n)	EULER	IMPROVED EULER	RUNGE KUTTA
1.00	2.0000	2.0000	2.0000	1.00	2.0000	2.0000	2.0000
1.10	2.1386	2.1549	2.1556	1.05	2.0693	2.0735	2.0736
1.20	2.3097	2.3439	2.3454	1.10	2.1469	2.1554	2.1556
1.30	2.5136	2.5672	2.5695	1.15	2.2328	2.2459	2.2462
1.40	2.7504	2.8246	2.8278	1.20	2.3272	2.3450	2.3454
1.50	3.0201	3.1157	3.1197	1.25	2.4299	2.4527	2.4532
				1.30	2.5409	2.5689	2.5695
				1.35	2.6604	2.6937	2.6944
				1.40	2.7883	2.8269	2.8278
				1.45	2.9245	2.9686	2.9696
				1.50	3.0690	3.1187	3.1197

## Chapter 9 Review Exercises

2.

h=0.1				h=0.05			
x(n)	EULER	IMPROVED EULER	RUNGE KUTTA	x(n)	EULER	IMPROVED EULER	RUNGE KUTTA
0.00	0.0000	0.0000	0.0000	0.00	0.0000	0.0000	0.0000
0.10	0.1000	0.1005	0.1003	0.05	0.0500	0.0501	0.0500
0.20	0.2010	0.2030	0.2026	0.10	0.1001	0.1004	0.1003
0.30	0.3049	0.3092	0.3087	0.15	0.1506	0.1512	0.1511
0.40	0.4135	0.4207	0.4201	0.20	0.2017	0.2027	0.2026
0.50	0.5279	0.5382	0.5376	0.25	0.2537	0.2552	0.2551
				0.30	0.3067	0.3088	0.3087
				0.35	0.3610	0.3638	0.3637
				0.40	0.4167	0.4202	0.4201
				0.45	0.4739	0.4782	0.4781
				0.50	0.5327	0.5378	0.5376

3.

h=0.1				h=0.05			
x(n)	EULER	IMPROVED EULER	RUNGE KUTTA	x(n)	EULER	IMPROVED EULER	RUNGE KUTTA
0.50	0.5000	0.5000	0.5000	0.50	0.5000	0.5000	0.5000
0.60	0.6000	0.6048	0.6049	0.55	0.5500	0.5512	0.5512
0.70	0.7095	0.7191	0.7194	0.60	0.6024	0.6049	0.6049
0.80	0.8283	0.8427	0.8431	0.65	0.6573	0.6609	0.6610
0.90	0.9559	0.9752	0.9757	0.70	0.7144	0.7193	0.7194
1.00	1.0921	1.1163	1.1169	0.75	0.7739	0.7800	0.7801
				0.80	0.8356	0.8430	0.8431
				0.85	0.8996	0.9082	0.9083
				0.90	0.9657	0.9755	0.9757
				0.95	1.0340	1.0451	1.0452
				1.00	1.1044	1.1168	1.1169

4.

h=0.1				h=0.05			
x(n)	EULER	IMPROVED EULER	RUNGE KUTTA	x(n)	EULER	IMPROVED EULER	RUNGE KUTTA
1.00	1.0000	1.0000	1.0000	1.00	1.0000	1.0000	1.0000
1.10	1.2000	1.2380	1.2415	1.05	1.1000	1.1091	1.1095
1.20	1.4760	1.5910	1.6036	1.10	1.2183	1.2405	1.2415
1.30	1.8710	2.1524	2.1909	1.15	1.3595	1.4010	1.4029
1.40	2.4643	3.1458	3.2745	1.20	1.5300	1.6001	1.6036
1.50	3.4165	5.2510	5.8338	1.25	1.7389	1.8523	1.8586
				1.30	1.9988	2.1799	2.1911
				1.35	2.3284	2.6197	2.6401
				1.40	2.7567	3.2360	3.2755
				1.45	3.3296	4.1528	4.2363
				1.50	4.1253	5.6404	5.8446

5. Using

$$y_{n+1} = y_n + hu_n, \quad y_0 = 3$$

$$u_{n+1} = u_n + h(2x_n + 1)y_n, \quad u_0 = 1$$

we obtain (when  $h = 0.2$ )  $y_1 = y(0.2) = y_0 + hu_0 = 3 + (0.2)1 = 3.2$ . When  $h = 0.1$  we have

$$y_1 = y_0 + 0.1u_0 = 3 + (0.1)1 = 3.1$$

$$u_1 = u_0 + 0.1(2x_0 + 1)y_0 = 1 + 0.1(1)3 = 1.3$$

$$y_2 = y_1 + 0.1u_1 = 3.1 + 0.1(1.3) = 3.23.$$



6.

$x(n)$	$y(n)$	
0.00	2.0000	initial condition
0.10	2.4734	Runge-Kutta
0.20	3.1781	Runge-Kutta
0.30	4.3925	Runge-Kutta
	6.7689	predictor
0.40	7.0783	corrector

7. Using  $x_0 = 1$ ,  $y_0 = 2$ , and  $h = 0.1$  we have

$$x_1 = x_0 + h(x_0 + y_0) = 1 + 0.1(1 + 2) = 1.3$$

$$y_1 = y_0 + h(x_0 - y_0) = 2 + 0.1(1 - 2) = 1.9$$

and

$$x_2 = x_1 + h(x_1 + y_1) = 1.3 + 0.1(1.3 + 1.9) = 1.62$$

$$y_2 = y_1 + h(x_1 - y_1) = 1.9 + 0.1(1.3 - 1.9) = 1.84.$$

Thus,  $x(0.2) \approx 1.62$  and  $y(0.2) \approx 1.84$ .

8. We identify  $P(x) = 0$ ,  $Q(x) = 6.55(1 + x)$ ,  $f(x) = 1$ , and  $h = (1 - 0)/10 = 0.1$ . Then the finite difference equation is

$$y_{i+1} + [-2 + 0.0655(1 + x_i)]y_i + y_{i-1} = 0.001$$

or

$$y_{i+1} + (0.0655x_i - 1.9345)y_i + y_{i-1} = 0.001.$$

The solution of the corresponding linear system gives

$x$	0.0	0.1	0.2	0.3	0.4	0.5	0.6
$y$	0.0000	4.1987	8.1049	11.3840	13.7038	14.7770	14.4083

	0.7	0.8	0.9	1.0
	12.5396	9.2847	4.9450	0.0000

# 10 Plane Autonomous Systems and Stability

## Exercises 10.1

---

1. The corresponding plane autonomous system is

$$x' = y, \quad y' = -9 \sin x.$$

If  $(x, y)$  is a critical point,  $y = 0$  and  $-9 \sin x = 0$ . Therefore  $x = \pm n\pi$  and so the critical points are  $(\pm n\pi, 0)$  for  $n = 0, 1, 2, \dots$ .

2. The corresponding plane autonomous system is

$$x' = y, \quad y' = -2x - y^2.$$

If  $(x, y)$  is a critical point, then  $y = 0$  and so  $-2x - y^2 = -2x = 0$ . Therefore  $(0, 0)$  is the sole critical point.

3. The corresponding plane autonomous system is

$$x' = y, \quad y' = x^2 - y(1 - x^3).$$

If  $(x, y)$  is a critical point,  $y = 0$  and so  $x^2 - y(1 - x^3) = x^2 = 0$ . Therefore  $(0, 0)$  is the sole critical point.

4. The corresponding plane autonomous system is

$$x' = y, \quad y' = -4 \frac{x}{1+x^2} - 2y.$$

If  $(x, y)$  is a critical point,  $y = 0$  and so  $-4 \frac{x}{1+x^2} - 2(0) = 0$ . Therefore  $x = 0$  and so  $(0, 0)$  is the sole critical point.

5. The corresponding plane autonomous system is

$$x' = y, \quad y' = -x + \epsilon x^3.$$

If  $(x, y)$  is a critical point,  $y = 0$  and  $-x + \epsilon x^3 = 0$ . Hence  $x(-1 + \epsilon x^2) = 0$  and so  $x = 0, \sqrt{1/\epsilon}, -\sqrt{1/\epsilon}$ . The critical points are  $(0, 0), (\sqrt{1/\epsilon}, 0)$  and  $(-\sqrt{1/\epsilon}, 0)$ .

6. The corresponding plane autonomous system is

$$x' = y, \quad y' = -x + \epsilon x|x|.$$

## Exercises 10.1

If  $(x, y)$  is a critical point,  $y = 0$  and  $-x + \epsilon x|x| = x(-1 + \epsilon|x|) = 0$ . Hence  $x = 0, 1/\epsilon, -1/\epsilon$ . The critical points are  $(0, 0)$ ,  $(1/\epsilon, 0)$  and  $(-1/\epsilon, 0)$ .

7. From  $x + xy = 0$  we have  $x(1 + y) = 0$ . Therefore  $x = 0$  or  $y = -1$ . If  $x = 0$ , then, substituting into  $-y - xy = 0$ , we obtain  $y = 0$ . Likewise, if  $y = -1$ ,  $1 + x = 0$  or  $x = -1$ . We may conclude that  $(0, 0)$  and  $(-1, -1)$  are critical points of the system.
8. From  $y^2 - x = 0$  we have  $x = y^2$ . Substituting into  $x^2 - y = 0$ , we obtain  $y^4 - y = 0$  or  $y(y^3 - 1) = 0$ . It follows that  $y = 0, 1$  and so  $(0, 0)$  and  $(1, 1)$  are the critical points of the system.
9. From  $x - y = 0$  we have  $y = x$ . Substituting into  $3x^2 - 4y = 0$  we obtain  $3x^2 - 4x = x(3x - 4) = 0$ . It follows that  $(0, 0)$  and  $(4/3, 4/3)$  are the critical points of the system.
10. From  $x^3 - y = 0$  we have  $y = x^3$ . Substituting into  $x - y^3 = 0$  we obtain  $x - x^9 = 0$  or  $x(1 - x^8)$ . Therefore  $x = 0, 1, -1$  and so the critical points of the system are  $(0, 0)$ ,  $(1, 1)$ , and  $(-1, -1)$ .
11. From  $x(10 - x - \frac{1}{2}y) = 0$  we obtain  $x = 0$  or  $x + \frac{1}{2}y = 10$ . Likewise  $y(16 - y - x) = 0$  implies that  $y = 0$  or  $x + y = 16$ . We therefore have four cases. If  $x = 0$ ,  $y = 0$  or  $y = 16$ . If  $x + \frac{1}{2}y = 10$ , we may conclude that  $y(-\frac{1}{2}y + 6) = 0$  and so  $y = 0, 12$ . Therefore the critical points of the system are  $(0, 0)$ ,  $(0, 16)$ ,  $(10, 0)$ , and  $(4, 12)$ .
12. Adding the two equations we obtain  $10 - 15\frac{y}{y+5} = 0$ . It follows that  $y = 10$ , and from  $-2x + y + 10 = 0$  we may conclude that  $x = 10$ . Therefore  $(10, 10)$  is the sole critical point of the system.
13. From  $x^2 e^y = 0$  we have  $x = 0$ . Since  $e^x - 1 = e^0 - 1 = 0$ , the second equation is satisfied for an arbitrary value of  $y$ . Therefore any point of the form  $(0, y)$  is a critical point.
14. From  $\sin y = 0$  we have  $y = \pm n\pi$ . From  $e^{x-y} = 1$ , we may conclude that  $x - y = 0$  or  $x = y$ . The critical points of the system are therefore  $(\pm n\pi, \pm n\pi)$  for  $n = 0, 1, 2, \dots$ .
15. From  $x(1 - x^2 - 3y^2) = 0$  we have  $x = 0$  or  $x^2 + 3y^2 = 1$ . If  $x = 0$ , then substituting into  $y(3 - x^2 - 3y^2)$  gives  $y(3 - 3y^2) = 0$ . Therefore  $y = 0, 1, -1$ . Likewise  $x^2 = 1 - 3y^2$  yields  $2y = 0$  so that  $y = 0$  and  $x^2 = 1 - 3(0)^2 = 1$ . The critical points of the system are therefore  $(0, 0)$ ,  $(0, 1)$ ,  $(0, -1)$ ,  $(1, 0)$ , and  $(-1, 0)$ .
16. From  $-x(4 - y^2) = 0$  we obtain  $x = 0$ ,  $y = 2$ , or  $y = -2$ . If  $x = 0$ , then substituting into  $4y(1 - x^2)$  yields  $y = 0$ . Likewise  $y = 2$  gives  $8(1 - x^2) = 0$  or  $x = 1, -1$ . Finally  $y = -2$  yields  $-8(1 - x^2) = 0$  or  $x = 1, -1$ . The critical points of the system are therefore  $(0, 0)$ ,  $(1, 2)$ ,  $(-1, 2)$ ,  $(1, -2)$ , and  $(-1, -2)$ .
17. (a) From Exercises 8.2, Problem 1,  $x = c_1 e^{5t} - c_2 e^{-t}$  and  $y = 2c_1 e^{5t} + c_2 e^{-t}$ .  
 (b) From  $\mathbf{X}(0) = (2, -1)$  it follows that  $c_1 = 0$  and  $c_2 = 2$ . Therefore  $x = -2e^{-t}$  and  $y = 2e^{-t}$ .

### Exercises 10.1

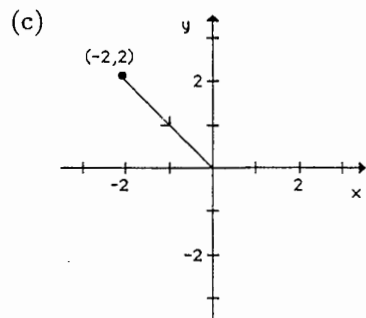

18. (a) From Exercises 8.2, Problem 6,  $x = c_1 + 2c_2e^{-5t}$  and  $y = 3c_1 + c_2e^{-5t}$ .  
 (b) From  $X(0) = (3, 4)$  it follows that  $c_1 = c_2 = 1$ . Therefore  $x = 1 + 2e^{-5t}$  and  $y = 3 + e^{-5t}$ .

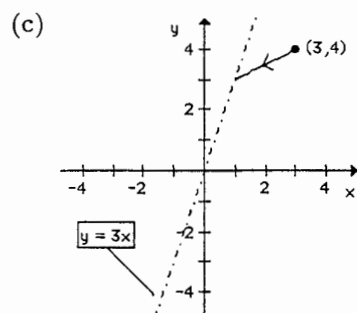

19. (a) From Exercises 8.2, Problem 37,  $x = c_1(4 \cos 3t - 3 \sin 3t) + c_2(4 \sin 3t + 3 \cos 3t)$  and  $y = c_1(5 \cos 3t) + c_2(5 \sin 3t)$ . All solutions are one periodic with  $p = 2\pi/3$ .  
 (b) From  $X(0) = (4, 5)$  it follows that  $c_1 = 1$  and  $c_2 = 0$ . Therefore  $x = 4 \cos 3t - 3 \sin 3t$  and  $y = 5 \cos 3t$ .

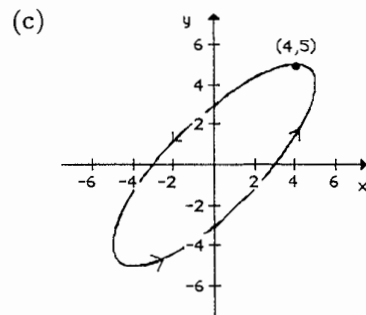

20. (a) From Exercises 8.2, Problem 34,  $x = c_1(\sin t - \cos t) + c_2(-\cos t - \sin t)$  and  $y = 2c_1 \cos t + 2c_2 \sin t$ . All solutions are periodic with  $p = 2\pi$ .  
 (b) From  $X(0) = (-2, 2)$  it follows that  $c_1 = c_2 = 1$ . Therefore  $x = -2 \cos t$  and  $y = 2 \cos t + 2 \sin t$ .

Exercises 10.1

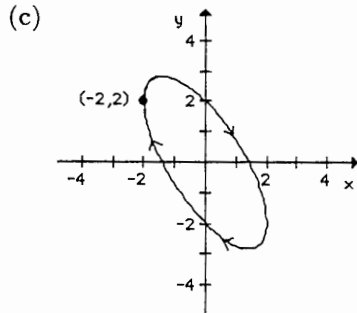

21. (a) From Exercises 8.2, Problem 35,  $x = c_1(\sin t - \cos t)e^{4t} + c_2(-\sin t - \cos t)e^{4t}$  and  $y = 2c_1(\cos t)e^{4t} + 2c_2(\sin t)e^{4t}$ . Because of the presence of  $e^{4t}$ , there are no periodic solutions.

(b) From  $\mathbf{X}(0) = (-1, 2)$  it follows that  $c_1 = 1$  and  $c_2 = 0$ . Therefore  $x = (\sin t - \cos t)e^{4t}$  and  $y = 2(\cos t)e^{4t}$ .

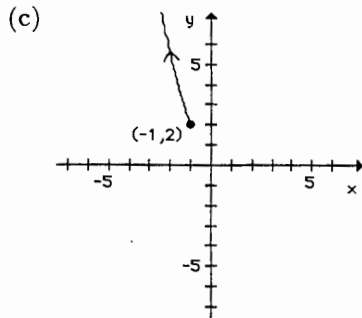

22. (a) From Exercises 8.2, Problem 38,  $x = c_1e^{-t}(2 \cos 2t - 2 \sin 2t) + c_2e^{-t}(2 \cos 2t + 2 \sin 2t)$  and  $y = c_1e^{-t} \cos 2t + c_2e^{-t} \sin 2t$ . Because of the presence of  $e^{-t}$ , there are no periodic solutions.

(b) From  $\mathbf{X}(0) = (2, 1)$  it follows that  $c_1 = 1$  and  $c_2 = 0$ . Therefore  $x = e^{-t}(2 \cos 2t - 2 \sin 2t)$  and  $y = e^{-t} \cos 2t$ .

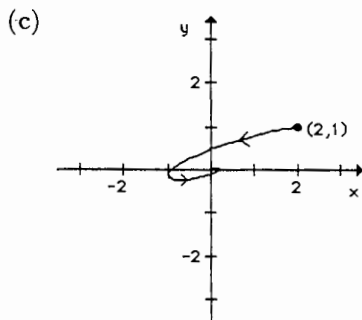

### Exercises 10.1

23. Switching to polar coordinates,

$$\frac{dr}{dt} = \frac{1}{r} \left( x \frac{dx}{dt} + y \frac{dy}{dt} \right) = \frac{1}{r} (-xy - x^2r^4 + xy - y^2r^4) = -r^5$$

$$\frac{d\theta}{dt} = \frac{1}{r^2} \left( -y \frac{dx}{dt} + x \frac{dy}{dt} \right) = \frac{1}{r^2} (y^2 + xyr^4 + x^2 - xyr^4) = 1.$$

If we use separation of variables on  $\frac{dr}{dt} = -r^5$  we obtain

$$r = \left( \frac{1}{4t + c_1} \right)^{1/4} \quad \text{and} \quad \theta = t + c_2.$$

Since  $\mathbf{X}(0) = (4, 0)$ ,  $r = 4$  and  $\theta = 0$  when  $t = 0$ . It follows that  $c_2 = 0$  and  $c_1 = \frac{1}{256}$ . The final solution may be written as

$$r = \frac{4}{\sqrt[4]{1024t + 1}}, \quad \theta = t$$

and so the solution spirals toward the origin as  $t$  increases.

24. Switching to polar coordinates,

$$\frac{dr}{dt} = \frac{1}{r} \left( x \frac{dx}{dt} + y \frac{dy}{dt} \right) = \frac{1}{r} (xy - x^2r^2 - xy + y^2r^2) = r^3$$

$$\frac{d\theta}{dt} = \frac{1}{r^2} \left( -y \frac{dx}{dt} + x \frac{dy}{dt} \right) = \frac{1}{r^2} (-y^2 - xyr^2 - x^2 + xyr^2) = -1.$$

If we use separation of variables, it follows that

$$r = \frac{1}{\sqrt{-2t + c_1}} \quad \text{and} \quad \theta = -t + c_2.$$

Since  $\mathbf{X}(0) = (4, 0)$ ,  $r = 4$  and  $\theta = 0$  when  $t = 0$ . It follows that  $c_2 = 0$  and  $c_1 = \frac{1}{16}$ . The final solution may be written as

$$r = \frac{4}{\sqrt{1 - 32t}}, \quad \theta = -t.$$

Note that  $r \rightarrow \infty$  as  $t \rightarrow \left(\frac{1}{32}\right)^-$ . Because  $0 \leq t \leq \frac{1}{32}$ , the curve is not a spiral.

25. Switching to polar coordinates,

$$\frac{dr}{dt} = \frac{1}{r} \left( x \frac{dx}{dt} + y \frac{dy}{dt} \right) = \frac{1}{r} [-xy + x^2(1 - r^2) + xy + y^2(1 - r^2)] = r(1 - r^2)$$

$$\frac{d\theta}{dt} = \frac{1}{r^2} \left( -y \frac{dx}{dt} + x \frac{dy}{dt} \right) = \frac{1}{r^2} [y^2 - xy(1 - r^2) + x^2 + xy(1 - r^2)] = 1.$$

Now  $\frac{dr}{dt} = r - r^3$  or  $\frac{dr}{dt} - r = -r^3$  is a Bernoulli differential equation. Following the procedure in Section 2.5 of the text, we let  $w = r^{-2}$  so that  $w' = -2r^{-3} \frac{dr}{dt}$ . Therefore  $w' + 2w = 2$ , a linear

Exercises 10.1

first order differential equation. It follows that  $w = 1 + c_1 e^{-2t}$  and so  $r^2 = \frac{1}{1 + c_1 e^{-2t}}$ . The general solution may be written as

$$r = \frac{1}{\sqrt{1 + c_1 e^{-2t}}}, \quad \theta = t + c_2.$$

If  $\mathbf{X}(0) = (1, 0)$ ,  $r = 1$  and  $\theta = 0$  when  $t = 0$ . Therefore  $c_1 = 0 = c_2$  and so  $x = r \cos t = \cos t$  and  $y = r \sin t = \sin t$ . This solution generates the circle  $r = 1$ . If  $\mathbf{X}(0) = (2, 0)$ ,  $r = 2$  and  $\theta = 0$  when  $t = 0$ . Therefore  $c_1 = -3/4$ ,  $c_2 = 0$  and so

$$r = \frac{1}{\sqrt{1 - \frac{3}{4} e^{-2t}}}, \quad \theta = t.$$

This solution spirals toward the circle  $r = 1$  as  $t$  increases.

26. Switching to polar coordinates,

$$\frac{dr}{dt} = \frac{1}{r} \left( x \frac{dx}{dt} + y \frac{dy}{dt} \right) = \frac{1}{r} \left[ xy - \frac{x^2}{r}(4 - r^2) - xy - \frac{y^2}{r}(4 - r^2) \right] = r^2 - 4$$

$$\frac{d\theta}{dt} = \frac{1}{r^2} \left( -y \frac{dx}{dt} + x \frac{dy}{dt} \right) = \frac{1}{r^2} \left[ -y^2 + \frac{xy}{r}(4 - r^2) - x^2 - \frac{xy}{r}(4 - r^2) \right] = -1.$$

From Example 3, Section 2.2,

$$r = 2 \frac{1 + c_1 e^{4t}}{1 - c_1 e^{4t}} \quad \text{and} \quad \theta = -t + c_2.$$

If  $\mathbf{X}(0) = (1, 0)$ ,  $r = 1$  and  $\theta = 0$  when  $t = 0$ . It follows that  $c_2 = 0$  and  $c_1 = -\frac{1}{3}$ . Therefore

$$r = 2 \frac{1 - \frac{1}{3} e^{4t}}{1 + \frac{1}{3} e^{4t}} \quad \text{and} \quad \theta = -t.$$

Note that  $r = 0$  when  $e^{4t} = 3$  or  $t = \frac{\ln 3}{4}$  and  $r \rightarrow -2$  as  $t \rightarrow \infty$ . The solution therefore approaches the circle  $r = 2$ . If  $\mathbf{X}(0) = (2, 0)$ , it follows that  $c_1 = c_2 = 0$ . Therefore  $r = 2$  and  $\theta = -t$  so that the solution generates the circle  $r = 2$  traversed in the clockwise direction. Note also that the original system is not defined at  $(0, 0)$  but the corresponding polar system is defined for  $r = 0$ . If the Runge-Kutta method is applied to the original system, the solution corresponding to  $\mathbf{X}(0) = (1, 0)$  will stall at the origin.

27. The system has no critical points, so there are no periodic solutions.  
 28. From  $x(6y - 1) = 0$  and  $y(2 - 8x) = 0$  we see that  $(0, 0)$  and  $(1/4, 1/6)$  are critical points. From the graph we see that there are periodic solutions around  $(1/4, 1/6)$ .

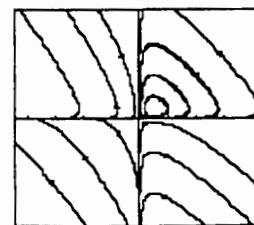

### Exercises 10.1

29. The only critical point is  $(0,0)$ . There appears to be a single periodic solution around  $(0,0)$ .

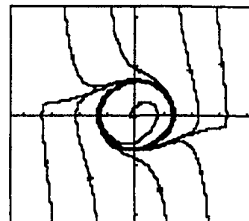

30. The system has no critical points, so there are no periodic solutions.

31. If  $\mathbf{X}(t) = (x(t), y(t))$  is a solution,

$$\frac{d}{dt} f(x(t), y(t)) = \frac{\partial f}{\partial x} \frac{dx}{dt} + \frac{\partial f}{\partial y} \frac{dy}{dt} = QP - PQ = 0,$$

using the chain rule. Therefore  $f(x(t), y(t)) = c$  for some constant  $c$ , and the solution lies on a level curve of  $f$ .

---

### Exercises 10.2

---

1. (a) If  $\mathbf{X}(0) = \mathbf{X}_0$  lies on the line  $y = 2x$ , then  $\mathbf{X}(t)$  approaches  $(0,0)$  along this line. For all other initial conditions,  $\mathbf{X}(t)$  approaches  $(0,0)$  from the direction determined by the line  $y = -x/2$ .

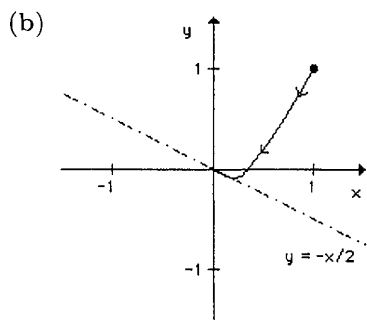

2. (a) If  $\mathbf{X}(0) = \mathbf{X}_0$  lies on the line  $y = -x$ , then  $\mathbf{X}(t)$  becomes unbounded along this line. For all other initial conditions,  $\mathbf{X}(t)$  becomes unbounded and  $y = -3x/2$  serves as an asymptote.



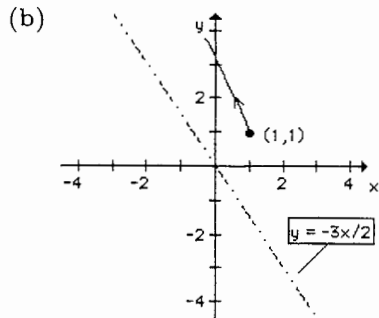

3. (a) All solutions are unstable spirals which become unbounded as  $t$  increases.

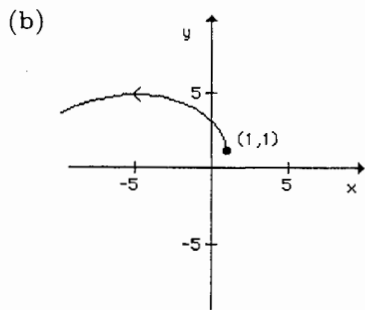

4. (a) All solutions are spirals which approach the origin.

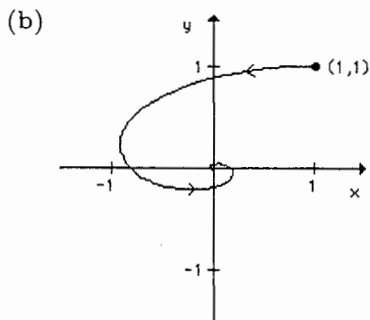

5. (a) All solutions approach  $(0,0)$  from the direction specified by the line  $y = x$ .

Exercises 10.2

(b)

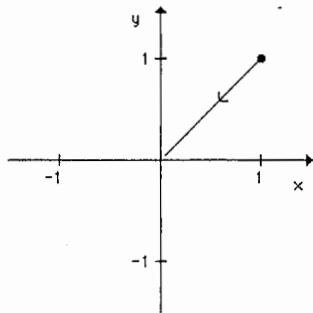

6. (a) All solutions become unbounded and  $y = x/2$  serves as the asymptote.

(b)

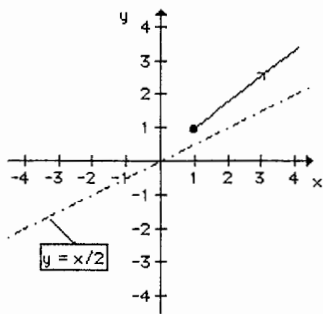

7. (a) If  $\mathbf{X}(0) = \mathbf{X}_0$  lies on the line  $y = 3x$ , then  $\mathbf{X}(t)$  approaches  $(0,0)$  along this line. For all other initial conditions,  $\mathbf{X}(t)$  becomes unbounded and  $y = x$  serves as the asymptote.

(b)

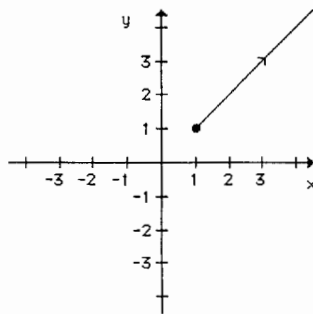

8. (a) The solutions are ellipses which encircle the origin.

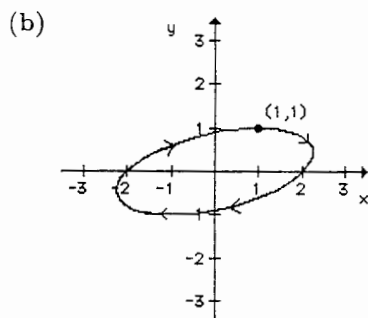

9. Since  $\Delta = -41 < 0$ , we may conclude from Figure 10.18 that  $(0, 0)$  is a saddle point.
10. Since  $\Delta = 29$  and  $\tau = -12$ ,  $\tau^2 - 4\Delta > 0$  and so from Figure 10.18,  $(0, 0)$  is a stable node.
11. Since  $\Delta = -19 < 0$ , we may conclude from Figure 10.18 that  $(0, 0)$  is a saddle point.
12. Since  $\Delta = 1$  and  $\tau = -1$ ,  $\tau^2 - 4\Delta = -3$  and so from Figure 10.18,  $(0, 0)$  is a stable spiral point.
13. Since  $\Delta = 1$  and  $\tau = -2$ ,  $\tau^2 - 4\Delta = 0$  and so from Figure 10.18,  $(0, 0)$  is a degenerate stable node.
14. Since  $\Delta = 1$  and  $\tau = 2$ ,  $\tau^2 - 4\Delta = 0$  and so from Figure 10.18,  $(0, 0)$  is a degenerate unstable node.
15. Since  $\Delta = 0.01$  and  $\tau = -0.03$ ,  $\tau^2 - 4\Delta < 0$  and so from Figure 10.18,  $(0, 0)$  is a stable spiral point.
16. Since  $\Delta = 0.0016$  and  $\tau = 0.08$ ,  $\tau^2 - 4\Delta = 0$  and so from Figure 10.18,  $(0, 0)$  is a degenerate unstable node.
17.  $\Delta = 1 - \mu^2$ ,  $\tau = 0$ , and so we need  $\Delta = 1 - \mu^2 > 0$  for  $(0, 0)$  to be a center. Therefore  $|\mu| < 1$ .
18. Note that  $\Delta = 1$  and  $\tau = \mu$ . Therefore we need both  $\tau = \mu < 0$  and  $\tau^2 - 4\Delta = \mu^2 - 4 < 0$  for  $(0, 0)$  to be a stable spiral point. These two conditions may be written as  $-2 < \mu < 0$ .
19. Note that  $\Delta = \mu + 1$  and  $\tau = \mu + 1$  and so  $\tau^2 - 4\Delta = (\mu + 1)^2 - 4(\mu + 1) = (\mu + 1)(\mu - 3)$ . It follows that  $\tau^2 - 4\Delta < 0$  if and only if  $-1 < \mu < 3$ . We may conclude that  $(0, 0)$  will be a saddle point when  $\mu < -1$ . Likewise  $(0, 0)$  will be an unstable spiral point when  $\tau = \mu + 1 > 0$  and  $\tau^2 - 4\Delta < 0$ . This condition reduces to  $-1 < \mu < 3$ .
20.  $\tau = 2\alpha$ ,  $\Delta = \alpha^2 + \beta^2 > 0$ , and  $\tau^2 - 4\Delta = -4\beta < 0$ . If  $\alpha < 0$ ,  $(0, 0)$  is a stable spiral point. If  $\alpha > 0$ ,  $(0, 0)$  is an unstable spiral point. Therefore  $(0, 0)$  cannot be a node or saddle point.
21.  $\mathbf{A}\mathbf{X}_1 + \mathbf{F} = \mathbf{0}$  implies that  $\mathbf{A}\mathbf{X}_1 = -\mathbf{F}$  or  $\mathbf{X}_1 = -\mathbf{A}^{-1}\mathbf{F}$ . Since  $\mathbf{X}_p(t) = -\mathbf{A}^{-1}\mathbf{F}$  is a particular solution, it follows from Theorem 8.6 that  $\mathbf{X}(t) = \mathbf{X}_c(t) + \mathbf{X}_1$  is the general solution to  $\mathbf{X}' = \mathbf{A}\mathbf{X} + \mathbf{F}$ . If  $\tau < 0$  and  $\Delta > 0$  then  $\mathbf{X}_c(t)$  approaches  $(0, 0)$  by Theorem 10.1(a). It follows that  $\mathbf{X}(t)$  approaches  $\mathbf{X}_1$  as  $t \rightarrow \infty$ .
22. If  $bc < 1$ ,  $\Delta = ad\hat{x}\hat{y}(1 - bc) > 0$  and  $\tau^2 - 4\Delta = (a\hat{x} - d\hat{y})^2 + 4abcd\hat{x}\hat{y} > 0$ . Therefore  $(0, 0)$  is a stable node.

Exercises 10.2

23. (a) The critical point is  $\mathbf{X}_1 = (-3, 4)$ .

(b) From the graph,  $\mathbf{X}_1$  appears to be an unstable node or a saddle point.

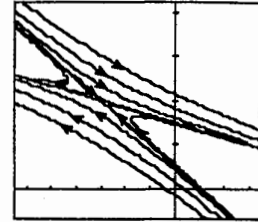

(c) Since  $\Delta = -1$ ,  $(0, 0)$  is a saddle point.

24. (a) The critical point is  $\mathbf{X}_1 = (-1, -2)$ .

(b) From the graph,  $\mathbf{X}_1$  appears to be a stable node or a degenerate stable node.

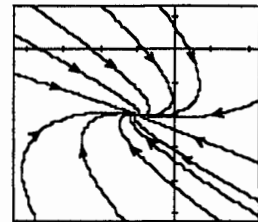

(c) Since  $\tau = -16$ ,  $\Delta = 64$ , and  $\tau^2 - 4\Delta = 0$ ,  $(0, 0)$  is a degenerate stable node.

25. (a) The critical point is  $\mathbf{X}_1 = (0.5, 2)$ .

(b) From the graph,  $\mathbf{X}_1$  appears to be an unstable spiral point.

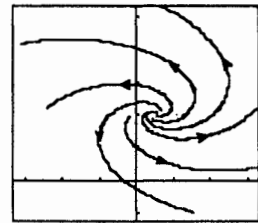

(c) Since  $\tau = 0.2$ ,  $\Delta = 0.03$ , and  $\tau^2 - 4\Delta = -0.08$ ,  $(0, 0)$  is an unstable spiral point.

26. (a) The critical point is  $\mathbf{X}_1 = (1, 1)$ .

(b) From the graph,  $\mathbf{X}_1$  appears to be a center.

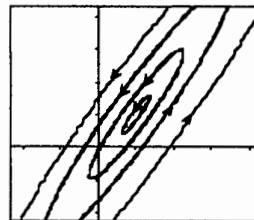

(c) Since  $\tau = 0$  and  $\Delta = 1$ ,  $(0, 0)$  is a center.

---

**Exercises 10.3**

---

1. Switching to polar coordinates,

$$\frac{dr}{dt} = \frac{1}{r} \left( x \frac{dx}{dt} + y \frac{dy}{dt} \right) = \frac{1}{r} (\alpha x^2 - \beta xy + xy^2 + \beta xy + \alpha y^2 - xy^2) = \frac{1}{r} \alpha r^2 = \alpha r.$$

Therefore  $r = ce^{\alpha t}$  and so  $r \rightarrow 0$  if and only if  $\alpha < 0$ .

2. The differential equation  $\frac{dr}{dt} = \alpha r(5 - r)$  is a logistic differential equation. [See Section 3.2, (4) and (5).] It follows that

$$r = \frac{5}{1 + c_1 e^{-5\alpha t}} \quad \text{and} \quad \theta = -t + c_2.$$

If  $\alpha > 0$ ,  $r \rightarrow 5$  as  $t \rightarrow +\infty$  and so the critical point  $(0, 0)$  is unstable. If  $\alpha < 0$ ,  $r \rightarrow 0$  as  $t \rightarrow +\infty$  and so  $(0, 0)$  is asymptotically stable.

3. The critical points are  $x = 0$  and  $x = n + 1$ . Since  $g'(x) = k(n + 1) - 2kx$ ,  $g'(0) = k(n + 1) > 0$  and  $g'(n + 1) = -k(n + 1) < 0$ . Therefore  $x = 0$  is unstable while  $x = n + 1$  is asymptotically stable. See Theorem 10.2.
4. Note that  $x = k$  is the only critical point since  $\ln(x/k)$  is not defined at  $x = 0$ . Since  $g'(x) = -k - k \ln(x/k)$ ,  $g'(k) = -k < 0$ . Therefore  $x = k$  is an asymptotically stable critical point by Theorem 10.2.
5. The only critical point is  $T = T_0$ . Since  $g'(T) = k$ ,  $g'(T_0) = k > 0$ . Therefore  $T = T_0$  is unstable by Theorem 10.2.
6. The only critical point is  $v = mg/k$ . Now  $g(v) = g - (k/m)v$  and so  $g'(v) = -k/m < 0$ . Therefore  $v = mg/k$  is an asymptotically stable critical point by Theorem 10.2.
7. Critical points occur at  $x = \alpha, \beta$ . Since  $g'(x) = k(-\alpha - \beta + 2x)$ ,  $g'(\alpha) = k(\alpha - \beta)$  and  $g'(\beta) = k(\beta - \alpha)$ . Since  $\alpha > \beta$ ,  $g'(\alpha) > 0$  and so  $x = \alpha$  is unstable. Likewise  $x = \beta$  is asymptotically stable.
8. Critical points occur at  $x = \alpha, \beta, \gamma$ . Since

$$g'(x) = k(\alpha - x)(-\beta - \gamma - 2x) + k(\beta - x)(\gamma - x)(-1),$$

$g'(\alpha) = -k(\beta - \alpha)(\gamma - \alpha) < 0$  since  $\alpha > \beta > \gamma$ . Therefore  $x = \alpha$  is asymptotically stable. Similarly  $g'(\beta) > 0$  and  $g'(\gamma) < 0$ . Therefore  $x = \beta$  is unstable while  $x = \gamma$  is asymptotically stable.

9. Critical points occur at  $P = a/b, c$  but not at  $P = 0$ . Since  $g'(P) = (a - bP) + (P - c)(-b)$ ,

$$g'(a/b) = (a/b - c)(-b) = -a + bc \quad \text{and} \quad g'(c) = a - bc.$$

Since  $a < bc$ ,  $-a + bc > 0$  and  $a - bc < 0$ . Therefore  $P = a/b$  is unstable while  $P = c$  is asymptotically stable.

### Exercises 10.3

10. Since  $A > 0$ , the only critical point is  $A = K^2$ . Since  $g'(A) = \frac{1}{2}kKA^{-1/2} - k$ ,  $g'(K^2) = -k/2 < 0$ . Therefore  $A = K^2$  is asymptotically stable.

11. The sole critical point is  $(1/2, 1)$  and

$$\mathbf{g}'(\mathbf{X}) = \begin{pmatrix} -2y & -2x \\ 2y & 2x - 1 \end{pmatrix}.$$

Computing  $\mathbf{g}'((1/2, 1))$  we find that  $\tau = -2$  and  $\Delta = 2$  so that  $\tau^2 - 4\Delta = -4 < 0$ . Therefore  $(1/2, 1)$  is a stable spiral point.

12. Critical points are  $(1, 0)$  and  $(-1, 0)$ , and

$$\mathbf{g}'(\mathbf{X}) = \begin{pmatrix} 2x & -2y \\ 0 & 2 \end{pmatrix}.$$

At  $\mathbf{X} = (1, 0)$ ,  $\tau = 4$ ,  $\Delta = 4$ , and so  $\tau^2 - 4\Delta = 0$ . We may conclude that  $(1, 0)$  is unstable but we are unable to classify this critical point any further. At  $\mathbf{X} = (-1, 0)$ ,  $\Delta = -4 < 0$  and so  $(-1, 0)$  is a saddle point.

13.  $y' = 2xy - y = y(2x - 1)$ . Therefore if  $(x, y)$  is a critical point, either  $x = 1/2$  or  $y = 0$ . The case  $x = 1/2$  and  $y - x^2 + 2 = 0$  implies that  $(x, y) = (1/2, -7/4)$ . The case  $y = 0$  leads to the critical points  $(\sqrt{2}, 0)$  and  $(-\sqrt{2}, 0)$ . We next use the Jacobian matrix

$$\mathbf{g}'(\mathbf{X}) = \begin{pmatrix} -2x & 1 \\ 2y & 2x - 1 \end{pmatrix}$$

to classify these three critical points. For  $\mathbf{X} = (\sqrt{2}, 0)$  or  $(-\sqrt{2}, 0)$ ,  $\tau = -1$  and  $\Delta < 0$ . Therefore both critical points are saddle points. For  $\mathbf{X} = (1/2, -7/4)$ ,  $\tau = -1$ ,  $\Delta = 7/2$  and so  $\tau^2 - 4\Delta = -13 < 0$ . Therefore  $(1/2, -7/4)$  is a stable spiral point.

14.  $y' = -y + xy = y(-1 + x)$ . Therefore if  $(x, y)$  is a critical point, either  $y = 0$  or  $x = 1$ . The case  $y = 0$  and  $2x - y^2 = 0$  implies that  $(x, y) = (0, 0)$ . The case  $x = 1$  leads to the critical points  $(1, \sqrt{2})$  and  $(1, -\sqrt{2})$ . We next use the Jacobian matrix

$$\mathbf{g}'(\mathbf{X}) = \begin{pmatrix} 2 & -2y \\ y & x - 1 \end{pmatrix}$$

to classify these critical points. For  $\mathbf{X} = (0, 0)$ ,  $\Delta = -2 < 0$  and so  $(0, 0)$  is a saddle point. For either  $(1, \sqrt{2})$  or  $(1, -\sqrt{2})$ ,  $\tau = 2$ ,  $\Delta = 4$ , and so  $\tau^2 - 4\Delta = -12$ . Therefore  $(1, \sqrt{2})$  and  $(1, -\sqrt{2})$  are unstable spiral points.

15. Since  $x^2 - y^2 = 0$ ,  $y^2 = x^2$  and so  $x^2 - 3x + 2 = (x - 1)(x - 2) = 0$ . It follows that the critical points are  $(1, 1)$ ,  $(1, -1)$ ,  $(2, 2)$ , and  $(2, -2)$ . We next use the Jacobian

$$\mathbf{g}'(\mathbf{X}) = \begin{pmatrix} -3 & 2y \\ 2x & -2y \end{pmatrix}$$

### Exercises 10.3

to classify these four critical points. For  $\mathbf{X} = (1, 1)$ ,  $\tau = -5$ ,  $\Delta = 2$ , and so  $\tau^2 - 4\Delta = 17 > 0$ . Therefore  $(1, 1)$  is a stable node. For  $\mathbf{X} = (1, -1)$ ,  $\Delta = -2 < 0$  and so  $(1, -1)$  is a saddle point. For  $\mathbf{X} = (2, 2)$ ,  $\Delta = -4 < 0$  and so we have another saddle point. Finally, if  $\mathbf{X} = (2, -2)$ ,  $\tau = 1$ ,  $\Delta = 4$ , and so  $\tau^2 - 4\Delta = -15 < 0$ . Therefore  $(2, -2)$  is an unstable spiral point.

16. From  $y^2 - x^2 = 0$ ,  $y = x$  or  $y = -x$ . The case  $y = x$  leads to  $(4, 4)$  and  $(-1, 1)$  but the case  $y = -x$  leads to  $x^2 - 3x + 4 = 0$  which has no real solutions. Therefore  $(4, 4)$  and  $(-1, 1)$  are the only critical points. We next use the Jacobian matrix

$$\mathbf{g}'(\mathbf{X}) = \begin{pmatrix} y & x - 3 \\ -2x & 2y \end{pmatrix}$$

to classify these two critical points. For  $\mathbf{X} = (4, 4)$ ,  $\tau = 12$ ,  $\Delta = 40$ , and so  $\tau^2 - 4\Delta < 0$ . Therefore  $(4, 4)$  is an unstable spiral point. For  $\mathbf{X} = (-1, 1)$ ,  $\tau = -3$ ,  $\Delta = 10$ , and so  $\tau^2 - 4\Delta < 0$ . It follows that  $(-1, -1)$  is a stable spiral point.

17. Since  $x' = -2xy = 0$ , either  $x = 0$  or  $y = 0$ . If  $x = 0$ ,  $y(1 - y^2) = 0$  and so  $(0, 0)$ ,  $(0, 1)$ , and  $(0, -1)$  are critical points. The case  $y = 0$  leads to  $x = 0$ . We next use the Jacobian matrix

$$\mathbf{g}'(\mathbf{X}) = \begin{pmatrix} -2y & -2x \\ -1 + y & 1 + x - 3y^2 \end{pmatrix}$$

to classify these three critical points. For  $\mathbf{X} = (0, 0)$ ,  $\tau = 1$  and  $\Delta = 0$  and so the test is inconclusive. For  $\mathbf{X} = (0, 1)$ ,  $\tau = -4$ ,  $\Delta = 4$  and so  $\tau^2 - 4\Delta = 0$ . We can conclude that  $(0, 1)$  is a stable critical point but we are unable to classify this critical point further in this borderline case. For  $\mathbf{X} = (0, -1)$ ,  $\Delta = -4 < 0$  and so  $(0, -1)$  is a saddle point.

18. We found that  $(0, 0)$ ,  $(0, 1)$ ,  $(0, -1)$ ,  $(1, 0)$  and  $(-1, 0)$  were the critical points in Exercise 15, Section 10.1. The Jacobian is

$$\mathbf{g}'(\mathbf{X}) = \begin{pmatrix} 1 - 3x^2 - 3y^2 & -6xy \\ -2xy & 3 - x^2 - 9y^2 \end{pmatrix}.$$

For  $\mathbf{X} = (0, 0)$ ,  $\tau = 4$ ,  $\Delta = 3$  and so  $\tau^2 - 4\Delta = 4 > 0$ . Therefore  $(0, 0)$  is an unstable node. Both  $(0, 1)$  and  $(0, -1)$  give  $\tau = -8$ ,  $\Delta = 12$ , and  $\tau^2 - 4\Delta = 16 > 0$ . These two critical points are therefore stable nodes. For  $\mathbf{X} = (1, 0)$  or  $(-1, 0)$ ,  $\Delta = -4 < 0$  and so saddle points occur.

19. We found the critical points  $(0, 0)$ ,  $(10, 0)$ ,  $(0, 16)$  and  $(4, 12)$  in Exercise 11, Section 10.1. Since the Jacobian is

$$\mathbf{g}'(\mathbf{X}) = \begin{pmatrix} 10 - 2x - \frac{1}{2}y & -\frac{1}{2}x \\ -y & 16 - 2y - x \end{pmatrix}$$

### Exercises 10.3

we may classify the critical points as follows:

$\mathbf{X}$	$\tau$	$\Delta$	$\tau^2 - 4\Delta$	Conclusion
(0, 0)	26	160	36	unstable node
(10, 0)	-4	-60	-	saddle point
(0, 16)	-14	-32	-	saddle point
(4, 12)	-16	24	160	stable node

20. We found the sole critical point (10, 10) in Exercise 12, Section 10.1. The Jacobian is

$$\mathbf{g}'(\mathbf{X}) = \begin{pmatrix} -2 & 1 \\ 2 & -1 - \frac{15}{(y+5)^2} \end{pmatrix},$$

$\mathbf{g}'((10, 10))$  has trace  $\tau = -46/15$ ,  $\Delta = 2/15$ , and  $\tau^2 - 4\Delta > 0$ . Therefore (0, 0) is a stable node.

21. The corresponding plane autonomous system is

$$\theta' = y, \quad y' = (\cos \theta - \frac{1}{2}) \sin \theta.$$

Since  $|\theta| < \pi$ , it follows that critical points are (0, 0),  $(\pi/3, 0)$  and  $(-\pi/3, 0)$ . The Jacobian matrix is

$$\mathbf{g}'(\mathbf{X}) = \begin{pmatrix} 0 & 1 \\ \cos 2\theta - \frac{1}{2} \cos \theta & 0 \end{pmatrix}$$

and so at (0, 0),  $\tau = 0$  and  $\Delta = -1/2$ . Therefore (0, 0) is a saddle point. For  $\mathbf{X} = (\pm\pi/3, 0)$ ,  $\tau = 0$  and  $\Delta = 3/4$ . It is not possible to classify either critical point in this borderline case.

22. The corresponding plane autonomous system is

$$x' = y, \quad y' = -x + \left(\frac{1}{2} - 3y^2\right)y - x^2.$$

If  $(x, y)$  is a critical point,  $y = 0$  and so  $-x - x^2 = -x(1 + x) = 0$ . Therefore (0, 0) and (-1, 0) are the only two critical points. We next use the Jacobian matrix

$$\mathbf{g}'(\mathbf{X}) = \begin{pmatrix} 0 & 1 \\ -1 - 2x & \frac{1}{2} - 9y^2 \end{pmatrix}$$

to classify these critical points. For  $\mathbf{X} = (0, 0)$ ,  $\tau = 1/2$ ,  $\Delta = 1$ , and  $\tau^2 - 4\Delta < 0$ . Therefore (0, 0) is an unstable spiral point. For  $\mathbf{X} = (-1, 0)$ ,  $\tau = 1/2$ ,  $\Delta = -1$  and so (-1, 0) is a saddle point.

23. The corresponding plane autonomous system is

$$x' = y, \quad y' = x^2 - y(1 - x^3)$$

and the only critical point is (0, 0). Since the Jacobian matrix is

$$\mathbf{g}'(\mathbf{X}) = \begin{pmatrix} 0 & 1 \\ 2x + 3x^2y & x^3 - 1 \end{pmatrix},$$



$\tau = -1$  and  $\Delta = 0$ , and we are unable to classify the critical point in this borderline case.

24. The corresponding plane autonomous system is

$$x' = y, \quad y' = -\frac{4x}{1+x^2} - 2y$$

and the only critical point is  $(0, 0)$ . Since the Jacobian matrix is

$$\mathbf{g}'(\mathbf{X}) = \begin{pmatrix} 0 & 1 \\ -4\frac{1-x^2}{(1+x^2)^2} & -2 \end{pmatrix},$$

$\tau = -2$ ,  $\Delta = 4$ ,  $\tau^2 - 4\Delta = -12$ , and so  $(0, 0)$  is a stable spiral point.

25. In Exercise 5, Section 10.1, we showed that  $(0, 0)$ ,  $(\sqrt{1/\epsilon}, 0)$  and  $(-\sqrt{1/\epsilon}, 0)$  are the critical points. We will use the Jacobian matrix

$$\mathbf{g}'(\mathbf{X}) = \begin{pmatrix} 0 & 1 \\ -1 + 3\epsilon x^2 & 0 \end{pmatrix}$$

to classify these three critical points. For  $\mathbf{X} = (0, 0)$ ,  $\tau = 0$  and  $\Delta = 1$  and we are unable to classify this critical point. For  $(\pm\sqrt{1/\epsilon}, 0)$ ,  $\tau = 0$  and  $\Delta = -2$  and so both of these critical points are saddle points.

26. In Exercise 6, Section 10.1, we showed that  $(0, 0)$ ,  $(1/\epsilon, 0)$ , and  $(-1/\epsilon, 0)$  are the critical points. Since  $D_x x|x| = 2|x|$ , the Jacobian matrix is

$$\mathbf{g}'(\mathbf{X}) = \begin{pmatrix} 0 & 1 \\ 2\epsilon|x| - 1 & 0 \end{pmatrix}.$$

For  $\mathbf{X} = (0, 0)$ ,  $\tau = 0$ ,  $\Delta = 1$  and we are unable to classify this critical point. For  $(\pm 1/\epsilon, 0)$ ,  $\tau = 0$ ,  $\Delta = -1$ , and so both of these critical points are saddle points.

27. The corresponding plane autonomous system is

$$x' = y, \quad y' = -\frac{(\beta + \alpha^2 y^2)x}{1 + \alpha^2 x^2}$$

and the Jacobian matrix is

$$\mathbf{g}'(\mathbf{X}) = \begin{pmatrix} 0 & 1 \\ \frac{(\beta + \alpha y^2)(\alpha^2 x^2 - 1)}{(1 + \alpha^2 x^2)^2} & \frac{-2\alpha^2 yx}{1 + \alpha^2 x^2} \end{pmatrix}.$$

For  $\mathbf{X} = (0, 0)$ ,  $\tau = 0$  and  $\Delta = \beta$ . Since  $\beta < 0$ , we may conclude that  $(0, 0)$  is a saddle point.

28. From  $x' = -\alpha x + xy = x(-\alpha + y) = 0$ , either  $x = 0$  or  $y = \alpha$ . If  $x = 0$ , then  $1 - \beta y = 0$  and so  $y = 1/\beta$ . The case  $y = \alpha$  implies that  $1 - \beta\alpha - x^2 = 0$  or  $x^2 = 1 - \alpha\beta$ . Since  $\alpha\beta > 1$ , this equation has no real solutions. It follows that  $(0, 1/\beta)$  is the unique critical point. Since the Jacobian matrix is

$$\mathbf{g}'(\mathbf{X}) = \begin{pmatrix} -\alpha + y & x \\ -2x & -\beta \end{pmatrix},$$

### Exercises 10.3

$\tau = -\alpha - \beta + \frac{1}{\beta} = -\beta + \frac{1 - \alpha\beta}{\beta} < 0$  and  $\Delta = \alpha\beta - 1 > 0$ . Therefore  $(0, 1/\beta)$  is a stable critical point.

29. (a) The graphs of  $-x + y - x^3 = 0$  and  $-x - y + y^2 = 0$  are shown in the figure. The Jacobian matrix is

$$\mathbf{g}'(\mathbf{X}) = \begin{pmatrix} -1 - 3x^2 & 1 \\ -1 & -1 + 2y \end{pmatrix}.$$

For  $\mathbf{X} = (0, 0)$ ,  $\tau = -2$ ,  $\Delta = 2$ ,  $\tau^2 - 4\Delta = -4$ , and so  $(0, 0)$  is a stable spiral point.

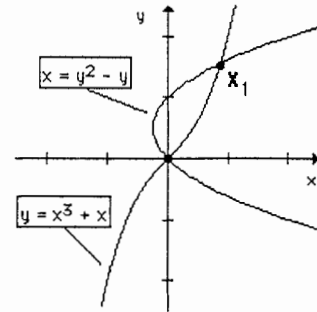

- (b) For  $\mathbf{X}_1$ ,  $\Delta = -6.07 < 0$  and so a saddle point occurs at  $\mathbf{X}_1$ .

30. (a) The corresponding plane autonomous system is

$$x' = y, \quad y' = \epsilon(y - \frac{1}{3}y^3) - x$$

and so the only critical point is  $(0, 0)$ . Since the Jacobian matrix is

$$\mathbf{g}'(\mathbf{X}) = \begin{pmatrix} 0 & 1 \\ -1 & \epsilon(1 - y^2) \end{pmatrix},$$

$\tau = \epsilon$ ,  $\Delta = 1$ , and so  $\tau^2 - 4\Delta = \epsilon^2 - 4$  at the critical point  $(0, 0)$ .

- (b) When  $\tau = \epsilon > 0$ ,  $(0, 0)$  is an unstable critical point.

- (c) When  $\epsilon < 0$  and  $\tau^2 - 4\Delta = \epsilon^2 - 4 < 0$ ,  $(0, 0)$  is a stable spiral point. These two requirements can be written as  $-2 < \epsilon < 0$ .

- (d) When  $\epsilon = 0$ ,  $x'' + x = 0$  and so  $x = c_1 \cos t + c_2 \sin t$ . Therefore all solutions are periodic (with period  $2\pi$ ) and so  $(0, 0)$  is a center.

31.  $\frac{dy}{dx} = \frac{y'}{x'} = \frac{-2x^3}{y}$  may be solved by separating variables. It follows that  $y^2 + x^4 = c$ . If  $\mathbf{X}(0) = (x_0, 0)$  where  $x_0 > 0$ , then  $c = x_0^4$  so that  $y^2 = x_0^4 - x^4$ . Therefore if  $-x_0 < x < x_0$ ,  $y^2 > 0$  and so there are two values of  $y$  corresponding to each value of  $x$ . Therefore the solution  $\mathbf{X}(t)$  with  $\mathbf{X}(0) = (x_0, 0)$  is periodic and so  $(0, 0)$  is a center.

32.  $\frac{dy}{dx} = \frac{y'}{x'} = \frac{x^2 - 2x}{y}$  may be solved by separating variables. It follows that  $\frac{y^2}{2} = \frac{x^3}{3} - x^2 + c$  and since  $\mathbf{X}(0) = (x(0), x'(0)) = (1, 0)$ ,  $c = \frac{2}{3}$ . Therefore

$$\frac{y^2}{2} = \frac{x^3 - 3x^2 + 2}{3} = \frac{(x-1)(x^2 - 2x - 2)}{3}.$$

Exercises 10.3

But  $(x-1)(x^2-2x-2) > 0$  for  $1-\sqrt{3} < x < 1$  and so each  $x$  in this interval has 2 corresponding values of  $y$ . therefore  $\mathbf{X}(t)$  is a periodic solution.

33. (a)  $x' = 2xy = 0$  implies that either  $x = 0$  or  $y = 0$ . If  $x = 0$ , then from  $1 - x^2 + y^2 = 0$ ,  $y^2 = -1$  and there are no real solutions. If  $y = 0$ ,  $1 - x^2 = 0$  and so  $(1, 0)$  and  $(-1, 0)$  are critical points. The Jacobian matrix is

$$\mathbf{g}'(\mathbf{X}) = \begin{pmatrix} 2y & 2x \\ -2x & 2y \end{pmatrix}$$

and so  $\tau = 0$  and  $\Delta = 4$  at either  $\mathbf{X} = (1, 0)$  or  $(-1, 0)$ . We obtain no information about these critical points in this borderline case.

- (b)  $\frac{dy}{dx} = \frac{y'}{x'} = \frac{1-x^2+y^2}{2xy}$  or  $2xy \frac{dy}{dx} = 1-x^2+y^2$ . Letting  $\mu = \frac{y^2}{x}$ , it follows that  $\frac{d\mu}{dx} = \frac{1}{x^2} - 1$  and so  $\mu = -\frac{1}{x} - x + 2c$ . Therefore  $\frac{y^2}{x} = -\frac{1}{x} - x + 2c$  which can be put in the form  $(x-c)^2 + y^2 = c^2 - 1$ .

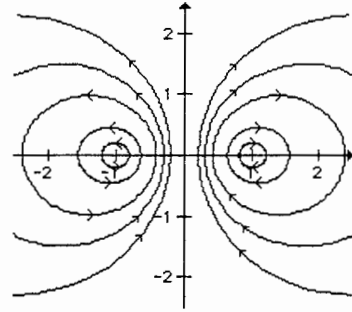

The solution curves are shown and so both  $(1, 0)$  and  $(-1, 0)$  are centers.

34. (a)  $\frac{dy}{dx} = \frac{y'}{x'} = \frac{-x-y^2}{y} = -\frac{x}{y} - y$  and so  $\frac{dy}{dx} + y = -xy^{-1}$ .  
 (b) Let  $w = y^{1-n} = y^2$ . It follows that  $\frac{dw}{dx} + 2w = -2x$ , a linear first order differential equation whose solution is

$$y^2 = w = ce^{-2x} + \left(\frac{1}{2} - x\right).$$

Since  $x(0) = \frac{1}{2}$  and  $y(0) = x'(0) = 0$ ,  $0 = c$  and so

$$y^2 = \frac{1}{2} - x,$$

a parabola with vertex at  $(1/2, 0)$ . Therefore the solution  $\mathbf{X}(t)$  with  $\mathbf{X}(0) = (1/2, 0)$  is not periodic.

35.  $\frac{dy}{dx} = \frac{y'}{x'} = \frac{x^3-x}{y}$  and so  $\frac{y^2}{2} = \frac{x^4}{4} - \frac{x^2}{2} + c$  or  $y^2 = \frac{x^4}{2} - x^2 + c_1$ . Since  $x(0) = 0$  and  $y(0) = x'(0) = v_0$ , it follows that  $c_1 = v_0^2$  and so

### Exercises 10.3

$$y^2 = \frac{1}{2}x^4 - x^2 + v_0^2 = \frac{(x^2 - 1)^2 + 2v_0^2 - 1}{2}.$$

The  $x$ -intercepts on this graph satisfy

$$x^2 = 1 \pm \sqrt{1 - 2v_0^2}$$

and so we must require that  $1 - 2v_0^2 \geq 0$  (or  $|v_0| \leq \frac{1}{2}\sqrt{2}$ ) for real solutions to exist. If  $x_0^2 = 1 - \sqrt{1 - 2v_0^2}$  and  $-x_0 < x < x_0$ , then  $(x^2 - 1)^2 + 2v_0^2 - 1 > 0$  and so there are two corresponding values of  $y$ . Therefore  $\mathbf{X}(t)$  with  $\mathbf{X}(0) = (0, v_0)$  is periodic provided that  $|v_0| \leq \frac{1}{2}\sqrt{2}$ .

36. The corresponding plane autonomous system is

$$x' = y, \quad y' = \epsilon x^2 - x + 1$$

and so the critical points must satisfy  $y = 0$  and

$$x = \frac{1 \pm \sqrt{1 - 4\epsilon}}{2\epsilon}.$$

Therefore we must require that  $\epsilon \leq \frac{1}{4}$  for real solutions to exist. We will use the Jacobian matrix

$$\mathbf{g}'(\mathbf{X}) = \begin{pmatrix} 0 & 1 \\ 2\epsilon x - 1 & 0 \end{pmatrix}$$

to attempt to classify  $((1 \pm \sqrt{1 - 4\epsilon})/2\epsilon, 0)$  when  $\epsilon \leq 1/4$ . Note that  $\tau = 0$  and  $\Delta = \mp \sqrt{1 - 4\epsilon}$ . For  $\mathbf{X} = ((1 + \sqrt{1 - 4\epsilon})/2\epsilon, 0)$  and  $\epsilon < 1/4$ ,  $\Delta < 0$  and so a saddle point occurs. For  $\mathbf{X} = ((1 - \sqrt{1 - 4\epsilon})/2\epsilon, 0)$ ,  $\Delta \geq 0$  and we are not able to classify this critical point using linearization.

37. The corresponding plane autonomous system is

$$x' = y, \quad y' = -\frac{\alpha}{L}x - \frac{\beta}{L}x^3 - \frac{R}{L}y$$

where  $x = q$  and  $y = q'$ . If  $\mathbf{X} = (x, y)$  is a critical point,  $y = 0$  and  $-\alpha x - \beta x^3 = -x(\alpha + \beta x^2) = 0$ . If  $\beta > 0$ ,  $\alpha + \beta x^2 = 0$  has no real solutions and so  $(0, 0)$  is the only critical point. Since

$$\mathbf{g}'(\mathbf{X}) = \begin{pmatrix} 0 & 1 \\ \frac{-\alpha - 3\beta x^2}{L} & -\frac{R}{L} \end{pmatrix},$$

$\tau = -R/L < 0$  and  $\Delta = \alpha/L > 0$ . Therefore  $(0, 0)$  is a stable critical point. If  $\beta < 0$ ,  $(0, 0)$  and  $(\pm \hat{x}, 0)$ , where  $\hat{x}^2 = -\alpha/\beta$  are critical points. At  $\mathbf{X}(\pm \hat{x}, 0)$ ,  $\tau = -R/L < 0$  and  $\Delta = -2\alpha/L < 0$ . Therefore both critical points are saddles.

38. If we let  $dx/dt = y$ , then  $dy/dt = -x^3 - x$ . From this we obtain the first-order differential equation

$$\frac{dy}{dx} = \frac{dy/dt}{dx/dt} = -\frac{x^3 + x}{y}.$$

Separating variables and integrating we obtain

$$\int y \, dy = - \int (x^3 + x) \, dx$$

and

$$\frac{1}{2}y^2 = -\frac{1}{4}x^4 - \frac{1}{2}x^2 + c_1.$$

Completing the square we can write the solution as  $y^2 = -\frac{1}{2}(x^2 + 1)^2 + c_2$ . If  $\mathbf{X}(0) = (x_0, 0)$ , then  $c_2 = \frac{1}{2}(x_0^2 + 1)^2$  and so

$$\begin{aligned} y^2 &= -\frac{1}{2}(x^2 + 1)^2 + \frac{1}{2}(x_0^2 + 1)^2 = \frac{x_0^4 + 2x_0^2 + 1 - x^4 - 2x^2 - 1}{2} \\ &= \frac{(x_0^2 + x^2)(x_0^2 - x^2) + 2(x_0^2 - x^2)}{2} = \frac{(x_0^2 + x^2 + 2)(x_0^2 - x^2)}{2}. \end{aligned}$$

Note that  $y = 0$  when  $x = -x_0$ . In addition, the right-hand side is positive for  $-x_0 < x < x_0$ , and so there are two corresponding values of  $y$  for each  $x$  between  $-x_0$  and  $x_0$ . The solution  $\mathbf{X} = \mathbf{X}(t)$  that satisfies  $\mathbf{X}(0) = (x_0, 0)$  is therefore periodic, and so  $(0, 0)$  is a center.

39. (a) Letting  $x = \theta$  and  $y = x'$  we obtain the system  $x' = y$  and  $y' = 1/2 - \sin x$ . Since  $\sin \pi/6 = \sin 5\pi/6 = 1/2$  we see that  $(\pi/6, 0)$  and  $(5\pi/6, 0)$  are critical points of the system.
- (b) The Jacobian matrix is

$$\mathbf{g}'(\mathbf{X}) = \begin{pmatrix} 0 & 1 \\ -\cos x & 0 \end{pmatrix}$$

and so

$$\mathbf{A}_1 = \mathbf{g}'((\pi/6, 0)) = \begin{pmatrix} 0 & 1 \\ -\sqrt{3}/2 & 0 \end{pmatrix} \quad \text{and} \quad \mathbf{A}_2 = \mathbf{g}'((5\pi/6, 0)) = \begin{pmatrix} 0 & 1 \\ \sqrt{3}/2 & 0 \end{pmatrix}.$$

Since  $\det \mathbf{A}_1 > 0$  and the trace of  $\mathbf{A}_1$  is 0, no conclusion can be drawn regarding the critical point  $(\pi/6, 0)$ . Since  $\det \mathbf{A}_2 < 0$ , we see that  $(5\pi/6, 0)$  is a saddle point.

- (c) From the system in part (a) we obtain the first-order differential equation

$$\frac{dy}{dx} = \frac{1/2 - \sin x}{y}.$$

Separating variables and integrating we obtain

$$\int y \, dy = \int \left( \frac{1}{2} - \sin x \right) dx$$

and

$$\frac{1}{2}y^2 = \frac{1}{2}x + \cos x + c_1$$

or

$$y^2 = x + 2 \cos x + c_2.$$

### Exercises 10.3

For  $x_0$  near  $\pi/6$ , if  $\mathbf{X}(0) = (x_0, 0)$  then  $c_2 = -x_0 - 2\cos x_0$  and  $y^2 = x + 2\cos x - x_0 - 2\cos x_0$ . Thus, there are two values of  $y$  for each  $x$  in a sufficiently small interval around  $\pi/6$ . Therefore  $(\pi/6, 0)$  is a center.

40. (a) Writing the system as  $x' = x(x^3 - 2y^3)$  and  $y' = y(2x^3 - y^3)$  we see that  $(0, 0)$  is a critical point. Setting  $x^3 - 2y^3 = 0$  we have  $x^3 = 2y^3$  and  $2x^3 - y^3 = 4y^3 - y^3 = 3y^3$ . Thus,  $(0, 0)$  is the only critical point of the system.

(b) From the system we obtain the first-order differential equation

$$\frac{dy}{dx} = \frac{2x^3y - y^4}{x^4 - 2xy^3}$$

or

$$(2x^3y - y^4) dx + (2xy^3 - x^4) dy = 0$$

which is homogeneous. If we let  $y = ux$  it follows that

$$(2x^4u - x^4u^4) dx + (2x^4u^3 - x^4)(u dx + x du) = 0$$

$$x^4u(1 + u^3) dx + x^5(2u^3 - 1) du = 0$$

$$\frac{1}{x} dx + \frac{2u^3 - 1}{u(u^3 + 1)} du = 0$$

$$\frac{1}{x} dx + \left( \frac{1}{u+1} - \frac{1}{u} + \frac{2u-1}{u^2-u+1} \right) du = 0.$$

Integrating gives

$$\ln|x| + \ln|u+1| - \ln|u| + \ln|u^2-u+1| = c_1$$

or

$$x \left( \frac{u+1}{u} \right) (u^2 - u + 1) = c_2$$

$$x \left( \frac{y+x}{y} \right) \left( \frac{y^2}{x^2} - \frac{y}{x} + 1 \right) = c_2$$

$$(xy + x^2)(y^2 - xy + x^2) = c_2x^2y$$

$$xy^3 + x^4 = c_2x^2y$$

$$x^3 + y^2 = 3c_3xy.$$

- (c) We see from the graph that  $(0, 0)$  is unstable. It is not possible to classify the critical point as a node, saddle, center, or spiral point.

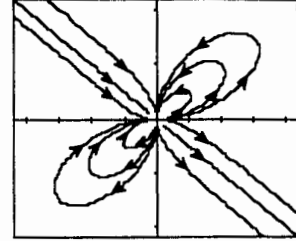

### Exercises 10.4

1. We are given that  $x(0) = \theta(0) = \frac{\pi}{3}$  and  $y(0) = \theta'(0) = w_0$ . Since  $y^2 = \frac{2g}{l} \cos x + c$ ,  $w_0^2 = \frac{2g}{l} \cos \frac{\pi}{3} + c = \frac{g}{l} + c$  and so  $c = w_0^2 - \frac{g}{l}$ . Therefore

$$y^2 = \frac{2g}{l} \left( \cos x - \frac{1}{2} + \frac{l}{2g} w_0^2 \right)$$

and the  $x$ -intercepts occur where  $\cos x = \frac{1}{2} - \frac{l}{2g} w_0^2$  and so  $\frac{1}{2} - \frac{l}{2g} w_0^2$  must be greater than  $-1$  for solutions to exist. This condition is equivalent to  $|w_0| < \sqrt{\frac{3g}{l}}$ .

2. (a) Since  $y^2 = \frac{2g}{l} \cos x + c$ ,  $x(0) = \theta(0) = \theta_0$  and  $y(0) = \theta'(0) = 0$ ,  $c = -\frac{2g}{l} \cos \theta_0$  and so  $y^2 = \frac{2g}{l} (\cos \theta - \cos \theta_0)$ . When  $\theta = -\theta_0$ ,  $y^2 = \frac{2g}{l} (\cos(-\theta_0) - \cos(\theta_0)) = 0$ . Therefore  $y = \frac{d\theta}{dt} = 0$  when  $\theta = \theta_0$ .

- (b) Since  $y = \frac{d\theta}{dt}$  and  $\theta$  is decreasing between the time when  $\theta = \theta_0$ ,  $t = 0$ , and  $\theta = -\theta_0$ , that is,  $t = T$ ,

$$\frac{d\theta}{dt} = -\sqrt{\frac{2g}{l}} \sqrt{\cos \theta - \cos \theta_0}.$$

Therefore  $\frac{dt}{d\theta} = -\sqrt{\frac{l}{2g}} \frac{1}{\sqrt{\cos \theta - \cos \theta_0}}$  and so

$$T = -\sqrt{\frac{l}{2g}} \int_{\theta=\theta_0}^{\theta=-\theta_0} \frac{1}{\sqrt{\cos \theta - \cos \theta_0}} d\theta = \sqrt{\frac{l}{2g}} \int_{-\theta_0}^{\theta_0} \frac{1}{\sqrt{\cos \theta - \cos \theta_0}} d\theta.$$

3. The corresponding plane autonomous system is

$$x' = y, \quad y' = -g \frac{f'(x)}{1 + [f'(x)]^2} - \frac{\beta}{m} y$$

### Exercises 10.4

and

$$\frac{\partial}{\partial x} \left( -g \frac{f'(x)}{1 + [f'(x)]^2} - \frac{\beta}{m} y \right) = -g \frac{(1 + [f'(x)]^2) f''(x) - f'(x) 2f'(x) f''(x)}{(1 + [f'(x)]^2)^2}.$$

If  $\mathbf{X}_1 = (x_1, y_1)$  is a critical point,  $y_1 = 0$  and  $f'(x_1) = 0$ . The Jacobian at this critical point is therefore

$$\mathbf{g}'(\mathbf{X}_1) = \begin{pmatrix} 0 & 1 \\ -g f''(x_1) & -\frac{\beta}{m} \end{pmatrix}.$$

4. When  $\beta = 0$  the Jacobian matrix is

$$\begin{pmatrix} 0 & 1 \\ -g f''(x_1) & 0 \end{pmatrix}$$

which has complex eigenvalues  $\lambda = \pm \sqrt{g f''(x_1)} i$ . The approximating linear system with  $x'(0) = 0$  has solution

$$x(t) = x(0) \cos \sqrt{g f''(x_1)} t$$

and period  $2\pi/\sqrt{g f''(x_1)}$ . Therefore  $p \approx 2\pi/\sqrt{g f''(x_1)}$  for the actual solution.

5. (a) If  $f(x) = \frac{x^2}{2}$ ,  $f'(x) = x$  and so

$$\frac{dy}{dx} = \frac{y'}{x'} = -g \frac{x}{1 + x^2} \frac{1}{y}.$$

We may separate variables to show that  $y^2 = -g \ln(1 + x^2) + c$ . But  $x(0) = x_0$  and  $y(0) = x'(0) = v_0$ . Therefore  $c = v_0^2 + g \ln(1 + x_0^2)$  and so

$$y^2 = v_0^2 - g \ln \left( \frac{1 + x^2}{1 + x_0^2} \right).$$

Now

$$v_0^2 - g \ln \left( \frac{1 + x^2}{1 + x_0^2} \right) \geq 0 \quad \text{if and only if} \quad x^2 \leq e^{v_0^2/g} (1 + x_0^2) - 1.$$

Therefore, if  $|x| \leq [e^{v_0^2/g} (1 + x_0^2) - 1]^{1/2}$ , there are two values of  $y$  for a given value of  $x$  and so the solution is periodic.

- (b) Since  $z = \frac{x^2}{2}$ , the maximum height occurs at the largest value of  $x$  on the cycle. From (a),  $x_{\max} = [e^{v_0^2/g} (1 + x_0^2) - 1]^{1/2}$  and so

$$z_{\max} = \frac{x_{\max}^2}{2} = \frac{1}{2} [e^{v_0^2/g} (1 + x_0^2) - 1].$$

6. (a) If  $f(x) = \cosh x$ ,  $f'(x) = \sinh x$  and  $[f'(x)]^2 + 1 = \sinh^2 x + 1 = \cosh^2 x$ . Therefore

$$\frac{dy}{dx} = \frac{y'}{x'} = -g \frac{\sinh x}{\cosh^2 x} \frac{1}{y}.$$



We may separate variables to show that  $y^2 = \frac{2g}{\cosh x} + c$ . But  $x(0) = x_0$  and  $y(0) = x'(0) = v_0$ .

Therefore  $c = v_0^2 - \frac{2g}{\cosh x_0}$  and so

$$y^2 = \frac{2g}{\cosh x} - \frac{2g}{\cosh x_0} + v_0^2.$$

Now

$$\frac{2g}{\cosh x} - \frac{2g}{\cosh x_0} + v_0^2 \geq 0 \quad \text{if and only if} \quad \cosh x \leq \frac{2g \cosh x_0}{2g - v_0^2 \cosh x_0}$$

and the solution to this inequality is an interval  $[-a, a]$ . Therefore each  $x$  in  $(-a, a)$  has two corresponding values of  $y$  and so the solution is periodic.

(b) Since  $z = \cosh x$ , the maximum height occurs at the largest value of  $x$  on the cycle. From (a),

$x_{\max} = a$  where  $\cosh a = \frac{2g \cosh x_0}{2g - v_0^2 \cosh x_0}$ . Therefore

$$z_{\max} = \frac{2g \cosh x_0}{2g - v_0^2 \cosh x_0}.$$

7. If  $x_m < x_1 < x_n$ , then  $F(x_1) > F(x_m) = F(x_n)$ . Letting  $x = x_1$ ,

$$G(y) = \frac{c_0}{F(x_1)} = \frac{F(x_m)G(a/b)}{F(x_1)} < G(a/b).$$

Therefore from (2) on page 474,  $G(y) = \frac{c_0}{F(x_1)}$  has two solutions  $y_1$  and  $y_2$  that satisfy  $y_1 < a/b < y_2$ .

8. From (1), when  $y = a/b$ ,  $x_n$  is taken on at some time  $t$ . From (3), if  $x > x_n$  there is no corresponding value of  $y$ . Therefore the maximum number of predators is  $x_n$  and  $x_n$  occurs when  $y = a/b$ .

9. (a) In the Lotka-Volterra Model the average number of predators is  $d/c$  and the average number of prey is  $a/b$ . But

$$x' = -ax + bxy - \epsilon_1 x = -(a + \epsilon_1)x + bxy$$

$$y' = -cxy + dy - \epsilon_2 y = -cxy + (d - \epsilon_2)y$$

and so the new critical point in the first quadrant is  $(d/c - \epsilon_2/c, a/b + \epsilon_1/b)$ .

(b) The average number of predators  $d/c - \epsilon_2/c$  has decreased while the average number of prey  $a/b + \epsilon_1/b$  has increased. The fishery science model is consistent with Volterra's principle.

### Exercises 10.4

10. (a) Solving

$$x(-0.1 + 0.02y) = 0$$

$$y(0.2 - 0.025x) = 0$$

in the first quadrant we obtain the critical point  $(8, 5)$ . The graphs are plotted using  $x(0) = 7$  and  $y(0) = 4$ .

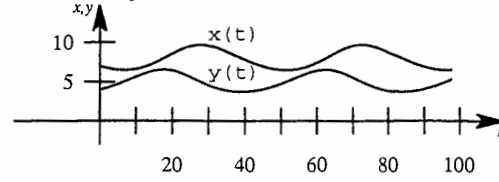

(b) The graph in part (a) was obtained using `NDSolve` in *Mathematica*. We see that the period is around 40. Since  $x(0) = 7$ , we use the `FindRoot` equation solver in *Mathematica* to approximate the solution of  $x(t) = 7$  for  $t$  near 40. From this we see that the period is more closely approximated by  $t = 44.65$ .

11. Solving

$$x(20 - 0.4x - 0.3y) = 0$$

$$y(10 - 0.1y - 0.3x) = 0$$

we see that critical points are  $(0, 0)$ ,  $(0, 100)$ ,  $(50, 0)$ , and  $(20, 40)$ . The Jacobian matrix is

$$\mathbf{g}'(\mathbf{X}) = \begin{pmatrix} 0.08(20 - 0.8x - 0.3y) & -0.024x \\ -0.018y & 0.06(10 - 0.2y - 0.3x) \end{pmatrix}$$

and so

$$\mathbf{A}_1 = \mathbf{g}'((0, 0)) = \begin{pmatrix} 1.6 & 0 \\ 0 & 0.6 \end{pmatrix}$$

$$\mathbf{A}_2 = \mathbf{g}'((0, 100)) = \begin{pmatrix} -0.8 & 0 \\ -1.8 & -0.6 \end{pmatrix}$$

$$\mathbf{A}_3 = \mathbf{g}'((50, 0)) = \begin{pmatrix} -1.6 & -1.2 \\ 0 & -0.3 \end{pmatrix}$$

$$\mathbf{A}_4 = \mathbf{g}'((20, 40)) = \begin{pmatrix} -0.64 & -0.48 \\ -0.72 & -0.24 \end{pmatrix}$$

Since  $\det(\mathbf{A}_1) = \Delta_1 = 0.96 > 0$ ,  $\tau = 2.2 > 0$ , and  $\tau_1^2 - 4\Delta_1 = 1 > 0$ , we see that  $(0, 0)$  is an unstable node. Since  $\det(\mathbf{A}_2) = \Delta_2 = 0.48 > 0$ ,  $\tau = -1.4 < 0$ , and  $\tau_2^2 - 4\Delta_2 = 0.04 > 0$ , we see that  $(0, 100)$  is a stable node. Since  $\det(\mathbf{A}_3) = \Delta_3 = 0.48 > 0$ ,  $\tau = -1.9 < 0$ , and  $\tau_3^2 - 4\Delta_3 = 1.69 > 0$ , we see that  $(50, 0)$  is a stable node. Since  $\det(\mathbf{A}_4) = -0.192 < 0$  we see that  $(20, 40)$  is a saddle point.

12.  $\Delta = r_1 r_2$ ,  $\tau = r_1 + r_2$  and  $\tau^2 - 4\Delta = (r_1 + r_2)^2 - 4r_1 r_2 = (r_1 - r_2)^2$ . Therefore when  $r_1 \neq r_2$ ,  $(0, 0)$  is an unstable node.

13. For  $\mathbf{X} = (K_1, 0)$ ,  $\tau = -r_1 + r_2 \left(1 - \frac{K_1}{K_2} \alpha_{21}\right)$  and  $\Delta = -r_1 r_2 \left(1 - \frac{K_1}{K_2} \alpha_{21}\right)$ . If we let  $c = 1 - \frac{K_1}{K_2} \alpha_{21}$ ,  $\tau^2 - 4\Delta = (cr_2 + r_1)^2 > 0$ . Now if  $k_1 > \frac{K_2}{\alpha_{21}}$ ,  $c < 0$  and so  $\tau < 0$ ,  $\Delta > 0$ . Therefore  $(K_1, 0)$  is a stable node. If  $K_1 < \frac{K_2}{\alpha_{21}}$ ,  $c > 0$  and so  $\Delta < 0$ . In this case  $(K_1, 0)$  is a saddle point.

Exercises 10.4

14.  $(\hat{x}, \hat{y})$  is a stable node if and only if  $\frac{K_1}{\alpha_{12}} > K_2$  and  $\frac{K_2}{\alpha_{21}} > K_1$ . [See Figure 10.38(a) in the text.]  
 From Problem 12,  $(0,0)$  is an unstable node and from Problem 13, since  $K_1 < \frac{K_2}{\alpha_{21}}$ ,  $(K_1, 0)$  is a saddle point. Finally, when  $K_2 < \frac{K_1}{\alpha_{12}}$ ,  $(0, K_2)$  is a saddle point. This is Problem 12 with the roles of 1 and 2 interchanged. Therefore  $(0, 0)$ ,  $(K_1, 0)$ , and  $(0, K_2)$  are unstable.
15.  $\frac{K_1}{\alpha_{12}} < K_2 < K_1\alpha_{21}$  and so  $\alpha_{12}\alpha_{21} > 1$ . Therefore  $\Delta = (1 - \alpha_{12}\alpha_{21})\hat{x}\hat{y} \frac{\tau_1\tau_2}{K_1K_2} < 0$  and so  $(\hat{x}, \hat{y})$  is a saddle point.
16. (a) The corresponding plane autonomous system is

$$x' = y, \quad y' = -\frac{g}{l} \sin x - \frac{\beta}{ml} y$$

and so critical points must satisfy both  $y = 0$  and  $\sin x = 0$ . Therefore  $(\pm n\pi, 0)$  are critical points.

- (b) The Jacobian matrix

$$\begin{pmatrix} 0 & 1 \\ -\frac{g}{l} \cos x & -\frac{\beta}{ml} \end{pmatrix}$$

has trace  $\tau = -\frac{\beta}{ml}$  and determinant  $\Delta = \frac{g}{l} > 0$  at  $(0, 0)$ . Therefore

$$\tau^2 - 4\Delta = \frac{\beta^2}{m^2l^2} - 4\frac{g}{l} = \frac{\beta^2 - 4glm^2}{m^2l^2}.$$

We may conclude that  $(0, 0)$  is a stable spiral point provided  $\beta^2 - 4glm^2 < 0$  or  $\beta < 2m\sqrt{gl}$ .

17. (a) The corresponding plane autonomous system is

$$x' = y, \quad y' = -\frac{\beta}{m} y|y| - \frac{k}{m} x$$

and so a critical point must satisfy both  $y = 0$  and  $x = 0$ . Therefore  $(0, 0)$  is the unique critical point.

- (b) The Jacobian matrix is

$$\begin{pmatrix} 0 & 1 \\ -\frac{k}{m} & -\frac{\beta}{m} 2|y| \end{pmatrix}$$

and so  $\tau = 0$  and  $\Delta = \frac{k}{m} > 0$ . Therefore  $(0, 0)$  is a center, stable spiral point, or an unstable spiral point. Physical considerations suggest that  $(0, 0)$  must be asymptotically stable and so  $(0, 0)$  must be a stable spiral point.

### Exercises 10.4

18. (a) The magnitude of the frictional force between the bead and the wire is  $\mu(mg \cos \theta)$  for some  $\mu > 0$ . The component of this frictional force in the  $x$ -direction is

$$(\mu mg \cos \theta) \cos \theta = \mu mg \cos^2 \theta.$$

But

$$\cos \theta = \frac{1}{\sqrt{1 + [f'(x)]^2}} \quad \text{and so} \quad \mu mg \cos^2 \theta = \frac{\mu mg}{1 + [f'(x)]^2}.$$

It follows from Newton's Second Law that

$$mx'' = -mg \frac{f'(x)}{1 + [f'(x)]^2} - \beta x' + mg \frac{\mu}{1 + [f'(x)]^2}$$

and so

$$x'' = g \frac{\mu - f'(x)}{1 + [f'(x)]^2} - \frac{\beta}{m} x'.$$

- (b) A critical point  $(x, y)$  must satisfy  $y = 0$  and  $f'(x) = \mu$ . Therefore critical points occur at  $(x_1, 0)$  where  $f'(x_1) = \mu$ . The Jacobian matrix of the plane autonomous system is

$$\mathbf{g}'(\mathbf{X}) = \begin{pmatrix} 0 & 1 \\ g \frac{(1 + [f'(x)]^2)(-f''(x)) - (\mu - f'(x))2f'(x)f''(x)}{(1 + [f'(x)]^2)^2} & -\frac{\beta}{m} \end{pmatrix}$$

and so at a critical point  $\mathbf{X}_1$ ,

$$\mathbf{g}'(\mathbf{X}) = \begin{pmatrix} 0 & 1 \\ -\frac{gf''(x_1)}{1 + \mu^2} & -\frac{\beta}{m} \end{pmatrix}.$$

Therefore  $\tau = -\frac{\beta}{m} < 0$  and  $\Delta = \frac{gf''(x_1)}{1 + \mu^2}$ . When  $f''(x_1) < 0$ ,  $\Delta < 0$  and so a saddle point occurs. When  $f''(x_1) > 0$  and

$$\tau^2 - 4\Delta = \frac{\beta^2}{m^2} - 4g \frac{f''(x_1)}{1 + \mu^2} < 0,$$

$(x_1, 0)$  is a stable spiral point. This condition may also be written as

$$\beta^2 < 4gm^2 \frac{f''(x_1)}{1 + \mu^2}.$$

19.  $\frac{dy}{dx} = \frac{y'}{x'} = -\frac{f(x)}{y}$  and so using separation of variables,  $\frac{y^2}{2} = -\int_0^x f(\mu) d\mu + c$  or  $y^2 + 2F(x) = c$ . We may conclude that for a given value of  $x$  there are at most two corresponding values of  $y$ . If  $(0, 0)$  were a stable spiral point there would exist an  $x$  with more than two corresponding values of  $y$ . Note that the condition  $f(0) = 0$  is required for  $(0, 0)$  to be a critical point of the corresponding plane autonomous system  $x' = y$ ,  $y' = -f(x)$ .

20. (a)  $x' = x(-a + by) = 0$  implies that  $x = 0$  or  $y = a/b$ . If  $x = 0$ , then, from

$$-cxy + \frac{r}{K}y(K - y) = 0,$$

$y = 0$  or  $K$ . Therefore  $(0, 0)$  and  $(0, K)$  are critical points. If  $\hat{y} = a/b$ , then

$$\hat{y} \left[ -cx + \frac{r}{K}(K - \hat{y}) \right] = 0.$$

The corresponding value of  $x$ ,  $x = \hat{x}$ , therefore satisfies the equation  $c\hat{x} = \frac{r}{K}(K - \hat{y})$ .

(b) The Jacobian matrix is

$$\mathbf{g}'(\mathbf{X}) = \begin{pmatrix} -a + by & bx \\ -cy & -cx + \frac{r}{K}(K - 2y) \end{pmatrix}$$

and so at  $\mathbf{X}_1 = (0, 0)$ ,  $\Delta = -ar < 0$ . For  $\mathbf{X}_1 = (0, K)$ ,  $\Delta = n(Kb - a) = -rb \left( K - \frac{a}{b} \right)$ . Since we are given that  $K > \frac{a}{b}$ ,  $\Delta < 0$  in this case. Therefore  $(0, 0)$  and  $(0, K)$  are each saddle points. For  $\mathbf{X}_1 = (\hat{x}, \hat{y})$  where  $\hat{y} = \frac{a}{b}$  and  $c\hat{x} = \frac{r}{K}(K - \hat{y})$ , we may write the Jacobian matrix as

$$\mathbf{g}'((\hat{x}, \hat{y})) = \begin{pmatrix} 0 & b\hat{x} \\ -c\hat{y} & -\frac{r}{K}\hat{y} \end{pmatrix}$$

and so  $\tau = -\frac{r}{K}\hat{y} < 0$  and  $\Delta = bc\hat{x}\hat{y} > 0$ . Therefore  $(\hat{x}, \hat{y})$  is a stable critical point and so it is either a stable node (perhaps degenerate) or a stable spiral point.

(c) Write

$$\tau^2 - 4\Delta = \frac{r^2}{K^2}\hat{y}^2 - 4bc\hat{x}\hat{y} = \hat{y} \left[ \frac{r^2}{K^2}\hat{y} - 4bc\hat{x} \right] = \hat{y} \left[ \frac{r^2}{K^2}\hat{y} - 4b\frac{r}{K}(K - \hat{y}) \right]$$

using

$$c\hat{x} = \frac{r}{K}(K - \hat{y}) = \frac{r}{K}\hat{y} \left[ \left( \frac{r}{K} + 4b \right) \hat{y} - 4bK \right].$$

Therefore  $\tau^2 - 4\Delta < 0$  if and only if

$$\hat{y} < \frac{4bK}{\frac{r}{K} + 4b} = \frac{4bK^2}{r + 4bK}.$$

Note that

$$\frac{4bK^2}{r + 4bK} = \frac{4bK}{r + 4bK} \cdot K \approx K$$

where  $K$  is large, and  $\hat{y} = \frac{a}{b} < K$ . Therefore  $\tau^2 - 4\Delta < 0$  when  $K$  is large and a stable spiral point will result.

### Exercises 10.4

21. The equation

$$x' = \alpha \frac{y}{1+y} x - x = x \left( \frac{\alpha y}{1+y} - 1 \right) = 0$$

implies that  $x = 0$  or  $y = \frac{1}{\alpha - 1}$ . When  $\alpha > 0$ ,  $\hat{y} = \frac{1}{\alpha - 1} > 0$ . If  $x = 0$ , then from the differential equation for  $y'$ ,  $y = \beta$ . On the other hand, if  $\hat{y} = \frac{1}{\alpha - 1}$ ,  $\frac{\hat{y}}{1 + \hat{y}} = \frac{1}{\alpha}$  and so  $\frac{1}{\alpha} \hat{x} - \frac{1}{\alpha - 1} + \beta = 0$ . It follows that

$$\hat{x} = \alpha \left( \beta - \frac{1}{\alpha - 1} \right) = \frac{\alpha}{\alpha - 1} [(\alpha - 1)\beta - 1]$$

and if  $\beta(\alpha - 1) > 1$ ,  $\hat{x} > 0$ . Therefore  $(\hat{x}, \hat{y})$  is the unique critical point in the first quadrant. The Jacobian matrix is

$$\mathbf{g}'(\mathbf{X}) = \begin{pmatrix} \alpha \frac{y}{y+1} - 1 & \frac{\alpha x}{(1+y)^2} \\ -\frac{y}{1+y} & \frac{-x}{(1+y)^2} - 1 \end{pmatrix}$$

and for  $\mathbf{X} = (\hat{x}, \hat{y})$ , the Jacobian can be written in the form

$$\mathbf{g}'((\hat{x}, \hat{y})) = \begin{pmatrix} 0 & \frac{(\alpha - 1)^2}{\alpha} \hat{x} \\ -\frac{1}{\alpha} & -\frac{(\alpha - 1)^2}{\alpha^2} \hat{x} - 1 \end{pmatrix}$$

It follows that

$$\tau = - \left[ \frac{(\alpha - 1)^2}{\alpha^2} \hat{x} + 1 \right] < 0, \quad \Delta = \frac{(\alpha - 1)^2}{\alpha^2} \hat{x}$$

and so  $\tau = -(\Delta + 1)$ . Therefore  $\tau^2 - 4\Delta = (\Delta + 1)^2 - 4\Delta = (\Delta - 1)^2 > 0$ . Therefore  $(\hat{x}, \hat{y})$  is a stable node.

22. Letting  $y = x'$  we obtain the plane autonomous system

$$\begin{aligned} x' &= y \\ y' &= -8x + 6x^3 - x^5. \end{aligned}$$

Solving  $x^5 - 6x^3 + 8x = x(x^2 - 4)(x^2 - 2) = 0$  we see that critical points are  $(0, 0)$ ,  $(0, -2)$ ,  $(0, 2)$ ,  $(0, -\sqrt{2})$ , and  $(0, \sqrt{2})$ .

The Jacobian matrix is

$$\mathbf{g}'(\mathbf{X}) = \begin{pmatrix} 0 & 1 \\ -8 + 18x^2 - 5x^4 & 0 \end{pmatrix}$$

and we see that  $\det(\mathbf{g}'(\mathbf{X})) = 5x^4 - 18x^2 + 8$  and the trace of  $\mathbf{g}'(\mathbf{X})$  is 0. Since  $\det(\mathbf{g}'((\pm\sqrt{2}, 0))) = -8 < 0$ ,  $(\pm\sqrt{2}, 0)$  are saddle points. For the other critical points the determinant is positive and linearization discloses no information. The graph of the phase plane suggests that  $(0, 0)$  and  $(\pm 2, 0)$  are centers.

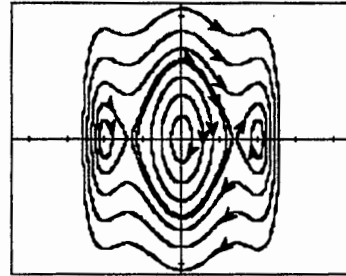

## Chapter 10 Review Exercises

1. True
2. True
3. a center or a saddle point
4. complex with negative real parts
5. False; there are initial conditions for which  $\lim_{t \rightarrow \infty} \mathbf{X}(t) = (0, 0)$ .
6. True
7. False; this is a borderline case. See Figure 10.25 in the text.
8. False; see Figure 10.29 in the text.
9. The system is linear and we identify  $\Delta = -\alpha$  and  $\tau = \alpha + 1$ . Since a critical point will be a center when  $\Delta > 0$  and  $\tau = 0$  we see that for  $\alpha = -1$  critical points will be centers and solutions will be periodic. Note also that when  $\alpha = -1$  the system is

$$\begin{aligned}x' &= -x - 2y \\y' &= x + y,\end{aligned}$$

which does have an isolated critical point at  $(0, 0)$ .

10. We identify  $g(x) = \sin x$  in Theorem 10.2. Then  $x_1 = n\pi$  is a critical point for  $n$  an integer and  $g'(n\pi) = \cos n\pi < 0$  when  $n$  is an odd integer. Thus,  $n\pi$  is an asymptotically stable critical point when  $n$  is an odd integer.
11. Switching to polar coordinates,

$$\begin{aligned}\frac{dr}{dt} &= \frac{1}{r} \left( x \frac{dx}{dt} + y \frac{dy}{dt} \right) = \frac{1}{r} (-xy - x^2r^3 + xy - y^2r^3) = -r^4 \\ \frac{d\theta}{dt} &= \frac{1}{r^2} \left( -y \frac{dx}{dt} + x \frac{dy}{dt} \right) = \frac{1}{r^2} (y^2 + xyr^3 + x^2 - xy r^3) = 1.\end{aligned}$$

Using separation of variables it follows that  $r = \frac{1}{\sqrt[3]{3t + c_1}}$  and  $\theta = t + c_2$ . Since  $\mathbf{X}(0) = (1, 0)$ ,  $r = 1$  and  $\theta = 0$ . It follows that  $c_1 = 1$ ,  $c_2 = 0$ , and so

$$r = \frac{1}{\sqrt[3]{3t + 1}}, \quad \theta = t.$$

As  $t \rightarrow \infty$ ,  $r \rightarrow 0$  and the solution spirals toward the origin.

12. (a) If  $\mathbf{X}(0) = \mathbf{X}_0$  lies on the line  $y = -2x$ , then  $\mathbf{X}(t)$  approaches  $(0, 0)$  along this line. For all other initial conditions,  $\mathbf{X}(t)$  approaches  $(0, 0)$  from the direction determined by the line  $y = x$ .

### Chapter 10 Review Exercises

(b) If  $\mathbf{X}(0) = \mathbf{X}_0$  lies on the line  $y = -x$ , then  $\mathbf{X}(t)$  approaches  $(0, 0)$  along this line. For all other initial conditions,  $\mathbf{X}(t)$  becomes unbounded and  $y = 2x$  serves as an asymptote.

13. (a)  $\tau = 0$ ,  $\Delta = 11 > 0$  and so  $(0, 0)$  is a center.

(b)  $\tau = -2$ ,  $\Delta = 1$ ,  $\tau^2 - 4\Delta = 0$  and so  $(0, 0)$  is a degenerate stable node.

14. From  $x' = x(1 + y - 3x) = 0$ , either  $x = 0$  or  $1 + y - 3x = 0$ . If  $x = 0$ , then, from  $y(4 - 2x - y) = 0$  we obtain  $y(4 - y) = 0$ . It follows that  $(0, 0)$  and  $(0, 4)$  are critical points. If  $1 + y - 3x = 0$ , then  $y(5 - 5x) = 0$ . Therefore  $(1/3, 0)$  and  $(1, 2)$  are the remaining critical points. We will use the Jacobian matrix

$$\mathbf{g}'(\mathbf{X}) = \begin{pmatrix} 1 + y - 6x & x \\ -2y & 4 - 2x - 2y \end{pmatrix}$$

to classify these four critical points. The results are as follows:

$\mathbf{X}$	$\tau$	$\Delta$	$\tau^2 - 4\Delta$	Conclusion
$(0, 0)$	5	4	9	unstable node
$(0, 4)$	-	-20	-	saddle point
$(\frac{1}{3}, 0)$	-	$-\frac{10}{3}$	-	saddle point
$(1, 2)$	-5	10	-15	stable spiral point

15. From  $x = r \cos \theta$ ,  $y = r \sin \theta$  we have

$$\frac{dx}{dt} = -r \sin \theta \frac{d\theta}{dt} + \frac{dr}{dt} \cos \theta$$

$$\frac{dy}{dt} = r \cos \theta \frac{d\theta}{dt} + \frac{dr}{dt} \sin \theta.$$

Then  $r' = \alpha r$ ,  $\theta' = 1$  gives

$$\frac{dx}{dt} = -r \sin \theta + \alpha r \cos \theta$$

$$\frac{dy}{dt} = r \cos \theta + \alpha r \sin \theta.$$

We see that  $r = 0$ , which corresponds to  $\mathbf{X} = (0, 0)$ , is a critical point. Solving  $r' = \alpha r$  we have  $r = c_1 e^{\alpha t}$ . Thus, when  $\alpha < 0$ ,  $\lim_{t \rightarrow \infty} r(t) = 0$  and  $(0, 0)$  is a stable critical point. When  $\alpha = 0$ ,  $r' = 0$  and  $r = c_1$ . In this case  $(0, 0)$  is a center, which is stable. Therefore,  $(0, 0)$  is a stable critical point for the system when  $\alpha \leq 0$ .

16. The corresponding plane autonomous system is  $x' = y$ ,  $y' = \mu(1 - x^2) - x$  and so the Jacobian at the critical point  $(0, 0)$  is

$$\mathbf{g}'((0, 0)) = \begin{pmatrix} 0 & 1 \\ -1 & \mu \end{pmatrix}.$$



Chapter 10 Review Exercises

Therefore  $\tau = \mu$ ,  $\Delta = 1$  and  $\tau^2 - 4\Delta = \mu^2 - 4$ . Now  $\mu^2 - 4 < 0$  if and only if  $-2 < \mu < 2$ . We may therefore conclude that  $(0, 0)$  is a stable node for  $\mu < -2$ , a stable spiral point for  $-2 < \mu < 0$ , an unstable spiral point for  $0 < \mu < 2$ , and an unstable node for  $\mu > 2$ .

17. Critical points occur at  $x = \pm 1$ . Since

$$g'(x) = -\frac{1}{2}e^{-x/2}(x^2 - 4x - 1),$$

$g'(1) > 0$  and  $g'(-1) < 0$ . Therefore  $x = 1$  is unstable and  $x = -1$  is asymptotically stable.

18.  $\frac{dy}{dx} = \frac{y'}{x'} = \frac{-2x\sqrt{y^2+1}}{y}$ . We may separate variables to show that  $\sqrt{y^2+1} = -x^2 + c$ . But  $x(0) = x_0$  and  $y(0) = x'(0) = 0$ . It follows that  $c = 1 + x_0^2$  so that

$$y^2 = (1 + x_0^2 - x^2)^2 - 1.$$

Note that  $1 + x_0^2 - x^2 > 1$  for  $-x_0 < x < x_0$  and  $y = 0$  for  $x = \pm x_0$ . Each  $x$  with  $-x_0 < x < x_0$  has two corresponding values of  $y$  and so the solution  $\mathbf{X}(t)$  with  $\mathbf{X}(0) = (x_0, 0)$  is periodic.

19. The corresponding plane autonomous system

$$x' = y, \quad y' = -\frac{\beta}{m}y - \frac{k}{m}(s+x)^3 + g$$

and so the Jacobian is

$$\mathbf{g}'(\mathbf{X}) = \begin{pmatrix} 0 & 1 \\ -\frac{3k}{m}(s+x)^2 & -\frac{\beta}{m} \end{pmatrix}.$$

For  $\mathbf{X} = (0, 0)$ ,  $\tau = -\frac{\beta}{m} < 0$ ,  $\Delta = \frac{3k}{m}s^2 > 0$ . Therefore

$$\tau^2 - 4\Delta = \frac{\beta^2}{m^2} - \frac{12k}{m}s^2 = \frac{1}{m^2}(\beta^2 - 12kms^2).$$

Therefore  $(0, 0)$  is a stable node if  $\beta^2 > 12kms^2$  and a stable spiral point provided  $\beta^2 < 12kms^2$ , where  $ks^3 = mg$ .

20. (a) If  $(x, y)$  is a critical point,  $y = 0$  and so  $\sin x(\omega^2 \cos x - g/l) = 0$ . Either  $\sin x = 0$  (in which case  $x = 0$ ) or  $\cos x = g/\omega^2 l$ . But if  $\omega^2 < g/l$ ,  $g/\omega^2 l > 1$  and so the latter equation has no real solutions. Therefore  $(0, 0)$  is the only critical point if  $\omega^2 < g/l$ . The Jacobian matrix is

$$\mathbf{g}'(\mathbf{X}) = \begin{pmatrix} 0 & 1 \\ \omega^2 \cos 2x - \frac{g}{l} \cos x & -\frac{\beta}{ml} \end{pmatrix}$$

and so  $\tau = -\beta/ml < 0$  and  $\Delta = g/l - \omega^2 > 0$  for  $\mathbf{X} = (0, 0)$ . It follows that  $(0, 0)$  is asymptotically stable and so after a small displacement, the pendulum will return to  $\theta = 0$ ,  $\theta' = 0$ .

### Chapter 10 Review Exercises

- (b) If  $\omega^2 > g/l$ ,  $\cos x = g/\omega^2 l$  will have two solutions  $x = \pm \hat{x}$  that satisfy  $-\pi < x < \pi$ . Therefore  $(\pm \hat{x}, 0)$  are two additional critical points. If  $\mathbf{X}_1 = (0, 0)$ ,  $\Delta = g/l - \omega^2 < 0$  and so  $(0, 0)$  is a saddle point. If  $\mathbf{X}_1 = (\pm \hat{x}, 0)$ ,  $\tau = -\beta/ml < 0$  and

$$\Delta = \frac{g}{l} \cos \hat{x} - \omega^2 \cos 2\hat{x} = \frac{g^2}{\omega^2 l^2} - \omega^2 \left( 2 \frac{g^2}{\omega^4 l^2} - 1 \right) = \omega^2 - \frac{g^2}{\omega^2 l^2} > 0.$$

Therefore  $(\hat{x}, 0)$  and  $(-\hat{x}, 0)$  are each stable. When  $\theta(0) = \theta_0$ ,  $\theta'(0) = 0$  and  $\theta_0$  is small we expect the pendulum to reach one of these two stable equilibrium positions.

# 11 Orthogonal Functions and Fourier Series

## Exercises 11.1

$$1. \int_{-2}^2 xx^2 dx = \frac{1}{4}x^4 \Big|_{-2}^2 = 0$$

$$2. \int_{-1}^1 x^3(x^2 + 1) dx = \frac{1}{6}x^6 \Big|_{-1}^1 + \frac{1}{4}x^4 \Big|_{-1}^1 = 0$$

$$3. \int_0^2 e^x(xe^{-x} - e^{-x}) dx = \int_0^2 (x - 1) dx = \left(\frac{1}{2}x^2 - x\right) \Big|_0^2 = 0$$

$$4. \int_0^\pi \cos x \sin^2 x dx = \frac{1}{3} \sin^3 x \Big|_0^\pi = 0$$

$$5. \int_{-\pi/2}^{\pi/2} x \cos 2x dx = \frac{1}{2} \left(\frac{1}{2} \cos 2x + x \sin 2x\right) \Big|_{-\pi/2}^{\pi/2} = 0$$

$$6. \int_{\pi/4}^{5\pi/4} e^x \sin x dx = \left(\frac{1}{2}e^x \sin x - \frac{1}{2}e^x \cos x\right) \Big|_{\pi/4}^{5\pi/4} = 0$$

7. For  $m \neq n$

$$\begin{aligned} \int_0^{\pi/2} \sin(2n+1)x \sin(2m+1)x dx \\ &= \frac{1}{2} \int_0^{\pi/2} [\cos 2(n-m)x - \cos 2(n+m+1)x] dx \\ &= \frac{1}{4(n-m)} \sin 2(n-m)x \Big|_0^{\pi/2} - \frac{1}{4(n+m+1)} \sin 2(n+m+1)x \Big|_0^{\pi/2} \\ &= 0. \end{aligned}$$

For  $m = n$

$$\begin{aligned} \int_0^{\pi/2} \sin^2(2n+1)x dx &= \int_0^{\pi/2} \left(\frac{1}{2} - \frac{1}{2} \cos 2(2n+1)x\right) dx \\ &= \frac{1}{2}x \Big|_0^{\pi/2} - \frac{1}{4(2n+1)} \sin 2(2n+1)x \Big|_0^{\pi/2} \\ &= \frac{\pi}{4} \end{aligned}$$

### Exercises 11.1

so that

$$\|\sin(2n+1)x\| = \frac{1}{2}\sqrt{\pi}.$$

8. For  $m \neq n$

$$\begin{aligned} \int_0^{\pi/2} \cos(2n+1)x \cos(2m+1)x \, dx &= \frac{1}{2} \int_0^{\pi/2} [\cos 2(n-m)x + \cos 2(n+m+1)x] \, dx \\ &= \frac{1}{4(n-m)} \sin 2(n-m)x \Big|_0^{\pi/2} + \frac{1}{4(n+m+1)} \sin 2(n+m+1)x \Big|_0^{\pi/2} \\ &= 0. \end{aligned}$$

For  $m = n$

$$\begin{aligned} \int_0^{\pi/2} \cos^2(2n+1)x \, dx &= \int_0^{\pi/2} \left( \frac{1}{2} + \frac{1}{2} \cos 2(2n+1)x \right) \, dx \\ &= \frac{1}{2}x \Big|_0^{\pi/2} + \frac{1}{4(2n+1)} \sin 2(2n+1)x \Big|_0^{\pi/2} \\ &= \frac{\pi}{4} \end{aligned}$$

so that

$$\|\cos(2n+1)x\| = \frac{1}{2}\sqrt{\pi}.$$

9. For  $m \neq n$

$$\begin{aligned} \int_0^{\pi} \sin nx \sin mx \, dx &= \frac{1}{2} \int_0^{\pi} [\cos(n-m)x - \cos(n+m)x] \, dx \\ &= \frac{1}{2(n-m)} \sin(n-m)x \Big|_0^{\pi} - \frac{1}{2(n+m)} \sin 2(n+m)x \Big|_0^{\pi} \\ &= 0. \end{aligned}$$

For  $m = n$

$$\int_0^{\pi} \sin^2 nx \, dx = \int_0^{\pi} \left[ \frac{1}{2} - \frac{1}{2} \cos 2nx \right] \, dx = \frac{1}{2}x \Big|_0^{\pi} - \frac{1}{4n} \sin 2nx \Big|_0^{\pi} = \frac{\pi}{2}$$

so that

$$\|\sin nx\| = \sqrt{\frac{\pi}{2}}.$$

10. For  $m \neq n$

$$\begin{aligned} \int_0^p \sin \frac{n\pi}{p} x \sin \frac{m\pi}{p} x dx &= \frac{1}{2} \int_0^p \left( \cos \frac{(n-m)\pi}{p} x - \cos \frac{(n+m)\pi}{p} x \right) dx \\ &= \frac{p}{2(n-m)\pi} \sin \frac{(n-m)\pi}{p} x \Big|_0^p - \frac{p}{2(n+m)\pi} \sin \frac{(n+m)\pi}{p} x \Big|_0^p \\ &= 0. \end{aligned}$$

For  $m = n$

$$\int_0^p \sin^2 \frac{n\pi}{p} x dx = \int_0^p \left[ \frac{1}{2} - \frac{1}{2} \cos \frac{2n\pi}{p} x \right] dx = \frac{1}{2} x \Big|_0^p - \frac{p}{4n\pi} \sin \frac{2n\pi}{p} x \Big|_0^p = \frac{p}{2}$$

so that

$$\left\| \sin \frac{n\pi}{p} x \right\| = \sqrt{\frac{p}{2}}.$$

11. For  $m \neq n$

$$\begin{aligned} \int_0^p \cos \frac{n\pi}{p} x \cos \frac{m\pi}{p} x dx &= \frac{1}{2} \int_0^p \left( \cos \frac{(n-m)\pi}{p} x + \cos \frac{(n+m)\pi}{p} x \right) dx \\ &= \frac{p}{2(n-m)\pi} \sin \frac{(n-m)\pi}{p} x \Big|_0^p + \frac{p}{2(n+m)\pi} \sin \frac{(n+m)\pi}{p} x \Big|_0^p \\ &= 0. \end{aligned}$$

For  $m = n$

$$\int_0^p \cos^2 \frac{n\pi}{p} x dx = \int_0^p \left( \frac{1}{2} + \frac{1}{2} \cos \frac{2n\pi}{p} x \right) dx = \frac{1}{2} x \Big|_0^p + \frac{p}{4n\pi} \sin \frac{2n\pi}{p} x \Big|_0^p = \frac{p}{2}.$$

Also

$$\int_0^p 1 \cdot \cos \frac{n\pi}{p} x dx = \frac{p}{n\pi} \sin \frac{n\pi}{p} x \Big|_0^p = 0 \quad \text{and} \quad \int_0^p 1^2 dx = p$$

so that

$$\|1\| = \sqrt{p} \quad \text{and} \quad \left\| \cos \frac{n\pi}{p} x \right\| = \sqrt{\frac{p}{2}}.$$

12. For  $m \neq n$ , we use Problems 11 and 10:

$$\begin{aligned} \int_{-p}^p \cos \frac{n\pi}{p} x \cos \frac{m\pi}{p} x dx &= 2 \int_0^p \cos \frac{n\pi}{p} x \cos \frac{m\pi}{p} x dx = 0 \\ \int_{-p}^p \sin \frac{n\pi}{p} x \sin \frac{m\pi}{p} x dx &= 2 \int_0^p \sin \frac{n\pi}{p} x \sin \frac{m\pi}{p} x dx = 0. \end{aligned}$$

Also

$$\int_{-p}^p \sin \frac{n\pi}{p} x \cos \frac{m\pi}{p} x dx = \frac{1}{2} \int_{-p}^p \left( \sin \frac{(n-m)\pi}{p} x + \sin \frac{(n+m)\pi}{p} x \right) dx = 0,$$

### Exercises 11.1

$$\int_{-p}^p 1 \cdot \cos \frac{n\pi}{p} x dx = \frac{p}{n\pi} \sin \frac{n\pi}{p} x \Big|_{-p}^p = 0,$$

$$\int_{-p}^p 1 \cdot \sin \frac{n\pi}{p} x dx = -\frac{p}{n\pi} \cos \frac{n\pi}{p} x \Big|_{-p}^p = 0,$$

and

$$\int_{-p}^p \sin \frac{n\pi}{p} x \cos \frac{n\pi}{p} x dx = \int_{-p}^p \frac{1}{2} \sin \frac{2n\pi}{p} x dx = -\frac{p}{4n\pi} \cos \frac{2n\pi}{p} x \Big|_{-p}^p = 0.$$

For  $m = n$

$$\int_{-p}^p \cos^2 \frac{n\pi}{p} x dx = \int_{-p}^p \left( \frac{1}{2} + \frac{1}{2} \cos \frac{2n\pi}{p} x \right) dx = p,$$

$$\int_{-p}^p \sin^2 \frac{n\pi}{p} x dx = \int_{-p}^p \left( \frac{1}{2} - \frac{1}{2} \cos \frac{2n\pi}{p} x \right) dx = p,$$

and

$$\int_{-p}^p 1^2 dx = 2p$$

so that

$$\|1\| = \sqrt{2p}, \quad \left\| \cos \frac{n\pi}{p} x \right\| = \sqrt{p}, \quad \text{and} \quad \left\| \sin \frac{n\pi}{p} x \right\| = \sqrt{p}.$$

13. Since

$$\int_{-\infty}^{\infty} e^{-x^2} \cdot 1 \cdot 2x dx = -e^{-x^2} \Big|_{-\infty}^0 - e^{-x^2} \Big|_0^{\infty} = 0,$$

$$\begin{aligned} \int_{-\infty}^{\infty} e^{-x^2} \cdot 1 \cdot (4x^2 - 2) dx &= 2 \int_{-\infty}^{\infty} x (2xe^{-x^2}) dx - 2 \int_{-\infty}^{\infty} e^{-x^2} dx \\ &= 2 \left( -xe^{-x^2} \Big|_{-\infty}^{\infty} + \int_{-\infty}^{\infty} e^{-x^2} dx \right) - 2 \int_{-\infty}^{\infty} e^{-x^2} dx \\ &= 2 \left( -xe^{-x^2} \Big|_{-\infty}^0 - xe^{-x^2} \Big|_0^{\infty} \right) = 0, \end{aligned}$$

and

$$\begin{aligned} \int_{-\infty}^{\infty} e^{-x^2} \cdot 2x \cdot (4x^2 - 2) dx &= 4 \int_{-\infty}^{\infty} x^2 (2xe^{-x^2}) dx - 4 \int_{-\infty}^{\infty} xe^{-x^2} dx \\ &= 4 \left( -x^2 e^{-x^2} \Big|_{-\infty}^{\infty} + 2 \int_{-\infty}^{\infty} xe^{-x^2} dx \right) - 4 \int_{-\infty}^{\infty} xe^{-x^2} dx \\ &= 4 \left( -x^2 e^{-x^2} \Big|_{-\infty}^0 - x^2 e^{-x^2} \Big|_0^{\infty} \right) + 2 \int_{-\infty}^{\infty} 2xe^{-x^2} dx = 0, \end{aligned}$$

the functions are orthogonal.

14. Since

$$\begin{aligned}\int_0^\infty e^{-x^2} \cdot 1(1-x) dx &= (x-1)e^{-x} \Big|_0^\infty - \int_0^\infty e^{-x} dx = 0, \\ \int_0^\infty e^{-x} \cdot 1 \cdot \left(\frac{1}{2}x^2 - 2x + 1\right) dx &= \left(2x - 1 - \frac{1}{2}x^2\right) e^{-x} \Big|_0^\infty + \int_0^\infty e^{-x}(x-2) dx \\ &= 1 + (2-x)e^{-x} \Big|_0^\infty + \int_0^\infty e^{-x} dx = 0,\end{aligned}$$

and

$$\begin{aligned}\int_0^\infty e^{-x} \cdot (1-x) \left(\frac{1}{2}x^2 - 2x + 1\right) dx &= \int_0^\infty e^{-x} \left(-\frac{1}{2}x^3 + \frac{5}{2}x^2 - 3x + 1\right) dx \\ &= e^{-x} \left(\frac{1}{2}x^3 - \frac{5}{2}x^2 + 3x - 1\right) \Big|_0^\infty + \int_0^\infty e^{-x} \left(-\frac{3}{2}x^2 + 5x - 3\right) dx \\ &= 1 + e^{-x} \left(\frac{3}{2}x^2 - 5x + 3\right) \Big|_0^\infty + \int_0^\infty e^{-x}(5-3x) dx \\ &= 1 - 3 + e^{-x}(3x-5) \Big|_0^\infty - 3 \int_0^\infty e^{-x} dx = 0,\end{aligned}$$

the functions are orthogonal.

15. By orthogonality  $\int_a^b \phi_0(x)\phi_n(x)dx = 0$  for  $n = 1, 2, 3, \dots$ ; that is,  $\int_a^b \phi_n(x)dx = 0$  for  $n = 1, 2, 3, \dots$ .

16. Using the facts that  $\phi_0$  and  $\phi_1$  are orthogonal to  $\phi_n$  for  $n > 1$ , we have

$$\begin{aligned}\int_a^b (\alpha x + \beta)\phi_n(x) dx &= \alpha \int_a^b x\phi_n(x) dx + \beta \int_a^b 1 \cdot \phi_n(x) dx \\ &= \alpha \int_a^b \phi_1(x)\phi_n(x) dx + \beta \int_a^b \phi_0(x)\phi_n(x) dx \\ &= \alpha \cdot 0 + \beta \cdot 0 = 0\end{aligned}$$

for  $n = 2, 3, 4, \dots$ .

17. Using the fact that  $\phi_m$  and  $\phi_n$  are orthogonal for  $n \neq m$  we have

$$\begin{aligned}\|\phi_m(x) + \phi_n(x)\|^2 &= \int_a^b [\phi_m(x) + \phi_n(x)]^2 dx = \int_a^b [\phi_m^2(x) + 2\phi_m(x)\phi_n(x) + \phi_n^2(x)] dx \\ &= \int_a^b \phi_m^2(x) dx + 2 \int_a^b \phi_m(x)\phi_n(x) dx + \int_a^b \phi_n^2(x) dx \\ &= \|\phi_m(x)\|^2 + \|\phi_n(x)\|^2.\end{aligned}$$

## Exercises 11.1

18. Setting

$$0 = \int_{-2}^2 f_3(x)f_1(x) dx = \int_{-2}^2 (x^2 + c_1x^3 + c_2x^4) dx = \frac{16}{3} + \frac{64}{5}c_2$$

and

$$0 = \int_{-2}^2 f_3(x)f_2(x) dx = \int_{-2}^2 (x^3 + c_1x^4 + c_2x^5) dx = \frac{64}{5}c_1$$

we obtain  $c_1 = 0$  and  $c_2 = -5/12$ .

19. Since  $\sin nx$  is an odd function on  $[-\pi, \pi]$ ,

$$(1, \sin nx) = \int_{-\pi}^{\pi} \sin nx dx = 0$$

and  $f(x) = 1$  is orthogonal to every member of  $\{\sin nx\}$ . Thus  $\{\sin nx\}$  is not complete.

20.  $(f_1 + f_2, f_3) = \int_a^b [f_1(x) + f_2(x)]f_3(x) dx = \int_a^b f_1(x)f_3(x) dx + \int_a^b f_2(x)f_3(x) dx = (f_1, f_3) + (f_2, f_3)$

21. (a) The fundamental period is  $2\pi/2\pi = 1$ .

(b) The fundamental period is  $2\pi/(4/L) = \frac{1}{2}\pi L$ .

(c) The fundamental period of  $\sin x + \sin 2x$  is  $2\pi$ .

(d) The fundamental period of  $\sin 2x + \cos 4x$  is  $2\pi/2 = \pi$ .

(e) The fundamental period of  $\sin 3x + \cos 4x$  is  $2\pi$  since the smallest integer multiples of  $2\pi/3$  and  $2\pi/4 = \pi/2$  that are equal are 3 and 4, respectively.

(f) The fundamental period of  $f(x)$  is  $2\pi/(n\pi/p) = 2p/n$ .

---

## Exercises 11.2

---

1.  $a_0 = \frac{1}{\pi} \int_{-\pi}^{\pi} f(x) dx = \frac{1}{\pi} \int_0^{\pi} 1 dx = 1$

$$a_n = \frac{1}{\pi} \int_{-\pi}^{\pi} f(x) \cos \frac{n\pi}{\pi} x dx = \frac{1}{\pi} \int_0^{\pi} \cos nx dx = 0$$

$$b_n = \frac{1}{\pi} \int_{-\pi}^{\pi} f(x) \sin \frac{n\pi}{\pi} x dx = \frac{1}{\pi} \int_0^{\pi} \sin nx dx = \frac{1}{n\pi} (1 - \cos n\pi) = \frac{1}{n\pi} [1 - (-1)^n]$$

$$f(x) = \frac{1}{2} + \frac{1}{\pi} \sum_{n=1}^{\infty} \frac{1 - (-1)^n}{n} \sin nx$$

2.  $a_0 = \frac{1}{\pi} \int_{-\pi}^{\pi} f(x) dx = \frac{1}{\pi} \int_{-\pi}^0 -1 dx + \frac{1}{\pi} \int_0^{\pi} 2 dx = 1$

$$a_n = \frac{1}{\pi} \int_{-\pi}^{\pi} f(x) \cos nx dx = \frac{1}{\pi} \int_{-\pi}^0 -\cos nx dx + \frac{1}{\pi} \int_0^{\pi} 2 \cos nx dx = 0$$

$$b_n = \frac{1}{\pi} \int_{-\pi}^{\pi} f(x) \sin nx dx = \frac{1}{\pi} \int_{-\pi}^0 -\sin nx dx + \frac{1}{\pi} \int_0^{\pi} 2 \sin nx dx = \frac{3}{n\pi} [1 - (-1)^n]$$



$$f(x) = \frac{1}{2} + \frac{3}{\pi} \sum_{n=1}^{\infty} \frac{1 - (-1)^n}{n} \sin nx$$

$$3. a_0 = \int_{-1}^1 f(x) dx = \int_{-1}^0 1 dx + \int_0^1 x dx = \frac{3}{2}$$

$$a_n = \int_{-1}^1 f(x) \cos n\pi x dx = \int_{-1}^0 \cos n\pi x dx + \int_0^1 x \cos n\pi x dx = \frac{1}{n^2\pi^2} [(-1)^n - 1]$$

$$b_n = \int_{-1}^1 f(x) \sin n\pi x dx = \int_{-1}^0 \sin n\pi x dx + \int_0^1 x \sin n\pi x dx = -\frac{1}{n\pi}$$

$$f(x) = \frac{3}{4} + \sum_{n=1}^{\infty} \left[ \frac{(-1)^n - 1}{n^2\pi^2} \cos n\pi x - \frac{1}{n\pi} \sin n\pi x \right]$$

$$4. a_0 = \int_{-1}^1 f(x) dx = \int_0^1 x dx = \frac{1}{2}$$

$$a_n = \int_{-1}^1 f(x) \cos n\pi x dx = \int_0^1 x \cos n\pi x dx = \frac{1}{n^2\pi^2} [(-1)^n - 1]$$

$$b_n = \int_{-1}^1 f(x) \sin n\pi x dx = \int_0^1 x \sin n\pi x dx = \frac{(-1)^{n+1}}{n\pi}$$

$$f(x) = \frac{3}{4} + \sum_{n=1}^{\infty} \left[ \frac{(-1)^n - 1}{n^2\pi^2} \cos n\pi x + \frac{(-1)^{n+1}}{n\pi} \sin n\pi x \right]$$

$$5. a_0 = \frac{1}{\pi} \int_{-\pi}^{\pi} f(x) dx = \frac{1}{\pi} \int_0^{\pi} x^2 dx = \frac{1}{3}\pi^2$$

$$a_n = \frac{1}{\pi} \int_{-\pi}^{\pi} f(x) \cos nx dx = \frac{1}{\pi} \int_0^{\pi} x^2 \cos nx dx = \frac{1}{\pi} \left( \frac{x^2}{\pi} \sin nx \Big|_0^{\pi} - \frac{2}{n} \int_0^{\pi} x \sin nx dx \right) = \frac{2(-1)^n}{n^2}$$

$$b_n = \frac{1}{\pi} \int_0^{\pi} x^2 \sin nx dx = \frac{1}{\pi} \left( -\frac{x^2}{n} \cos nx \Big|_0^{\pi} + \frac{2}{n} \int_0^{\pi} x \cos nx dx \right) = \frac{\pi}{n} (-1)^{n+1} + \frac{2}{n^3\pi} [(-1)^n - 1]$$

$$f(x) = \frac{\pi^2}{6} + \sum_{n=1}^{\infty} \left[ \frac{2(-1)^n}{n^2} \cos nx + \left( \frac{\pi}{n} (-1)^{n+1} + \frac{2[(-1)^n - 1]}{n^3\pi} \right) \sin nx \right]$$

$$6. a_0 = \frac{1}{\pi} \int_{-\pi}^{\pi} f(x) dx = \frac{1}{\pi} \int_{-\pi}^0 \pi^2 dx + \frac{1}{\pi} \int_0^{\pi} (\pi^2 - x^2) dx = \frac{5}{3}\pi^2$$

$$\begin{aligned} a_n &= \frac{1}{\pi} \int_{-\pi}^{\pi} f(x) \cos nx dx = \frac{1}{\pi} \int_{-\pi}^0 \pi^2 \cos nx dx + \frac{1}{\pi} \int_0^{\pi} (\pi^2 - x^2) \cos nx dx \\ &= \frac{1}{\pi} \left( \frac{\pi^2 - x^2}{n} \sin nx \Big|_0^{\pi} + \frac{2}{n} \int_0^{\pi} x \sin nx dx \right) = \frac{2}{n^2} (-1)^{n+1} \end{aligned}$$

$$b_n = \frac{1}{\pi} \int_{-\pi}^{\pi} f(x) \sin nx dx = \frac{1}{\pi} \int_{-\pi}^0 \pi^2 \sin nx dx + \frac{1}{\pi} \int_0^{\pi} (\pi^2 - x^2) \sin nx dx$$

## Exercises 11.2

$$= \frac{\pi}{n}[(-1)^n - 1] + \frac{1}{\pi} \left( \frac{x^2 - \pi^2}{n} \cos nx \Big|_0^\pi - \frac{2}{n} \int_0^\pi x \cos nx \, dx \right) = \frac{\pi}{n}(-1)^n + \frac{2}{n^3\pi}[1 - (-1)^n]$$

$$f(x) = \frac{5\pi^2}{6} + \sum_{n=1}^{\infty} \left[ \frac{2}{n^2}(-1)^{n+1} \cos nx + \left( \frac{\pi}{n}(-1)^n + \frac{2[1 - (-1)^n]}{n^3\pi} \right) \sin nx \right]$$

$$7. \quad a_0 = \frac{1}{\pi} \int_{-\pi}^{\pi} f(x) \, dx = \frac{1}{\pi} \int_{-\pi}^{\pi} (x + \pi) \, dx = 2\pi$$

$$a_n = \frac{1}{\pi} \int_{-\pi}^{\pi} f(x) \cos nx \, dx = \frac{1}{\pi} \int_{-\pi}^{\pi} (x + \pi) \cos nx \, dx = 0$$

$$b_n = \frac{1}{\pi} \int_{-\pi}^{\pi} f(x) \sin nx \, dx = \frac{2}{n}(-1)^{n+1}$$

$$f(x) = \pi + \sum_{n=1}^{\infty} \frac{2}{n}(-1)^{n+1} \sin nx$$

$$8. \quad a_0 = \frac{1}{\pi} \int_{-\pi}^{\pi} f(x) \, dx = \frac{1}{\pi} \int_{-\pi}^{\pi} (3 - 2x) \, dx = 6$$

$$a_n = \frac{1}{\pi} \int_{-\pi}^{\pi} f(x) \cos nx \, dx = \frac{1}{\pi} \int_{-\pi}^{\pi} (3 - 2x) \cos nx \, dx = 0$$

$$b_n = \frac{1}{\pi} \int_{-\pi}^{\pi} (3 - 2x) \sin nx \, dx = \frac{4}{n}(-1)^n$$

$$f(x) = 3 + 4 \sum_{n=1}^{\infty} \frac{(-1)^n}{n} \sin nx$$

$$9. \quad a_0 = \frac{1}{\pi} \int_{-\pi}^{\pi} f(x) \, dx = \frac{1}{\pi} \int_0^{\pi} \sin x \, dx = \frac{2}{\pi}$$

$$\begin{aligned} a_n &= \frac{1}{\pi} \int_{-\pi}^{\pi} f(x) \cos nx \, dx = \frac{1}{\pi} \int_0^{\pi} \sin x \cos nx \, dx = \frac{1}{2\pi} \int_0^{\pi} [\sin(n+1)x + \sin(1-n)x] \, dx \\ &= \frac{1 + (-1)^n}{\pi(1-n^2)} \quad \text{for } n = 2, 3, 4, \dots \end{aligned}$$

$$a_1 = \frac{1}{2\pi} \int_0^{\pi} \sin 2x \, dx = 0$$

$$\begin{aligned} b_n &= \frac{1}{\pi} \int_{-\pi}^{\pi} f(x) \sin nx \, dx = \frac{1}{\pi} \int_0^{\pi} \sin x \sin nx \, dx \\ &= \frac{1}{2\pi} \int_0^{\pi} [\cos(1-n)x - \cos(1+n)x] \, dx = 0 \quad \text{for } n = 2, 3, 4, \dots \end{aligned}$$

$$b_1 = \frac{1}{2\pi} \int_0^{\pi} (1 - \cos 2x) \, dx = \frac{1}{2}$$

$$f(x) = \frac{1}{\pi} + \frac{1}{2} \sin x + \sum_{n=2}^{\infty} \frac{1 + (-1)^n}{\pi(1-n^2)} \cos nx$$

10.  $a_0 = \frac{2}{\pi} \int_{-\pi/2}^{\pi/2} f(x) dx = \frac{2}{\pi} \int_0^{\pi/2} \cos x dx = \frac{2}{\pi}$
- $$a_n = \frac{2}{\pi} \int_{-\pi/2}^{\pi/2} f(x) \cos 2nx dx = \frac{2}{\pi} \int_0^{\pi/2} \cos x \cos 2nx dx = \frac{1}{\pi} \int_0^{\pi/2} [\cos(2n-1)x + \cos(2n+1)x] dx$$
- $$= \frac{2(-1)^{n+1}}{\pi(4n^2-1)}$$
- $$b_n = \frac{2}{\pi} \int_{-\pi/2}^{\pi/2} f(x) \sin 2nx dx = \frac{2}{\pi} \int_0^{\pi/2} \cos x \sin 2nx dx = \frac{1}{\pi} \int_0^{\pi/2} [\sin(2n-1)x + \sin(2n+1)x] dx$$
- $$= \frac{4n}{\pi(4n^2-1)}$$
- $$f(x) = \frac{1}{\pi} + \sum_{n=1}^{\infty} \left[ \frac{2(-1)^{n+1}}{\pi(4n^2-1)} \cos 2nx + \frac{4n}{\pi(4n^2-1)} \sin 2nx \right]$$
11.  $a_0 = \frac{1}{2} \int_{-2}^2 f(x) dx = \frac{1}{2} \left( \int_{-1}^0 -2 dx + \int_0^1 1 dx \right) = -\frac{1}{2}$
- $$a_n = \frac{1}{2} \int_{-2}^2 f(x) \cos \frac{n\pi}{2} x dx = \frac{1}{2} \left( \int_{-1}^0 [-2 \cos \frac{n\pi}{2} x] dx + \int_0^1 \cos \frac{n\pi}{2} x dx \right) = -\frac{1}{n\pi} \sin \frac{n\pi}{2}$$
- $$b_n = \frac{1}{2} \int_{-2}^2 f(x) \sin \frac{n\pi}{2} x dx = \frac{1}{2} \left( \int_{-1}^0 [-2 \sin \frac{n\pi}{2} x] dx + \int_0^1 \sin \frac{n\pi}{2} x dx \right) = \frac{3}{n\pi} \left( 1 - \cos \frac{n\pi}{2} \right)$$
- $$f(x) = -\frac{1}{4} + \sum_{n=1}^{\infty} \left[ -\frac{1}{n\pi} \sin \frac{n\pi}{2} \cos \frac{n\pi}{2} x + \frac{3}{n\pi} \left( 1 - \cos \frac{n\pi}{2} \right) \sin \frac{n\pi}{2} x \right]$$
12.  $a_0 = \frac{1}{2} \int_{-2}^2 f(x) dx = \frac{1}{2} \left( \int_0^1 x dx + \int_1^2 1 dx \right) = \frac{3}{4}$
- $$a_n = \frac{1}{2} \int_{-2}^2 f(x) \cos \frac{n\pi}{2} x dx = \frac{1}{2} \left( \int_0^1 x \cos \frac{n\pi}{2} x dx + \int_1^2 \cos \frac{n\pi}{2} x dx \right) = \frac{2}{n^2\pi^2} \left( \cos \frac{n\pi}{2} - 1 \right)$$
- $$b_n = \frac{1}{2} \int_{-2}^2 f(x) \sin \frac{n\pi}{2} x dx = \frac{1}{2} \left( \int_0^1 x \sin \frac{n\pi}{2} x dx + \int_1^2 \sin \frac{n\pi}{2} x dx \right)$$
- $$= \frac{2}{n^2\pi^2} \left( \sin \frac{n\pi}{2} + \frac{n\pi}{2} (-1)^{n+1} \right)$$
- $$f(x) = \frac{3}{8} + \sum_{n=1}^{\infty} \left[ \frac{2}{n^2\pi^2} \left( \cos \frac{n\pi}{2} - 1 \right) \cos \frac{n\pi}{2} x + \frac{2}{n^2\pi^2} \left( \sin \frac{n\pi}{2} + \frac{n\pi}{2} (-1)^{n+1} \right) \sin \frac{n\pi}{2} x \right]$$
13.  $a_0 = \frac{1}{5} \int_{-5}^5 f(x) dx = \frac{1}{5} \left( \int_{-5}^0 1 dx + \int_0^5 (1+x) dx \right) = \frac{9}{2}$
- $$a_n = \frac{1}{5} \int_{-5}^5 f(x) \cos \frac{n\pi}{5} x dx = \frac{1}{5} \left( \int_{-5}^0 \cos \frac{n\pi}{5} x dx + \int_0^5 (1+x) \cos \frac{n\pi}{5} x dx \right) = \frac{5}{n^2\pi^2} [(-1)^n - 1]$$

### Exercises 11.2

$$b_n = \frac{1}{5} \int_{-5}^5 f(x) \sin \frac{n\pi}{5} x dx = \frac{1}{5} \left( \int_{-5}^0 \sin \frac{n\pi}{5} x dx + \int_0^5 (1+x) \cos \frac{n\pi}{5} x dx \right) = \frac{5}{n\pi} (-1)^{n+1}$$

$$f(x) = \frac{9}{4} + \sum_{n=1}^{\infty} \left[ \frac{5}{n^2 \pi^2} [(-1)^n - 1] \cos \frac{n\pi}{5} x + \frac{5}{n\pi} (-1)^{n+1} \sin \frac{n\pi}{5} x \right]$$

$$14. a_0 = \frac{1}{2} \int_{-2}^2 f(x) dx = \frac{1}{2} \left( \int_{-2}^0 (2+x) dx + \int_0^2 2 dx \right) = 3$$

$$a_n = \frac{1}{2} \int_{-2}^2 f(x) \cos \frac{n\pi}{2} x dx = \frac{1}{2} \left( \int_{-2}^0 (2+x) \cos \frac{n\pi}{2} x dx + \int_0^2 2 \cos \frac{n\pi}{2} x dx \right) = \frac{2}{n^2 \pi^2} [1 - (-1)^n]$$

$$b_n = \frac{1}{2} \int_{-2}^2 f(x) \sin \frac{n\pi}{2} x dx = \frac{1}{2} \left( \int_{-2}^0 (2+x) \sin \frac{n\pi}{2} x dx + \int_0^2 2 \sin \frac{n\pi}{2} x dx \right) = \frac{2}{n\pi} (-1)^{n+1}$$

$$f(x) = \frac{3}{2} + \sum_{n=1}^{\infty} \left[ \frac{2}{n^2 \pi^2} [1 - (-1)^n] \cos \frac{n\pi}{2} x + \frac{2}{n\pi} (-1)^{n+1} \sin \frac{n\pi}{2} x \right]$$

$$15. a_0 = \frac{1}{\pi} \int_{-\pi}^{\pi} f(x) dx = \frac{1}{\pi} \int_{-\pi}^{\pi} e^x dx = \frac{1}{\pi} (e^{\pi} - e^{-\pi})$$

$$a_n = \frac{1}{\pi} \int_{-\pi}^{\pi} f(x) \cos nx dx = \frac{(-1)^n (e^{\pi} - e^{-\pi})}{\pi(1+n^2)}$$

$$b_n = \frac{1}{\pi} \int_{-\pi}^{\pi} f(x) \sin nx dx = \frac{1}{\pi} \int_{-\pi}^{\pi} e^x \sin nx dx = \frac{(-1)^n n (e^{-\pi} - e^{\pi})}{\pi(1+n^2)}$$

$$f(x) = \frac{e^{\pi} - e^{-\pi}}{2\pi} + \sum_{n=1}^{\infty} \left[ \frac{(-1)^n (e^{\pi} - e^{-\pi})}{\pi(1+n^2)} \cos nx + \frac{(-1)^n n (e^{-\pi} - e^{\pi})}{\pi(1+n^2)} \sin nx \right]$$

$$16. a_0 = \frac{1}{\pi} \int_{-\pi}^{\pi} f(x) dx = \frac{1}{\pi} \int_0^{\pi} (e^x - 1) dx = \frac{1}{\pi} (e^{\pi} - \pi - 1)$$

$$a_n = \frac{1}{\pi} \int_{-\pi}^{\pi} f(x) \cos nx dx = \frac{1}{\pi} \int_0^{\pi} (e^x - 1) \cos nx dx = \frac{[e^{\pi} (-1)^n - 1]}{\pi(1+n^2)}$$

$$b_n = \frac{1}{\pi} \int_{-\pi}^{\pi} f(x) \sin nx dx = \frac{1}{\pi} \int_0^{\pi} (e^x - 1) \sin nx dx = \frac{1}{\pi} \left( \frac{ne^{\pi} (-1)^{n+1}}{1+n^2} + \frac{n}{1+n^2} + \frac{(-1)^n}{n} - \frac{1}{n} \right)$$

$$f(x) = \frac{e^{\pi} - \pi - 1}{2\pi} + \sum_{n=1}^{\infty} \left[ \frac{e^{\pi} (-1)^n - 1}{\pi(1+n^2)} \cos nx + \left( \frac{n}{1+n^2} [e^{\pi} (-1)^{n+1} + 1] + \frac{(-1)^n - 1}{n} \right) \sin nx \right]$$

17. The function in Problem 5 is discontinuous at  $x = \pi$ , so the corresponding Fourier series converges

to  $\pi^2/2$  at  $x = \pi$ . That is,

$$\begin{aligned}\frac{\pi^2}{2} &= \frac{\pi^2}{6} + \sum_{n=1}^{\infty} \left[ \frac{2(-1)^n}{n^2} \cos n\pi + \left( \frac{\pi}{n}(-1)^{n+1} + \frac{2[(-1)^n - 1]}{n^3\pi} \right) \sin n\pi \right] \\ &= \frac{\pi^2}{6} + \sum_{n=1}^{\infty} \frac{2(-1)^n}{n^2} (-1)^n = \frac{\pi^2}{6} + \sum_{n=1}^{\infty} \frac{2}{n^2} = \frac{\pi^2}{6} + 2 \left( 1 + \frac{1}{2^2} + \frac{1}{3^2} + \dots \right)\end{aligned}$$

and

$$\frac{\pi^2}{6} = \frac{1}{2} \left( \frac{\pi^2}{2} - \frac{\pi^2}{6} \right) = 1 + \frac{1}{2^2} + \frac{1}{3^2} + \dots$$

At  $x = 0$  the series converges to 0 and

$$0 = \frac{\pi^2}{6} + \sum_{n=1}^{\infty} \frac{2(-1)^n}{n^2} = \frac{\pi^2}{6} + 2 \left( -1 + \frac{1}{2^2} - \frac{1}{3^2} + \frac{1}{4^2} - \dots \right)$$

so

$$\frac{\pi^2}{12} = 1 - \frac{1}{2^2} + \frac{1}{3^2} - \frac{1}{4^2} + \dots$$

18. From Problem 17

$$\frac{\pi^2}{8} = \frac{1}{2} \left( \frac{\pi^2}{6} + \frac{\pi^2}{12} \right) = \frac{1}{2} \left( 2 + \frac{2}{3^2} + \frac{2}{5^2} + \dots \right) = 1 + \frac{1}{3^2} + \frac{1}{5^2} + \dots$$

19. The function in Problem 7 is continuous at  $x = \pi/2$  so

$$\frac{3\pi}{2} = f\left(\frac{\pi}{2}\right) = \pi + \sum_{n=1}^{\infty} \frac{2}{n} (-1)^{n+1} \sin \frac{n\pi}{2} = \pi + 2 \left( 1 - \frac{1}{3} + \frac{1}{5} - \frac{1}{7} + \dots \right)$$

and

$$\frac{\pi}{4} = 1 - \frac{1}{3} + \frac{1}{5} - \frac{1}{7} + \dots$$

20. The function in Problem 9 is continuous at  $x = \pi/2$  so

$$\begin{aligned}1 &= f\left(\frac{\pi}{2}\right) = \frac{1}{\pi} + \frac{1}{2} + \sum_{n=2}^{\infty} \frac{1 + (-1)^n}{\pi(1 - n^2)} \cos \frac{n\pi}{2} \\ &= \frac{1}{\pi} + \frac{1}{2} + \frac{2}{3\pi} - \frac{2}{3 \cdot 5\pi} + \frac{2}{5 \cdot 7\pi} - \dots\end{aligned}$$

and

$$\pi = 1 + \frac{\pi}{2} + \frac{2}{3} - \frac{2}{3 \cdot 5} + \frac{2}{5 \cdot 7} - \dots$$

or

$$\frac{\pi}{4} = \frac{1}{2} + \frac{1}{1 \cdot 3} - \frac{1}{3 \cdot 5} + \frac{1}{5 \cdot 7} - \dots$$

## Exercises 11.2

21. (a) Letting  $c_0 = a_0/2$ ,  $c_n = (a_n - ib_n)$ , and  $c_{-n} = (a_n + ib_n)/2$  we have

$$\begin{aligned}
 f(x) &= \frac{a_0}{2} + \sum_{n=1}^{\infty} \left( a_n \cos \frac{n\pi}{p} x + b_n \sin \frac{n\pi}{p} x \right) \\
 &= c_0 + \sum_{n=1}^{\infty} \left( a_n \frac{e^{in\pi x/p} + e^{-in\pi x/p}}{2} + b_n \frac{e^{in\pi x/p} - e^{-in\pi x/p}}{2i} \right) \\
 &= c_0 + \sum_{n=1}^{\infty} \left( a_n \frac{e^{in\pi x/p} + e^{-in\pi x/p}}{2} - b_n \frac{ie^{in\pi x/p} - ie^{-in\pi x/p}}{2} \right) \\
 &= c_0 + \sum_{n=1}^{\infty} \left( \frac{a_n - ib_n}{2} e^{in\pi x/p} + \frac{a_n + ib_n}{2} e^{-in\pi x/p} \right) \\
 &= c_0 + \sum_{n=1}^{\infty} (c_n e^{in\pi x/p} + c_{-n} e^{i(-n)\pi x/p}) = \sum_{n=-\infty}^{\infty} c_n e^{in\pi x/p}.
 \end{aligned}$$

(b) Multiplying both sides of the expression in (a) by  $e^{-im\pi x/p}$  and integrating we obtain

$$\begin{aligned}
 \int_{-p}^p f(x) e^{-im\pi x/p} dx &= \int_{-p}^p \left( \sum_{n=-\infty}^{\infty} c_n e^{in\pi x/p} e^{-im\pi x/p} \right) dx \\
 &= \sum_{n=-\infty}^{\infty} c_n \int_{-p}^p e^{i(n-m)\pi x/p} dx \\
 &= \sum_{n \neq m} c_n \int_{-p}^p e^{i(n-m)\pi x/p} dx + c_m \int_{-p}^p e^{i(m-n)\pi x/p} dx \\
 &= \sum_{n \neq m} c_n \int_{-p}^p e^{i(n-m)\pi x/p} dx + c_m \int_{-p}^p dx \\
 &= \sum_{n \neq m} c_n \int_{-p}^p e^{i(n-m)\pi x/p} dx + 2pc_m.
 \end{aligned}$$

Recalling that

$$e^{iy} = \cos y + i \sin y \quad \text{and} \quad e^{-iy} = \cos y - i \sin y$$

we have for  $n - m$  an integer and  $n \neq m$

$$\begin{aligned}
 \int_{-p}^p e^{i(n-m)\pi x/p} dx &= \frac{p}{i(n-m)\pi} e^{i(n-m)\pi x/p} \Big|_{-p}^p \\
 &= \frac{p}{i(n-m)\pi} (e^{i(n-m)\pi} - e^{-i(n-m)\pi}) \\
 &= \frac{p}{i(n-m)\pi} [\cos(n-m)\pi + i \sin(n-m)\pi - \cos(n-m)\pi + i \sin(n-m)\pi] \\
 &= 0.
 \end{aligned}$$

Thus

$$\int_{-p}^p f(x)e^{-im\pi x/p} dx = 2pc_m$$

and

$$c_m = \frac{1}{2p} \int_{-p}^p f(x)e^{-im\pi x/p} dx.$$

22. Identifying  $f(x) = e^{-x}$  and  $p = \pi$ , we have

$$\begin{aligned} c_n &= \frac{1}{2\pi} \int_{-\pi}^{\pi} e^{-x} e^{-inx} dx = \frac{1}{2\pi} \int_{-\pi}^{\pi} e^{-(in+1)x} dx \\ &= -\frac{1}{2(in+1)\pi} e^{-(in+1)x} \Big|_{-\pi}^{\pi} \\ &= -\frac{1}{2(in+1)\pi} [e^{-(in+1)\pi} - e^{(in+1)\pi}] \\ &= \frac{e^{(in+1)\pi} - e^{-(in+1)\pi}}{2(in+1)\pi} \\ &= \frac{e^{\pi}(\cos n\pi + i \sin n\pi) - e^{-\pi}(\cos n\pi - i \sin n\pi)}{2(in+1)\pi} \\ &= \frac{(e^{\pi} - e^{-\pi} \cos n\pi)}{2(in+1)\pi} = \frac{(e^{\pi} - e^{-\pi})(-1)^n}{2(in+1)\pi}. \end{aligned}$$

Thus

$$f(x) = \sum_{n=-\infty}^{\infty} (-1)^n \frac{e^{\pi} - e^{-\pi}}{2(in+1)\pi} e^{inx}.$$

---

### Exercises 11.3

---

1. Since  $f(-x) = \sin(-3x) = -\sin 3x = -f(x)$ ,  $f(x)$  is an odd function.
2. Since  $f(-x) = -x \cos(-x) = -x \cos x = -f(x)$ ,  $f(x)$  is an odd function.
3. Since  $f(-x) = (-x)^2 - x = x^2 - x$ ,  $f(x)$  is neither even nor odd.
4. Since  $f(-x) = (-x)^3 + 4x = -(x^3 - 4x) = -f(x)$ ,  $f(x)$  is an odd function.
5. Since  $f(-x) = e^{|-x|} = e^{|x|} = f(x)$ ,  $f(x)$  is an even function.
6. Since  $f(-x) = e^{-x} - e^x = -f(x)$ ,  $f(x)$  is an odd function.
7. For  $0 < x < 1$ ,  $f(-x) = (-x)^2 = x^2 = -f(x)$ ,  $f(x)$  is an odd function.
8. For  $0 \leq x < 2$ ,  $f(-x) = -x + 5 = f(x)$ ,  $f(x)$  is an even function.
9. Since  $f(x)$  is not defined for  $x < 0$ , it is neither even nor odd.

### Exercises 11.3

10. Since  $f(-x) = |(-x)^5| = |x^5| = f(x)$ ,  $f(x)$  is an even function.

11. Since  $f(x)$  is an odd function, we expand in a sine series:

$$b_n = \frac{2}{\pi} \int_0^\pi 1 \cdot \sin nx \, dx = \frac{2}{n\pi} [1 - (-1)^n].$$

Thus

$$f(x) = \sum_{n=1}^{\infty} \frac{2}{n\pi} [1 - (-1)^n] \sin nx.$$

12. Since  $f(x)$  is an even function, we expand in a cosine series:

$$a_0 = \int_1^2 1 \, dx = 1$$

$$a_n = \int_1^2 \cos \frac{n\pi}{2} x \, dx = -\frac{2}{n\pi} \sin \frac{n\pi}{2}.$$

Thus

$$f(x) = \frac{1}{2} + \sum_{n=1}^{\infty} \frac{-2}{n\pi} \sin \frac{n\pi}{2} \cos \frac{n\pi}{2} x.$$

13. Since  $f(x)$  is an even function, we expand in a cosine series:

$$a_0 = \frac{2}{\pi} \int_0^\pi x \, dx = \pi$$

$$a_n = \frac{2}{\pi} \int_0^\pi x \cos nx \, dx = \frac{2}{n^2\pi} [(-1)^n - 1].$$

Thus

$$f(x) = \frac{\pi}{2} + \sum_{n=1}^{\infty} \frac{2}{n^2\pi} [(-1)^n - 1] \cos nx.$$

14. Since  $f(x)$  is an odd function, we expand in a sine series:

$$b_n = \frac{2}{\pi} \int_0^\pi x \sin nx \, dx = \frac{2}{n} (-1)^{n+1}.$$

Thus

$$f(x) = \sum_{n=1}^{\infty} \frac{2}{n} (-1)^{n+1} \sin nx.$$

15. Since  $f(x)$  is an even function, we expand in a cosine series:

$$a_0 = 2 \int_0^1 x^2 \, dx = \frac{2}{3}$$

$$a_n = 2 \int_0^1 x^2 \cos n\pi x \, dx = 2 \left( \frac{x^2}{n\pi} \sin n\pi x \Big|_0^1 - \frac{2}{n\pi} \int_0^1 x \sin n\pi x \, dx \right) = \frac{4}{n^2\pi^2} (-1)^n.$$

Thus

$$f(x) = \frac{1}{3} + \sum_{n=1}^{\infty} \frac{4}{n^2\pi^2} (-1)^n \cos n\pi x.$$



16. Since  $f(x)$  is an odd function, we expand in a sine series:

$$\begin{aligned} b_n &= 2 \int_0^1 x^2 \sin n\pi x \, dx = 2 \left( -\frac{x^2}{n\pi} \cos n\pi x \Big|_0^1 + \frac{2}{n\pi} \int_0^1 x \cos n\pi x \, dx \right) \\ &= \frac{2(-1)^{n+1}}{n\pi} + \frac{4}{n^3\pi^3} [(-1)^n - 1]. \end{aligned}$$

Thus

$$f(x) = \sum_{n=1}^{\infty} \left( \frac{2(-1)^{n+1}}{n\pi} + \frac{4}{n^3\pi^3} [(-1)^n - 1] \right) \sin n\pi x.$$

17. Since  $f(x)$  is an even function, we expand in a cosine series:

$$\begin{aligned} a_0 &= \frac{2}{\pi} \int_0^{\pi} (\pi^2 - x^2) \, dx = \frac{4}{3}\pi^2 \\ a_n &= \frac{2}{\pi} \int_0^{\pi} (\pi^2 - x^2) \cos nx \, dx = \frac{2}{\pi} \left( \frac{\pi^2 - x^2}{n} \sin nx \Big|_0^{\pi} + \frac{2}{n} \int_0^{\pi} x \sin nx \, dx \right) = \frac{4}{n^2} (-1)^{n+1}. \end{aligned}$$

Thus

$$f(x) = \frac{2}{3}\pi^2 + \sum_{n=1}^{\infty} \frac{4}{n^2} (-1)^{n+1} \cos nx \, dx.$$

18. Since  $f(x)$  is an odd function, we expand in a sine series:

$$\begin{aligned} b_n &= \frac{2}{\pi} \int_0^{\pi} x^3 \sin nx \, dx = \frac{2}{\pi} \left( -\frac{x^3}{n} \cos nx \Big|_0^{\pi} + \frac{3}{n} \int_0^{\pi} x^2 \cos nx \, dx \right) \\ &= \frac{2\pi^2}{n} (-1)^{n+1} - \frac{12}{n^2\pi} \int_0^{\pi} x \sin nx \, dx \\ &= \frac{2\pi^2}{n} (-1)^{n+1} - \frac{12}{n^2\pi} \left( -\frac{x}{n} \cos nx \Big|_0^{\pi} + \frac{1}{n} \int_0^{\pi} \cos nx \, dx \right) = \frac{2\pi^2}{n} (-1)^{n+1} + \frac{12}{n^3} (-1)^n. \end{aligned}$$

Thus

$$f(x) = \sum_{n=1}^{\infty} \left( \frac{2\pi^2}{n} (-1)^{n+1} + \frac{12}{n^3} (-1)^n \right) \sin nx.$$

19. Since  $f(x)$  is an odd function, we expand in a sine series:

$$b_n = \frac{2}{\pi} \int_0^{\pi} (x+1) \sin nx \, dx = \frac{2(\pi+1)}{n\pi} (-1)^{n+1} + \frac{2}{n\pi}.$$

Thus

$$f(x) = \sum_{n=1}^{\infty} \left( \frac{2(\pi+1)}{n\pi} (-1)^{n+1} + \frac{2}{n\pi} \right) \sin nx.$$

### Exercises 11.3

20. Since  $f(x)$  is an odd function, we expand in a sine series:

$$\begin{aligned} b_n &= 2 \int_0^1 (x-1) \sin n\pi x \, dx = 2 \left[ \int_0^1 x \sin n\pi x \, dx - \int_0^1 \sin n\pi x \, dx \right] \\ &= 2 \left[ \frac{1}{n^2\pi^2} \sin n\pi x - \frac{x}{n\pi} \cos n\pi x + \frac{1}{n\pi} \cos n\pi x \right]_0^1 = -\frac{2}{n\pi}. \end{aligned}$$

Thus

$$f(x) = -\sum_{n=1}^{\infty} \frac{2}{n\pi} \sin n\pi x.$$

21. Since  $f(x)$  is an even function, we expand in a cosine series:

$$\begin{aligned} a_0 &= \int_0^1 x \, dx + \int_1^2 1 \, dx = \frac{3}{2} \\ a_n &= \int_0^1 x \cos \frac{n\pi}{2} x \, dx + \int_1^2 \cos \frac{n\pi}{2} x \, dx = \frac{4}{n^2\pi^2} \left( \cos \frac{n\pi}{2} - 1 \right). \end{aligned}$$

Thus

$$f(x) = \frac{3}{4} + \sum_{n=1}^{\infty} \frac{4}{n^2\pi^2} \left( \cos \frac{n\pi}{2} - 1 \right) \cos \frac{n\pi}{2} x.$$

22. Since  $f(x)$  is an odd function, we expand in a sine series:

$$b_n = \frac{1}{\pi} \int_0^{\pi} x \sin \frac{n}{2} x \, dx + \int_{\pi}^{2\pi} \pi \sin \frac{n}{2} x \, dx = \frac{4}{n^2\pi} \sin \frac{n\pi}{2} + \frac{2}{n} (-1)^{n+1}.$$

Thus

$$f(x) = \sum_{n=1}^{\infty} \left( \frac{4}{n^2\pi} \sin \frac{n\pi}{2} + \frac{2}{n} (-1)^{n+1} \right) \sin \frac{n}{2} x.$$

23. Since  $f(x)$  is an even function, we expand in a cosine series:

$$\begin{aligned} a_0 &= \frac{2}{\pi} \int_0^{\pi} \sin x \, dx = \frac{4}{\pi} \\ a_n &= \frac{2}{\pi} \int_0^{\pi} \sin x \cos nx \, dx = \frac{1}{\pi} \int_0^{\pi} [\sin(n+1)x + \sin(1-n)x] \, dx \\ &= \frac{2}{\pi(1-n^2)} [1 + (-1)^n] \quad \text{for } n = 2, 3, 4, \dots \\ a_1 &= \frac{1}{\pi} \int_0^{\pi} \sin 2x \, dx = 0. \end{aligned}$$

Thus

$$f(x) = \frac{2}{\pi} + \sum_{n=2}^{\infty} \frac{2[1 + (-1)^n]}{\pi(1-n^2)} \cos nx.$$

Exercises 11.3

24. Since  $f(x)$  is an even function, we expand in a cosine series. [See the solution of Problem 10 in Exercise 11.2 for the computation of the integrals.]

$$a_0 = \frac{2}{\pi/2} \int_0^{\pi/2} \cos x \, dx = \frac{4}{\pi}$$

$$a_n = \frac{2}{\pi/2} \int_0^{\pi/2} \cos x \cos \frac{n\pi}{\pi/2} x \, dx = \frac{4(-1)^{n+1}}{\pi(4n^2 - 1)}$$

Thus

$$f(x) = \frac{2}{\pi} + \sum_{n=1}^{\infty} \frac{4(-1)^{n+1}}{\pi(4n^2 - 1)} \cos 2nx.$$

25.  $a_0 = 2 \int_0^{1/2} 1 \, dx = 1$

$$a_n = 2 \int_0^{1/2} 1 \cdot \cos n\pi x \, dx = \frac{2}{n\pi} \sin \frac{n\pi}{2}$$

$$b_n = 2 \int_0^{1/2} 1 \cdot \sin n\pi x \, dx = \frac{2}{n\pi} \left(1 - \cos \frac{n\pi}{2}\right)$$

$$f(x) = \frac{1}{2} + \sum_{n=1}^{\infty} \frac{2}{n\pi} \sin \frac{n\pi}{2} \cos n\pi x$$

$$f(x) = \sum_{n=1}^{\infty} \frac{2}{n\pi} \left(1 - \cos \frac{n\pi}{2}\right) \sin n\pi x$$

26.  $a_0 = 2 \int_{1/2}^1 1 \, dx = 1$

$$a_n = 2 \int_{1/2}^1 1 \cdot \cos n\pi x \, dx = -\frac{2}{n\pi} \sin \frac{n\pi}{2}$$

$$b_n = 2 \int_{1/2}^1 1 \cdot \sin n\pi x \, dx = \frac{2}{n\pi} \left(\cos \frac{n\pi}{2} + (-1)^{n+1}\right)$$

$$f(x) = \frac{1}{2} + \sum_{n=1}^{\infty} \left(-\frac{2}{n\pi} \sin \frac{n\pi}{2} \cos n\pi x\right)$$

$$f(x) = \sum_{n=1}^{\infty} \frac{2}{n\pi} \left(\cos \frac{n\pi}{2} + (-1)^{n+1}\right) \sin n\pi x$$

27.  $a_0 = \frac{4}{\pi} \int_0^{\pi/2} \cos x \, dx = \frac{4}{\pi}$

$$a_n = \frac{4}{\pi} \int_0^{\pi/2} \cos x \cos 2nx \, dx = \frac{2}{\pi} \int_0^{\pi/2} [\cos(2n+1)x + \cos(2n-1)x] \, dx = \frac{4(-1)^n}{\pi(1-4n^2)}$$

$$b_n = \frac{4}{\pi} \int_0^{\pi/2} \cos x \sin 2nx \, dx = \frac{2}{\pi} \int_0^{\pi/2} [\sin(2n+1)x + \sin(2n-1)x] \, dx = \frac{8n}{\pi(4n^2-1)}$$

### Exercises 11.3

$$f(x) = \frac{2}{\pi} + \sum_{n=1}^{\infty} \frac{4(-1)^n}{\pi(1-4n^2)} \cos 2nx$$

$$f(x) = \sum_{n=1}^{\infty} \frac{8n}{\pi(4n^2-1)} \sin 2nx$$

$$28. a_0 = \frac{2}{\pi} \int_0^{\pi} \sin x \, dx = \frac{4}{\pi}$$

$$a_n = \frac{2}{\pi} \int_0^{\pi} \sin x \cos nx \, dx = \frac{1}{\pi} \int_0^{\pi} [\sin(n+1)x - \sin(n-1)x] \, dx = \frac{2[(-1)^n + 1]}{\pi(1-n^2)} \quad \text{for } n = 2, 3, 4, \dots$$

$$b_n = \frac{2}{\pi} \int_0^{\pi} \sin x \sin nx \, dx = \frac{1}{\pi} \int_0^{\pi} [\cos(n-1)x - \cos(n+1)x] \, dx = 0 \quad \text{for } n = 2, 3, 4, \dots$$

$$a_1 = \frac{1}{\pi} \int_0^{\pi} \sin 2x \, dx = 0$$

$$b_1 = \frac{2}{\pi} \int_0^{\pi} \sin^2 x \, dx = 1$$

$$f(x) = \sin x$$

$$f(x) = \frac{2}{\pi} + \frac{2}{\pi} \sum_{n=2}^{\infty} \frac{(-1)^n + 1}{1-n^2} \cos nx$$

$$29. a_0 = \frac{2}{\pi} \left( \int_0^{\pi/2} x \, dx + \int_{\pi/2}^{\pi} (\pi - x) \, dx \right) = \frac{\pi}{2}$$

$$a_n = \frac{2}{\pi} \left( \int_0^{\pi/2} x \cos nx \, dx + \int_{\pi/2}^{\pi} (\pi - x) \cos nx \, dx \right) = \frac{2}{n^2\pi} \left( 2 \cos \frac{n\pi}{2} + (-1)^{n+1} - 1 \right)$$

$$b_n = \frac{2}{\pi} \left( \int_0^{\pi/2} x \sin nx \, dx + \int_{\pi/2}^{\pi} (\pi - x) \sin nx \, dx \right) = \frac{4}{n^2\pi} \sin \frac{n\pi}{2}$$

$$f(x) = \frac{\pi}{4} + \sum_{n=1}^{\infty} \frac{2}{n^2\pi} \left( 2 \cos \frac{n\pi}{2} + (-1)^{n+1} - 1 \right) \cos nx$$

$$f(x) = \sum_{n=1}^{\infty} \frac{4}{n^2\pi} \sin \frac{n\pi}{2} \sin nx$$

$$30. a_0 = \frac{1}{\pi} \int_{\pi}^{2\pi} (x - \pi) \, dx = \frac{\pi}{2}$$

$$a_n = \frac{1}{\pi} \int_{\pi}^{2\pi} (x - \pi) \cos \frac{n}{2}x \, dx = \frac{4}{n^2\pi} \left[ (-1)^n - \cos \frac{n\pi}{2} \right]$$

$$b_n = \frac{1}{\pi} \int_{\pi}^{2\pi} (x - \pi) \sin \frac{n}{2}x \, dx = \frac{2}{n} (-1)^{n+1} - \frac{4}{n^2\pi} \sin \frac{n\pi}{2}$$

$$f(x) = \frac{\pi}{4} + \sum_{n=1}^{\infty} \frac{4}{n^2\pi} \left[ (-1)^n - \cos \frac{n\pi}{2} \right] \cos \frac{n}{2}x$$

$$f(x) = \sum_{n=1}^{\infty} \left( \frac{2}{n} (-1)^{n+1} - \frac{4}{n^2 \pi} \sin \frac{n\pi}{2} \right) \sin \frac{n}{2} x$$

$$31. a_0 = \int_0^1 x dx + \int_1^2 1 dx = \frac{3}{2}$$

$$a_n = \int_0^1 x \cos \frac{n\pi}{2} x dx + \int_1^2 1 \cdot \cos \frac{n\pi}{2} x dx = \frac{4}{n^2 \pi^2} \left( \cos \frac{n\pi}{2} - 1 \right)$$

$$b_n = \int_0^1 x \sin \frac{n\pi}{2} x dx + \int_1^2 1 \cdot \sin \frac{n\pi}{2} x dx = \frac{4}{n^2 \pi^2} \sin \frac{n\pi}{2} + \frac{2}{n\pi} (-1)^{n+1}$$

$$f(x) = \frac{3}{4} + \sum_{n=1}^{\infty} \frac{4}{n^2 \pi^2} \left( \cos \frac{n\pi}{2} - 1 \right) \cos \frac{n\pi}{2} x$$

$$f(x) = \sum_{n=1}^{\infty} \left( \frac{4}{n^2 \pi^2} \sin \frac{n\pi}{2} + \frac{2}{n\pi} (-1)^{n+1} \right) \sin \frac{n\pi}{2} x$$

$$32. a_0 = \int_0^1 1 dx + \int_1^2 (2-x) dx = \frac{3}{2}$$

$$a_n = \int_0^1 1 \cdot \cos \frac{n\pi}{2} x dx + \int_1^2 (2-x) \cos \frac{n\pi}{2} x dx = \frac{4}{n^2 \pi^2} \left( \cos \frac{n\pi}{2} + (-1)^{n+1} \right)$$

$$b_n = \int_0^1 1 \cdot \sin \frac{n\pi}{2} x dx + \int_1^2 (2-x) \sin \frac{n\pi}{2} x dx = \frac{2}{n\pi} + \frac{4}{n^2 \pi^2} \sin \frac{n\pi}{2}$$

$$f(x) = \frac{3}{4} + \sum_{n=1}^{\infty} \frac{4}{n^2 \pi^2} \left( \cos \frac{n\pi}{2} + (-1)^{n+1} \right) \cos \frac{n\pi}{2} x$$

$$f(x) = \sum_{n=1}^{\infty} \left( \frac{2}{n\pi} + \frac{4}{n^2 \pi^2} \sin \frac{n\pi}{2} \right) \sin \frac{n\pi}{2} x$$

$$33. a_0 = 2 \int_0^1 (x^2 + x) dx = \frac{5}{3}$$

$$a_n = 2 \int_0^1 (x^2 + x) \cos n\pi x dx = \frac{2(x^2 + x)}{n\pi} \sin n\pi x \Big|_0^1 - \frac{2}{n\pi} \int_0^1 (2x+1) \sin n\pi x dx = \frac{2}{n^2 \pi^2} [3(-1)^n - 1]$$

$$b_n = 2 \int_0^1 (x^2 + x) \sin n\pi x dx = -\frac{2(x^2 + x)}{n\pi} \cos n\pi x \Big|_0^1 + \frac{2}{n\pi} \int_0^1 (2x+1) \cos n\pi x dx$$

$$= \frac{4}{n\pi} (-1)^{n+1} + \frac{4}{n^3 \pi^3} [(-1)^n - 1]$$

$$f(x) = \frac{5}{6} + \sum_{n=1}^{\infty} \frac{2}{n^2 \pi^2} [3(-1)^n - 1] \cos n\pi x$$

$$f(x) = \sum_{n=1}^{\infty} \left( \frac{4}{n\pi} (-1)^{n+1} + \frac{4}{n^3 \pi^3} [(-1)^n - 1] \right) \sin n\pi x$$

### Exercises 11.3

34.  $a_0 = \int_0^2 (2x - x^2) dx = \frac{4}{3}$   
 $a_n = \int_0^2 (2x - x^2) \cos \frac{n\pi}{2} x dx = \frac{8}{n^2\pi^2} [(-1)^{n+1} - 1]$   
 $b_n = \int_0^2 (2x - x^2) \sin \frac{n\pi}{2} x dx = \frac{16}{n^3\pi^3} [1 - (-1)^n]$   
 $f(x) = \frac{2}{3} + \sum_{n=1}^{\infty} \frac{8}{n^2\pi^2} [(-1)^{n+1} - 1] \cos \frac{n\pi}{2} x$   
 $f(x) = \sum_{n=1}^{\infty} \frac{16}{n^3\pi^3} [1 - (-1)^n] \sin \frac{n\pi}{2} x$
35.  $a_0 = \frac{1}{\pi} \int_0^{2\pi} x^2 dx = \frac{8}{3}\pi^2$   
 $a_n = \frac{1}{\pi} \int_0^{2\pi} x^2 \cos nx dx = \frac{4}{n^2}$   
 $b_n = \frac{1}{\pi} \int_0^{2\pi} x^2 \sin nx dx = -\frac{4\pi}{n}$   
 $f(x) = \frac{4}{3}\pi^2 + \sum_{n=1}^{\infty} \left( \frac{4}{n^2} \cos nx - \frac{4\pi}{n} \sin nx \right)$
36.  $a_0 = \frac{2}{\pi} \int_0^{\pi} x dx = \pi$   
 $a_n = \frac{2}{\pi} \int_0^{\pi} x \cos 2nx dx = 0$   
 $b_n = \frac{2}{\pi} \int_0^{\pi} x \sin 2nx dx = -\frac{1}{n}$   
 $f(x) = \frac{\pi}{2} + \sum_{n=1}^{\infty} \left( -\frac{1}{n} \sin 2nx \right)$
37.  $a_0 = 2 \int_0^1 (x+1) dx = 3$   
 $a_n = 2 \int_0^1 (x+1) \cos 2n\pi x dx = 0$   
 $b_n = 2 \int_0^1 (x+1) \sin 2n\pi x dx = -\frac{1}{n\pi}$   
 $f(x) = \frac{3}{2} - \sum_{n=1}^{\infty} \frac{1}{n\pi} \sin 2n\pi x$
38.  $a_0 = 2 \int_0^2 (2-x) dx = 2$

$$a_n = 2 \int_0^2 (2-x) \cos n\pi x \, dx = 0$$

$$b_n = 2 \int_0^2 (2-x) \sin n\pi x \, dx = \frac{2}{n\pi}$$

$$f(x) = 1 + \sum_{n=1}^{\infty} \frac{2}{n\pi} \sin n\pi x$$

39. We have

$$b_n = \frac{2}{\pi} \int_0^{\pi} 5 \sin nt \, dt = \frac{10}{n\pi} [1 - (-1)^n]$$

so that

$$f(t) = \sum_{n=1}^{\infty} \frac{10[1 - (-1)^n]}{n\pi} \sin nt.$$

Substituting the assumption  $x_p(t) = \sum_{n=1}^{\infty} B_n \sin nt$  into the differential equation then gives

$$x_p'' + 10x_p = \sum_{n=1}^{\infty} B_n(10 - n^2) \sin nt = \sum_{n=1}^{\infty} \frac{10[1 - (-1)^n]}{n\pi} \sin nt$$

and so  $B_n = \frac{10[1 - (-1)^n]}{n\pi(10 - n^2)}$ . Thus

$$x_p(t) = \frac{10}{\pi} \sum_{n=1}^{\infty} \frac{1 - (-1)^n}{n(10 - n^2)} \sin nt.$$

40. We have

$$b_n = \frac{2}{\pi} \int_0^1 (1-t) \sin n\pi t \, dt = \frac{2}{n\pi}$$

so that

$$f(t) = \sum_{n=1}^{\infty} \frac{2}{n\pi} \sin n\pi t.$$

Substituting the assumption  $x_p(t) = \sum_{n=1}^{\infty} B_n \sin n\pi t$  into the differential equation then gives

$$x_p'' + 10x_p = \sum_{n=1}^{\infty} B_n(10 - n^2\pi^2) \sin n\pi t = \sum_{n=1}^{\infty} \frac{2}{n\pi} \sin n\pi t$$

and so  $B_n = \frac{2}{n\pi(10 - n^2\pi^2)}$ . Thus

$$x_p(t) = \frac{2}{\pi} \sum_{n=1}^{\infty} \frac{1}{n(10 - n^2\pi^2)} \sin n\pi t.$$

### Exercises 11.3

41. We have

$$a_0 = \frac{2}{\pi} \int_0^\pi (2\pi t - t^2) dt = \frac{4}{3}\pi^2$$

$$a_n = \frac{2}{\pi} \int_0^\pi (2\pi t - t^2) \cos nt dt = -4n^2$$

so that

$$f(t) = \frac{2\pi^2}{3} + \sum_{n=1}^{\infty} \frac{(-4)}{n^2} \cos nt.$$

Substituting the assumption

$$x_p(t) = \frac{A_0}{2} + \sum_{n=1}^{\infty} A_n \cos nt$$

into the differential equation then gives

$$\frac{1}{4} x_p'' + 12x_p = 6A_0 + \sum_{n=1}^{\infty} A_n \left( -\frac{1}{4}n^2 + 12 \right) \cos nt = \frac{2\pi^2}{3} + \sum_{n=1}^{\infty} \frac{(-4)}{n^2} \cos nt$$

and  $A_0 = \frac{\pi^2}{9}$ ,  $A_n = \frac{16}{n^2(n^2 - 48)}$ . Thus

$$x_p(t) = \frac{\pi^2}{18} + 16 \sum_{n=1}^{\infty} \frac{1}{n^2(n^2 - 48)} \cos nt.$$

42. We have

$$a_0 = \frac{2}{(1/2)} \int_0^{1/2} t dt = \frac{1}{2}$$

$$a_n = \frac{2}{(1/2)} \int_0^{1/2} t \cos 2n\pi t dt = \frac{1}{n^2\pi^2} [(-1)^n - 1]$$

so that

$$f(t) = \frac{1}{4} + \sum_{n=1}^{\infty} \frac{(-1)^n - 1}{n^2\pi^2} \cos 2n\pi t.$$

Substituting the assumption

$$x_p(t) = \frac{A_0}{2} + \sum_{n=1}^{\infty} A_n \cos 2n\pi t$$

into the differential equation then gives

$$\frac{1}{4} x_p'' + 12x_p = 6A_0 + \sum_{n=1}^{\infty} A_n (12 - n^2\pi^2) \cos 2n\pi t = \frac{1}{4} + \sum_{n=1}^{\infty} \frac{(-1)^n - 1}{n^2\pi^2} \cos 2n\pi t$$

and  $A_0 = \frac{1}{24}$ ,  $A_n = \frac{(-1)^n - 1}{n^2\pi^2(12 - n^2\pi^2)}$ . Thus

$$x_p(t) = \frac{1}{48} + \frac{1}{\pi^2} \sum_{n=1}^{\infty} \frac{(-1)^n - 1}{n^2(12 - n^2\pi^2)} \cos 2n\pi t.$$



43. (a) The general solution is  $x(t) = c_1 \cos \sqrt{10}t + c_2 \sin \sqrt{10}t + x_p(t)$ , where

$$x_p(t) = \frac{10}{\pi} \sum_{n=1}^{\infty} \frac{1 - (-1)^n}{n(10 - n^2)} \sin nt.$$

The initial condition  $x(0) = 0$  implies  $c_1 + x_p(0) = 0$ . Since  $x_p(0) = 0$ , we have  $c_1 = 0$  and  $x(t) = c_2 \sin \sqrt{10}t + x_p(t)$ . Then  $x'(t) = c_2 \sqrt{10} \cos \sqrt{10}t + x'_p(t)$  and  $x'(0) = 0$  implies

$$c_2 \sqrt{10} + \frac{10}{\pi} \sum_{n=1}^{\infty} \frac{1 - (-1)^n}{10 - n^2} \cos 0 = 0.$$

Thus

$$c_2 = -\frac{\sqrt{10}}{\pi} \sum_{n=1}^{\infty} \frac{1 - (-1)^n}{10 - n^2}$$

and

$$x(t) = \frac{10}{\pi} \sum_{n=1}^{\infty} \frac{1 - (-1)^n}{10 - n^2} \left[ \frac{1}{n} \sin nt - \frac{1}{\sqrt{10}} \sin \sqrt{10}t \right].$$

(b) The graph is plotted using eight nonzero terms in the series expansion of  $x(t)$ .

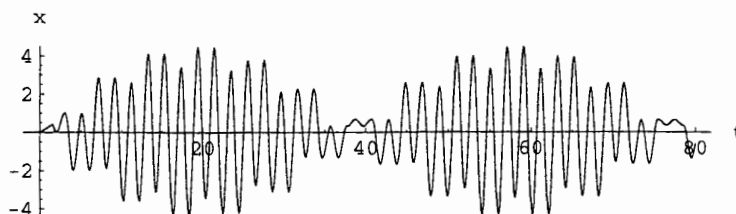

44. (a) The general solution is  $x(t) = c_1 \cos 4\sqrt{3}t + c_2 \sin 4\sqrt{3}t + x_p(t)$ , where

$$x_p(t) = \frac{\pi^2}{18} + 16 \sum_{n=1}^{\infty} \frac{1}{n^2(n^2 - 48)} \cos nt.$$

The initial condition  $x(0) = 0$  implies  $c_1 + x_p(0) = 1$  or

$$c_1 = 1 - x_p(0) = 1 - \frac{\pi^2}{18} - 16 \sum_{n=1}^{\infty} \frac{1}{n^2(n^2 - 48)}.$$

Now  $x'(t) = -4\sqrt{3}c_1 \sin 4\sqrt{3}t + 4c_2 \cos 4\sqrt{3}t + x'_p(t)$ , so  $x'(0) = 0$  implies  $4c_2 + x'_p(0) = 0$ . Since  $x'_p(0) = 0$ , we have  $c_2 = 0$  and

$$\begin{aligned} x(t) &= \left( 1 - \frac{\pi^2}{18} - 16 \sum_{n=1}^{\infty} \frac{1}{n^2(n^2 - 48)} \right) \cos 4\sqrt{3}t + \frac{\pi^2}{18} + 16 \sum_{n=1}^{\infty} \frac{1}{n^2(n^2 - 48)} \cos nt \\ &= \frac{\pi^2}{18} + \left( 1 - \frac{\pi^2}{18} \right) \cos 4\sqrt{3}t + 16 \sum_{n=1}^{\infty} \frac{1}{n^2(n^2 - 48)} [\cos nt - \cos 4\sqrt{3}t]. \end{aligned}$$

### Exercises 11.3

(b) The graph is plotted using five nonzero terms in the series expansion of  $x(t)$ .

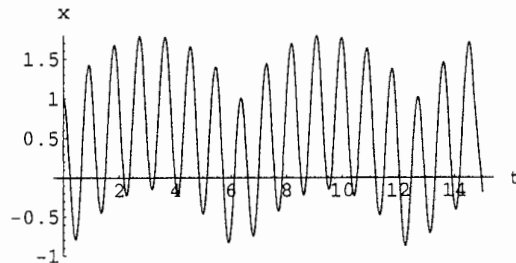

45. (a) We have

$$b_n = \frac{2}{L} \int_0^L \frac{w_0 x}{L} \sin \frac{n\pi}{L} x dx = \frac{2w_0}{n\pi} (-1)^{n+1}$$

so that

$$w(x) = \sum_{n=1}^{\infty} \frac{2w_0}{n\pi} (-1)^{n+1} \sin \frac{n\pi}{L} x.$$

(b) If we assume  $y(x) = \sum_{n=1}^{\infty} B_n \sin \frac{n\pi}{L} x$  then

$$y^{(4)} = \sum_{n=1}^{\infty} \frac{n^4 \pi^4}{L^4} B_n \sin \frac{n\pi}{L} x$$

and so the differential equation  $EIy^{(4)} = w(x)$  gives

$$B_n = \frac{2w_0(-1)^{n+1}L^4}{EI n^5 \pi^5}.$$

Thus

$$y(x) = \frac{2w_0 L^4}{EI \pi^5} \sum_{n=1}^{\infty} \frac{(-1)^{n+1}}{n^5} \sin \frac{n\pi}{L} x.$$

46. We have

$$b_n = \frac{2}{L} \int_{L/3}^{2L/3} w_0 \sin \frac{n\pi}{L} x dx = \frac{2w_0}{n\pi} \left[ \cos \frac{n\pi}{3} - \cos \frac{2n\pi}{3} \right]$$

so that

$$w(x) = \sum_{n=1}^{\infty} \frac{2w_0}{n\pi} \left[ \cos \frac{n\pi}{3} - \cos \frac{2n\pi}{3} \right] \sin \frac{n\pi}{L} x.$$

If we assume  $y(x) = \sum_{n=1}^{\infty} B_n \sin \frac{n\pi}{L} x$  then

$$y^{(4)} = \sum_{n=1}^{\infty} \frac{n^4 \pi^4}{L^4} B_n \sin \frac{n\pi}{L} x$$

and so the differential equation  $EIy^{(4)} = w(x)$  gives

$$B_n = 2w_0L^4 \frac{\cos \frac{n\pi}{3} - \cos \frac{2n\pi}{3}}{EI n^5 \pi^5}.$$

Thus

$$y(x) = \frac{2w_0L^4}{EI\pi^5} \sum_{n=1}^{\infty} \frac{\cos \frac{n\pi}{3} - \cos \frac{2n\pi}{3}}{n^5} \sin \frac{n\pi}{L} x.$$

47. We note that  $w(x)$  is  $2\pi$ -periodic and even. With  $p = \pi$  we find the cosine expansion of

$$f(x) = \begin{cases} w_0 & 0 < x < \pi/2 \\ 0, & \pi/2 < x < \pi. \end{cases}$$

We have

$$\begin{aligned} a_0 &= \frac{2}{\pi} \int_0^{\pi} f(x) dx = \frac{2}{\pi} \int_0^{\pi/2} w_0 dx = w_0 \\ a_n &= \frac{2}{\pi} \int_0^{\pi} f(x) \cos nx dx = \frac{2}{\pi} \int_0^{\pi/2} w_0 \cos nx dx = \frac{2w_0}{n\pi} \sin \frac{n\pi}{2}. \end{aligned}$$

Thus,

$$w(x) = \frac{w_0}{2} + \frac{2w_0}{\pi} \sum_{n=1}^{\infty} \frac{1}{n} \sin \frac{n\pi}{2} \cos nx.$$

Now we assume a particular solution of the form  $y_p(x) = A_0/2 + \sum_{n=1}^{\infty} A_n \cos nx$ . Then  $y_p^{(4)}(x) = \sum_{n=1}^{\infty} A_n n^4 \cos nx$  and substituting into the differential equation, we obtain

$$\begin{aligned} EIy_p^{(4)}(x) + ky_p(x) &= \frac{kA_0}{2} + \sum_{n=1}^{\infty} A_n(EIn^4 + k) \cos nx \\ &= \frac{w_0}{2} + \frac{2w_0}{\pi} \sum_{n=1}^{\infty} \frac{1}{n} \sin \frac{n\pi}{2} \cos nx. \end{aligned}$$

Thus

$$A_0 = \frac{w_0}{k} \quad \text{and} \quad A_n = \frac{2w_0}{\pi} \frac{\sin(n\pi/2)}{n(EIn^4 + k)},$$

and

$$y_p(x) = \frac{w_0}{2k} + \frac{2w_0}{\pi} \sum_{n=1}^{\infty} \frac{\sin(n\pi/2)}{n(EIn^4 + k)} \cos nx.$$

48. (a) If  $f$  and  $g$  are even and  $h(x) = f(x)g(x)$  then

$$h(-x) = f(-x)g(-x) = f(x)g(x) = h(x)$$

and  $h$  is even.

(c) If  $f$  is even and  $g$  is odd and  $h(x) = f(x)g(x)$  then

$$h(-x) = f(-x)g(-x) = f(x)[-g(x)] = -h(x)$$

### Exercises 11.3

and  $h$  is odd.

(d) Let  $h(x) = f(x) \pm g(x)$  where  $f$  and  $g$  are even. Then

$$h(-x) = f(-x) \pm g(-x) = f(x) \pm g(x),$$

and  $h$  is an even function.

(f) If  $f$  is even then

$$\int_{-a}^a f(x) dx = -\int_a^0 f(-u) du + \int_0^a f(x) dx = \int_0^a f(u) du + \int_0^a f(x) dx = 2 \int_0^a f(x) dx.$$

(g) If  $f$  is odd then

$$\begin{aligned} \int_{-a}^a f(x) dx &= -\int_{-a}^0 f(-x) dx + \int_0^a f(x) dx = \int_a^0 f(u) du + \int_0^a f(x) dx \\ &= -\int_0^a f(u) du + \int_0^a f(x) dx = 0. \end{aligned}$$

49. If  $f(x)$  is even then  $f(-x) = f(x)$ . If  $f(x)$  is odd then  $f(-x) = -f(x)$ . Thus, if  $f(x)$  is both even and odd,  $f(x) = f(-x) = -f(x)$ , and  $f(x) = 0$ .

50. For  $EIy^{(4)} + ky = 0$  the roots of the auxiliary equation are  $m_1 = \alpha + \alpha i$ ,  $m_2 = \alpha - \alpha i$ ,  $m_3 = -\alpha + \alpha i$ , and  $m_4 = -\alpha - \alpha i$ , where  $\alpha = (k/EI)^{1/4}/\sqrt{2}$ . Thus

$$y_c = e^{\alpha x}(c_1 \cos \alpha x + c_2 \sin \alpha x) + \alpha^{-\alpha x}(c_3 \cos \alpha x + c_4 \sin \alpha x).$$

We expect  $y(x)$  to be bounded as  $x \rightarrow \infty$ , so we must have  $c_1 = c_2 = 0$ . We also expect  $y(x)$  to be bounded as  $x \rightarrow -\infty$ , so we must have  $c_3 = c_4 = 0$ . Thus,  $y_c = 0$  and the solution of the differential equation in Problem 47 is  $y_p(x)$ .

51. The graph is obtained by summing the series from  $n = 1$  to 20. It appears that

$$f(x) = \begin{cases} x, & 0 < x < \pi \\ -\pi, & \pi < x < 2\pi. \end{cases}$$

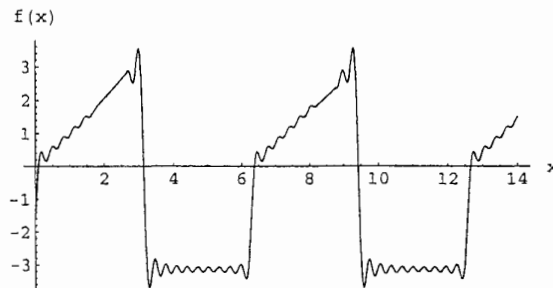

52. The graph is obtained by summing the series from  $n = 1$  to 10. It appears that

$$f(x) = \begin{cases} 1 - x, & 0 < x < 1 \\ 0, & 1 < x < 2. \end{cases}$$

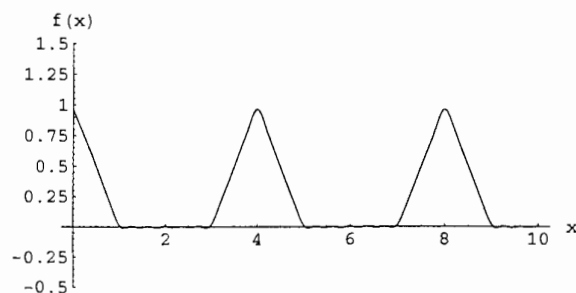

53. (a) The function in Problem 51 is not unique; it could also be

$$f(x) = \begin{cases} x, & 0 < x < \pi \\ 1, & x = \pi \\ -\pi, & \pi < x < 2\pi. \end{cases}$$

(b) The function in Problem 52 is not unique; it could also be

$$f(x) = \begin{cases} 0, & -2 < x < -1 \\ x + 1, & -1 < x < 0 \\ -x + 1, & 0 < x < 1 \\ 0, & 1 < x < 2. \end{cases}$$

---

## Exercises 11.4

---

1. For  $\lambda \leq 0$  the only solution of the boundary-value problem is  $y = 0$ . For  $\lambda > 0$  we have

$$y = c_1 \cos \sqrt{\lambda} x + c_2 \sin \sqrt{\lambda} x.$$

Now

$$y'(x) = -c_1 \sqrt{\lambda} \sin \sqrt{\lambda} x + c_2 \sqrt{\lambda} \cos \sqrt{\lambda} x$$

and  $y'(0) = 0$  implies  $c_2 = 0$ , so

$$y(1) + y'(1) = c_1(\cos \sqrt{\lambda} - \sqrt{\lambda} \sin \sqrt{\lambda}) = 0 \quad \text{or} \quad \cot \sqrt{\lambda} = \sqrt{\lambda}.$$

The eigenvalues are  $\lambda_n = x_n^2$  where  $x_1, x_2, x_3, \dots$  are the consecutive positive solutions of  $\cot \sqrt{\lambda} = \sqrt{\lambda}$ . The corresponding eigenfunctions are  $\cos \sqrt{\lambda_n} x = \cos x_n x$  for  $n = 1, 2, 3, \dots$ . Using a CAS

### Exercises 11.4

we find that the first four eigenvalues are 0.7402, 11.7349, 41.4388, and 90.8082 with corresponding eigenfunctions  $\cos 0.8603x$ ,  $\cos 3.4256x$ ,  $\cos 6.4373x$ , and  $\cos 9.5293x$ .

2. For  $\lambda < 0$  the only solution of the boundary-value problem is  $y = 0$ . For  $\lambda = 0$  we have  $y = c_1x + c_2$ . Now  $y' = c_1$  and the boundary conditions both imply  $c_1 + c_2 = 0$ . Thus,  $\lambda = 0$  is an eigenvalue with corresponding eigenfunction  $y_0 = x - 1$ .

For  $\lambda > 0$  we have

$$y = c_1 \cos \sqrt{\lambda}x + c_2 \sin \sqrt{\lambda}x$$

and

$$y' = -c_1 \sqrt{\lambda} \sin \sqrt{\lambda}x + c_2 \sqrt{\lambda} \cos \sqrt{\lambda}x.$$

The boundary conditions imply

$$c_1 + c_2 \sqrt{\lambda} = 0$$

$$c_1 \cos \sqrt{\lambda} + c_2 \sin \sqrt{\lambda} = 0$$

which gives

$$-c_2 \sqrt{\lambda} \cos \sqrt{\lambda} + c_2 \sin \sqrt{\lambda} = 0 \quad \text{or} \quad \tan \sqrt{\lambda} = \sqrt{\lambda}.$$

The eigenvalues are  $\lambda_n = x_n^2$  where  $x_1, x_2, x_3, \dots$  are the consecutive positive solutions of  $\tan \sqrt{\lambda} = \sqrt{\lambda}$ . The corresponding eigenfunctions are  $\sqrt{\lambda_n} \cos \sqrt{\lambda_n}x - \sin \sqrt{\lambda_n}x$  (obtained by taking  $c_2 = -1$  in the first equation of the system.) Using a CAS we find that the first four positive eigenvalues are 20.1907, 59.6795, 118.9000, and 197.858 with corresponding eigenfunctions  $4.4934 \cos 4.4934x - \sin 4.4934x$ ,  $7.7253 \cos 7.7253x - \sin 7.7253x$ ,  $10.9041 \cos 10.9041x - \sin 10.9041x$ , and  $14.0662 \cos 14.0662x - \sin 14.0662x$ .

3. For  $\lambda = 0$  the solution of  $y'' = 0$  is  $y = c_1x + c_2$ . The condition  $y'(0) = 0$  implies  $c_1 = 0$ , so  $\lambda = 0$  is an eigenvalue with corresponding eigenfunction 1.

For  $\lambda < 0$  we have  $y = c_1 \cosh \sqrt{-\lambda}x + c_2 \sinh \sqrt{-\lambda}x$  and  $y' = c_1 \sqrt{-\lambda} \sinh \sqrt{-\lambda}x + c_2 \sqrt{-\lambda} \cosh \sqrt{-\lambda}x$ . The condition  $y'(0) = 0$  implies  $c_2 = 0$  and so  $y = c_1 \cosh \sqrt{-\lambda}x$ . Now the condition  $y'(L) = 0$  implies  $c_1 = 0$ . Thus  $y = 0$  and there are no negative eigenvalues.

For  $\lambda > 0$  we have  $y = c_1 \cos \sqrt{\lambda}x + c_2 \sin \sqrt{\lambda}x$  and  $y' = -c_1 \sqrt{\lambda} \sin \sqrt{\lambda}x + c_2 \sqrt{\lambda} \cos \sqrt{\lambda}x$ . The condition  $y'(0) = 0$  implies  $c_2 = 0$  and so  $y = c_1 \cos \sqrt{\lambda}x$ . Now the condition  $y'(L) = 0$  implies  $-c_1 \sqrt{\lambda} \sin \sqrt{\lambda}L = 0$ . For  $c_1 \neq 0$  this condition will hold when  $\sqrt{\lambda}L = n\pi$  or  $\lambda = n^2\pi^2/L^2$ , where  $n = 1, 2, 3, \dots$ . These are the positive eigenvalues with corresponding eigenfunctions  $\cos(n\pi/L)x$ ,  $n = 1, 2, 3, \dots$ .

4. For  $\lambda < 0$  we have

$$y = c_1 \cosh \sqrt{-\lambda}x + c_2 \sinh \sqrt{-\lambda}x$$

$$y' = c_1 \sqrt{-\lambda} \sinh \sqrt{-\lambda}x + c_2 \sqrt{-\lambda} \cosh \sqrt{-\lambda}x.$$

Using the fact that  $\cosh x$  is an even function and  $\sinh x$  is odd we have

$$\begin{aligned} y(-L) &= c_1 \cosh(-\sqrt{-\lambda}L) + c_2 \sinh(-\sqrt{-\lambda}L) \\ &= c_1 \cosh \sqrt{-\lambda}L - c_2 \sinh \sqrt{-\lambda}L \end{aligned}$$

and

$$\begin{aligned} y'(-L) &= c_1 \sqrt{-\lambda} \sinh(-\sqrt{-\lambda}L) + c_2 \sqrt{-\lambda} \cosh(-\sqrt{-\lambda}L) \\ &= -c_1 \sqrt{-\lambda} \sinh \sqrt{-\lambda}L + c_2 \sqrt{-\lambda} \cosh \sqrt{-\lambda}L. \end{aligned}$$

The boundary conditions imply

$$c_1 \cosh \sqrt{-\lambda}L - c_2 \sinh \sqrt{-\lambda}L = c_1 \cosh \sqrt{-\lambda}L + c_2 \sinh \sqrt{-\lambda}L$$

or

$$2c_2 \sinh \sqrt{-\lambda}L = 0$$

and

$$-c_1 \sqrt{-\lambda} \sinh \sqrt{-\lambda}L + c_2 \sqrt{-\lambda} \cosh \sqrt{-\lambda}L = c_1 \sqrt{-\lambda} \sinh \sqrt{-\lambda}L + c_2 \sqrt{-\lambda} \cosh \sqrt{-\lambda}L$$

or

$$2c_1 \sqrt{-\lambda} \sinh \sqrt{-\lambda}L = 0.$$

Since  $\sqrt{-\lambda}L \neq 0$ ,  $c_1 = c_2 = 0$  and the only solution of the boundary-value problem in this case is  $y = 0$ .

For  $\lambda = 0$  we have

$$\begin{aligned} y &= c_1 x + c_2 \\ y' &= c_1. \end{aligned}$$

From  $y(-L) = y(L)$  we obtain

$$-c_1 L + c_2 = c_1 L + c_2.$$

Then  $c_1 = 0$  and  $y = 1$  is an eigenfunction corresponding to the eigenvalue  $\lambda = 0$ .

For  $\lambda > 0$  we have

$$\begin{aligned} y &= c_1 \cos \sqrt{\lambda}x + c_2 \sin \sqrt{\lambda}x \\ y' &= -c_1 \sqrt{\lambda} \sin \sqrt{\lambda}x + c_2 \sqrt{\lambda} \cos \sqrt{\lambda}x. \end{aligned}$$

The first boundary condition implies

$$c_1 \cos \sqrt{\lambda}L - c_2 \sin \sqrt{\lambda}L = c_1 \cos \sqrt{\lambda}L + c_2 \sin \sqrt{\lambda}L$$

or

$$2c_2 \sin \sqrt{\lambda}L = 0.$$

### Exercises 11.4

Thus, if  $c_1 = 0$  and  $c_2 \neq 0$ ,

$$\sqrt{\lambda} L = n\pi \quad \text{or} \quad \lambda = \frac{n^2\pi^2}{L^2}, \quad n = 1, 2, 3, \dots$$

The corresponding eigenfunctions are  $\sin \frac{n\pi}{L}x$ , for  $n = 1, 2, 3, \dots$ . Similarly, the second boundary condition implies

$$2c_1\sqrt{\lambda} \sin \sqrt{\lambda} L = 0.$$

If  $c_2 = 0$  and  $c_1 \neq 0$ ,

$$\sqrt{\lambda} L = n\pi \quad \text{or} \quad \lambda = \frac{n^2\pi^2}{L^2}, \quad n = 1, 2, 3, \dots,$$

and the corresponding eigenfunctions are  $\cos \frac{n\pi}{L}x$ , for  $n = 1, 2, 3, \dots$ .

5. The eigenfunctions are  $\cos \sqrt{\lambda_n} x$  where  $\cot \sqrt{\lambda_n} = \sqrt{\lambda_n}$ . Thus

$$\begin{aligned} \|\cos \sqrt{\lambda_n} x\|^2 &= \int_0^1 \cos^2 \sqrt{\lambda_n} x \, dx = \frac{1}{2} \int_0^1 (1 + \cos 2\sqrt{\lambda_n} x) \, dx \\ &= \frac{1}{2} \left( x + \frac{1}{2\sqrt{\lambda_n}} \sin 2\sqrt{\lambda_n} x \right) \Big|_0^1 = \frac{1}{2} \left( 1 + \frac{1}{2\sqrt{\lambda_n}} \sin 2\sqrt{\lambda_n} \right) \\ &= \frac{1}{2} \left[ 1 + \frac{1}{2\sqrt{\lambda_n}} (2 \sin \sqrt{\lambda_n} \cos \sqrt{\lambda_n}) \right] \\ &= \frac{1}{2} \left[ 1 + \frac{1}{\sqrt{\lambda_n}} \sin \sqrt{\lambda_n} \cot \sqrt{\lambda_n} \sin \sqrt{\lambda_n} \right] \\ &= \frac{1}{2} \left[ 1 + \frac{1}{\sqrt{\lambda_n}} (\sin \sqrt{\lambda_n}) \sqrt{\lambda_n} (\sin \sqrt{\lambda_n}) \right] = \frac{1}{2} (1 + \sin^2 \sqrt{\lambda_n}). \end{aligned}$$

6. The eigenfunctions are  $\sin \sqrt{\lambda_n} x$  where  $\tan \sqrt{\lambda_n} = -\lambda_n$ . Thus

$$\begin{aligned} \|\sin \sqrt{\lambda_n} x\|^2 &= \int_0^1 \sin^2 \sqrt{\lambda_n} x \, dx = \frac{1}{2} \int_0^1 (1 - \cos 2\sqrt{\lambda_n} x) \, dx \\ &= \frac{1}{2} \left( x - \frac{1}{2\sqrt{\lambda_n}} \sin 2\sqrt{\lambda_n} x \right) \Big|_0^1 = \frac{1}{2} \left( 1 - \frac{1}{2\sqrt{\lambda_n}} \sin 2\sqrt{\lambda_n} \right) \\ &= \frac{1}{2} \left[ 1 - \frac{1}{2\sqrt{\lambda_n}} (2 \sin \sqrt{\lambda_n} \cos \sqrt{\lambda_n}) \right] \\ &= \frac{1}{2} \left[ 1 - \frac{1}{\sqrt{\lambda_n}} \tan \sqrt{\lambda_n} \cos \sqrt{\lambda_n} \cos \sqrt{\lambda_n} \right] \\ &= \frac{1}{2} \left[ 1 - \frac{1}{\sqrt{\lambda_n}} (-\sqrt{\lambda_n} \cos^2 \sqrt{\lambda_n}) \right] = \frac{1}{2} (1 + \cos^2 \sqrt{\lambda_n}). \end{aligned}$$



7. (a) If  $\lambda \leq 0$  the initial conditions imply  $y = 0$ . For  $\lambda > 0$  the general solution of the Cauchy-Euler differential equation is  $y = c_1 \cos(\sqrt{\lambda} \ln x) + c_2 \sin(\sqrt{\lambda} \ln x)$ . The condition  $y(1) = 0$  implies  $c_1 = 0$ , so that  $y = c_2 \sin(\sqrt{\lambda} \ln x)$ . The condition  $y(5) = 0$  implies  $\sqrt{\lambda} \ln 5 = n\pi$ ,  $n = 1, 2, 3, \dots$ . Thus, the eigenvalues are  $n^2\pi^2/(\ln 5)^2$  for  $n = 1, 2, 3, \dots$ , with corresponding eigenfunctions  $\sin[(n\pi/\ln 5) \ln x]$ .

(b) The self-adjoint form is

$$\frac{d}{dx}[xy'] + \frac{\lambda}{x}y = 0.$$

(c) An orthogonality relation is

$$\int_1^5 \sin\left(\frac{m\pi}{\ln 5} \ln x\right) \sin\left(\frac{n\pi}{\ln 5} \ln x\right) dx = 0.$$

8. (a) The roots of the auxiliary equation  $m^2 + m + \lambda = 0$  are  $\frac{1}{2}(-1 \pm \sqrt{1-4\lambda})$ . When  $\lambda = 0$  the general solution of the differential equation is  $c_1 + c_2e^{-x}$ . The initial conditions imply  $c_1 + c_2 = 0$  and  $c_1 + c_2e^{-2} = 0$ . Since the determinant of the coefficients is not 0, the only solution of this homogeneous system is  $c_1 = c_2 = 0$ , in which case  $y = 0$ . Similarly, if  $0 < \lambda < \frac{1}{4}$ , the general solution is

$$y = c_1 e^{\frac{1}{2}(-1+\sqrt{1-4\lambda})x} + c_2 e^{\frac{1}{2}(-1-\sqrt{1-4\lambda})x}.$$

In this case the initial conditions again imply  $c_1 = c_2 = 0$ , and so  $y = 0$ . Now, for  $\lambda > \frac{1}{4}$ , the general solution of the differential equation is

$$y = c_1 e^{-x/2} \cos \sqrt{4\lambda-1} x + c_2 e^{-x/2} \sin \sqrt{4\lambda-1} x.$$

The condition  $y(0) = 0$  implies  $c_1 = 0$  so  $y = c_2 e^{-x/2} \sin \sqrt{4\lambda-1} x$ . From

$$y(2) = c_2 e^{-1} \sin 2\sqrt{4\lambda-1} = 0$$

we see that the eigenvalues are determined by  $2\sqrt{4\lambda-1} = n\pi$  for  $n = 1, 2, 3, \dots$ . Thus, the eigenvalues are  $n^2\pi^2/4^2 + 1/4$  for  $n = 1, 2, 3, \dots$ , with corresponding eigenfunctions  $e^{-x/2} \sin \frac{n\pi}{2} x$ .

(b) The self-adjoint form is

$$\frac{d}{dx}[e^x y'] + \lambda e^x y = 0.$$

(c) An orthogonality relation is

$$\int_0^2 e^x \left( e^{-x/2} \sin \frac{m\pi}{2} x \right) \left( e^{-x/2} \cos \frac{n\pi}{2} x \right) dx = \int_0^2 \left( \sin \frac{m\pi}{2} x \right) \left( \cos \frac{n\pi}{2} x \right) dx = 0.$$

9. To obtain the self-adjoint form we note that an integrating factor is  $(1/x)e^{\int(1-x)dx/x} = e^{-x}$ . Thus, the differential equation is

$$xe^{-x}y'' + (1-x)e^{-x}y' + ne^{-x}y = 0$$

### Exercises 11.4

and the self-adjoint form is

$$\frac{d}{dx} [xe^{-x}y'] + ne^{-x}y = 0.$$

Identifying the weight function  $p(x) = e^{-x}$  and noting that since  $r(x) = xe^{-x}$ ,  $r(0) = 0$  and  $\lim_{x \rightarrow \infty} r(x) = 0$ , we have the orthogonality relation

$$\int_0^{\infty} e^{-x} L_n(x) L_m(x) dx = 0, \quad m \neq n.$$

10. To obtain the self-adjoint form we note that an integrating factor is  $e^{\int -2x dx} = e^{-x^2}$ . Thus, the differential equation is

$$e^{-x^2} y'' - 2xe^{-x^2} y' + 2ne^{-x^2} y = 0$$

and the self-adjoint form is

$$\frac{d}{dx} [e^{-x^2} y'] + 2ne^{-x^2} y = 0.$$

Identifying the weight function  $p(x) = 2e^{-x^2}$  and noting that since  $r(x) = e^{-x^2}$ ,  $\lim_{x \rightarrow -\infty} r(x) = \lim_{x \rightarrow \infty} r(x) = 0$ , we have the orthogonality relation

$$\int_{-\infty}^{\infty} 2e^{-x^2} H_n(x) H_m(x) dx = 0, \quad m \neq n.$$

11. (a) The differential equation is

$$(1+x^2)y'' + 2xy' + \frac{\lambda}{1+x^2}y = 0.$$

Letting  $x = \tan \theta$  we have  $\theta = \tan^{-1} x$  and

$$\frac{dy}{dx} = \frac{dy}{d\theta} \frac{d\theta}{dx} = \frac{1}{1+x^2} \frac{dy}{d\theta}$$

$$\begin{aligned} \frac{d^2y}{dx^2} &= \frac{d}{dx} \left[ \frac{1}{1+x^2} \frac{dy}{d\theta} \right] = \frac{1}{1+x^2} \left( \frac{d^2y}{d\theta^2} \frac{d\theta}{dx} \right) - \frac{2x}{(1+x^2)^2} \frac{dy}{d\theta} \\ &= \frac{1}{(1+x^2)^2} \frac{d^2y}{d\theta^2} - \frac{2x}{(1+x^2)^2} \frac{dy}{d\theta}. \end{aligned}$$

The differential equation can then be written in terms of  $y(\theta)$  as

$$\begin{aligned} (1+x^2) \left[ \frac{1}{(1+x^2)^2} \frac{d^2y}{d\theta^2} - \frac{2x}{(1+x^2)^2} \frac{dy}{d\theta} \right] + 2x \left[ \frac{1}{1+x^2} \frac{dy}{d\theta} \right] + \frac{\lambda}{1+x^2} y \\ = \frac{1}{1+x^2} \frac{d^2y}{d\theta^2} + \frac{\lambda}{1+x^2} y = 0 \end{aligned}$$

or

$$\frac{d^2y}{d\theta^2} + \lambda y = 0.$$

The boundary conditions become  $y(0) = y(\pi/4) = 0$ . For  $\lambda \leq 0$  the only solution of the boundary-value problem is  $y = 0$ . For  $\lambda > 0$  the general solution of the differential equation is  $y = c_1 \cos \sqrt{\lambda} \theta + c_2 \sin \sqrt{\lambda} \theta$ . The condition  $y(0) = 0$  implies  $c_1 = 0$  so  $y = c_2 \sin \sqrt{\lambda} \theta$ . Now the condition  $y(\pi/4) = 0$  implies  $c_2 \sin \sqrt{\lambda} \pi/4 = 0$ . For  $c_2 \neq 0$  this condition will hold when  $\sqrt{\lambda} \pi/4 = n\pi$  or  $\lambda = 16n^2$ , where  $n = 1, 2, 3, \dots$ . These are the eigenvalues with corresponding eigenfunctions  $\sin 4n\theta = \sin(4n \tan^{-1} x)$ , for  $n = 1, 2, 3, \dots$ .

(b) An orthogonality relation is

$$\int_0^1 \frac{1}{x^2 + 1} \sin(4m \tan^{-1} x) \sin(4n \tan^{-1} x) dx = 0.$$

12. (a) This is the parametric Bessel equation with  $\nu = 1$ . The general solution is

$$y = c_1 J_1(\lambda x) c_2 Y_1(\lambda x).$$

Since  $Y$  is bounded at 0 we must have  $c_2 = 0$ , so that  $y = c_1 J_1(\lambda x)$ . The condition  $J_1(3\lambda) = 0$  defines the eigenvalues  $\lambda_1, \lambda_2, \lambda_3, \dots$ . (When  $\lambda = 0$  the differential equation is Cauchy-Euler and the only solution satisfying the boundary condition is  $y = 0$ , so  $\lambda = 0$  is not an eigenvalue.)

(b) From Table 6.1 in Section 6.3 in the text we see that eigenvalues are determined by  $3\lambda_1 = 3.832$ ,  $3\lambda_2 = 7.016$ ,  $3\lambda_3 = 10.173$ , and  $3\lambda_4 = 13.323$ . The first four eigenvalues are thus  $\lambda_1 = 1.2773$ ,  $\lambda_2 = 2.3387$ ,  $\lambda_3 = 3.391$ , and  $\lambda_4 = 4.441$ .

13. When  $\lambda = 0$  the differential equation is  $r(x)y'' + r'(x)y' = 0$ . By inspection we see that  $y = 1$  is a solution of the boundary-value problem. Thus,  $\lambda = 0$  is an eigenvalue.

14. (a) An orthogonality relation is

$$\int_0^1 \cos x_m x \cos x_n x = 0$$

where  $x_m \neq x_n$  are positive solutions of  $\cot x = x$ .

(b) Referring to Problem 1 we use a CAS to compute

$$\int_0^1 (\cos 0.8603x)(\cos 3.4256x) dx = -1.8771 \times 10^{-6}.$$

15. (a) An orthogonality relation is

$$\int_0^1 (x_m \cos x_m x - \sin x_m x)(x_n \cos x_n x - \sin x_n x) dx = 0$$

where  $x_m \neq x_n$  are positive solutions of  $\tan x = x$ .

(b) Referring to Problem 2 we use a CAS to compute

$$\int_0^1 (4.4934 \cos 4.4934x - \sin 4.4934x)(7.7253 \cos 7.7253x - \sin 7.7253x) dx = -2.5650 \times 10^{-4}.$$

---

**Exercises 11.5**

---

1. Identifying  $b = 3$ , the first four eigenvalues are

$$\lambda_1 = \frac{3.832}{3} \approx 1.277$$

$$\lambda_2 = \frac{7.016}{3} \approx 2.339$$

$$\lambda_3 = \frac{10.173}{3} = 3.391$$

$$\lambda_4 = \frac{13.323}{3} \approx 4.441.$$

2. We first note from Case III in the text that 0 is an eigenvalue. Now, since  $J'_0(2\lambda) = 0$  is equivalent to  $J_1(2\lambda) = 0$ , the next three eigenvalues are

$$\lambda_2 = \frac{3.832}{2} = 1.916$$

$$\lambda_3 = \frac{7.016}{2} = 3.508$$

$$\lambda_4 = \frac{10.173}{2} = 5.087.$$

3. The boundary condition indicates that we use (15) and (16) in the text. With  $b = 2$  we obtain

$$c_i = \frac{2}{4J_1^2(2\lambda_i)} \int_0^2 x J_0(\lambda_i x) dx$$

$t = \lambda_i x$	$dt = \lambda_i dx$
-------------------	---------------------

$$= \frac{1}{2J_1^2(2\lambda_i)} \cdot \frac{1}{\lambda_i^2} \int_0^{2\lambda_i} t J_0(t) dt$$

$$= \frac{1}{2\lambda_i^2 J_1^2(2\lambda_i)} \int_0^{2\lambda_i} \frac{d}{dt} [t J_1(t)] dt \quad \text{[From (4) in the text]}$$

$$= \frac{1}{2\lambda_i^2 J_1^2(2\lambda_i)} t J_1(t) \Big|_0^{2\lambda_i}$$

$$= \frac{1}{\lambda_i J_1(2\lambda_i)}.$$

Thus

$$f(x) = \sum_{i=1}^{\infty} \frac{1}{\lambda_i J_1(2\lambda_i)} J_0(\lambda_i x).$$

Exercises 11.5

4. The boundary condition indicates that we use (19) and (20) in the text. With  $b = 2$  we obtain

$$\begin{aligned}
 c_1 &= \frac{2}{4} \int_0^2 x \, dx = \frac{2}{4} \left. \frac{x^2}{2} \right|_0^2 = 1, \\
 c_i &= \frac{2}{4J_0^2(2\lambda_i)} \int_0^2 x J_0(\lambda_i x) \, dx && \boxed{t = \lambda_i x \quad dt = \lambda_i \, dx} \\
 &= \frac{1}{2J_0^2(2\lambda_i)} \cdot \frac{1}{\lambda_i^2} \int_0^{2\lambda_i} t J_0(t) \, dt \\
 &= \frac{1}{2\lambda_i^2 J_0^2(2\lambda_i)} \int_0^{2\lambda_i} \frac{d}{dt} [t J_1(t)] \, dt && \text{[From (4) in the text]} \\
 &= \frac{1}{2\lambda_i^2 J_0^2(2\lambda_i)} t J_1(t) \Big|_0^{2\lambda_i} \\
 &= \frac{J_1(2\lambda_i)}{\lambda_i J_0^2(2\lambda_i)}.
 \end{aligned}$$

Now since  $J_0'(2\lambda_i) = 0$  is equivalent to  $J_1(2\lambda_i) = 0$  we conclude  $c_i = 0$  for  $i = 2, 3, 4, \dots$ . Thus the expansion of  $f$  on  $0 < x < 2$  consists of a series with one nontrivial term:

$$f(x) = c_1 = 1.$$

5. The boundary condition indicates that we use (17) and (18) in the text. With  $b = 2$  and  $h = 1$  we obtain

$$\begin{aligned}
 c_i &= \frac{2\lambda_i^2}{(4\lambda_i^2 + 1)J_0^2(2\lambda_i)} \int_0^2 x J_0(\lambda_i x) \, dx && \boxed{t = \lambda_i x \quad dt = \lambda_i \, dx} \\
 &= \frac{2\lambda_i^2}{(4\lambda_i^2 + 1)J_0^2(2\lambda_i)} \cdot \frac{1}{\lambda_i^2} \int_0^{2\lambda_i} t J_0(t) \, dt \\
 &= \frac{2}{(4\lambda_i^2 + 1)J_0^2(2\lambda_i)} \int_0^{2\lambda_i} \frac{d}{dt} [t J_1(t)] \, dt && \text{[From (4) in the text]} \\
 &= \frac{2}{(4\lambda_i^2 + 1)J_0^2(2\lambda_i)} t J_1(t) \Big|_0^{2\lambda_i} \\
 &= \frac{4\lambda_i J_1(2\lambda_i)}{(4\lambda_i^2 + 1)J_0^2(2\lambda_i)}.
 \end{aligned}$$

Thus

$$f(x) = 4 \sum_{i=1}^{\infty} \frac{\lambda_i J_1(2\lambda_i)}{(4\lambda_i^2 + 1)J_0^2(2\lambda_i)} J_0(\lambda_i x).$$

### Exercises 11.5

6. Writing the boundary condition in the form

$$2J_0(2\lambda) + 2\lambda J_0'(2\lambda) = 0$$

we identify  $b = 2$  and  $h = 2$ . Using (17) and (18) in the text we obtain

$$\begin{aligned} c_i &= \frac{2\lambda_i^2}{(4\lambda_i^2 + 4)J_0^2(2\lambda_i)} \int_0^2 x J_0(\lambda_i x) dx && \boxed{t = \lambda_i x \quad dt = \lambda_i dx} \\ &= \frac{\lambda_i^2}{2(\lambda_i^2 + 1)J_0^2(2\lambda_i)} \cdot \frac{1}{\lambda_i^2} \int_0^{2\lambda_i} t J_0(t) dt \\ &= \frac{1}{2(\lambda_i^2 + 1)J_0^2(2\lambda_i)} \int_0^{2\lambda_i} \frac{d}{dt} [t J_1(t)] dt && \text{[From (4) in the text]} \\ &= \frac{1}{2(\lambda_i^2 + 1)J_0^2(2\lambda_i)} t J_1(t) \Big|_0^{2\lambda_i} \\ &= \frac{\lambda_i J_1(2\lambda_i)}{(\lambda_i^2 + 1)J_0^2(2\lambda_i)}. \end{aligned}$$

Thus

$$f(x) = \sum_{i=1}^{\infty} \frac{\lambda_i J_1(2\lambda_i)}{(\lambda_i^2 + 1)J_0^2(2\lambda_i)} J_0(\lambda_i x).$$

7. The boundary condition indicates that we use (17) and (18) in the text. With  $n = 1$ ,  $b = 4$ , and  $h = 3$  we obtain

$$\begin{aligned} c_i &= \frac{2\lambda_i^2}{(16\lambda_i^2 - 1 + 9)J_1^2(4\lambda_i)} \int_0^4 x J_1(\lambda_i x) 5x dx && \boxed{t = \lambda_i x \quad dt = \lambda_i dx} \\ &= \frac{5\lambda_i^2}{4(2\lambda_i^2 + 1)J_1^2(4\lambda_i)} \cdot \frac{1}{\lambda_i^3} \int_0^{4\lambda_i} t^2 J_1(t) dt \\ &= \frac{5}{4\lambda_i(2\lambda_i^2 + 1)J_1^2(4\lambda_i)} \int_0^{4\lambda_i} \frac{d}{dt} [t^2 J_2(t)] dt && \text{[From (4) in the text]} \\ &= \frac{5}{4\lambda_i(2\lambda_i^2 + 1)J_1^2(4\lambda_i)} t^2 J_2(t) \Big|_0^{4\lambda_i} \\ &= \frac{20\lambda_i J_2(4\lambda_i)}{(2\lambda_i^2 + 1)J_1^2(4\lambda_i)}. \end{aligned}$$

Thus

$$f(x) = 20 \sum_{i=1}^{\infty} \frac{\lambda_i J_2(4\lambda_i)}{(2\lambda_i^2 + 1)J_1^2(4\lambda_i)} J_1(\lambda_i x).$$

Exercises 11.5

8. The boundary condition indicates that we use (15) and (16) in the text. With  $n = 2$  and  $b = 1$  we obtain

$$\begin{aligned}
 c_1 &= \frac{2}{J_3^2(\lambda_i)} \int_0^1 x J_2(\lambda_i x) x^2 dx && \boxed{t = \lambda_i x \quad dt = \lambda_i dx} \\
 &= \frac{2}{J_3^2(\lambda_i)} \cdot \frac{1}{\lambda_i^4} \int_0^{\lambda_i} t^3 J_2(t) dt \\
 &= \frac{2}{\lambda_i^4 J_3^2(\lambda_i)} \int_0^{\lambda_i} \frac{d}{dt} [t^3 J_3(t)] dt && \text{[From (4) in the text]} \\
 &= \frac{2}{\lambda_i^4 J_3^2(\lambda_i)} t^3 J_3(t) \Big|_0^{\lambda_i} \\
 &= \frac{2}{\lambda_i J_3(\lambda_i)}.
 \end{aligned}$$

Thus

$$f(x) = 2 \sum_{i=1}^{\infty} \frac{1}{\lambda_i J_3(\lambda_i)} J_2(\lambda_i x).$$

9. The boundary condition indicates that we use (19) and (20) in the text. With  $b = 3$  we obtain

$$\begin{aligned}
 c_1 &= \frac{2}{9} \int_0^3 x x^2 dx = \frac{2}{9} \frac{x^4}{4} \Big|_0^3 = \frac{9}{2}, \\
 c_i &= \frac{2}{9J_0^2(3\lambda_i)} \int_0^3 x J_0(\lambda_i x) x^2 dx && \boxed{t = \lambda_i x \quad dt = \lambda_i dx} \\
 &= \frac{2}{9J_0^2(3\lambda_i)} \cdot \frac{1}{\lambda_i^4} \int_0^{3\lambda_i} t^3 J_0(t) dt \\
 &= \frac{2}{9\lambda_i^4 J_0^2(3\lambda_i)} \int_0^{3\lambda_i} t^2 \frac{d}{dt} [t J_1(t)] dt && \boxed{\begin{array}{ll} u = t^2 & dv = \frac{d}{dt} [t J_1(t)] dt \\ du = 2t dt & v = t J_1(t) \end{array}} \\
 &= \frac{2}{9\lambda_i^4 J_0^2(3\lambda_i)} \left( t^3 J_1(t) \Big|_0^{3\lambda_i} - 2 \int_0^{3\lambda_i} t^2 J_1(t) dt \right)
 \end{aligned}$$

With  $n = 0$  in equation (5) in the text we have  $J_0'(x) = -J_1(x)$ , so the boundary condition

### Exercises 11.5

$J'_0(3\lambda_i) = 0$  implies  $J_1(3\lambda_i) = 0$ . Then

$$\begin{aligned} c_i &= \frac{2}{9\lambda_i^4 J_0^2(3\lambda_i)} \left( -2 \int_0^{3\lambda_i} \frac{d}{dt} [t^2 J_2(t)] dt \right) = \frac{2}{9\lambda_i^4 J_0^2(3\lambda_i)} \left( -2t^2 J_2(t) \Big|_0^{3\lambda_i} \right) \\ &= \frac{2}{9\lambda_i^4 J_0^2(3\lambda_i)} [-18\lambda_i^2 J_2(3\lambda_i)] = \frac{-4J_2(3\lambda_i)}{\lambda_i^2 J_0^2(3\lambda_i)}. \end{aligned}$$

Thus

$$f(x) = \frac{9}{2} - 4 \sum_{i=1}^{\infty} \frac{J_2(3\lambda_i)}{\lambda_i^2 J_0^2(3\lambda_i)} J_0(\lambda_i x).$$

10. The boundary condition indicates that we use (15) and (16) in the text. With  $b = 1$  it follows that

$$\begin{aligned} c_i &= \frac{2}{J_1^2(\lambda_i)} \int_0^1 x(1-x^2) J_0(\lambda_i x) dx \\ &= \frac{2}{J_1^2(\lambda_i)} \left[ \int_0^1 x J_0(\lambda_i x) dx - \int_0^1 x^3 J_0(\lambda_i x) dx \right] \\ & \hspace{20em} \boxed{t = \lambda_i x \quad dt = \lambda_i dx} \\ &= \frac{2}{J_1^2(\lambda_i)} \left[ \frac{1}{\lambda_i^2} \int_0^{\lambda_i} t J_0(t) dt - \frac{1}{\lambda_i^4} \int_0^{\lambda_i} t^3 J_0(t) dt \right] \\ &= \frac{2}{J_1^2(\lambda_i)} \left[ \frac{1}{\lambda_i^2} \int_0^{\lambda_i} \frac{d}{dt} (t J_1(t)) dt - \frac{1}{\lambda_i^4} \int_0^{\lambda_i} t^2 \frac{d}{dt} [t J_1(t)] dt \right] \\ & \hspace{20em} \boxed{u = t^2 \quad dv = \frac{d}{dt} [t J_1(t)] dt} \\ & \hspace{20em} \boxed{du = 2t dt \quad v = t J_1(t)} \\ &= \frac{2}{J_1^2(\lambda_i)} \left[ \frac{1}{\lambda_i^2} t J_1(t) \Big|_0^{\lambda_i} - \frac{1}{\lambda_i^4} \left( t^3 J_1(t) \Big|_0^{\lambda_i} - 2 \int_0^{\lambda_i} t^2 J_1(t) dt \right) \right] \\ &= \frac{2}{J_1^2(\lambda_i)} \left[ \frac{J_1(\lambda_i)}{\lambda_i} - \frac{J_1(\lambda_i)}{\lambda_i} + \frac{2}{\lambda_i^4} \int_0^{\lambda_i} \frac{d}{dt} [t^2 J_2(t)] dt \right] \\ &= \frac{2}{J_1^2(\lambda_i)} \left[ \frac{2}{\lambda_i^4} t^2 J_2(t) \Big|_0^{\lambda_i} \right] = \frac{4J_2(\lambda_i)}{\lambda_i^2 J_1^2(\lambda_i)}. \end{aligned}$$

Thus

$$f(x) = 4 \sum_{i=1}^{\infty} \frac{J_2(\lambda_i)}{\lambda_i^2 J_1^2(\lambda_i)} j_0(\lambda_i x).$$



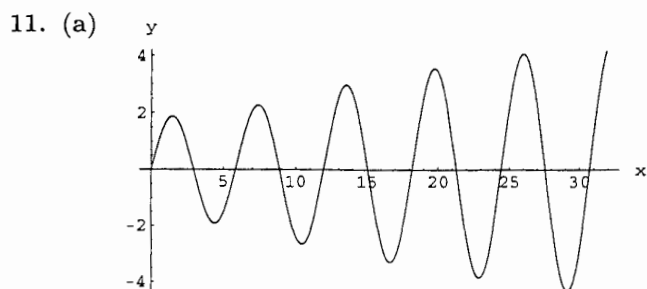

- (b) Using **FindRoot** in *Mathematica* we find the roots  $x_1 = 2.9496$ ,  $x_2 = 5.84113$ ,  $x_3 = 8.87273$ ,  $x_4 = 11.9561$ , and  $x_5 = 15.0624$ .
- (c) Dividing the roots in part (b) by 4 we find the eigenvalues  $\lambda_1 = 0.7374$ ,  $\lambda_2 = 1.46028$ ,  $\lambda_3 = 2.21818$ ,  $\lambda_4 = 2.98904$ , and  $\lambda_5 = 3.76559$ .
- (d) The next five eigenvalues are  $\lambda_6 = 4.54508$ ,  $\lambda_7 = 5.32626$ ,  $\lambda_8 = 6.1085$ ,  $\lambda_9 = 6.89145$ , and  $\lambda_{10} = 7.6749$ .

12. (a) From Problem 7, the coefficients of the Fourier-Bessel series are

$$c_1 = \frac{20\lambda_i J_2(4\lambda_i)}{(2\lambda_i^2 + 1)J_1^2(4\lambda_i)}.$$

Using a CAS we find  $c_1 = 26.7896$ ,  $c_2 = -12.4624$ ,  $c_3 = 7.1404$ ,  $c_4 = -4.68705$ , and  $c_5 = 3.35619$ .

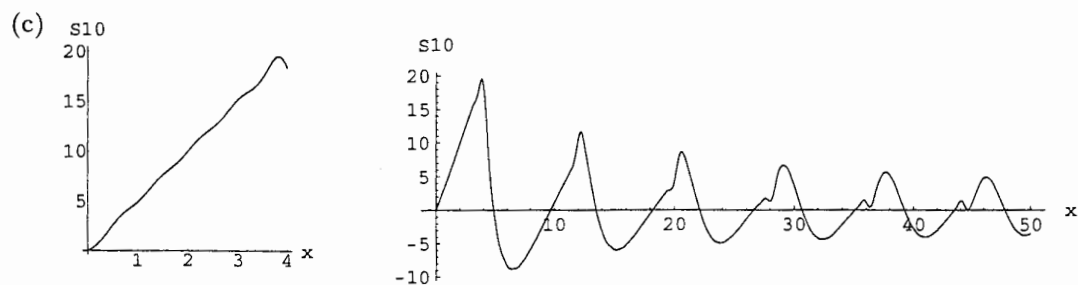
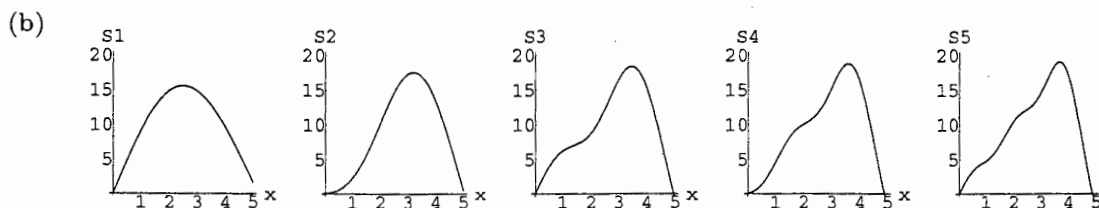

### Exercises 11.5

13. We compute

$$c_0 = \frac{1}{2} \int_0^1 x P_0(x) dx = \frac{1}{2} \int_0^1 x dx = \frac{1}{4}$$

$$c_1 = \frac{3}{2} \int_0^1 x P_1(x) dx = \frac{3}{2} \int_0^1 x^2 dx = \frac{1}{2}$$

$$c_2 = \frac{5}{2} \int_0^1 x P_2(x) dx = \frac{5}{2} \int_0^1 \frac{1}{2}(3x^3 - x) dx = \frac{5}{16}$$

$$c_3 = \frac{7}{2} \int_0^1 x P_3(x) dx = \frac{7}{2} \int_0^1 \frac{1}{2}(5x^4 - 3x^2) dx = 0$$

$$c_4 = \frac{9}{2} \int_0^1 x P_4(x) dx = \frac{9}{2} \int_0^1 \frac{1}{8}(35x^5 - 30x^3 + 3x) dx = -\frac{3}{32}$$

$$c_5 = \frac{11}{2} \int_0^1 x P_5(x) dx = \frac{11}{2} \int_0^1 \frac{1}{8}(63x^6 - 70x^4 + 15x^2) dx = 0$$

$$c_6 = \frac{13}{2} \int_0^1 x P_6(x) dx = \frac{13}{2} \int_0^1 \frac{1}{16}(231x^7 - 315x^5 + 105x^3 - 5x) dx = \frac{13}{256}$$

Thus

$$f(x) = \frac{1}{4}P_0(x) + \frac{1}{2}P_1(x) + \frac{5}{16}P_2(x) - \frac{3}{32}P_4(x) + \frac{13}{256}P_6(x) + \dots$$

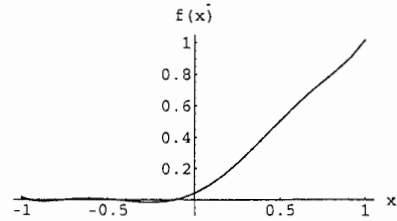

14. We compute

$$c_0 = \frac{1}{2} \int_{-1}^1 e^x P_0(x) dx = \frac{1}{2} \int_{-1}^1 e^x dx = \frac{1}{2}(e - e^{-1})$$

$$c_1 = \frac{3}{2} \int_{-1}^1 e^x P_1(x) dx = \frac{3}{2} \int_{-1}^1 x e^x dx = 3e^{-1}$$

$$\begin{aligned} c_2 &= \frac{5}{2} \int_{-1}^1 e^x P_2(x) dx = \frac{5}{2} \int_{-1}^1 \frac{1}{2}(3x^2 e^x - e^x) dx \\ &= \frac{5}{2}(e - 7e^{-1}) \end{aligned}$$

$$c_3 = \frac{7}{2} \int_{-1}^1 e^x P_3(x) dx = \frac{7}{2} \int_{-1}^1 \frac{1}{2}(5x^3 e^x - 3x e^x) dx = \frac{7}{2}(-5e + 37e^{-1})$$

$$c_4 = \frac{9}{2} \int_{-1}^1 e^x P_4(x) dx = \frac{9}{2} \int_{-1}^1 \frac{1}{8}(35x^4 e^x - 30x^2 e^x + 3e^x) dx = \frac{9}{2}(36e - 266e^{-1}).$$

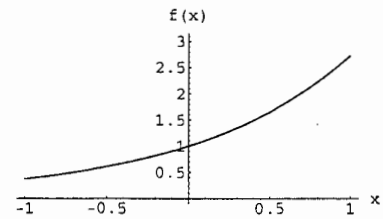

Thus

$$f(x) = \frac{1}{2}(e - e^{-1})P_0(x) + 3e^{-1}P_1(x) + \frac{5}{2}(e - 7e^{-1})P_2(x) \\ + \frac{7}{2}(-5e + 37e^{-1})P_3(x) + \frac{9}{2}(36e - 266e^{-1})P_4(x) + \dots$$

15. Using  $\cos^2 \theta = \frac{1}{2}(\cos 2\theta + 1)$  we have

$$P_2(\cos \theta) = \frac{1}{2}(3 \cos^2 \theta - 1) = \frac{3}{2} \cos^2 \theta - \frac{1}{2} \\ = \frac{3}{4}(\cos 2\theta + 1) - \frac{1}{2} = \frac{3}{4} \cos 2\theta + \frac{1}{4} = \frac{1}{4}(3 \cos 2\theta + 1).$$

16. From Problem 15 we have

$$P_2(\cos \theta) = \frac{1}{4}(3 \cos 2\theta + 1)$$

or

$$\cos 2\theta = \frac{4}{3}P_2(\cos \theta) - \frac{1}{3}.$$

Then, using  $P_0(\cos \theta) = 1$ ,

$$F(\theta) = 1 - \cos 2\theta = 1 - \left[ \frac{4}{3}P_2(\cos \theta) - \frac{1}{3} \right] \\ = \frac{4}{3} - \frac{4}{3}P_2(\cos \theta) = \frac{4}{3}P_0(\cos \theta) - \frac{4}{3}P_2(\cos \theta).$$

17. If  $f$  is an even function on  $(-1, 1)$  then

$$\int_{-1}^1 f(x)P_{2n}(x) dx = 2 \int_0^1 f(x)P_{2n}(x) dx$$

and

$$\int_{-1}^1 f(x)P_{2n+1}(x) dx = 0.$$

Thus

$$c_{2n} = \frac{2(2n) + 1}{2} \int_{-1}^1 f(x)P_{2n}(x) dx = \frac{4n + 1}{2} \left( 2 \int_0^1 f(x)P_{2n}(x) dx \right) \\ = (4n + 1) \int_0^1 f(x)P_{2n}(x) dx,$$

$c_{2n+1} = 0$ , and

$$f(x) = \sum_{n=0}^{\infty} c_{2n}P_{2n}(x).$$

18. If  $f$  is an odd function on  $(-1, 1)$  then

$$\int_{-1}^1 f(x)P_{2n}(x) dx = 0$$

and

### Exercises 11.5

$$\int_{-1}^1 f(x)P_{2n+1}(x) dx = 2 \int_0^1 f(x)P_{2n+1}(x) dx.$$

Thus

$$\begin{aligned} c_{2n+1} &= \frac{2(2n+1)+1}{2} \int_{-1}^1 f(x)P_{2n+1}(x) dx = \frac{4n+3}{2} \left( 2 \int_0^1 f(x)P_{2n+1}(x) dx \right) \\ &= (4n+1) \int_0^1 f(x)P_{2n+1}(x) dx, \end{aligned}$$

$c_{2n} = 0$ , and

$$f(x) = \sum_{n=0}^{\infty} c_{2n+1} P_{2n+1}(x).$$

19. From (26) in Problem 17 in the text we find

$$c_0 = \int_0^1 x P_0(x) dx = \int_0^1 x dx = \frac{1}{2},$$

$$c_2 = 5 \int_0^1 x P_2(x) dx = 5 \int_0^1 \frac{1}{2}(3x^3 - x) dx = \frac{5}{8},$$

$$c_4 = 9 \int_0^1 x P_4(x) dx = 9 \int_0^1 \frac{1}{8}(35x^5 - 30x^3 + 3x) dx = -\frac{3}{16},$$

and

$$c_6 = 13 \int_0^1 x P_6(x) dx = 13 \int_0^1 \frac{1}{16}(231x^7 - 315x^5 + 105x^3 - 5x) dx = \frac{13}{128}.$$

Hence, from (25) in the text,

$$f(x) = \frac{1}{2}P_0(x) + \frac{5}{8}P_2(x) - \frac{3}{16}P_4(x) + \frac{13}{128}P_6 + \dots$$

On the interval  $-1 < x < 1$  this series represents the function  $f(x) = |x|$ .

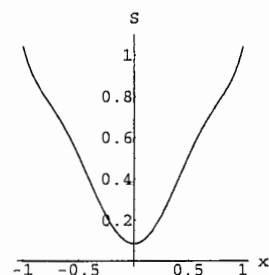

20. From (28) in Problem 18 in the text we find

$$c_1 = 3 \int_0^1 P_1(x) dx = 3 \int_0^1 x dx = \frac{3}{2},$$

$$c_3 = 7 \int_0^1 P_3(x) dx = 7 \int_0^1 \frac{1}{2}(5x^3 - 3x) dx = -\frac{7}{8},$$

$$c_5 = 11 \int_0^1 P_5(x) dx = 11 \int_0^1 \frac{1}{8}(63x^5 - 70x^3 + 15x) dx = \frac{11}{16}$$

and

$$c_7 = 15 \int_0^1 P_7(x) dx = 15 \int_0^1 \frac{1}{16}(429x^7 - 693x^5 + 315x^3 - 35x) dx = -\frac{75}{128}.$$

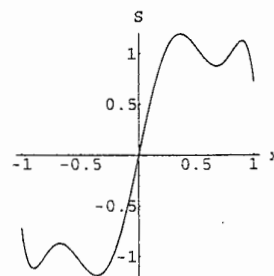

Hence, from (27) in the text,

$$f(x) = \frac{3}{2}P_1(x) - \frac{7}{8}P_3(x) + \frac{11}{16}P_5(x) - \frac{75}{128}P_7(x) + \dots$$

On the interval  $-1 < x < 1$  this series represents the odd function

$$f(x) = \begin{cases} -1, & -1 < x < 0 \\ 1, & 0 < x < 1. \end{cases}$$

21. Since  $f$  is expanded as a series of Bessel functions,  $J_1(\lambda_i x)$  and  $J_1$  is an odd function, the series should represent an odd function.
22. (a) Since  $J_0$  is an even function, a series expansion of a function defined on  $(0, 2)$  would converge to the even extension of the function on  $(-2, 0)$ .

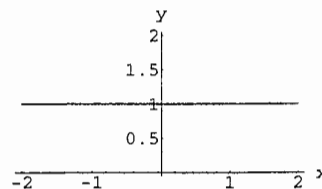

- (b) In Section 6.3 we saw that  $J_2'(x) = 2J_2(x)/x - J_3(x)$ . Since  $J_2$  is even and  $J_3$  is odd we see that

$$\begin{aligned} J_2'(-x) &= 2J_2(-x)/(-x) - J_3(-x) \\ &= -2J_2(x)/x + J_3(x) = -J_2'(x), \end{aligned}$$

so that  $J_2'$  is an odd function. Now, if  $f(x) = 3J_2(x) + 2xJ_2'(x)$ , we see that

$$\begin{aligned} f(-x) &= 3J_2(-x) - 2xJ_2'(-x) \\ &= 3J_2(x) + 2xJ_2'(x) = f(x), \end{aligned}$$

so that  $f$  is an even function. Thus, a series expansion of a function defined on  $(0, 1)$  would converge to the even extension of the function on  $(-1, 0)$ .

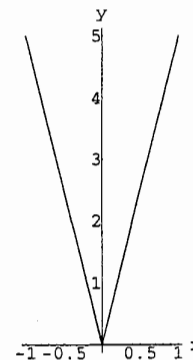

23. Since there is a Legendre polynomial of every degree, any polynomial can be represented as a finite linear combination of Legendre polynomials. For  $f(x) = x^2$  we have

$$\begin{aligned} c_0 &= \frac{1}{2} \int_{-1}^1 x^2 \cdot 1 \, dx = \frac{1}{3} \\ c_1 &= \frac{3}{2} \int_{-1}^1 x^2 \cdot x \, dx = 0 \\ c_2 &= \frac{5}{2} \int_{-1}^1 x^2 \cdot \frac{1}{2}(3x^2 - 1) \, dx = \frac{2}{3}, \end{aligned}$$

so

$$x^2 = \frac{1}{3}P_0(x) + \frac{2}{3}P_2(x).$$

### Exercises 11.5

For  $f(x) = x^3$  we have

$$c_0 = \frac{1}{2} \int_{-1}^1 x^3 \cdot 1 \, dx = 0$$

$$c_1 = \frac{3}{2} \int_{-1}^1 x^3 \cdot x \, dx = \frac{3}{5}$$

$$c_2 = \frac{5}{2} \int_{-1}^1 x^3 \cdot \frac{1}{2}(3x^2 - 1) \, dx = 0$$

$$c_3 = \frac{7}{2} \int_{-1}^1 x^4 \cdot \frac{1}{2}(5x^3 - 3x) \, dx = \frac{2}{5},$$

so

$$x^3 = \frac{3}{5}P_1(x) + \frac{2}{5}P_3(x).$$

---

## Chapter 11 Review Exercises

---

1. True, since  $\int_{-\pi}^{\pi} (x^2 - 1)x^5 \, dx = 0$
2. Even, since if  $f$  and  $g$  are odd then  $h(-x) = f(-x)g(-x) = -f(x)[-g(x)] = f(x)g(x) = h(x)$
3. Cosine, since  $f$  is even
4. True
5. False; the Sturm-Liouville problem,

$$\frac{d}{dx}[r(x)y'] + \lambda p(x)y = 0, \quad y'(a) = 0, \quad y'(b) = 0,$$

on the interval  $[a, b]$ , has eigenvalue  $\lambda = 0$ .

6. Periodically extending the function we see that at  $x = -1$  the function converges to  $\frac{1}{2}(-1+0) = -\frac{1}{2}$ ; at  $x = 0$  it converges to  $\frac{1}{2}(0+1) = \frac{1}{2}$ , and at  $x = 1$  it converges to  $\frac{1}{2}(-1+0) = -\frac{1}{2}$ .
7. The Fourier series will converge to 1, the cosine series to 1, and the sine series to 0 at  $x = 0$ . Respectively, this is because the rule  $(x^2 + 1)$  defining  $f(x)$  determines a continuous function on  $(-3, 3)$ , the even extension of  $f$  to  $(-3, 0)$  is continuous at 0, and the odd extension of  $f$  to  $(-3, 0)$  approaches  $-1$  as  $x$  approaches 0 from the left.
8.  $\cos.5x$ , since the general solution is  $y = c_1 \cos \sqrt{\lambda}x + c_2 \sin \sqrt{\lambda}x$  and  $y'(0) = 0$  implies  $c_2 = 0$ .
9. Since the coefficient of  $y$  in the differential equation is  $n^2$ , the weight function is the integrating factor

$$\frac{1}{a(x)} e^{\int (b/a) dx} = \frac{1}{1-x^2} e^{\int -\frac{x}{1-x^2} dx} = \frac{1}{1-x^2} e^{\frac{1}{2} \ln(1-x^2)} = \frac{\sqrt{1-x^2}}{1-x^2} = \frac{1}{\sqrt{1-x^2}}$$

on the interval  $[-1, 1]$ . The orthogonality relation is

$$\int_{-1}^1 \frac{1}{\sqrt{1-x^2}} T_m(x) T_n(x) dx = 0, \quad m \neq n.$$

10. Since  $P_n(x)$  is orthogonal to  $P_0(x) = 1$  for  $n > 0$ ,

$$\int_{-1}^1 P_n(x) dx = \int_{-1}^1 P_0(x) P_n(x) dx = 0.$$

11. We know from a half-angle formula in trigonometry that  $\cos^2 x = \frac{1}{2} - \frac{1}{2} \cos 2x$ , which is a cosine series.

12. (a) For  $m \neq n$

$$\int_0^L \sin \frac{(2n+1)\pi}{2L} x \sin \frac{(2m+1)\pi}{2L} x dx = \frac{1}{2} \int_0^L \left( \cos \frac{n-m}{L} \pi x - \cos \frac{n+m}{L} \pi x \right) dx = 0.$$

(b) From

$$\int_0^L \sin^2 \frac{(2n+1)\pi}{2L} x dx = \int_0^L \left( \frac{1}{2} - \frac{1}{2} \cos \frac{(2n+1)\pi}{2L} x \right) dx = \frac{L}{2}$$

we see that

$$\left\| \sin \frac{(2n+1)\pi}{2L} x \right\| = \sqrt{\frac{L}{2}}.$$

13. Since

$$A_0 = \int_{-1}^0 (-2x) dx = 1,$$

$$A_n = \int_{-1}^0 (-2x) \cos n\pi x dx = \frac{2}{n^2\pi^2} [(-1)^n - 1],$$

and

$$B_n = \int_{-1}^0 (-2x) \sin n\pi x dx = \frac{4}{n\pi} (-1)^n$$

for  $n = 1, 2, 3, \dots$  we have

$$f(x) = \frac{1}{2} + \sum_{n=1}^{\infty} \left( \frac{2}{n^2\pi^2} [(-1)^n - 1] \cos n\pi x + \frac{4}{n\pi} (-1)^n \sin n\pi x \right).$$

14. Since

$$A_0 = \int_{-1}^1 (2x^2 - 1) dx = -\frac{2}{3},$$

$$A_n = \int_{-1}^1 (2x^2 - 1) \cos n\pi x dx = \frac{8}{n^2\pi^2} (-1)^n,$$

and

$$B_n = \int_{-1}^1 (2x^2 - 1) \sin n\pi x dx = 0$$

## Chapter 11 Review Exercises

for  $n = 1, 2, 3, \dots$  we have

$$f(x) = -\frac{1}{3} + \sum_{n=1}^{\infty} \frac{8}{n^2\pi^2} (-1)^n \cos n\pi x.$$

15. (a) Since

$$A_0 = 2 \int_0^1 e^{-x} dx$$

and

$$A_n = 2 \int_{-1}^1 e^{-x} \cos n\pi x dx = \frac{2}{1+n^2\pi^2} [(1 - (-1)^n e^{-1})]$$

for  $n = 1, 2, 3, \dots$  we have

$$f(x) = 1 - e^{-1} + 2 \sum_{n=1}^{\infty} \frac{1 - (-1)^n e^{-1}}{1 + n^2\pi^2} \cos n\pi x.$$

(b) Since

$$B_n = 2 \int_0^1 e^{-x} \sin n\pi x dx = \frac{2n\pi}{1+n^2\pi^2} [(1 - (-1)^n e^{-1})]$$

for  $n = 1, 2, 3, \dots$  we have

$$f(x) = \sum_{n=1}^{\infty} \frac{2n\pi}{1+n^2\pi^2} [(1 - (-1)^n e^{-1})] \sin n\pi x.$$

16.

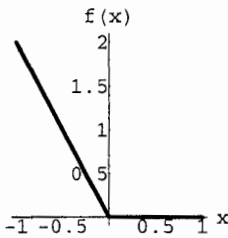

$$f(x) = |x| - 1$$

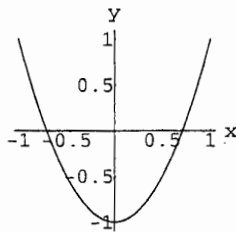

$$f(x) = 2x^2 - 1$$

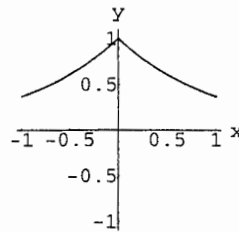

$$f(x) = e^{-|x|}$$

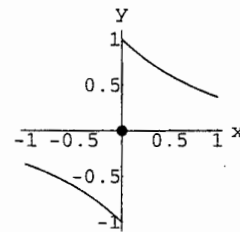

$$f(x) = \begin{cases} e^{-x}, & 0 < x < 1 \\ 0, & x = 0 \\ -e^x, & -1 < x < 0 \end{cases}$$

17. For  $\lambda > 0$  a general solution of the given differential equation is

$$y = c_1 \cos(3\sqrt{\lambda} \ln x) + c_2 \sin(3\sqrt{\lambda} \ln x)$$

and

$$y' = -\frac{3c_1\sqrt{\lambda}}{x} \sin(3\sqrt{\lambda} \ln x) + \frac{3c_2\sqrt{\lambda}}{x} \cos(3\sqrt{\lambda} \ln x).$$

Since  $\ln 1 = 0$ , the boundary condition  $y'(1) = 0$  implies  $c_2 = 0$ . Therefore

$$y = c_1 \cos(3\sqrt{\lambda} \ln x).$$



Chapter 11 Review Exercises

Using  $\ln e = 1$  we find that  $y(e) = 0$  implies  $c_1 \cos 3\sqrt{\lambda} = 0$  or  $3\sqrt{\lambda} = \frac{2n-1}{2}\pi$ , for  $n = 1, 2, 3, \dots$ . The eigenvalues are  $\lambda = (2n-1)^2\pi^2/36$  with corresponding eigenfunctions  $\cos\left(\frac{2n-1}{2}\pi \ln x\right)$  for  $n = 1, 2, 3, \dots$ .

18. To obtain the self-adjoint form of the differential equation in Problem 17 we note that an integrating factor is  $(1/x^2)e^{\int dx/x} = 1/x$ . Thus the weight function is  $9/x$  and an orthogonality relation is

$$\int_1^e \frac{9}{x} \cos\left(\frac{2n-1}{2}\pi \ln x\right) \cos\left(\frac{2m-1}{2}\pi \ln x\right) dx = 0, \quad m \neq n.$$

19. The boundary condition indicates that we use (15) and (16) of Section 11.5 in the text. With  $b = 4$  we obtain

$$\begin{aligned} c_i &= \frac{2}{16J_1^2(4\lambda_i)} \int_0^4 x J_0(\lambda_i x) f(x) dx \\ &= \frac{1}{8J_1^2(4\lambda_i)} \int_0^2 x J_0(\lambda_i x) dx && \boxed{t = \lambda_i x \quad dt = \lambda_i dx} \\ &= \frac{1}{8J_1^2(4\lambda_i)} \cdot \frac{1}{\lambda_i^2} \int_0^{2\lambda_i} t J_0(t) dt \\ &= \frac{1}{8J_1^2(4\lambda_i)} \int_0^{2\lambda_i} \frac{d}{dt} [t J_1(t)] dt && \text{[From (4) in 11.5 in the text]} \\ &= \frac{1}{8J_1^2(4\lambda_i)} t J_1(t) \Big|_0^{2\lambda_i} = \frac{J_1(2\lambda_i)}{4\lambda_i J_1^2(4\lambda_i)}. \end{aligned}$$

Thus

$$f(x) = \frac{1}{4} \sum_{i=1}^{\infty} \frac{J_1(2\lambda_i)}{\lambda_i J_1^2(4\lambda_i)} J_0(\lambda_i x).$$

20. Since  $f(x) = x^4$  is a polynomial in  $x$ , an expansion of  $f$  in polynomials in  $x$  must terminate with the term having the same degree as  $f$ . Using the fact that  $x^4 P_1(x)$  and  $x^4 P_3(x)$  are odd functions, we see immediately that  $c_1 = c_3 = 0$ . Now

$$\begin{aligned} c_0 &= \frac{1}{2} \int_{-1}^1 x^4 P_0(x) dx = \frac{1}{2} \int_{-1}^1 x^4 dx = \frac{1}{5} \\ c_2 &= \frac{5}{2} \int_{-1}^1 x^4 P_2(x) dx = \frac{5}{2} \int_{-1}^1 \frac{1}{2} (3x^6 - x^4) dx = \frac{4}{7} \\ c_4 &= \frac{9}{2} \int_{-1}^1 x^4 P_4(x) dx = \frac{9}{2} \int_{-1}^1 \frac{1}{8} (35x^8 - 30x^6 + 3x^4) dx = \frac{8}{35}. \end{aligned}$$

Thus

$$f(x) = \frac{1}{5} P_0(x) + \frac{4}{7} P_2(x) + \frac{8}{35} P_4(x).$$

# 12 Partial Differential Equations and Boundary-Value Problems in Rectangular Coordinates

## Exercises 12.1

---

1. If  $u = XY$  then

$$u_x = X'Y,$$

$$u_y = XY',$$

$$X'Y = XY',$$

and

$$\frac{X'}{X} = \frac{Y'}{Y} = \pm\lambda^2.$$

Then

$$X' \mp \lambda^2 X = 0 \quad \text{and} \quad Y' \mp \lambda^2 Y = 0$$

so that

$$X = A_1 e^{\pm\lambda^2 x},$$

$$Y = A_2 e^{\pm\lambda^2 y},$$

and

$$u = XY = c_1 e^{c_2(x+y)}.$$

2. If  $u = XY$  then

$$u_x = X'Y,$$

$$u_y = XY',$$

$$X'Y = -3XY',$$

and

$$\frac{X'}{-3X} = \frac{Y'}{Y} = \pm\lambda^2.$$

Then

$$X' \pm 3\lambda^2 X = 0 \quad \text{and} \quad Y' \mp \lambda^2 Y = 0$$

so that

$$X = A_1 e^{\mp 3\lambda^2 x},$$

$$Y = A_2 e^{\pm \lambda^2 y},$$

and

$$u = XY = c_1 e^{c_2(y-3x)}.$$

3. If  $u = XY$  then

$$u_x = X'Y,$$

$$u_y = XY',$$

$$X'Y = X(Y - Y'),$$

and

$$\frac{X'}{X} = \frac{Y - Y'}{Y} = \pm \lambda^2.$$

Then

$$X' \mp \lambda^2 X = 0 \quad \text{and} \quad Y' - (1 \mp \lambda^2)Y = 0$$

so that

$$X = A_1 e^{\pm \lambda^2 x},$$

$$Y = A_2 e^{(1 \mp \lambda^2)y},$$

and

$$u = XY = c_1 e^{y+c_2(x-y)}.$$

4. If  $u = XY$  then

$$u_x = X'Y,$$

$$u_y = XY',$$

$$X'Y = X(Y + Y'),$$

and

$$\frac{X'}{X} = \frac{Y + Y'}{Y} = \pm \lambda^2.$$

Then

$$X' \mp \lambda^2 X = 0 \quad \text{and} \quad Y' - (-1 \pm \lambda^2)Y = 0$$

so that

$$X = A_1 e^{\pm \lambda^2 x},$$

$$Y = A_2 e^{(-1 \pm \lambda^2)y},$$

and

### Exercises 12.1

$$u = XY = c_1 e^{-y+c_2(x+y)}.$$

5. If  $u = XY$  then

$$u_x = X'Y,$$

$$u_y = XY',$$

$$xX'Y = yXY',$$

and

$$\frac{xX'}{X} = \frac{yY'}{Y} = \pm\lambda^2.$$

Then

$$X \mp \frac{1}{x}\lambda^2 X = 0 \quad \text{and} \quad Y' \mp \frac{1}{y}\lambda^2 Y = 0$$

so that

$$X = A_1 x^{\pm\lambda^2},$$

$$Y = A_2 y^{\pm\lambda^2},$$

and

$$u = XY = c_1 (xy)^{c_2}.$$

6. If  $u = XY$  then

$$u_x = X'Y,$$

$$u_y = XY',$$

$$yX'Y = xXY',$$

and

$$\frac{X'}{xX} = \frac{Y'}{-yY} = \pm\lambda^2.$$

Then

$$X \mp \lambda^2 x X = 0 \quad \text{and} \quad Y' \pm \lambda^2 y Y = 0$$

so that

$$X = A_1 e^{\pm\lambda^2 x^2/2},$$

$$Y = A_2 e^{\mp\lambda^2 y^2/2},$$

and

$$u = XY = c_1 e^{c_2(x^2 - y^2)}.$$

7. If  $u = XY$  then

$$u_{xx} = X''Y, \quad u_{yy} = XY'', \quad u_{yx} = X'Y',$$

and

$$X''Y + X'Y' + XY'' = 0,$$

which is not separable.

8. If  $u = XY$  then

$$u_{yx} = X'Y',$$

$$yX'Y' + XY'' = 0,$$

and

$$\frac{X'}{-X} = \frac{Y''}{Y} = \pm\lambda^2.$$

Then

$$X' \mp \lambda^2 X = 0 \quad \text{and} \quad \pm \lambda^2 y Y'' - Y = 0$$

so that

$$X = A_1 e^{\mp \lambda^2 x},$$

$$Y = A_2 y^{\pm 1/\lambda^2},$$

and

$$u = XY = c_1 e^{-c_2 x} y^{1/c_2}.$$

9. If  $u = XT$  then

$$u_t = XT',$$

$$u_{xx} = X''T,$$

$$kX''T - XT' = XT',$$

and we choose

$$\frac{T'}{T} = \frac{kX'' - X}{X} = -1 \pm k\lambda^2$$

so that

$$T' - (-1 \pm k\lambda^2)T = 0 \quad \text{and} \quad X'' - (\pm\lambda^2)X = 0.$$

For  $\lambda^2 > 0$  we obtain

$$X = A_1 \cosh \lambda x + A_2 \sinh \lambda x \quad \text{and} \quad T = A_3 e^{(-1+k\lambda^2)t}$$

so that

$$u = XT = e^{(-1+k\lambda^2)t} (c_1 \cosh \lambda x + c_2 \sinh \lambda x).$$

For  $-\lambda^2 < 0$  we obtain

$$X = A_1 \cos \lambda x + A_2 \sin \lambda x \quad \text{and} \quad T = A_3 e^{(-1-k\lambda^2)t}$$

so that

### Exercises 12.1

$$u = XT = e^{(-1-k\lambda^2)t}(c_3 \cos \lambda x + c_4 \sin \lambda x).$$

If  $\lambda^2 = 0$  then

$$X'' = 0 \quad \text{and} \quad T' + T = 0,$$

and we obtain

$$X = A_1x + A_2 \quad \text{and} \quad T = A_3e^{-t}.$$

In this case

$$u = XT = e^{-t}(c_5x + c_6)$$

10. If  $u = XT$  then

$$u_t = XT',$$

$$u_{xx} = X''T,$$

$$kX''T = XT',$$

and

$$\frac{X''}{X} = \frac{T'}{kT} = \pm\lambda^2$$

so that

$$X'' \mp \lambda^2 X = 0 \quad \text{and} \quad T' \mp \lambda^2 kT = 0.$$

For  $\lambda^2 > 0$  we obtain

$$X = A_1 \cos \lambda x + A_2 \sin \lambda x \quad \text{and} \quad T = A_3 e^{\lambda^2 kt},$$

so that

$$u = XT = e^{-c_3^2 kt}(c_1 \cos c_3 x + c_2 \sin c_3 x).$$

For  $-\lambda^2 < 0$  we obtain

$$X = A_1 e^{-\lambda x} + A_2 e^{\lambda x},$$

$$T = A_3 e^{\lambda^2 kt},$$

and

$$u = XT = e^{c_3^2 kt}(c_1 e^{-c_3 x} + c_2 e^{c_3 x}).$$

For  $\lambda^2 = 0$  we obtain

$$T = A_3, \quad X = A_1x + A_2, \quad \text{and} \quad u = XT = c_1x + c_2.$$

11. If  $u = XT$  then

$$u_{xx} = X''T,$$

$$u_{tt} = XT'',$$

$$a^2 X''T = XT'',$$

and

$$\frac{X''}{X} = \frac{T''}{a^2 T} = \pm \lambda^2$$

so that

$$X'' \mp \lambda^2 X = 0 \quad \text{and} \quad T'' \mp a^2 \lambda^2 T = 0.$$

For  $\lambda^2 > 0$  we obtain

$$X = A_1 \cos \lambda x + A_2 \sin \lambda x,$$

$$T = A_3 \cos a\lambda t + A_4 \sin a\lambda t,$$

and

$$u = XT = (A_1 \cos \lambda x + A_2 \sin \lambda x)(A_3 \cos a\lambda t + A_4 \sin a\lambda t).$$

For  $-\lambda^2 < 0$  we obtain

$$X = A_1 e^{\lambda x} + A_2 e^{-\lambda x},$$

$$T = A_3 e^{a\lambda t} + A_4 e^{-a\lambda t},$$

and

$$u = XT = (A_1 e^{\lambda x} + A_2 e^{-\lambda x})(A_3 e^{a\lambda t} + A_4 e^{-a\lambda t}).$$

For  $\lambda^2 = 0$  we obtain

$$X = A_1 x + A_2,$$

$$T = A_3 t + A_4,$$

and

$$u = XT = (A_1 x + A_2)(A_3 t + A_4).$$

12. If  $u = XT$  then

$$u_t = XT',$$

$$u_{tt} = XT'',$$

$$u_{xx} = X''T,$$

$$a^2 X''T = XT'' + 2kXT',$$

and

$$\frac{X''}{X} = \frac{T'' + 2kT'}{a^2 T} = \pm \lambda^2$$

so that

$$X'' \mp \lambda^2 X = 0 \quad \text{and} \quad T'' + 2kT' \mp a^2 \lambda^2 T = 0.$$

### Exercises 12.1

For  $\lambda^2 > 0$  we obtain

$$X = A_1 e^{\lambda x} + A_2 e^{-\lambda x},$$

$$T = A_3 e^{(-k + \sqrt{k^2 + a^2 \lambda^2})t} + A_4 e^{(-k - \sqrt{k^2 + a^2 \lambda^2})t},$$

and

$$u = XT = (A_1 e^{\lambda x} + A_2 e^{-\lambda x}) (A_3 e^{(-k + \sqrt{k^2 + a^2 \lambda^2})t} + A_4 e^{(-k - \sqrt{k^2 + a^2 \lambda^2})t}).$$

For  $-\lambda^2 < 0$  we obtain

$$X = A_1 \cos \lambda x + A_2 \sin \lambda x.$$

If  $k^2 - a^2 \lambda^2 > 0$  then

$$T = A_3 e^{(-k + \sqrt{k^2 - a^2 \lambda^2})t} + A_4 e^{(-k - \sqrt{k^2 - a^2 \lambda^2})t}.$$

If  $k^2 - a^2 \lambda^2 < 0$  then

$$T = e^{-kt} (A_3 \cos \sqrt{a^2 \lambda^2 - k^2} t + A_4 \sin \sqrt{a^2 \lambda^2 - k^2} t).$$

If  $k^2 - a^2 \lambda^2 = 0$  then

$$T = A_3 e^{-kt} + A_4 t e^{-kt}$$

so that

$$\begin{aligned} u = XT &= (A_1 \cos \lambda x + A_2 \sin \lambda x) (A_3 e^{(-k + \sqrt{k^2 - a^2 \lambda^2})t} + A_4 e^{(-k - \sqrt{k^2 - a^2 \lambda^2})t}) \\ &= (A_1 \cos \lambda x + A_2 \sin \lambda x) e^{-kt} (A_3 \cos \sqrt{a^2 \lambda^2 - k^2} t + A_4 \sin \sqrt{a^2 \lambda^2 - k^2} t) \\ &= \left( A_1 \cos \frac{k}{a} x + A_2 \sin \frac{k}{a} x \right) (A_3 e^{-kt} + A_4 t e^{-kt}). \end{aligned}$$

For  $\lambda^2 = 0$  we obtain

$$X = A_1 x + A_2,$$

$$T = A_3 + A_4 e^{-2kt},$$

and

$$u = XT = (A_1 x + A_2)(A_3 + A_4 e^{-2kt}).$$

13. If  $u = XY$  then

$$u_{xx} = X''Y,$$

$$u_{yy} = XY'',$$

$$X''Y + XY'' = 0,$$

and



$$\frac{X''}{-X} = \frac{Y''}{Y} = \pm\lambda^2$$

so that

$$X'' \pm \lambda^2 X = 0 \quad \text{and} \quad Y'' \mp \lambda^2 Y = 0.$$

For  $\lambda^2 > 0$  we obtain

$$X = A_1 \cos \lambda x + A_2 \sin \lambda x,$$

$$Y = A_3 e^{\lambda y} + A_4 e^{-\lambda y},$$

and

$$u = XY = (A_1 \cos \lambda x + A_2 \sin \lambda x)(A_3 e^{\lambda y} + A_4 e^{-\lambda y}).$$

For  $-\lambda^2 < 0$  we obtain

$$X = A_1 e^{\lambda x} + A_2 e^{-\lambda x},$$

$$Y = A_3 \cos \lambda y + A_4 \sin \lambda y,$$

and

$$u = XY = (A_1 e^{\lambda x} + A_2 e^{-\lambda x})(A_3 \cos \lambda y + A_4 \sin \lambda y).$$

For  $\lambda^2 = 0$  we obtain

$$u = XY = (A_1 x + A_2)(A_3 y + A_4).$$

14. If  $u = XY$  then

$$u_{xx} = X''Y,$$

$$u_{yy} = XY'',$$

$$x^2 X''Y + xY'' = 0,$$

and

$$\frac{x^2 X''}{-X} = \frac{Y''}{Y} = \pm\lambda^2$$

so that

$$x^2 X'' \pm \lambda^2 X = 0 \quad \text{and} \quad Y'' \mp \lambda^2 Y = 0.$$

For  $\lambda^2 > 0$  we obtain

$$Y = A_3 e^{\lambda y} + A_4 e^{-\lambda y}.$$

If  $1 - 4\lambda^2 > 0$  then

$$X = A_1 x^{(1/2 + \sqrt{1-4\lambda^2}/2)} + A_2 x^{(1/2 - \sqrt{1-4\lambda^2}/2)}.$$

If  $1 - 4\lambda^2 < 0$  then

$$X = x^{1/2} \left( A_1 \cos \frac{1}{2} \sqrt{4\lambda^2 - 1} \ln x + A_2 \sin \frac{1}{2} \sqrt{4\lambda^2 - 1} \ln x \right).$$

### Exercises 12.1

If  $1 - 4\lambda^2 = 0$  then

$$X = A_1 x^{1/2} + A_2 x^{1/2} \ln x$$

so that

$$\begin{aligned} u = XY &= \left( A_1 x^{(1/2 + \sqrt{1-4\lambda^2}/2)} + A_2 x^{(1/2 - \sqrt{1-4\lambda^2}/2)} \right) (A_3 e^{\lambda y} + A_4 e^{-\lambda y}) \\ &= x^{1/2} \left( A_1 \cos \frac{1}{2} \sqrt{4\lambda^2 - 1} \ln x + A_2 \sin \frac{1}{2} \sqrt{4\lambda^2 - 1} \ln x \right) (A_3 e^{y/2} + A_4 e^{-y/2}) \\ &= (A_1 x^{1/2} + A_2 x^{1/2} \ln x) (A_3 e^{y/2} + A_4 e^{-y/2}). \end{aligned}$$

For  $-\lambda^2 < 0$  we obtain

$$X = A_1 e^{(1/2 + \sqrt{1+4\lambda^2}/2)x} + A_2 e^{(1/2 - \sqrt{1+4\lambda^2}/2)x},$$

$$Y = A_3 \cos \lambda y + A_4 \sin \lambda y,$$

and

$$u = XY = \left( A_1 e^{(1/2 + \sqrt{1+4\lambda^2}/2)x} + A_2 e^{(1/2 - \sqrt{1+4\lambda^2}/2)x} \right) (A_3 \cos \lambda y + A_4 \sin \lambda y).$$

For  $\lambda^2 = 0$  we obtain

$$X = A_1 x + A_2,$$

$$Y = A_3 y + A_4,$$

and

$$u = XY = (A_1 x + A_2)(A_3 y + A_4).$$

15. If  $u = XY$  then

$$u_{xx} = X''Y,$$

$$u_{yy} = XY'',$$

$$X''Y + XY'' = XY,$$

and

$$\frac{X''}{X} = \frac{Y - Y''}{Y} = \pm \lambda^2$$

so that

$$X'' \mp \lambda^2 X = 0 \quad \text{and} \quad Y'' + (\pm \lambda^2 - 1)Y = 0.$$

For  $\lambda^2 > 0$  we obtain

$$X = A_1 e^{\lambda x} + A_2 e^{-\lambda x}.$$

If  $\lambda^2 - 1 > 0$  then

$$Y = A_3 \cos \sqrt{\lambda^2 - 1} y + A_4 \sin \sqrt{\lambda^2 - 1} y.$$

If  $\lambda^2 - 1 < 0$  then

$$Y = A_3 e^{\sqrt{1-\lambda^2}y} + A_4 e^{-\sqrt{1-\lambda^2}y}.$$

If  $\lambda^2 - 1 = 0$  then  $Y = A_3 y + A_4$  so that

$$\begin{aligned} u = XY &= (A_1 e^{\lambda x} + A_2 e^{-\lambda x}) \left( A_3 \cos \sqrt{\lambda^2 - 1} y + A_4 \sin \sqrt{\lambda^2 - 1} y \right), \\ &= (A_1 e^{\lambda x} + A_2 e^{-\lambda x}) \left( A_3 e^{\sqrt{1-\lambda^2}y} + A_4 e^{-\sqrt{1-\lambda^2}y} \right) \\ &= (A_1 e^x + A_2 e^{-x})(A_3 y + A_4). \end{aligned}$$

For  $-\lambda^2 < 0$  we obtain

$$\begin{aligned} X &= A_1 \cos \lambda x + A_2 \sin \lambda x, \\ Y &= A_3 e^{\sqrt{1+\lambda^2}y} + A_4 e^{-\sqrt{1+\lambda^2}y}, \end{aligned}$$

and

$$u = XY = (A_1 \cos \lambda x + A_2 \sin \lambda x) \left( A_3 e^{\sqrt{1+\lambda^2}y} + A_4 e^{-\sqrt{1+\lambda^2}y} \right).$$

For  $\lambda^2 = 0$  we obtain

$$\begin{aligned} X &= A_1 x + A_2, \\ Y &= A_3 e^y + A_4 e^{-y}, \end{aligned}$$

and

$$u = XY = (A_1 x + A_2)(A_3 e^y + A_4 e^{-y}).$$

16. If  $u = XT$  then

$$u_{tt} = XT'', \quad u_{xx} = X''T, \quad \text{and} \quad a^2 X''T - g = XT'',$$

which is not separable.

17. Identifying  $A = B = C = 1$ , we compute  $B^2 - 4AC = -3 < 0$ . The equation is elliptic.
18. Identifying  $A = 3$ ,  $B = 5$ , and  $C = 1$ , we compute  $B^2 - 4AC = 13 > 0$ . The equation is hyperbolic.
19. Identifying  $A = 1$ ,  $B = 6$ , and  $C = 9$ , we compute  $B^2 - 4AC = 0$ . The equation is parabolic.
20. Identifying  $A = 1$ ,  $B = -1$ , and  $C = -3$ , we compute  $B^2 - 4AC = 13 > 0$ . The equation is hyperbolic.
21. Identifying  $A = 1$ ,  $B = -9$ , and  $C = 0$ , we compute  $B^2 - 4AC = 81 > 0$ . The equation is hyperbolic.
22. Identifying  $A = 0$ ,  $B = 1$ , and  $C = 0$ , we compute  $B^2 - 4AC = 1 > 0$ . The equation is hyperbolic.
23. Identifying  $A = 1$ ,  $B = 2$ , and  $C = 1$ , we compute  $B^2 - 4AC = 0$ . The equation is parabolic.
24. Identifying  $A = 1$ ,  $B = 0$ , and  $C = 1$ , we compute  $B^2 - 4AC = -4 < 0$ . The equation is elliptic.

### Exercises 12.1

25. Identifying  $A = a^2$ ,  $B = 0$ , and  $C = -1$ , we compute  $B^2 - 4AC = 4a^2 > 0$ . The equation is hyperbolic.
26. Identifying  $A = k > 0$ ,  $B = 0$ , and  $C = 0$ , we compute  $B^2 - 4AC = -4k < 0$ . The equation is elliptic.
27. If  $u = RT$  then

$$\begin{aligned}u_r &= R'T, \\u_{rr} &= R''T, \\u_t &= RT', \\RT' &= k \left( R''T + \frac{1}{r}R'T \right),\end{aligned}$$

and

$$\frac{r^2R'' + rR'}{r^2R} = \frac{T'}{kT} = \pm\lambda^2.$$

If we use  $-\lambda^2 < 0$  then

$$r^2R'' + rR' + \lambda^2r^2R = 0 \quad \text{and} \quad T'' \mp \lambda^2kT = 0$$

so that

$$\begin{aligned}R &= A_2J_0(\lambda r) + A_3Y_0(\lambda r), \\T &= A_1e^{-k\lambda^2t},\end{aligned}$$

and

$$u = RT = e^{-k\lambda^2t}[c_1J_0(\lambda r) + c_2Y_0(\lambda r)]$$

28. If  $u = R\Theta$  then

$$\begin{aligned}u_r &= R'\Theta, \\u_{rr} &= R''\Theta, \\u_t &= R\Theta', \\u_{tt} &= R\Theta'', \\R''\Theta + \frac{1}{r}R'\Theta + \frac{1}{r^2}R\Theta'' &= 0,\end{aligned}$$

and

$$\frac{r^2R'' + rR'}{R} = -\frac{\Theta''}{\Theta} = \lambda^2.$$

Then

$$r^2R'' + rR' - \lambda^2R = 0 \quad \text{and} \quad \Theta'' + \lambda^2\Theta = 0$$

so that

$$R = c_3 r^\lambda + c_4 r^{-\lambda}$$

$$\Theta\theta = c_1 \cos \lambda\theta + c_2 \sin \lambda\theta,$$

and

$$u = R\Theta = (c_1 \cos \lambda\theta + c_2 \sin \lambda\theta)(c_3 r^\lambda + c_4 r^{-\lambda}).$$

29. For  $u = A_1 e^{\lambda^2 y} \cosh 2\lambda x + B_1 e^{\lambda^2 y} \sinh 2\lambda x$  we compute

$$\frac{\partial^2 u}{\partial x^2} = 4\lambda^2 A_1 e^{\lambda^2 y} \cosh 2\lambda x + 4\lambda^2 B_1 e^{\lambda^2 y} \sinh 2\lambda x$$

and

$$\frac{\partial u}{\partial y} = \lambda^2 A_1 e^{\lambda^2 y} \cosh 2\lambda x + \lambda^2 B_1 e^{\lambda^2 y} \sinh 2\lambda x.$$

Then  $\partial^2 u / \partial x^2 = 4\partial u / \partial y$ .

For  $u = A_2 e^{-\lambda^2 y} \cos 2\lambda x + B_2 e^{-\lambda^2 y} \sin 2\lambda x$  we compute

$$\frac{\partial^2 u}{\partial x^2} = -4\lambda^2 A_2 e^{-\lambda^2 y} \cos 2\lambda x - 4\lambda^2 B_2 e^{-\lambda^2 y} \sin 2\lambda x$$

and

$$\frac{\partial u}{\partial y} = -\lambda^2 A_2 \cos 2\lambda x - \lambda^2 B_2 \sin 2\lambda x.$$

Then  $\partial^2 u / \partial x^2 = 4\partial u / \partial y$ .

For  $u = A_3 x + B_3$  we compute  $\partial^2 u / \partial x^2 = \partial u / \partial y = 0$ . Then  $\partial^2 u / \partial x^2 = 4\partial u / \partial y$ .

30. We identify  $A = xy + 1$ ,  $B = x + 2y$ , and  $C = 1$ . Then  $B^2 - 4AC = x^2 + 4y^2 - 4$ . The equation  $x^2 + 4y^2 = 4$  defines an ellipse. The partial differential equation is hyperbolic outside the ellipse, parabolic on the ellipse, and elliptic inside the ellipse.

## Exercises 12.2

1.  $k \frac{\partial^2 u}{\partial x^2} = \frac{\partial u}{\partial t}, \quad 0 < x < L, t > 0$

$$u(0, t) = 0, \quad \left. \frac{\partial u}{\partial x} \right|_{x=L} = 0, \quad t > 0$$

$$u(x, 0) = f(x), \quad 0 < x < L$$

2.  $k \frac{\partial^2 u}{\partial x^2} = \frac{\partial u}{\partial t}, \quad 0 < x < L, t > 0$

$$u(0, t) = u_0, \quad u(L, t) = u_1, \quad t > 0$$

$$u(x, 0) = 0, \quad 0 < x < L$$

### Exercises 12.2

3.  $k \frac{\partial^2 u}{\partial x^2} = \frac{\partial u}{\partial t}$ ,  $0 < x < L$ ,  $t > 0$   
 $u(0, t) = 100$ ,  $\left. \frac{\partial u}{\partial x} \right|_{x=L} = -hu(L, t)$ ,  $t > 0$   
 $u(x, 0) = f(x)$ ,  $0 < x < L$
4.  $k \frac{\partial^2 u}{\partial x^2} + h(u - 50) = \frac{\partial u}{\partial t}$ ,  $0 < x < L$ ,  $t > 0$   
 $\left. \frac{\partial u}{\partial x} \right|_{x=0} = 0$ ,  $\left. \frac{\partial u}{\partial x} \right|_{x=L} = 0$ ,  $t > 0$   
 $u(x, 0) = 100$ ,  $0 < x < L$
5.  $a^2 \frac{\partial^2 u}{\partial x^2} = \frac{\partial^2 u}{\partial t^2}$ ,  $0 < x < L$ ,  $t > 0$   
 $u(0, t) = 0$ ,  $u(L, t) = 0$ ,  $t > 0$   
 $u(x, 0) = x(L - x)$ ,  $\left. \frac{\partial u}{\partial x} \right|_{t=0} = 0$ ,  $0 < x < L$
6.  $a^2 \frac{\partial^2 u}{\partial x^2} = \frac{\partial^2 u}{\partial t^2}$ ,  $0 < x < L$ ,  $t > 0$   
 $u(0, t) = 0$ ,  $u(L, t) = 0$ ,  $t > 0$   
 $u(x, 0) = 0$ ,  $\left. \frac{\partial u}{\partial x} \right|_{t=0} = \sin \frac{\pi x}{L}$ ,  $0 < x < L$
7.  $a^2 \frac{\partial^2 u}{\partial x^2} - 2\beta \frac{\partial u}{\partial t} = \frac{\partial^2 u}{\partial t^2}$ ,  $0 < x < L$ ,  $t > 0$   
 $u(0, t) = 0$ ,  $u(L, t) = \sin \pi t$ ,  $t > 0$   
 $u(x, 0) = f(x)$ ,  $\left. \frac{\partial u}{\partial t} \right|_{t=0} = 0$ ,  $0 < x < L$
8.  $a^2 \frac{\partial^2 u}{\partial x^2} + Ax = \frac{\partial^2 u}{\partial t^2}$ ,  $0 < x < L$ ,  $t > 0$ ,  $A$  a constant  
 $u(0, t) = 0$ ,  $u(L, t) = 0$ ,  $t > 0$   
 $u(x, 0) = 0$ ,  $\left. \frac{\partial u}{\partial x} \right|_{t=0} = 0$ ,  $0 < x < L$
9.  $\frac{\partial^2 u}{\partial x^2} + \frac{\partial^2 u}{\partial y^2} = 0$ ,  $0 < x < 4$ ,  $0 < y < 2$   
 $\left. \frac{\partial u}{\partial x} \right|_{x=0} = 0$ ,  $u(4, y) = f(y)$ ,  $0 < y < 2$

$$\frac{\partial u}{\partial y} \Big|_{y=0} = 0, \quad u(x, 2) = 0, \quad 0 < x < 4$$

$$10. \quad \frac{\partial^2 u}{\partial x^2} + \frac{\partial^2 u}{\partial y^2} = 0, \quad 0 < x < \pi, \quad y > 0$$

$$u(0, y) = e^{-y}, \quad u(\pi, y) = \begin{cases} 100, & 0 < y \leq 1 \\ 0, & y > 1 \end{cases}$$

$$u(x, 0) = f(x), \quad 0 < x < \pi$$

---

### Exercises 12.3

---

1. Using  $u = XT$  and  $-\lambda^2$  as a separation constant leads to

$$X'' + \lambda^2 X = 0,$$

$$X(0) = 0,$$

$$X(L) = 0,$$

and

$$T' + k\lambda^2 T = 0.$$

Then

$$X = c_1 \sin \frac{n\pi}{L} x \quad \text{and} \quad T = c_2 e^{-\frac{kn^2\pi^2}{L^2} t}$$

for  $n = 1, 2, 3, \dots$  so that

$$u = \sum_{n=1}^{\infty} A_n e^{-\frac{kn^2\pi^2}{L^2} t} \sin \frac{n\pi}{L} x.$$

Imposing

$$u(x, 0) = \sum_{n=1}^{\infty} A_n \sin \frac{n\pi}{L} x$$

gives

$$A_n = \frac{2}{L} \int_0^{L/2} \sin \frac{n\pi}{L} x \, dx = \frac{2}{n\pi} \left( 1 - \cos \frac{n\pi}{2} \right)$$

for  $n = 1, 2, 3, \dots$  so that

$$u(x, t) = \frac{2}{\pi} \sum_{n=1}^{\infty} \frac{1 - \cos \frac{n\pi}{2}}{n} e^{-\frac{kn^2\pi^2}{L^2} t} \sin \frac{n\pi}{L} x.$$

2. Using  $u = XT$  and  $-\lambda^2$  as a separation constant leads to

$$X'' + \lambda^2 X = 0,$$

$$X(0) = 0,$$

### Exercises 12.3

$$X(L) = 0,$$

and

$$T' + k\lambda^2 T = 0.$$

Then

$$X = c_1 \sin \frac{n\pi}{L} x \quad \text{and} \quad T = c_2 e^{-\frac{kn^2\pi^2}{L^2} t}$$

for  $n = 1, 2, 3, \dots$  so that

$$u = \sum_{n=1}^{\infty} A_n e^{-\frac{kn^2\pi^2}{L^2} t} \sin \frac{n\pi}{L} x.$$

Imposing

$$u(x, 0) = \sum_{n=1}^{\infty} A_n \sin \frac{n\pi}{L} x$$

gives

$$A_n = \frac{2}{L} \int_0^L x(L-x) \sin \frac{n\pi}{L} x \, dx = \frac{4L^2}{n^3\pi^3} [1 - (-1)^n]$$

for  $n = 1, 2, 3, \dots$  so that

$$u(x, t) = \frac{4L^2}{\pi^3} \sum_{n=1}^{\infty} \frac{1 - (-1)^n}{n^3} e^{-\frac{kn^2\pi^2}{L^2} t} \sin \frac{n\pi}{L} x.$$

3. Using  $u = XT$  and  $-\lambda^2$  as a separation constant leads to

$$X'' + \lambda^2 X = 0,$$

$$X'(0) = 0,$$

$$X'(L) = 0,$$

and

$$T' + k\lambda^2 T = 0.$$

Then

$$X = c_1 \cos \frac{n\pi}{L} x \quad \text{and} \quad T = c_2 e^{-\frac{kn^2\pi^2}{L^2} t}$$

for  $n = 0, 1, 2, \dots$  so that

$$u = \sum_{n=0}^{\infty} A_n e^{-\frac{kn^2\pi^2}{L^2} t} \cos \frac{n\pi}{L} x.$$

Imposing

$$u(x, 0) = f(x) = \sum_{n=0}^{\infty} A_n \cos \frac{n\pi}{L} x$$

gives

$$u(x, t) = \frac{1}{L} \int_0^L f(x) \, dx + \frac{2}{L} \sum_{n=1}^{\infty} \left( \int_0^L f(x) \cos \frac{n\pi}{L} x \, dx \right) e^{-\frac{kn^2\pi^2}{L^2} t} \cos \frac{n\pi}{L} x.$$



4. If  $L = 2$  and  $f(x)$  is  $x$  for  $0 < x < 1$  and  $f(x)$  is 0 for  $1 < x < 2$  then

$$u(x, t) = \frac{1}{4} + 4 \sum_{n=1}^{\infty} \left[ \frac{1}{2n\pi} \sin \frac{n\pi}{2} + \frac{1}{n^2\pi^2} \left( \cos \frac{n\pi}{2} - 1 \right) \right] e^{-\frac{kn^2\pi^2}{4}t} \cos \frac{n\pi}{2}x.$$

5. Using  $u = XT$  and  $-\lambda^2$  as a separation constant leads to

$$X'' + \lambda^2 X = 0,$$

$$X'(0) = 0,$$

$$X'(L) = 0,$$

and

$$T' + (h + k\lambda^2)T = 0.$$

Then

$$X = c_1 \cos \frac{n\pi}{L}x \quad \text{and} \quad T = c_2 e^{-\left(h + \frac{kn^2\pi^2}{L^2}\right)t}$$

for  $n = 0, 1, 2, \dots$  so that

$$u = \sum_{n=0}^{\infty} A_n e^{-\left(h + \frac{kn^2\pi^2}{L^2}\right)t} \cos \frac{n\pi}{L}x.$$

Imposing

$$u(x, 0) = f(x) = \sum_{n=0}^{\infty} A_n \cos \frac{n\pi}{L}x$$

gives

$$u(x, t) = \frac{e^{-ht}}{L} \int_0^L f(x) dx + \frac{2}{L} \sum_{n=1}^{\infty} \left( \int_0^L f(x) \cos \frac{n\pi}{L}x dx \right) e^{-\left(h + \frac{kn^2\pi^2}{L^2}\right)t} \cos \frac{n\pi}{L}x.$$

6. In Problem 5 we instead find that  $X(0) = 0$  and  $X(L) = 0$  so that

$$X = c_1 \sin \frac{n\pi}{L}x$$

and

$$u = \frac{2}{L} \sum_{n=1}^{\infty} \left( \int_0^L f(x) \sin \frac{n\pi}{L}x dx \right) e^{-\left(h + \frac{kn^2\pi^2}{L^2}\right)t} \sin \frac{n\pi}{L}x.$$

7. (a) The solution is

$$u(x, t) = \sum_{n=1}^{\infty} A_n e^{-k(n^2\pi^2/100^2)t} \sin \frac{n\pi}{100}x,$$

where

$$A_n = \frac{2}{100} \left[ \int_0^{50} 0.8x \sin \frac{n\pi}{100}x dx + \int_{50}^{100} 0.8(100 - x) \sin \frac{n\pi}{100}x dx \right] = \frac{320}{n^2\pi^2} \sin \frac{n\pi}{2}.$$

Thus,

$$u(x, t) = \frac{320}{\pi^2} \sum_{n=1}^{\infty} \frac{1}{n^2} \left( \sin \frac{n\pi}{2} \right) e^{-k(n^2\pi^2/100^2)t} \sin \frac{n\pi}{100}x.$$

### Exercises 12.3

- (b) Since  $A_n = 0$  for  $n$  even, the first five nonzero terms correspond to  $n = 1, 3, 5, 7, 9$ . In this case  $\sin(n\pi/2) = \sin(2p-1)/2 = (-1)^{p+1}$  for  $p = 1, 2, 3, 4, 5$ , and

$$u(x, t) = \frac{320}{\pi^2} \sum_{p=1}^{\infty} \frac{(-1)^{p+1}}{(2p-1)^2} e^{(-1.6352(2p-1)^2\pi^2/100^2)t} \sin \frac{(2p-1)\pi}{100} x.$$

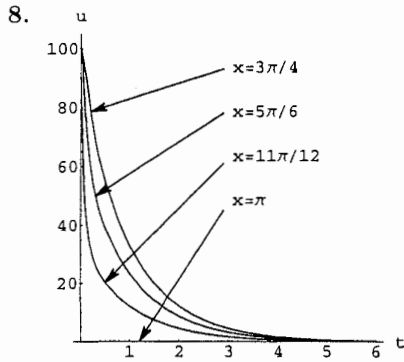
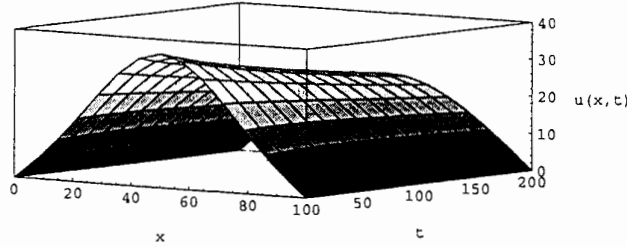

### Exercises 12.4

1. Using  $u = XT$  and  $-\lambda^2$  as a separation constant leads to

$$X'' + \lambda^2 X = 0,$$

$$X(0) = 0,$$

$$X(L) = 0,$$

and

$$T'' + \lambda^2 a^2 T = 0.$$

Then

$$X = c_1 \sin \frac{n\pi}{L} x \quad \text{and} \quad T = c_2 \cos \frac{n\pi a}{L} t + c_3 \sin \frac{n\pi a}{L} t$$

for  $n = 1, 2, 3, \dots$  so that

$$u = \sum_{n=1}^{\infty} \left( A_n \cos \frac{n\pi a}{L} t + B_n \sin \frac{n\pi a}{L} t \right) \sin \frac{n\pi}{L} x.$$

Imposing

$$u(x, 0) = \frac{1}{4} x(L - x) = \sum_{n=1}^{\infty} A_n \sin \frac{n\pi}{L} x$$

and

$$u_t(x, 0) = 0 = \sum_{n=1}^{\infty} B_n \frac{n\pi a}{L} \sin \frac{n\pi}{L} x$$

gives

$$A_n = \frac{L}{n^3 \pi^3} [1 - (-1)^n] \quad \text{and} \quad B_n = 0$$

for  $n = 1, 2, 3, \dots$  so that

$$u(x, t) = \frac{L^2}{\pi^3} \sum_{n=1}^{\infty} \frac{1 - (-1)^n}{n^3} \cos \frac{n\pi a}{L} t \sin \frac{n\pi}{L} x.$$

2. Using  $u = XT$  and  $-\lambda^2$  as a separation constant leads to

$$X'' + \lambda^2 X = 0,$$

$$X(0) = 0,$$

$$X(L) = 0,$$

and

$$T'' + \lambda^2 a^2 T = 0.$$

Then

$$X = c_1 \sin \frac{n\pi}{L} x \quad \text{and} \quad T = c_2 \cos \frac{n\pi a}{L} t + c_3 \sin \frac{n\pi a}{L} t$$

for  $n = 1, 2, 3, \dots$  so that

$$u = \sum_{n=1}^{\infty} \left( A_n \cos \frac{n\pi a}{L} t + B_n \sin \frac{n\pi a}{L} t \right) \sin \frac{n\pi}{L} x.$$

Imposing

$$u(x, 0) = 0 = \sum_{n=1}^{\infty} A_n \sin \frac{n\pi}{L} x$$

and

$$u_t(x, 0) = x(L - x) = \sum_{n=1}^{\infty} B_n \frac{n\pi a}{L} \sin \frac{n\pi}{L} x$$

gives

$$A_n = 0 \quad \text{and} \quad B_n \frac{n\pi a}{L} = \frac{4L^2}{n^3 \pi^3} [1 - (-1)^n]$$

### Exercises 12.4

for  $n = 1, 2, 3, \dots$  so that

$$u(x, t) = \frac{4L^3}{a\pi^4} \sum_{n=1}^{\infty} \frac{1 - (-1)^n}{n^4} \sin \frac{n\pi a}{L} t \sin \frac{n\pi}{L} x.$$

3. Using  $u = XT$  and  $-\lambda^2$  as a separation constant leads to

$$X'' + \lambda^2 X = 0,$$

$$X(0) = 0,$$

$$X(L) = 0,$$

and

$$T'' + \lambda^2 a^2 T = 0.$$

Then

$$X = c_1 \sin \frac{n\pi}{L} x \quad \text{and} \quad T = c_2 \cos \frac{n\pi a}{L} t + c_3 \sin \frac{n\pi a}{L} t$$

for  $n = 1, 2, 3, \dots$  so that

$$u = \sum_{n=1}^{\infty} \left( A_n \cos \frac{n\pi a}{L} t + B_n \sin \frac{n\pi a}{L} t \right) \sin \frac{n\pi}{L} x.$$

Imposing

$$u(x, 0) = \sum_{n=1}^{\infty} A_n \sin \frac{n\pi}{L} x$$

gives

$$A_n = \frac{2}{L} \left( \int_0^{L/3} \frac{3}{L} x \sin \frac{n\pi}{L} x dx + \int_{L/3}^{2L/3} \sin \frac{n\pi}{L} x dx + \int_{2L/3}^L \left( 3 - \frac{3}{L} x \right) \sin \frac{n\pi}{L} x dx \right)$$

so that

$$A_1 = \frac{6\sqrt{3}}{\pi^2},$$

$$A_2 = A_3 = A_4 = 0,$$

$$A_5 = -\frac{6\sqrt{3}}{5^2\pi^2},$$

$$A_6 = 0,$$

$$A_7 = \frac{6\sqrt{3}}{7^2\pi^2} \dots$$

Imposing

$$u_t(x, 0) = 0 = \sum_{n=1}^{\infty} B_n \frac{n\pi a}{L} \sin \frac{n\pi}{L} x$$

gives  $B_n = 0$  for  $n = 1, 2, 3, \dots$  so that

$$u(x, t) = \frac{6\sqrt{3}}{\pi^2} \left( \cos \frac{\pi a}{L} t \sin \frac{\pi}{L} x - \frac{1}{5^2} \cos \frac{5\pi a}{L} t \sin \frac{5\pi}{L} x + \frac{1}{7^2} \cos \frac{7\pi a}{L} t \sin \frac{7\pi}{L} x - \dots \right).$$

4. Using  $u = XT$  and  $-\lambda^2$  as a separation constant leads to

$$X'' + \lambda^2 X = 0,$$

$$X(0) = 0,$$

$$X(\pi) = 0,$$

and

$$T'' + \lambda^2 a^2 T = 0.$$

Then

$$X = c_1 \sin nx \quad \text{and} \quad T = c_2 \cos nat + c_3 \sin nat$$

for  $n = 1, 2, 3, \dots$  so that

$$u = \sum_{n=1}^{\infty} (A_n \cos nat + B_n \sin nat) \sin nx.$$

Imposing

$$u(x, 0) = \frac{1}{6}x(\pi^2 - x^2) = \sum_{n=1}^{\infty} A_n \sin nx \quad \text{and} \quad u_t(x, 0) = 0$$

gives

$$B_n = 0 \quad \text{and} \quad A_n = \frac{2}{n^3} (-1)^{n+1}$$

for  $n = 1, 2, 3, \dots$  so that

$$u(x, t) = 2 \sum_{n=1}^{\infty} \frac{(-1)^{n+1}}{n^3} \cos nat \sin nx.$$

5. Using  $u = XT$  and  $-\lambda^2$  as a separation constant leads to

$$X'' + \lambda^2 X = 0,$$

$$X(0) = 0,$$

$$X(\pi) = 0,$$

and

$$T'' + \lambda^2 a^2 T = 0.$$

Then

$$X = c_1 \sin nx \quad \text{and} \quad T = c_2 \cos nat + c_3 \sin nat$$

### Exercises 12.4

for  $n = 1, 2, 3, \dots$  so that

$$u = \sum_{n=1}^{\infty} (A_n \cos nat + B_n \sin nat) \sin nx.$$

Imposing

$$u(x, 0) = 0 = \sum_{n=1}^{\infty} A_n \sin nx \quad \text{and} \quad u_t(x, 0) = \sin x = \sum_{n=1}^{\infty} B_n na \sin nx$$

gives

$$A_n = 0, \quad B_1 = \frac{1}{a^2}, \quad \text{and} \quad B_n = 0$$

for  $n = 2, 3, 4, \dots$  so that

$$u(x, t) = \frac{1}{a} \sin at \sin x.$$

6. Using  $u = XT$  and  $-\lambda^2$  as a separation constant leads to

$$X'' + \lambda^2 X = 0,$$

$$X(0) = 0,$$

$$X(1) = 0,$$

and

$$T'' + \lambda^2 a^2 T = 0.$$

Then

$$X = c_1 \sin n\pi x \quad \text{and} \quad T = c_2 \cos n\pi at + c_3 \sin n\pi at$$

for  $n = 1, 2, 3, \dots$  so that

$$u = \sum_{n=1}^{\infty} (A_n \cos n\pi at + B_n \sin n\pi at) \sin n\pi x.$$

Imposing

$$u(x, 0) = 0.01 \sin 3\pi x = \sum_{n=1}^{\infty} A_n \sin n\pi x$$

and

$$u_t(x, 0) = 0 = \sum_{n=1}^{\infty} B_n n\pi a \sin n\pi x$$

gives  $B_n = 0$  for  $n = 1, 2, 3, \dots$ ,  $A_3 = 0.01$ , and  $A_n = 0$  for  $n = 1, 2, 4, 5, 6, \dots$  so that

$$u(x, t) = 0.01 \sin 3\pi x \cos 3\pi at.$$

7. Using  $u = XT$  and  $-\lambda^2$  as a separation constant leads to

$$X'' + \lambda^2 X = 0,$$

$$X(0) = 0,$$

$$X(L) = 0,$$

and

$$T'' + \lambda^2 a^2 T = 0.$$

Then

$$X = c_1 \sin \frac{n\pi}{L} x \quad \text{and} \quad T = c_2 \cos \frac{n\pi a}{L} t + c_3 \sin \frac{n\pi a}{L} t$$

for  $n = 1, 2, 3, \dots$  so that

$$u = \sum_{n=1}^{\infty} \left( A_n \cos \frac{n\pi a}{L} t + B_n \sin \frac{n\pi a}{L} t \right) \sin \frac{n\pi}{L} x.$$

Imposing

$$u(x, 0) = \sum_{n=1}^{\infty} A_n \sin \frac{n\pi}{L} x$$

and

$$u_t(x, 0) = 0 = \sum_{n=1}^{\infty} B_n \frac{n\pi a}{L} \sin \frac{n\pi}{L} x$$

gives

$$B_n = 0 \quad \text{and} \quad A_n = \frac{8h}{n^2 \pi^2} \sin \frac{n\pi}{2}$$

for  $n = 1, 2, 3, \dots$  so that

$$u(x, t) = \frac{8h}{\pi^2} \sum_{n=1}^{\infty} \frac{1}{n^2} \sin \frac{n\pi}{2} \cos \frac{n\pi a}{L} t \sin \frac{n\pi}{L} x.$$

8. Using  $u = XT$  and  $-\lambda^2$  as a separation constant leads to

$$X'' + \lambda^2 X = 0,$$

$$X'(0) = 0,$$

$$X'(L) = 0,$$

and

$$T'' + a^2 \lambda^2 T = 0.$$

Then

$$X = c_1 \cos \frac{n\pi}{L} x \quad \text{and} \quad T = c_2 \cos \frac{n\pi a}{L} t$$

for  $n = 1, 2, 3, \dots$ . Since  $\lambda = 0$  is also an eigenvalue with eigenfunction  $X(x) = 1$  we have

$$u = A_0 + \sum_{n=1}^{\infty} A_n \cos \frac{n\pi a}{L} t \cos \frac{n\pi}{L} x.$$

Imposing

$$u(x, 0) = x = \sum_{n=0}^{\infty} A_n \cos \frac{n\pi}{L} x$$

### Exercises 12.4

gives

$$A_0 = \frac{1}{L} \int_0^L x \, dx = \frac{L}{2}$$

and

$$A_n = \frac{2}{L} \int_0^L x \cos \frac{n\pi}{L} x \, dx = \frac{2L}{n^2\pi^2} [(-1)^n - 1]$$

for  $n = 1, 2, 3, \dots$ , so that

$$u(x, t) = \frac{L}{2} + \frac{2L}{\pi^2} \sum_{n=1}^{\infty} \frac{(-1)^n - 1}{n^2} \cos \frac{n\pi a}{L} t \cos \frac{n\pi}{L} x.$$

9. Using  $u = XT$  and  $-\lambda^2$  as a separation constant leads to

$$X'' + \lambda^2 X = 0,$$

$$X(0) = 0,$$

$$X(\pi) = 0,$$

and

$$T'' + 2\beta T' + \lambda^2 T = 0.$$

Then

$$X = c_1 \sin nx \quad \text{and} \quad T = e^{-\beta t} \left( c_2 \cos \sqrt{n^2 - \beta^2} t + c_3 \sin \sqrt{n^2 - \beta^2} t \right)$$

so that

$$u = \sum_{n=1}^{\infty} e^{-\beta t} \left( A_n \cos \sqrt{n^2 - \beta^2} t + B_n \sin \sqrt{n^2 - \beta^2} t \right) \sin nx.$$

Imposing

$$u(x, 0) = f(x) = \sum_{n=1}^{\infty} A_n \sin nx$$

and

$$u_t(x, 0) = 0 = \sum_{n=1}^{\infty} \left( B_n \sqrt{n^2 - \beta^2} - \beta A_n \right) \sin nx$$

gives

$$u(x, t) = e^{-\beta t} \sum_{n=1}^{\infty} A_n \left( \cos \sqrt{n^2 - \beta^2} t + \frac{\beta}{\sqrt{n^2 - \beta^2}} \sin \sqrt{n^2 - \beta^2} t \right) \sin nx,$$

where

$$A_n = \frac{2}{\pi} \int_0^{\pi} f(x) \sin nx \, dx.$$

10. Using  $u = XT$  and  $-\lambda^2$  as a separation constant leads to  $X'' + \lambda^2 X = 0$ ,  $X(0) = 0$ ,  $X(\pi) = 0$  and



Exercises 12.4

$T'' + (1 + \lambda^2)T = 0$ ,  $T'(0) = 0$ . Then  $X = c_2 \sin nx$  and  $T = c_3 \cos \sqrt{n^2 + 1} t$  for  $n = 1, 2, 3, \dots$  so that

$$u = \sum_{n=1}^{\infty} B_n \cos \sqrt{n^2 + 1} t \sin nx.$$

Imposing  $u(x, 0) = \sum_{n=1}^{\infty} B_n \sin nx$  gives

$$\begin{aligned} B_n &= \frac{2}{\pi} \int_0^{\pi/2} x \sin nx \, dx + \frac{2}{\pi} \int_{\pi/2}^{\pi} (\pi - x) \sin nx \, dx = \frac{4}{\pi n^2} \sin \frac{n\pi}{2} \\ &= \begin{cases} 0, & n \text{ even} \\ \frac{4}{\pi n^2} (-1)^{(n+3)/2}, & n = 2k - 1, k = 1, 2, 3, \dots \end{cases} \end{aligned}$$

Thus with  $n = 2k - 1$ ,

$$u(x, t) = \frac{4}{\pi} \sum_{n=1}^{\infty} \frac{\sin \frac{n\pi}{2}}{n^2} \cos \sqrt{n^2 + 1} t \sin nx = \frac{4}{\pi} \sum_{k=1}^{\infty} \frac{(-1)^{k+1}}{(2k-1)^2} \cos \sqrt{(2k-1)^2 + 1} t \sin(2k-1)x.$$

11. Separating variables in the partial differential equation gives

$$\frac{X^{(4)}}{X} = -\frac{T''}{a^2 T} = \lambda^4$$

so that

$$X^{(4)} - \lambda^4 X = 0$$

$$T'' + a^2 \lambda^4 T = 0$$

and

$$X = c_1 \cosh \lambda x + c_2 \sinh \lambda x + c_3 \cos \lambda x + c_4 \sin \lambda x$$

$$T = c_5 \cos a\lambda^2 t + c_6 \sin a\lambda^2 t.$$

The boundary conditions translate into  $X(0) = X(L) = 0$  and  $X''(0) = X''(L) = 0$ . From  $X(0) = X''(0) = 0$  we find  $c_1 = c_3 = 0$ . From

$$X(L) = c_2 \sinh \lambda L + c_4 \sin \lambda L = 0$$

$$X''(L) = \lambda^2 c_2 \sinh \lambda L - \lambda^2 c_4 \sin \lambda L = 0$$

we see by subtraction that  $c_4 \sin \lambda L = 0$ . This equation yields the eigenvalues  $\lambda = n\pi/L$  for  $n = 1, 2, 3, \dots$ . The corresponding eigenfunctions are

$$X = c_4 \sin \frac{n\pi}{L} x.$$

Thus

$$u(x, t) = \sum_{n=1}^{\infty} \left( A_n \cos \frac{n^2 \pi^2}{L^2} at + B_n \sin \frac{n^2 \pi^2}{L^2} at \right) \sin \frac{n\pi}{L} x.$$

### Exercises 12.4

From

$$u(x, 0) = f(x) = \sum_{n=1}^{\infty} A_n \sin \frac{n\pi}{L} x$$

we obtain

$$A_n = \frac{2}{L} \int_0^L f(x) \sin \frac{n\pi}{L} x dx.$$

From

$$\frac{\partial u}{\partial t} = \sum_{n=1}^{\infty} \left( -A_n \frac{n^2 \pi^2 a}{L^2} \sin \frac{n^2 \pi^2}{L^2} at + B_n \frac{n^2 \pi^2 a}{L^2} \cos \frac{n^2 \pi^2}{L^2} at \right) \sin \frac{n\pi}{L} x$$

and

$$\left. \frac{\partial u}{\partial t} \right|_{t=0} = g(x) = \sum_{n=1}^{\infty} B_n \frac{n^2 \pi^2 a}{L^2} \sin \frac{n\pi}{L} x$$

we obtain

$$B_n \frac{n^2 \pi^2 a}{L^2} = \frac{2}{L} \int_0^L g(x) \sin \frac{n\pi}{L} x dx$$

and

$$B_n = \frac{2L}{n^2 \pi^2 a} \int_0^L g(x) \sin \frac{n\pi}{L} x dx.$$

12. (a) Using

$$X = c_1 \cosh \lambda x + c_2 \sinh \lambda x + c_3 \cos \lambda x + c_4 \sin \lambda x$$

and  $X(0) = 0$ ,  $X'(0) = 0$  we find, in turn,  $c_3 = -c_1$  and  $c_4 = -c_2$ . The conditions  $X(L) = 0$  and  $X'(L) = 0$  then yield the system of equations for  $c_1$  and  $c_2$ :

$$c_1(\cosh \lambda L - \cos \lambda L) + c_2(\sinh \lambda L - \sin \lambda L) = 0$$

$$c_1(\lambda \sinh \lambda L + \lambda \sin \lambda L) + c_2(\lambda \cosh \lambda L - \lambda \cos \lambda L) = 0.$$

In order that this system have nontrivial solutions the determinant of the coefficients must be zero:

$$\lambda(\cosh \lambda L - \cos \lambda L)^2 - \lambda(\sinh^2 \lambda L - \sin^2 \lambda L) = 0.$$

$\lambda = 0$  is not an eigenvalue since this leads to  $X = 0$ . Thus the last equation simplifies to  $\cosh \lambda L \cos \lambda L = 1$  or  $\cosh x \cos x = 1$ , where  $x = \lambda L$ .

(b) The equation  $\cosh x \cos x = 1$  is the same as  $\cos x = \operatorname{sech} x$ . The figure indicates that the equation has an infinite number of roots.

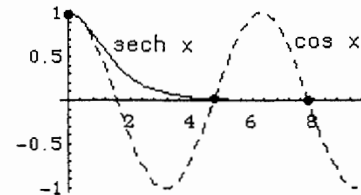

- (c) Using a CAS we find the first four positive roots to be  $x_1 = 4.7300$ ,  $x_2 = 7.8532$ ,  $x_3 = 10.9956$ , and  $x_4 = 14.1372$ . Thus the first four eigenvalues are  $\lambda_1 = x_1/L = 4.7300/L$ ,  $\lambda_2 = x_2/L = 7.8532/L$ ,  $\lambda_3 = x_3/L = 10.9956/L$ , and  $\lambda_4 = 14.1372/L$ .

13. From (5) in the text we have

$$u(x, t) = \sum_{n=1}^{\infty} \left( A_n \cos \frac{n\pi a}{L} t + B_n \sin \frac{n\pi a}{L} t \right) \sin \frac{n\pi}{L} x.$$

Since  $u_t(x, 0) = g(x) = 0$  we have  $B_n = 0$  and

$$\begin{aligned} u(x, t) &= \sum_{n=1}^{\infty} A_n \cos \frac{n\pi a}{L} t \sin \frac{n\pi}{L} x \\ &= \sum_{n=1}^{\infty} A_n \frac{1}{2} \left[ \sin \left( \frac{n\pi}{L} x + \frac{n\pi a}{L} t \right) + \sin \left( \frac{n\pi}{L} x - \frac{n\pi a}{L} t \right) \right] \\ &= \frac{1}{2} \sum_{n=1}^{\infty} A_n \left[ \sin \frac{n\pi}{L} (x + at) + \sin \frac{n\pi}{L} (x - at) \right]. \end{aligned}$$

From

$$u(x, 0) = f(x) = \sum_{n=1}^{\infty} A_n \sin \frac{n\pi}{L} x$$

we identify

$$f(x + at) = \sum_{n=1}^{\infty} A_n \sin \frac{n\pi}{L} (x + at)$$

and

$$f(x - at) = \sum_{n=1}^{\infty} A_n \sin \frac{n\pi}{L} (x - at),$$

so that

$$u(x, t) = \frac{1}{2} [f(x + at) + f(x - at)].$$

14. (a) We note that  $\xi_x = \eta_x = 1$ ,  $\xi_t = a$ , and  $\eta_t = -a$ . Then

$$\frac{\partial u}{\partial x} = \frac{\partial u}{\partial \xi} \frac{\partial \xi}{\partial x} + \frac{\partial u}{\partial \eta} \frac{\partial \eta}{\partial x} = u_\xi + u_\eta$$

and

$$\begin{aligned} \frac{\partial^2 u}{\partial x^2} &= \frac{\partial}{\partial x} (u_\xi + u_\eta) = \frac{\partial u_\xi}{\partial \xi} \frac{\partial \xi}{\partial x} + \frac{\partial u_\xi}{\partial \eta} \frac{\partial \eta}{\partial x} + \frac{\partial u_\eta}{\partial \xi} \frac{\partial \xi}{\partial x} + \frac{\partial u_\eta}{\partial \eta} \frac{\partial \eta}{\partial x} \\ &= u_{\xi\xi} + 2u_{\xi\eta} + u_{\eta\eta}. \end{aligned}$$

Similarly

$$\frac{\partial^2 u}{\partial t^2} = a^2 (u_{\xi\xi} - 2u_{\xi\eta} + u_{\eta\eta}).$$

### Exercises 12.4

Thus

$$a^2 \frac{\partial^2 u}{\partial x^2} = \frac{\partial^2 u}{\partial t^2} \quad \text{becomes} \quad \frac{\partial^2 u}{\partial \xi \partial \eta} = 0.$$

(b) Integrating

$$\frac{\partial^2 u}{\partial \xi \partial \eta} = \frac{\partial}{\partial \eta} u_\xi = 0$$

we obtain

$$\int \frac{\partial}{\partial \eta} u_\xi d\eta = \int 0 d\eta$$

$$u_\xi = f(\xi).$$

Integrating this result with respect to  $\xi$  we obtain

$$\int \frac{\partial u}{\partial \xi} d\xi = \int f(\xi) d\xi$$

$$u = F(\xi) + G(\eta).$$

Since  $\xi = x + at$  and  $\eta = x - at$ , we then have

$$u = F(\xi) + G(\eta) = F(x + at) + G(x - at).$$

Next, we have

$$u(x, t) = F(x + at) + G(x - at)$$

$$u(x, 0) = F(x) + G(x) = f(x)$$

$$u_t(x, 0) = aF'(x) - aG'(x) = g(x)$$

Integrating the last equation with respect to  $x$  gives

$$F(x) - G(x) = \frac{1}{a} \int_{x_0}^x g(s) ds + c_1.$$

Substituting  $G(x) = f(x) - F(x)$  we obtain

$$F(x) = \frac{1}{2} f(x) + \frac{1}{2a} \int_{x_0}^x g(s) ds + C$$

where  $c = c_1/2$ . Thus

$$G(x) = \frac{1}{2} f(x) - \frac{1}{2a} \int_{x_0}^x g(s) ds - c.$$

(c) From the expressions for  $F$  and  $G$ ,

$$F(x + at) = \frac{1}{2} f(x + at) + \frac{1}{2a} \int_{x_0}^{x+at} g(s) ds + c$$

$$G(x - at) = \frac{1}{2} f(x - at) - \frac{1}{2a} \int_{x_0}^{x-at} g(s) ds - c.$$

Thus,

$$u(x, t) = F(x + at) + G(x - at) = \frac{1}{2}[f(x + at) + f(x - at)] + \frac{1}{2a} \int_{x-at}^{x+at} g(s) ds.$$

Here we have used  $-\int_{x_0}^{x-at} g(s) ds = \int_{x-at}^{x_0} g(s) ds$ .

$$\begin{aligned} 15. \quad u(x, t) &= \frac{1}{2}[\sin(x + at) + \sin(x - at)] + \frac{1}{2a} \int_{x-at}^{x+at} ds \\ &= \frac{1}{2}[\sin x \cos at + \cos x \sin at + \sin x \cos at - \cos x \sin at] + \frac{1}{2a} s \Big|_{x-at}^{x+at} = \sin x \cos at + t \end{aligned}$$

$$\begin{aligned} 16. \quad u(x, t) &= \frac{1}{2}[\sin(x + at) + \sin(x - at)] + \frac{1}{2a} \int_{x-at}^{x+at} \cos s ds \\ &= \sin x \cos at + \frac{1}{2a}[\sin(x + at) - \sin(x - at)] = \sin x \cos at + \frac{1}{a} \cos x \sin at \end{aligned}$$

$$\begin{aligned} 17. \quad u(x, t) &= 0 + \frac{1}{2a} \int_{x-at}^{x+at} \sin 2s ds = \frac{1}{2a} \left[ \frac{-\cos(2x + 2at) + \cos(2x - 2at)}{2} \right] \\ &= \frac{1}{4a}[-\cos 2x \cos 2at + \sin 2x \sin 2at + \cos 2x \cos 2at + \sin 2x \sin 2at] = \frac{1}{2a} \sin 2x \sin 2at \end{aligned}$$

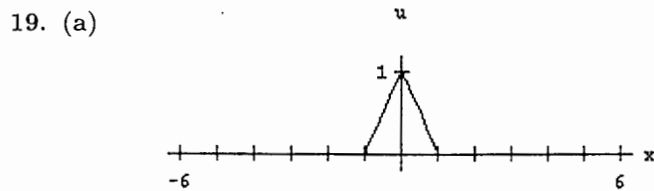
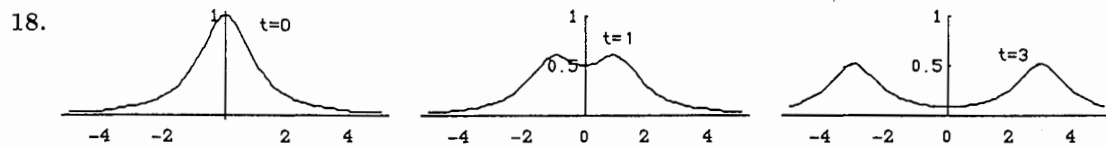

(b) Since  $g(x) = 0$ , d'Alembert's solution with  $a = 1$  is

$$u(x, t) = \frac{1}{2}[f(x + t) + f(x - t)].$$

### Exercises 12.4

Sample plots are shown below.

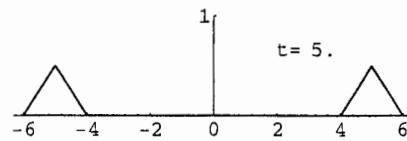
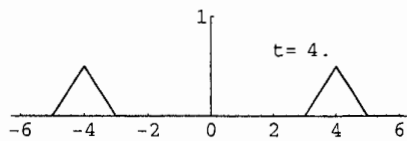
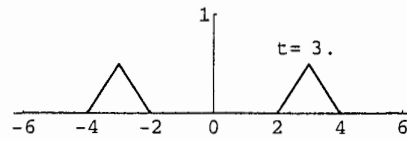
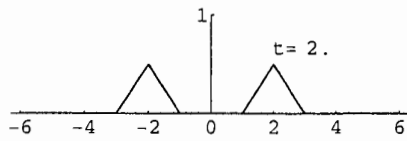
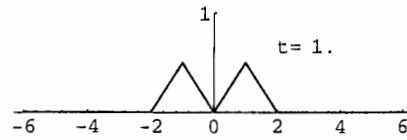
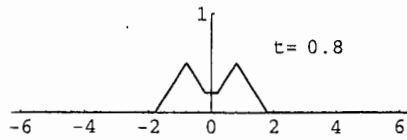
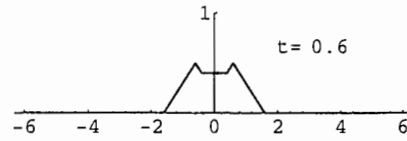
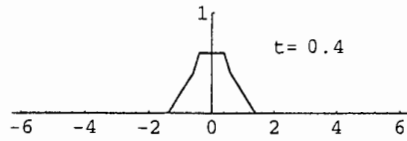
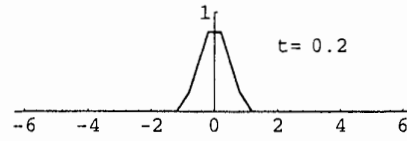
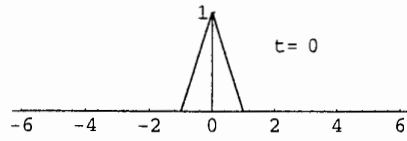

(c) The single peaked wave dissolves into two peaks moving outward.

20. (a) With  $a = 1$ , d'Alembert's solution is

$$u(x, t) = \frac{1}{2} \int_{x-t}^{x+t} g(s) ds \quad \text{where} \quad g(s) = \begin{cases} 1, & |s| \leq 0.1 \\ 0, & |s| > 0.1 \end{cases}$$

Exercises 12.4

Sample plots are shown below.

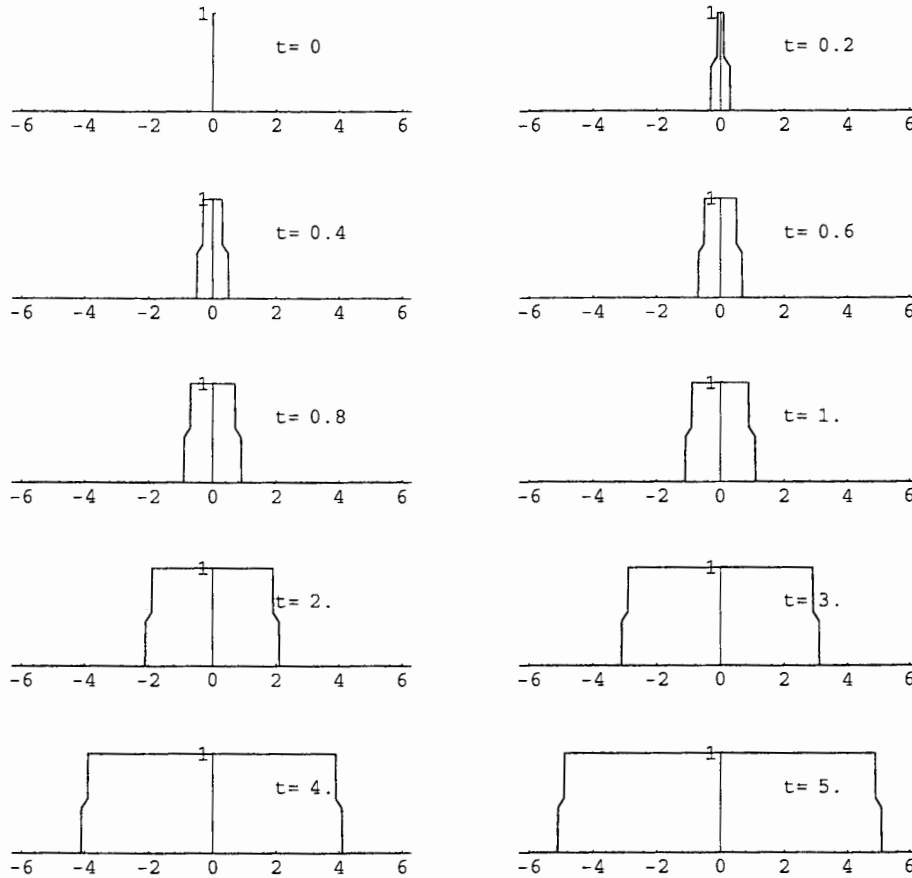

(b) Some frames of the movie are shown in part (a). The string has a roughly rectangular shape with the base on the  $x$ -axis increasing in length.

21. (a) and (b) With the given parameters, the solution is

$$u(x, t) = \frac{8}{\pi^2} \sum_{n=1}^{\infty} \frac{1}{n^2} \sin \frac{n\pi}{2} \cos nt \sin nx.$$

For  $n$  even,  $\sin(n\pi/2) = 0$ , so the first six nonzero terms correspond to  $n = 1, 3, 5, 7, 9, 11$ . In this case  $\sin(n\pi/2) = \sin(2p-1)/2 = (-1)^{p+1}$  for  $p = 1, 2, 3, 4, 5, 6$ , and

$$u(x, t) = \frac{8}{\pi^2} \sum_{p=1}^{\infty} \frac{(-1)^{p+1}}{(2p-1)^2} \cos(2p-1)t \sin(2p-1)x.$$

### Exercises 12.4

Frames of the movie corresponding to  $t = 0.5, 1, 1.5,$  and  $2$  are shown.

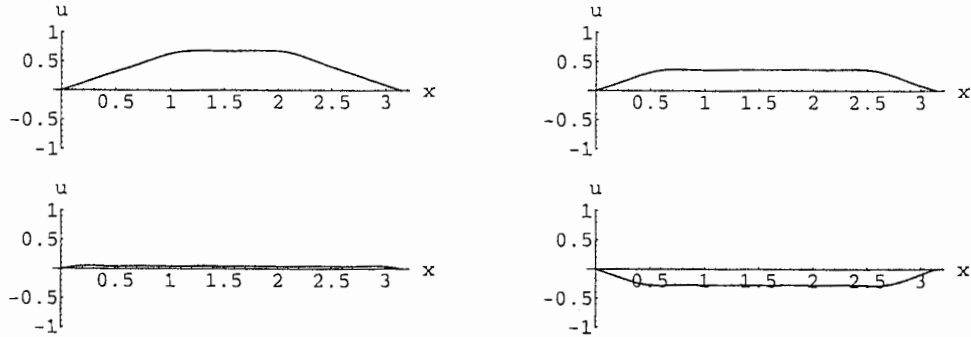

---

### Exercises 12.5

1. Using  $u = XY$  and  $-\lambda^2$  as a separation constant leads to

$$X'' + \lambda^2 X = 0,$$

$$X(0) = 0,$$

$$X(a) = 0,$$

and

$$Y'' - \lambda^2 Y = 0,$$

$$Y(0) = 0.$$

Then

$$X = c_1 \sin \frac{n\pi}{a} x \quad \text{and} \quad Y = c_2 \sinh \frac{n\pi}{a} y$$

for  $n = 1, 2, 3, \dots$  so that

$$u = \sum_{n=1}^{\infty} A_n \sin \frac{n\pi}{a} x \sinh \frac{n\pi}{a} y.$$

Imposing

$$u(x, b) = f(x) = \sum_{n=1}^{\infty} A_n \sinh \frac{n\pi b}{a} \sin \frac{n\pi}{a} x$$

gives

$$A_n \sinh \frac{n\pi b}{a} = \frac{2}{a} \int_0^a f(x) \sin \frac{n\pi}{a} x dx$$

so that

$$u(x, y) = \sum_{n=1}^{\infty} A_n \sin \frac{n\pi}{a} x \sinh \frac{n\pi}{a} y$$



where

$$A_n = \frac{2}{a} \operatorname{csch} \frac{n\pi b}{a} \int_0^a f(x) \sin \frac{n\pi}{a} x \, dx.$$

2. Using  $u = XY$  and  $-\lambda^2$  as a separation constant leads to

$$X'' + \lambda^2 X = 0,$$

$$X(0) = 0,$$

$$X(a) = 0,$$

and

$$Y'' - \lambda^2 Y = 0,$$

$$Y'(0) = 0.$$

Then

$$X = c_1 \sin \frac{n\pi}{a} x \quad \text{and} \quad Y = c_2 \cosh \frac{n\pi}{a} y$$

for  $n = 1, 2, 3, \dots$  so that

$$u = \sum_{n=1}^{\infty} A_n \sin \frac{n\pi}{a} x \cosh \frac{n\pi}{a} y.$$

Imposing

$$u(x, b) = f(x) = \sum_{n=1}^{\infty} A_n \cosh \frac{n\pi b}{a} \sin \frac{n\pi}{a} x$$

gives

$$A_n \cosh \frac{n\pi b}{a} = \frac{2}{a} \int_0^a f(x) \sin \frac{n\pi}{a} x \, dx$$

so that

$$u(x, y) = \sum_{n=1}^{\infty} A_n \sin \frac{n\pi}{a} x \cosh \frac{n\pi}{a} y$$

where

$$A_n = \frac{2}{a} \operatorname{sech} \frac{n\pi b}{a} \int_0^a f(x) \sin \frac{n\pi}{a} x \, dx.$$

3. Using  $u = XY$  and  $-\lambda^2$  as a separation constant leads to

$$X'' + \lambda^2 X = 0,$$

$$X(0) = 0,$$

$$X(a) = 0,$$

and

$$Y'' - \lambda^2 Y = 0,$$

$$Y(b) = 0.$$

### Exercises 12.5

Then

$$X = c_1 \sin \frac{n\pi}{a} x \quad \text{and} \quad Y = c_2 \cosh \frac{n\pi}{a} y - c_2 \frac{\cosh \frac{n\pi b}{a}}{\sinh \frac{n\pi b}{a}} \sinh \frac{n\pi}{a} y$$

for  $n = 1, 2, 3, \dots$  so that

$$u = \sum_{n=1}^{\infty} A_n \sin \frac{n\pi}{a} x \left( \cosh \frac{n\pi}{a} y - \frac{\cosh \frac{n\pi b}{a}}{\sinh \frac{n\pi b}{a}} \sinh \frac{n\pi}{a} y \right).$$

Imposing

$$u(x, 0) = f(x) = \sum_{n=1}^{\infty} A_n \sin \frac{n\pi}{a} x$$

gives

$$A_n = \frac{2}{a} \int_0^a f(x) \sin \frac{n\pi}{a} x dx$$

so that

$$u(x, y) = \frac{2}{a} \sum_{n=1}^{\infty} \left( \int_0^a f(x) \sin \frac{n\pi}{a} x dx \right) \sin \frac{n\pi}{a} x \left( \cosh \frac{n\pi}{a} y - \frac{\cosh \frac{n\pi b}{a}}{\sinh \frac{n\pi b}{a}} \sinh \frac{n\pi}{a} y \right).$$

4. Using  $u = XY$  and  $-\lambda^2$  as a separation constant leads to

$$X'' + \lambda^2 X = 0,$$

$$X'(0) = 0,$$

$$X'(a) = 0,$$

and

$$Y'' - \lambda^2 Y = 0,$$

$$Y(b) = 0.$$

Then

$$X = c_1 \cos \frac{n\pi}{a} x$$

for  $n = 0, 1, 2, \dots$  and

$$Y = c_2(y - b) \quad \text{or} \quad Y = c_2 \cosh \frac{n\pi}{a} y - c_2 \frac{\cosh \frac{n\pi b}{a}}{\sinh \frac{n\pi b}{a}} \sinh \frac{n\pi}{a} y$$

so that

$$u = A_0(y - b) + \sum_{n=1}^{\infty} A_n \cos \frac{n\pi}{a} x \left( \cosh \frac{n\pi}{a} y - \frac{\cosh \frac{n\pi b}{a}}{\sinh \frac{n\pi b}{a}} \sinh \frac{n\pi}{a} y \right).$$

Imposing

$$u(x, 0) = x = -A_0 b + \sum_{n=1}^{\infty} A_n \cos \frac{n\pi}{a} x$$

gives

$$-A_0b = \frac{1}{a} \int_0^a x \, dx = \frac{1}{2}a$$

and

$$A_n = \frac{2}{a} \int_0^a x \cos \frac{n\pi}{a} x \, dx = \frac{2a}{n^2\pi^2} [(-1)^n - 1]$$

so that

$$u(x, y) = \frac{a}{2b}(b - y) + \frac{2a}{\pi^2} \sum_{n=1}^{\infty} \frac{(-1)^n - 1}{n^2} \cos \frac{n\pi}{a} x \left( \cosh \frac{n\pi}{a} y - \frac{\cosh \frac{n\pi b}{a}}{\sinh \frac{n\pi b}{a}} \sinh \frac{n\pi}{a} y \right).$$

5. Using  $u = XY$  and  $\lambda^2$  as a separation constant leads to

$$X'' + -\lambda^2 X = 0,$$

$$X(0) = 0,$$

and

$$Y'' + \lambda^2 Y = 0,$$

$$Y'(0) = 0,$$

$$Y'(1) = 0.$$

Then

$$Y = c_1 \cos n\pi y$$

for  $n = 0, 1, 2, \dots$  and

$$X = c_2 x \quad \text{or} \quad X = c_2 \sinh n\pi x$$

for  $n = 1, 2, 3, \dots$  so that

$$u = A_0 x + \sum_{n=1}^{\infty} A_n \sinh n\pi x \cos n\pi y.$$

Imposing

$$u(1, y) = 1 - y = A_0 + \sum_{n=1}^{\infty} A_n \sinh n\pi \cos n\pi y$$

gives

$$A_0 = \int_0^1 (1 - y) \, dy$$

and

$$A_n \sinh n\pi = 2 \int_0^1 (1 - y) \cos n\pi y \, dy = \frac{2[1 - (-1)^n]}{n^2\pi^2 \sinh n\pi}$$

for  $n = 1, 2, 3, \dots$  so that

$$u(x, y) = \frac{1}{2}x + \frac{2}{\pi^2} \sum_{n=1}^{\infty} \frac{1 - (-1)^n}{n^2 \sinh n\pi} \sinh n\pi x \cos n\pi y.$$

### Exercises 12.5

6. Using  $u = XY$  and  $\lambda^2$  as a separation constant leads to

$$X'' - \lambda^2 X = 0,$$

$$X'(1) = 0,$$

and

$$Y'' + \lambda^2 Y = 0,$$

$$Y'(0) = 0,$$

$$Y'(\pi) = 0.$$

Then

$$Y = c_1 \cos ny$$

for  $n = 0, 1, 2, \dots$  and

$$X = c_2 \cosh nx - c_2 \frac{\sinh n}{\cosh n} \sinh nx$$

for  $n = 0, 1, 2, \dots$  so that

$$u = A_0 + \sum_{n=1}^{\infty} A_n \left( \cosh nx - \frac{\sinh n}{\cosh n} \sinh nx \right) \cos ny.$$

Imposing

$$u(0, y) = g(y) = A_0 + \sum_{n=1}^{\infty} A_n \cos ny$$

gives

$$A_0 = \frac{1}{\pi} \int_0^{\pi} g(y) dy \quad \text{and} \quad A_n = \frac{2}{\pi} \int_0^{\pi} g(y) \cos ny dy$$

for  $n = 1, 2, 3, \dots$  so that

$$u(x, y) = \frac{1}{\pi} \int_0^{\pi} g(y) dy + \sum_{n=1}^{\infty} \left( \frac{2}{\pi} \int_0^{\pi} g(y) \cos ny dy \right) \left( \cosh nx - \frac{\sinh n}{\cosh n} \sinh nx \right) \cos ny.$$

7. Using  $u = XY$  and  $\lambda^2$  as a separation constant leads to

$$X'' - \lambda^2 X = 0,$$

$$X'(0) = X(0),$$

and

$$Y'' + \lambda^2 Y = 0,$$

$$Y(0) = 0,$$

$$Y(\pi) = 0.$$

Then

$$Y = c_1 \sin ny \quad \text{and} \quad X = c_2 (n \cosh nx + \sinh nx)$$

for  $n = 1, 2, 3, \dots$  so that

$$u = \sum_{n=1}^{\infty} A_n (n \cosh nx + \sinh nx) \sin ny.$$

Imposing

$$u(\pi, y) = 1 = \sum_{n=1}^{\infty} A_n (n \cosh n\pi + \sinh n\pi) \sin ny$$

gives

$$A_n (n \cosh n\pi + \sinh n\pi) = \frac{2}{\pi} \int_0^{\pi} \sin ny \, dy = \frac{2[1 - (-1)^n]}{n\pi}$$

for  $n = 1, 2, 3, \dots$  so that

$$u(x, y) = \frac{2}{\pi} \sum_{n=1}^{\infty} \frac{1 - (-1)^n}{n} \frac{n \cosh nx + \sinh nx}{n \cosh n\pi + \sinh n\pi} \sin ny.$$

8. Using  $u = XY$  and  $-\lambda^2$  as a separation constant leads to

$$X'' + \lambda^2 X = 0,$$

$$X(0) = 0,$$

$$X(1) = 0$$

and

$$Y'' - \lambda^2 Y = 0,$$

$$Y'(0) = Y(0).$$

Then

$$X = c_1 \sin n\pi x \quad \text{and} \quad Y = c_2 (n \cosh n\pi y + \sinh n\pi y)$$

for  $n = 1, 2, 3, \dots$  so that

$$u = \sum_{n=1}^{\infty} A_n (n \cosh n\pi y + \sinh n\pi y) \sin n\pi x.$$

Imposing

$$u(x, 1) = f(x) = \sum_{n=1}^{\infty} A_n (n \cosh n\pi + \sinh n\pi) \sin n\pi x$$

gives

$$A_n (n \cosh n\pi + \sinh n\pi) = \frac{2}{\pi} \int_0^{\pi} f(x) \sin n\pi x \, dx$$

for  $n = 1, 2, 3, \dots$  so that

$$u(x, y) = \sum_{n=1}^{\infty} A_n (n \cosh n\pi y + \sinh n\pi y) \sin n\pi x$$

### Exercises 12.5

where

$$A_n = \frac{2}{n\pi \cosh n\pi + \pi \sinh n\pi} \int_0^1 f(x) \sin n\pi x dx.$$

9. This boundary-value problem has the form of Problem 1 in this section, with  $a = b = 1$ ,  $f(x) = 100$ , and  $g(x) = 200$ . The solution, then, is

$$u(x, y) = \sum_{n=1}^{\infty} (A_n \cosh n\pi y + B_n \sinh n\pi y) \sin n\pi x,$$

where

$$A_n = 2 \int_0^1 100 \sin n\pi x dx = 200 \left( \frac{1 - (-1)^n}{n\pi} \right)$$

and

$$\begin{aligned} B_n &= \frac{1}{\sinh n\pi} \left[ 2 \int_0^1 200 \sin n\pi x dx - A_n \cosh n\pi \right] \\ &= \frac{1}{\sinh n\pi} \left[ 400 \left( \frac{1 - (-1)^n}{n\pi} \right) - 200 \left( \frac{1 - (-1)^n}{n\pi} \right) \cosh n\pi \right] \\ &= 200 \left[ \frac{1 - (-1)^n}{n\pi} \right] [2 \operatorname{csch} n\pi - \operatorname{coth} n\pi]. \end{aligned}$$

10. This boundary-value problem has the form of Problem 2 in this section, with  $a = 1$  and  $b = 1$ . Thus, the solution has the form

$$u(x, y) = \sum_{n=1}^{\infty} (A_n \cosh n\pi x + B_n \sinh n\pi x) \sin n\pi y.$$

The boundary condition  $u(0, y) = 10y$  implies

$$10y = \sum_{n=1}^{\infty} A_n \sin n\pi y$$

and

$$A_n = \frac{2}{1} \int_0^1 10y \sin n\pi y dy = \frac{20}{n\pi} (-1)^{n+1}.$$

The boundary condition  $u_x(1, y) = -1$  implies

$$-1 = \sum_{n=1}^{\infty} (n\pi A_n \sinh n\pi + n\pi B_n \cosh n\pi) \sin n\pi y$$

and

$$n\pi A_n \sinh n\pi + n\pi B_n \cosh n\pi = \frac{2}{1} \int_0^1 (-\sin n\pi y) dy$$

$$A_n \sinh n\pi + B_n \cosh n\pi = -\frac{2}{n\pi} [1 - (-1)^n]$$

$$B_n = \frac{2}{n\pi} [(-1)^n - 1] \operatorname{sech} n\pi - \frac{20}{n\pi} (-1)^{n+1} \tanh n\pi.$$

11. Using  $u = XY$  and  $-\lambda^2$  as a separation constant leads to

$$X'' + \lambda^2 X = 0,$$

$$X(0) = 0,$$

$$X(\pi) = 0,$$

and

$$Y'' - \lambda^2 Y = 0.$$

Then the boundedness of  $u$  as  $y \rightarrow \infty$  gives  $Y = c_1 e^{-ny}$  and  $X = c_2 \sin nx$  for  $n = 1, 2, 3, \dots$  so that

$$u = \sum_{n=1}^{\infty} A_n e^{-ny} \sin nx.$$

Imposing

$$u(x, 0) = f(x) = \sum_{n=1}^{\infty} A_n \sin nx$$

gives

$$A_n = \frac{2}{\pi} \int_0^{\pi} f(x) \sin nx \, dx$$

so that

$$u(x, y) = \sum_{n=1}^{\infty} \left( \frac{2}{\pi} \int_0^{\pi} f(x) \sin nx \, dx \right) e^{-ny} \sin nx.$$

12. Using  $u = XY$  and  $-\lambda^2$  as a separation constant leads to

$$X'' + \lambda^2 X = 0,$$

$$X'(0) = 0,$$

$$X'(\pi) = 0,$$

and

$$Y'' - \lambda^2 Y = 0.$$

By the boundedness of  $u$  as  $y \rightarrow \infty$  we obtain  $Y = c_1 e^{-ny}$  for  $n = 1, 2, 3, \dots$  or  $Y = c_1$  and  $X = c_2 \cos nx$  for  $n = 0, 1, 2, \dots$  so that

$$u = A_0 + \sum_{n=1}^{\infty} A_n e^{-ny} \cos nx.$$

Imposing

$$u(x, 0) = f(x) = A_0 + \sum_{n=1}^{\infty} A_n \cos nx$$

gives

$$A_0 = \frac{1}{\pi} \int_0^{\pi} f(x) \, dx \quad \text{and} \quad A_n = \frac{2}{\pi} \int_0^{\pi} f(x) \cos nx \, dx$$

### Exercises 12.5

so that

$$u(x, y) = \frac{1}{\pi} \int_0^\pi f(x) dx + \sum_{n=1}^{\infty} \left( \frac{2}{\pi} \int_0^\pi f(x) \cos nx dx \right) e^{-ny} \cos nx.$$

13. Since the boundary conditions at  $y = 0$  and  $y = b$  are functions of  $x$  we choose to separate Laplace's equation as

$$\frac{X''}{X} = -\frac{Y''}{Y} = -\lambda^2$$

so that

$$X'' + \lambda^2 X = 0$$

$$Y'' - \lambda^2 Y = 0$$

and

$$X(x) = c_1 \cos \lambda x + c_2 \sin \lambda x$$

$$Y(y) = c_3 \cosh \lambda y + c_4 \sinh \lambda y.$$

Now  $X(0) = 0$  gives  $c_1 = 0$  and  $X(a) = 0$  implies  $\sin \lambda a = 0$  or  $\lambda = n\pi/a$  for  $n = 1, 2, 3, \dots$ . Thus

$$u_n(x, y) = XY = \left( A_n \cosh \frac{n\pi}{a} y + B_n \sinh \frac{n\pi}{a} y \right) \sin \frac{n\pi}{a} x$$

and

$$u(x, y) = \sum_{n=1}^{\infty} \left( A_n \cosh \frac{n\pi}{a} y + B_n \sinh \frac{n\pi}{a} y \right) \sin \frac{n\pi}{a} x. \quad (1)$$

At  $y = 0$  we then have

$$f(x) = \sum_{n=1}^{\infty} A_n \sin \frac{n\pi}{a} x$$

and consequently

$$A_n = \frac{2}{a} \int_0^a f(x) \sin \frac{n\pi}{a} x dx. \quad (2)$$

At  $y = b$ ,

$$g(y) = \sum_{n=1}^{\infty} \left( A_n \cosh \frac{n\pi}{a} b + B_n \sinh \frac{n\pi}{a} b \right) \sin \frac{n\pi}{a} x$$

indicates that the entire expression in the parentheses is given by

$$A_n \cosh \frac{n\pi}{a} b + B_n \sinh \frac{n\pi}{a} b = \frac{2}{a} \int_0^a g(x) \sin \frac{n\pi}{a} x dx.$$

We can now solve for  $B_n$ :

$$\begin{aligned} B_n \sinh \frac{n\pi}{a} b &= \frac{2}{a} \int_0^a g(x) \sin \frac{n\pi}{a} x dx - A_n \cosh \frac{n\pi}{a} b \\ B_n &= \frac{1}{\sinh \frac{n\pi}{a} b} \left( \frac{2}{a} \int_0^a g(x) \sin \frac{n\pi}{a} x dx - A_n \cosh \frac{n\pi}{a} b \right). \end{aligned} \quad (3)$$



A solution to the given boundary-value problem consists of the series (1) with coefficients  $A_n$  and  $B_n$  given in (2) and (3), respectively.

14. Since the boundary conditions at  $x = 0$  and  $x = a$  are functions of  $y$  we choose to separate Laplace's equation as

$$\frac{X''}{X} = -\frac{Y''}{Y} = \lambda^2$$

so that

$$X'' - \lambda^2 X = 0$$

$$Y'' + \lambda^2 Y = 0$$

and

$$X(x) = c_1 \cosh \lambda x + c_2 \sinh \lambda x$$

$$Y(y) = c_3 \cos \lambda y + c_4 \sin \lambda y.$$

Now  $Y(0) = 0$  gives  $c_3 = 0$  and  $Y(b) = 0$  implies  $\sin \lambda b = 0$  or  $\lambda = n\pi/b$  for  $n = 1, 2, 3, \dots$ . Thus

$$u_n(x, y) = XY = \left( A_n \cosh \frac{n\pi}{b} x + B_n \sinh \frac{n\pi}{b} x \right) \sin \frac{n\pi}{b} y$$

and

$$u(x, y) = \sum_{n=1}^{\infty} \left( A_n \cosh \frac{n\pi}{b} x + B_n \sinh \frac{n\pi}{b} x \right) \sin \frac{n\pi}{b} y. \quad (4)$$

At  $x = 0$  we then have

$$F(y) = \sum_{n=1}^{\infty} A_n \sin \frac{n\pi}{b} y$$

and consequently

$$A_n = \frac{2}{b} \int_0^b F(y) \sin \frac{n\pi}{b} y dy. \quad (5)$$

At  $x = a$ ,

$$G(y) = \sum_{n=1}^{\infty} \left( A_n \cosh \frac{n\pi}{b} a + B_n \sinh \frac{n\pi}{b} a \right) \sin \frac{n\pi}{b} y$$

indicates that the entire expression in the parentheses is given by

$$A_n \cosh \frac{n\pi}{b} a + B_n \sinh \frac{n\pi}{b} a = \frac{2}{b} \int_0^b G(y) \sin \frac{n\pi}{b} y dy.$$

We can now solve for  $B_n$ :

$$B_n \sinh \frac{n\pi}{b} a = \frac{2}{b} \int_0^b G(y) \sin \frac{n\pi}{b} y dy - A_n \cosh \frac{n\pi}{b} a$$

$$B_n = \frac{1}{\sinh \frac{n\pi}{b} a} \left( \frac{2}{b} \int_0^b G(y) \sin \frac{n\pi}{b} y dy - A_n \cosh \frac{n\pi}{b} a \right). \quad (6)$$

A solution to the given boundary-value problem consists of the series (4) with coefficients  $A_n$  and  $B_n$  given in (5) and (6), respectively.

### Exercises 12.5

In Problems 15 and 16 we refer to the discussion in the text under the heading **Superposition Principle**.

15. We identify  $a = b = \pi$ ,  $f(x) = 0$ ,  $g(x) = 1$ ,  $F(y) = 1$ , and  $G(y) = 1$ . Then  $A_n = 0$  and

$$u_1(x, y) = \sum_{n=1}^{\infty} B_n \sinh ny \sin nx$$

where

$$B_n = \frac{2}{\pi \sinh n\pi} \int_0^{\pi} \sin nx \, dx = \frac{2[1 - (-1)^n]}{n\pi \sinh n\pi}.$$

Next

$$u_2(x, y) = \sum_{n=1}^{\infty} (A_n \cosh nx + B_n \sinh nx) \sin ny$$

where

$$A_n = \frac{2}{\pi} \int_0^{\pi} \sin ny \, dy = \frac{2[1 - (-1)^n]}{n\pi}$$

and

$$\begin{aligned} B_n &= \frac{1}{\sinh n\pi} \left( \frac{2}{\pi} \int_0^{\pi} \sin ny \, dy - A_n \cosh n\pi \right) \\ &= \frac{1}{\sinh n\pi} \left( \frac{2[1 - (-1)^n]}{n\pi} - \frac{2[1 - (-1)^n]}{n\pi} \cosh n\pi \right) \\ &= \frac{2[1 - (-1)^n]}{n\pi \sinh n\pi} (1 - \cosh n\pi). \end{aligned}$$

Now

$$\begin{aligned} A_n \cosh nx + B_n \sinh nx &= \frac{2[1 - (-1)^n]}{n\pi} \left[ \cosh nx + \frac{\sinh nx}{\sinh n\pi} (1 - \cosh n\pi) \right] \\ &= \frac{2[1 - (-1)^n]}{n\pi \sinh n\pi} [\cosh nx \sinh n\pi + \sinh nx - \sinh nx \cosh n\pi] \\ &= \frac{2[1 - (-1)^n]}{n\pi \sinh n\pi} [\sinh nx + \sinh n(\pi - x)] \end{aligned}$$

and

$$\begin{aligned} u(x, y) = u_1 + u_2 &= \frac{2}{\pi} \sum_{n=1}^{\infty} \frac{1 - (-1)^n}{n \sinh n\pi} \sinh ny \sin nx \\ &\quad + \frac{2}{\pi} \sum_{n=1}^{\infty} \frac{[1 - (-1)^n][\sinh nx + \sinh n(\pi - x)]}{n \sinh n\pi} \sin ny. \end{aligned}$$

16. We identify  $a = b = 2$ ,  $f(x) = 0$ ,  $g(x) = \begin{cases} x, & 0 < x < 1 \\ 2 - x, & 1 < x < 2 \end{cases}$ ,  $F(y) = 0$ , and  $G(y) = y(2 - y)$ .

Then  $A_n = 0$  and

$$u_1(x, y) = \sum_{n=1}^{\infty} B_n \sinh \frac{n\pi}{2} y \sin \frac{n\pi}{2} x$$

where

$$\begin{aligned} B_n &= \frac{1}{\sinh n\pi} \int_0^2 g(x) \sin \frac{n\pi}{2} x dx \\ &= \frac{1}{\sinh n\pi} \left( \int_0^1 x \sin \frac{n\pi}{2} x dx + \int_1^2 (2-x) \sin \frac{n\pi}{2} x dx \right) \\ &= \frac{8 \sin \frac{n\pi}{2}}{n^2 \pi^2 \sinh n\pi}. \end{aligned}$$

Next, since  $A_n = 0$  in  $u_2$ , we have

$$u_2(x, y) = \sum_{n=1}^{\infty} B_n \sinh \frac{n\pi}{2} x \sin \frac{n\pi}{2} y$$

where

$$B_n = \frac{1}{\sinh n\pi} \int_0^b y(2-y) \sin \frac{n\pi}{2} y dy = \frac{16[1 - (-1)^n]}{n^3 \pi^3 \sinh n\pi}.$$

Thus

$$\begin{aligned} u(x, y) = u_1 + u_2 &= \frac{8}{\pi^2} \sum_{n=1}^{\infty} \frac{\sin \frac{n\pi}{2}}{n^2 \sinh n\pi} \sinh \frac{n\pi}{2} y \sin \frac{n\pi}{2} x \\ &\quad + \frac{16}{\pi^3} \sum_{n=1}^{\infty} \frac{[1 - (-1)^n]}{n^3 \sinh n\pi} \sinh \frac{n\pi}{2} x \sin \frac{n\pi}{2} y. \end{aligned}$$

17. (a)

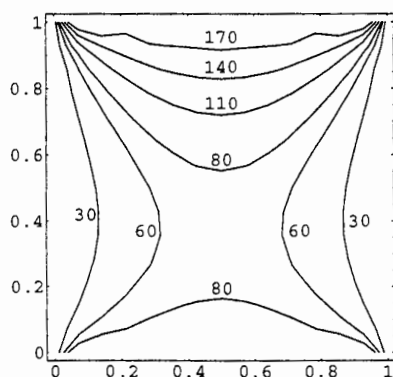

Exercises 12.5

(b)

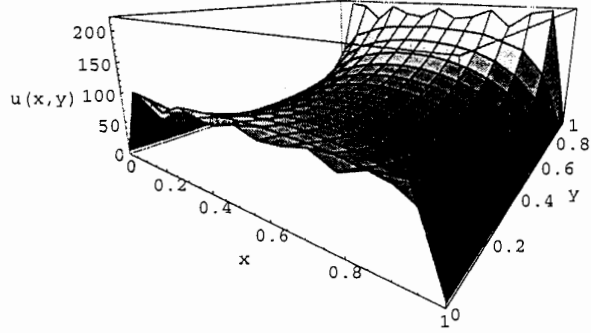

18.

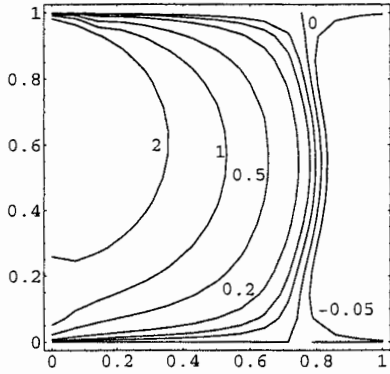

19. (a)

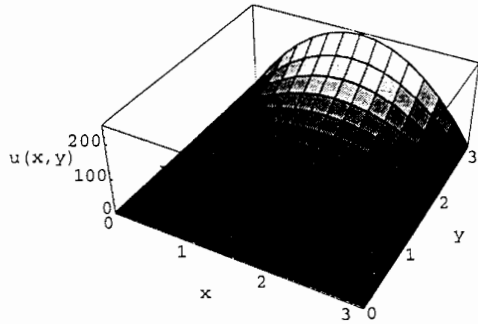

(b) The maximum value occurs at  $(\pi/2, \pi)$  and is  $f(\pi/2) = 25\pi^2$ .

(c) The coefficients are

$$A_n = \frac{2}{\pi} \operatorname{csch} n\pi \int_0^\pi 100x(\pi - x) \sin nx \, dx$$

$$= \frac{200 \operatorname{csch} n\pi}{\pi} \left[ \frac{200}{n^3} (1 - (-1)^n) \right] = \frac{400}{n^3\pi} [1 - (-1)^n] \operatorname{csch} n\pi.$$

20. From the figure showing the boundary conditions we see that the maximum value of the temperature is 1 at (1, 2) and (2, 1).

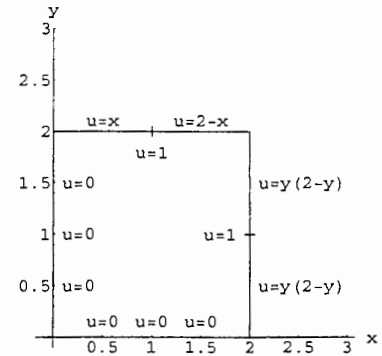

### Exercises 12.6

1. Using  $v(x, t) = u(x, t) - 100$  we wish to solve  $kv_{xx} = v_t$  subject to  $v(0, t) = 0$ ,  $v(1, t) = 0$ , and  $v(x, 0) = -100$ . Let  $v = XT$  and use  $-\lambda^2$  as a separation constant so that

$$X'' + \lambda^2 X = 0,$$

$$X(0) = 0,$$

$$X(1) = 0,$$

and

$$T' + \lambda^2 kT = 0.$$

Then

$$X = c_1 \sin n\pi x \quad \text{and} \quad T = c_2 e^{-kn^2\pi^2 t}$$

for  $n = 1, 2, 3, \dots$  so that

$$v = \sum_{n=1}^{\infty} A_n e^{-kn^2\pi^2 t} \sin n\pi x.$$

Imposing

$$v(x, 0) = -100 = \sum_{n=1}^{\infty} A_n \sin n\pi x$$

### Exercises 12.6

gives

$$A_n = 2 \int_0^1 (-100) \sin n\pi x \, dx = \frac{-200}{n\pi} [1 - (-1)^n]$$

so that

$$u(x, t) = v(x, t) + 100 = 100 + \frac{200}{\pi} \sum_{n=1}^{\infty} \frac{(-1)^n - 1}{n} e^{-kn^2\pi^2 t} \sin n\pi x.$$

2. Letting  $u(x, t) = v(x, t) + \psi(x)$  and proceeding as in Example 1 in the text we find  $\psi(x) = u_0 - u_0x$ . Then  $v(x, t) = u(x, t) + u_0x - u_0$  and we wish to solve  $kv_{xx} = v_t$  subject to  $v(0, t) = 0$ ,  $v(1, t) = 0$ , and  $v(x, 0) = f(x) + u_0x - u_0$ . Let  $v = XT$  and use  $-\lambda^2$  as a separation constant so that

$$X'' + \lambda^2 X = 0,$$

$$X(0) = 0,$$

$$X(1) = 0,$$

and

$$T' + \lambda^2 kT = 0.$$

Then

$$X = c_1 \sin n\pi x \quad \text{and} \quad T = c_2 e^{-kn^2\pi^2 t}$$

for  $n = 1, 2, 3, \dots$  so that

$$v = \sum_{n=1}^{\infty} A_n e^{-kn^2\pi^2 t} \sin n\pi x.$$

Imposing

$$v(x, 0) = f(x) + u_0x - u_0 = \sum_{n=1}^{\infty} A_n \sin n\pi x$$

gives

$$A_n = 2 \int_0^1 (f(x) + u_0x - u_0) \sin n\pi x \, dx$$

so that

$$u(x, t) = v(x, t) + u_0 - u_0x = u_0 - u_0x + \sum_{n=1}^{\infty} A_n e^{-kn^2\pi^2 t} \sin n\pi x.$$

3. If we let  $u(x, t) = v(x, t) + \psi(x)$ , then we obtain as in Example 1 in the text

$$k\psi'' + r = 0$$

or

$$\psi(x) = -\frac{r}{2k}x^2 + c_1x + c_2.$$

The boundary conditions become

$$u(0, t) = v(0, t) + \psi(0) = u_0$$

$$u(1, t) = v(1, t) + \psi(1) = u_0.$$

Letting  $\psi(0) = \psi(1) = u_0$  we obtain homogeneous boundary conditions in  $v$ :

$$v(0, t) = 0 \quad \text{and} \quad v(1, t) = 0.$$

Now  $\psi(0) = \psi(1) = u_0$  implies  $c_2 = u_0$  and  $c_1 = r/2k$ . Thus

$$\psi(x) = -\frac{r}{2k}x^2 + \frac{r}{2k}x + u_0 = u_0 - \frac{r}{2k}x(x-1).$$

To determine  $v(x, t)$  we solve

$$k \frac{\partial^2 v}{\partial x^2} = \frac{\partial v}{\partial t}, \quad 0 < x < 1, \quad t > 0$$

$$v(0, t) = 0, \quad v(1, t) = 0,$$

$$v(x, 0) = \frac{r}{2k}x(x-1) - u_0.$$

Separating variables, we find

$$v(x, t) = \sum_{n=1}^{\infty} A_n e^{-kn^2\pi^2 t} \sin n\pi x,$$

where

$$A_n = 2 \int_0^1 \left[ \frac{r}{2k}x(x-1) - u_0 \right] \sin n\pi x \, dx = 2 \left[ \frac{u_0}{n\pi} + \frac{r}{kn^3\pi^3} \right] [(-1)^n - 1]. \quad (1)$$

Hence, a solution of the original problem is

$$\begin{aligned} u(x, t) &= \psi(x) + v(x, t) \\ &= u_0 - \frac{r}{2k}x(x-1) + \sum_{n=1}^{\infty} A_n e^{-kn^2\pi^2 t} \sin n\pi x, \end{aligned}$$

where  $A_n$  is defined in (1).

4. If we let  $u(x, t) = v(x, t) + \psi(x)$ , then we obtain as in Example 1 in the text

$$k\psi'' + r = 0$$

or

$$\psi(x) = -\frac{r}{2k}x^2 + c_1x + c_2.$$

The boundary conditions become

$$u(0, t) = v(0, t) + \psi(0) = u_0$$

$$u(1, t) = v(1, t) + \psi(1) = u_1.$$

Letting  $\psi(0) = u_0$  and  $\psi(1) = u_1$  we obtain homogeneous boundary conditions in  $v$ :

$$v(0, t) = 0 \quad \text{and} \quad v(1, t) = 0.$$

### Exercises 12.6

Now  $\psi(0) = u_0$  and  $\psi(1) = u_1$  imply  $c_2 = u_0$  and  $c_1 = u_1 - u_0 + r/2k$ . Thus

$$\psi(x) = -\frac{r}{2k}x^2 + \left(u_1 - u_0 + \frac{r}{2k}\right)x + u_0.$$

To determine  $v(x, t)$  we solve

$$k \frac{\partial^2 v}{\partial x^2} = \frac{\partial v}{\partial t}, \quad 0 < x < 1, \quad t > 0$$

$$v(0, t) = 0, \quad v(1, t) = 0,$$

$$v(x, 0) = f(x) - \psi(x).$$

Separating variables, we find

$$v(x, t) = \sum_{n=1}^{\infty} A_n e^{-kn^2\pi^2 t} \sin n\pi x,$$

where

$$A_n = 2 \int_0^1 [f(x) - \psi(x)] \sin n\pi x \, dx. \quad (2)$$

Hence, a solution of the original problem is

$$\begin{aligned} u(x, t) &= \psi(x) + v(x, t) \\ &= -\frac{r}{2k}x^2 + \left(u_1 - u_0 + \frac{r}{2k}\right)x + u_0 + \sum_{n=1}^{\infty} A_n e^{-kn^2\pi^2 t} \sin n\pi x, \end{aligned}$$

where  $A_n$  is defined in (2).

5. Substituting  $u(x, t) = v(x, t) + \psi(x)$  into the partial differential equation gives

$$k \frac{\partial^2 v}{\partial x^2} + k\psi'' + Ae^{-\beta x} = \frac{\partial v}{\partial t}.$$

This equation will be homogeneous provided  $\psi$  satisfies

$$k\psi'' + Ae^{-\beta x} = 0.$$

The general solution of this differential equation is

$$\psi(x) = -\frac{A}{\beta^2 k} e^{-\beta x} + c_1 x + c_2.$$

From  $\psi(0) = 0$  and  $\psi(1) = 0$  we find

$$c_1 = \frac{A}{\beta^2 k} (e^{-\beta} - 1) \quad \text{and} \quad c_2 = \frac{A}{\beta^2 k}.$$

Hence

$$\begin{aligned} \psi(x) &= -\frac{A}{\beta^2 k} e^{-\beta x} + \frac{A}{\beta^2 k} (e^{-\beta} - 1)x + \frac{A}{\beta^2 k} \\ &= \frac{A}{\beta^2 k} [1 - e^{-\beta x} + (e^{-\beta} - 1)x]. \end{aligned}$$



Now the new problem is

$$\begin{aligned} k \frac{\partial^2 v}{\partial x^2} &= \frac{\partial v}{\partial t}, \quad 0 < x < 1, \quad t > 0, \\ v(0, t) &= 0, \quad v(1, t) = 0, \quad t > 0, \\ v(x, 0) &= f(x) - \psi(x), \quad 0 < x < 1. \end{aligned}$$

Identifying this as the heat equation solved in Section 12.3 in the text with  $L = 1$  we obtain

$$v(x, t) = \sum_{n=1}^{\infty} A_n e^{-kn^2\pi^2 t} \sin n\pi x$$

where

$$A_n = 2 \int_0^1 [f(x) - \psi(x)] \sin n\pi x \, dx.$$

Thus

$$u(x, t) = \frac{A}{\beta^2 k} [1 - e^{-\beta x} + (e^{-\beta} - 1)x] + \sum_{n=1}^{\infty} A_n e^{-kn^2\pi^2 t} \sin n\pi x.$$

6. Substituting  $u(x, t) = v(x, t) + \psi(x)$  into the partial differential equation gives

$$k \frac{\partial^2 v}{\partial x^2} + k\psi'' - hv - h\psi = \frac{\partial v}{\partial t}.$$

This equation will be homogeneous provided  $\psi$  satisfies

$$k\psi'' - h\psi = 0.$$

Since  $k$  and  $h$  are positive, the general solution of this latter equation is

$$\psi(x) = c_1 \cosh \sqrt{\frac{h}{k}} x + c_2 \sinh \sqrt{\frac{h}{k}} x.$$

From  $\psi(0) = 0$  and  $\psi(\pi) = u_0$  we find  $c_1 = 0$  and  $c_2 = u_0 / \sinh \sqrt{h/k} \pi$ . Hence

$$\psi(x) = u_0 \frac{\sinh \sqrt{h/k} x}{\sinh \sqrt{h/k} \pi}.$$

Now the new problem is

$$\begin{aligned} k \frac{\partial^2 v}{\partial x^2} - hv &= \frac{\partial v}{\partial t}, \quad 0 < x < \pi, \quad t > 0 \\ v(0, t) &= 0, \quad v(\pi, t) = 0, \quad t > 0 \\ v(x, 0) &= -\psi(x), \quad 0 < x < \pi. \end{aligned}$$

If we let  $v = XT$  then

$$\frac{X''}{X} = \frac{T' + hT}{kT} = -\lambda^2$$

### Exercises 12.6

gives the separated differential equations

$$X'' + \lambda^2 X = 0 \quad \text{and} \quad T' + (h + k\lambda^2)T = 0.$$

The respective solutions are

$$\begin{aligned} X(x) &= c_3 \cos \lambda x + c_4 \sin \lambda x \\ T(t) &= c_5 e^{-(h+k\lambda^2)t}. \end{aligned}$$

From  $X(0) = 0$  we get  $c_3 = 0$  and from  $X(\pi) = 0$  we find  $\lambda = n$  for  $n = 1, 2, 3, \dots$ . Consequently, it follows that

$$v(x, t) = \sum_{n=1}^{\infty} A_n e^{-(h+kn^2)t} \sin nx$$

where

$$A_n = -\frac{2}{\pi} \int_0^{\pi} \psi(x) \sin nx \, dx.$$

Hence a solution of the original problem is

$$u(x, t) = u_0 \frac{\sinh \sqrt{h/k} x}{\sinh \sqrt{h/k} \pi} + e^{-ht} \sum_{n=1}^{\infty} A_n e^{-kn^2 t} \sin nx$$

where

$$A_n = -\frac{2}{\pi} \int_0^{\pi} u_0 \frac{\sinh \sqrt{h/k} x}{\sinh \sqrt{h/k} \pi} \sin nx \, dx.$$

Using the exponential definition of the hyperbolic sine and integration by parts we find

$$A_n = \frac{2u_0 nk(-1)^n}{\pi(h + kn^2)}.$$

7. Substituting  $u(x, t) = v(x, t) + \psi(x)$  into the partial differential equation gives

$$k \frac{\partial^2 v}{\partial x^2} + k\psi'' - hv - h\psi + hu_0 = \frac{\partial v}{\partial t}.$$

This equation will be homogeneous provided  $\psi$  satisfies

$$k\psi'' - h\psi + hu_0 = 0 \quad \text{or} \quad k\psi'' - h\psi = -hu_0.$$

This second-order, linear, non-homogeneous differential equation has solution

$$\psi(x) = c_1 \cosh \sqrt{\frac{h}{k}} x + c_2 \sinh \sqrt{\frac{h}{k}} x + u_0,$$

where we assume  $h > 0$  and  $k > 0$ . From  $\psi(0) = u_0$  and  $\psi(1) = 0$  we find  $c_1 = 0$  and  $c_2 = -u_0 / \sinh \sqrt{h/k}$ . Thus, the steady-state solution is

$$\psi(x) = -\frac{u_0}{\sinh \sqrt{\frac{h}{k}}} \sinh \sqrt{\frac{h}{k}} x + u_0 = u_0 \left( 1 - \frac{\sinh \sqrt{\frac{h}{k}} x}{\sinh \sqrt{\frac{h}{k}}} \right).$$

8. The partial differential equation is

$$k \frac{\partial^2 u}{\partial x^2} - hu = \frac{\partial u}{\partial t}.$$

Substituting  $u(x, t) = v(x, t) + \psi(x)$  gives

$$k \frac{\partial^2 v}{\partial x^2} + k\psi'' - hv - h\psi = \frac{\partial v}{\partial t}.$$

This equation will be homogeneous provided  $\psi$  satisfies

$$k\psi'' - h\psi = 0.$$

Assuming  $h > 0$  and  $k > 0$ , we have

$$\psi = c_1 e^{\sqrt{h/k}x} + c_2 e^{-\sqrt{h/k}x},$$

where we have used the exponential form of the solution since the rod is infinite. Now, in order that the steady-state temperature  $\psi(x)$  be bounded as  $x \rightarrow \infty$ , we require  $c_1 = 0$ . Then

$$\psi(x) = c_2 e^{-\sqrt{h/k}x}$$

and  $\psi(0) = u_0$  implies  $c_2 = u_0$ . Thus

$$\psi(x) = u_0 e^{-\sqrt{h/k}x}.$$

9. Substituting  $u(x, t) = v(x, t) + \psi(x)$  into the partial differential equation gives

$$a^2 \frac{\partial^2 v}{\partial x^2} + a^2 \psi'' + Ax = \frac{\partial^2 v}{\partial t^2}.$$

This equation will be homogeneous provided  $\psi$  satisfies

$$a^2 \psi'' + Ax = 0.$$

The general solution of this differential equation is

$$\psi(x) = -\frac{A}{6a^2}x^3 + c_1x + c_2.$$

From  $\psi(0) = 0$  we obtain  $c_2 = 0$ , and from  $\psi(1) = 0$  we obtain  $c_1 = A/6a^2$ . Hence

$$\psi(x) = \frac{A}{6a^2}(x - x^3).$$

Now the new problem is

$$a^2 \frac{\partial^2 v}{\partial x^2} = \frac{\partial^2 v}{\partial t^2}$$

$$v(0, t) = 0, \quad v(1, t) = 0, \quad t > 0,$$

$$v(x, 0) = -\psi(x), \quad v_t(x, 0) = 0, \quad 0 < x < 1.$$

### Exercises 12.6

Identifying this as the wave equation solved in Section 12.4 in the text with  $L = 1$ ,  $f(x) = -\psi(x)$ , and  $g(x) = 0$  we obtain

$$v(x, t) = \sum_{n=1}^{\infty} A_n \cos n\pi at \sin n\pi x$$

where

$$A_n = 2 \int_0^1 [-\psi(x)] \sin n\pi x \, dx = \frac{A}{3a^2} \int_0^1 (x^3 - x) \sin n\pi x \, dx = \frac{2A(-1)^n}{a^2\pi^3 n^3}.$$

Thus

$$u(x, t) = \frac{A}{6a^2}(x - x^3) + \frac{2A}{a^2\pi^3} \sum_{n=1}^{\infty} \frac{(-1)^n}{n^3} \cos n\pi at \sin n\pi x.$$

10. We solve

$$a^2 \frac{\partial^2 u}{\partial x^2} - g = \frac{\partial^2 u}{\partial t^2}, \quad 0 < x < 1, \quad t > 0$$

$$u(0, t) = 0, \quad u(1, t) = 0, \quad t > 0$$

$$u(x, 0) = 0, \quad \left. \frac{\partial u}{\partial t} \right|_{t=0} = 0, \quad 0 < x < 1.$$

The partial differential equation is nonhomogeneous. The substitution  $u(x, t) = v(x, t) + \psi(x)$  yields a homogeneous partial differential equation provided  $\psi$  satisfies

$$a^2 \psi'' - g = 0.$$

By integrating twice we find

$$\psi(x) = \frac{g}{2a^2} x^2 + c_1 x + c_2.$$

The imposed conditions  $\psi(0) = 0$  and  $\psi(1) = 0$  then lead to  $c_2 = 0$  and  $c_1 = -g/2a^2$ . Hence

$$\psi(x) = \frac{g}{2a^2} (x^2 - x).$$

The new problem is now

$$a^2 \frac{\partial^2 v}{\partial x^2} = \frac{\partial^2 v}{\partial t^2}, \quad 0 < x < 1, \quad t > 0$$

$$v(0, t) = 0, \quad v(1, t) = 0$$

$$v(x, 0) = \frac{g}{2a^2} (x - x^2), \quad \left. \frac{\partial v}{\partial t} \right|_{t=0} = 0.$$

Substituting  $v = XT$  we find in the usual manner

$$X'' + \lambda^2 X = 0$$

$$T'' + a^2 \lambda^2 T = 0$$

with solutions

$$X(x) = c_3 \cos \lambda x + c_4 \sin \lambda x$$

$$T(t) = c_5 \cos a\lambda t + c_6 \sin a\lambda t.$$

The conditions  $X(0) = 0$  and  $X(1) = 0$  imply in turn that  $c_3 = 0$  and  $\lambda = n\pi$  for  $n = 1, 2, 3, \dots$ . The condition  $T'(0) = 0$  implies  $c_6 = 0$ . Hence, by the superposition principle

$$v(x, t) = \sum_{n=1}^{\infty} A_n \cos(an\pi t) \sin(n\pi x).$$

At  $t = 0$ ,

$$\frac{g}{2a^2} (x - x^2) = \sum_{n=1}^{\infty} A_n \sin n\pi x$$

and so

$$A_n = \frac{g}{a^2} \int_0^1 (x - x^2) \sin n\pi x \, dx = \frac{2g}{a^2 n^3 \pi^3} [1 - (-1)^n].$$

Thus the solution to the original problem is

$$u(x, t) = \psi(x) + v(x, t) = \frac{g}{2a^2} (x^2 - x) + \frac{2g}{a^2 \pi^3} \sum_{n=1}^{\infty} \frac{1 - (-1)^n}{n^3} \cos(an\pi t) \sin(n\pi x).$$

11. Substituting  $u(x, y) = v(x, y) + \psi(y)$  into Laplace's equation we obtain

$$\frac{\partial^2 v}{\partial x^2} + \frac{\partial^2 v}{\partial y^2} + \psi''(y) = 0.$$

This equation will be homogeneous provided  $\psi$  satisfies  $\psi(y) = c_1 y + c_2$ . Considering

$$u(x, 0) = v(x, 0) + \psi(0) = u_1$$

$$u(x, 1) = v(x, 1) + \psi(1) = u_0$$

$$u(0, y) = v(0, y) + \psi(y) = 0$$

we require that  $\psi(0) = u_1$ ,  $\psi(1) = u_0$  and  $v(0, y) = -\psi(y)$ . Then  $c_1 = u_0 - u_1$  and  $c_2 = u_1$ . The new boundary-value problem is

$$\frac{\partial^2 v}{\partial x^2} + \frac{\partial^2 v}{\partial y^2} = 0$$

$$v(x, 0) = 0, \quad v(x, 1) = 0,$$

$$v(0, y) = -\psi(y), \quad 0 < y < 1,$$

where  $v(x, y)$  is bounded at  $x \rightarrow \infty$ . This problem is similar to Problem 11 in Section 12.5. The

### Exercises 12.6

solution is

$$\begin{aligned} v(x, y) &= \sum_{n=1}^{\infty} \left( 2 \int_0^1 [-\psi(y) \sin n\pi y] dy \right) e^{-n\pi x} \sin n\pi y \\ &= 2 \sum_{n=1}^{\infty} \left[ (u_1 - u_0) \int_0^1 y \sin n\pi y dy - u_1 \int_0^1 \sin n\pi y dy \right] e^{-n\pi x} \sin n\pi y \\ &= \frac{2}{\pi} \sum_{n=1}^{\infty} \frac{u_0(-1)^n - u_1}{n} e^{-n\pi x} \sin n\pi y. \end{aligned}$$

Thus

$$\begin{aligned} u(x, y) &= v(x, y) + \psi(y) \\ &= (u_0 - u_1)y + u_1 + \frac{2}{\pi} \sum_{n=1}^{\infty} \frac{u_0(-1)^n - u_1}{n} e^{-n\pi x} \sin n\pi y. \end{aligned}$$

12. Substituting  $u(x, y) = v(x, y) + \psi(x)$  into Poisson's equation we obtain

$$\frac{\partial^2 v}{\partial x^2} + \psi''(x) + h + \frac{\partial^2 v}{\partial y^2} = 0.$$

The equation will be homogeneous provided  $\psi$  satisfies  $\psi''(x) + h = 0$  or  $\psi(x) = -\frac{h}{2}x^2 + c_1x + c_2$ . From  $\psi(0) = 0$  we obtain  $c_2 = 0$ . From  $\psi(\pi) = 1$  we obtain

$$c_1 = \frac{1}{\pi} + \frac{h\pi}{2}.$$

Then

$$\psi(x) = \left( \frac{1}{\pi} + \frac{h\pi}{2} \right) x - \frac{h}{2}x^2.$$

The new boundary-value problem is

$$\begin{aligned} \frac{\partial^2 v}{\partial x^2} + \frac{\partial^2 v}{\partial y^2} &= 0 \\ v(0, y) &= 0, \quad v(\pi, y) = 0, \\ v(x, 0) &= -\psi(x), \quad 0 < x < \pi. \end{aligned}$$

This is Problem 11 in Section 12.5. The solution is

$$v(x, y) = \sum_{n=1}^{\infty} A_n e^{-ny} \sin nx$$

where

$$\begin{aligned} A_n &= \frac{2}{\pi} \int_0^{\pi} [-\psi(x) \sin nx] dx \\ &= \frac{2(-1)^n}{n} \left( \frac{1}{\pi} + \frac{h\pi}{2} \right) - h(-1)^n \left( \frac{\pi}{n} + \frac{2}{n^2} \right). \end{aligned}$$

Thus

$$u(x, y) = v(x, y) + \psi(x) = \left(\frac{1}{\pi} + \frac{h\pi}{2}\right)x - \frac{h}{2}x^2 + \sum_{n=1}^{\infty} A_n e^{-ny} \sin nx.$$

## Exercises 12.7

1. Referring to Example 1 in the text we have

$$X(x) = c_1 \cos \lambda x + c_2 \sin \lambda x$$

and

$$T(t) = c_3 e^{-k\lambda^2 t}.$$

From  $X'(0) = 0$  (since the left end of the rod is insulated), we find  $c_2 = 0$ . Then  $X(x) = c_1 \cos \lambda x$  and the other boundary condition  $X'(1) = -hX(1)$  implies

$$-\lambda \sin \lambda + h \cos \lambda = 0 \quad \text{or} \quad \cot \lambda = \frac{\lambda}{h}.$$

Denoting the consecutive positive roots of this latter equation by  $\lambda_n$  for  $n = 1, 2, 3, \dots$ , we have

$$u(x, t) = \sum_{n=1}^{\infty} A_n e^{-k\lambda_n^2 t} \cos \lambda_n x.$$

From the initial condition  $u(x, 0) = 1$  we obtain

$$1 = \sum_{n=1}^{\infty} A_n \cos \lambda_n x$$

and

$$\begin{aligned} A_n &= \frac{\int_0^1 \cos \lambda_n x \, dx}{\int_0^1 \cos^2 \lambda_n x \, dx} = \frac{\sin \lambda_n / \lambda_n}{\frac{1}{2} \left[1 + \frac{1}{2\lambda_n} \sin 2\lambda_n\right]} \\ &= \frac{2 \sin \lambda_n}{\lambda_n \left[1 + \frac{1}{\lambda_n} \sin \lambda_n \cos \lambda_n\right]} = \frac{2 \sin \lambda_n}{\lambda_n \left[1 + \frac{1}{h\lambda_n} \sin \lambda_n (\lambda_n \sin \lambda_n)\right]} \\ &= \frac{2h \sin \lambda_n}{\lambda_n [h + \sin^2 \lambda_n]}. \end{aligned}$$

The solution is

$$u(x, t) = 2h \sum_{n=1}^{\infty} \frac{\sin \lambda_n}{\lambda_n (h + \sin^2 \lambda_n)} e^{-k\lambda_n^2 t} \cos \lambda_n x.$$

2. Substituting  $u(x, t) = v(x, t) + \psi(x)$  into the partial differential equation gives

$$k \frac{\partial^2 v}{\partial x^2} + k\psi'' = \frac{\partial v}{\partial t}.$$

### Exercises 12.7

This equation will be homogeneous if  $\psi''(x) = 0$  or  $\psi(x) = c_1x + c_2$ . The boundary condition  $u(0, t) = 0$  implies  $\psi(0) = 0$  which implies  $c_2 = 0$ . Thus  $\psi(x) = c_1x$ . Using the second boundary condition we obtain

$$-\left(\frac{\partial v}{\partial x} + \psi'\right)\Big|_{x=1} = -h[v(1, t) + \psi(1) - u_0],$$

which will be homogeneous when

$$-\psi'(1) = -h\psi(1) + hu_0.$$

Since  $\psi(1) = \psi'(1) = c_1$  we have  $-c_1 = -hc_1 + hu_0$  and  $c_1 = hu_0/(h - 1)$ . Thus

$$\psi(x) = \frac{hu_0}{h - 1}x.$$

The new boundary-value problem is

$$\begin{aligned} k \frac{\partial^2 v}{\partial x^2} &= \frac{\partial v}{\partial t}, & 0 < x < 1, & \quad t > 0 \\ v(0, t) &= 0, & \frac{\partial v}{\partial x}\Big|_{x=1} &= -hv(1, t), & \quad h > 0, \quad t > 0 \\ v(x, 0) &= f(x) - \frac{hu_0}{h - 1}x, & 0 < x < 1. \end{aligned}$$

Referring to Example 1 in the text we see that

$$v(x, t) = \sum_{n=1}^{\infty} A_n e^{-k\lambda_n^2 t} \sin \lambda_n x$$

and

$$u(x, t) = v(x, t) + \psi(x) = \frac{hu_0}{h - 1}x + \sum_{n=1}^{\infty} A_n e^{-k\lambda_n^2 t} \sin \lambda_n x$$

where

$$f(x) - \frac{hu_0}{h - 1}x = \sum_{n=1}^{\infty} A_n \sin \lambda_n x$$



and  $\lambda_n$  is a solution of  $\lambda_n \cos \lambda_n = -h \sin \lambda_n$ . The coefficients are

$$\begin{aligned} A_n &= \frac{\int_0^1 [f(x) - hu_0x/(h-1)] \sin \lambda_n x \, dx}{\int_0^1 \sin^2 \lambda_n x \, dx} \\ &= \frac{\int_0^1 [f(x) - hu_0x/(h-1)] \sin \lambda_n x \, dx}{\frac{1}{2} \left[ 1 - \frac{1}{2\lambda_n} \sin 2\lambda_n \right]} \\ &= \frac{2 \int_0^1 [f(x) - hu_0x/(h-1)] \sin \lambda_n x \, dx}{1 - \frac{1}{\lambda_n} \sin \lambda_n \cos \lambda_n} \\ &= \frac{2 \int_0^1 [f(x) - hu_0x/(h-1)] \sin \lambda_n x \, dx}{1 - \frac{1}{h\lambda_n} (h \sin \lambda_n) \cos \lambda_n} \\ &= \frac{2 \int_0^1 [f(x) - hu_0x/(h-1)] \sin \lambda_n x \, dx}{1 - \frac{1}{h\lambda_n} (-\lambda_n \cos \lambda_n) \cos \lambda_n} \\ &= \frac{2h}{h + \cos^2 \lambda_n} \int_0^1 \left[ f(x) - \frac{hu_0}{h-1} x \right] \sin \lambda_n x \, dx. \end{aligned}$$

3. Separating variables in Laplace's equation gives

$$X'' + \lambda^2 X = 0$$

$$Y'' - \lambda^2 Y = 0$$

and

$$X(x) = c_1 \cos \lambda x + c_2 \sin \lambda x$$

$$Y(y) = c_3 \cosh \lambda y + c_4 \sinh \lambda y.$$

From  $u(0, y) = 0$  we obtain  $X(0) = 0$  and  $c_1 = 0$ . From  $u_x(a, y) = -hu(a, y)$  we obtain  $X'(a) = -hX(a)$  and

$$\lambda \cos \lambda a = -h \sin \lambda a \quad \text{or} \quad \tan \lambda a = -\frac{\lambda}{h}.$$

Let  $\lambda_n$ , where  $n = 1, 2, 3, \dots$ , be the consecutive positive roots of this equation. From  $u(x, 0) = 0$  we obtain  $Y(0) = 0$  and  $c_3 = 0$ . Thus

$$u(x, y) = \sum_{n=1}^{\infty} A_n \sinh \lambda_n y \sin \lambda_n x.$$

Now

$$f(x) = \sum_{n=1}^{\infty} A_n \sinh \lambda_n b \sin \lambda_n x$$

and

$$A_n \sinh \lambda_n b = \frac{\int_0^a f(x) \sin \lambda_n x \, dx}{\int_0^a \sin^2 \lambda_n x \, dx}.$$

### Exercises 12.7

Since

$$\begin{aligned}\int_0^a \sin^2 \lambda_n x \, dx &= \frac{1}{2} \left[ a - \frac{1}{2\lambda_n} \sin 2\lambda_n a \right] = \frac{1}{2} \left[ a - \frac{1}{\lambda_n} \sin \lambda_n a \cos \lambda_n a \right] \\ &= \frac{1}{2} \left[ a - \frac{1}{h\lambda_n} (h \sin \lambda_n a) \cos \lambda_n a \right] \\ &= \frac{1}{2} \left[ a - \frac{1}{h\lambda_n} (-\lambda_n \cos \lambda_n a) \cos \lambda_n a \right] = \frac{1}{2h} [ah + \cos^2 \lambda_n a],\end{aligned}$$

we have

$$A_n = \frac{2h}{\sinh \lambda_n b [ah + \cos^2 \lambda_n a]} \int_0^a f(x) \sin \lambda_n x \, dx.$$

4. Letting  $u(x, y) = X(x)Y(y)$  and separating variables gives

$$X''Y + XY'' = 0.$$

The boundary conditions

$$\left. \frac{\partial u}{\partial y} \right|_{y=0} = 0 \quad \text{and} \quad \left. \frac{\partial u}{\partial y} \right|_{y=1} = -hu(x, 1)$$

correspond to

$$X(x)Y'(0) = 0 \quad \text{and} \quad X(x)Y'(1) = -hX(x)Y(1)$$

or

$$Y'(0) = 0 \quad \text{and} \quad Y'(1) = -hY(1).$$

Since these homogeneous boundary conditions are in terms of  $Y$ , we separate the differential equation as

$$\frac{X''}{X} = -\frac{Y''}{Y} = \lambda^2.$$

Then

$$Y'' + \lambda^2 Y = 0$$

and

$$X'' - \lambda^2 X = 0$$

have solutions

$$Y(y) = c_1 \cos \lambda y + c_2 \sin \lambda y$$

and

$$X(x) = c_3 e^{-\lambda x} + c_4 e^{\lambda x}.$$

We use exponential functions in the solution of  $X(x)$  since  $\cosh \lambda x$  and  $\sinh \lambda x$  are both unbounded as  $x \rightarrow \infty$ . Now,  $Y'(0) = 0$  implies  $c_2 = 0$ , so  $Y(y) = c_1 \cos \lambda y$ . Since  $Y'(y) = -c_1 \lambda \sin \lambda y$ , the boundary condition  $Y'(1) = -hY(1)$  implies

$$-c_1 \lambda \sin \lambda = -hc_1 \cos \lambda \quad \text{or} \quad \cot \lambda = \frac{\lambda}{h}.$$

Consideration of the graphs of  $f(\lambda) = \cot \lambda$  and  $g(\lambda) = \lambda/h$  show that  $\cos \lambda = \lambda h$  has an infinite number of roots. The consecutive positive roots  $\lambda_n$  for  $n = 1, 2, 3, \dots$ , are the eigenvalues of the problem. The corresponding eigenfunctions are  $Y_n(y) = c_1 \cos \lambda_n y$ . The condition  $\lim_{x \rightarrow \infty} u(x, y) = 0$  is equivalent to  $\lim_{x \rightarrow \infty} X(x) = 0$ . Thus  $c_4 = 0$  and  $X(x) = c_3 e^{-\lambda x}$ . Therefore

$$u_n(x, y) = X_n(x)Y_n(x) = A_n e^{-\lambda_n x} \cos \lambda_n y$$

and by the superposition principle

$$u(x, y) = \sum_{n=1}^{\infty} A_n e^{-\lambda_n x} \cos \lambda_n y.$$

[It is easily shown that there are no eigenvalues corresponding to  $\lambda = 0$ .] Finally, the condition  $u(0, y) = u_0$  implies

$$u_0 = \sum_{n=1}^{\infty} A_n \cos \lambda_n y.$$

This is not a Fourier cosine series since the coefficients  $\lambda_n$  of  $y$  are not integer multiples of  $\pi/p$ , where  $p = 1$  in this problem. The functions  $\cos \lambda_n y$  are however orthogonal since they are eigenfunctions of the Sturm-Lionville problem

$$Y'' + \lambda^2 Y = 0,$$

$$Y'(0) = 0$$

$$Y'(1) + hY(1) = 0,$$

with weight function  $p(x) = 1$ . Thus we find

$$A_n = \frac{\int_0^1 u_0 \cos \lambda_n y \, dy}{\int_0^1 \cos^2 \lambda_n y \, dy}.$$

Now

$$\int_0^1 u_0 \cos \lambda_n y \, dy = \frac{u_0}{\lambda_n} \sin \lambda_n y \Big|_0^1 = \frac{u_0}{\lambda_n} \sin \lambda_n$$

and

$$\begin{aligned} \int_0^1 \cos^2 \lambda_n y \, dy &= \frac{1}{2} \int_0^1 (1 + \cos 2\lambda_n y) \, dy = \frac{1}{2} \left[ y + \frac{1}{2\lambda_n} \sin 2\lambda_n y \right]_0^1 \\ &= \frac{1}{2} \left[ 1 + \frac{1}{2\lambda_n} \sin 2\lambda_n \right] = \frac{1}{2} \left[ 1 + \frac{1}{\lambda_n} \sin \lambda_n \cos \lambda_n \right]. \end{aligned}$$

Since  $\cot \lambda = \lambda/h$ ,

$$\frac{\cos \lambda}{\lambda} = \frac{\sin \lambda}{h}$$

and

$$\int_0^1 \cos^2 \lambda_n y \, dy = \frac{1}{2} \left[ 1 + \frac{\sin^2 \lambda_n}{h} \right].$$

### Exercises 12.7

Then

$$A_n = \frac{\frac{u_0}{\lambda_n} \sin \lambda_n}{\frac{1}{2} \left[ 1 + \frac{1}{h} \sin^2 \lambda_n \right]} = \frac{2hu_0 \sin \lambda_n}{\lambda_n (h + \sin^2 \lambda_n)}$$

and

$$u(x, y) = 2hu_0 \sum_{n=1}^{\infty} \frac{\sin \lambda_n}{\lambda_n (1 + \sin^2 \lambda_n)} e^{-\lambda_n x} \cos \lambda_n y$$

where  $\lambda_n$  for  $n = 1, 2, 3, \dots$  are the consecutive positive roots of  $\cot \lambda = \lambda/h$ .

5. The boundary-value problem is

$$k \frac{\partial^2 u}{\partial x^2} = \frac{\partial u}{\partial t}, \quad 0 < x < L, \quad t > 0,$$

$$u(0, t) = 0, \quad \left. \frac{\partial u}{\partial x} \right|_{x=L} = 0, \quad t > 0,$$

$$u(x, 0) = f(x), \quad 0 < x < L.$$

Separation of variables leads to

$$X'' + \lambda^2 X = 0$$

$$T' + k\lambda^2 T = 0$$

and

$$X(x) = c_1 \cos \lambda x + c_2 \sin \lambda x$$

$$T(t) = c_3 e^{-k\lambda^2 t}.$$

From  $X(0) = 0$  we find  $c_1 = 0$ . From  $X'(L) = 0$  we obtain  $\cos \lambda L = 0$  and

$$\lambda = \frac{\pi(2n-1)}{2L}, \quad n = 1, 2, 3, \dots$$

Thus

$$u(x, t) = \sum_{n=1}^{\infty} A_n e^{-k(2n-1)^2 \pi^2 t / 4L^2} \sin \left( \frac{2n-1}{2L} \right) \pi x$$

where

$$A_n = \frac{\int_0^L f(x) \sin \left( \frac{2n-1}{2L} \right) \pi x \, dx}{\int_0^L \sin^2 \left( \frac{2n-1}{2L} \right) \pi x \, dx} = \frac{2}{L} \int_0^L f(x) \sin \left( \frac{2n-1}{2L} \right) \pi x \, dx.$$

6. Substituting  $u(x, t) = v(x, t) + \psi(x)$  into the partial differential equation gives

$$a^2 \frac{\partial^2 v}{\partial x^2} + \psi''(x) = \frac{\partial^2 v}{\partial t^2}.$$

This equation will be homogeneous if  $\psi''(x) = 0$  or  $\psi(x) = c_1 x + c_2$ . The boundary condition  $u(0, t) = 0$  implies  $\psi(0) = 0$  which implies  $c_2 = 0$ . Thus  $\psi(x) = c_1 x$ . Using the second boundary

condition, we obtain

$$E \left( \frac{\partial v}{\partial x} + \psi' \right) \Big|_{x=L} = F_0,$$

which will be homogeneous when

$$E\psi'(L) = F_0.$$

Since  $\psi'(x) = c_1$  we conclude that  $c_1 = F_0/E$  and

$$\psi(x) = \frac{F_0}{E}x.$$

The new boundary-value problem is

$$a^2 \frac{\partial^2 v}{\partial x^2} = \frac{\partial^2 v}{\partial t^2}, \quad 0 < x < L, \quad t > 0$$

$$v(0, t) = 0, \quad \frac{\partial v}{\partial x} \Big|_{x=L} = 0, \quad t > 0,$$

$$v(x, 0) = -\frac{F_0}{E}x, \quad \frac{\partial v}{\partial t} \Big|_{t=0} = 0, \quad 0 < x < L.$$

Referring to Example 2 in the text we see that

$$v(x, t) = \sum_{n=1}^{\infty} A_n \cos a \left( \frac{2n-1}{2L} \right) \pi t \sin \left( \frac{2n-1}{2L} \right) \pi x$$

where

$$-\frac{F_0}{E}x = \sum_{n=1}^{\infty} A_n \sin \left( \frac{2n-1}{2L} \right) \pi x$$

and

$$A_n = \frac{-F_0 \int_0^L x \sin \left( \frac{2n-1}{2L} \right) \pi x \, dx}{E \int_0^L \sin^2 \left( \frac{2n-1}{2L} \right) \pi x \, dx} = \frac{8F_0L(-1)^n}{E\pi^2(2n-1)^2}.$$

Thus

$$\begin{aligned} u(x, t) &= v(x, t) + \psi(x) \\ &= \frac{F_0}{E}x + \frac{8F_0L}{E\pi^2} \sum_{n=1}^{\infty} \frac{(-1)^n}{(2n-1)^2} \cos a \left( \frac{2n-1}{2L} \right) \pi t \sin \left( \frac{2n-1}{2L} \right) \pi x. \end{aligned}$$

7. Separation of variables leads to

$$Y'' + \lambda^2 Y = 0$$

$$X'' - \lambda^2 X = 0$$

and

$$Y(y) = c_1 \cos \lambda y + c_2 \sin \lambda y$$

$$X(x) = c_3 \cosh \lambda x + c_4 \sinh \lambda x.$$

### Exercises 12.7

From  $Y(0) = 0$  we find  $c_1 = 0$ . From  $Y'(1) = 0$  we obtain  $\cos \lambda = 0$  and

$$\lambda = \frac{\pi(2n-1)}{2}, \quad n = 1, 2, 3, \dots$$

Thus

$$Y(y) = c_2 \sin\left(\frac{2n-1}{2}\pi y\right)$$

From  $X'(0) = 0$  we find  $c_4 = 0$ . Then

$$u(x, y) = \sum_{n=1}^{\infty} A_n \cosh\left(\frac{2n-1}{2}\pi x\right) \sin\left(\frac{2n-1}{2}\pi y\right)$$

where

$$u_0 = u(1, y) = \sum_{n=1}^{\infty} A_n \cosh\left(\frac{2n-1}{2}\pi\right) \sin\left(\frac{2n-1}{2}\pi y\right)$$

and

$$A_n \cosh\left(\frac{2n-1}{2}\pi\right) \pi = \frac{\int_0^1 u_0 \sin\left(\frac{2n-1}{2}\pi y\right) \pi y \, dy}{\int_0^1 \sin^2\left(\frac{2n-1}{2}\pi y\right) \pi y \, dy} = \frac{4u_0}{(2n-1)\pi}$$

Thus

$$u(x, y) = \frac{4u_0}{\pi} \sum_{n=1}^{\infty} \frac{1}{(2n-1) \cosh\left(\frac{2n-1}{2}\pi\right)} \cosh\left(\frac{2n-1}{2}\pi x\right) \sin\left(\frac{2n-1}{2}\pi y\right)$$

8. The boundary-value problem is

$$\begin{aligned} k \frac{\partial^2 u}{\partial x^2} &= \frac{\partial u}{\partial t}, \quad 0 < x < 1, \quad t > 0 \\ \frac{\partial u}{\partial x} \Big|_{x=0} &= hu(0, t), \quad \frac{\partial u}{\partial x} \Big|_{x=1} = -hu(1, t), \quad h > 0, \quad t > 0, \\ u(x, 0) &= f(x), \quad 0 < x < 1. \end{aligned}$$

Referring to Example 1 in the text we have

$$X(x) = c_1 \cos \lambda x + c_2 \sin \lambda x$$

and

$$T(t) = c_3 e^{-k\lambda^2 t}$$

Applying the boundary conditions, we obtain

$$X'(0) = hX(0)$$

$$X'(1) = -hX(1)$$

or

$$\lambda c_2 = hc_1$$

$$-\lambda c_1 \sin \lambda + \lambda c_2 \cos \lambda = -hc_1 \cos \lambda - hc_2 \sin \lambda.$$

Choosing  $c_1 = \lambda$  and  $c_2 = h$  (to satisfy the first equation above) we obtain

$$\begin{aligned} -\lambda^2 \sin \lambda + h\lambda \cos \lambda &= -h\lambda \cos \lambda - h^2 \sin \lambda \\ 2h\lambda \cos \lambda &= (\lambda^2 - h^2) \sin \lambda. \end{aligned}$$

The eigenvalues  $\lambda_n$  are the consecutive positive roots of

$$\tan \lambda = \frac{2h\lambda}{\lambda^2 - h^2}.$$

Then

$$u(x, t) = \sum_{n=1}^{\infty} A_n e^{-k\lambda_n^2 t} (\lambda_n \cos \lambda_n x + h \sin \lambda_n x)$$

where

$$f(x) = u(x, 0) = \sum_{n=1}^{\infty} A_n (\lambda_n \cos \lambda_n x + h \sin \lambda_n x)$$

and

$$\begin{aligned} A_n &= \frac{\int_0^1 f(x) (\lambda_n \cos \lambda_n x + h \sin \lambda_n x) dx}{\int_0^1 (\lambda_n \cos \lambda_n x + h \sin \lambda_n x)^2 dx} \\ &= \frac{2}{\lambda_n^2 + 2h + h^2} \int_0^1 f(x) (\lambda_n \cos \lambda_n x + h \sin \lambda_n x) dx. \end{aligned}$$

[Note: the evaluation and simplification of the integral in the denominator requires the use of the relationship  $(\lambda^2 - h^2) \sin \lambda = 2h\lambda \cos \lambda$ .]

9. (a) Using  $u = XT$  and separation constant  $\lambda^4$  we find

$$X^{(4)} - \lambda^4 X = 0$$

and

$$X(x) = c_1 \cos \lambda x + c_2 \sin \lambda x + c_3 \cosh \lambda x + c_4 \sinh \lambda x.$$

Since  $u = XT$  the boundary conditions become

$$X(0) = 0, \quad X'(0) = 0, \quad X''(1) = 0, \quad X'''(1) = 0.$$

Now  $X(0) = 0$  implies  $c_1 + c_3 = 0$ , while  $X'(0) = 0$  implies  $c_2 + c_4 = 0$ . Thus

$$X(x) = c_1 \cos \lambda x + c_2 \sin \lambda x - c_1 \cosh \lambda x - c_2 \sinh \lambda x.$$

The boundary condition  $X''(1) = 0$  implies

$$-c_1 \cos \lambda - c_2 \sin \lambda - c_1 \cosh \lambda - c_2 \sinh \lambda = 0$$

while the boundary condition  $X'''(1) = 0$  implies

$$c_1 \sin \lambda - c_2 \cos \lambda - c_1 \sinh \lambda - c_2 \cosh \lambda = 0.$$

### Exercises 12.7

We then have the system of two equations in two unknowns

$$(\cos \lambda + \cosh \lambda)c_1 + (\sin \lambda + \sinh \lambda)c_2 = 0$$

$$(\sin \lambda - \sinh \lambda)c_1 - (\cos \lambda + \cosh \lambda)c_2 = 0.$$

This homogeneous system will have nontrivial solutions for  $c_1$  and  $c_2$  provided

$$\begin{vmatrix} \cos \lambda + \cosh \lambda & \sin \lambda + \sinh \lambda \\ \sin \lambda - \sinh \lambda & -\cos \lambda - \cosh \lambda \end{vmatrix} = 0$$

or

$$-2 - 2 \cos \lambda \cosh \lambda = 0.$$

Thus, the eigenvalues are determined by the equation  $\cos \lambda \cosh \lambda = -1$ .

- (b) Using a computer to graph  $\cosh \lambda$  and  $-1/\cos \lambda = -\sec \lambda$  we see that the first two positive eigenvalues occur near 1.9 and 4.7. Applying Newton's method with these initial values we find that the eigenvalues are  $\lambda_1 = 1.8751$  and  $\lambda_2 = 4.6941$ .

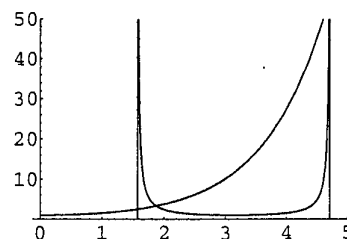

10. (a) In this case the boundary conditions are

$$\begin{aligned} u(0, t) = 0, & \quad \frac{\partial u}{\partial x} \Big|_{x=0} = 0 \\ u(1, t) = 0, & \quad \frac{\partial u}{\partial x} \Big|_{x=1} = 0. \end{aligned}$$

Separating variables leads to

$$X(x) = c_1 \cos \lambda x + c_2 \sin \lambda x + c_3 \cosh \lambda x + c_4 \sinh \lambda x$$

subject to

$$X(0) = 0, \quad X'(0) = 0, \quad X(1) = 0, \quad \text{and} \quad X'(1) = 0.$$

Now  $X(0) = 0$  implies  $c_1 + c_3 = 0$  while  $X'(0) = 0$  implies  $c_2 + c_4 = 0$ . Thus

$$X(x) = c_1 \cos \lambda x + c_2 \sin \lambda x - c_1 \cosh \lambda x - c_2 \sinh \lambda x.$$

The boundary condition  $X(1) = 0$  implies

$$c_1 \cos \lambda + c_2 \sin \lambda - c_1 \cosh \lambda - c_2 \sinh \lambda = 0$$

while the boundary condition  $X'(1) = 0$  implies

$$-c_1 \sin \lambda + c_2 \cos \lambda - c_1 \sinh \lambda - c_2 \cosh \lambda = 0.$$



We then have the system of two equations in two unknowns

$$\begin{aligned}(\cos \lambda - \cosh \lambda)c_1 + (\sin \lambda - \sinh \lambda)c_2 &= 0 \\ -(\sin \lambda + \sinh \lambda)c_1 + (\cos \lambda - \cosh \lambda)c_2 &= 0.\end{aligned}$$

This homogeneous system will have nontrivial solutions for  $c_1$  and  $c_2$  provided

$$\begin{vmatrix} \cos \lambda - \cosh \lambda & \sin \lambda - \sinh \lambda \\ -\sin \lambda - \sinh \lambda & \cos \lambda - \cosh \lambda \end{vmatrix} = 0$$

or

$$2 - 2 \cos \lambda \cosh \lambda = 0.$$

Thus, the eigenvalues are determined by the equation  $\cos \lambda \cosh \lambda = 1$ .

- (b) Using a computer to graph  $\cosh \lambda$  and  $1/\cos \lambda = \sec \lambda$  we see that the first two positive eigenvalues occur near the vertical asymptotes of  $\sec \lambda$ , at  $3\pi/2$  and  $5\pi/2$ . Applying Newton's method with these initial values we find that the eigenvalues are  $\lambda_1 = 4.7300$  and  $\lambda_2 = 7.8532$ .

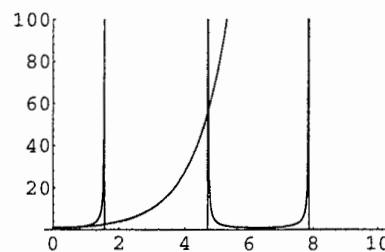

## Exercises 12.8

1. This boundary-value problem was solved in Example 1 in the text. Identifying  $b = c = \pi$  and  $f(x, y) = u_0$  we have

$$u(x, y, t) = \sum_{m=1}^{\infty} \sum_{n=1}^{\infty} A_{mn} e^{-k(m^2+n^2)t} \sin mx \sin ny$$

where

$$\begin{aligned}A_{mn} &= \frac{4}{\pi^2} \int_0^{\pi} \int_0^{\pi} u_0 \sin mx \sin ny \, dx \, dy \\ &= \frac{4u_0}{\pi^2} \int_0^{\pi} \sin mx \, dx \int_0^{\pi} \sin ny \, dy \\ &= \frac{4u_0}{mn\pi^2} [1 - (-1)^m][1 - (-1)^n].\end{aligned}$$

2. As shown in Example 1 in the text, separation of variables leads to

$$X(x) = c_1 \cos \lambda x + c_2 \sin \lambda x$$

$$Y(y) = c_3 \cos \mu y + c_4 \sin \mu y$$

### Exercises 12.8

and

$$T(t) + c_5 e^{-k(\lambda^2 + \mu^2)t}.$$

The boundary conditions

$$\left. \begin{array}{l} u_x(0, y, t) = 0, \quad u_x(1, y, t) = 0 \\ u_y(x, 0, t) = 0, \quad u_y(x, 1, t) = 0 \end{array} \right\} \text{ imply } \left\{ \begin{array}{l} X'(0) = 0, \quad X'(1) = 0 \\ Y'(0) = 0, \quad Y'(1) = 0. \end{array} \right.$$

Applying these conditions to

$$X'(x) = -\lambda c_1 \sin \lambda x + \lambda c_2 \cos \lambda x$$

and

$$Y'(y) = -\mu c_3 \sin \mu y + \mu c_4 \cos \mu y$$

gives  $c_2 = c_4 = 0$  and  $\sin \lambda = \sin \mu = 0$ . Then

$$\lambda = m\pi, \quad m = 0, 1, 2, \dots \quad \text{and} \quad \mu = n\pi, \quad n = 0, 1, 2, \dots$$

By the superposition principle

$$\begin{aligned} u(x, y, t) = & A_{00} + \sum_{m=1}^{\infty} A_{m0} e^{-km^2\pi^2 t} \cos m\pi x + \sum_{n=1}^{\infty} A_{0n} e^{-kn^2\pi^2 t} \cos n\pi y \\ & + \sum_{m=1}^{\infty} \sum_{n=1}^{\infty} A_{mn} e^{-k(m^2+n^2)\pi^2 t} \cos m\pi x \cos n\pi y. \end{aligned}$$

We now compute the coefficients of the double cosine series: Identifying  $b = c = 1$  and  $f(x, y) = xy$  we have

$$A_{00} = \int_0^1 \int_0^1 xy \, dx \, dy = \int_0^1 \frac{1}{2} x^2 y \Big|_0^1 \, dy = \frac{1}{2} \int_0^1 y \, dy = \frac{1}{4},$$

$$\begin{aligned} A_{m0} &= 2 \int_0^1 \int_0^1 xy \cos m\pi x \, dx \, dy = 2 \int_0^1 \frac{1}{m^2\pi^2} (\cos m\pi x + m\pi x \sin m\pi x) \Big|_0^1 \, y \, dy \\ &= 2 \int_0^1 \frac{\cos m\pi - 1}{m^2\pi^2} y \, dy = \frac{\cos m\pi - 1}{m^2\pi^2} = \frac{(-1)^m - 1}{m^2\pi^2}, \end{aligned}$$

$$A_{0n} = 2 \int_0^1 \int_0^1 xy \cos n\pi y \, dx \, dy = \frac{(-1)^n - 1}{n^2\pi^2},$$

and

$$\begin{aligned} A_{mn} &= 4 \int_0^1 \int_0^1 xy \cos m\pi x \cos n\pi y \, dx \, dy = 4 \int_0^1 x \cos m\pi x \, dx \int_0^1 y \cos n\pi y \, dy \\ &= 4 \left( \frac{(-1)^m - 1}{m^2\pi^2} \right) \left( \frac{(-1)^n - 1}{n^2\pi^2} \right). \end{aligned}$$

In Problems 3 and 4 we need to solve the partial differential equation

$$a^2 \left( \frac{\partial^2 u}{\partial x^2} + \frac{\partial^2 u}{\partial y^2} \right) = \frac{\partial^2 u}{\partial t^2}.$$

To separate this equation we try  $u(x, y, t) = X(x)Y(y)T(t)$ :

$$a^2(X''YT + XY''T) = XYT''$$

$$\frac{X''}{X} = -\frac{Y''}{Y} + \frac{T''}{a^2T} = -\lambda^2.$$

Then

$$X'' + \lambda^2 X = 0 \tag{1}$$

$$\frac{Y''}{Y} = \frac{T''}{a^2T} + \lambda^2 = -\mu^2$$

$$Y'' + \mu^2 Y = 0 \tag{2}$$

$$T'' + a^2(\lambda^2 + \mu^2)T = 0. \tag{3}$$

The general solutions of equations (1), (2), and (3) are, respectively,

$$X(x) = c_1 \cos \lambda x + c_2 \sin \lambda x$$

$$Y(y) = c_3 \cos \mu y + c_4 \sin \mu y$$

$$T(t) = c_5 \cos a\sqrt{\lambda^2 + \mu^2}t + c_6 \sin a\sqrt{\lambda^2 + \mu^2}t.$$

3. The conditions  $X(0) = 0$  and  $Y(0) = 0$  give  $c_1 = 0$  and  $c_3 = 0$ . The conditions  $X(\pi) = 0$  and  $Y(\pi) = 0$  yield two sets of eigenvalues:

$$\lambda = m, m = 1, 2, 3, \dots \quad \text{and} \quad \mu = n, n = 1, 2, 3, \dots$$

A product solution of the partial differential equation that satisfies the boundary conditions is

$$u_{mn}(x, y, t) = \left( A_{mn} \cos a\sqrt{m^2 + n^2}t + B_{mn} \sin a\sqrt{m^2 + n^2}t \right) \sin mx \sin ny.$$

To satisfy the initial conditions we use the superposition principle:

$$u(x, y, t) = \sum_{m=1}^{\infty} \sum_{n=1}^{\infty} \left( A_{mn} \cos a\sqrt{m^2 + n^2}t + B_{mn} \sin a\sqrt{m^2 + n^2}t \right) \sin mx \sin ny.$$

The initial condition  $u_t(x, y, 0) = 0$  implies  $B_{mn} = 0$  and

$$u(x, y, t) = \sum_{m=1}^{\infty} \sum_{n=1}^{\infty} A_{mn} \cos a\sqrt{m^2 + n^2}t \sin mx \sin ny.$$

### Exercises 12.8

At  $t = 0$  we have

$$xy(x - \pi)(y - \pi) = \sum_{m=1}^{\infty} \sum_{n=1}^{\infty} A_{mn} \sin mx \sin ny.$$

Using (11) and (12) in the text, it follows that

$$\begin{aligned} A_{mn} &= \frac{4}{\pi^2} \int_0^{\pi} \int_0^{\pi} xy(x - \pi)(y - \pi) \sin mx \sin ny \, dx \, dy \\ &= \frac{4}{\pi^2} \int_0^{\pi} x(x - \pi) \sin mx \, dx \int_0^{\pi} y(y - \pi) \sin ny \, dy \\ &= \frac{16}{m^3 n^3 \pi^2} [(-1)^m - 1][(-1)^n - 1]. \end{aligned}$$

4. The conditions  $X(0) = 0$  and  $Y(0) = 0$  give  $c_1 = 0$  and  $c_3 = 0$ . The conditions  $X(b) = 0$  and  $Y(c) = 0$  yield two sets of eigenvalues

$$\lambda = m\pi/b, \quad m = 1, 2, 3, \dots \quad \text{and} \quad \mu = n\pi/c, \quad n = 1, 2, 3, \dots$$

A product solution of the partial differential that satisfies the boundary conditions is

$$u_{mn}(x, y, t) = (A_{mn} \cos a\omega_{mn}t + B_{mn} \sin a\omega_{mn}t) \sin\left(\frac{m\pi}{b}x\right) \sin\left(\frac{n\pi}{c}y\right),$$

where  $\omega_{mn} = \sqrt{(m\pi/b)^2 + (n\pi/c)^2}$ . To satisfy the initial conditions we use the superposition principle:

$$u(x, y, t) = \sum_{m=1}^{\infty} \sum_{n=1}^{\infty} (A_{mn} \cos a\omega_{mn}t + B_{mn} \sin a\omega_{mn}t) \sin\left(\frac{m\pi}{b}x\right) \sin\left(\frac{n\pi}{c}y\right).$$

At  $t = 0$  we have

$$f(x, y) = \sum_{m=1}^{\infty} \sum_{n=1}^{\infty} A_{mn} \sin\left(\frac{m\pi}{b}x\right) \sin\left(\frac{n\pi}{c}y\right)$$

and

$$g(x, y) = \sum_{m=1}^{\infty} \sum_{n=1}^{\infty} B_{mn} a\omega_{mn} \sin\left(\frac{m\pi}{b}x\right) \sin\left(\frac{n\pi}{c}y\right).$$

Using (11) and (12) in the text, it follows that

$$A_{mn} = \frac{4}{bc} \int_0^c \int_0^b f(x, y) \sin\left(\frac{m\pi}{b}x\right) \sin\left(\frac{n\pi}{c}y\right) \, dx \, dy$$

$$B_{mn} = \frac{4}{abc\omega_{mn}} \int_0^c \int_0^b g(x, y) \sin\left(\frac{m\pi}{b}x\right) \sin\left(\frac{n\pi}{c}y\right) \, dx \, dy.$$

To separate Laplace's equation in three dimensions we try  $u(x, y, z) = X(x)Y(y)Z(z)$ :

$$X''YZ + XY''Z + XYZ'' = 0$$

$$\frac{X''}{X} = -\frac{Y''}{Y} - \frac{Z''}{Z} = -\lambda^2.$$

Then

$$X'' + \lambda^2 X = 0 \quad (4)$$

$$\frac{Y''}{Y} = -\frac{Z''}{Z} + \lambda^2 = -\mu^2$$

$$Y'' + \mu^2 Y = 0 \quad (5)$$

$$Z'' - (\lambda^2 + \mu^2)Z = 0. \quad (6)$$

The general solutions of equations (4), (5), and (6) are, respectively

$$X(x) = c_1 \cos \lambda x + c_2 \sin \lambda x$$

$$Y(y) = c_3 \cos \mu y + c_4 \sin \mu y$$

$$Z(z) = c_5 \cosh \sqrt{\lambda^2 + \mu^2} z + c_6 \sinh \sqrt{\lambda^2 + \mu^2} z.$$

5. The boundary and initial conditions are

$$u(0, y, z) = 0, \quad u(a, y, z) = 0$$

$$u(x, 0, z) = 0, \quad u(x, b, z) = 0$$

$$u(x, y, 0) = 0, \quad u(x, y, c) = f(x, y).$$

The conditions  $X(0) = Y(0) = Z(0) = 0$  give  $c_1 = c_3 = c_5 = 0$ . The conditions  $X(a) = 0$  and  $Y(b) = 0$  yield two sets of eigenvalues:

$$\lambda = \frac{m\pi}{a}, \quad m = 1, 2, 3, \dots \quad \text{and} \quad \mu = \frac{n\pi}{b}, \quad n = 1, 2, 3, \dots$$

By the superposition principle

$$u(x, y, z) = \sum_{m=1}^{\infty} \sum_{n=1}^{\infty} A_{mn} \sinh \omega_{mn} z \sin \frac{m\pi}{a} x \sin \frac{n\pi}{b} y$$

where

$$\omega_{mn}^2 = \frac{m^2 \pi^2}{a^2} + \frac{n^2 \pi^2}{b^2}$$

and

$$A_{mn} = \frac{4}{ab \sinh \omega_{mn} c} \int_0^b \int_0^a f(x, y) \sin \frac{m\pi}{a} x \sin \frac{n\pi}{b} y \, dx \, dy.$$

6. The boundary and initial conditions are

$$u(0, y, z) = 0, \quad u(a, y, z) = 0,$$

$$u(x, 0, z) = 0, \quad u(x, b, z) = 0,$$

$$u(x, y, 0) = f(x, y), \quad u(x, y, c) = 0.$$

### Exercises 12.8

The conditions  $X(0) = Y(0) = 0$  give  $c_1 = c_3 = 0$ . The conditions  $X(a) = Y(b) = 0$  yield two sets of eigenvalues:

$$\lambda = \frac{m\pi}{a}, \quad m = 1, 2, 3, \dots \quad \text{and} \quad \mu = \frac{n\pi}{b}, \quad n = 1, 2, 3, \dots$$

Let

$$\omega_{mn}^2 = \frac{m^2\pi^2}{a^2} + \frac{n^2\pi^2}{b^2}.$$

Then the boundary condition  $Z(c) = 0$  gives

$$c_5 \cosh \omega_{mn} c + c_6 \sinh \omega_{mn} c = 0$$

from which we obtain

$$\begin{aligned} Z(z) &= c_5 \left( \cosh \omega_{mn} z - \frac{\cosh \omega_{mn} c}{\sinh \omega_{mn} c} \sinh \omega_{mn} z \right) \\ &= \frac{c_5}{\sinh \omega_{mn} c} (\sinh \omega_{mn} c \cosh \omega_{mn} z - \cosh \omega_{mn} c \sinh \omega_{mn} z) = c_{mn} \sinh \omega_{mn} (c - z). \end{aligned}$$

By the superposition principle

$$u(x, y, t) = \sum_{m=1}^{\infty} \sum_{n=1}^{\infty} A_{mn} \sinh \omega_{mn} (c - z) \sin \frac{m\pi}{a} x \sin \frac{n\pi}{b} y$$

where

$$A_{mn} = \frac{4}{ab \sinh \omega_{mn} c} \int_0^b \int_0^a f(x, y) \sin \frac{m\pi}{a} x \sin \frac{n\pi}{b} y \, dx \, dy.$$

---

## Chapter 12 Review Exercises

---

1. Let  $u = XY$  so that

$$u_{yx} = X'Y',$$

$$X'Y' = XY,$$

and

$$\frac{X'}{X} = \frac{Y}{Y'} = \pm \lambda^2.$$

Then

$$X' \mp \lambda^2 X = 0 \quad \text{and} \quad Y \mp \lambda^2 Y' = 0.$$

For  $\lambda^2 > 0$  we obtain

$$X = c_1 e^{\lambda^2 x} \quad \text{and} \quad Y = c_2 e^{y/\lambda^2}.$$

For  $-\lambda^2 < 0$  we obtain

$$X = c_1 e^{-\lambda^2 x} \quad \text{and} \quad Y = c_2 e^{-y/\lambda^2}.$$

For  $\lambda^2 = 0$  we obtain  $X = c_1$  and  $Y = 0$ . The general form is

$$u = XY = A_1 e^{A_2 x + y/A_2}.$$

2. If  $u = XY$  then

$$u_x = X'Y,$$

$$u_y = XY',$$

$$u_{xx} = X''Y,$$

$$u_{yy} = XY'',$$

and

$$X''Y + XY'' + 2X'Y + 2XY' = 0$$

so that

$$(X'' + 2X')Y + X(Y'' + 2Y') = 0,$$

$$\frac{X'' + 2X'}{-X} = \frac{Y'' + 2Y'}{Y} = \pm\lambda^2,$$

$$X'' + 2X' \pm \lambda^2 X = 0,$$

and

$$Y'' + 2Y' \mp \lambda^2 Y = 0.$$

Using  $\lambda^2$  as a separation constant we obtain

$$Y = c_1 e^{(-1+\sqrt{1+\lambda^2})y} + c_2 e^{(-1-\sqrt{1+\lambda^2})y}.$$

If  $1 - \lambda^2 < 0$  then

$$X = e^{-x} \left( c_3 \cos \sqrt{\lambda^2 - 1} x + c_4 \sin \sqrt{\lambda^2 - 1} x \right).$$

If  $1 - \lambda^2 > 0$  then

$$X = c_3 e^{(-1+\sqrt{1-\lambda^2})x} + c_4 e^{(-1-\sqrt{1-\lambda^2})x}.$$

If  $1 - \lambda^2 = 0$  then

$$X = c_3 e^{-x} + c_4 x e^{-x}$$

so that

$$\begin{aligned} u = XY &= \left( A_1 e^{(-1+\sqrt{1+A_5})y} + A_2 e^{(-1-\sqrt{1+A_5})y} \right) e^{-x} \left( A_3 \cos \sqrt{A_5 - 1} x + A_4 \sin \sqrt{A_5 - 1} x \right) \\ &= \left( A_1 e^{(-1+\sqrt{1+A_5})y} + A_2 e^{(-1-\sqrt{1+A_5})y} \right) \left( A_3 e^{(-1+\sqrt{1-A_5})x} + A_4 e^{(-1-\sqrt{1-A_5})x} \right) \\ &= \left( A_1 e^{(-1+\sqrt{2})y} + A_2 e^{(-1-\sqrt{2})y} \right) \left( A_3 e^{-x} + A_4 x e^{-x} \right). \end{aligned}$$

## Chapter 12 Review Exercises

Using  $-\lambda^2$  we obtain the same three solutions except that  $x$  and  $y$  are interchanged. Using  $\lambda^2 = 0$  we obtain

$$u = XY = (A_1 + A_2 e^{-2x})(A_3 + A_4 e^{-2y}).$$

3. Substituting  $u(x, t) = v(x, t) + \psi(x)$  into the partial differential equation we obtain

$$k \frac{\partial^2 v}{\partial x^2} + k \psi''(x) = \frac{\partial v}{\partial t}.$$

This equation will be homogeneous provided  $\psi$  satisfies

$$k\psi'' = 0 \quad \text{or} \quad \psi = c_1 x + c_2.$$

Considering

$$u(0, t) = v(0, t) + \psi(0) = u_0$$

we set  $\psi(0) = u_0$  so that  $\psi(x) = c_1 x + u_0$ . Now

$$-\frac{\partial u}{\partial x} \Big|_{x=\pi} = -\frac{\partial v}{\partial x} \Big|_{x=\pi} - \psi'(x) = v(\pi, t) + \psi(\pi) - u_1$$

is equivalent to

$$\frac{\partial v}{\partial x} \Big|_{x=\pi} + v(\pi, t) = u_1 - \psi'(x) - \psi(\pi) = u_1 - c_1 - (c_1 \pi + u_0),$$

which will be homogeneous when

$$u_1 - c_1 - c_1 \pi - u_0 = 0 \quad \text{or} \quad c_1 = \frac{u_1 - u_0}{1 + \pi}.$$

The steady-state solution is

$$\psi(x) = \left( \frac{u_1 - u_0}{1 + \pi} \right) x + u_0.$$

4. The solution of the problem represents the heat of a thin rod of length  $\pi$ . The left boundary  $x = 0$  is kept at constant temperature  $u_0$  for  $t > 0$ . Heat is lost from the right end of the rod by being in contact with a medium that is held at constant temperature  $u_1$ .
5. The boundary-value problem is

$$a^2 \frac{\partial^2 u}{\partial x^2} = \frac{\partial^2 u}{\partial t^2}, \quad 0 < x < 1, \quad t > 0,$$

$$u(0, t) = 0, \quad u(1, t) = 0, \quad t > 0,$$

$$u(x, 0) = 0, \quad \frac{\partial u}{\partial t} \Big|_{t=0} = g(x), \quad 0 < x < 1.$$

From Section 12.4 in the text we see that  $A_n = 0$ ,

$$\begin{aligned} B_n &= \frac{2}{n\pi a} \int_0^1 g(x) \sin n\pi x \, dx = \frac{2}{n\pi a} \int_{1/4}^{3/4} h \sin n\pi x \, dx \\ &= \frac{2h}{n\pi a} \left( -\frac{1}{n\pi} \cos n\pi x \right) \Big|_{1/4}^{3/4} = \frac{2h}{n^2 \pi^2 a} \left( \cos \frac{n\pi}{4} - \cos \frac{3n\pi}{4} \right) \end{aligned}$$



and

$$u(x, t) = \sum_{n=1}^{\infty} B_n \sin n\pi at \sin n\pi x.$$

6. The boundary-value problem is

$$\frac{\partial^2 u}{\partial x^2} + x^2 = \frac{\partial^2 u}{\partial t^2}, \quad 0 < x < 1, \quad t > 0,$$

$$u(0, t) = 1, \quad u(1, t) = 0, \quad t > 0,$$

$$u(x, 0) = f(x), \quad u_t(x, 0) = 0, \quad 0 < x < 1.$$

Substituting  $u(x, t) = v(x, t) + \psi(x)$  into the partial differential equation gives

$$\frac{\partial^2 v}{\partial x^2} + \psi''(x) + x^2 = \frac{\partial^2 v}{\partial t^2}.$$

This equation will be homogeneous provided  $\psi''(x) + x^2 = 0$  or

$$\psi(x) = -\frac{1}{12}x^4 + c_1x + c_2.$$

From  $\psi(0) = 1$  and  $\psi(1) = 0$  we obtain  $c_1 = -11/12$  and  $c_2 = 1$ . The new problem is

$$\frac{\partial^2 v}{\partial x^2} = \frac{\partial^2 v}{\partial t^2}, \quad 0 < x < 1, \quad t > 0,$$

$$v(0, t) = 0, \quad v(1, t) = 0, \quad t > 0,$$

$$v(x, 0) = f(x) - \psi(x), \quad v_t(x, 0) = 0, \quad 0 < x < 1.$$

From Section 12.4 in the text we see that  $B_n = 0$ ,

$$A_n = 2 \int_0^1 [f(x) - \psi(x)] \sin n\pi x \, dx = 2 \int_0^1 \left[ f(x) + \frac{1}{12}x^4 + \frac{11}{12}x - 1 \right] \sin n\pi x \, dx,$$

and

$$v(x, t) = \sum_{n=1}^{\infty} A_n \cos n\pi t \sin n\pi x.$$

Thus

$$u(x, t) = v(x, t) + \psi(x) = -\frac{1}{12}x^4 - \frac{11}{12}x + 1 + \sum_{n=1}^{\infty} A_n \cos n\pi t \sin n\pi x.$$

7. Using  $u = XY$  and  $\lambda^2$  as a separation constant leads to

$$X'' - \lambda^2 X = 0,$$

$$X(0) = 0,$$

and

Chapter 12 Review Exercises

$$Y'' + \lambda^2 Y = 0,$$

$$Y(0) = 0,$$

$$Y(\pi) = 0.$$

Then

$$Y = c_1 \sin ny \quad \text{and} \quad X = c_2 \sinh nx$$

for  $n = 1, 2, 3, \dots$  so that

$$u = \sum_{n=1}^{\infty} A_n \sinh nx \sin ny.$$

Imposing

$$u(\pi, y) = 50 = \sum_{n=1}^{\infty} A_n \sinh n\pi \sin ny$$

gives

$$A_n \sinh n\pi = \frac{100}{n\pi} \frac{1 - (-1)^n}{\sinh n\pi}$$

so that

$$u(x, y) = \frac{100}{\pi} \sum_{n=1}^{\infty} \frac{1 - (-1)^n}{n \sinh n\pi} \sinh nx \sin ny.$$

8. Using  $u = XY$  and  $\lambda^2$  as a separation constant leads to

$$X'' - \lambda^2 X = 0,$$

and

$$Y'' + \lambda^2 Y = 0,$$

$$Y'(0) = 0,$$

$$Y'(\pi) = 0.$$

Then

$$Y = c_1 \cos ny$$

for  $n = 0, 1, 2, \dots$  and

$$X = c_2 \quad \text{or} \quad X = c_2 e^{-nx}$$

for  $n = 1, 2, 3, \dots$  (since  $u$  must be bounded as  $x \rightarrow \infty$ ) so that

$$u = A_0 + \sum_{n=1}^{\infty} A_n e^{-nx} \cos ny.$$

Imposing

$$u(0, y) = 50 = A_0 + \sum_{n=1}^{\infty} A_n \cos ny$$

gives

$$A_0 = \frac{1}{\pi} \int_0^\pi 50 \, dy = 50$$

and

$$A_n = \frac{2}{\pi} \int_0^\pi 50 \cos ny \, dy = 0$$

for  $n = 1, 2, 3, \dots$  so that

$$u(x, y) = 50.$$

9. Using  $u = XY$  and  $\lambda^2$  as a separation constant leads to

$$X'' - \lambda^2 X = 0,$$

and

$$Y'' + \lambda^2 Y = 0,$$

$$Y(0) = 0,$$

$$Y(\pi) = 0.$$

Then

$$Y = c_1 \sin ny \quad \text{and} \quad X = c_2 e^{-nx}$$

for  $n = 1, 2, 3, \dots$  (since  $u$  must be bounded as  $x \rightarrow \infty$ ) so that

$$u = \sum_{n=1}^{\infty} A_n e^{-nx} \sin ny.$$

Imposing

$$u(0, y) = 50 = \sum_{n=1}^{\infty} A_n \sin ny$$

gives

$$A_n = \frac{2}{\pi} \int_0^\pi 50 \sin ny \, dy = \frac{100}{n\pi} [1 - (-1)^n]$$

so that

$$u(x, y) = \sum_{n=1}^{\infty} \frac{100}{n\pi} [1 - (-1)^n] e^{-nx} \sin ny.$$

10. The boundary-value problem is

$$k \frac{\partial^2 u}{\partial x^2} = \frac{\partial u}{\partial t}, \quad -L < x < L, \quad t > 0,$$

$$u(-L, t) = 0, \quad u(L, t) = 0, \quad t > 0,$$

$$u(x, 0) = u_0, \quad -L < x < L.$$

## Chapter 12 Review Exercises

Referring to Section 12.3 in the text we have

$$X(x) = c_1 \cos \lambda x + c_2 \sin \lambda x$$

and

$$T(t) = c_3 e^{-k\lambda^2 t}.$$

Using the boundary conditions  $u(-L, 0) = X(-L)T(0) = 0$  and  $u(L, 0) = X(L)T(0) = 0$  we obtain

$$c_1 \cos(-\lambda L) + c_2 \sin(-\lambda L) = 0$$

$$c_1 \cos \lambda L + c_2 \sin \lambda L = 0$$

or

$$c_1 \cos \lambda L - c_2 \sin \lambda L = 0$$

$$c_1 \cos \lambda L + c_2 \sin \lambda L = 0.$$

Adding, we find  $\cos \lambda L = 0$  which gives the eigenvalues

$$\lambda = \frac{2n-1}{2L}\pi, \quad n = 1, 2, 3, \dots$$

Thus

$$u(x, t) = \sum_{n=1}^{\infty} A_n e^{-\left(\frac{2n-1}{2L}\pi\right)^2 kt} \cos\left(\frac{2n-1}{2L}\pi x\right).$$

From

$$u(x, 0) = u_0 = \sum_{n=1}^{\infty} A_n \cos\left(\frac{2n-1}{2L}\pi x\right)$$

we find

$$A_n = \frac{2 \int_0^L u_0 \cos\left(\frac{2n-1}{2L}\pi x\right) \pi x \, dx}{2 \int_0^L \cos^2\left(\frac{2n-1}{2L}\pi x\right) \pi x \, dx} = \frac{u_0 (-1)^{n+1} 2L/\pi(2n-1)}{L/2} = \frac{4u_0 (-1)^{n+1}}{\pi(2n-1)}.$$

11. The coefficients of the series

$$u(x, 0) = \sum_{n=1}^{\infty} B_n \sin nx$$

are

$$\begin{aligned} B_n &= \frac{2}{\pi} \int_0^\pi \sin x \sin nx \, dx = \frac{2}{\pi} \int_0^\pi \frac{1}{2} [\cos(1-n)x - \cos(1+n)x] \, dx \\ &= \frac{1}{\pi} \left[ \frac{\sin(1-n)x}{1-n} \Big|_0^\pi - \frac{\sin(1+n)x}{1+n} \Big|_0^\pi \right] = 0 \text{ for } n \neq 1. \end{aligned}$$

For  $n = 1$ ,

$$B_1 = \frac{2}{\pi} \int_0^\pi \sin^2 x \, dx = \frac{1}{\pi} \int_0^\pi (1 - \cos 2x) \, dx = 1.$$

Thus

$$u(x, t) = \sum_{n=1}^{\infty} B_n e^{-n^2 t} \sin nx$$

reduces to  $u(x, t) = e^{-t} \sin x$  for  $n = 1$ .

12. Substituting  $u(x, t) = v(x, t) + \psi(x)$  into the partial differential equation gives

$$k \frac{\partial^2 v}{\partial x^2} + k\psi'' + \sin 2\pi x = \frac{\partial v}{\partial t}.$$

This equation will be homogeneous provided  $\psi$  satisfies

$$k\psi'' + \sin 2\pi x = 0.$$

The general solution of this equation is

$$\psi(x) = \frac{1}{4k\pi^2} \sin 2\pi x + c_1 x + c_2.$$

From  $\psi(0) = \psi(1) = 0$  we find that  $c_1 = c_2 = 0$  and

$$\psi(x) = \frac{1}{4k\pi^2} \sin 2\pi x.$$

Now the new problem is

$$\begin{aligned} k \frac{\partial^2 v}{\partial x^2} &= \frac{\partial v}{\partial t}, & 0 < x < 1, & \quad t > 0 \\ v(0, t) &= 0, & v(1, t) &= 0, & \quad t > 0 \\ v(x, 0) &= \sin \pi x - \psi(x), & 0 < x < 1. \end{aligned}$$

If we let  $v = XT$  then

$$\frac{X''}{X} = \frac{T'}{kT} = -\lambda^2$$

gives the separated differential equations

$$X'' + \lambda^2 X = 0 \quad \text{and} \quad T' + k\lambda^2 T = 0.$$

The respective solutions are

$$X(x) = c_3 \cos \lambda x + c_4 \sin \lambda x$$

$$T(t) = c_5 e^{-k\lambda^2 t}.$$

From  $X(0) = 0$  we get  $c_3 = 0$  and from  $X(1) = 0$  we find  $\lambda = n\pi$  for  $n = 1, 2, 3, \dots$ . Consequently, it follows that

$$v(x, t) = \sum_{n=1}^{\infty} A_n e^{-kn^2\pi^2 t} \sin n\pi x$$

where

$$v(x, 0) = \sin \pi x - \frac{1}{4k\pi^2} \sin 2\pi x = 0$$

implies

$$A_n = 2 \int_0^1 \left( \sin \pi x - \frac{1}{4k\pi^2} \sin 2\pi x \right) \sin n\pi x \, dx.$$

## Chapter 12 Review Exercises

By orthogonality  $A_n = 0$  for  $n = 3, 4, 5, \dots$ , and only  $A_1$  and  $A_2$  can be nonzero. We have

$$A_1 = 2 \left[ \int_0^1 \sin^2 \pi x \, dx - \frac{1}{4k\pi^2} \int_0^1 \sin 2\pi x \sin \pi x \, dx \right] = 2 \int_0^1 \frac{1}{2} (1 - \cos 2\pi x) \, dx = 1$$

and

$$\begin{aligned} A_2 &= 2 \left[ \int_0^1 \sin \pi x \sin 2\pi x \, dx - \frac{1}{4k\pi^2} \int_0^1 \sin^2 2\pi x \, dx \right] \\ &= -\frac{1}{2k\pi^2} \int_0^1 \frac{1}{2} (1 - \cos 4\pi x) \, dx = -\frac{1}{4k\pi^2}. \end{aligned}$$

Therefore

$$\begin{aligned} v(x, t) &= A_1 e^{-k\pi^2 t} \sin \pi x + A_2 e^{-4k\pi^2 t} \sin 2\pi x \\ &= e^{-k\pi^2 t} \sin \pi x - \frac{1}{4k\pi^2} e^{-4k\pi^2 t} \sin 2\pi x \end{aligned}$$

and

$$u(x, t) = v(x, t) + \psi(x) = e^{-k\pi^2 t} \sin \pi x + \frac{1}{4k\pi^2} (1 - e^{-4k\pi^2 t}) \sin 2\pi x.$$

13. Using  $u = XT$  and  $-\lambda^2$  as a separation constant we find

$$X'' + 2X' + \lambda^2 X = 0 \quad \text{and} \quad T'' + 2T' + (1 + \lambda^2)T = 0.$$

Thus for  $\lambda > 1$

$$X = c_1 e^{-x} \cos \sqrt{\lambda^2 - 1} x + c_2 e^{-x} \sin \sqrt{\lambda^2 - 1} x$$

$$T = c_3 e^{-t} \cos \lambda t + c_4 e^{-t} \sin \lambda t.$$

For  $0 \leq \lambda \leq 1$  we only obtain  $X = 0$ . Now the boundary conditions  $X(0) = 0$  and  $X(\pi) = 0$  give, in turn,  $c_1 = 0$  and  $\sqrt{\lambda^2 - 1} \pi = n\pi$  or  $\lambda^2 = n^2 + 1$ ,  $n = 1, 2, 3, \dots$ . The corresponding solutions are  $X = c_2 e^{-x} \sin nx$ . The initial condition  $T'(0) = 0$  implies  $c_3 = \lambda c_4$  and so

$$T = c_4 e^{-t} \left[ \sqrt{n^2 + 1} \cos \sqrt{n^2 + 1} t + \sin \sqrt{n^2 + 1} t \right].$$

Using  $u = XT$  and the superposition principle, a formal series solution is

$$u(x, t) = e^{-(x+t)} \sum_{n=1}^{\infty} A_n \left[ \sqrt{n^2 + 1} \cos \sqrt{n^2 + 1} t + \sin \sqrt{n^2 + 1} t \right] \sin nx.$$

14. Letting  $c = XT$  and separating variables we obtain

$$\frac{kX'' - hX'}{X} = \frac{T'}{T} \quad \text{or} \quad \frac{X'' - \alpha X'}{X} = \frac{T'}{kT} = -\lambda^2$$

where  $\alpha = h/k$ . This leads to the separated differential equations

$$X'' - \alpha X' + \lambda^2 X = 0 \quad \text{and} \quad T' + k\lambda^2 T = 0.$$

The solution of the second equation is

$$T(t) = c_3 e^{-k\lambda^2 t}.$$

Chapter 12 Review Exercises

For the first equation we have  $m = \frac{1}{2}(\alpha \pm \sqrt{\alpha^2 - 4\lambda^2})$ , and we consider three cases using the boundary conditions  $X(0) = X(1) = 0$ :

$\boxed{\alpha^2 > 4\lambda^2}$  The solution is  $X = c_1 e^{m_1 x} + c_2 e^{m_2 x}$ , where the boundary conditions imply  $c_1 = c_2 = 0$ , so  $X = 0$ . (Note in this case that if  $\lambda = 0$ , the solution is  $X = c_1 + c_2 e^{\alpha x}$  and the boundary conditions again imply  $c_1 = c_2 = 0$ , so  $X = 0$ .)

$\boxed{\alpha^2 = 4\lambda^2}$  The solution is  $X = c_1 e^{m_1 x} + c_2 x e^{m_1 x}$ , where the boundary conditions imply  $c_1 = c_2 = 0$ , so  $X = 0$ .

$\boxed{\alpha^2 < 4\lambda^2}$  The solution is

$$X(x) = c_1 e^{\alpha x/2} \cos \frac{\sqrt{4\lambda^2 - \alpha^2}}{2} x + c_2 e^{\alpha x/2} \sin \frac{\sqrt{4\lambda^2 - \alpha^2}}{2} x.$$

From  $X(0) = 0$  we see that  $c_1 = 0$ . From  $X(1) = 0$  we find

$$\frac{1}{2} \sqrt{4\lambda^2 - \alpha^2} = n\pi \quad \text{or} \quad \lambda^2 = \frac{1}{4}(4n^2\pi^2 + \alpha^2).$$

Thus

$$X(x) = c_2 e^{\alpha x/2} \sin n\pi x,$$

and

$$c(x, t) = \sum_{n=1}^{\infty} A_n e^{\alpha x/2} e^{-k(4n^2\pi^2 + \alpha^2)t/4} \sin 2n\pi x.$$

The initial condition  $c(x, 0) = c_0$  implies

$$c_0 = \sum_{n=1}^{\infty} A_n e^{\alpha/2} \sin n\pi x. \tag{1}$$

From the self-adjoint form

$$\frac{d}{dx} [e^{-\alpha x} X'] + \lambda^2 e^{-\alpha x} X = 0$$

the eigenfunctions are orthogonal on  $[0, 1]$  with weight function  $e^{-\alpha x}$ . That is

$$\int_0^1 e^{-\alpha x} (e^{\alpha x/2} \sin n\pi x)(e^{\alpha x/2} \sin m\pi x) dx = 0, \quad n \neq m.$$

Multiplying (1) by  $e^{-\alpha x} e^{\alpha x/2} \sin m\pi x$  and integrating we obtain

$$\int_0^1 c_0 e^{-\alpha x} e^{\alpha x/2} \sin m\pi x dx = \sum_{n=1}^{\infty} A_n e^{-\alpha x} e^{\alpha x/2} (\sin m\pi x) e^{\alpha x/2} \sin n\pi x dx$$

$$c_0 \int_0^1 e^{-\alpha x/2} \sin n\pi x dx = A_n \int_0^1 \sin^2 n\pi x dx = \frac{1}{2} A_n$$

and

$$A_n = 2c_0 \int_0^1 e^{-\alpha x/2} \sin n\pi x dx = \frac{4c_0 [2e^{\alpha/2} n\pi - 2n\pi(-1)^n]}{e^{\alpha/2}(\alpha^2 + 4n^2\pi^2)} = \frac{8n\pi c_0 [e^{\alpha/2} - (-1)^n]}{e^{\alpha/2}(\alpha^2 + 4n^2\pi^2)}.$$

# 13 Boundary-Value Problems in Other Coordinate Systems

## Exercises 13.1

1. We have

$$A_0 = \frac{1}{2\pi} \int_0^\pi u_0 d\theta = \frac{u_0}{2}$$

$$A_n = \frac{1}{\pi} \int_0^\pi u_0 \cos n\theta d\theta = 0$$

$$B_n = \frac{1}{\pi} \int_0^\pi u_0 \sin n\theta d\theta = \frac{u_0}{n\pi} [1 - (-1)^n]$$

and so

$$u(r, \theta) = \frac{u_0}{2} + \frac{u_0}{\pi} \sum_{n=1}^{\infty} \frac{1 - (-1)^n}{n} r^n \sin n\theta.$$

2. We have

$$A_0 = \frac{1}{2\pi} \int_0^\pi \theta d\theta + \frac{1}{2\pi} \int_\pi^{2\pi} (\pi - \theta) d\theta = 0$$

$$A_n = \frac{1}{\pi} \int_0^\pi \theta \cos n\theta d\theta + \frac{1}{\pi} \int_\pi^{2\pi} (\pi - \theta) \cos n\theta d\theta = \frac{2}{n^2\pi} [(-1)^n - 1]$$

$$B_n = \frac{1}{\pi} \int_0^\pi \theta \sin n\theta d\theta + \frac{1}{\pi} \int_\pi^{2\pi} (\pi - \theta) \sin n\theta d\theta = \frac{1}{n} [1 - (-1)^n]$$

and so

$$u(r, \theta) = \sum_{n=1}^{\infty} r^n \left[ \frac{(-1)^n - 1}{n^2\pi} \cos n\theta + \frac{1 - (-1)^n}{n} \sin n\theta \right].$$

3. We have

$$A_0 = \frac{1}{2\pi} \int_0^{2\pi} (2\pi\theta - \theta^2) d\theta = \frac{2\pi^2}{3}$$

$$A_n = \frac{1}{\pi} \int_0^{2\pi} (2\pi\theta - \theta^2) \cos n\theta d\theta = -\frac{4}{n^2}$$

$$B_n = \frac{1}{\pi} \int_0^{2\pi} (2\pi\theta - \theta^2) \sin n\theta d\theta = 0$$

and so

$$u(r, \theta) = \frac{2\pi^2}{3} - 4 \sum_{n=1}^{\infty} \frac{r^n}{n^2} \cos n\theta.$$



4. We have

$$A_0 = \frac{1}{2\pi} \int_0^{2\pi} \theta \, d\theta = \pi$$

$$A_n = \frac{1}{\pi} \int_0^{2\pi} \theta \cos n\theta \, d\theta = 0$$

$$B_n = \frac{1}{\pi} \int_0^{2\pi} \theta \sin n\theta \, d\theta = -\frac{2}{n}$$

and so

$$u(r, \theta) = \pi - 2 \sum_{n=1}^{\infty} \frac{r^n}{n} \sin n\theta.$$

5. As in Example 1 in the text we have  $R(r) = c_3 r^n + c_4 r^{-n}$ . In order that the solution be bounded as  $r \rightarrow \infty$  we must define  $c_3 = 0$ . Hence

$$u(r, \theta) = A_0 + \sum_{n=1}^{\infty} r^{-n} (A_n \cos n\theta + B_n \sin n\theta)$$

where

$$A_0 = \frac{1}{2\pi} \int_0^{2\pi} f(\theta) \, d\theta$$

$$A_n = \frac{c^n}{\pi} \int_0^{2\pi} f(\theta) \cos n\theta \, d\theta$$

$$B_n = \frac{c^n}{\pi} \int_0^{2\pi} f(\theta) \sin n\theta \, d\theta.$$

6. We solve

$$\frac{\partial^2 u}{\partial r^2} + \frac{1}{r} \frac{\partial u}{\partial r} + \frac{1}{r^2} \frac{\partial^2 u}{\partial \theta^2} = 0, \quad 0 < \theta < \frac{\pi}{2}, \quad 0 < r < c,$$

$$u(c, \theta) = f(\theta), \quad 0 < \theta < \frac{\pi}{2},$$

$$u(r, 0) = 0, \quad u(r, \pi/2) = 0, \quad 0 < r < c.$$

Proceeding as in Example 1 in the text we obtain the separated differential equations

$$r^2 R'' + rR' - \lambda^2 R = 0$$

$$\Theta'' + \lambda^2 \Theta = 0$$

with solutions

$$\Theta(\theta) = c_1 \cos \lambda\theta + c_2 \sin \lambda\theta$$

$$R(r) = c_3 r^\lambda + c_4 r^{-\lambda}.$$

Since we want  $R(r)$  to be bounded as  $r \rightarrow 0$  we require  $c_4 = 0$ . Applying the boundary conditions  $\Theta(0) = 0$  and  $\Theta(\pi/2) = 0$  we find that  $c_1 = 0$  and  $\lambda = 2n$  for  $n = 1, 2, 3, \dots$ . Therefore

$$u(r, \theta) = \sum_{n=1}^{\infty} A_n r^{2n} \sin 2n\theta.$$

### Exercises 13.1

From

$$u(c, \theta) = f(\theta) = \sum_{n=1}^{\infty} A_n c^n \sin 2n\theta$$

we find

$$A_n = \frac{4}{\pi c^{2n}} \int_0^{\pi/2} f(\theta) \sin 2n\theta \, d\theta.$$

7. Referring to the solution of Problem 6 above we have

$$\Theta(\theta) = c_1 \cos \lambda\theta + c_2 \sin \lambda\theta$$

$$R(r) = c_3 r^n.$$

Applying the boundary conditions  $\Theta'(0) = 0$  and  $\Theta'(\pi/2) = 0$  we find that  $c_2 = 0$  and  $\lambda = 2n$  for  $n = 0, 1, 2, \dots$ . Therefore

$$u(r, \theta) = A_0 + \sum_{n=1}^{\infty} A_n r^{2n} \cos 2n\theta.$$

From

$$u(c, \theta) = \begin{cases} 1, & 0 < \theta < \pi/4 \\ 0, & \pi/4 < \theta < \pi/2 \end{cases} = A_0 + \sum_{n=1}^{\infty} A_n c^{2n} \cos 2n\theta$$

we find

$$A_0 = \frac{1}{\pi/2} \int_0^{\pi/4} d\theta = \frac{1}{2}$$

and

$$c^{2n} A_n = \frac{2}{\pi/2} \int_0^{\pi/4} \cos 2n\theta \, d\theta = \frac{2}{n\pi} \sin \frac{n\pi}{2}.$$

Thus

$$u(r, \theta) = \frac{1}{2} + \frac{2}{\pi} \sum_{n=1}^{\infty} \frac{1}{n} \sin \frac{n\pi}{2} \left(\frac{r}{c}\right)^{2n} \cos 2n\theta.$$

8. We solve

$$\frac{\partial^2 u}{\partial r^2} + \frac{1}{r} \frac{\partial u}{\partial r} + \frac{1}{r^2} \frac{\partial^2 u}{\partial \theta^2} = 0, \quad 0 < \theta < \pi/4, \quad r > 0$$

$$u(r, 0) = 0, \quad r > 0$$

$$u(r, \pi/4) = 30, \quad r > 0.$$

Proceeding as in Example 1 in the text we find the separated ordinary differential equations to be

$$r^2 R'' + rR' - \lambda^2 R = 0$$

$$\Theta'' + \lambda^2 \Theta = 0.$$

The corresponding general solutions are

$$R(r) = c_1 r^\lambda + c_2 r^{-\lambda}$$

$$\Theta(\theta) = c_3 \cos \lambda\theta + c_4 \sin \lambda\theta.$$

The condition  $\Theta(0) = 0$  implies  $c_3 = 0$  so that  $\Theta = c_4 \sin \lambda\theta$ . Now, in order that the temperature be bounded as  $r \rightarrow \infty$  we define  $c_1 = 0$ . Similarly, in order that the temperature be bounded as  $r \rightarrow 0$  we are forced to define  $c_2 = 0$ . Thus  $R(r) = 0$  and so no nontrivial solution exists for  $\lambda > 0$ . For  $\lambda = 0$  the separated differential equations are

$$r^2 R'' + rR' = 0 \quad \text{and} \quad \Theta'' = 0.$$

Solutions of these latter equations are

$$R(r) = c_1 + c_2 \ln r \quad \text{and} \quad \Theta(\theta) = c_2\theta + c_3.$$

$\Theta(0) = 0$  still implies  $c_3 = 0$ , whereas boundedness as  $r \rightarrow 0$  demands  $c_2 = 0$ . Thus, a product solution is

$$u = c_1 c_2 \theta = A\theta.$$

From  $u(r, \pi/4) = 0$  we obtain  $A = 120/\pi$ . Thus, a solution to the problem is

$$u(r, \theta) = \frac{120}{\pi} \theta.$$

9. Proceeding as in Example 1 in the text and again using the periodicity of  $u(r, \theta)$ , we have

$$\Theta(\theta) = c_1 \cos \lambda\theta + c_2 \sin \lambda\theta$$

where  $\lambda = n$  for  $n = 0, 1, 2, \dots$ . Then

$$R(r) = c_3 r^n + c_4 r^{-n}.$$

[We do not have  $c_4 = 0$  in this case since  $0 < a \leq r$ .] Since  $u(b, \theta) = 0$  we have

$$u(r, \theta) = A_0 \ln \frac{r}{b} + \sum_{n=1}^{\infty} \left[ \left( \frac{b}{r} \right)^n - \left( \frac{r}{b} \right)^n \right] [A_n \cos n\theta + B_n \sin n\theta].$$

From

$$u(a, \theta) = f(\theta) = A_0 \ln \frac{a}{b} + \sum_{n=1}^{\infty} \left[ \left( \frac{b}{a} \right)^n - \left( \frac{a}{b} \right)^n \right] [A_n \cos n\theta + B_n \sin n\theta]$$

we find

$$A_0 \ln \frac{a}{b} = \frac{1}{2\pi} \int_0^{2\pi} f(\theta) d\theta,$$

$$\left[ \left( \frac{b}{a} \right)^n - \left( \frac{a}{b} \right)^n \right] A_n = \frac{1}{\pi} \int_0^{2\pi} f(\theta) \cos n\theta d\theta,$$

and

### Exercises 13.1

$$\left[ \left( \frac{b}{a} \right)^n - \left( \frac{a}{b} \right)^n \right] B_n = \frac{1}{\pi} \int_0^{2\pi} f(\theta) \sin n\theta \, d\theta.$$

10. Substituting  $u(r, \theta) = v(r, \theta) + \psi(r)$  into the partial differential equation we obtain

$$\frac{\partial^2 v}{\partial r^2} + \psi''(r) + \frac{1}{r} \left[ \frac{\partial v}{\partial r} + \psi'(r) \right] + \frac{1}{r^2} \frac{\partial^2 v}{\partial \theta^2} = 0.$$

This equation will be homogeneous provided

$$\psi''(r) + \frac{1}{r} \psi'(r) = 0 \quad \text{or} \quad r^2 \psi''(r) + r \psi'(r) = 0.$$

The general solution of this Cauchy-Euler differential equation is

$$\psi(r) = c_1 + c_2 \ln r.$$

From

$$u_0 = u(a, \theta) = v(a, \theta) + \psi(a) \quad \text{and} \quad u_1 = u(b, \theta) = v(b, \theta) + \psi(b)$$

we see that in order for the boundary values  $v(a, \theta)$  and  $v(b, \theta)$  to be 0 we need  $\psi(a) = u_0$  and  $\psi(b) = u_1$ . From this we have

$$\psi(a) = c_1 + c_2 \ln a = u_0$$

$$\psi(b) = c_1 + c_2 \ln b = u_1.$$

Solving for  $c_1$  and  $c_2$  we obtain

$$c_1 = \frac{u_1 \ln a - u_0 \ln b}{\ln a/b} \quad \text{and} \quad c_2 = \frac{u_0 - u_1}{\ln a/b}.$$

Then

$$\psi(r) = \frac{u_1 \ln a - u_0 \ln b}{\ln a/b} + \frac{u_0 - u_1}{\ln a/b} \ln r = \frac{u_0 \ln r/b - u_1 \ln r/a}{\ln a/b}.$$

From Problem 9 with  $f(\theta) = 0$  we see that the solution of

$$\frac{\partial^2 v}{\partial r^2} + \frac{1}{r} \frac{\partial v}{\partial r} + \frac{1}{r^2} \frac{\partial^2 v}{\partial \theta^2} = 0, \quad 0 < \theta < 2\pi, \quad a < r < b,$$

$$v(a, \theta) = 0, \quad v(b, \theta) = 0, \quad 0 < \theta < 2\pi$$

is  $v(r, \theta) = 0$ . Thus the steady-state temperature of the ring is

$$u(r, \theta) = v(r, \theta) + \psi(r) = \frac{u_0 \ln r/b - u_1 \ln r/a}{\ln a/b}.$$

11. We solve

$$\frac{\partial^2 u}{\partial r^2} + \frac{1}{r} \frac{\partial u}{\partial r} + \frac{1}{r^2} \frac{\partial^2 u}{\partial \theta^2} = 0, \quad 0 < \theta < \pi, \quad a < r < b,$$

$$u(a, \theta) = \theta(\pi - \theta), \quad u(b, \theta) = 0, \quad 0 < \theta < \pi,$$

$$u(r, 0) = 0, \quad u(r, \pi) = 0, \quad a < r < b.$$

Proceeding as in Example 1 in the text we obtain the separated differential equations

$$r^2 R'' + rR' - \lambda^2 R = 0$$

$$\Theta'' + \lambda^2 \Theta = 0$$

with solutions

$$\Theta(\theta) = c_1 \cos \lambda\theta + c_2 \sin \lambda\theta$$

$$R(r) = c_3 r^\lambda + c_4 r^{-\lambda}.$$

Applying the boundary conditions  $\Theta(0) = 0$  and  $\Theta(\pi) = 0$  we find that  $c_1 = 0$  and  $\lambda = n$  for  $n = 1, 2, 3, \dots$ . The boundary condition  $R(b) = 0$  gives

$$c_3 b^n + c_4 b^{-n} = 0 \quad \text{and} \quad c_4 = -c_3 b^{2n}.$$

Then

$$R(r) = c_3 \left( r^n - \frac{b^{2n}}{r^n} \right) = c_3 \left( \frac{r^{2n} - b^{2n}}{r^n} \right)$$

and

$$u(r, \theta) = \sum_{n=1}^{\infty} A_n \left( \frac{r^{2n} - b^{2n}}{r^n} \right) \sin n\theta.$$

From

$$u(a, \theta) = \theta(\pi - \theta) = \sum_{n=1}^{\infty} A_n \left( \frac{a^{2n} - b^{2n}}{a^n} \right) \sin n\theta$$

we find

$$A_n \left( \frac{a^{2n} - b^{2n}}{a^n} \right) = \frac{2}{\pi} \int_0^\pi (\theta\pi - \theta^2) \sin n\theta \, d\theta = \frac{4}{n^3\pi} [1 - (-1)^n].$$

Thus

$$u(r, \theta) = \frac{4}{\pi} \sum_{n=1}^{\infty} \frac{1 - (-1)^n}{n^3} \frac{r^{2n} - b^{2n}}{a^{2n} - b^{2n}} \left( \frac{a}{r} \right)^n \sin n\theta.$$

12. Letting  $u(r, \theta) = v(r, \theta) + \psi(\theta)$  we obtain  $\psi''(\theta) = 0$  and so  $\psi(\theta) = c_1\theta + c_2$ . From  $\psi(0) = 0$  and  $\psi(\pi) = u_0$  we find, in turn,  $c_2 = 0$  and  $c_1 = u_0/\pi$ . Therefore  $\psi(\theta) = \frac{u_0}{\pi}\theta$ .

Now  $u(1, \theta) = v(1, \theta) + \psi(\theta)$  so that  $v(1, \theta) = u_0 - \frac{u_0}{\pi}\theta$ . From

$$v(r, \theta) = \sum_{n=1}^{\infty} A_n r^n \sin n\theta \quad \text{and} \quad v(1, \theta) = \sum_{n=1}^{\infty} A_n \sin n\theta$$

we obtain

$$A_n = \frac{2}{\pi} \int_0^\pi \left( u_0 - \frac{u_0}{\pi}\theta \right) \sin n\theta \, d\theta = \frac{2u_0}{\pi n}.$$

Thus

$$u(r, \theta) = \frac{u_0}{\pi}\theta + \frac{2u_0}{\pi} \sum_{n=1}^{\infty} \frac{r^n}{n} \sin n\theta.$$

### Exercises 13.1

13. We solve

$$\frac{\partial^2 u}{\partial r^2} + \frac{1}{r} \frac{\partial u}{\partial r} + \frac{1}{r^2} \frac{\partial^2 u}{\partial \theta^2} = 0, \quad 0 < \theta < \pi, \quad 0 < r < 2,$$

$$u(2, \theta) = \begin{cases} u_0, & 0 < \theta < \pi/2 \\ 0, & \pi/2 < \theta < \pi \end{cases}$$

$$\left. \frac{\partial u}{\partial \theta} \right|_{\theta=0} = 0, \quad \left. \frac{\partial u}{\partial \theta} \right|_{\theta=\pi} = 0, \quad 0 < r < 2.$$

Proceeding as in Example 1 in the text we obtain the separated differential equations

$$r^2 R'' + rR' - \lambda^2 R = 0$$

$$\Theta'' + \lambda^2 \Theta = 0$$

with solutions

$$\Theta(\theta) = c_1 \cos \lambda \theta + c_2 \sin \lambda \theta$$

$$R(r) = c_3 r^\lambda + c_4 r^{-\lambda}.$$

Applying the boundary conditions  $\Theta'(0) = 0$  and  $\Theta'(\pi) = 0$  we find that  $c_2 = 0$  and  $\lambda = n$  for  $n = 0, 1, 2, \dots$ . Since we want  $R(r)$  to be bounded as  $r \rightarrow 0$  we require  $c_4 = 0$ . Thus

$$u(r, \theta) = A_0 + \sum_{n=1}^{\infty} A_n r^n \cos n\theta.$$

From

$$u(2, \theta) = \begin{cases} u_0, & 0 < \theta < \pi/2 \\ 0, & \pi/2 < \theta < \pi \end{cases} = A_0 + \sum_{n=1}^{\infty} A_n 2^n \cos n\theta$$

we find

$$A_0 = \frac{1}{2} \frac{2}{\pi} \int_0^{\pi/2} u_0 d\theta = \frac{u_0}{2}$$

and

$$2^n A_n = \frac{2u_0}{\pi} \int_0^{\pi/2} \cos n\theta d\theta = \frac{2u_0}{\pi} \frac{\sin n\pi/2}{n}.$$

Therefore

$$u(r, \theta) = \frac{u_0}{2} + \frac{2u_0}{\pi} \sum_{n=1}^{\infty} \frac{1}{n} \left( \sin \frac{n\pi}{2} \right) \left( \frac{r}{2} \right)^n \cos n\theta.$$

14. (a) From Problem 1 in this section, with  $u_0 = 100$ ,

$$u(r, \theta) = 50 + \frac{100}{\pi} \sum_{n=1}^{\infty} \frac{1 - (-1)^n}{n} r^n \sin n\theta.$$

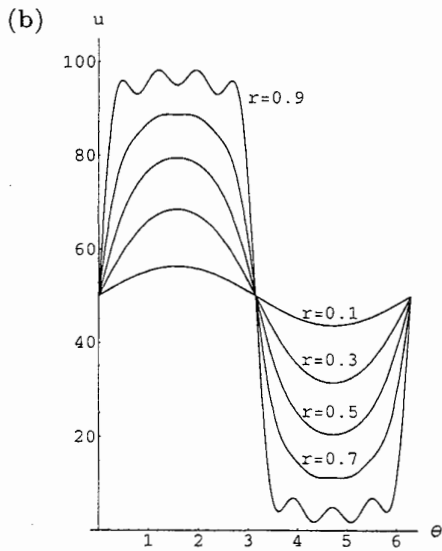

(c) Using a partial sum including the term with  $r^{99}$  we find

$$\begin{array}{ll}
 u(0.9, 1.3) \approx 96.5268 & u(0.9, 2\pi - 1.3) \approx 3.4731 \\
 u(0.7, 2) \approx 87.871 & u(0.7, 2\pi - 2) \approx 12.129 \\
 u(0.5, 3.5) \approx 36.0744 & u(0.5, 2\pi - 3.5) \approx 63.9256 \\
 u(0.3, 4) \approx 35.2674 & u(0.3, 2\pi - 4) \approx 64.7326 \\
 u(0.1, 5.5) \approx 45.4934 & u(0.1, 2\pi - 5.5) \approx 54.5066
 \end{array}$$

(d) At the center of the plate  $u(0, 0) = 50$ . From the graphs in part (b) we observe that the solution curves are symmetric about the point  $(\pi, 50)$ . In part (c) we observe that the horizontal pairs add up to 100, and hence average 50. This is consistent with the observation about part (b), so it is appropriate to say the average temperature in the plate is  $50^\circ$ .

15. Let  $u_1$  be the solution of the boundary-value problem

$$\frac{\partial^2 u_1}{\partial r^2} + \frac{1}{r} \frac{\partial u_1}{\partial r} + \frac{1}{r^2} \frac{\partial^2 u_1}{\partial \theta^2} = 0, \quad 0 < \theta < \pi, \quad a < r < b$$

$$u_1(a, \theta) = f(\theta), \quad 0 < \theta < \pi$$

$$u_1(b, \theta) = 0, \quad 0 < \theta < \pi,$$

and let  $u^2$  be the solution of the boundary-value problem

$$\frac{\partial^2 u_2}{\partial r^2} + \frac{1}{r} \frac{\partial u_2}{\partial r} + \frac{1}{r^2} \frac{\partial^2 u_2}{\partial \theta^2} = 0, \quad 0 < \theta < \pi, \quad a < r < b$$

### Exercises 13.1

$$u_2(a, \theta) = 0, \quad 0 < \theta < \pi$$

$$u_2(b, \theta) = g(\theta), \quad 0 < \theta < \pi.$$

Each of these problems can be solved using the methods shown in Problem 9 of this section. Now if  $u(r, \theta) = u_1(r, \theta) + u_2(r, \theta)$ , then

$$u(a, \theta) = u_1(a, \theta) + u_2(a, \theta) = f(\theta)$$

$$u(b, \theta) = u_1(b, \theta) + u_2(b, \theta) = g(\theta)$$

and  $u(r, \theta)$  will be the steady-state temperature of the circular ring with boundary conditions  $u(a, \theta) = f(\theta)$  and  $u(b, \theta) = g(\theta)$ .

---

### Exercises 13.2

---

1. Referring to the solution of Example 1 in the text we have

$$R(r) = c_1 J_0(\lambda_n r) \quad \text{and} \quad T(t) = c_3 \cos a\lambda_n t + c_4 \sin a\lambda_n t$$

where the eigenvalues  $\lambda_n$  are the positive roots of  $J_0(\lambda c) = 0$ . Now, the initial condition  $u(r, 0) = R(r)T(0) = 0$  implies  $c_3 = 0$ . Thus

$$u(r, t) = \sum_{n=1}^{\infty} A_n \sin a\lambda_n t J_0(\lambda_n r) \frac{\partial u}{\partial t} = \sum_{n=1}^{\infty} a\lambda_n A_n \cos a\lambda_n t J_0(\lambda_n r).$$

From

$$\left. \frac{\partial u}{\partial t} \right|_{t=0} = 1 = \sum_{n=1}^{\infty} a\lambda_n A_n J_0 \lambda_n r$$

we find

$$\begin{aligned} a\lambda_n A_n &= \frac{2}{c^2 J_1^2(\lambda_n c)} \int_0^c r J_0(\lambda_n r) dr && \boxed{x = \lambda_n r, \quad dx = \lambda_n dr} \\ &= \frac{2}{c^2 J_1^2(\lambda_n c)} \int_0^{\lambda_n c} \frac{1}{\lambda_n^2} x J_0(x) dx \\ &= \frac{2}{c^2 J_1^2(\lambda_n c)} \int_0^{\lambda_n c} \frac{1}{\lambda_n^2} \frac{d}{dx} [x J_1(x)] dx && \boxed{\text{see (4) of Section 11.5 in text}} \\ &= \frac{2}{c^2 \lambda_n^2 J_1^2(\lambda_n c)} (x J_1(x)) \Big|_0^{\lambda_n c} = \frac{2}{c \lambda_n J_1(\lambda_n c)}. \end{aligned}$$

Then

$$A_n = \frac{2}{ac \lambda_n^2 J_1(\lambda_n c)}$$



and

$$u(r, t) = \frac{2}{ac} \sum_{n=1}^{\infty} \frac{J_0(\lambda_n r)}{\lambda_n^2 J_1(\lambda_n c)} \sin a \lambda_n t.$$

2. From Example 1 in the text we have  $B_n = 0$  and

$$A_n = \frac{2}{J_1^2(\lambda_n)} \int_0^1 r(1-r^2) J_0(\lambda_n r) dr.$$

From Problem 10, Exercises 11.5 we obtained  $A_n = \frac{4J_2(\lambda_n)}{\lambda_n^2 J_1^2(\lambda_n)}$ . Thus

$$u(r, t) = 4 \sum_{n=1}^{\infty} \frac{J_2(\lambda_n)}{J_1^2(\lambda_n)} \cos a \lambda_n t J_0(\lambda_n r).$$

3. Referring to Example 2 in the text we have

$$R(r) = c_1 J_0(\lambda r) + c_2 Y_0(\lambda r)$$

$$Z(z) = c_3 \cosh \lambda z + c_4 \sinh \lambda z$$

where  $c_2 = 0$  and  $J_0(2\lambda) = 0$  defines the positive eigenvalues  $\lambda_n$ . From  $Z(4) = 0$  we obtain

$$c_3 \cosh 4\lambda_n + c_4 \sinh 4\lambda_n = 0 \quad \text{or} \quad c_4 = -c_3 \frac{\cosh 4\lambda_n}{\sinh 4\lambda_n}.$$

Then

$$\begin{aligned} Z(z) &= c_3 \left[ \cosh \lambda_n z - \frac{\cosh 4\lambda_n}{\sinh 4\lambda_n} \sinh \lambda_n z \right] = c_3 \frac{\sinh 4\lambda_n \cosh \lambda_n z - \cosh 4\lambda_n \sinh \lambda_n z}{\sinh 4\lambda_n} \\ &= c_3 \frac{\sinh \lambda_n (4 - z)}{\sinh 4\lambda_n} \end{aligned}$$

and

$$u(r, z) = \sum_{n=1}^{\infty} A_n \frac{\sinh \lambda_n (4 - z)}{\sinh 4\lambda_n} J_0(\lambda_n r).$$

From

$$u(r, 0) = u_0 = \sum_{n=1}^{\infty} A_n J_0(\lambda_n r)$$

we obtain

$$A_n = \frac{2u_0}{4J_1^2(2\lambda_n)} \int_0^2 r J_0(\lambda_n r) dr = \frac{u_0}{\lambda_n J_1(2\lambda_n)}.$$

Thus the temperature in the cylinder is

$$u(r, z) = u_0 \sum_{n=1}^{\infty} \frac{\sinh \lambda_n (4 - z) J_0(\lambda_n r)}{\lambda_n \sinh 4\lambda_n J_1(2\lambda_n)}.$$

### Exercises 13.2

4. (a) The boundary condition  $u_r(2, z) = 0$  implies  $R'(2) = 0$  or  $J'_0(2\lambda) = 0$ . Thus  $\lambda = 0$  is also an eigenvalue and the separated equations are in this case  $rR'' + R' = 0$  and  $z'' = 0$ . The solutions of these equations are then

$$R(r) = c_1 + c_2 \ln r, \quad Z(z) = c_3 z + c_4.$$

Now  $Z(0) = 0$  yields  $c_4 = 0$  and the implicit condition that the temperature is bounded as  $r \rightarrow 0$  demands that we define  $c_2 = 0$ . Using the superposition principle then gives

$$u(r, z) = A_1 z + \sum_{n=2}^{\infty} A_n \sinh \lambda_n z J_0(\lambda_n r). \quad (1)$$

At  $z = 4$  we obtain

$$f(r) = 4A_1 + \sum_{n=2}^{\infty} A_n \sinh 4\lambda_n J_0(\lambda_n r).$$

Thus from (17) and (18) of Section 11.5 in the text we can write with  $b = 2$ ,

$$A_1 = \frac{1}{8} \int_0^2 r f(r) dr \quad (2)$$

$$A_n = \frac{1}{2 \sinh 4\lambda_n J_0^2(2\lambda_n)} \int_0^2 r f(r) J_0(\lambda_n r) dr. \quad (3)$$

A solution of the problem consists of the series (1) with coefficients  $A_1$  and  $A_n$  defined in (2) and (3), respectively.

- (b) When  $f(r) = u_0$  we get  $A_1 = u_0/4$  and

$$A_n = \frac{u_0 J_1(2\lambda_n)}{\lambda_n \sinh 4\lambda_n J_0^2(2\lambda_n)} = 0$$

since  $J'_0(2\lambda) = 0$  is equivalent to  $J_1(2\lambda) = 0$ . A solution of the problem is then  $u(r, z) = \frac{u_0}{4} z$ .

5. Letting  $u(r, t) = R(r)T(t)$  and separating variables we obtain

$$\frac{R'' + \frac{1}{r}R'}{R} = \frac{T'}{kT} = \mu \quad \text{and} \quad R'' + \frac{1}{r}R' - \mu R = 0, \quad T' - \mu kT = 0.$$

From the second equation we find  $T(t) = e^{\mu kt}$ . If  $\mu > 0$ ,  $T(t)$  increases without bound as  $t \rightarrow \infty$ . Thus we assume  $\mu = -\lambda^2 \leq 0$ . Now

$$R'' + \frac{1}{r}R' + \lambda^2 R = 0$$

is a parametric Bessel equation with solution

$$R(r) = c_1 J_0(\lambda r) + c_2 Y_0(\lambda r).$$

Since  $Y_0$  is unbounded as  $r \rightarrow 0$  we take  $c_2 = 0$ . Then  $R(r) = c_1 J_0(\lambda r)$  and the boundary condition

Exercises 13.2

$u(c, t) = R(c)T(t) = 0$  implies  $J_0(\lambda c) = 0$ . This latter equation defines the positive eigenvalues  $\lambda_n$ .

Thus

$$u(r, t) = \sum_{n=1}^{\infty} A_n J_0(\lambda_n r) e^{-\lambda_n^2 kt}.$$

From

$$u(r, 0) = f(r) = \sum_{n=1}^{\infty} A_n J_0(\lambda_n r)$$

we find

$$A_n = \frac{2}{c^2 J_1^2(\lambda_n c)} \int_0^c r J_0(\lambda_n r) f(r) dr, \quad n = 1, 2, 3, \dots$$

6. If the edge  $r = c$  is insulated we have the boundary condition  $u_r(c, t) = 0$ . Referring to the solution of Problem 5 above we have

$$R'(c) = \lambda c_1 J_0'(\lambda c) = 0$$

which defines an eigenvalue  $\lambda = 0$  and positive eigenvalues  $\lambda_n$ . Thus

$$u(r, t) = A_0 + \sum_{n=1}^{\infty} A_n J_0(\lambda_n r) e^{-\lambda_n^2 kt}.$$

From

$$u(r, 0) = f(r) = A_0 + \sum_{n=1}^{\infty} A_n J_0(\lambda_n r)$$

we find

$$A_0 = \frac{2}{c^2} \int_0^c r f(r) dr$$

$$A_n = \frac{2}{c^2 J_0^2(\lambda_n c)} \int_0^c r J_0(\lambda_n r) f(r) dr.$$

7. Referring to Problem 5 above we have  $T(t) = e^{-\lambda^2 kt}$  and  $R(r) = c_1 J_0(\lambda r)$ . The boundary condition  $hu(1, t) + u_r(1, t) = 0$  implies  $hJ_0(\lambda) + \lambda J_0'(\lambda) = 0$  which defines positive eigenvalues  $\lambda_n$ . Now

$$u(r, t) = \sum_{n=1}^{\infty} A_n J_0(\lambda_n r) e^{-\lambda_n^2 kt}$$

where

$$A_n = \frac{2\lambda_n^2}{(\lambda_n^2 + h^2) J_0^2(\lambda_n)} \int_0^1 r J_0(\lambda_n r) f(r) dr.$$

8. We solve

$$\frac{\partial^2 u}{\partial r^2} + \frac{1}{r} \frac{\partial u}{\partial r} + \frac{\partial^2 u}{\partial z^2} = 0, \quad 0 < r < 1, \quad z > 0$$

$$\left. \frac{\partial u}{\partial r} \right|_{r=1} = -hu(1, z), \quad z > 0$$

$$u(r, 0) = u_0, \quad 0 < r < 1.$$

### Exercises 13.2

assuming  $u = RZ$  we get

$$\frac{R'' + \frac{1}{r}R'}{R} = -\frac{Z''}{Z} = -\lambda^2$$

and so

$$rR'' + R' + \lambda^2 rR = 0 \quad \text{and} \quad Z'' - \lambda^2 Z = 0.$$

Therefore

$$R(r) = c_1 J_0(\lambda r) + c_2 Y_0(\lambda r) \quad \text{and} \quad Z(z) = c_3 e^{-\lambda z} + c_4 e^{\lambda z}.$$

We use the exponential form of the solution of  $Z'' - \lambda^2 Z = 0$  since the domain of the variable  $z$  is a semi-infinite interval. As usual we define  $c_2 = 0$  since the temperature is surely bounded as  $r \rightarrow 0$ . Hence  $R(r) = c_1 J_0(\lambda r)$ . Now the boundary-condition  $u_r(1, z) + hu(1, z) = 0$  is equivalent to

$$\lambda J_0'(\lambda) + hJ_0(\lambda) = 0. \quad (4)$$

The eigenvalues  $\lambda_n$  are the positive roots of (4). Finally, we must now define  $c_4 = 0$  since the temperature is also expected to be bounded as  $z \rightarrow \infty$ . A product solution of the partial differential equation that satisfies the first boundary condition is given by

$$u_n(r, z) = A_n e^{-\lambda_n z} J_0(\lambda_n r).$$

Therefore

$$u(r, z) = \sum_{n=1}^{\infty} A_n e^{-\lambda_n z} J_0(\lambda_n r)$$

is another formal solution. At  $z = 0$  we have  $u_0 = A_n J_0(\lambda_n r)$ . In view of (4) we use (17) and (18) of Section 11.5 in the text with the identification  $b = 1$ :

$$\begin{aligned} A_n &= \frac{2\lambda_n^2}{(\lambda_n^2 + h^2) J_0^2(\lambda_n)} \int_0^1 r J_0(\lambda_n r) u_0 dr \\ &= \frac{2\lambda_n^2 u_0}{(\lambda_n^2 + h^2) J_0^2(\lambda_n) \lambda_n^2} t J_1(t) \Big|_0^{\lambda_n} = \frac{2\lambda_n u_0 J_1(\lambda_n)}{(\lambda_n^2 + h^2) J_0^2(\lambda_n)}. \end{aligned} \quad (5)$$

Since  $J_0' = -J_1$  [see (5) of Section 11.5] it follows from (4) that  $\lambda_n J_1(\lambda_n) = hJ_0(\lambda_n)$ . Thus (5) simplifies to

$$A_n = \frac{2u_0 h}{(\lambda_n^2 + h^2) J_0^2(\lambda_n)}.$$

A solution to the boundary-value problem is then

$$u(r, z) = 2u_0 h \sum_{n=1}^{\infty} \frac{e^{-\lambda_n z}}{(\lambda_n^2 + h^2) J_0(\lambda_n)} J_0(\lambda_n r).$$

9. Substituting  $u(r, t) = v(r, t) + \psi(r)$  into the partial differential equation gives

$$\frac{\partial^2 v}{\partial r^2} + \frac{1}{r} \frac{\partial v}{\partial r} + \psi'' + \frac{1}{r} \psi' = \frac{\partial v}{\partial t}.$$

This equation will be homogeneous provided  $\psi'' + \frac{1}{r}\psi' = 0$  or  $\psi(r) = c_1 \ln r + c_2$ . Since  $\ln r$  is unbounded as  $r \rightarrow 0$  we take  $c_1 = 0$ . Then  $\psi(r) = c_2$  and using  $u(2, t) = v(2, t) + \psi(2) = 100$  we set  $c_2 = \psi(r) = 100$ . Referring to Problem 5 above, the solution of the boundary-value problem

$$\frac{\partial^2 v}{\partial r^2} + \frac{1}{r} \frac{\partial v}{\partial r} = \frac{\partial v}{\partial t}, \quad 0 < r < 2, \quad t > 0,$$

$$v(2, t) = 0, \quad t > 0,$$

$$v(r, 0) = u(r, 0) - \psi(r)$$

is

$$v(r, t) = \sum_{n=1}^{\infty} A_n J_0(\lambda_n r) e^{-\lambda_n^2 t}$$

where

$$\begin{aligned} A_n &= \frac{2}{2J_1^2(2\lambda_n)} \int_0^2 r J_0(\lambda_n r) [u(r, 0) - \psi(r)] dr \\ &= \frac{1}{2J_1^2(2\lambda_n)} \left[ \int_0^1 r J_0(\lambda_n r) [200 - 100] dr + \int_1^2 r J_0(\lambda_n r) [100 - 100] dr \right] \\ &= \frac{50}{J_1^2(2\lambda_n)} \int_0^1 r J_0(\lambda_n r) dr \quad \boxed{x = \lambda_n r, \quad dx = \lambda_n dr} \\ &= \frac{50}{J_1^2(2\lambda_n)} \int_0^{\lambda_n} \frac{1}{\lambda_n^2} x J_0(x) dx \\ &= \frac{50}{\lambda_n^2 J_1^2(2\lambda_n)} \int_0^{\lambda_n} \frac{d}{dx} [x J_1(x)] dx \quad \boxed{\text{see (4) of Section 11.5 in text}} \\ &= \frac{50}{\lambda_n^2 J_1^2(2\lambda_n)} (x J_1(x)) \Big|_0^{\lambda_n} = \frac{50 J_1(\lambda_n)}{\lambda_n J_1^2(2\lambda_n)}. \end{aligned}$$

Thus

$$u(r, t) = v(r, t) + \psi(r) = 100 + 50 \sum_{n=1}^{\infty} \frac{J_1(\lambda_n) J_0(\lambda_n r)}{\lambda_n J_1^2(2\lambda_n)} e^{-\lambda_n^2 t}.$$

10. Letting  $u(r, t) = v(r, t) + \psi(r)$  we obtain  $r\psi'' + \psi' = -\beta r$ . The general solution of this nonhomogeneous equation is found with the aid of variation of parameters:  $\psi = c_1 + c_2 \ln r - \beta \frac{r^2}{4}$ . In order that this solution be bounded as  $r \rightarrow 0$  we define  $c_2 = 0$ . Using  $\psi(1) = 0$  then gives  $c_1 = \frac{\beta}{4}$  and so  $\psi(r) = \frac{\beta}{4}(1 - r^2)$ . Using  $v = RT$  we find that a solution of

$$\frac{\partial^2 v}{\partial r^2} + \frac{1}{r} \frac{\partial v}{\partial r} = \frac{\partial v}{\partial t}, \quad 0 < r < 1, \quad t > 0$$

$$v(1, t) = 0, \quad t > 0$$

### Exercises 13.2

$$v(r, 0) = -\psi(r), \quad 0 < r < 1$$

is

$$v(r, t) = \sum_{n=1}^{\infty} A_n e^{-\lambda_n^2 t} J_0(\lambda_n r)$$

where

$$A_n = -\frac{\beta}{4} \frac{2}{J_1^2(\lambda_n)} \int_0^1 r(1-r^2) J_0(\lambda_n r) dr$$

and the eigenvalues are defined by  $J_0(\lambda) = 0$ . From the result of Problem 10, Exercises 11.5 (see also Problem 2 of this exercise set) we get

$$A_n = -\frac{\beta J_2(\lambda_n)}{\lambda_n^2 J_1^2(\lambda_n)}.$$

Thus from  $u = v + \psi(r)$  it follows that

$$u(r, t) = \frac{\beta}{4}(1-r^2) - \beta \sum_{n=1}^{\infty} \frac{J_2(\lambda_n)}{\lambda_n^2 J_1^2(\lambda_n)} e^{-\lambda_n^2 t} J_0(\lambda_n r).$$

11. (a) Writing the partial differential equation in the form

$$g \left( x \frac{\partial^2 u}{\partial x^2} + \frac{\partial u}{\partial x} \right) = \frac{\partial^2 u}{\partial t^2}$$

and separating variables we obtain

$$\frac{xX'' + X'}{X} = \frac{T''}{gT} = -\lambda^2.$$

Then

$$xX'' + X' + \lambda^2 X = 0 \quad \text{and} \quad T'' + g\lambda^2 T = 0.$$

Letting  $x = \tau^2/4$  in the first equation we obtain  $dx/d\tau = \tau/2$  or  $d\tau/dx = 2\tau$ . Then

$$\frac{dX}{dx} = \frac{dX}{d\tau} \frac{d\tau}{dx} = \frac{2}{\tau} \frac{dX}{d\tau}$$

and

$$\begin{aligned} \frac{d^2 X}{dx^2} &= \frac{d}{dx} \left( \frac{2}{\tau} \frac{dX}{d\tau} \right) = \frac{2}{\tau} \frac{d}{dx} \left( \frac{dX}{d\tau} \right) + \frac{dX}{d\tau} \frac{d}{dx} \left( \frac{2}{\tau} \right) \\ &= \frac{2}{\tau} \frac{d}{d\tau} \left( \frac{dX}{d\tau} \right) \frac{d\tau}{dx} + \frac{dX}{d\tau} \frac{d}{d\tau} \left( \frac{2}{\tau} \right) \frac{d\tau}{dx} = \frac{4}{\tau^2} \frac{d^2 X}{d\tau^2} - \frac{4}{\tau^3} \frac{dX}{d\tau}. \end{aligned}$$

Thus

$$xX'' + X' + \lambda^2 X = \frac{\tau^2}{4} \left( \frac{4}{\tau^2} \frac{d^2 X}{d\tau^2} - \frac{4}{\tau^3} \frac{dX}{d\tau} \right) + \frac{2}{\tau} \frac{dX}{d\tau} + \lambda^2 X = \frac{d^2 X}{d\tau^2} + \frac{1}{\tau} \frac{dX}{d\tau} + \lambda^2 X = 0.$$

This is a parametric Bessel equation with solution

$$X(\tau) = c_1 J_0(\lambda\tau) + c_2 Y_0(\lambda\tau).$$

- (b) To insure a finite solution at  $x = 0$  (and thus  $\tau = 0$ ) we set  $c_2 = 0$ . The condition  $u(L, t) = X(L)T(t) = 0$  implies  $X|_{x=L} = X|_{\tau=2\sqrt{L}} = c_1 J_0(2\lambda\sqrt{L}) = 0$ , which defines positive eigenvalues  $\lambda_n$ . The solution of  $T'' + g\lambda^2 T = 0$  is

$$T(t) = c_3 \cos \lambda_n \sqrt{g} t + c_4 \sin \lambda_n \sqrt{g} t.$$

The boundary condition  $u_t(x, 0) = X(x)T'(0) = 0$  implies  $c_4 = 0$ . Thus

$$u(\tau, t) = \sum_{n=1}^{\infty} A_n \cos \lambda_n \sqrt{g} t J_0(\lambda_n \tau).$$

From

$$u(\tau, 0) = f(\tau^2/4) = \sum_{n=1}^{\infty} A_n J_0(\lambda_n \tau)$$

we find

$$\begin{aligned} A_n &= \frac{2}{(2\sqrt{L})^2 J_1^2(2\lambda_n \sqrt{L})} \int_0^{2\sqrt{L}} \tau J_0(\lambda_n \tau) f(\tau^2/4) d\tau && \boxed{v = \tau/2, dv = d\tau/2} \\ &= \frac{1}{2L J_1^2(2\lambda_n \sqrt{L})} \int_0^{\sqrt{L}} 2v J_0(2\lambda_n v) f(v^2) 2 dv \\ &= \frac{2}{L J_1^2(2\lambda_n \sqrt{L})} \int_0^{\sqrt{L}} v J_0(2\lambda_n v) f(v^2) dv. \end{aligned}$$

12. (a) First we see that

$$\frac{R''\Theta + \frac{1}{r}R'\Theta + \frac{1}{r^2}R\Theta''}{R\Theta} = \frac{T''}{a^2T} = -\lambda^2.$$

This gives  $T'' + a^2\lambda^2T = 0$ . Then from

$$\frac{R'' + \frac{1}{r}R' + \lambda^2R}{-R/r^2} = \frac{\Theta''}{\Theta} = -\nu^2$$

we get  $\Theta'' + \nu^2\Theta = 0$  and  $r^2R'' + rR' + (\lambda^2r^2 - \nu^2)R = 0$ .

- (b) The general solutions of the differential equations in part (a) are

$$T = c_1 \cos a\lambda t + c_2 \sin a\lambda t$$

$$\Theta = c_3 \cos \nu\theta + c_4 \sin \nu\theta$$

$$R = c_5 J_\nu(\lambda r) + c_6 Y_\nu(\lambda r).$$

- (c) Implicitly we expect  $u(r, \theta, t) = u(r, \theta + 2\pi, t)$  and so  $\Theta$  must be  $2\pi$ -periodic. Therefore  $\nu = n$ ,  $n = 0, 1, 2, \dots$ . The corresponding eigenfunctions are  $1, \cos \theta, \cos 2\theta, \dots, \sin \theta, \sin 2\theta, \dots$ . Arguing that  $u(r, \theta, t)$  is bounded as  $r \rightarrow 0$  we then define  $c_6 = 0$  and so  $R = c_3 J_n(\lambda r)$ . But

### Exercises 13.2

$R(c) = 0$  gives  $J_n(\lambda c) = 0$ ; this equation defines the eigenvalues  $\lambda_n$ . For each  $n$ ,  $\lambda_{ni} = x_{ni}/c$ ,  $i = 1, 2, 3, \dots$

$$\begin{aligned} \text{(d)} \quad u(r, \theta, t) &= \sum_{i=1}^n (A_{0i} \cos a\lambda_{0i}t + B_{0i} \sin a\lambda_{0i}t) J_0(\lambda_{0i}r) \\ &+ \sum_{n=1}^{\infty} \sum_{i=1}^{\infty} [(A_{ni} \cos a\lambda_{ni}t + B_{ni} \sin a\lambda_{ni}t) \cos n\theta \\ &+ (C_{ni} \cos a\lambda_{ni}t + D_{ni} \sin a\lambda_{ni}t) \sin n\theta] J_n(\lambda_{ni}r) \end{aligned}$$

13. (a) The boundary-value problem is

$$\begin{aligned} a^2 \left( \frac{\partial^2 u}{\partial r^2} + \frac{1}{r} \frac{\partial u}{\partial r} \right) &= \frac{\partial^2 u}{\partial t^2}, \quad 0 < r < 1, \quad t > 0 \\ u(1, t) &= 0, \quad t > 0 \\ u(r, 0) &= 0, \quad \frac{\partial u}{\partial t} \Big|_{t=0} = \begin{cases} -v_0, & 0 \leq r < b \\ 0, & b \leq r < 1 \end{cases}, \quad 0 < r < 1, \end{aligned}$$

and the solution is

$$u(r, t) = \sum_{n=1}^{\infty} (A_n \cos a\lambda_n t + B_n \sin a\lambda_n t) J_0(\lambda_n r),$$

where the eigenvalues  $\lambda_n$  are defined by  $J_0(\lambda) = 0$  and  $A_n = 0$  since  $f(r) = 0$ . The coefficients  $B_n$  are given by

$$\begin{aligned} B_n &= \frac{2}{a\lambda_n J_1^2(\lambda_n)} \int_0^c r J_0(\lambda_n r) g(r) dr = -\frac{2v_0}{a\lambda_n J_1^2(\lambda_n)} \int_0^b r J_0(\lambda_n r) dr \\ &\quad \boxed{\text{let } x = \lambda_n r} \\ &= -\frac{2v_0}{a\lambda_n J_1^2(\lambda_n)} \int_0^{\lambda_n b} \frac{x}{\lambda_n} J_0(x) \frac{1}{\lambda_n} dx = -\frac{2v_0}{a\lambda_n^3 J_1^2(\lambda_n)} \int_0^{\lambda_n b} x J_0(x) dx \\ &= -\frac{2v_0}{a\lambda_n^3 J_1^2(\lambda_n)} (x J_1(x)) \Big|_0^{\lambda_n b} = -\frac{2v_0}{a\lambda_n^3 J_1(\lambda_n)} (\lambda_n b J_1(\lambda_n b)) \\ &= -\frac{2v_0 b}{a\lambda_n^2} \frac{J_1(\lambda_n b)}{J_1^2(\lambda_n)}. \end{aligned}$$

Thus,

$$u(r, t) = \frac{-2v_0 b}{a} \sum_{n=1}^{\infty} \frac{1}{\lambda_n^2} \frac{J_1(\lambda_n b)}{J_1^2(\lambda_n)} \sin(a\lambda_n t) J_0(\lambda_n r).$$

(b) The standing wave  $u_n(r, t)$  is given by  $u_n(r, t) = B_n \sin(a\lambda_n t) J_0(\lambda_n r)$ , which has frequency  $f_n = a\lambda_n/2\pi$ , where  $\lambda_n$  is the  $n$ th positive zero of  $J_0(x)$ . The fundamental frequency is



Exercises 13.2

$f_1 = a\lambda_1/2\pi$ . The next two frequencies are

$$f_2 = \frac{a\lambda_2}{2\pi} = \frac{\lambda_2}{\lambda_1} \left( \frac{a\lambda_1}{2\pi} \right) = \frac{5.520}{2.405} f_1 = 2.295 f_1$$

and

$$f_3 = \frac{a\lambda_3}{2\pi} = \frac{\lambda_3}{\lambda_1} \left( \frac{a\lambda_1}{2\pi} \right) = \frac{8.654}{2.405} f_1 = 3.598 f_1.$$

(c) With  $a = 1$ ,  $b = \frac{1}{4}$ , and  $v_0 = 1$ , the solution becomes

$$u(r, t) = -\frac{1}{2} \sum_{n=1}^{\infty} \frac{1}{\lambda_n^2} \frac{J_1(\lambda_n/4)}{J_1(\lambda_n)} \sin(\lambda_n t) J_0(\lambda_n r).$$

The graphs of  $S_5(r, t)$  for  $t = 1, 2, 3, 4, 5, 6$  are shown below.

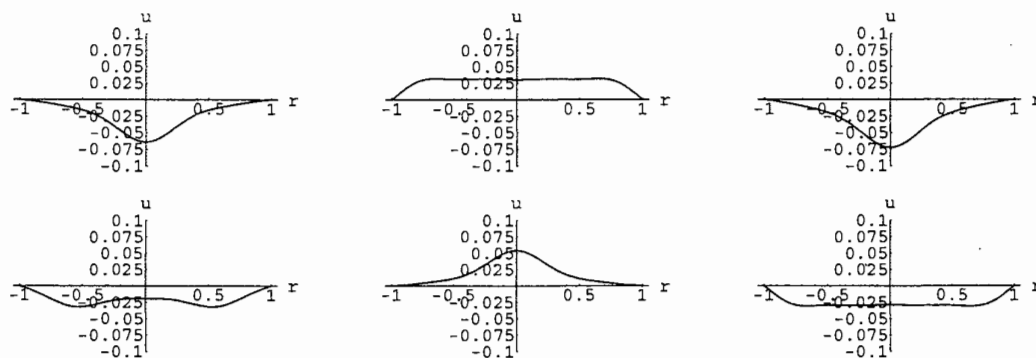

(d) Three frames from the movie are shown.

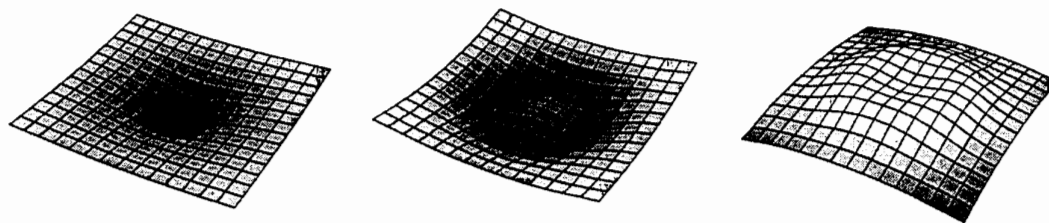

14. (a) We need to solve  $J_0(10\lambda) = 0$ . From the Table 6.2 in Section 6.3 in the text we see that  $\lambda_1 = 0.2405$ ,  $\lambda_2 = 0.5520$ , and  $\lambda_3 = 0.8654$ . Using a CAS to compute  $A_1$  we find:

$$A_1 = \frac{2}{10^2 J_1^2(10\lambda_1)} \int_0^{10} r J_0(\lambda_1 r) (1 - r/10) dr = 0.7845.$$

### Exercises 13.2

In a similar fashion we compute  $A_2 = 0.0687$  and  $A_3 = 0.0531$ . Then, from Example 1 in the text with  $a = 1$  and  $g(r) = 0$  [so that  $B_n = 0$ ] we have

$$\begin{aligned} u(r, t) &\approx \sum_{n=1}^3 A_n (\cos \lambda_n t) J_0(\lambda_n r) \\ &= 0.7845 \cos(0.2405t) J_0(0.2405r) + 0.0687 \cos(0.5520t) J_0(0.5520r) \\ &\quad + 0.0531 \cos(0.8654t) J_0(0.8654r). \end{aligned}$$

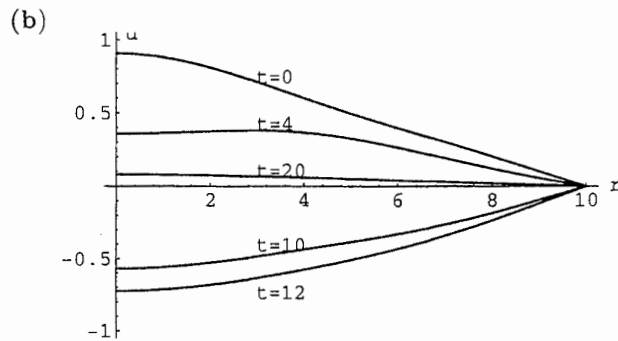

15. Because of the nonhomogeneous boundary condition  $u(c, t) = 200$  we use the substitution  $u(r, t) = v(r, t) + \psi(r)$ . This gives

$$k \left( \frac{\partial^2 v}{\partial r^2} + \frac{1}{r} \frac{\partial v}{\partial r} + \psi'' + \frac{1}{r} \psi' \right) = \frac{\partial v}{\partial t}.$$

This equation will be homogeneous provided  $\psi'' + (1/r)\psi' = 0$  or  $\psi(r) = c_1 \ln r + c_2$ . Since  $\ln r$  is unbounded as  $r \rightarrow 0$  we take  $c_1 = 0$ . Then  $\psi(r) = c_2$  and using  $u(c, t) = v(c, t) + c_2 = 200$  we set  $c_2 = 200$ , giving  $v(c, t) = 0$ . Referring to Problem 5 in this section, the solution of the boundary-value problem

$$k \left( \frac{\partial^2 v}{\partial r^2} + \frac{1}{r} \frac{\partial v}{\partial r} \right) = \frac{\partial v}{\partial t}, \quad 0 < r < c, \quad t > 0$$

$$v(c, t) = 0, \quad t > 0$$

$$v(r, 0) = -200, \quad 0 < r < c$$

is

$$v(r, t) = \sum_{n=1}^{\infty} A_n J_0(\lambda_n r) e^{-\lambda_n^2 kt},$$

where the eigenvalues  $\lambda_n$  are defined by  $J_0(\lambda_n c) = 0$ , and

$$A_n = \frac{2}{c^2 J_1^2(\lambda_n c)} \int_0^c r J_0(\lambda_n r) (-200) dr = -\frac{400}{c^2 J_1^2(\lambda_n c)} \int_0^c r J_0(\lambda_n r) dr.$$

Then

$$u(r, \theta) = \sum_{n=0}^{\infty} A_n \frac{b^{2n+1} - r^{2n+1}}{b^{2n+1} r^{n+1}} P_n(\cos \theta)$$

where

$$\frac{b^{2n+1} - a^{2n+1}}{b^{2n+1} a^{n+1}} A_n = \frac{2n+1}{2} \int_0^{\pi} f(\theta) P_n(\cos \theta) \sin \theta \, d\theta.$$

6. Referring to Example 1 in the text we have

$$R(r) = c_1 r^n \quad \text{and} \quad \Theta(\theta) = P_n(\cos \theta).$$

Now  $\Theta(\pi/2) = 0$  implies that  $n$  is odd, so

$$u(r, \theta) = \sum_{n=0}^{\infty} A_{2n+1} r^{2n+1} P_{2n+1}(\cos \theta).$$

From

$$u(c, \theta) = f(\theta) = \sum_{n=0}^{\infty} A_{2n+1} c^{2n+1} P_{2n+1}(\cos \theta)$$

we see that

$$A_{2n+1} c^{2n+1} = (4n+3) \int_0^{\pi/2} f(\theta) \sin \theta P_{2n+1}(\cos \theta) \, d\theta.$$

Thus

$$u(r, \theta) = \sum_{n=0}^{\infty} A_{2n+1} r^{2n+1} P_{2n+1}(\cos \theta)$$

where

$$A_{2n+1} = \frac{4n+3}{c^{2n+1}} \int_0^{\pi/2} f(\theta) \sin \theta P_{2n+1}(\cos \theta) \, d\theta.$$

7. Referring to Example 1 in the text we have

$$r^2 R'' + 2r R' - \lambda^2 R = 0$$

$$\sin \theta \Theta'' + \cos \theta \Theta' + \lambda \sin \theta \Theta = 0.$$

Substituting  $x = \cos \theta$ ,  $0 \leq \theta \leq \pi/2$ , the latter equation becomes

$$(1-x^2) \frac{d^2 \Theta}{dx^2} - 2x \frac{d\Theta}{dx} + \lambda^2 \Theta = 0, \quad 0 \leq x \leq 1.$$

Taking the solutions of this equation to be the Legendre polynomials  $P_n(x)$  corresponding to  $\lambda^2 = n(n+1)$  for  $n = 1, 2, 3, \dots$ , we have  $\Theta = P_n(\cos \theta)$ . Since

$$\left. \frac{\partial u}{\partial \theta} \right|_{\theta=\pi/2} = \Theta'(\pi/2) R(r) = 0$$

we have

$$\Theta'(\pi/2) = -(\sin \pi/2) P_n'(\cos \pi/2) = -P_n'(0) = 0.$$

### Exercises 13.3

As noted in the hint,  $P'_n(0) = 0$  only if  $n$  is even. Thus  $\Theta = P_n(\cos \theta)$ ,  $n = 0, 2, 4, \dots$ . As in Example 1,  $R(r) = c_1 r^n$ . Hence

$$u(r, \theta) = \sum_{n=0}^{\infty} A_{2n} r^{2n} P_{2n}(\cos \theta).$$

At  $r = c$ ,

$$f(\theta) = \sum_{n=0}^{\infty} A_{2n} c^{2n} P_{2n}(\cos \theta).$$

Using Problem 17 in Section 11.5, we obtain

$$c^{2n} A_{2n} = (4n + 1) \int_{\pi/2}^0 f(\theta) P_{2n}(\cos \theta) (-\sin \theta) d\theta$$

and

$$A_{2n} = \frac{4n + 1}{c^{2n}} \int_0^{\pi/2} f(\theta) \sin \theta P_{2n}(\cos \theta) d\theta.$$

8. Referring to Example 1 in the text we have

$$R(r) = c_1 r^n + c_2 r^{-(n-1)} \quad \text{and} \quad \Theta(\theta) = P_n(\cos \theta).$$

Since we expect  $u(r, \theta)$  to be bounded as  $r \rightarrow \infty$ , we define  $c_1 = 0$ . Also  $\Theta(\pi/2) = 0$  implies that  $n$  is odd, so

$$u(r, \theta) = \sum_{n=0}^{\infty} A_{2n+1} r^{-2(n+1)} P_{2n+1}(\cos \theta).$$

From

$$u(c, \theta) = f(\theta) = \sum_{n=0}^{\infty} A_{2n+1} c^{-2(n+1)} P_{2n+1}(\cos \theta)$$

we see that

$$A_{2n+1} c^{-2(n+1)} = (4n + 3) \int_0^{\pi/2} f(\theta) \sin \theta P_{2n+1}(\cos \theta) d\theta.$$

Thus

$$u(r, \theta) = \sum_{n=0}^{\infty} A_{2n+1} r^{-2(n+1)} P_{2n+1}(\cos \theta)$$

where

$$A_{2n+1} = (4n + 3) c^{2(n+1)} \int_0^{\pi/2} f(\theta) \sin \theta P_{2n+1}(\cos \theta) d\theta.$$

9. Checking the hint, we find

$$\frac{1}{r} \frac{\partial^2}{\partial r^2}(ru) = \frac{1}{r} \frac{\partial}{\partial r} \left[ r \frac{\partial u}{\partial r} + u \right] = \frac{1}{r} \left[ r \frac{\partial^2 u}{\partial r^2} + \frac{\partial u}{\partial r} + \frac{\partial u}{\partial r} \right] = \frac{\partial^2 u}{\partial r^2} + \frac{2}{r} \frac{\partial u}{\partial r}.$$

The partial differential equation then becomes

$$\frac{\partial^2}{\partial r^2}(ru) = r \frac{\partial u}{\partial t}.$$

Taking  $c = 10$  and  $k = 0.1$  we have

$$u(r, t) = v(r, t) + 200 = 200 + \sum_{n=1}^{\infty} A_n J_0(\lambda_n r) e^{-0.1 \lambda_n^2 t},$$

where the eigenvalues  $\lambda_n$  are defined by  $J_0(10\lambda) = 0$  and

$$A_n = -\frac{4}{J_1^2(10\lambda_n)} \int_0^{10} r J_0(\lambda_n r) dr.$$

Using a CAS we find that the first five eigenvalues are

$$\lambda_1 = 0.240483, \lambda_2 = 0.552008, \lambda_3 = 0.865373, \lambda_4 = 1.17915,$$

and  $\lambda_5 = 1.49309$ . From the graph we see that  $u(5, t) \approx 100$

when  $t = 132$ ,  $u(0, t) \approx 100$  when  $t = 198$ ,  $u(5, t) \approx 200$

when  $t = 808$ , and  $u(0, t) \approx 200$  when  $t = 885$ .

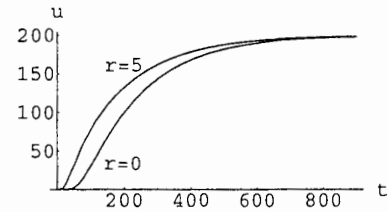

### Exercises 13.3

1. To compute

$$A_n = \frac{2n+1}{2c^n} \int_0^\pi f(\theta) P_n(\cos \theta) \sin \theta d\theta$$

we substitute  $x = \cos \theta$  and  $dx = -\sin \theta d\theta$ . Then

$$A_n = \frac{2n+1}{2c^n} \int_1^{-1} F(x) P_n(x) (-dx) = \frac{2n+1}{2c^n} \int_{-1}^1 F(x) P_n(x) dx$$

where

$$F(x) = \begin{cases} 0, & -1 < x < 0 \\ 50, & 0 < x < 1 \end{cases} = 50 \begin{cases} 0, & -1 < x < 0 \\ 1, & 0 < x < 1 \end{cases}$$

The coefficients  $A_n$  are computed in Example 3 of Section 11.5. Thus

$$\begin{aligned} u(r, \theta) &= \sum_{n=0}^{\infty} A_n r^n P_n(\cos \theta) \\ &= 50 \left[ \frac{1}{2} P_0(\cos \theta) + \frac{3}{4} \left(\frac{r}{c}\right) P_1(\cos \theta) - \frac{7}{16} \left(\frac{r}{c}\right)^3 P_3(\cos \theta) + \frac{11}{32} \left(\frac{r}{c}\right)^5 P_5(\cos \theta) + \dots \right]. \end{aligned}$$

2. In the solution of the Cauchy-Euler equation,

$$R(r) = c_1 r^n + c_2 r^{-(n+1)},$$

we define  $c_1 = 0$  since we expect the potential  $u$  to be bounded as  $r \rightarrow \infty$ . Hence

$$u_n(r, \theta) = A_n r^{-(n+1)} P_n(\cos \theta)$$

$$u(r, \theta) = \sum_{n=0}^{\infty} A_n r^{-(n+1)} P_n(\cos \theta).$$

### Exercises 13.3

When  $r = c$  we have

$$f(\theta) = \sum_{n=0}^{\infty} A_n c^{-(n+1)} P_n(\cos \theta)$$

so that

$$A_n = c^{n+1} \frac{(2n+1)}{2} \int_0^\pi f(\theta) P_n(\cos \theta) \sin \theta d\theta.$$

The solution of the problem is then

$$u(r, \theta) = \sum_{n=0}^{\infty} \left( \frac{2n+1}{2} \int_0^\pi f(\theta) P_n(\cos \theta) \sin \theta d\theta \right) \left( \frac{c}{r} \right)^{n+1} P_n(\cos \theta).$$

3. The coefficients are given by

$$A_n = \frac{2n+1}{2c^n} \int_0^\pi \cos \theta P_n(\cos \theta) \sin \theta d\theta = \frac{2n+1}{2c^n} \int_0^\pi P_1(\cos \theta) P_n(\cos \theta) \sin \theta d\theta$$

$$\boxed{x = \cos \theta, \quad dx = -\sin \theta d\theta}$$

$$= \frac{2n+1}{2c^n} \int_{-1}^1 P_1(x) P_n(x) dx.$$

Since  $P_n(x)$  and  $P_m(x)$  are orthogonal for  $m \neq n$ ,  $A_n = 0$  for  $n \neq 1$  and

$$A_1 = \frac{2(1)+1}{2c^1} \int_{-1}^1 P_1(x) P_1(x) dx = \frac{3}{2c} \int_{-1}^1 x^2 dx = \frac{1}{c}.$$

Thus

$$u(r, \theta) = \frac{r}{c} P_1(\cos \theta) = \frac{r}{c} \cos \theta.$$

4. The coefficients are given by

$$A_n = \frac{2n+1}{2c^n} \int_0^\pi (1 - \cos 2\theta) P_n(\cos \theta) \sin \theta d\theta.$$

These were computed in Problem 16 of Section 11.5. Thus

$$u(r, \theta) = \frac{4}{3} P_0(\cos \theta) - \frac{4}{3} \left( \frac{r}{c} \right)^2 P_2(\cos \theta).$$

5. Referring to Example 1 in the text we have

$$\Theta = P_n(\cos \theta) \quad \text{and} \quad R = c_1 r^n + c_2 r^{-(n+1)}.$$

Since  $u(b, \theta) = R(b)\Theta(\theta) = 0$ ,

$$c_1 b^n + c_2 b^{-(n+1)} = 0 \quad \text{or} \quad c_1 = -c_2 b^{-2n-1},$$

and

$$R(r) = -c_2 b^{-2n-1} r^n + c_2 r^{-(n+1)} = c_2 \left( \frac{b^{2n+1} - r^{2n+1}}{b^{2n+1} r^{n+1}} \right).$$

Now, letting  $ru(r, t) = v(r, t) + \psi(r)$ , since the boundary condition is nonhomogeneous, we obtain

$$\frac{\partial^2}{\partial r^2} [v(r, t) + \psi(r)] = r \frac{\partial}{\partial t} \left[ \frac{1}{r} v(r, t) + \psi(r) \right]$$

or

$$\frac{\partial^2 v}{\partial r^2} + \psi''(r) = \frac{\partial v}{\partial t}.$$

This differential equation will be homogeneous if  $\psi''(r) = 0$  or  $\psi(r) = c_1 r + c_2$ . Now

$$u(r, t) = \frac{1}{r} v(r, t) + \frac{1}{r} \psi(r) \quad \text{and} \quad \frac{1}{r} \psi(r) = c_1 + \frac{c_2}{r}.$$

Since we want  $u(r, t)$  to be bounded as  $r$  approaches 0, we require  $c_2 = 0$ . Then  $\psi(r) = c_1 r$ . When  $r = 1$

$$u(1, t) = v(1, t) + \psi(1) = v(1, t) + c_1 = 100,$$

and we will have the homogeneous boundary condition  $v(1, t) = 0$  when  $c_1 = 100$ . Consequently,  $\psi(r) = 100r$ . The initial condition

$$u(r, 0) = \frac{1}{r} v(r, 0) + \frac{1}{r} \psi(r) = \frac{1}{r} v(r, 0) + 100 = 0$$

implies  $v(r, 0) = -100r$ . We are thus led to solve the new boundary-value problem

$$\frac{\partial^2 v}{\partial r^2} = \frac{\partial v}{\partial t}, \quad 0 < r < 1, \quad t > 0,$$

$$v(1, t) = 0, \quad \lim_{r \rightarrow 0} \frac{1}{r} v(r, t) < \infty,$$

$$v(r, 0) = -100r.$$

Letting  $v(r, t) = R(r)T(t)$  and separating variables leads to

$$R'' + \lambda^2 R = 0 \quad \text{and} \quad T' + \lambda^2 T = 0$$

with solutions

$$R(r) = c_3 \cos \lambda r + c_4 \sin \lambda r \quad \text{and} \quad T(t) = c_5 e^{-\lambda^2 t}.$$

The boundary conditions are equivalent to  $R(1) = 0$  and  $\lim_{r \rightarrow 0} \frac{1}{r} R(r) < \infty$ . Since

$$\lim_{r \rightarrow 0} \frac{1}{r} R(r) = \lim_{r \rightarrow 0} \frac{c_3 \cos \lambda r}{r} + \lim_{r \rightarrow 0} \frac{c_4 \sin \lambda r}{r} = \lim_{r \rightarrow 0} \frac{c_3 \cos \lambda r}{r} + c_4 \lambda < \infty$$

we must have  $c_3 = 0$ . Then  $R(r) = c_4 \sin \lambda r$ , and  $R(1) = 0$  implies  $\lambda = n\pi$  for  $n = 1, 2, 3, \dots$ .

Thus

$$v_n(r, t) = A_n e^{-n^2 \pi^2 t} \sin n\pi r$$

### Exercises 13.3

for  $n = 1, 2, 3, \dots$ . Using the condition  $\lim_{r \rightarrow 0} \frac{1}{r}R(r) < \infty$  it is easily shown that there are no eigenvalues for  $\lambda = 0$ , nor does setting the common constant to  $+\lambda^2$  when separating variables lead to any solutions. Now, by the superposition principle,

$$v(r, t) = \sum_{n=1}^{\infty} A_n e^{-n^2 \pi^2 t} \sin n\pi r.$$

The initial condition  $v(r, 0) = -100r$  implies

$$-100r = \sum_{n=1}^{\infty} A_n \sin n\pi r.$$

This is a Fourier sine series and so

$$\begin{aligned} A_n &= 2 \int_0^1 (-100r \sin n\pi r) dr = -200 \left[ -\frac{r}{n\pi} \cos n\pi r \Big|_0^1 + \int_0^1 \frac{1}{n\pi} \cos n\pi r dr \right] \\ &= -200 \left[ -\frac{\cos n\pi}{n\pi} + \frac{1}{n^2 \pi^2} \sin n\pi r \Big|_0^1 \right] = -200 \left[ -\frac{(-1)^n}{n\pi} \right] = \frac{(-1)^n 200}{n\pi}. \end{aligned}$$

A solution of the problem is thus

$$\begin{aligned} u(r, t) &= \frac{1}{r}v(r, t) + \frac{1}{r}\psi(r) = \frac{1}{r} \sum_{n=1}^{\infty} (-1)^n \frac{20}{n\pi} e^{-n^2 \pi^2 t} \sin n\pi r + \frac{1}{r}(100r) \\ &= \frac{200}{\pi r} \sum_{n=1}^{\infty} \frac{(-1)^n}{n} e^{-n^2 \pi^2 t} \sin n\pi r + 100. \end{aligned}$$

10. Referring to Problem 9 we have

$$\frac{\partial^2 v}{\partial r^2} + \psi''(r) = \frac{\partial v}{\partial t}$$

where  $\psi(r) = c_1 r$ . Since

$$u(r, t) = \frac{1}{r}v(r, t) + \frac{1}{r}\psi(r) = \frac{1}{r}v(r, t) + c_1$$

we have

$$\frac{\partial u}{\partial r} = \frac{1}{r}v_r(r, t) - \frac{1}{r^2}v(r, t).$$

When  $r = 1$ ,

$$\frac{\partial u}{\partial r} \Big|_{r=1} = v_r(1, t) - v(1, t)$$

and

$$\frac{\partial u}{\partial r} \Big|_{r=1} + hu(1, t) = v_r(1, t) - v(1, t) + h[v(1, t) + \psi(1)] = v_r(1, t) + (h-1)v(1, t) + hc_1.$$

Thus the boundary condition

$$\frac{\partial u}{\partial r} \Big|_{r=1} + hu(1, t) = hu_1$$



Exercises 13.3

will be homogeneous when  $hc_1 = hu_1$  or  $c_1 = u_1$ . Consequently  $\psi(r) = u_1 r$ . The initial condition

$$u(r, 0) = \frac{1}{r}v(r, 0) + \frac{1}{r}\psi(r) = \frac{1}{r}v(r, 0) + u_1 = u_0$$

implies  $v(r, 0) = (u_0 - u_1)r$ . We are thus led to solve the new boundary-value problem

$$\begin{aligned} \frac{\partial^2 v}{\partial r^2} &= \frac{\partial v}{\partial t}, & 0 < r < 1, & \quad t > 0, \\ v_r(1, t) + (h - 1)v(1, t) &= 0, & t > 0, \\ \lim_{r \rightarrow 0} \frac{1}{r}v(r, t) &< \infty, \\ v(r, 0) &= (u_0 - u_1)r. \end{aligned}$$

Separating variables as in Problem 9 leads to

$$R(r) = c_3 \cos \lambda r + c_4 \sin \lambda r \quad \text{and} \quad T(t) = c_5 e^{-\lambda^2 t}.$$

The boundary conditions are equivalent to

$$R'(1) + (h - 1)R(1) = 0 \quad \text{and} \quad \lim_{r \rightarrow 0} \frac{1}{r}R(r) < \infty.$$

As in Problem 6 we use the second condition to determine that  $c_3 = 0$  and  $R(r) = c_4 \sin \lambda r$ . Then

$$R'(1) + (h - 1)R(1) = c_4 \lambda \cos \lambda + c_4 (h - 1) \sin \lambda = 0$$

and the eigenvalues  $\lambda_n$  are the consecutive nonnegative roots of  $\tan \lambda = \lambda/(1 - h)$ . Now

$$v(r, t) = \sum_{n=1}^{\infty} A_n e^{-\lambda_n^2 t} \sin \lambda_n r.$$

From

$$v(r, 0) = (u_0 - u_1)r = \sum_{n=1}^{\infty} A_n \sin \lambda_n r$$

we obtain

$$A_n = \frac{\int_0^1 (u_0 - u_1)r \sin \lambda_n r \, dr}{\int_0^1 \sin^2 \lambda_n r \, dr}.$$

We compute the integrals

$$\int_0^1 r \sin \lambda_n r \, dr = \left( \frac{1}{\lambda_n^2} \sin \lambda_n r - \frac{1}{\lambda_n} \cos \lambda_n r \right) \Big|_0^1 = \frac{1}{\lambda_n^2} \sin \lambda_n - \frac{1}{\lambda_n} \cos \lambda_n$$

and

$$\int_0^1 \sin^2 \lambda_n r \, dr = \left( \frac{1}{2} r - \frac{1}{4\lambda_n} \sin 2\lambda_n r \right) \Big|_0^1 = \frac{1}{2} - \frac{1}{4\lambda_n} \sin 2\lambda_n.$$

### Exercises 13.3

Using  $\lambda_n \cos \lambda_n = -(h-1) \sin \lambda_n$  we then have

$$\begin{aligned} A_n &= (u_0 - u_1) \frac{\frac{1}{\lambda_n^2} \sin \lambda_n - \frac{1}{\lambda_n} \cos \lambda_n}{\frac{1}{2} - \frac{1}{4\lambda_n} \sin 2\lambda_n} = (u_0 - u_1) \frac{4 \sin \lambda_n - 4\lambda_n \cos \lambda_n}{2\lambda_n^2 - \lambda_n \sin 2\lambda_n} \\ &= 2(u_0 - u_1) \frac{\sin \lambda_n + (h-1) \sin \lambda_n}{\lambda_n^2 + (h-1) \sin \lambda_n \sin \lambda_n} = 2(u_0 - u_1) h \frac{\sin \lambda_n}{\lambda_n^2 + (h-1) \sin^2 \lambda_n}. \end{aligned}$$

Therefore

$$u(r, t) = \frac{1}{r} v(r, t) + \frac{1}{r} \psi(r) = u_1 + 2(u_0 - u_1) h \sum_{n=1}^{\infty} \frac{\sin \lambda_n \sin \lambda_n r}{r[\lambda_n^2 + (h-1) \sin^2 \lambda_n]} e^{-\lambda_n^2 t}.$$

11. We write the differential equation in the form

$$a^2 \frac{1}{r} \frac{\partial^2}{\partial r^2} (ru) = \frac{\partial^2 u}{\partial t^2} \quad \text{or} \quad a^2 \frac{\partial^2}{\partial r^2} (ru) = r \frac{\partial^2 u}{\partial t^2},$$

and then let  $v(r, t) = ru(r, t)$ . The new boundary-value problem is

$$a^2 \frac{\partial^2 v}{\partial r^2} = \frac{\partial^2 v}{\partial t^2}, \quad 0 < r < c, \quad t > 0$$

$$v(c, t) = 0, \quad t > 0$$

$$v(r, 0) = rf(r), \quad \left. \frac{\partial v}{\partial t} \right|_{t=0} = rg(r).$$

Letting  $v(r, t) = R(r)T(t)$  and separating variables we obtain

$$R'' + \lambda^2 R = 0$$

$$T'' + a^2 \lambda^2 T = 0$$

and

$$R(r) = c_1 \cos \lambda r + c_2 \sin \lambda r$$

$$T(t) = c_3 \cos a\lambda t + c_4 \sin a\lambda t.$$

Since  $u(r, t) = v(r, t)/r$ , in order to insure boundedness at  $r = 0$  we define  $c_1 = 0$ . Then  $R(r) = c_2 \sin \lambda r$  and the condition  $R(c) = 0$  implies  $\lambda = n\pi/c$ . Thus

$$v(r, t) = \sum_{n=1}^{\infty} \left( A_n \cos \frac{n\pi a}{c} t + B_n \sin \frac{n\pi a}{c} t \right) \sin \frac{n\pi}{c} r.$$

From

$$v(r, 0) = rf(r) = \sum_{n=1}^{\infty} A_n \sin \frac{n\pi}{c} r$$

we see that

$$A_n = \frac{2}{c} \int_0^c rf(r) \sin \frac{n\pi}{c} r dr.$$

From

$$\frac{\partial v}{\partial t} \Big|_{t=0} = rg(r) = \sum_{n=1}^{\infty} \left( B_n \frac{n\pi a}{c} \right) \sin \frac{n\pi}{c} r$$

we see that

$$B_n = \frac{c}{n\pi a} \cdot \frac{2}{c} \int_0^c rg(r) \sin \frac{n\pi}{c} r dr = \frac{2}{n\pi a} \int_0^c rg(r) \sin \frac{n\pi}{c} r dr.$$

12. Proceeding as in Example 1 we obtain

$$\Theta(\theta) = P_n(\cos \theta) \quad \text{and} \quad R(r) = c_1 r^n + c_2 r^{-(n+1)}$$

so that

$$u(r, \theta) = \sum_{n=0}^{\infty} (A_n r^n + B_n r^{-(n+1)}) P_n(\cos \theta).$$

To satisfy  $\lim_{r \rightarrow \infty} u(r, \theta) = -Er \cos \theta$  we must have  $A_n = 0$  for  $n = 2, 3, 4, \dots$ . Then

$$\lim_{r \rightarrow \infty} u(r, \theta) = -Er \cos \theta = A_0 \cdot 1 + A_1 r \cos \theta,$$

so  $A_0 = 0$  and  $A_1 = -E$ . Thus

$$u(r, \theta) = -Er \cos \theta + \sum_{n=0}^{\infty} B_n r^{-(n+1)} P_n(\cos \theta).$$

Now

$$u(c, \theta) = 0 = -Ec \cos \theta + \sum_{n=0}^{\infty} B_n c^{-(n+1)} P_n(\cos \theta)$$

so

$$\sum_{n=0}^{\infty} B_n c^{-(n+1)} P_n(\cos \theta) = Ec \cos \theta$$

and

$$B_n c^{-(n+1)} = \frac{2n+1}{2} \int_0^\pi Ec \cos \theta P_n(\cos \theta) \sin \theta d\theta.$$

Now  $\cos \theta = P_1(\cos \theta)$  so, for  $n \neq 1$ ,

$$\int_0^\pi \cos \theta P_n(\cos \theta) \sin \theta d\theta = 0$$

by orthogonality. Thus  $B_n = 0$  for  $n \neq 1$  and

$$B_1 = \frac{3}{2} Ec^3 \int_0^\pi \cos^2 \theta \sin \theta d\theta = Ec^3.$$

Therefore,

$$u(r, \theta) = -Er \cos \theta + Ec^3 r^{-2} \cos \theta.$$

## Chapter 13 Review Exercises

1. We have

$$A_0 = \frac{1}{2\pi} \int_0^\pi u_0 d\theta + \frac{1}{2\pi} \int_\pi^{2\pi} (-u_0) d\theta = 0$$

$$A_n = \frac{1}{c^n \pi} \int_0^\pi u_0 \cos n\theta d\theta + \frac{1}{c^n \pi} \int_\pi^{2\pi} (-u_0) \cos n\theta d\theta = 0$$

$$B_n = \frac{1}{c^n \pi} \int_0^\pi u_0 \sin n\theta d\theta + \frac{1}{c^n \pi} \int_\pi^{2\pi} (-u_0) \sin n\theta d\theta = \frac{2u_0}{c^n n \pi} [1 - (-1)^n]$$

and so

$$u(r, \theta) = \frac{2u_0}{\pi} \sum_{n=1}^{\infty} \frac{1 - (-1)^n}{n} \left(\frac{r}{c}\right)^n \sin n\theta.$$

2. We have

$$A_0 = \frac{1}{2\pi} \int_0^{\pi/2} d\theta + \frac{1}{2\pi} \int_{3\pi/2}^{2\pi} d\theta = \frac{1}{2}$$

$$A_n = \frac{1}{c^n \pi} \int_0^{\pi/2} \cos n\theta d\theta + \frac{1}{c^n \pi} \int_{3\pi/2}^{2\pi} \cos n\theta d\theta = \frac{1}{c^n n \pi} \left[ \sin \frac{n\pi}{2} - \sin \frac{3n\pi}{2} \right]$$

$$B_n = \frac{1}{c^n \pi} \int_0^{\pi/2} \sin n\theta d\theta + \frac{1}{c^n \pi} \int_{3\pi/2}^{2\pi} \sin n\theta d\theta = \frac{1}{c^n n \pi} \left[ \cos \frac{3n\pi}{2} - \cos \frac{n\pi}{2} \right]$$

and so

$$u(r, \theta) = \frac{1}{2} + \frac{1}{\pi} \sum_{n=1}^{\infty} \left(\frac{r}{c}\right)^n \left[ \frac{\sin \frac{n\pi}{2} - \sin \frac{3n\pi}{2}}{n} \cos n\theta + \frac{\cos \frac{3n\pi}{2} - \cos \frac{n\pi}{2}}{n} \sin n\theta \right].$$

3. The conditions  $\Theta(0) = 0$  and  $\Theta(\pi) = 0$  applied to  $\Theta = c_1 \cos \lambda\theta + c_2 \sin \lambda\theta$  give  $c_1 = 0$  and  $\lambda = n$ ,  $n = 1, 2, 3, \dots$ , respectively. Thus we have the Fourier sine-series coefficients

$$A_n = \frac{2}{\pi} \int_0^\pi u_0(\pi\theta - \theta^2) \sin n\theta d\theta = \frac{4u_0}{n^3 \pi} [1 - (-1)^n].$$

Thus

$$u(r, \theta) = \frac{4u_0}{\pi} \sum_{n=1}^{\infty} \frac{1 - (-1)^n}{n^3} r^n \sin n\theta.$$

4. In this case

$$A_n = \frac{2}{\pi} \int_0^\pi \sin \theta \sin n\theta d\theta = \frac{1}{\pi} \int_0^\pi [\cos(1-n)\theta - \cos(1+n)\theta] d\theta = 0, \quad n \neq 1.$$

For  $n = 1$ ,

$$A_1 = \frac{2}{\pi} \int_0^\pi \sin^2 \theta d\theta = \frac{1}{\pi} \int_0^\pi (1 - \cos 2\theta) d\theta = 1.$$

Thus

$$u(r, \theta) = \sum_{n=1}^{\infty} A_n r^n \sin n\theta$$

reduces to

$$u(r, \theta) = r \sin \theta.$$

5. We solve

$$\frac{\partial^2 u}{\partial r^2} + \frac{1}{r} \frac{\partial u}{\partial r} + \frac{1}{r^2} \frac{\partial^2 u}{\partial \theta^2} = 0, \quad 0 < \theta < \frac{\pi}{4}, \quad \frac{1}{2} < r < 1,$$

$$u(r, 0) = 0, \quad u(r, \pi/4) = 0, \quad \frac{1}{2} < r < 1,$$

$$u(1/2, \theta) = u_0, \quad u_r(1, \theta) = 0, \quad 0 < \theta < \frac{\pi}{4}.$$

Proceeding as in Example 1 in Section 13.1 in the text we obtain the separated equations

$$r^2 R'' + rR' - \lambda^2 R = 0$$

$$\Theta'' + \lambda^2 \Theta = 0$$

with solutions

$$\Theta(\theta) = c_1 \cos \lambda\theta + c_2 \sin \lambda\theta$$

$$R(r) = c_3 r^\lambda + c_4 r^{-\lambda}.$$

Applying the boundary conditions  $\Theta(0) = 0$  and  $\Theta(\pi/4) = 0$  gives  $c_1 = 0$  and  $\lambda = 4n$  for  $n = 1, 2, 3, \dots$ . From  $R_r(1) = 0$  we obtain  $c_3 = c_4$ . Therefore

$$u(r, \theta) = \sum_{n=1}^{\infty} A_n (r^{4n} + r^{-4n}) \sin 4n\theta.$$

From

$$u(1/2, \theta) = u_0 = \sum_{n=1}^{\infty} A_n \left( \frac{1}{2^{4n}} + \frac{1}{2^{-4n}} \right) \sin 4n\theta$$

we find

$$A_n \left( \frac{1}{2^{4n}} + \frac{1}{2^{-4n}} \right) = \frac{2}{\pi/4} \int_0^{\pi/4} u_0 \sin 4n\theta \, d\theta = \frac{2u_0}{n\pi} [1 - (-1)^n]$$

or

$$A_n = \frac{2u_0}{n\pi(2^{4n} + 2^{-4n})} [1 - (-1)^n].$$

Thus the steady-state temperature in the plate is

$$u(r, \theta) = \frac{2u_0}{\pi} \sum_{n=1}^{\infty} \frac{[r^{4n} + r^{-4n}][1 - (-1)^n]}{n[2^{4n} + 2^{-4n}]} \sin 4n\theta.$$

## Chapter 13 Review Exercises

6. We solve

$$\frac{\partial^2 u}{\partial r^2} + \frac{1}{r} \frac{\partial u}{\partial r} + \frac{1}{r^2} \frac{\partial^2 u}{\partial \theta^2} = 0, \quad r > 1, \quad 0 < \theta < \pi,$$

$$u(r, 0) = 0, \quad u(r, \pi) = 0, \quad r > 1,$$

$$u(1, \theta) = f(\theta), \quad 0 < \theta < \pi.$$

Separating variables we obtain

$$\Theta(\theta) = c_1 \cos \lambda \theta + c_2 \sin \lambda \theta$$

$$R(r) = c_3 r^\lambda + c_4 r^{-\lambda}.$$

Applying the boundary conditions  $\Theta(0) = 0$ , and  $\Theta(\pi) = 0$  gives  $c_1 = 0$  and  $\lambda = n$  for  $n = 1, 2, 3, \dots$ . Assuming  $f(\theta)$  to be bounded, we expect the solution  $u(r, \theta)$  to also be bounded as  $r \rightarrow \infty$ . This requires that  $c_3 = 0$ . Therefore

$$u(r, \theta) = \sum_{n=1}^{\infty} A_n r^{-n} \sin n\theta.$$

From

$$u(1, \theta) = f(\theta) = \sum_{n=1}^{\infty} A_n \sin n\theta$$

we obtain

$$A_n = \frac{2}{\pi} \int_0^\pi f(\theta) \sin n\theta \, d\theta.$$

7. Letting  $u(r, t) = R(r)T(t)$  and separating variables we obtain

$$\frac{R'' + \frac{1}{r}R' - hR}{R} = \frac{T'}{T} = \mu$$

so

$$R'' + \frac{1}{r}R' - (\mu + h)R = 0 \quad \text{and} \quad T' - \mu T = 0.$$

From the second equation we find  $T(t) = c_1 e^{\mu t}$ . If  $\mu > 0$ ,  $T(t)$  increases without bound as  $t \rightarrow \infty$ . Thus we assume  $\mu \leq 0$ . Since  $h > 0$  we can take  $\mu = -\lambda^2 - h$ . Then

$$R'' + \frac{1}{r}R' + \lambda^2 R = 0$$

is a parametric Bessel equation with solution

$$R(r) = c_1 J_0(\lambda r) + c_2 Y_0(\lambda r).$$

Since  $Y_0$  is unbounded as  $r \rightarrow 0$  we take  $c_2 = 0$ . Then  $R(r) = c_1 J_0(\lambda r)$  and the boundary condition  $u(1, t) = R(1)T(t) = 0$  implies  $J_0(\lambda) = 0$ . This latter equation defines the positive eigenvalues  $\lambda_n$ . Thus

$$u(r, t) = \sum_{n=1}^{\infty} A_n J_0(\lambda_n r) e^{(-\lambda_n^2 - h)t}.$$

From

$$u(r, 0) = 1 = \sum_{n=1}^{\infty} A_n J_0(\lambda_n r)$$

we find

$$\begin{aligned} A_n &= \frac{2}{J_1^2(\lambda_n)} \int_0^1 r J_0(\lambda_n r) dr && \boxed{x = \lambda_n r, dx = \lambda_n dr} \\ &= \frac{2}{J_1^2(\lambda_n)} \int_0^{\lambda_n} \frac{1}{\lambda_n^2} x J_0(x) dx. \end{aligned}$$

From recurrence relation (4) in Section 11.5 of the text we have

$$x J_0(x) = \frac{d}{dx} [x J_1(x)].$$

Then

$$A_n = \frac{2}{\lambda_n^2 J_1^2(\lambda_n)} \int_0^{\lambda_n} \frac{d}{dx} [x J_1(x)] dx = \frac{2}{\lambda_n^2 J_1^2(\lambda_n)} \left( x J_1(x) \right) \Big|_0^{\lambda_n} = \frac{2 \lambda_n J_1(\lambda_n)}{\lambda_n^2 J_1^2(\lambda_n)} = \frac{2}{\lambda_n J_1(\lambda_n)}$$

and

$$u(r, t) = 2e^{-ht} \sum_{n=1}^{\infty} \frac{J_0(\lambda_n r)}{\lambda_n J_1(\lambda_n)} e^{-\lambda_n^2 t}$$

8. Proceeding in the usual manner we find

$$u(r, t) = \sum_{n=1}^{\infty} A_n \cos a \lambda_n t J_0(\lambda_n r)$$

where the eigenvalues are defined by  $J_0(\lambda) = 0$ . Thus the initial condition gives

$$u_0 J_0(x_k r) = \sum_{n=1}^{\infty} A_n J_0(\lambda_n r)$$

and so

$$A_n = \frac{2}{J_1^2(\lambda_n)} \int_0^1 r (u_0 J_0(x_k r)) J_0(\lambda_n r) dr.$$

But  $J_0(\lambda) = 0$  implies that the eigenvalues are the positive zeros of  $J_0$ , that is,  $\lambda_n = x_n$  for  $n = 1, 2, 3, \dots$ . Therefore

$$A_n = \frac{2u_0}{J_1^2(\lambda_n)} \int_0^1 r J_0(\lambda_k r) J_0(\lambda_n r) dr = 0, \quad n \neq k$$

by orthogonality. For  $n = k$ ,

$$A_k = \frac{2u_0}{J_1^2(\lambda_k)} \int_0^1 r J_0^2(\lambda_k r) dr = u_0$$

by (6) of Section 11.5. Thus the solution  $u(r, t)$  reduces to one term when  $n = k$ , and

$$u(r, t) = u_0 \cos a \lambda_k t J_0(\lambda_k r) = u_0 \cos a x_k t J_0(x_k r).$$

### Chapter 13 Review Exercises

9. Referring to Example 2 in Section 13.2 we have

$$R(r) = c_1 J_0(\lambda r) + c_2 Y_0(\lambda r)$$

$$Z(z) = c_3 \cosh \lambda z + c_4 \sinh \lambda z$$

where  $c_2 = 0$  and  $J_0(2\lambda) = 0$  defines the positive eigenvalues  $\lambda_n$ . From  $Z'(0) = 0$  we obtain  $c_4 = 0$ . Then

$$u(r, z) = \sum_{n=1}^{\infty} A_n \cosh \lambda_n z J_0(\lambda_n r).$$

From

$$u(r, 4) = 50 = \sum_{n=1}^{\infty} A_n \cosh 4\lambda_n J_0(\lambda_n r)$$

we obtain (as in Example 1 of Section 13.1)

$$A_n \cosh 4\lambda_n = \frac{2(50)}{4J_1^2(2\lambda_n)} \int_0^2 r J_0(\lambda_n r) dr = \frac{50}{\lambda_n J_1(2\lambda_n)}.$$

Thus the temperature in the cylinder is

$$u(r, z) = 50 \sum_{n=1}^{\infty} \frac{\cosh \lambda_n z J_0(\lambda_n r)}{\lambda_n \cosh 4\lambda_n J_1(2\lambda_n)}.$$

10. Using  $u = RZ$  and  $-\lambda^2$  as a separation constant leads to

$$r^2 R'' + rR' + \lambda^2 r^2 R = 0, \quad R'(1) = 0, \quad \text{and} \quad Z'' - \lambda^2 Z = 0.$$

Thus

$$R(r) = c_1 J_0(\lambda r) + c_2 Y_0(\lambda r)$$

$$Z(z) = c_3 \cosh \lambda z + c_4 \sinh \lambda z$$

for  $\lambda > 0$ . Arguing that  $u(r, z)$  is bounded as  $r \rightarrow 0$  we defined  $c_2 = 0$ . Since the eigenvalues are defined by  $J_0'(\lambda) = 0$  we know that  $\lambda = 0$  is an eigenvalue. The solutions are then

$$R(r) = c_1 + c_2 \ln r \quad \text{and} \quad Z(z) = c_3 z + c_4$$

where  $c_2 = 0$ . Thus a formal solution is

$$u(r, z) = A_0 z + B_0 + \sum_{n=1}^{\infty} (A_n \sinh \lambda_n z + B_n \cosh \lambda_n z) J_0(\lambda_n r).$$



Finally, the specified conditions  $z = 0$  and  $z = 1$  give, in turn,

$$B_0 = 2 \int_0^1 r f(r) dr$$

$$B_n = \frac{2}{J_0^2(\lambda_n)} \int_0^1 r f(r) J_0(\lambda_n r) dr$$

$$A_0 = -B_0 + 2 \int_0^1 r g(r) dr$$

$$A_n = \frac{1}{\sinh \lambda_n} \left[ -B_n \cosh \lambda_n + \frac{2}{J_0^2(\lambda_n)} \int_0^1 r g(r) J_0(\lambda_n r) dr \right].$$

11. Referring to Example 1 in Section 13.3 of the text we have

$$u(r, \theta) = \sum_{n=0}^{\infty} A_n r^n P_n(\cos \theta).$$

For  $x = \cos \theta$

$$u(1, \theta) = \begin{cases} 100 & 0 < \theta < \pi/2 \\ -100 & \pi/2 < \theta < \pi \end{cases} = 100 \begin{cases} -1, & -1 < x < 0 \\ 1, & 0 < x < 1 \end{cases} = g(x).$$

From Problem 20 in Exercise 11.5 we have

$$u(r, \theta) = 100 \left[ \frac{3}{2} r P_1(\cos \theta) - \frac{7}{8} r^3 P_3(\cos \theta) + \frac{11}{16} r^5 P_5(\cos \theta) + \dots \right].$$

12. Since

$$\frac{1}{r} \frac{\partial^2}{\partial r^2}(ru) = \frac{1}{r} \frac{\partial}{\partial r} \left[ r \frac{\partial u}{\partial r} + u \right] = \frac{1}{r} \left[ r \frac{\partial^2 u}{\partial r^2} + \frac{\partial u}{\partial r} + \frac{\partial u}{\partial r} \right] = \frac{\partial^2 u}{\partial r^2} + \frac{2}{r} \frac{\partial u}{\partial r}$$

the differential equation becomes

$$\frac{1}{r} \frac{\partial^2}{\partial r^2}(ru) = \frac{\partial^2 u}{\partial t^2} \quad \text{or} \quad \frac{\partial^2}{\partial r^2}(ru) = r \frac{\partial^2 u}{\partial t^2}.$$

Letting  $v(r, t) = ru(r, t)$  we obtain the boundary-value problem

$$\frac{\partial^2 v}{\partial r^2} = \frac{\partial^2 v}{\partial t^2}, \quad 0 < r < 1, \quad t > 0$$

$$\frac{\partial v}{\partial r} \Big|_{r=1} - v(1, t) = 0, \quad t > 0$$

$$v(r, 0) = r f(r), \quad \frac{\partial v}{\partial t} \Big|_{t=0} = r g(r), \quad 0 < r < 1.$$

If we separate variables using  $v(r, t) = R(r)T(t)$  then we obtain

$$R(r) = c_1 \cos \lambda r + c_2 \sin \lambda r$$

$$T(t) = c_3 \cos \lambda t + c_4 \sin \lambda t.$$

### Chapter 13 Review Exercises

Since  $u(r, t) = v(r, t)/r$ , in order to insure boundedness at  $r = 0$  we define  $c_1 = 0$ . Then  $R(r) = c_2 \sin \lambda r$ . Now the boundary condition  $R'(1) - R(1) = 0$  implies  $\lambda \cos \lambda - \sin \lambda = 0$ . Thus, the eigenvalues  $\lambda_n$  are the positive solutions of  $\tan \lambda = \lambda$ . We now have

$$v_n(r, t) = (A_n \cos \lambda_n t + B_n \sin \lambda_n t) \sin \lambda_n r.$$

For the eigenvalue  $\lambda = 0$ ,

$$R(r) = c_1 r + c_2 \quad \text{and} \quad T(t) = c_3 t + c_4,$$

and boundedness at  $r = 0$  implies  $c_2 = 0$ . We then take

$$v_0(r, t) = A_0 t r + B_0 r$$

so that

$$v(r, t) = A_0 t r + B_0 r + \sum_{n=1}^{\infty} (a_n \cos \lambda_n t + B_n \sin \lambda_n t) \sin \lambda_n r.$$

Now

$$v(r, 0) = r f(r) = B_0 r + \sum_{n=1}^{\infty} A_n \sin \lambda_n r.$$

Since  $\{r, \sin \lambda_n r\}$  is an orthogonal set on  $[0, 1]$ ,

$$\int_0^1 r \sin \lambda_n r \, dr = 0 \quad \text{and} \quad \int_0^1 \sin \lambda_m r \sin \lambda_n r \, dr = 0$$

for  $m \neq n$ . Therefore

$$\int_0^1 r^2 f(r) \, dr = B_0 \int_0^1 r^2 \, dr = \frac{1}{3} B_0$$

and

$$B_0 = 3 \int_0^1 r^2 f(r) \, dr.$$

Also

$$\int_0^1 r f(r) \sin \lambda_n r \, dr = A_n \int_0^1 \sin^2 \lambda_n r \, dr$$

and

$$A_n = \frac{\int_0^1 r f(r) \sin \lambda_n r \, dr}{\int_0^1 \sin^2 \lambda_n r \, dr}.$$

Now

$$\int_0^1 \sin^2 \lambda_n r \, dr = \frac{1}{2} \int_0^1 (1 - \cos 2\lambda_n r) \, dr = \frac{1}{2} \left[ 1 - \frac{\sin 2\lambda_n}{2\lambda_n} \right] = \frac{1}{2} [1 - \cos^2 \lambda_n].$$

Since  $\tan \lambda_n = \lambda_n$ ,

$$1 + \lambda_n^2 = 1 + \tan^2 \lambda_n = \sec^2 \lambda_n = \frac{1}{\cos^2 \lambda_n}$$

and

$$\cos^2 \lambda_n = \frac{1}{1 + \lambda_n^2}.$$

Then

$$\int_0^1 \sin^2 \lambda_n r \, dr = \frac{1}{2} \left[ 1 - \frac{1}{1 + \lambda_n^2} \right] = \frac{\lambda_n^2}{2(1 + \lambda_n^2)}$$

and

$$A_n = \frac{2(1 + \lambda_n^2)}{\lambda_n^2} \int_0^1 r f(r) \sin \lambda_n r \, dr.$$

Similarly, setting

$$\left. \frac{\partial v}{\partial t} \right|_{t=0} = r g(r) = A_0 r + \sum_{n=1}^{\infty} B_n \lambda_n \sin \lambda_n r$$

we obtain

$$A_0 = 3 \int_0^1 r^2 g(r) \, dr$$

and

$$B_n = \frac{2(1 + \lambda_n^2)}{\lambda_n^3} \int_0^1 r g(r) \sin \lambda_n r \, dr.$$

Therefore, since  $v(r, t) = ru(r, t)$  we have

$$u(r, t) = A_0 t + B_0 + \sum_{n=1}^{\infty} (A_n \cos \lambda_n t + B_n \sin \lambda_n t) \frac{\sin \lambda_n r}{r},$$

where the  $\lambda_n$  are solutions of  $\tan \lambda = \lambda$  and

$$A_0 = 3 \int_0^1 r^2 g(r) \, dr$$

$$B_0 = 3 \int_0^1 r^2 f(r) \, dr$$

$$A_n = \frac{2(1 + \lambda_n^2)}{\lambda_n^2} \int_0^1 r f(r) \sin \lambda_n r \, dr$$

$$B_n = \frac{2(1 + \lambda_n^2)}{\lambda_n^3} \int_0^1 r g(r) \sin \lambda_n r \, dr$$

for  $n = 1, 2, 3, \dots$ .

13. We note that the differential equation can be expressed in the form

$$\frac{d}{dx} [xu'] = -\lambda^2 xu.$$

Thus

$$u_n \frac{d}{dx} [xu'_m] = -\lambda_m^2 x u_m u_n$$

and

$$u_m \frac{d}{dx} [xu'_n] = -\lambda_n^2 x u_n u_m.$$

## Chapter 13 Review Exercises

Subtracting we obtain

$$u_n \frac{d}{dx} [xu'_m] - u_m \frac{d}{dx} [xu'_n] = (\lambda_n^2 - \lambda_m^2) xu_m u_n$$

and

$$\int_a^b u_n \frac{d}{dx} [xu'_m] dx - \int_a^b u_m \frac{d}{dx} [xu'_n] dx = (\lambda_n^2 - \lambda_m^2) \int_a^b xu_m u_n dx.$$

Using integration by parts this becomes

$$\begin{aligned} u_n x u'_m \Big|_a^b - \int_a^b x u'_m u'_n dx - u_m x u'_n \Big|_a^b + \int_a^b x u'_n u'_m dx \\ = b[u_n(b)u'_m(b) - u_m(b)u'_n(b)] - a[u_n(a)u'_m(a) - u_m(a)u'_n(a)] \\ = (\lambda_n^2 - \lambda_m^2) \int_a^b xu_m u_n dx. \end{aligned}$$

Since

$$u(x) = Y_0(\lambda a)J_0(\lambda x) - J_0(\lambda a)Y_0(\lambda x)$$

we have

$$u_n(b) = Y_0(\lambda_n a)J_0(\lambda_n b) - J_0(\lambda_n a)Y_0(\lambda_n b) = 0$$

by the definition of the  $\lambda_n$ . Similarly  $u_m(b) = 0$ . Also

$$u_n(a) = Y_0(\lambda a)J_0(\lambda_n a) - J_0(\lambda_n a)Y_0(\lambda a) = 0$$

and  $u_m(a) = 0$ . Therefore

$$\int_a^b xu_m u_n dx = \frac{1}{\lambda_n^2 - \lambda_m^2} (b[u_n(b)u'_m(b) - u_m(b)u'_n(b)] - a[u_n(a)u'_m(a) - u_m(a)u'_n(a)]) = 0$$

and the  $u_n(x)$  are orthogonal with respect to the weight function  $x$ .

14. Letting  $u(r, t) = R(r)T(t)$  and separating variables we obtain

$$rR'' + R' + \lambda^2 rR = 0$$

$$T' + \lambda^2 T = 0,$$

with solutions

$$R(r) = c_1 J_0(\lambda r) + c_2 Y_0(\lambda r)$$

$$T(t) = c_3 e^{-\lambda^2 t}.$$

Now the boundary conditions imply

$$R(a) = 0 = c_1 J_0(\lambda a) + c_2 Y_0(\lambda a)$$

$$R(b) = 0 = c_1 J_0(\lambda b) + c_2 Y_0(\lambda b)$$

so that

$$c_2 = -\frac{c_1 J_0(\lambda a)}{Y_0(\lambda a)}$$

and

$$c_1 J_0(\lambda b) - \frac{c_1 J_0(\lambda a)}{Y_0(\lambda a)} Y_0(\lambda b) = 0$$

or

$$Y_0(\lambda a) J_0(\lambda b) - J_0(\lambda a) Y_0(\lambda b) = 0.$$

This equation defines  $\lambda_n$  for  $n = 1, 2, 3, \dots$ . Now

$$R(r) = c_1 J_0(\lambda r) - c_1 \frac{J_0(\lambda a)}{Y_0(\lambda a)} Y_0(\lambda r) = \frac{c_1}{Y_0(\lambda a)} [Y_0(\lambda a) J_0(\lambda r) - J_0(\lambda a) Y_0(\lambda r)]$$

and

$$u_n(r, t) = A_n [Y_0(\lambda_n a) J_0(\lambda_n r) - J_0(\lambda_n a) Y_0(\lambda_n r)] e^{-\lambda_n^2 t} = A_n u_n(r) e^{-\lambda_n^2 t}.$$

Thus

$$u(r, t) = \sum_{n=1}^{\infty} A_n u_n(r) e^{-\lambda_n^2 t}.$$

From the initial condition

$$u(r, 0) = f(r) = \sum_{n=1}^{\infty} A_n u_n(r)$$

we obtain

$$A_n = \frac{\int_a^b r f(r) u_n(r) dr}{\int_a^b r u_n^2(r) dr}.$$

# 14 Integral Transform Method

## Exercises 14.1

1. (a) The result follows by letting  $\tau = u^2$  or  $u = \sqrt{\tau}$  in  $\operatorname{erf}(\sqrt{t}) = \frac{2}{\sqrt{\pi}} \int_0^{\sqrt{t}} e^{-u^2} du$ .

(b) Using  $\mathcal{L}\{t^{-1/2}\} = \frac{\sqrt{\pi}}{s^{1/2}}$  and the first translation theorem, it follows from the convolution theorem that

$$\begin{aligned} \mathcal{L}\{\operatorname{erf}(\sqrt{t})\} &= \frac{1}{\sqrt{\pi}} \mathcal{L}\left\{\int_0^t \frac{e^{-\tau}}{\sqrt{\tau}} d\tau\right\} = \frac{1}{\sqrt{\pi}} \mathcal{L}\{1\} \mathcal{L}\{t^{-1/2}e^{-t}\} = \frac{1}{\sqrt{\pi}} \frac{1}{s} \mathcal{L}\{t^{-1/2}\} \Big|_{s \rightarrow s+1} \\ &= \frac{1}{\sqrt{\pi}} \frac{1}{s} \frac{\sqrt{\pi}}{\sqrt{s+1}} = \frac{1}{s\sqrt{s+1}}. \end{aligned}$$

2. Since  $\operatorname{erfc}(\sqrt{t}) = 1 - \operatorname{erf}(\sqrt{t})$  we have

$$\mathcal{L}\{\operatorname{erfc}(\sqrt{t})\} = \mathcal{L}\{1\} - \mathcal{L}\{\operatorname{erf}(\sqrt{t})\} = \frac{1}{s} - \frac{1}{s\sqrt{s+1}} = \frac{1}{s} \left[1 - \frac{1}{\sqrt{s+1}}\right].$$

3. By the first translation theorem,

$$\mathcal{L}\{e^t \operatorname{erf}(\sqrt{t})\} = \mathcal{L}\{\operatorname{erf}(\sqrt{t})\} \Big|_{s \rightarrow s-1} = \frac{1}{s\sqrt{s+1}} \Big|_{s \rightarrow s-1} = \frac{1}{\sqrt{s}(s-1)}.$$

4. By the first translation theorem and the result of Problem 2,

$$\begin{aligned} \mathcal{L}\{e^t \operatorname{erfc}(\sqrt{t})\} &= \mathcal{L}\{\operatorname{erfc}(\sqrt{t})\} \Big|_{s \rightarrow s-1} = \left(\frac{1}{s} - \frac{1}{s\sqrt{s+1}}\right) \Big|_{s \rightarrow s-1} = \frac{1}{s-1} - \frac{1}{\sqrt{s}(s-1)} \\ &= \frac{\sqrt{s}-1}{\sqrt{s}(s-1)} = \frac{\sqrt{s}-1}{\sqrt{s}(\sqrt{s+1})(\sqrt{s}-1)} = \frac{1}{\sqrt{s}(\sqrt{s+1})}. \end{aligned}$$

5. From entry 3 in Table 14.1 and the first translation theorem we have

$$\begin{aligned} \mathcal{L}\left\{e^{-Gt/C} \operatorname{erf}\left(\frac{x}{2}\sqrt{\frac{RC}{t}}\right)\right\} &= \mathcal{L}\left\{e^{-Gt/C} \left[1 - \operatorname{erfc}\left(\frac{x}{2}\sqrt{\frac{RC}{t}}\right)\right]\right\} \\ &= \mathcal{L}\{e^{-Gt/C}\} - \mathcal{L}\left\{e^{-Gt/C} \operatorname{erfc}\left(\frac{x}{2}\sqrt{\frac{RC}{t}}\right)\right\} \\ &= \frac{1}{s+G/C} - \frac{e^{-x\sqrt{RC}\sqrt{s}}}{s} \Big|_{s \rightarrow s+G/C} \\ &= \frac{1}{s+G/C} - \frac{e^{-x\sqrt{RC}\sqrt{s+G/C}}}{s+G/C} = \frac{C}{Cs+G} \left(1 - e^{x\sqrt{RCs+RG}}\right). \end{aligned}$$

6. We first compute

$$\begin{aligned} \frac{\sinh a\sqrt{s}}{s \sinh \sqrt{s}} &= \frac{e^{a\sqrt{s}} - e^{-a\sqrt{s}}}{s(e^{\sqrt{s}} - e^{-\sqrt{s}})} = \frac{e^{(a-1)\sqrt{s}} - e^{-(a+1)\sqrt{s}}}{s(1 - e^{-2\sqrt{s}})} \\ &= \frac{e^{(a-1)\sqrt{s}}}{s} [1 + e^{-2\sqrt{s}} + e^{-4\sqrt{s}} + \dots] - \frac{e^{-(a+1)\sqrt{s}}}{s} [1 + e^{-2\sqrt{s}} + e^{-4\sqrt{s}} + \dots] \\ &= \left[ \frac{e^{-(1-a)\sqrt{s}}}{s} + \frac{e^{-(3-a)\sqrt{s}}}{s} + \frac{e^{-(5-a)\sqrt{s}}}{s} + \dots \right] \\ &\quad - \left[ \frac{e^{-(1+a)\sqrt{s}}}{s} + \frac{e^{-(3+a)\sqrt{s}}}{s} + \frac{e^{-(5+a)\sqrt{s}}}{s} + \dots \right] \\ &= \sum_{n=0}^{\infty} \left[ \frac{e^{-(2n+1-a)\sqrt{s}}}{s} - \frac{e^{-(2n+1+a)\sqrt{s}}}{s} \right]. \end{aligned}$$

Then

$$\begin{aligned} \mathcal{L} \left\{ \frac{\sinh a\sqrt{s}}{s \sinh \sqrt{s}} \right\} &= \sum_{n=0}^{\infty} \left[ \mathcal{L} \left\{ \frac{e^{-(2n+1-a)\sqrt{s}}}{s} \right\} - \mathcal{L} \left\{ \frac{e^{-(2n+1+a)\sqrt{s}}}{s} \right\} \right] \\ &= \sum_{n=0}^{\infty} \left[ \operatorname{erfc} \left( \frac{2n+1-a}{2\sqrt{t}} \right) - \operatorname{erfc} \left( \frac{2n+1+a}{2\sqrt{t}} \right) \right] \\ &= \sum_{n=0}^{\infty} \left( \left[ 1 - \operatorname{erf} \left( \frac{2n+1-a}{2\sqrt{t}} \right) \right] - \left[ 1 - \operatorname{erf} \left( \frac{2n+1+a}{2\sqrt{t}} \right) \right] \right) \\ &= \sum_{n=0}^{\infty} \left[ \operatorname{erf} \left( \frac{2n+1+a}{2\sqrt{t}} \right) - \operatorname{erf} \left( \frac{2n+1-a}{2\sqrt{t}} \right) \right]. \end{aligned}$$

7. Taking the Laplace transform of both sides of the equation we obtain

$$\mathcal{L}\{y(t)\} = \mathcal{L}\{1\} - \mathcal{L} \left\{ \int_0^t \frac{y(\tau)}{\sqrt{t-\tau}} d\tau \right\}$$

$$Y(s) = \frac{1}{s} - Y(s) \frac{\sqrt{\pi}}{\sqrt{s}}$$

$$\frac{\sqrt{s} + \sqrt{\pi}}{\sqrt{s}} Y(s) = \frac{1}{s}$$

$$Y(s) = \frac{1}{\sqrt{s}(\sqrt{s} + \sqrt{\pi})}.$$

Thus

$$y(t) = \mathcal{L}^{-1} \left\{ \frac{1}{\sqrt{s}(\sqrt{s} + \sqrt{\pi})} \right\} = e^{\pi t} \operatorname{erfc}(\sqrt{\pi t}). \quad \boxed{\text{By entry 5 in Table 14.1}}$$

### Exercises 14.1

8. Using entries 3 and 5 in Table 14.1, we have

$$\begin{aligned}
 & \mathcal{L}\left\{-e^{ab}e^{b^2t}\operatorname{erfc}\left(b\sqrt{t}+\frac{a}{2\sqrt{t}}\right)+\operatorname{erfc}\left(\frac{a}{2\sqrt{t}}\right)\right\} \\
 &= -\mathcal{L}\left\{e^{ab}e^{b^2t}\operatorname{erfc}\left(b\sqrt{t}+\frac{a}{2\sqrt{t}}\right)\right\}+\mathcal{L}\left\{\frac{a}{2\sqrt{t}}\right\} \\
 &= -\frac{e^{-a\sqrt{s}}}{\sqrt{s}(\sqrt{s}+b)}+\frac{e^{-a\sqrt{s}}}{s} \\
 &= e^{-a\sqrt{s}}\left[\frac{1}{s}-\frac{1}{\sqrt{s}(\sqrt{s}+b)}\right]=e^{-a\sqrt{s}}\left[\frac{1}{s}-\frac{\sqrt{s}}{s(\sqrt{s}+b)}\right] \\
 &= e^{-a\sqrt{s}}\left[\frac{\sqrt{s}+b-\sqrt{s}}{s(\sqrt{s}+b)}\right]=\frac{be^{-a\sqrt{s}}}{s(\sqrt{s}+b)}.
 \end{aligned}$$

9. 
$$\begin{aligned}
 \int_a^b e^{-u^2} du &= \int_a^0 e^{-u^2} du + \int_0^b e^{-u^2} du = \int_0^b e^{-u^2} du - \int_0^a e^{-u^2} du \\
 &= \frac{\sqrt{\pi}}{2}\operatorname{erf}(b) - \frac{\sqrt{\pi}}{2}\operatorname{erf}(a) = \frac{\sqrt{\pi}}{2}[\operatorname{erf}(b) - \operatorname{erf}(a)]
 \end{aligned}$$

10. Since  $f(x) = e^{-x^2}$  is an even function,

$$\int_{-a}^a e^{-u^2} du = 2 \int_0^a e^{-u^2} du.$$

Therefore,

$$\int_{-a}^a e^{-u^2} du = \sqrt{\pi} \operatorname{erf}(a).$$

11. The function  $\operatorname{erf}(x)$  is symmetric with respect to the origin, while  $\operatorname{erfc}(x)$  appears to be symmetric with respect to the point  $(0, 1)$ . From the graph it appears that  $\lim_{x \rightarrow -\infty} \operatorname{erf}(x) = -1$  and  $\lim_{x \rightarrow -\infty} \operatorname{erfc}(x) = 2$ .

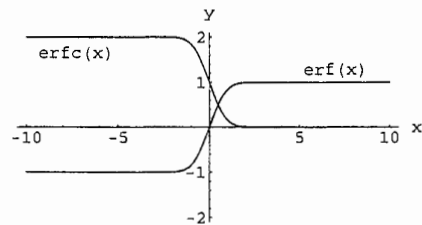



---

**Exercises 14.2**

---

1. The boundary-value problem is

$$\begin{aligned} a^2 \frac{\partial^2 u}{\partial x^2} &= \frac{\partial^2 u}{\partial t^2}, & 0 < x < L, & \quad t > 0, \\ u(0, t) &= 0, & u(L, t) &= 0, & \quad t > 0, \\ u(x, 0) &= A \sin \frac{\pi}{L} x, & \frac{\partial u}{\partial t} \Big|_{t=0} &= 0. \end{aligned}$$

Transforming the partial differential equation gives

$$\frac{d^2 U}{dx^2} - \left(\frac{s}{a}\right)^2 U = -\frac{s}{a^2} A \sin \frac{\pi}{L} x.$$

Using undetermined coefficients we obtain

$$U(x, s) = c_1 \cosh \frac{s}{a} x + c_2 \sinh \frac{s}{a} x + \frac{As}{s^2 + a^2 \pi^2 / L^2} \sin \frac{\pi}{L} x.$$

The transformed boundary conditions,  $U(0, s) = 0$ ,  $U(L, s) = 0$  give in turn  $c_1 = 0$  and  $c_2 = 0$ .

Therefore

$$U(x, s) = \frac{As}{s^2 + a^2 \pi^2 / L^2} \sin \frac{\pi}{L} x$$

and

$$u(x, t) = A \mathcal{L}^{-1} \left\{ \frac{s}{s^2 + a^2 \pi^2 / L^2} \right\} \sin \frac{\pi}{L} x = A \cos \frac{a\pi}{L} t \sin \frac{\pi}{L} x.$$

2. The transformed equation is

$$\frac{d^2 U}{dx^2} - s^2 U = -2 \sin \pi x - 4 \sin 3\pi x$$

and so

$$U(x, s) = c_1 \cosh sx + c_2 \sinh sx + \frac{2}{s^2 + \pi^2} \sin \pi x + \frac{4}{s^2 + 9\pi^2} \sin 3\pi x.$$

The transformed boundary conditions,  $U(0, s) = 0$  and  $U(1, s) = 0$  give  $c_1 = 0$  and  $c_2 = 0$ . Thus

$$U(x, s) = \frac{2}{s^2 + \pi^2} \sin \pi x + \frac{4}{s^2 + 9\pi^2} \sin 3\pi x$$

and

$$\begin{aligned} u(x, t) &= 2 \mathcal{L}^{-1} \left\{ \frac{1}{s^2 + \pi^2} \right\} \sin \pi x + 4 \mathcal{L}^{-1} \left\{ \frac{1}{s^2 + 9\pi^2} \right\} \sin 3\pi x \\ &= \frac{2}{\pi} \sin \pi t \sin \pi x + \frac{4}{3\pi} \sin 3\pi t \sin 3\pi x. \end{aligned}$$

3. The solution of

$$a^2 \frac{d^2 U}{dx^2} - s^2 U = 0$$

### Exercises 14.2

is in this case

$$U(x, s) = c_1 e^{-(x/a)s} + c_2 e^{(x/a)s}.$$

Since  $\lim_{x \rightarrow \infty} u(x, t) = 0$  we have  $\lim_{x \rightarrow \infty} U(x, s) = 0$ . Thus  $c_2 = 0$  and

$$U(x, s) = c_1 e^{-(x/a)s}.$$

If  $\mathcal{L}\{u(0, t)\} = \mathcal{L}\{f(t)\} = F(s)$  then  $U(0, s) = F(s)$ . From this we have  $c_1 = F(s)$  and

$$U(x, s) = F(s)e^{-(x/a)s}.$$

Hence, by the second translation theorem,

$$u(x, t) = f\left(t - \frac{x}{a}\right) \mathcal{U}\left(t - \frac{x}{a}\right).$$

4. Expressing  $f(t)$  in the form  $(\sin \pi t)[1 - \mathcal{U}(t - 1)]$  and using the result of Problem 3 we find

$$\begin{aligned} u(x, t) &= f\left(t - \frac{x}{a}\right) \mathcal{U}\left(t - \frac{x}{a}\right) \\ &= \sin \pi \left(t - \frac{x}{a}\right) \left[1 - \mathcal{U}\left(t - \frac{x}{a} - 1\right)\right] \mathcal{U}\left(t - \frac{x}{a}\right) \\ &= \sin \pi \left(t - \frac{x}{a}\right) \left[\mathcal{U}\left(t - \frac{x}{a}\right) - \mathcal{U}\left(t - \frac{x}{a} - 1\right)\right] \\ &= \sin \pi \left(t - \frac{x}{a}\right) \left[\mathcal{U}\left(t - \frac{x}{a}\right) - \mathcal{U}\left(t - \frac{x}{a} - 1\right)\right] \end{aligned}$$

Now

$$\begin{aligned} \mathcal{U}\left(t - \frac{x}{a}\right) - \mathcal{U}\left(t - \frac{x}{a} - 1\right) &= \begin{cases} 0, & 0 \leq t < x/a \\ 1, & x/a \leq t \leq x/a + 1 \\ 0, & t > x/a + 1 \end{cases} \\ &= \begin{cases} 0, & x < a(t-1) \text{ or } x > at \\ 1, & a(t-1) \leq x \leq at \end{cases} \end{aligned}$$

so

$$u(x, t) = \begin{cases} 0, & x < a(t-1) \text{ or } x > at \\ \sin \pi(t - x/a), & a(t-1) \leq x \leq at. \end{cases}$$

The graph is shown for  $t > 1$ .

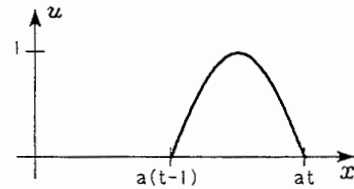

5. We use

$$U(x, s) = c_1 e^{-(x/a)s} - \frac{g}{s^3}.$$

Now

$$\mathcal{L}\{u(0, t)\} = U(0, s) = \frac{A\omega}{s^2 + \omega^2}$$

and so

$$U(0, s) = c_1 - \frac{g}{s^3} = \frac{A\omega}{s^2 + \omega^2} \quad \text{or} \quad c_1 = \frac{g}{s^3} + \frac{A\omega}{s^2 + \omega^2}.$$

Therefore

$$U(x, s) = \frac{A\omega}{s^2 + \omega^2} e^{-(x/a)s} + \frac{g}{s^3} e^{-(x/a)s} - \frac{g}{s^3}$$

and

$$\begin{aligned} u(x, t) &= A\mathcal{L}^{-1}\left\{\frac{\omega e^{-(x/a)s}}{s^2 + \omega^2}\right\} + g\mathcal{L}^{-1}\left\{\frac{e^{-(x/a)s}}{s^3}\right\} - g\mathcal{L}^{-1}\left\{\frac{1}{s^3}\right\} \\ &= A \sin \omega \left(t - \frac{x}{a}\right) \mathcal{U}\left(t - \frac{x}{a}\right) + \frac{1}{2}g \left(t - \frac{x}{a}\right)^2 \mathcal{U}\left(t - \frac{x}{a}\right) - \frac{1}{2}gt^2. \end{aligned}$$

6. Transforming the partial differential equation gives

$$\frac{d^2U}{dx^2} - s^2U = -\frac{\omega}{s^2 + \omega^2} \sin \pi x.$$

Using undetermined coefficients we obtain

$$U(x, s) = c_1 \cosh sx + c_2 \sinh sx + \frac{\omega}{(s^2 + \pi^2)(s^2 + \omega^2)} \sin \pi x.$$

The transformed boundary conditions  $U(0, s) = 0$  and  $U(1, s) = 0$  give, in turn,  $c_1 = 0$  and  $c_2 = 0$ .

Therefore

$$U(x, s) = \frac{\omega}{(s^2 + \pi^2)(s^2 + \omega^2)} \sin \pi x$$

and

$$\begin{aligned} u(x, t) &= \omega \sin \pi x \mathcal{L}^{-1}\left\{\frac{1}{(s^2 + \pi^2)(s^2 + \omega^2)}\right\} \\ &= \frac{\omega}{\omega^2 - \pi^2} \sin \pi x \mathcal{L}^{-1}\left\{\frac{1}{\pi} \frac{\pi}{s^2 + \pi^2} - \frac{1}{\omega} \frac{\omega}{s^2 + \omega^2}\right\} \\ &= \frac{\omega}{\pi(\omega^2 - \pi^2)} \sin \pi t \sin \pi x - \frac{1}{\omega^2 - \pi^2} \sin \omega t \sin \pi x. \end{aligned}$$

7. We use

$$U(x, s) = c_1 \cosh \frac{s}{a} x + c_2 \sinh \frac{s}{a} x.$$

Now  $U(0, s) = 0$  implies  $c_1 = 0$ , so  $U(x, s) = c_2 \sinh(s/a)x$ . The condition  $E \frac{dU}{dx} \Big|_{x=L} = F_0$  then

## Exercises 14.2

yields  $c_2 = F_0 a / Es \cosh(s/a)L$  and so

$$\begin{aligned} U(x, s) &= \frac{aF_0 \sinh(s/a)x}{Es \cosh(s/a)L} = \frac{aF_0}{Es} \frac{e^{(s/a)x} - e^{-(s/a)x}}{e^{(s/a)L} + e^{-(s/a)L}} \\ &= \frac{aF_0}{Es} \frac{e^{(s/a)(x-L)} - e^{-(s/a)(x+L)}}{1 + e^{-2sL/a}} \\ &= \frac{aF_0}{E} \left[ \frac{e^{-(s/a)(L-x)}}{s} - \frac{e^{-(s/a)(3L-x)}}{s} + \frac{e^{-(s/a)(5L-x)}}{s} - \dots \right] \\ &\quad - \frac{aF_0}{E} \left[ \frac{e^{-(s/a)(L+x)}}{s} - \frac{e^{-(s/a)(3L+x)}}{s} + \frac{e^{-(s/a)(5L+x)}}{s} - \dots \right] \\ &= \frac{aF_0}{E} \sum_{n=0}^{\infty} (-1)^n \left[ \frac{e^{-(s/a)(2nL+L-x)}}{s} - \frac{e^{-(s/a)(2nL+L+x)}}{s} \right] \end{aligned}$$

and

$$\begin{aligned} u(x, t) &= \frac{aF_0}{E} \sum_{n=0}^{\infty} (-1)^n \left[ \mathcal{L}^{-1} \left\{ \frac{e^{-(s/a)(2nL+L-x)}}{s} \right\} - \mathcal{L}^{-1} \left\{ \frac{e^{-(s/a)(2nL+L+x)}}{s} \right\} \right] \\ &= \frac{aF_0}{E} \sum_{n=0}^{\infty} (-1)^n \left[ \left( t - \frac{2nL+L-x}{a} \right) \mathcal{U} \left( t - \frac{2nL+L-x}{a} \right) \right. \\ &\quad \left. - \left( t - \frac{2nL+L+x}{a} \right) \mathcal{U} \left( t - \frac{2nL+L+x}{a} \right) \right]. \end{aligned}$$

8. We use

$$U(x, s) = c_1 e^{-(x/a)s} + c_2 e^{(x/a)s} - \frac{v_0}{s^2}.$$

Now  $\lim_{x \rightarrow \infty} \frac{dU}{dx} = 0$  implies  $c_2 = 0$ , and  $U(0, s) = 0$  then gives  $c_1 = v_0/s^2$ . Hence

$$U(x, s) = \frac{v_0}{s^2} e^{-(x/a)s} - \frac{v_0}{s^2}$$

and

$$u(x, t) = v_0 \left( t - \frac{x}{a} \right) \mathcal{U} \left( t - \frac{x}{a} \right) - v_0 t.$$

9. Transforming the partial differential equation gives

$$\frac{d^2 U}{dx^2} - s^2 U = -sxe^{-x}.$$

Using undetermined coefficients we obtain

$$U(x, s) = c_1 e^{-sx} + c_2 e^{sx} - \frac{2s}{(s^2 - 1)^2} e^{-x} + \frac{s}{s^2 - 1} x e^{-x}.$$

The transformed boundary conditions  $\lim_{x \rightarrow \infty} U(x, s) = 0$  and  $U(0, s) = 0$  give, in turn,  $c_2 = 0$  and

$c_1 = 2s/(s^2 - 1)^2$ . Therefore

$$U(x, s) = \frac{2s}{(s^2 - 1)^2} e^{-sx} - \frac{2s}{(s^2 - 1)^2} e^{-x} + \frac{s}{s^2 - 1} x e^{-x}.$$

From entries (13) and (26) in the Table of Laplace transforms we obtain

$$\begin{aligned} u(x, t) &= \mathcal{L}^{-1} \left\{ \frac{2s}{(s^2 - 1)^2} e^{-sx} - \frac{2s}{(s^2 - 1)^2} e^{-x} + \frac{s}{s^2 - 1} x e^{-x} \right\} \\ &= 2(t - x) \sinh(t - x) \mathcal{U}(t - x) - t e^{-x} \sinh t + x e^{-x} \cosh t. \end{aligned}$$

10. We use

$$U(x, s) = c_1 e^{-xs} + c_2 e^{xs} + \frac{s}{s^2 - 1} e^{-x}.$$

Now  $\lim_{x \rightarrow \infty} u(x, t) = 0$  implies  $\lim_{x \rightarrow \infty} U(x, s) = 0$ , so we define  $c_2 = 0$ . Then

$$U(x, s) = c_1 e^{-xs} + \frac{s}{s^2 - 1} e^{-x}.$$

Finally,  $U(0, s) = 1/s$  gives  $c_1 = 1/s - s/(s^2 - 1)$ . Thus

$$U(x, s) = \frac{1}{s} - \frac{s}{s^2 - 1} e^{-xs} + \frac{s}{s^2 - 1} e^{-x}$$

and

$$\begin{aligned} u(x, t) &= -\mathcal{L}^{-1} \left\{ \frac{s}{s^2 - 1} e^{-(x/a)s} \right\} + \mathcal{L}^{-1} \left\{ \frac{s}{s^2 - 1} \right\} e^{-x} \\ &= -\cosh \left( t - \frac{x}{a} \right) \mathcal{U} \left( t - \frac{x}{a} \right) + e^{-x} \cosh t. \end{aligned}$$

11. (a) We use

$$U(x, s) = c_1 e^{-\sqrt{s/k}x} + c_2 e^{\sqrt{s/k}x}.$$

Now  $\lim_{x \rightarrow \infty} u(x, t) = 0$  implies  $\lim_{x \rightarrow \infty} U(x, s) = 0$ , so we define  $c_2 = 0$ . Then

$$U(x, s) = c_1 e^{-\sqrt{s/k}x}.$$

Finally, from  $U(0, s) = u_0/s$  we obtain  $c_1 = u_0/s$ . Thus

$$U(x, s) = u_0 \frac{e^{-\sqrt{s/k}x}}{s}$$

and

$$u(x, t) = u_0 \mathcal{L}^{-1} \left\{ \frac{e^{-\sqrt{s/k}x}}{s} \right\} = u_0 \mathcal{L}^{-1} \left\{ \frac{e^{-(x/\sqrt{k})\sqrt{s}}}{s} \right\} = u_0 \operatorname{erfc} \left( \frac{x}{2\sqrt{kt}} \right).$$

Since  $\operatorname{erfc}(0) = 1$ ,

$$\lim_{t \rightarrow \infty} u(x, t) = \lim_{t \rightarrow \infty} u_0 \operatorname{erfc}(x/2\sqrt{kt}) = u_0.$$

Exercises 14.2

(b)

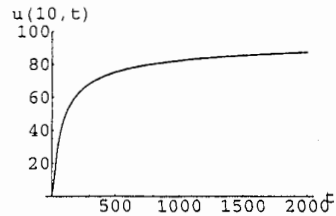
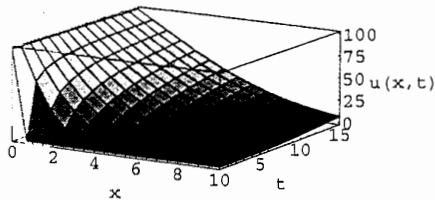

12. (a) Transforming the partial differential equation and using the initial condition gives

$$k \frac{d^2 U}{dx^2} - sU = 0.$$

Since the domain of the variable  $x$  is an infinite interval we write the general solution of this differential equation as

$$U(x, s) = c_1 e^{-\sqrt{s/k}x} + c_2 e^{\sqrt{s/k}x}.$$

Transforming the boundary conditions gives  $U'(0, s) = -A/s$  and  $\lim_{x \rightarrow \infty} U(x, s) = 0$ . Hence we find  $c_2 = 0$  and  $c_1 = A\sqrt{k}/s\sqrt{s}$ . From

$$U(x, s) = A\sqrt{k} \frac{e^{-\sqrt{s/k}x}}{s\sqrt{s}}$$

we see that

$$u(x, t) = A\sqrt{k} \mathcal{L}^{-1} \left\{ \frac{e^{-\sqrt{s/k}x}}{s\sqrt{s}} \right\}.$$

With the identification  $a = x/\sqrt{k}$  it follows from (49) in the Table of Laplace transforms that

$$\begin{aligned} u(x, t) &= A\sqrt{k} \left\{ 2\sqrt{\frac{t}{\pi}} e^{-x^2/4kt} - \frac{x}{\sqrt{k}} \operatorname{erfc}\left(\frac{x}{2\sqrt{kt}}\right) \right\} \\ &= 2A\sqrt{\frac{kt}{\pi}} e^{-x^2/4kt} - Ax \operatorname{erfc}\left(\frac{x}{2\sqrt{kt}}\right). \end{aligned}$$

Since  $\operatorname{erfc}(0) = 1$ ,

$$\lim_{t \rightarrow \infty} u(x, t) = \lim_{t \rightarrow \infty} \left( 2A\sqrt{\frac{kt}{\pi}} e^{-x^2/4kt} - Ax \operatorname{erfc}\left(\frac{x}{2\sqrt{kt}}\right) \right) = \infty.$$

(b)

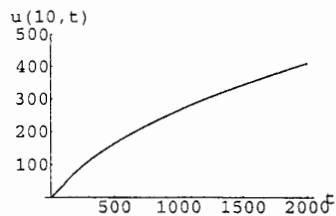
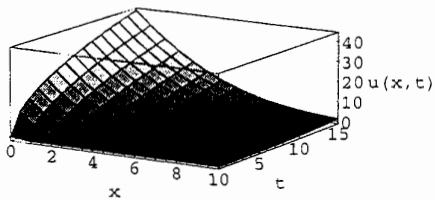

13. We use

$$U(x, s) = c_1 e^{-\sqrt{s}x} + c_2 e^{\sqrt{s}x} + \frac{u_1}{s}.$$

The condition  $\lim_{x \rightarrow \infty} u(x, t) = u_1$  implies  $\lim_{x \rightarrow \infty} U(x, s) = u_1/s$ , so we define  $c_2 = 0$ . Then

$$U(x, s) = c_1 e^{-\sqrt{s}x} + \frac{u_1}{s}.$$

From  $U(0, s) = u_0/s$  we obtain  $c_1 = (u_0 - u_1)/s$ . Thus

$$U(x, s) = (u_0 - u_1) \frac{e^{-\sqrt{s}x}}{s} + \frac{u_1}{s}$$

and

$$u(x, t) = (u_0 - u_1) \mathcal{L}^{-1} \left\{ \frac{e^{-x\sqrt{s}}}{s} \right\} + u_1 \mathcal{L}^{-1} \left\{ \frac{1}{s} \right\} = (u_0 - u_1) \operatorname{erfc} \left( \frac{x}{2\sqrt{t}} \right) + u_1.$$

14. We use

$$U(x, s) = c_1 e^{-\sqrt{s}x} + c_2 e^{\sqrt{s}x} + \frac{u_1 x}{s}.$$

The condition  $\lim_{x \rightarrow \infty} u(x, t)/x = u_1$  implies  $\lim_{x \rightarrow \infty} U(x, s)/x = u_1/s$ , so we define  $c_2 = 0$ . Then

$$U(x, s) = c_1 e^{-\sqrt{s}x} + \frac{u_1 x}{s}.$$

From  $U(0, s) = u_0/s$  we obtain  $c_1 = u_0/s$ . Hence

$$U(x, s) = u_0 \frac{e^{-\sqrt{s}x}}{s} + \frac{u_1 x}{s}$$

and

$$u(x, t) = u_0 \mathcal{L}^{-1} \left\{ \frac{e^{-x\sqrt{s}}}{s} \right\} + u_1 x \mathcal{L}^{-1} \left\{ \frac{1}{s} \right\} = u_0 \operatorname{erfc} \left( \frac{x}{2\sqrt{t}} \right) + u_1 x.$$

15. We use

$$U(x, s) = c_1 e^{-\sqrt{s}x} + c_2 e^{\sqrt{s}x} + \frac{u_0}{s}.$$

The condition  $\lim_{x \rightarrow \infty} u(x, t) = u_0$  implies  $\lim_{x \rightarrow \infty} U(x, s) = u_0/s$ , so we define  $c_2 = 0$ . Then

$$U(x, s) = c_1 e^{-\sqrt{s}x} + \frac{u_0}{s}.$$

The transform of the remaining boundary conditions gives

$$\left. \frac{dU}{dx} \right|_{x=0} = U(0, s).$$

This condition yields  $c_1 = -u_0/s(\sqrt{s} + 1)$ . Thus

$$U(x, s) = -u_0 \frac{e^{-\sqrt{s}x}}{s(\sqrt{s} + 1)} + \frac{u_0}{s}$$

## Exercises 14.2

and

$$\begin{aligned} u(x, t) &= -u_0 \mathcal{L}^{-1} \left\{ \frac{e^{-x\sqrt{s}}}{s(\sqrt{s}+1)} \right\} + u_0 \mathcal{L}^{-1} \left\{ \frac{1}{s} \right\} \\ &= u_0 e^{x+t} \operatorname{erfc} \left( \sqrt{t} + \frac{x}{2\sqrt{t}} \right) - u_0 \operatorname{erfc} \left( \frac{x}{2\sqrt{t}} \right) + u_0 \end{aligned} \quad \boxed{\text{By entry (5) in Table 14.1}}$$

16. We use

$$U(x, s) = c_1 e^{-\sqrt{s}x} + c_2 e^{\sqrt{s}x}.$$

The condition  $\lim_{x \rightarrow \infty} u(x, t) = 0$  implies  $\lim_{x \rightarrow \infty} U(x, s) = 0$ , so we define  $c_2 = 0$ . Hence

$$U(x, s) = c_1 e^{-\sqrt{s}x}.$$

The remaining boundary condition transforms into

$$\left. \frac{dU}{dx} \right|_{x=0} = U(0, s) - \frac{50}{s}.$$

This condition gives  $c_1 = 50/s(\sqrt{s}+1)$ . Therefore

$$U(x, s) = 50 \frac{e^{-\sqrt{s}x}}{s(\sqrt{s}+1)}$$

and

$$u(x, t) = 50 \mathcal{L}^{-1} \left\{ \frac{e^{-x\sqrt{s}}}{s(\sqrt{s}+1)} \right\} = -50 e^{x+t} \operatorname{erfc} \left( \sqrt{t} + \frac{x}{2\sqrt{t}} \right) + 50 \operatorname{erfc} \left( \frac{x}{2\sqrt{t}} \right).$$

17. We use

$$U(x, s) = c_1 e^{-\sqrt{s}x} + c_2 e^{\sqrt{s}x}.$$

The condition  $\lim_{x \rightarrow \infty} u(x, t) = 0$  implies  $\lim_{x \rightarrow \infty} U(x, s) = 0$ , so we define  $c_2 = 0$ . Hence

$$U(x, s) = c_1 e^{-\sqrt{s}x}.$$

The transform of  $u(0, t) = f(t)$  is  $U(0, s) = F(s)$ . Therefore

$$U(x, s) = F(s) e^{-\sqrt{s}x}$$

and

$$u(x, t) = \mathcal{L}^{-1} \left\{ F(s) e^{-x\sqrt{s}} \right\} = \frac{x}{2\sqrt{\pi}} \int_0^t \frac{f(t-\tau) e^{-x^2/4\tau}}{\tau^{3/2}} d\tau.$$

18. We use

$$U(x, s) = c_1 e^{-\sqrt{s}x} + c_2 e^{\sqrt{s}x}.$$

The condition  $\lim_{x \rightarrow \infty} u(x, t) = 0$  implies  $\lim_{x \rightarrow \infty} U(x, s) = 0$ , so we define  $c_2 = 0$ . Then  $U(x, s) = c_1 e^{-\sqrt{s}x}$ . The transform of the remaining boundary condition gives

$$\left. \frac{dU}{dx} \right|_{x=0} = -F(s)$$



### Exercises 14.2

It follows from (1) that

$$\frac{20}{s} - \frac{20}{s}e^{-s} = c_2 + \frac{100}{s} \quad \text{or} \quad c_2 = -\frac{80}{s} - \frac{20}{s}e^{-s}$$

and so

$$\begin{aligned} U(x, s) &= \left(-\frac{80}{s} - \frac{20}{s}e^{-s}\right)e^{-\sqrt{s}x} + \frac{100}{s} \\ &= \frac{100}{s} - \frac{80}{s}e^{-\sqrt{s}x} - \frac{20}{s}e^{-\sqrt{s}x}e^{-s}. \end{aligned}$$

Thus

$$\begin{aligned} u(x, t) &= 100 \mathcal{L}^{-1}\left\{\frac{1}{s}\right\} - 80 \mathcal{L}^{-1}\left\{\frac{e^{-\sqrt{s}x}}{s}\right\} - 20 \mathcal{L}^{-1}\left\{\frac{e^{-\sqrt{s}x}}{s}e^{-s}\right\} \\ &= 100 - 80 \operatorname{erfc}(x/2\sqrt{t}) - 20 \operatorname{erfc}(x/2\sqrt{t-1}) \mathcal{U}(t-1). \end{aligned}$$

21. Transforming the partial differential equation gives

$$\frac{d^2U}{dx^2} - sU = 0$$

and so

$$U(x, s) = c_1e^{-\sqrt{s}x} + c_2e^{\sqrt{s}x}.$$

The condition  $\lim_{x \rightarrow -\infty} u(x, t) = 0$  implies  $\lim_{x \rightarrow -\infty} U(x, s) = 0$ , so we define  $c_1 = 0$ . The transform of the remaining boundary condition gives

$$\left.\frac{dU}{dx}\right|_{x=1} = \frac{100}{s} - U(1, s).$$

This condition yields

$$c_2\sqrt{s}e^{\sqrt{s}} = \frac{100}{s} - c_2e^{\sqrt{s}}$$

from which it follows that

$$c_2 = \frac{100}{s(\sqrt{s}+1)}e^{-\sqrt{s}}.$$

Thus

$$U(x, s) = 100 \frac{e^{-(1-x)\sqrt{s}}}{s(\sqrt{s}+1)}.$$

Using entry (49) in the Table of Laplace transforms we obtain

$$u(x, t) = 100 \mathcal{L}^{-1}\left\{\frac{e^{-(1-x)\sqrt{s}}}{s(\sqrt{s}+1)}\right\} = 100 \left[-e^{1-x+t} \operatorname{erfc}\left(\sqrt{t} + \frac{1-x}{\sqrt{t}}\right) + \operatorname{erfc}\left(\frac{1-x}{2\sqrt{t}}\right)\right].$$

22. Transforming the partial differential equation gives

$$k \frac{d^2U}{dx^2} - sU = -\frac{r}{s}.$$

Exercises 14.2

where  $F(s) = \mathcal{L}\{f(t)\}$ . This condition yields  $c_1 = F(s)/\sqrt{s}$ . Thus

$$U(x, s) = F(s) \frac{e^{-\sqrt{s}x}}{\sqrt{s}}.$$

Using entry (44) in the Table of Laplace transforms and the convolution theorem we obtain

$$u(x, t) = \mathcal{L}^{-1} \left\{ F(s) \cdot \frac{e^{-\sqrt{s}x}}{\sqrt{s}} \right\} = \frac{1}{\sqrt{\pi}} \int_0^t f(\tau) \frac{e^{-x^2/4(t-\tau)}}{\sqrt{t-\tau}} d\tau.$$

19. Transforming the partial differential equation gives

$$\frac{d^2U}{dx^2} - sU = -60.$$

Using undetermined coefficients we obtain

$$U(x, s) = c_1 e^{-\sqrt{s}x} + c_2 e^{\sqrt{s}x} + \frac{60}{s}.$$

The condition  $\lim_{x \rightarrow \infty} u(x, t) = 60$  implies  $\lim_{x \rightarrow \infty} U(x, s) = 60/s$ , so we define  $c_2 = 0$ . The transform of the remaining boundary condition gives

$$U(0, s) = \frac{60}{s} + \frac{40}{s} e^{-2s}.$$

This condition yields  $c_1 = \frac{40}{s} e^{-2s}$ . Thus

$$U(x, s) = \frac{60}{s} + 40e^{-2s} \frac{e^{-\sqrt{s}x}}{s}.$$

Using entry (46) in the Table of Laplace transforms and the second translation theorem we obtain

$$u(x, t) = \mathcal{L}^{-1} \left\{ \frac{60}{s} + 40e^{-2s} \frac{e^{-\sqrt{s}x}}{s} \right\} = 60 + 40 \operatorname{erfc} \left( \frac{x}{2\sqrt{t-2}} \right) \mathcal{U}(t-2).$$

20. The solution of the transformed equation

$$\frac{d^2U}{dx^2} - sU = -100$$

by undetermined coefficients is

$$U(x, s) = c_1 e^{\sqrt{s}x} + c_2 e^{-\sqrt{s}x} + \frac{100}{s}.$$

From the fact that  $\lim_{x \rightarrow \infty} U(x, s) = 100/s$  we see that  $c_1 = 0$ . Thus

$$U(x, s) = c_2 e^{-\sqrt{s}x} + \frac{100}{s}. \tag{1}$$

Now the transform of the boundary condition at  $x = 0$  is

$$U(0, s) = 20 \left[ \frac{1}{s} - \frac{1}{s} e^{-s} \right].$$

Using undetermined coefficients we obtain

$$U(x, s) = c_1 e^{-\sqrt{s/k}x} + c_2 e^{\sqrt{s/k}x} + \frac{r}{s^2}.$$

The condition  $\lim_{x \rightarrow \infty} \frac{\partial u}{\partial x} = 0$  implies  $\lim_{x \rightarrow \infty} \frac{dU}{dx} = 0$ , so we define  $c_2 = 0$ . The transform of the remaining boundary condition gives  $U(0, s) = 0$ . This condition yields  $c_1 = -r/s^2$ . Thus

$$U(x, s) = r \left[ \frac{1}{s^2} - \frac{e^{-\sqrt{s/k}x}}{s^2} \right].$$

Using entries (3) and (46) in the Table of Laplace transforms and the convolution theorem we obtain

$$u(x, t) = r \mathcal{L}^{-1} \left\{ \frac{1}{s^2} - \frac{1}{s} \cdot \frac{e^{-\sqrt{s/k}x}}{s} \right\} = rt - r \int_0^t \operatorname{erfc} \left( \frac{x}{2\sqrt{k\tau}} \right) d\tau.$$

23. The solution of

$$\frac{d^2 U}{dx^2} - sU = -u_0 - u_0 \sin \frac{\pi}{L} x$$

is

$$U(x, s) = c_1 \cosh(\sqrt{s}x) + c_2 \sinh(\sqrt{s}x) + \frac{u_0}{s} + \frac{u_0}{s + \pi^2/L^2} \sin \frac{\pi}{L} x.$$

The transformed boundary conditions  $U(0, s) = u_0/s$  and  $U(L, s) = u_0/s$  give, in turn,  $c_1 = 0$  and  $c_2 = 0$ . Therefore

$$U(x, s) = \frac{u_0}{s} + \frac{u_0}{s + \pi^2/L^2} \sin \frac{\pi}{L} x$$

and

$$u(x, t) = u_0 \mathcal{L}^{-1} \left\{ \frac{1}{s} \right\} + u_0 \mathcal{L}^{-1} \left\{ \frac{1}{s + \pi^2/L^2} \right\} \sin \frac{\pi}{L} x = u_0 + u_0 e^{-\pi^2 t/L^2} \sin \frac{\pi}{L} x.$$

24. The transform of the partial differential equation is

$$k \frac{d^2 U}{dx^2} - hU + h \frac{u_m}{s} = sU - u_0$$

or

$$k \frac{d^2 U}{dx^2} - (h + s)U = -h \frac{u_m}{s} - u_0.$$

By undetermined coefficients we find

$$U(x, s) = c_1 e^{\sqrt{(h+s)/k}x} + c_2 e^{-\sqrt{(h+s)/k}x} + \frac{hu_m + u_0 s}{s(s+h)}.$$

The transformed boundary conditions are  $U'(0, s) = 0$  and  $U'(L, s) = 0$ . These conditions imply  $c_1 = 0$  and  $c_2 = 0$ . By partial fractions we then get

$$U(x, s) = \frac{hu_m + u_0 s}{s(s+h)} = \frac{u_m}{s} - \frac{u_m}{s+h} + \frac{u_0}{s+h}.$$

### Exercises 14.2

Therefore,

$$u(x, t) = u_m \mathcal{L}^{-1}\left\{\frac{1}{s}\right\} - u_m \mathcal{L}^{-1}\left\{\frac{1}{s+h}\right\} + u_0 \mathcal{L}^{-1}\left\{\frac{1}{s+h}\right\} = u_m - u_m e^{-ht} + u_0 e^{-ht}.$$

25. We use

$$U(x, s) = c_1 \cosh \sqrt{\frac{s}{k}} x + c_2 \sinh \sqrt{\frac{s}{k}} x + \frac{u_0}{s}.$$

The transformed boundary conditions  $\frac{dU}{dx} \Big|_{x=0} = 0$  and  $U(1, s) = 0$  give, in turn,  $c_2 = 0$  and  $c_1 = -u_0/s \cosh \sqrt{s/k}$ . Therefore

$$\begin{aligned} U(x, s) &= \frac{u_0}{s} - \frac{u_0 \cosh \sqrt{s/k} x}{s \cosh \sqrt{s/k}} = \frac{u_0}{s} - u_0 \frac{e^{\sqrt{s/k} x} + e^{-\sqrt{s/k} x}}{s(e^{\sqrt{s/k}} + e^{-\sqrt{s/k}})} \\ &= \frac{u_0}{s} - u_0 \frac{e^{\sqrt{s/k}(x-1)} + e^{-\sqrt{s/k}(x+1)}}{s(1 + e^{-2\sqrt{s/k}})} \\ &= \frac{u_0}{s} - u_0 \left[ \frac{e^{-\sqrt{s/k}(1-x)}}{s} - \frac{e^{-\sqrt{s/k}(3-x)}}{s} + \frac{e^{-\sqrt{s/k}(5-x)}}{s} - \dots \right] \\ &\quad - u_0 \left[ \frac{e^{-\sqrt{s/k}(1+x)}}{s} - \frac{e^{-\sqrt{s/k}(3+x)}}{s} + \frac{e^{-\sqrt{s/k}(5+x)}}{s} - \dots \right] \\ &= \frac{u_0}{s} - u_0 \sum_{n=0}^{\infty} (-1)^n \left[ \frac{e^{-(2n+1-x)\sqrt{s}/\sqrt{k}}}{s} + \frac{e^{-(2n+1+x)\sqrt{s}/\sqrt{k}}}{s} \right] \end{aligned}$$

and

$$\begin{aligned} u(x, t) &= u_0 \mathcal{L}^{-1}\left\{\frac{1}{s}\right\} - u_0 \sum_{n=0}^{\infty} (-1)^n \left[ \mathcal{L}^{-1}\left\{\frac{e^{-(2n+1-x)\sqrt{s}/\sqrt{k}}}{s}\right\} - \mathcal{L}^{-1}\left\{\frac{e^{-(2n+1+x)\sqrt{s}/\sqrt{k}}}{s}\right\} \right] \\ &= u_0 - u_0 \sum_{n=0}^{\infty} (-1)^n \left[ \operatorname{erfc}\left(\frac{2n+1-x}{2\sqrt{kt}}\right) - \operatorname{erfc}\left(\frac{2n+1+x}{2\sqrt{kt}}\right) \right]. \end{aligned}$$

26. We use

$$c(x, s) = c_1 \cosh \sqrt{\frac{s}{D}} x + c_2 \sinh \sqrt{\frac{s}{D}} x.$$

The transform of the two boundary conditions are  $c(0, s) = c_0/s$  and  $c(1, s) = c_0/s$ . From these conditions we obtain  $c_1 = c_0/s$  and

$$c_2 = c_0(1 - \cosh \sqrt{s/D})/s \sinh \sqrt{s/D}.$$

Therefore

$$\begin{aligned}
 c(x, s) &= c_0 \left[ \frac{\cosh \sqrt{s/D} x}{s} + \frac{(1 - \cosh \sqrt{s/D})}{s \sinh \sqrt{s/D}} \sinh \sqrt{s/D} x \right] \\
 &= c_0 \left[ \frac{\sinh \sqrt{s/D} (1-x)}{s \sinh \sqrt{s/D}} + \frac{\sin \sqrt{s/D} x}{s \sinh \sqrt{s/D}} \right] \\
 &= c_0 \left[ \frac{e^{\sqrt{s/D}(1-x)} - e^{-\sqrt{s/D}(1-x)}}{s(e^{\sqrt{s/D}} - e^{-\sqrt{s/D}})} + \frac{e^{\sqrt{s/D} x} - e^{-\sqrt{s/D} x}}{s(e^{\sqrt{s/D}} - e^{-\sqrt{s/D}})} \right] \\
 &= c_0 \left[ \frac{e^{-\sqrt{s/D} x} - e^{-\sqrt{s/D}(2-x)}}{s(1 - e^{-2\sqrt{s/D}})} + \frac{e^{\sqrt{s/D}(x-1)} - e^{-\sqrt{s/D}(x+1)}}{s(1 - e^{-2\sqrt{s/D}})} \right] \\
 &= c_0 \frac{(e^{-\sqrt{s/D} x} - e^{-\sqrt{s/D}(2-x)})}{s} \left( 1 + e^{-2\sqrt{s/D}} + e^{-4\sqrt{s/D}} + \dots \right) \\
 &\quad + c_0 \frac{(e^{\sqrt{s/D}(x-1)} - e^{-\sqrt{s/D}(x+1)})}{s} \left( 1 + e^{-2\sqrt{s/D}} + e^{-4\sqrt{s/D}} + \dots \right) \\
 &= c_0 \sum_{n=0}^{\infty} \left[ \frac{e^{-(2n+x)\sqrt{s/D}}}{s} - \frac{e^{-(2n+2-x)\sqrt{s/D}}}{s} \right] \\
 &\quad + c_0 \sum_{n=0}^{\infty} \left[ \frac{e^{-(2n+1-x)\sqrt{s/D}}}{s} - \frac{e^{-(2n+1+x)\sqrt{s/D}}}{s} \right]
 \end{aligned}$$

and

$$\begin{aligned}
 c(x, t) &= c_0 \sum_{n=0}^{\infty} \left[ \mathcal{L}^{-1} \left\{ \frac{e^{-\frac{(2n+x)\sqrt{s}}{\sqrt{D}}}}{s} \right\} - \mathcal{L}^{-1} \left\{ \frac{e^{-\frac{(2n+2-x)\sqrt{s}}{\sqrt{D}}}}{s} \right\} \right] \\
 &\quad + c_0 \sum_{n=0}^{\infty} \left[ \mathcal{L}^{-1} \left\{ \frac{e^{-\frac{(2n+1-x)\sqrt{s}}{\sqrt{D}}}}{s} \right\} - \mathcal{L}^{-1} \left\{ \frac{e^{-\frac{(2n+1+x)\sqrt{s}}{\sqrt{D}}}}{s} \right\} \right] \\
 &= c_0 \sum_{n=0}^{\infty} \left[ \operatorname{erfc} \left( \frac{2n+x}{2\sqrt{Dt}} \right) - \operatorname{erfc} \left( \frac{2n+2-x}{2\sqrt{Dt}} \right) \right] \\
 &\quad + c_0 \sum_{n=0}^{\infty} \left[ \operatorname{erfc} \left( \frac{2n+1-x}{2\sqrt{Dt}} \right) - \operatorname{erfc} \left( \frac{2n+1+x}{2\sqrt{Dt}} \right) \right].
 \end{aligned}$$

## Exercises 14.2

Now using  $\operatorname{erfc}(x) = 1 - \operatorname{erf}(x)$  we get

$$c(x, t) = c_0 \sum_{n=0}^{\infty} \left[ \operatorname{erf} \left( \frac{2n+2-x}{2\sqrt{Dt}} \right) - \operatorname{erf} \left( \frac{2n+x}{2\sqrt{Dt}} \right) \right] \\ + c_0 \sum_{n=0}^{\infty} \left[ \operatorname{erf} \left( \frac{2n+1+x}{2\sqrt{Dt}} \right) - \operatorname{erf} \left( \frac{2n+1-x}{2\sqrt{Dt}} \right) \right].$$

27. We use

$$U(x, s) = c_1 e^{-\sqrt{RCs+RG}x} + c_2 e^{\sqrt{RCs+RG}x} + \frac{Cu_0}{Cs+G}.$$

The condition  $\lim_{x \rightarrow \infty} \partial u / \partial x = 0$  implies  $\lim_{x \rightarrow \infty} dU/dx = 0$ , so we define  $c_2 = 0$ . Applying  $U(0, s) = 0$  to

$$U(x, s) = c_1 e^{-\sqrt{RCsRG}x} + \frac{Cu_0}{Cs+G}$$

gives  $c_1 = -Cu_0/(Cs+G)$ . Therefore

$$U(x, s) = -Cu_0 \frac{e^{-\sqrt{RCsRG}x}}{Cs+G} + \frac{Cu_0}{Cs+G}$$

and

$$u(x, t) = u_0 \mathcal{L}^{-1} \left\{ \frac{1}{s+G/C} \right\} - u_0 \mathcal{L}^{-1} \left\{ \frac{e^{-x\sqrt{RC}\sqrt{s+G/C}}}{s+G/C} \right\} \\ = u_0 e^{-Gt/C} - u_0 e^{-Gt/C} \operatorname{erfc} \left( \frac{x\sqrt{RC}}{2\sqrt{t}} \right) \\ = u_0 e^{-Gt/C} \left[ 1 - \operatorname{erfc} \left( \frac{x}{2} \sqrt{\frac{RC}{t}} \right) \right] \\ = u_0 e^{-Gt/C} \operatorname{erf} \left( \frac{x}{2} \sqrt{\frac{RC}{t}} \right).$$

28. We use

$$U(x, s) = c_1 e^{-\sqrt{s+h}x} + c_2 e^{\sqrt{s+h}x}.$$

The condition  $\lim_{x \rightarrow \infty} u(x, t) = 0$  implies  $\lim_{x \rightarrow \infty} U(x, s) = 0$ , so we take  $c_2 = 0$ . Therefore

$$U(x, s) = c_1 e^{-\sqrt{s+h}x}.$$

The Laplace transform of  $u(0, t) = u_0$  is  $U(0, s) = u_0/s$  and so

$$U(x, s) = u_0 \frac{e^{-\sqrt{s+h}x}}{s}$$

and

$$u(x, t) = u_0 \mathcal{L}^{-1} \left\{ \frac{e^{-\sqrt{s+h}x}}{s} \right\} = u_0 \mathcal{L}^{-1} \left\{ \frac{1}{s} e^{-\sqrt{s+h}x} \right\}.$$

Exercises 14.2

From the first translation theorem,

$$\mathcal{L}^{-1}\{e^{-\sqrt{s+h}x}\} = e^{-ht} \mathcal{L}^{-1}\{e^{-x\sqrt{s}}\} = e^{-ht} \frac{x}{2\sqrt{\pi t^3}} e^{-x^2/4t}.$$

Thus, from the convolution theorem we obtain

$$u(x, s) = \frac{u_0 x}{2\sqrt{\pi}} \int_0^t \frac{e^{-h\tau-x^2/4\tau}}{\tau^{3/2}} d\tau.$$

29. (a) Letting  $C(x, s) = \mathcal{L}\{c(x, t)\}$  we obtain

$$\frac{d^2 C}{dx^2} - \frac{s}{k} C = 0 \quad \text{subject to} \quad \left. \frac{dC}{dx} \right|_{x=0} = -A.$$

The solution of this initial-value problem is

$$C(x, s) = A\sqrt{k} \frac{e^{-(x/\sqrt{k})\sqrt{s}}}{\sqrt{s}},$$

so that

$$c(x, t) = A\sqrt{\frac{k}{\pi t}} e^{-x^2/4kt}.$$

(b)

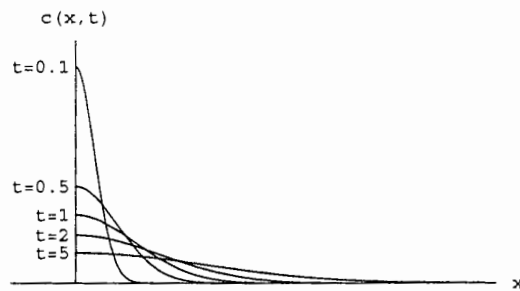

(c)  $\int_0^\infty c(x, t) dx = Ak \operatorname{erf} \frac{x}{2\sqrt{kt}} \Big|_0^\infty = Ak(1 - 0) = Ak$

30. (a) We use

$$U(x, s) = c_1 e^{-(s/a)x} + c_2 e^{(s/a)x} + \frac{v_0^2 F_0}{(a^2 - v_0^2)s^2} e^{-(s/v_0)x}.$$

The condition  $\lim_{x \rightarrow \infty} u(x, t) = 0$  implies  $\lim_{x \rightarrow \infty} U(x, s) = 0$ , so we must define  $c_2 = 0$ .

Consequently

$$U(x, s) = c_1 e^{-(s/a)x} + \frac{v_0^2 F_0}{(a^2 - v_0^2)s^2} e^{-(s/v_0)x}.$$

The remaining boundary condition transforms into  $U(0, s) = 0$ . From this we find

$$c_1 = -v_0^2 F_0 / (a^2 - v_0^2)s^2.$$

## Exercises 14.2

Therefore, by the second translation theorem

$$U(x, s) = -\frac{v_0^2 F_0}{(a^2 - v_0^2)s^2} e^{-(s/a)x} + \frac{v_0^2 F_0}{(a^2 - v_0^2)s^2} e^{-(s/v_0)x}$$

and

$$\begin{aligned} u(x, t) &= \frac{v_0^2 F_0}{a^2 - v_0^2} \left[ \mathcal{L}^{-1} \left\{ \frac{e^{-(x/v_0)s}}{s^2} \right\} - \mathcal{L}^{-1} \left\{ \frac{e^{-(x/a)s}}{s^2} \right\} \right] \\ &= \frac{v_0^2 F_0}{a^2 - v_0^2} \left[ \left( t - \frac{x}{v_0} \right) \eta \left( t - \frac{x}{v_0} \right) - \left( t - \frac{x}{a} \right) \eta \left( t - \frac{x}{a} \right) \right]. \end{aligned}$$

(b) In the case when  $v_0 = a$  the solution of the transformed equation is

$$U(x, s) = c_1 e^{-(s/a)x} + c_2 e^{(s/a)x} - \frac{F_0}{2as} x e^{-(s/a)x}.$$

The usual analysis then leads to  $c_1 = 0$  and  $c_2 = 0$ . Therefore

$$U(x, s) = -\frac{F_0}{2as} x e^{-(s/a)x}$$

and

$$u(x, t) = -\frac{x F_0}{2a} \mathcal{L}^{-1} \left\{ \frac{e^{-(x/a)s}}{s} \right\} = -\frac{x F_0}{2a} \eta \left( t - \frac{x}{a} \right).$$

---

## Exercises 14.3

---

1. From formulas (5) and (6) in the text,

$$A(\alpha) = \int_{-1}^0 (-1) \cos \alpha x \, dx + \int_0^1 (2) \cos \alpha x \, dx = -\frac{\sin \alpha}{\alpha} + 2 \frac{\sin \alpha}{\alpha} = \frac{\sin \alpha}{\alpha}$$

and

$$\begin{aligned} B(\alpha) &= \int_{-1}^0 (-1) \sin \alpha x \, dx + \int_0^1 (2) \sin \alpha x \, dx \\ &= \frac{1 - \cos \alpha}{\alpha} - 2 \frac{\cos \alpha - 1}{\alpha} = \frac{3(1 - \cos \alpha)}{\alpha}. \end{aligned}$$

Hence

$$f(x) = \frac{1}{\pi} \int_0^\infty \frac{\sin \alpha \cos \alpha x + 3(1 - \cos \alpha) \sin \alpha x}{\alpha} d\alpha.$$

2. From formulas (5) and (6) in the text,

$$A(\alpha) = \int_\pi^{2\pi} 4 \cos \alpha x \, dx = 4 \frac{\sin 2\pi\alpha - \sin \pi\alpha}{\alpha}$$

and

$$B(\alpha) = \int_\pi^{2\pi} 4 \sin \alpha x \, dx = 4 \frac{\cos \pi\alpha - \cos 2\pi\alpha}{\alpha}.$$



Hence

$$\begin{aligned} f(x) &= \frac{4}{\pi} \int_0^\infty \frac{(\sin 2\pi\alpha - \sin \pi\alpha) \cos \alpha x + (\cos \pi\alpha - \cos 2\pi\alpha) \sin \alpha x}{\alpha} d\alpha \\ &= \frac{4}{\pi} \int_0^\infty \frac{\sin 2\pi\alpha \cos \alpha x - \cos 2\pi\alpha \sin \alpha x - \sin \pi\alpha \cos \alpha x + \cos \pi\alpha \sin \alpha x}{\alpha} d\alpha \\ &= \frac{4}{\pi} \int_0^\infty \frac{\sin \alpha(2\pi - x) - \sin \alpha(\pi - x)}{\alpha} d\alpha. \end{aligned}$$

3. From formulas (5) and (6) in the text,

$$\begin{aligned} A(\alpha) &= \int_0^3 x \cos \alpha x dx = \frac{x \sin \alpha x}{\alpha} \Big|_0^3 - \frac{1}{\alpha} \int_0^3 \sin \alpha x dx \\ &= \frac{3 \sin 3\alpha}{\alpha} + \frac{\cos \alpha x}{\alpha^2} \Big|_0^3 = \frac{3\alpha \sin 3\alpha + \cos 3\alpha - 1}{\alpha^2} \end{aligned}$$

and

$$\begin{aligned} B(\alpha) &= \int_0^3 x \sin \alpha x dx = -\frac{x \cos \alpha x}{\alpha} \Big|_0^3 + \frac{1}{\alpha} \int_0^3 \cos \alpha x dx \\ &= -\frac{3 \cos 3\alpha}{\alpha} + \frac{\sin \alpha x}{\alpha^2} \Big|_0^3 = \frac{\sin 3\alpha - 3\alpha \cos 3\alpha}{\alpha^2}. \end{aligned}$$

Hence

$$\begin{aligned} f(x) &= \frac{1}{\pi} \int_0^\infty \frac{(3\alpha \sin 3\alpha + \cos 3\alpha - 1) \cos \alpha x + (\sin 3\alpha - 3\alpha \cos 3\alpha) \sin \alpha x}{\alpha^2} d\alpha \\ &= \frac{1}{\pi} \int_0^\infty \frac{3\alpha(\sin 3\alpha \cos \alpha x - \cos 3\alpha \sin \alpha x) + \cos 3\alpha \cos \alpha x + \sin 3\alpha \sin \alpha x - \cos \alpha x}{\alpha^2} d\alpha \\ &= \frac{1}{\pi} \int_0^\infty \frac{3\alpha \sin \alpha(3 - x) + \cos \alpha(3 - x) - \cos \alpha x}{\alpha^2} d\alpha. \end{aligned}$$

4. From formulas (5) and (6) in the text,

$$\begin{aligned} A(\alpha) &= \int_{-\infty}^\infty f(x) \cos \alpha x dx \\ &= \int_{-\infty}^0 0 \cdot \cos \alpha x dx + \int_0^\pi \sin x \cos \alpha x dx + \int_\pi^\infty 0 \cdot \cos \alpha x dx \\ &= \frac{1}{2} \int_0^\pi [\sin(1 + \alpha)x + \sin(1 - \alpha)x] dx \\ &= \frac{1}{2} \left[ \frac{\cos(1 + \alpha)x}{1 + \alpha} - \frac{\cos(1 - \alpha)x}{1 - \alpha} \right]_0^\pi \end{aligned}$$

Exercises 14.3

$$\begin{aligned}
 &= -\frac{1}{2} \left[ \frac{\cos(1+\alpha)\pi - 1}{1+\alpha} + \frac{\cos(1-\alpha)\pi - 1}{1-\alpha} \right] \\
 &= -\frac{1}{2} \left[ \frac{\cos(1+\alpha)\pi - \alpha \cos(1+\alpha)\pi + \cos(1-\alpha)\pi + \alpha \cos(1-\alpha)\pi - 2}{1-\alpha^2} \right] \\
 &= \frac{1 + \cos \alpha\pi}{1 - \alpha^2},
 \end{aligned}$$

and

$$\begin{aligned}
 B(\alpha) &= \int_0^\pi \sin x \sin \alpha x \, dx = \frac{1}{2} \int_0^\pi [\cos(1-\alpha)x - \cos(1+\alpha)x] \, dx \\
 &= \frac{1}{2} \left[ \frac{\sin(1-\alpha)\pi}{1-\alpha} - \frac{\sin(1+\alpha)\pi}{1+\alpha} \right] = \frac{\sin \alpha\pi}{1-\alpha^2}.
 \end{aligned}$$

Hence

$$\begin{aligned}
 f(x) &= \frac{1}{\pi} \int_0^\infty \frac{\cos \alpha x + \cos \alpha x \cos \alpha\pi + \sin \alpha x \sin \alpha\pi}{1-\alpha^2} \, d\alpha \\
 &= \frac{1}{\pi} \int_0^\infty \frac{\cos \alpha x + \cos \alpha(x-\pi)}{1-\alpha^2} \, d\alpha.
 \end{aligned}$$

5. From formula (5) in the text,

$$A(\alpha) = \int_0^\infty e^{-x} \cos \alpha x \, dx.$$

Recall  $\mathcal{L}\{\cos kt\} = s/(s^2 + k^2)$ . If we set  $s = 1$  and  $k = \alpha$  we obtain

$$A(\alpha) = \frac{1}{1 + \alpha^2}.$$

Now

$$B(\alpha) = \int_0^\infty e^{-x} \sin \alpha x \, dx.$$

Recall  $\mathcal{L}\{\sin kt\} = k/(s^2 + k^2)$ . If we set  $s = 1$  and  $k = \alpha$  we obtain

$$B(\alpha) = \frac{\alpha}{1 + \alpha^2}.$$

Hence

$$f(x) = \frac{1}{\pi} \int_0^\infty \frac{\cos \alpha x + \alpha \sin \alpha x}{1 + \alpha^2} \, d\alpha.$$

6. From formulas (5) and (6) in the text,

$$\begin{aligned}
 A(\alpha) &= \int_{-1}^1 e^x \cos \alpha x \, dx \\
 &= \frac{e(\cos \alpha + \alpha \sin \alpha) - e^{-1}(\cos \alpha - \alpha \sin \alpha)}{1 + \alpha^2} \\
 &= \frac{2(\sinh 1) \cos \alpha - 2\alpha(\cosh 1) \sin \alpha}{1 + \alpha^2}
 \end{aligned}$$

and

$$\begin{aligned} B(\alpha) &= \int_{-1}^1 e^x \sin \alpha x \, dx \\ &= \frac{e(\sin \alpha - \alpha \cos \alpha) - e^{-1}(-\sin \alpha - \alpha \cos \alpha)}{1 + \alpha^2} \\ &= \frac{2(\cosh 1) \sin \alpha - 2\alpha(\sinh 1) \cos \alpha}{1 + \alpha^2}. \end{aligned}$$

Hence

$$f(x) = \frac{1}{\pi} \int_0^{\infty} [A(\alpha) \cos \alpha x + B(\alpha) \sin \alpha x] \, d\alpha.$$

7. The function is odd. Thus from formula (11) in the text

$$B(\alpha) = 5 \int_0^1 \sin \alpha x \, dx = \frac{5(1 - \cos \alpha)}{\alpha}.$$

Hence from formula (10) in the text,

$$f(x) = \frac{10}{\pi} \int_0^{\infty} \frac{(1 - \cos \alpha) \sin \alpha x}{\alpha} \, d\alpha.$$

8. The function is even. Thus from formula (9) in the text

$$A(\alpha) = \pi \int_1^2 \cos \alpha x \, dx = \pi \left( \frac{\sin 2\alpha - \sin \alpha}{\alpha} \right).$$

Hence from formula (8) in the text,

$$f(x) = 2 \int_0^{\infty} \frac{(\sin 2\alpha - \sin \alpha) \cos \alpha x}{\alpha} \, d\alpha.$$

9. The function is even. Thus from formula (9) in the text

$$\begin{aligned} A(\alpha) &= \int_0^{\pi} x \cos \alpha x \, dx = \frac{x \sin \alpha x}{\alpha} \Big|_0^{\pi} - \frac{1}{\alpha} \int_0^{\pi} \sin \alpha x \, dx \\ &= \frac{\pi \alpha \sin \pi \alpha}{\alpha} + \frac{1}{\alpha^2} \cos \alpha x \Big|_0^{\pi} = \frac{\pi \alpha \sin \pi \alpha + \cos \pi \alpha - 1}{\alpha^2}. \end{aligned}$$

Hence from formula (8) in the text

$$f(x) = \frac{2}{\pi} \int_0^{\infty} \frac{(\pi \alpha \sin \pi \alpha + \cos \pi \alpha - 1) \cos \alpha x}{\alpha^2} \, d\alpha.$$

10. The function is odd. Thus from formula (11) in the text

$$\begin{aligned} B(\alpha) &= \int_0^{\pi} x \sin \alpha x \, dx = -\frac{x \cos \alpha x}{\alpha} \Big|_0^{\pi} + \frac{1}{\alpha} \int_0^{\pi} \cos \alpha x \, dx \\ &= -\frac{\pi \cos \pi \alpha}{\alpha} + \frac{1}{\alpha^2} \sin \alpha x \Big|_0^{\pi} = \frac{-\pi \alpha \cos \pi \alpha + \sin \pi \alpha}{\alpha^2}. \end{aligned}$$

### Exercises 14.3

Hence from formula (10) in the text,

$$f(x) = \frac{2}{\pi} \int_0^{\infty} \frac{(-\pi\alpha \cos \pi\alpha + \sin \pi\alpha) \sin \alpha x}{\alpha^2} d\alpha.$$

11. The function is odd. Thus from formula (11) in the text

$$\begin{aligned} B(\alpha) &= \int_0^{\infty} (e^{-x} \sin x) \sin \alpha x dx \\ &= \frac{1}{2} \int_0^{\infty} e^{-x} [\cos(1-\alpha)x - \cos(1+\alpha)x] dx \\ &= \frac{1}{2} \int_0^{\infty} e^{-x} \cos(1-\alpha)x dx - \frac{1}{2} \int_0^{\infty} e^{-x} \cos(1+\alpha)x dx. \end{aligned}$$

Now recall

$$\mathcal{L}\{\cos kt\} = \int_0^{\infty} e^{-st} \cos kt dt = s/(s^2 + k^2).$$

If we set  $s = 1$ , and in turn,  $k = 1 - \alpha$  and then  $k = 1 + \alpha$ , we obtain

$$B(\alpha) = \frac{1}{2} \frac{1}{1 + (1 - \alpha)^2} - \frac{1}{2} \frac{1}{1 + (1 + \alpha)^2} = \frac{1}{2} \frac{(1 + \alpha)^2 - (1 - \alpha)^2}{[1 + (1 - \alpha)^2][1 + (1 + \alpha)^2]}.$$

Simplifying the last expression gives

$$B(\alpha) = \frac{2\alpha}{4 + \alpha^4}.$$

Hence from formula (10) in the text

$$f(x) = \frac{4}{\pi} \int_0^{\infty} \frac{\alpha \sin \alpha x}{4 + \alpha^4} d\alpha.$$

12. The function is odd. Thus from formula (11) in the text

$$B(\alpha) = \int_0^{\infty} x e^{-x} \sin \alpha x dx.$$

Now recall

$$\mathcal{L}\{t \sin kt\} = -\frac{d}{ds} \mathcal{L}\{\sin kt\} = 2ks/(s^2 + k^2)^2.$$

If we set  $s = 1$  and  $k = \alpha$  we obtain

$$B(\alpha) = \frac{2\alpha}{(1 + \alpha^2)^2}.$$

Hence from formula (10) in the text

$$f(x) = \frac{4}{\pi} \int_0^{\infty} \frac{\alpha \sin \alpha x}{(1 + \alpha^2)^2} d\alpha.$$

13. For the cosine integral,

$$A(\alpha) = \int_0^{\infty} e^{-kx} \cos \alpha x dx = \frac{k}{k^2 + \alpha^2}.$$

Hence

$$f(x) = \frac{2}{\pi} \int_0^\infty \frac{k \cos \alpha x}{k^2 + \alpha^2} d\alpha = \frac{2k}{\pi} \int_0^\infty \frac{\cos \alpha x}{k^2 + \alpha^2} d\alpha.$$

For the sine integral,

$$B(\alpha) = \int_0^\infty e^{-kx} \sin \alpha x dx = \frac{\alpha}{k^2 + \alpha^2}.$$

Hence

$$f(x) = \frac{2}{\pi} \int_0^\infty \frac{\alpha \sin \alpha x}{k^2 + \alpha^2} d\alpha.$$

14. From Problem 13 the cosine and sine integral representations of  $e^{-kx}$ ,  $k > 0$ , are respectively,

$$e^{-kx} = \frac{2k}{\pi} \int_0^\infty \frac{\cos \alpha x}{k^2 + \alpha^2} d\alpha \quad \text{and} \quad e^{-kx} = \frac{2}{\pi} \int_0^\infty \frac{\alpha \sin \alpha x}{k^2 + \alpha^2} d\alpha.$$

Hence, the cosine integral representation of  $f(x) = e^{-x} - e^{-3x}$  is

$$e^{-x} - e^{-3x} = \frac{2}{\pi} \int_0^\infty \frac{\cos \alpha x}{1 + \alpha^2} d\alpha - \frac{2(3)}{\pi} \int_0^\infty \frac{\cos \alpha x}{9 + \alpha^2} d\alpha = \frac{4}{\pi} \int_0^\infty \frac{3 - \alpha^2}{(1 + \alpha^2)(9 + \alpha^2)} \cos \alpha x d\alpha.$$

The sine integral representation of  $f$  is

$$e^{-x} - e^{-3x} = \frac{2}{\pi} \int_0^\infty \frac{\alpha \sin \alpha x}{1 + \alpha^2} d\alpha - \frac{2}{\pi} \int_0^\infty \frac{\alpha \sin \alpha x}{9 + \alpha^2} d\alpha = \frac{16}{\pi} \int_0^\infty \frac{\alpha \sin \alpha x}{(1 + \alpha^2)(9 + \alpha^2)} d\alpha.$$

15. For the cosine integral,

$$A(\alpha) = \int_0^\infty x e^{-2x} \cos \alpha x dx.$$

But we know

$$\mathcal{L}\{t \cos kt\} = -\frac{d}{ds} \frac{s}{(s^2 + k^2)} = \frac{(s^2 - k^2)}{(s^2 + k^2)^2}.$$

If we set  $s = 2$  and  $k = \alpha$  we obtain

$$A(\alpha) = \frac{4 - \alpha^2}{(4 + \alpha^2)^2}.$$

Hence

$$f(x) = \frac{2}{\pi} \int_0^\infty \frac{(4 - \alpha^2) \cos \alpha x}{(4 + \alpha^2)^2} d\alpha.$$

For the sine integral,

$$B(\alpha) = \int_0^\infty x e^{-2x} \sin \alpha x dx.$$

From Problem 12, we know

$$\mathcal{L}\{t \sin kt\} = \frac{2ks}{(s^2 + k^2)^2}.$$

If we set  $s = 2$  and  $k = \alpha$  we obtain

$$B(\alpha) = \frac{4\alpha}{(4 + \alpha^2)^2}.$$

### Exercises 14.3

Hence

$$f(x) = \frac{8}{\pi} \int_0^{\infty} \frac{\alpha \sin \alpha x}{(4 + \alpha^2)^2} d\alpha.$$

16. For the cosine integral,

$$\begin{aligned} A(\alpha) &= \int_0^{\infty} e^{-x} \cos x \cos \alpha x dx \\ &= \frac{1}{2} \int_0^{\infty} e^{-x} [\cos(1 + \alpha)x + \cos(1 - \alpha)x] dx \\ &= \frac{1}{2} \frac{1}{1 + (1 + \alpha)^2} + \frac{1}{2} \frac{1}{1 + (1 - \alpha)^2} \\ &= \frac{1}{2} \frac{1 + (1 - \alpha)^2 + 1 + (1 + \alpha)^2}{[1 + (1 + \alpha)^2][1 + (1 - \alpha)^2]} \\ &= \frac{2 + \alpha^2}{4 + \alpha^4}. \end{aligned}$$

Hence

$$f(x) = \frac{2}{\pi} \int_0^{\infty} \frac{(2 + \alpha^2) \cos \alpha x}{4 + \alpha^4} d\alpha.$$

For the sine integral,

$$\begin{aligned} B(\alpha) &= \int_0^{\infty} e^{-x} \cos x \sin \alpha x dx \\ &= \frac{1}{2} \int_0^{\infty} e^{-x} [\sin(1 + \alpha)x - \sin(1 - \alpha)x] dx \\ &= \frac{1}{2} \frac{1 + \alpha}{1 + (1 + \alpha)^2} - \frac{1}{2} \frac{1 - \alpha}{1 + (1 - \alpha)^2} \\ &= \frac{1}{2} \left[ \frac{(1 + \alpha)[1 + (1 - \alpha)^2] - (1 - \alpha)[1 + (1 + \alpha)^2]}{[1 + (1 + \alpha)^2][1 + (1 - \alpha)^2]} \right] \\ &= \frac{\alpha^3}{4 + \alpha^4}. \end{aligned}$$

Hence

$$f(x) = \frac{2}{\pi} \int_0^{\infty} \frac{\alpha^3 \sin \alpha x}{4 + \alpha^4} d\alpha.$$

17. By formula (8) in the text

$$f(x) = 2\pi \int_0^{\infty} e^{-\alpha} \cos \alpha x d\alpha = \frac{2}{\pi} \frac{1}{1 + x^2}, \quad x > 0.$$

18. From the formula for sine integral of  $f(x)$  we have

$$\begin{aligned} f(x) &= \frac{2}{\pi} \int_0^{\infty} \left( \int_0^{\infty} f(x) \sin \alpha x \, dx \right) \sin \alpha x \, d\alpha \\ &= \frac{2}{\pi} \left[ \int_0^1 1 \cdot \sin \alpha x \, d\alpha + \int_1^{\infty} 0 \cdot \sin \alpha x \, d\alpha \right] \\ &= \frac{2}{\pi} \left. \frac{(-\cos \alpha x)}{x} \right|_0^1 = \frac{2}{\pi} \frac{1 - \cos x}{x}. \end{aligned}$$

19. (a) From formula (7) in the text with  $x = 2$ , we have

$$\frac{1}{2} = \frac{2}{\pi} \int_0^{\infty} \frac{\sin \alpha \cos \alpha}{\alpha} \, d\alpha = \frac{1}{\pi} \int_0^{\infty} \frac{\sin 2\alpha}{\alpha} \, d\alpha.$$

If we let  $\alpha = x$  we obtain

$$\int_0^{\infty} \frac{\sin 2x}{x} \, dx = \frac{\pi}{2}.$$

(b) If we now let  $2x = kt$  where  $k > 0$ , then  $dx = (k/2)dt$  and the integral in part (a) becomes

$$\int_0^{\infty} \frac{\sin kt}{kt/2} (k/2) \, dt = \int_0^{\infty} \frac{\sin kt}{t} \, dt = \frac{\pi}{2}.$$

20. With  $f(x) = e^{-|x|}$ , formula (16) in the text is

$$C(\alpha) = \int_{-\infty}^{\infty} e^{-|x|} e^{i\alpha x} \, dx = \int_{-\infty}^{\infty} e^{-|x|} \cos \alpha x \, dx + i \int_{-\infty}^{\infty} e^{-|x|} \sin \alpha x \, dx.$$

The imaginary part in the last line is zero since the integrand is an odd function of  $x$ . Therefore,

$$C(\alpha) = \int_{-\infty}^{\infty} e^{-|x|} \cos \alpha x \, dx = 2 \int_0^{\infty} e^{-x} \cos \alpha x \, dx = \frac{2}{1 + \alpha^2}$$

and so from formula (15) in the text,

$$f(x) = \frac{1}{\pi} \int_{-\infty}^{\infty} \frac{\cos \alpha x}{1 + \alpha^2} \, d\alpha = \frac{2}{\pi} \int_0^{\infty} \frac{\cos \alpha x}{1 + \alpha^2} \, d\alpha.$$

This is the same result obtained from formulas (8) and (9) in the text.

---

## Exercises 14.4

---

For the boundary-value problems in this section it is sometimes useful to note that the identities

$$e^{i\alpha} = \cos \alpha + i \sin \alpha \quad \text{and} \quad e^{-i\alpha} = \cos \alpha - i \sin \alpha$$

imply

$$e^{i\alpha} + e^{-i\alpha} = 2 \cos \alpha \quad \text{and} \quad e^{i\alpha} - e^{-i\alpha} = 2i \sin \alpha.$$

### Exercises 14.4

1. Using the Fourier transform, the partial differential equation becomes

$$\frac{dU}{dt} + k\alpha^2 U = 0 \quad \text{and so} \quad U(\alpha, t) = ce^{-k\alpha^2 t}.$$

Now

$$\mathcal{F}\{u(x, 0)\} = U(\alpha, 0) = \mathcal{F}\{e^{-|x|}\}.$$

We have

$$\mathcal{F}\{e^{-|x|}\} = \int_{-\infty}^{\infty} e^{-|x|} e^{i\alpha x} dx = \int_{-\infty}^{\infty} e^{-|x|} (\cos \alpha x + i \sin \alpha x) dx = \int_{-\infty}^{\infty} e^{-|x|} \cos \alpha x dx.$$

The integral

$$\int_{-\infty}^{\infty} e^{-|x|} \sin \alpha x dx = 0$$

since the integrand is an odd function of  $x$ . Continuing we obtain

$$\mathcal{F}\{e^{-|x|}\} = 2 \int_0^{\infty} e^{-x} \cos \alpha x dx = \frac{2}{1 + \alpha^2}.$$

But  $U(\alpha, 0) = c = \frac{2}{1 + \alpha^2}$  gives

$$U(\alpha, t) = \frac{2e^{-k\alpha^2 t}}{1 + \alpha^2}$$

and so

$$\begin{aligned} u(x, t) &= \frac{2}{2\pi} \int_{-\infty}^{\infty} \frac{e^{-k\alpha^2 t} e^{-i\alpha x}}{1 + \alpha^2} d\alpha = \frac{1}{\pi} \int_{-\infty}^{\infty} \frac{e^{-k\alpha^2 t}}{1 + \alpha^2} (\cos \alpha x - i \sin \alpha x) d\alpha \\ &= \frac{1}{\pi} \int_{-\infty}^{\infty} \frac{e^{-k\alpha^2 t} \cos \alpha x}{1 + \alpha^2} d\alpha = \frac{2}{\pi} \int_0^{\infty} \frac{e^{-k\alpha^2 t} \cos \alpha x}{1 + \alpha^2} d\alpha. \end{aligned}$$

2. Since the domain of  $x$  is  $(-\infty, \infty)$  we transform the differential equation using the Fourier transform:

$$-k\alpha^2 U(\alpha, t) = \frac{du}{dt}$$

$$\frac{du}{dt} + k\alpha^2 U(\alpha, t) = 0$$

$$U(\alpha, t) = ce^{-k\alpha^2 t}.$$

(1)

The transform of the initial condition is

$$\begin{aligned} \mathcal{F}\{u(x, 0)\} &= \int_{-\infty}^{\infty} u(x, 0) e^{i\alpha x} dx = \int_{-1}^0 (-100e^{i\alpha x}) dx + \int_0^1 100e^{i\alpha x} dx \\ &= -100 \frac{1 - e^{-i\alpha}}{i\alpha} + 100 \frac{e^{i\alpha} - 1}{i\alpha} = 100 \frac{e^{i\alpha} + e^{-i\alpha} - 2}{i\alpha} \\ &= 100 \frac{2 \cos \alpha - 2}{i\alpha} = 200 \frac{\cos \alpha - 1}{i\alpha}. \end{aligned}$$



Thus

$$U(\alpha, 0) = 200 \frac{\cos \alpha - 1}{i\alpha},$$

and since  $c = U(\alpha, 0)$  in (1) we have

$$U(\alpha, t) = 200 \frac{\cos \alpha - 1}{i\alpha} e^{-k\alpha^2 t}.$$

Applying the inverse Fourier transform we obtain

$$\begin{aligned} u(x, t) &= \mathcal{F}^{-1}\{U(\alpha, t)\} \\ &= \frac{1}{2\pi} \int_{-\infty}^{\infty} 200 \frac{\cos \alpha - 1}{i\alpha} e^{-k\alpha^2 t} e^{-i\alpha x} d\alpha \\ &= \frac{100}{\pi} \int_{-\infty}^{\infty} 200 \frac{\cos \alpha - 1}{i\alpha} e^{-k\alpha^2 t} (\cos \alpha x - i \sin \alpha x) d\alpha \\ &= \frac{100}{\pi} \int_{-\infty}^{\infty} \underbrace{\frac{\cos \alpha x (\cos \alpha - 1)}{i\alpha}}_{\text{odd function}} e^{-k\alpha^2 t} d\alpha - \frac{100}{\pi} \int_{-\infty}^{\infty} \underbrace{\frac{\sin \alpha x (\cos \alpha - 1)}{\alpha}}_{\text{even function}} e^{-k\alpha^2 t} d\alpha \\ &= \frac{200}{\pi} \int_0^{\infty} \frac{\sin \alpha x (1 - \cos \alpha)}{\alpha} e^{-k\alpha^2 t} d\alpha. \end{aligned}$$

3. Using the Fourier transform, the partial differential equation becomes

$$\frac{dU}{dt} + k\alpha^2 U = 0 \quad \text{and so} \quad U(\alpha, t) = ce^{-k\alpha^2 t}.$$

Now

$$\mathcal{F}\{u(x, 0)\} = U(\alpha, 0) = \sqrt{\pi} e^{-\alpha^2/4}$$

by the given result. This gives  $c = \sqrt{\pi} e^{-\alpha^2/4}$  and so

$$U(\alpha, t) = \sqrt{\pi} e^{-(\frac{1}{4} + kt)\alpha^2}.$$

Using the given Fourier transform again we obtain

$$u(x, t) = \sqrt{\pi} \mathcal{F}^{-1}\{e^{-(1+4kt)\alpha^2/4}\} = \frac{1}{\sqrt{1+4kt}} e^{-x^2/(1+4kt)}.$$

4. (a) We use  $U(\alpha, t) = ce^{-k\alpha^2 t}$ . The Fourier transform of the boundary condition is  $U(\alpha, 0) = F(\alpha)$ . This gives  $c = F(\alpha)$  and so  $U(\alpha, t) = F(\alpha)e^{-k\alpha^2 t}$ . By the convolution theorem and the given result, we obtain

$$u(x, t) = \mathcal{F}^{-1}\{F(\alpha) \cdot e^{-k\alpha^2 t}\} = \frac{1}{2\sqrt{k\pi t}} \int_{-\infty}^{\infty} f(\tau) e^{-(x-\tau)^2/4kt} d\tau.$$

- (b) Using the definition of  $f$  and the solution is part (a) we obtain

$$u(x, t) = \frac{u_0}{2\sqrt{k\pi t}} \int_{-1}^1 e^{-(x-\tau)^2/4kt} d\tau.$$

### Exercises 14.4

If  $u = \frac{x - \tau}{2\sqrt{kt}}$ , then  $d\tau = -2\sqrt{kt} du$  and the integral becomes

$$u(x, t) = \frac{u_0}{\sqrt{\pi}} \int_{(x-1)/2\sqrt{kt}}^{(x+1)/2\sqrt{kt}} e^{-u^2} du.$$

Using the result in Problem 9, Exercises 14.1, we have

$$u(x, t) = \frac{u_0}{2} \left[ \operatorname{erf} \left( \frac{x+1}{2\sqrt{kt}} \right) - \operatorname{erf} \left( \frac{x-1}{2\sqrt{kt}} \right) \right].$$

(c)

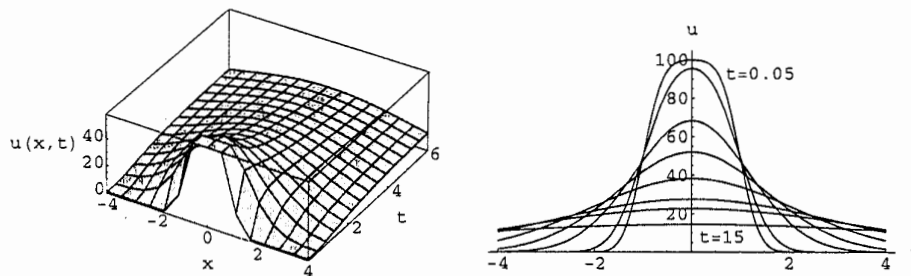

Since  $\operatorname{erf}(0) = 0$  and  $\lim_{x \rightarrow \infty} \operatorname{erf}(x) = 1$ , we have

$$\lim_{t \rightarrow \infty} u(x, t) = 50[\operatorname{erf}(0) - \operatorname{erf}(0)] = 0$$

and

$$\lim_{x \rightarrow \infty} u(x, t) = 50[\operatorname{erf}(\infty) - \operatorname{erf}(\infty)] = 50[1 - 1] = 0.$$

5. Using the Fourier sine transform, the partial differential equation becomes

$$\frac{dU}{dt} + k\alpha^2 U = k\alpha u_0.$$

The general solution of this linear equation is

$$U(\alpha, t) = ce^{-k\alpha^2 t} + \frac{u_0}{\alpha}.$$

But  $U(\alpha, 0) = 0$  implies  $c = -u_0/\alpha$  and so

$$U(\alpha, t) = u_0 \frac{1 - e^{-k\alpha^2 t}}{\alpha}$$

and

$$u(x, t) = \frac{2u_0}{\pi} \int_0^\infty \frac{1 - e^{-k\alpha^2 t}}{\alpha} \sin \alpha x d\alpha.$$

6. The solution of Problem 5 can be written

$$u(x, t) = \frac{2u_0}{\pi} \int_0^\infty \frac{\sin \alpha x}{\alpha} d\alpha - \frac{2u_0}{\pi} \int_0^\infty \frac{\sin \alpha x}{\alpha} e^{-k\alpha^2 t} d\alpha.$$

Using  $\int_0^\infty \frac{\sin \alpha x}{\alpha} d\alpha = \pi/2$  the last line becomes

$$u(x, t) = u_0 - \frac{2u_0}{\pi} \int_0^\infty \frac{\sin \alpha x}{\alpha} e^{-k\alpha^2 t} d\alpha.$$

7. Using the Fourier sine transform we find

$$U(\alpha, t) = ce^{-k\alpha^2 t}.$$

Now

$$\mathcal{F}_S\{u(x, 0)\} = U(\alpha, 0) = \int_0^1 \sin \alpha x dx = \frac{1 - \cos \alpha}{\alpha}.$$

From this we find  $c = (1 - \cos \alpha)/\alpha$  and so

$$U(\alpha, t) = \frac{1 - \cos \alpha}{\alpha} e^{-k\alpha^2 t}$$

and

$$u(x, t) = \frac{2}{\pi} \int_0^\infty \frac{1 - \cos \alpha}{\alpha} e^{-k\alpha^2 t} \sin \alpha x d\alpha.$$

8. Since the domain of  $x$  is  $(0, \infty)$  and the condition at  $x = 0$  involves  $\partial u/\partial x$  we use the Fourier cosine transform:

$$-k\alpha^2 U(\alpha, t) - ku_x(0, t) = \frac{dU}{dt}$$

$$\frac{dU}{dt} + k\alpha^2 U(\alpha, t) = kA$$

$$U(\alpha, t) = ce^{-k\alpha^2 t} + \frac{A}{\alpha^2}.$$

Since

$$\mathcal{F}\{u(x, 0)\} = U(\alpha, 0) = 0$$

we find  $c = -A/\alpha^2$ , so that

$$U(\alpha, t) = A \frac{1 - e^{-k\alpha^2 t}}{\alpha^2}.$$

Applying the inverse Fourier cosine transform we obtain

$$u(x, t) = \mathcal{F}_C^{-1}\{U(\alpha, t)\} = \frac{2A}{\pi} \int_0^\infty \frac{1 - e^{-k\alpha^2 t}}{\alpha^2} \cos \alpha x d\alpha.$$

9. Using the Fourier cosine transform we find

$$U(\alpha, t) = ce^{-k\alpha^2 t}.$$

### Exercises 14.4

Now

$$\mathcal{F}_C\{u(x, 0)\} = \int_0^1 \cos \alpha x \, dx = \frac{\sin \alpha}{\alpha} = U(\alpha, 0).$$

From this we obtain  $c = (\sin \alpha)/\alpha$  and so

$$U(\alpha, t) = \frac{\sin \alpha}{\alpha} e^{-k\alpha^2 t}$$

and

$$u(x, t) = \frac{2}{\pi} \int_0^\infty \frac{\sin \alpha}{\alpha} e^{-k\alpha^2 t} \cos \alpha x \, d\alpha.$$

10. Using the Fourier sine transform we find

$$U(\alpha, t) = ce^{-k\alpha^2 t} + \frac{1}{\alpha}.$$

Now

$$\mathcal{F}_S\{u(x, 0)\} = \mathcal{F}_S\{e^{-x}\} = \int_0^\infty e^{-x} \sin \alpha x \, dx = \frac{\alpha}{1 + \alpha^2} = U(\alpha, 0).$$

From this we obtain  $c = \alpha/(1 + \alpha^2) - 1/\alpha$ . Therefore

$$U(\alpha, t) = \left( \frac{\alpha}{1 + \alpha^2} - \frac{1}{\alpha} \right) e^{-k\alpha^2 t} + \frac{1}{\alpha} = \frac{1}{\alpha} - \frac{e^{-k\alpha^2 t}}{\alpha(1 + \alpha^2)}$$

and

$$u(x, t) = \frac{2}{\pi} \int_0^\infty \left( \frac{1}{\alpha} - \frac{e^{-k\alpha^2 t}}{\alpha(1 + \alpha^2)} \right) \sin \alpha x \, d\alpha.$$

11. (a) Using the Fourier transform we obtain

$$U(\alpha, t) = c_1 \cos \alpha at + c_2 \sin \alpha at.$$

If we write

$$\mathcal{F}\{u(x, 0)\} = \mathcal{F}\{f(x)\} = F(\alpha)$$

and

$$\mathcal{F}\{u_t(x, 0)\} = \mathcal{F}\{g(x)\} = G(\alpha)$$

we first obtain

$c_1 = F(\alpha)$  from  $U(\alpha, 0) = F(\alpha)$  and then  $c_2 = G(\alpha)/\alpha a$  from  $\left. \frac{dU}{dt} \right|_{t=0} = G(\alpha)$ . Thus

$$U(\alpha, t) = F(\alpha) \cos \alpha at + \frac{G(\alpha)}{\alpha a} \sin \alpha at$$

and

$$u(x, t) = \frac{1}{2\pi} \int_{-\infty}^\infty \left( F(\alpha) \cos \alpha at + \frac{G(\alpha)}{\alpha a} \sin \alpha at \right) e^{-i\alpha x} \, d\alpha.$$

(b) If  $g(x) = 0$  then  $c_2 = 0$  and

$$\begin{aligned} u(x, t) &= \frac{1}{2\pi} \int_{-\infty}^{\infty} F(\alpha) \cos \alpha at e^{-i\alpha x} d\alpha \\ &= \frac{1}{2\pi} \int_{-\infty}^{\infty} F(\alpha) \left( \frac{e^{\alpha at} + e^{-\alpha at}}{2} \right) e^{-i\alpha x} d\alpha \\ &= \frac{1}{2} \left[ \frac{1}{2\pi} \int_{-\infty}^{\infty} F(\alpha) e^{-i(x-at)\alpha} d\alpha + \frac{1}{2\pi} \int_{-\infty}^{\infty} F(\alpha) e^{-i(x+at)\alpha} d\alpha \right] \\ &= \frac{1}{2} [f(x-at) + f(x+at)]. \end{aligned}$$

12. Using the Fourier sine transform we obtain

$$U(\alpha, t) = c_1 \cos \alpha at + c_2 \sin \alpha at.$$

Now

$$\mathcal{F}_S\{u(x, 0)\} = \mathcal{F}\{xe^{-x}\} = \int_0^{\infty} xe^{-x} \sin \alpha x dx = \frac{2\alpha}{(1+\alpha^2)^2} = U(\alpha, 0).$$

Also,

$$\mathcal{F}_S\{u_t(x, 0)\} = \left. \frac{dU}{dt} \right|_{t=0} = 0.$$

This last condition gives  $c_2 = 0$ . Then  $U(\alpha, 0) = 2\alpha/(1+\alpha^2)^2$  yields  $c_1 = 2\alpha/(1+\alpha^2)^2$ . Therefore

$$U(\alpha, t) = \frac{2\alpha}{(1+\alpha^2)^2} \cos \alpha at$$

and

$$u(x, t) = \frac{4}{\pi} \int_0^{\infty} \frac{\alpha \cos \alpha at}{(1+\alpha^2)^2} \sin \alpha x d\alpha.$$

13. Using the Fourier cosine transform we obtain

$$U(x, \alpha) = c_1 \cosh \alpha x + c_2 \sinh \alpha x.$$

Now the Fourier cosine transforms of  $u(0, y) = e^{-y}$  and  $u(\pi, y) = 0$  are, respectively,  $U(0, \alpha) = 1/(1+\alpha^2)$  and  $U(\pi, \alpha) = 0$ . The first of these conditions gives  $c_1 = 1/(1+\alpha^2)$ . The second condition gives

$$c_2 = -\frac{\cosh \alpha \pi}{(1+\alpha^2) \sinh \alpha \pi}.$$

Hence

$$\begin{aligned} U(x, \alpha) &= \frac{\cosh \alpha x}{1+\alpha^2} - \frac{\cosh \alpha \pi \sinh \alpha x}{(1+\alpha^2) \sinh \alpha \pi} = \frac{\sinh \alpha \pi \cosh \alpha \pi - \cosh \alpha \pi \sinh \alpha x}{(1+\alpha^2) \sinh \alpha \pi} \\ &= \frac{\sinh \alpha (\pi - x)}{(1+\alpha^2) \sinh \alpha \pi} \end{aligned}$$

### Exercises 14.4

and

$$u(x, t) = \frac{2}{\pi} \int_0^{\infty} \frac{\sinh \alpha(\pi - x)}{(1 + \alpha^2) \sinh \alpha\pi} \cos \alpha y \, d\alpha.$$

14. Since the boundary condition at  $y = 0$  now involves  $u(x, 0)$  rather than  $u'(x, 0)$ , we use the Fourier sine transform. The transform of the partial differential equation is then

$$\frac{d^2 U}{dx^2} - \alpha^2 U + \alpha u(x, 0) = 0 \quad \text{or} \quad \frac{d^2 U}{dx^2} - \alpha^2 U = -\alpha.$$

The solution of this differential equation is

$$U(x, \alpha) = c_1 \cosh \alpha x + c_2 \sinh \alpha x + \frac{1}{\alpha}.$$

The transforms of the boundary conditions at  $x = 0$  and  $x = \pi$  in turn imply that  $c_1 = 1/\alpha$  and

$$c_2 = \frac{\cosh \alpha\pi}{\alpha \sinh \alpha\pi} - \frac{1}{\alpha \sinh \alpha\pi} + \frac{\alpha}{(1 + \alpha^2) \sinh \alpha\pi}.$$

Hence

$$\begin{aligned} U(\alpha, x) &= \frac{1}{\alpha} - \frac{\cosh \alpha x}{\alpha} + \frac{\cosh \alpha\pi}{\alpha \sinh \alpha\pi} \sinh \alpha x - \frac{\sinh \alpha x}{\alpha \sinh \alpha\pi} + \frac{\alpha \sinh \alpha x}{(1 + \alpha^2) \sinh \alpha\pi} \\ &= \frac{1}{\alpha} - \frac{\sinh \alpha(\pi - x)}{\alpha \sinh \alpha\pi} - \frac{\sinh \alpha x}{\alpha(1 + \alpha^2) \sinh \alpha\pi}. \end{aligned}$$

Taking the inverse transform it follows that

$$u(x, y) = \frac{2}{\pi} \int_0^{\infty} \left( \frac{1}{\alpha} - \frac{\sinh \alpha(\pi - x)}{\alpha \sinh \alpha\pi} - \frac{\sinh \alpha x}{\alpha(1 + \alpha^2) \sinh \alpha\pi} \right) \sin \alpha y \, d\alpha.$$

15. Using the Fourier cosine transform with respect to  $x$  gives

$$U(\alpha, y) = c_1 e^{-\alpha y} + c_2 e^{\alpha y}.$$

Since we expect  $u(x, y)$  to be bounded as  $y \rightarrow \infty$  we define  $c_2 = 0$ . Thus

$$U(\alpha, y) = c_1 e^{-\alpha y}.$$

Now

$$\mathcal{F}_C\{u(x, 0)\} = \int_0^1 50 \cos \alpha x \, dx = 50 \frac{\sin \alpha}{\alpha}$$

and so

$$U(\alpha, y) = 50 \frac{\sin \alpha}{\alpha} e^{-\alpha y}$$

and

$$u(x, y) = \frac{100}{\pi} \int_0^{\infty} \frac{\sin \alpha}{\alpha} e^{-\alpha y} \cos \alpha x \, d\alpha.$$

16. The boundary condition  $u(0, y) = 0$  indicates that we now use the Fourier sine transform. We still have  $U(\alpha, y) = c_1 e^{-\alpha y}$ , but

$$\mathcal{F}_S\{u(x, 0)\} = \int_0^1 50 \sin \alpha x \, dx = 50(1 - \cos \alpha)/\alpha = U(\alpha, 0).$$

This gives  $c_1 = 50(1 - \cos \alpha)/\alpha$  and so

$$U(\alpha, y) = 50 \frac{1 - \cos \alpha}{\alpha} e^{-\alpha y}$$

and

$$u(x, y) = \frac{100}{\pi} \int_0^\infty \frac{1 - \cos \alpha}{\alpha} e^{-\alpha y} \sin \alpha x \, d\alpha.$$

17. We use the Fourier sine transform with respect to  $x$  to obtain

$$U(\alpha, y) = c_1 \cosh \alpha y + c_2 \sinh \alpha y.$$

The transforms of  $u(x, 0) = f(x)$  and  $u(x, 2) = 0$  give, in turn,  $U(\alpha, 0) = F(\alpha)$  and  $U(\alpha, 2) = 0$ . The first condition gives  $c_1 = F(\alpha)$  and the second condition then yields

$$c_2 = -\frac{F(\alpha) \cosh 2\alpha}{\sinh 2\alpha}.$$

Hence

$$\begin{aligned} U(\alpha, y) &= F(\alpha) \cosh \alpha y - \frac{F(\alpha) \cosh 2\alpha \sinh \alpha y}{\sinh 2\alpha} \\ &= F(\alpha) \frac{\sinh 2\alpha \cosh \alpha y - \cosh 2\alpha \sinh \alpha y}{\sinh 2\alpha} \\ &= F(\alpha) \frac{\sinh \alpha(2 - y)}{\sinh 2\alpha} \end{aligned}$$

and

$$u(x, y) = \frac{2}{\pi} \int_0^\infty F(\alpha) \frac{\sinh \alpha(2 - y)}{\sinh 2\alpha} \sin \alpha x \, d\alpha.$$

18. The domain of  $y$  and the boundary condition at  $y = 0$  suggest that we use a Fourier cosine transform. The transformed equation is

$$\frac{d^2 U}{dx^2} - \alpha^2 U - u_y(x, 0) = 0 \quad \text{or} \quad \frac{d^2 U}{dx^2} - \alpha^2 U = 0.$$

Because the domain of the variable  $x$  is a finite interval we choose to write the general solution of the latter equation as

$$U(x, \alpha) = c_1 \cosh \alpha x + c_2 \sinh \alpha x.$$

Now  $U(0, \alpha) = F(\alpha)$ , where  $F(\alpha)$  is the Fourier cosine transform of  $f(y)$ , and  $U'(\pi, \alpha) = 0$  imply  $c_1 = F(\alpha)$  and  $c_2 = -F(\alpha) \sinh \alpha\pi / \cosh \alpha\pi$ . Thus

$$U(x, \alpha) = F(\alpha) \cosh \alpha x - F(\alpha) \frac{\sinh \alpha\pi}{\cosh \alpha\pi} \sinh \alpha x = F(\alpha) \frac{\cosh \alpha(\pi - x)}{\cosh \alpha\pi}.$$

Using the inverse transform we find that a solution to the problem is

$$u(x, y) = \frac{2}{\pi} \int_0^\infty F(\alpha) \frac{\cosh \alpha(\pi - x)}{\cosh \alpha\pi} \cos \alpha y \, d\alpha.$$

### Exercises 14.4

19. We solve two boundary-value problems:

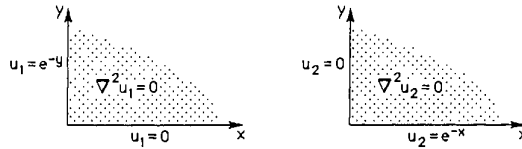

Using the Fourier sine transform with respect to  $y$  gives

$$u_1(x, y) = \frac{2}{\pi} \int_0^\infty \frac{\alpha e^{-\alpha x}}{1 + \alpha^2} \sin \alpha y \, d\alpha.$$

The Fourier sine transform with respect to  $x$  yields the solution to the second problem:

$$u_2(x, y) = \frac{2}{\pi} \int_0^\infty \frac{\alpha e^{-\alpha y}}{1 + \alpha^2} \sin \alpha x \, d\alpha.$$

We define the solution of the original problem to be

$$u(x, y) = u_1(x, y) + u_2(x, y) = \frac{2}{\pi} \int_0^\infty \frac{\alpha}{1 + \alpha^2} [e^{-\alpha x} \sin \alpha y + e^{-\alpha y} \sin \alpha x] \, d\alpha.$$

20. We solve the three boundary-value problems:

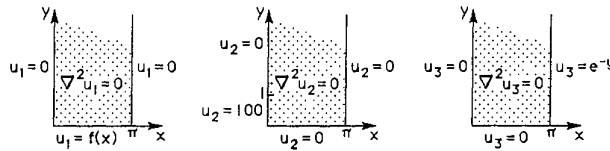

Using separation of variables we find the solution of the first problem is

$$u_1(x, y) = \sum_{n=1}^{\infty} A_n e^{-ny} \sin nx \quad \text{where} \quad A_n = \frac{2}{\pi} \int_0^\pi f(x) \sin nx \, dx.$$

Using the Fourier sine transform with respect to  $y$  gives the solution of the second problem:

$$u_2(x, y) = \frac{200}{\pi} \int_0^\infty \frac{(1 - \cos \alpha) \sinh \alpha(\pi - x)}{\alpha \sinh \alpha\pi} \sin \alpha y \, d\alpha.$$

Also, the Fourier sine transform with respect to  $y$  gives the solution of the third problem:

$$u_3(x, y) = \frac{2}{\pi} \int_0^\infty \frac{\alpha \sinh \alpha x}{(1 + \alpha^2) \sinh \alpha\pi} \sin \alpha y \, d\alpha.$$

The solution of the original problem is

$$u(x, y) = u_1(x, y) + u_2(x, y) + u_3(x, y).$$

21. Using the Fourier transform with respect to  $x$  gives

$$U(\alpha, y) = c_1 \cosh \alpha y + c_2 \sinh \alpha y.$$



The transform of the boundary condition  $\frac{\partial u}{\partial y} \Big|_{y=0} = 0$  is  $\frac{dU}{dy} \Big|_{y=0} = 0$ . This condition gives  $c_2 = 0$ . Hence

$$U(\alpha, y) = c_1 \cosh \alpha y.$$

Now by the given information the transform of the boundary condition  $u(x, 1) = e^{-x^2}$  is  $U(\alpha, 1) = \sqrt{\pi} e^{-\alpha^2/4}$ . This condition then gives  $c_1 = \sqrt{\pi} e^{-\alpha^2/4} \cosh \alpha$ . Therefore

$$U(\alpha, y) = \sqrt{\pi} \frac{e^{-\alpha^2/4} \cosh \alpha y}{\cosh \alpha}$$

and

$$\begin{aligned} U(x, y) &= \frac{1}{2\sqrt{\pi}} \int_{-\infty}^{\infty} \frac{e^{-\alpha^2/4} \cosh \alpha y}{\cosh \alpha} e^{-i\alpha x} d\alpha \\ &= \frac{1}{2\sqrt{\pi}} \int_{-\infty}^{\infty} \frac{e^{-\alpha^2/4} \cosh \alpha y}{\cosh \alpha} \cos \alpha x d\alpha \\ &= \frac{1}{\sqrt{\pi}} \int_0^{\infty} \frac{e^{-\alpha^2/4} \cosh \alpha y}{\cosh \alpha} \cos \alpha x d\alpha. \end{aligned}$$

22. Entries 42 and 43 in the Table of Laplace transforms imply

$$\int_0^{\infty} e^{-st} \frac{\sin at}{t} dt = \arctan \frac{a}{s}$$

and

$$\int_0^{\infty} e^{-st} \frac{\sin at \cos bt}{t} dt = \frac{1}{2} \arctan \frac{a+b}{s} + \frac{1}{2} \arctan \frac{a-b}{s}.$$

Identifying  $\alpha = t$ ,  $x = a$ , and  $y = s$ , the solution of Problem 16 is

$$\begin{aligned} u(x, y) &= \frac{100}{\pi} \int_0^{\infty} \frac{1 - \cos \alpha}{\alpha} e^{-\alpha y} \sin \alpha x d\alpha \\ &= \frac{100}{\pi} \left[ \int_0^{\infty} \frac{\sin \alpha x}{\alpha} e^{-\alpha y} d\alpha - \int_0^{\infty} \frac{\sin \alpha x \cos \alpha}{\alpha} e^{-\alpha y} d\alpha \right] \\ &= \frac{100}{\pi} \left[ \arctan \frac{x}{y} - \frac{1}{2} \arctan \frac{x+1}{y} - \frac{1}{2} \arctan \frac{x-1}{y} \right]. \end{aligned}$$

## Chapter 14 Review Exercises

1. The partial differential equation and the boundary conditions indicate that the Fourier cosine transform is appropriate for the problem. We find in this case

$$u(x, y) = \frac{2}{\pi} \int_0^{\infty} \frac{\sinh \alpha y}{\alpha(1 + \alpha^2) \cosh \alpha \pi} \cos \alpha x \, d\alpha.$$

2. We use the Laplace transform and undetermined coefficients to obtain

$$U(x, s) = c_1 \cosh \sqrt{s} x + c_2 \sinh \sqrt{s} x + \frac{50}{s + 4\pi^2} \sin 2\pi x.$$

The transformed boundary conditions  $U(0, s) = 0$  and  $U(1, s) = 0$  give, in turn,  $c_1 = 0$  and  $c_2 = 0$ . Hence

$$U(x, s) = \frac{50}{s + 4\pi^2} \sin 2\pi x$$

and

$$u(x, t) = 50 \sin 2\pi x \mathcal{L}^{-1} \left\{ \frac{1}{s + 4\pi^2} \right\} = 50e^{-4\pi^2 t} \sin 2\pi x.$$

3. The Laplace transform gives

$$U(x, s) = c_1 e^{-\sqrt{s+h}x} + c_2 e^{\sqrt{s+h}x} + \frac{u_0}{s+h}.$$

The condition  $\lim_{x \rightarrow \infty} \partial u / \partial x = 0$  implies  $\lim_{x \rightarrow \infty} dU/dx = 0$  and so we define  $c_2 = 0$ . Thus

$$U(x, s) = c_1 e^{-\sqrt{s+h}x} + \frac{u_0}{s+h}.$$

The condition  $U(0, s) = 0$  then gives  $c_1 = -u_0/(s+h)$  and so

$$U(x, s) = \frac{u_0}{s+h} - u_0 \frac{e^{-\sqrt{s+h}x}}{s+h}.$$

With the help of the first translation theorem we then obtain

$$\begin{aligned} u(x, t) &= u_0 \mathcal{L}^{-1} \left\{ \frac{1}{s+h} \right\} - u_0 \mathcal{L}^{-1} \left\{ \frac{e^{-\sqrt{s+h}x}}{s+h} \right\} = u_0 e^{-ht} - u_0 e^{-ht} \operatorname{erfc} \left( \frac{x}{2\sqrt{t}} \right) \\ &= u_0 e^{-ht} \left[ 1 - \operatorname{erfc} \left( \frac{x}{2\sqrt{t}} \right) \right] = u_0 e^{-ht} \operatorname{erf} \left( \frac{x}{2\sqrt{t}} \right). \end{aligned}$$

4. Using the Fourier transform and the result  $\mathcal{F}\{e^{-|x|}\} = 1/(1 + \alpha^2)$  we find

$$\begin{aligned} u(x, t) &= \frac{1}{2\pi} \int_{-\infty}^{\infty} \frac{1 - e^{-\alpha^2 t}}{\alpha^2(1 + \alpha^2)} e^{-i\alpha x} d\alpha \\ &= \frac{1}{2\pi} \int_{-\infty}^{\infty} \frac{1 - e^{-\alpha^2 t}}{\alpha^2(1 + \alpha^2)} \cos \alpha x d\alpha \\ &= \frac{1}{\pi} \int_0^{\infty} \frac{1 - e^{-\alpha^2 t}}{\alpha^2(1 + \alpha^2)} \cos \alpha x d\alpha. \end{aligned}$$

5. The Laplace transform gives

$$U(x, s) = c_1 e^{-\sqrt{s}x} + c_2 e^{\sqrt{s}x}.$$

The condition  $\lim_{x \rightarrow \infty} u(x, t) = 0$  implies  $\lim_{x \rightarrow \infty} U(x, s) = 0$  and so we define  $c_2 = 0$ . Thus

$$U(x, s) = c_1 e^{-\sqrt{s}x}.$$

The transform of the remaining boundary condition is  $U(0, s) = 1/s^2$ . This gives  $c_1 = 1/s^2$ . Hence

$$U(x, s) = \frac{e^{-\sqrt{s}x}}{s^2} \quad \text{and} \quad u(x, t) = \mathcal{L}^{-1} \left\{ \frac{1}{s} \frac{e^{-\sqrt{s}x}}{s} \right\}.$$

Using

$$\mathcal{L}^{-1} \left\{ \frac{1}{s} \right\} = 1 \quad \text{and} \quad \mathcal{L}^{-1} \left\{ \frac{e^{-\sqrt{s}x}}{s} \right\} = \operatorname{erfc} \left( \frac{x}{2\sqrt{t}} \right),$$

it follows from the convolution theorem that

$$u(x, t) = \int_0^t \operatorname{erfc} \left( \frac{x}{2\sqrt{\tau}} \right) d\tau.$$

6. The Laplace transform and undetermined coefficients gives

$$U(x, s) = c_1 \cosh sx + c_2 \sinh sx + \frac{s-1}{s^2 + \pi^2} \sin \pi x.$$

The conditions  $U(0, s) = 0$  and  $U(1, s) = 0$  give, in turn,  $c_1 = 0$  and  $c_2 = 0$ . Thus

$$U(x, s) = \frac{s-1}{s^2 + \pi^2} \sin \pi x$$

and

$$\begin{aligned} u(x, t) &= \sin \pi x \mathcal{L}^{-1} \left\{ \frac{s}{s^2 + \pi^2} \right\} - \frac{1}{\pi} \sin \pi x \mathcal{L}^{-1} \left\{ \frac{\pi}{s^2 + \pi^2} \right\} \\ &= (\sin \pi x) \cos \pi t - \frac{1}{\pi} (\sin \pi x) \sin \pi t. \end{aligned}$$

## Chapter 14 Review Exercises

7. The Fourier transform gives the solution

$$\begin{aligned} u(x, t) &= \frac{u_0}{2\pi} \int_{-\infty}^{\infty} \left( \frac{e^{i\alpha\pi} - 1}{i\alpha} \right) e^{-i\alpha x} e^{-k\alpha^2 t} d\alpha \\ &= \frac{u_0}{2\pi} \int_{-\infty}^{\infty} \frac{e^{i\alpha(\pi-x)} - e^{-i\alpha x}}{i\alpha} e^{-k\alpha^2 t} d\alpha \\ &= \frac{u_0}{2\pi} \int_{-\infty}^{\infty} \frac{\cos \alpha(\pi-x) + i \sin \alpha(\pi-x) - \cos \alpha x + i \sin \alpha x}{i\alpha} e^{-k\alpha^2 t} d\alpha. \end{aligned}$$

Since the imaginary part of the integrand of the last integral is an odd function of  $\alpha$ , we obtain

$$u(x, t) = \frac{u_0}{2\pi} \int_{-\infty}^{\infty} \frac{\sin \alpha(\pi-x) + \sin \alpha x}{\alpha} e^{-k\alpha^2 t} d\alpha.$$

8. Using the Fourier cosine transform we obtain  $U(x, \alpha) = c_1 \cosh \alpha x + c_2 \sinh \alpha x$ . The condition  $U(0, \alpha) = 0$  gives  $c_1 = 0$ . Thus  $U(x, \alpha) = c_2 \sinh \alpha x$ . Now

$$\mathcal{F}_C\{u(\pi, y)\} = \int_1^2 \cos \alpha y dy = \frac{\sin 2\alpha - \sin \alpha}{\alpha} = U(\pi, \alpha).$$

This last condition gives  $c_2 = (\sin 2\alpha - \sin \alpha)/\alpha \sinh \alpha \pi$ . Hence

$$U(x, \alpha) = \frac{\sin 2\alpha - \sin \alpha}{\alpha \sinh \alpha \pi} \sinh \alpha x$$

and

$$u(x, y) = \frac{2}{\pi} \int_0^{\infty} \frac{\sin 2\alpha - \sin \alpha}{\alpha \sinh \alpha \pi} \sinh \alpha x \cos \alpha y d\alpha.$$

9. We solve the two problems

$$\frac{\partial^2 u_1}{\partial x^2} + \frac{\partial^2 u_1}{\partial y^2} = 0, \quad x > 0, \quad y > 0,$$

$$u_1(0, y) = 0, \quad y > 0,$$

$$u_1(x, 0) = \begin{cases} 100, & 0 < x < 1 \\ 0, & x > 1 \end{cases}$$

and

$$\frac{\partial^2 u_2}{\partial x^2} + \frac{\partial^2 u_2}{\partial y^2} = 0, \quad x > 0, \quad y > 0,$$

$$u_2(0, y) = \begin{cases} 50, & 0 < y < 1 \\ 0, & y > 1 \end{cases}$$

$$u_2(x, 0) = 0.$$

Using the Fourier sine transform with respect to  $x$  we find

$$u_1(x, y) = \frac{200}{\pi} \int_0^{\infty} \left( \frac{1 - \cos \alpha}{\alpha} \right) e^{-\alpha y} \sin \alpha x d\alpha.$$

Using the Fourier sine transform with respect to  $y$  we find

$$u_2(x, y) = \frac{100}{\pi} \int_0^\infty \left( \frac{1 - \cos \alpha}{\alpha} \right) e^{-\alpha x} \sin \alpha y \, d\alpha.$$

The solution of the problem is then

$$u(x, y) = u_1(x, y) + u_2(x, y).$$

10. The Laplace transform gives

$$U(x, s) = c_1 \cosh \sqrt{s} x + c_2 \sinh \sqrt{s} x + \frac{r}{s^2}.$$

The condition  $\frac{\partial u}{\partial x} \Big|_{x=0} = 0$  transforms into  $\frac{dU}{dx} \Big|_{x=0} = 0$ . This gives  $c_2 = 0$ . The remaining condition  $u(1, t) = 0$  transforms into  $U(1, s) = 0$ . This condition then implies  $c_1 = -r/s^2 \cosh \sqrt{s}$ . Hence

$$U(x, s) = \frac{r}{s^2} - r \frac{\cosh \sqrt{s} x}{s^2 \cosh \sqrt{s}}.$$

Using geometric series and the convolution theorem we obtain

$$\begin{aligned} u(x, t) &= r \mathcal{L}^{-1} \left\{ \frac{1}{s^2} \right\} - r \mathcal{L}^{-1} \left\{ \frac{\cosh \sqrt{s} x}{s^2 \cosh \sqrt{s}} \right\} \\ &= rt - r \sum_{n=0}^{\infty} (-1)^n \left[ \int_0^t \operatorname{erfc} \left( \frac{2n+1-x}{2\sqrt{\tau}} \right) d\tau + \int_0^t \operatorname{erfc} \left( \frac{2n+1+x}{2\sqrt{\tau}} \right) d\tau \right]. \end{aligned}$$

11. The Fourier sine transform with respect to  $x$  and undetermined coefficients give

$$U(\alpha, y) = c_1 \cosh \alpha y + c_2 \sinh \alpha y + \frac{A}{\alpha}.$$

The transforms of the boundary conditions are

$$\frac{dU}{dy} \Big|_{y=0} = 0 \quad \text{and} \quad \frac{dU}{dy} \Big|_{y=\pi} = \frac{B\alpha}{1 + \alpha^2}.$$

The first of these conditions gives  $c_2 = 0$  and so

$$U(\alpha, y) = c_1 \cosh \alpha y + \frac{A}{\alpha}.$$

The second transformed boundary condition yields  $c_1 = B/(1 + \alpha^2) \sinh \alpha \pi$ . Therefore

$$U(\alpha, y) = \frac{B \cosh \alpha y}{(1 + \alpha^2) \sinh \alpha \pi} + \frac{A}{\alpha}$$

and

$$u(x, y) = \frac{2}{\pi} \int_0^\infty \left( \frac{B \cosh \alpha y}{(1 + \alpha^2) \sinh \alpha \pi} + \frac{A}{\alpha} \right) \sin \alpha x \, d\alpha.$$

12. Using the Laplace transform gives

$$U(x, s) = c_1 \cosh \sqrt{s} x + c_2 \sinh \sqrt{s} x.$$

### Chapter 14 Review Exercises

The condition  $u(0, t) = u_0$  transforms into  $U(0, s) = u_0/s$ . This gives  $c_1 = u_0/s$ . The condition  $u(1, t) = u_0$  transforms into  $U(1, s) = u_0/s$ . This implies that  $c_2 = u_0(1 - \cosh \sqrt{s})/s \sinh \sqrt{s}$ .

Hence

$$\begin{aligned} U(x, s) &= \frac{u_0}{s} \cosh \sqrt{s} x + u_0 \left[ \frac{1 - \cosh \sqrt{s}}{s \sinh \sqrt{s}} \right] \sinh \sqrt{s} x \\ &= u_0 \left[ \frac{\sinh \sqrt{s} \cosh \sqrt{s} x - \cosh \sinh \sqrt{s} \sinh \sqrt{s} x + \sinh \sqrt{s} x}{s \sinh \sqrt{s}} \right] \\ &= u_0 \left[ \frac{\sinh \sqrt{s} (1 - x) + \sinh \sqrt{s} x}{s \sinh \sqrt{s}} \right] \\ &= u_0 \left[ \frac{\sinh \sqrt{s} (1 - x)}{s \sinh \sqrt{s}} + \frac{\sinh \sqrt{s} x}{s \sinh \sqrt{s}} \right] \end{aligned}$$

and

$$\begin{aligned} u(x, t) &= u_0 \left[ \mathcal{L}^{-1} \left\{ \frac{\sinh \sqrt{s} (1 - x)}{s \sinh \sqrt{s}} \right\} + \mathcal{L}^{-1} \left\{ \frac{\sinh \sqrt{s} x}{s \sinh \sqrt{s}} \right\} \right] \\ &= u_0 \sum_{n=0}^{\infty} \left[ \operatorname{erf} \left( \frac{2n + 2 - x}{2\sqrt{t}} \right) - \operatorname{erf} \left( \frac{2n + x}{2\sqrt{t}} \right) \right] \\ &\quad + u_0 \sum_{n=0}^{\infty} \left[ \operatorname{erf} \left( \frac{2n + 1 + x}{2\sqrt{t}} \right) - \operatorname{erf} \left( \frac{2n + 1 - x}{2\sqrt{t}} \right) \right]. \end{aligned}$$

13. Using the Fourier transform gives

$$U(\alpha, t) = c_1 e^{-k\alpha^2 t}.$$

Now

$$u(\alpha, 0) = \int_0^{\infty} e^{-x} e^{i\alpha x} dx = \frac{e^{(i\alpha-1)x}}{i\alpha-1} \Big|_0^{\infty} = 0 - \frac{1}{i\alpha-1} = \frac{1}{1-i\alpha} = c_1$$

so

$$U(\alpha, t) = \frac{1+i\alpha}{1+\alpha^2} e^{-k\alpha^2 t}$$

and

$$u(x, t) = \frac{1}{2\pi} \int_{-\infty}^{\infty} \frac{1+i\alpha}{1+\alpha^2} e^{-k\alpha^2 t} e^{-i\alpha x} d\alpha.$$

Since

$$\frac{1+i\alpha}{1+\alpha^2} (\cos \alpha x - i \sin \alpha x) = \frac{\cos \alpha x + \alpha \sin \alpha x}{1+\alpha^2} + \frac{i(\alpha \cos \alpha x - \sin \alpha x)}{1+\alpha^2}$$

and the integral of the product of the second term with  $e^{-k\alpha^2 t}$  is 0 (it is an odd function), we have

$$u(x, t) = \frac{1}{2\pi} \int_{-\infty}^{\infty} \frac{\cos \alpha x + \alpha \sin \alpha x}{1+\alpha^2} e^{-k\alpha^2 t} d\alpha.$$

# 15 Numerical Solutions of Partial Differential Equations

## Exercises 15.1

1. The figure shows the values of  $u(x, y)$  along the boundary. We need to determine  $u_{11}$  and  $u_{21}$ . The system is

$$u_{21} + 2 + 0 + 0 - 4u_{11} = 0 \quad \text{or} \quad -4u_{11} + u_{21} = -2$$

$$1 + 2 + u_{11} + 0 - 4u_{21} = 0 \quad \text{or} \quad u_{11} - 4u_{21} = -3.$$

Solving we obtain  $u_{11} = 11/15$  and  $u_{21} = 14/15$ .

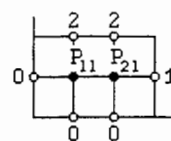

2. The figure shows the values of  $u(x, y)$  along the boundary. We need to determine  $u_{11}$ ,  $u_{21}$ , and  $u_{31}$ . By symmetry  $u_{11} = u_{31}$  and the system is

$$u_{21} + 0 + 0 + 100 - 4u_{11} = 0 \quad \text{or} \quad -4u_{11} + u_{21} = -100$$

$$u_{31} + 0 + u_{11} + 100 - 4u_{21} = 0 \quad \text{or} \quad 2u_{11} - 4u_{21} = -100.$$

$$0 + 0 + u_{21} + 100 - 4u_{31} = 0$$

Solving we obtain  $u_{11} = u_{31} = 250/7$  and  $u_{21} = 300/7$ .

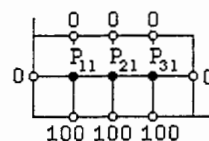

3. The figure shows the values of  $u(x, y)$  along the boundary. We need to determine  $u_{11}$ ,  $u_{21}$ ,  $u_{12}$ , and  $u_{22}$ . By symmetry  $u_{11} = u_{21}$  and  $u_{12} = u_{22}$ . The system is

$$u_{21} + u_{12} + 0 + 0 - 4u_{11} = 0 \quad \text{or} \quad 3u_{11} + u_{12} = 0$$

$$0 + u_{22} + u_{11} + 0 - 4u_{21} = 0 \quad \text{or} \quad u_{11} - 3u_{12} = -\frac{\sqrt{3}}{2}.$$

$$u_{22} + \sqrt{3}/2 + 0 + u_{11} - 4u_{12} = 0$$

$$0 + \sqrt{3}/2 + u_{12} + u_{21} - 4u_{22} = 0$$

Solving we obtain  $u_{11} = u_{21} = \sqrt{3}/16$  and  $u_{12} = u_{22} = 3\sqrt{3}/16$ .

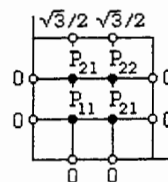

### Exercises 15.1

4. The figure shows the values of  $u(x, y)$  along the boundary. We need to determine  $u_{11}$ ,  $u_{21}$ ,  $u_{12}$ , and  $u_{22}$ . The system is

$$\begin{aligned} u_{21} + u_{12} + 8 + 0 - 4u_{11} &= 0 & -4u_{11} + u_{21} + u_{12} &= -8 \\ 0 + u_{22} + u_{11} + 0 - 4u_{21} &= 0 & u_{11} - 4u_{21} + u_{22} &= 0 \\ u_{22} + 0 + 16 + u_{11} - 4u_{12} &= 0 & \text{or} & & u_{11} - 4u_{12} + u_{22} &= -16 \\ 0 + 0 + u_{12} + u_{21} - 4u_{22} &= 0 & & & u_{21} + u_{12} - 4u_{22} &= 0. \end{aligned}$$

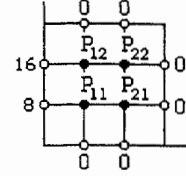

Solving we obtain  $u_{11} = 11/3$ ,  $u_{21} = 4/3$ ,  $u_{12} = 16/3$ , and  $u_{22} = 5/3$ .

5. The figure shows the values of  $u(x, y)$  along the boundary. For Gauss-Seidel the coefficients of the unknowns  $u_{11}$ ,  $u_{21}$ ,  $u_{31}$ ,  $u_{12}$ ,  $u_{22}$ ,  $u_{32}$ ,  $u_{13}$ ,  $u_{23}$ ,  $u_{33}$  are shown in the matrix

$$\begin{bmatrix} 0 & .25 & 0 & .25 & 0 & 0 & 0 & 0 & 0 \\ .25 & 0 & .25 & 0 & .25 & 0 & 0 & 0 & 0 \\ 0 & .25 & 0 & 0 & 0 & .25 & 0 & 0 & 0 \\ .25 & 0 & 0 & 0 & .25 & 0 & .25 & 0 & 0 \\ 0 & .25 & 0 & .25 & 0 & .25 & 0 & .25 & 0 \\ 0 & 0 & .25 & 0 & .25 & 0 & 0 & 0 & .25 \\ 0 & 0 & 0 & .25 & 0 & 0 & 0 & .25 & 0 \\ 0 & 0 & 0 & 0 & .25 & 0 & .25 & 0 & .25 \\ 0 & 0 & 0 & 0 & 0 & .25 & 0 & .25 & 0 \end{bmatrix}$$

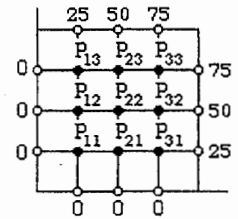

The constant terms in the equations are 0, 0, 6.25, 0, 0, 12.5, 6.25, 12.5, 37.5. We use 25 as the initial guess for each variable. Then  $u_{11} = 6.25$ ,  $u_{21} = u_{12} = 12.5$ ,  $u_{31} = u_{13} = 18.75$ ,  $u_{22} = 25$ ,  $u_{32} = u_{23} = 37.5$ , and  $u_{33} = 56.25$

6. The coefficients of the unknowns are the same as shown above in Problem 5. The constant terms are 7.5, 5, 20, 10, 0, 15, 17.5, 5, 27.5. We use 32.5 as the initial guess for each variable. Then  $u_{11} = 21.92$ ,  $u_{21} = 28.30$ ,  $u_{31} = 38.17$ ,  $u_{12} = 29.38$ ,  $u_{22} = 33.13$ ,  $u_{32} = 44.38$ ,  $u_{13} = 22.46$ ,  $u_{23} = 30.45$ , and  $u_{33} = 46.21$ .

7. (a) Using the difference approximations for  $u_{xx}$  and  $u_{yy}$  we obtain

$$u_{xx} + u_{yy} = \frac{1}{h^2}(u_{i+1,j} + u_{i,j+1} + u_{i-1,j} + u_{i,j-1} - 4u_{ij}) = f(x, y)$$

so that

$$u_{i+1,j} + u_{i,j+1} + u_{i-1,j} + u_{i,j-1} - 4u_{ij} = h^2 f(x, y).$$



Exercises 15.1

(b) By symmetry, as shown in the figure, we need only solve for  $u_1, u_2, u_3, u_4,$  and  $u_5$ . The difference equations are

$$\begin{aligned} u_2 + 0 + 0 + 1 - 4u_1 &= \frac{1}{4}(-2) \\ u_3 + 0 + u_1 + 1 - 4u_2 &= \frac{1}{4}(-2) \\ u_4 + 0 + u_2 + u_5 - 4u_3 &= \frac{1}{4}(-2) \\ 0 + 0 + u_3 + u_3 - 4u_4 &= \frac{1}{4}(-2) \\ u_3 + u_3 + 1 + 1 - 4u_5 &= \frac{1}{4}(-2) \end{aligned}$$

or

$$\begin{aligned} u_1 &= 0.25u_2 + 0.375 \\ u_2 &= 0.25u_1 + 0.25u_3 + 0.375 \\ u_3 &= 0.25u_2 + 0.25u_4 + 0.25u_5 + 0.125 \\ u_4 &= 0.5u_3 + 0.125 \\ u_5 &= 0.5u_3 + 0.625. \end{aligned}$$

Using Gauss-Seidel iteration we find  $u_1 = 0.5427, u_2 = 0.6707, u_3 = 0.6402, u_4 = 0.4451,$  and  $u_5 = 0.9451$ .

8. By symmetry, as shown in the figure, we need only solve for  $u_1, u_2, u_3, u_4,$  and  $u_5$ . The difference equations are

$$\begin{aligned} u_2 + 0 + 0 + u_3 - 4u_1 &= -1 & u_1 &= 0.25u_2 + 0.25u_3 + 0.25 \\ 0 + 0 + u_1 + u_4 - 4u_2 &= -1 & u_2 &= 0.25u_1 + 0.25u_4 + 0.25 \\ u_4 + u_1 + 0 + u_5 - 4u_3 &= -1 & \text{or } u_3 &= 0.25u_1 + 0.25u_4 + 0.25u_5 + 0.25 \\ u_2 + u_2 + u_3 + u_3 - 4u_4 &= -1 & u_4 &= 0.5u_2 + 0.5u_3 + 0.25 \\ u_3 + u_3 + 0 + 0 - 4u_5 &= -1 & u_5 &= 0.5u_3 + 0.25. \end{aligned}$$

Using Gauss-Seidel iteration we find  $u_1 = 0.6157, u_2 = 0.6493, u_3 = 0.8134, u_4 = 0.9813,$  and  $u_5 = 0.6567$ .

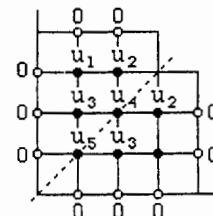
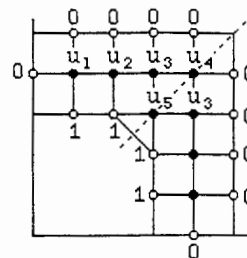

Exercises 15.2

**Exercises 15.2**

1. We identify  $c = 1$ ,  $a = 2$ ,  $T = 1$ ,  $n = 8$ , and  $m = 40$ . Then  $h = 2/8 = 0.25$ ,  $k = 1/40 = 0.025$ , and  $\lambda = 2/5 = 0.4$ .

TIME	X=0.25	X=0.50	X=0.75	X=1.00	X=1.25	X=1.50	X=1.75
0.000	1.0000	1.0000	1.0000	1.0000	0.0000	0.0000	0.0000
0.025	0.6000	1.0000	1.0000	0.6000	0.4000	0.0000	0.0000
0.050	0.5200	0.8400	0.8400	0.6800	0.3200	0.1600	0.0000
0.075	0.4400	0.7120	0.7760	0.6000	0.4000	0.1600	0.0640
0.100	0.3728	0.6288	0.6800	0.5904	0.3840	0.2176	0.0768
0.125	0.3261	0.5469	0.6237	0.5437	0.4000	0.2278	0.1024
0.150	0.2840	0.4893	0.5610	0.5182	0.3886	0.2465	0.1116
0.175	0.2525	0.4358	0.5152	0.4835	0.3836	0.2494	0.1209
0.200	0.2248	0.3942	0.4708	0.4562	0.3699	0.2517	0.1239
0.225	0.2027	0.3571	0.4343	0.4275	0.3571	0.2479	0.1255
0.250	0.1834	0.3262	0.4007	0.4021	0.3416	0.2426	0.1242
0.275	0.1672	0.2989	0.3715	0.3773	0.3262	0.2348	0.1219
0.300	0.1530	0.2752	0.3448	0.3545	0.3101	0.2262	0.1183
0.325	0.1407	0.2541	0.3209	0.3329	0.2943	0.2166	0.1141
0.350	0.1298	0.2354	0.2990	0.3126	0.2787	0.2067	0.1095
0.375	0.1201	0.2186	0.2790	0.2936	0.2635	0.1966	0.1046
0.400	0.1115	0.2034	0.2607	0.2757	0.2488	0.1865	0.0996
0.425	0.1036	0.1895	0.2438	0.2589	0.2347	0.1766	0.0945
0.450	0.0965	0.1769	0.2281	0.2432	0.2211	0.1670	0.0896
0.475	0.0901	0.1652	0.2136	0.2283	0.2083	0.1577	0.0847
0.500	0.0841	0.1545	0.2002	0.2144	0.1961	0.1487	0.0800
0.525	0.0786	0.1446	0.1876	0.2014	0.1845	0.1402	0.0755
0.550	0.0736	0.1354	0.1759	0.1891	0.1735	0.1320	0.0712
0.575	0.0689	0.1269	0.1650	0.1776	0.1632	0.1243	0.0670
0.600	0.0645	0.1189	0.1548	0.1668	0.1534	0.1169	0.0631
0.625	0.0605	0.1115	0.1452	0.1566	0.1442	0.1100	0.0594
0.650	0.0567	0.1046	0.1363	0.1471	0.1355	0.1034	0.0559
0.675	0.0532	0.0981	0.1279	0.1381	0.1273	0.0972	0.0525
0.700	0.0499	0.0921	0.1201	0.1297	0.1196	0.0914	0.0494
0.725	0.0468	0.0864	0.1127	0.1218	0.1124	0.0859	0.0464
0.750	0.0439	0.0811	0.1058	0.1144	0.1056	0.0807	0.0436
0.775	0.0412	0.0761	0.0994	0.1074	0.0992	0.0758	0.0410
0.800	0.0387	0.0715	0.0933	0.1009	0.0931	0.0712	0.0385
0.825	0.0363	0.0671	0.0876	0.0948	0.0875	0.0669	0.0362
0.850	0.0341	0.0630	0.0823	0.0890	0.0822	0.0628	0.0340
0.875	0.0320	0.0591	0.0772	0.0836	0.0772	0.0590	0.0319
0.900	0.0301	0.0555	0.0725	0.0785	0.0725	0.0554	0.0300
0.925	0.0282	0.0521	0.0681	0.0737	0.0681	0.0521	0.0282
0.950	0.0265	0.0490	0.0640	0.0692	0.0639	0.0489	0.0265
0.975	0.0249	0.0460	0.0601	0.0650	0.0600	0.0459	0.0249
1.000	0.0234	0.0432	0.0564	0.0610	0.0564	0.0431	0.0233

Exercises 15.2

2.

(x,y)	exact	approx	abs error
(0.25,0.1)	0.3794	0.3728	0.0066
(1,0.5)	0.1854	0.2144	0.0290
(1.5,0.8)	0.0623	0.0712	0.0089

3. We identify  $c = 1$ ,  $a = 2$ ,  $T = 1$ ,  $n = 8$ , and  $m = 40$ . Then  $h = 2/8 = 0.25$ ,  $k = 1/40 = 0.025$ , and  $\lambda = 2/5 = 0.4$ .

TIME	X=0.25	X=0.50	X=0.75	X=1.00	X=1.25	X=1.50	X=1.75
0.000	1.0000	1.0000	1.0000	1.0000	0.0000	0.0000	0.0000
0.025	0.7074	0.9520	0.9566	0.7444	0.2545	0.0371	0.0053
0.050	0.5606	0.8499	0.8685	0.6633	0.3303	0.1034	0.0223
0.075	0.4684	0.7473	0.7836	0.6191	0.3614	0.1529	0.0462
0.100	0.4015	0.6577	0.7084	0.5837	0.3753	0.1871	0.0684
0.125	0.3492	0.5821	0.6428	0.5510	0.3797	0.2101	0.0861
0.150	0.3069	0.5187	0.5857	0.5199	0.3778	0.2247	0.0990
0.175	0.2721	0.4652	0.5359	0.4901	0.3716	0.2329	0.1078
0.200	0.2430	0.4198	0.4921	0.4617	0.3622	0.2362	0.1132
0.225	0.2186	0.3809	0.4533	0.4348	0.3507	0.2358	0.1160
0.250	0.1977	0.3473	0.4189	0.4093	0.3378	0.2327	0.1166
0.275	0.1798	0.3181	0.3881	0.3853	0.3240	0.2275	0.1157
0.300	0.1643	0.2924	0.3604	0.3626	0.3097	0.2208	0.1136
0.325	0.1507	0.2697	0.3353	0.3412	0.2953	0.2131	0.1107
0.350	0.1387	0.2495	0.3125	0.3211	0.2808	0.2047	0.1071
0.375	0.1281	0.2313	0.2916	0.3021	0.2666	0.1960	0.1032
0.400	0.1187	0.2150	0.2725	0.2843	0.2528	0.1871	0.0989
0.425	0.1102	0.2002	0.2549	0.2675	0.2393	0.1781	0.0946
0.450	0.1025	0.1867	0.2387	0.2517	0.2263	0.1692	0.0902
0.475	0.0955	0.1743	0.2236	0.2368	0.2139	0.1606	0.0858
0.500	0.0891	0.1630	0.2097	0.2228	0.2020	0.1521	0.0814
0.525	0.0833	0.1525	0.1967	0.2096	0.1906	0.1439	0.0772
0.550	0.0779	0.1429	0.1846	0.1973	0.1798	0.1361	0.0731
0.575	0.0729	0.1339	0.1734	0.1856	0.1696	0.1285	0.0691
0.600	0.0683	0.1256	0.1628	0.1746	0.1598	0.1214	0.0653
0.625	0.0641	0.1179	0.1530	0.1643	0.1506	0.1145	0.0617
0.650	0.0601	0.1106	0.1438	0.1546	0.1419	0.1080	0.0582
0.675	0.0564	0.1039	0.1351	0.1455	0.1336	0.1018	0.0549
0.700	0.0530	0.0976	0.1270	0.1369	0.1259	0.0959	0.0518
0.725	0.0497	0.0917	0.1194	0.1288	0.1185	0.0904	0.0488
0.750	0.0467	0.0862	0.1123	0.1212	0.1116	0.0852	0.0460
0.775	0.0439	0.0810	0.1056	0.1140	0.1050	0.0802	0.0433
0.800	0.0413	0.0762	0.0993	0.1073	0.0989	0.0755	0.0408
0.825	0.0388	0.0716	0.0934	0.1009	0.0931	0.0711	0.0384
0.850	0.0365	0.0674	0.0879	0.0950	0.0876	0.0669	0.0362
0.875	0.0343	0.0633	0.0827	0.0894	0.0824	0.0630	0.0341
0.900	0.0323	0.0596	0.0778	0.0841	0.0776	0.0593	0.0321
0.925	0.0303	0.0560	0.0732	0.0791	0.0730	0.0558	0.0302
0.950	0.0285	0.0527	0.0688	0.0744	0.0687	0.0526	0.0284
0.975	0.0268	0.0496	0.0647	0.0700	0.0647	0.0495	0.0268
1.000	0.0253	0.0466	0.0609	0.0659	0.0608	0.0465	0.0252

### Exercises 15.2

(x,y)	exact	approx	abs error
(0.25,0.1)	0.3794	0.4015	0.0221
(1,0.5)	0.1854	0.2228	0.0374
(1.5,0.8)	0.0623	0.0755	0.0132

4. We identify  $c = 1$ ,  $a = 2$ ,  $T = 1$ ,  $n = 8$ , and  $m = 20$ . Then  $h = 2/8 = 0.25$ ,  $h = 1/20 = 0.05$ , and  $\lambda = 4/5 = 0.8$ .

TIME	X=0.25	X=0.50	X=0.75	X=1.00	X=1.25	X=1.50	X=1.75
0.00	1.00	1.00	1.00	1.00	0.00	0.00	0.00
0.05	0.20	1.00	1.00	0.20	0.80	0.00	0.00
0.10	0.68	0.36	0.36	1.32	-0.32	0.64	0.00
0.15	-0.12	0.62	1.13	-0.76	1.76	-0.64	0.51
0.20	0.56	0.44	-0.79	2.77	-2.18	2.20	-0.82
0.25	0.01	-0.44	3.04	-4.03	5.28	-3.72	2.25
0.30	-0.36	2.70	-5.41	9.07	-9.37	8.26	-4.33
0.35	2.38	-6.24	12.67	-17.26	19.49	-15.91	9.20
0.40	-6.42	15.78	-26.40	36.08	-38.23	32.50	-18.25
0.45	16.47	-35.72	57.33	-73.35	77.80	-64.68	36.94
0.50	-38.46	80.48	-121.66	152.12	-157.11	130.60	-73.91
0.55	87.46	-176.38	259.07	-314.28	320.44	-263.18	148.83
0.60	-193.58	383.05	-547.97	652.17	-654.23	533.32	-299.84
0.65	422.59	-823.07	1156.96	-1353.07	1340.93	-1083.25	606.56
0.70	-912.01	1757.48	-2435.09	2810.16	-2753.61	2207.94	-1230.53
0.75	1953.19	-3732.17	5115.16	-5837.05	5666.65	-4512.08	2504.67
0.80	-4157.65	7893.99	-10724.47	12127.68	-11679.29	9244.30	-5112.47
0.85	8809.78	-16642.09	22452.02	-25199.62	24105.16	-18979.99	10462.92
0.90	-18599.54	34994.69	-46944.58	52365.51	-49806.79	39042.46	-21461.75
0.95	39155.48	-73432.11	98054.91	-108820.40	103010.45	-80440.31	44111.02
1.00	-82238.97	153827.58	-204634.95	226144.53	-213214.84	165961.36	-90818.86

(x,y)	exact	approx	abs error
(0.25,0.1)	0.3794	0.6800	0.3006
(1,0.5)	0.1854	152.1152	151.9298
(1.5,0.8)	0.0623	9244.3042	9244.2419

In this case  $\lambda = 0.8$  is greater than 0.5 and the procedure is unstable.

Exercises 15.2

5. We identify  $c = 1$ ,  $a = 2$ ,  $T = 1$ ,  $n = 8$ , and  $m = 20$ . Then  $h = 2/8 = 0.25$ ,  $k = 1/20 = 0.05$ , and  $\lambda = 4/5 = 0.8$ .

TIME	X=0.25	X=0.50	X=0.75	X=1.00	X=1.25	X=1.50	X=1.75
0.00	1.0000	1.0000	1.0000	1.0000	0.0000	0.0000	0.0000
0.05	0.5265	0.8693	0.8852	0.6141	0.3783	0.0884	0.0197
0.10	0.3972	0.6551	0.7043	0.5883	0.3723	0.1955	0.0653
0.15	0.3042	0.5150	0.5844	0.5192	0.3812	0.2261	0.1010
0.20	0.2409	0.4171	0.4901	0.4620	0.3636	0.2385	0.1145
0.25	0.1962	0.3452	0.4174	0.4092	0.3391	0.2343	0.1178
0.30	0.1631	0.2908	0.3592	0.3624	0.3105	0.2220	0.1145
0.35	0.1379	0.2482	0.3115	0.3208	0.2813	0.2056	0.1077
0.40	0.1181	0.2141	0.2718	0.2840	0.2530	0.1876	0.0993
0.45	0.1020	0.1860	0.2381	0.2514	0.2265	0.1696	0.0904
0.50	0.0888	0.1625	0.2092	0.2226	0.2020	0.1523	0.0816
0.55	0.0776	0.1425	0.1842	0.1970	0.1798	0.1361	0.0732
0.60	0.0681	0.1253	0.1625	0.1744	0.1597	0.1214	0.0654
0.65	0.0599	0.1104	0.1435	0.1544	0.1418	0.1079	0.0582
0.70	0.0528	0.0974	0.1268	0.1366	0.1257	0.0959	0.0518
0.75	0.0466	0.0860	0.1121	0.1210	0.1114	0.0851	0.0460
0.80	0.0412	0.0760	0.0991	0.1071	0.0987	0.0754	0.0408
0.85	0.0364	0.0672	0.0877	0.0948	0.0874	0.0668	0.0361
0.90	0.0322	0.0594	0.0776	0.0839	0.0774	0.0592	0.0320
0.95	0.0285	0.0526	0.0687	0.0743	0.0686	0.0524	0.0284
1.00	0.0252	0.0465	0.0608	0.0657	0.0607	0.0464	0.0251

(x,y)	exact	approx	abs error
(0.25,0.1)	0.3794	0.3972	0.0178
(1,0.5)	0.1854	0.2226	0.0372
(1.5,0.8)	0.0623	0.0754	0.0131

6. (a) We identify  $c = 15/88 \approx 0.1705$ ,  $a = 20$ ,  $T = 10$ ,  $n = 10$ , and  $m = 10$ . Then  $h = 2$ ,  $k = 1$ , and  $\lambda = 15/352 \approx 0.0426$ .

TIME	X=2	X=4	X=6	X=8	X=10	X=12	X=14	X=16	X=18
0	30.0000	30.0000	30.0000	30.0000	30.0000	30.0000	30.0000	30.0000	30.0000
1	28.7216	30.0000	30.0000	30.0000	30.0000	30.0000	30.0000	30.0000	28.7216
2	27.5521	29.9455	30.0000	30.0000	30.0000	30.0000	30.0000	29.9455	27.5521
3	26.4800	29.8459	29.9977	30.0000	30.0000	30.0000	29.9977	29.8459	26.4800
4	25.4951	29.7089	29.9913	29.9999	30.0000	29.9999	29.9913	29.7089	25.4951
5	24.5882	29.5414	29.9796	29.9995	30.0000	29.9995	29.9796	29.5414	24.5882
6	23.7515	29.3490	29.9618	29.9987	30.0000	29.9987	29.9618	29.3490	23.7515
7	22.9779	29.1365	29.9373	29.9972	29.9998	29.9972	29.9373	29.1365	22.9779
8	22.2611	28.9082	29.9057	29.9948	29.9996	29.9948	29.9057	28.9082	22.2611
9	21.5958	28.6675	29.8670	29.9912	29.9992	29.9912	29.8670	28.6675	21.5958
10	20.9768	28.4172	29.8212	29.9862	29.9985	29.9862	29.8212	28.4172	20.9768

Exercises 15.2

- (b) We identify  $c = 15/88 \approx 0.1705$ ,  $a = 50$ ,  $T = 10$ ,  $n = 10$ , and  $m = 10$ . Then  $h = 5$ ,  $k = 1$ , and  $\lambda = 3/440 \approx 0.0068$ .

TIME	X=5	X=10	X=15	X=20	X=25	X=30	X=35	X=40	X=45
0	30.0000	30.0000	30.0000	30.0000	30.0000	30.0000	30.0000	30.0000	30.0000
1	29.7955	30.0000	30.0000	30.0000	30.0000	30.0000	30.0000	30.0000	29.7955
2	29.5937	29.9986	30.0000	30.0000	30.0000	30.0000	30.0000	29.9986	29.5937
3	29.3947	29.9959	30.0000	30.0000	30.0000	30.0000	30.0000	29.9959	29.3947
4	29.1984	29.9918	30.0000	30.0000	30.0000	30.0000	30.0000	29.9918	29.1984
5	29.0047	29.9864	29.9999	30.0000	30.0000	30.0000	29.9999	29.9864	29.0047
6	28.8136	29.9798	29.9998	30.0000	30.0000	30.0000	29.9998	29.9798	28.8136
7	28.6251	29.9720	29.9997	30.0000	30.0000	30.0000	29.9997	29.9720	28.6251
8	28.4391	29.9630	29.9995	30.0000	30.0000	30.0000	29.9995	29.9630	28.4391
9	28.2556	29.9529	29.9992	30.0000	30.0000	30.0000	29.9992	29.9529	28.2556
10	28.0745	29.9416	29.9989	30.0000	30.0000	30.0000	29.9989	29.9416	28.0745

- (c) We identify  $c = 50/27 \approx 1.8519$ ,  $a = 20$ ,  $T = 10$ ,  $n = 10$ , and  $m = 10$ . Then  $h = 2$ ,  $k = 1$ , and  $\lambda = 25/54 \approx 0.4630$ .

TIME	X=2	X=4	X=6	X=8	X=10	X=12	X=14	X=16	X=18
0	18.0000	32.0000	42.0000	48.0000	50.0000	48.0000	42.0000	32.0000	18.0000
1	16.1481	30.1481	40.1481	46.1481	48.1481	46.1481	40.1481	30.1481	16.1481
2	15.1536	28.2963	38.2963	44.2963	46.2963	44.2963	38.2963	28.2963	15.1536
3	14.2226	26.8414	36.4444	42.4444	44.4444	42.4444	36.4444	26.8414	14.2226
4	13.4801	25.4452	34.7764	40.5926	42.5926	40.5926	34.7764	25.4452	13.4801
5	12.7787	24.2258	33.1491	38.8258	40.7407	38.8258	33.1491	24.2258	12.7787
6	12.1622	23.0574	31.6460	37.0842	38.9677	37.0842	31.6460	23.0574	12.1622
7	11.5756	21.9895	30.1875	35.4385	37.2238	35.4385	30.1875	21.9895	11.5756
8	11.0378	20.9636	28.8232	33.8340	35.5707	33.8340	28.8232	20.9636	11.0378
9	10.5230	20.0070	27.5043	32.3182	33.9626	32.3182	27.5043	20.0070	10.5230
10	10.0420	19.0872	26.2620	30.8509	32.4400	30.8509	26.2620	19.0872	10.0420

- (d) We identify  $c = 260/159 \approx 1.6352$ ,  $a = 100$ ,  $T = 10$ ,  $n = 10$ , and  $m = 10$ . Then  $h = 10$ ,  $k = 1$ , and  $\lambda = 13/795 \approx 0.0164$ .

TIME	X=10	X=20	X=30	X=40	X=50	X=60	X=70	X=80	X=90
0	8.0000	16.0000	24.0000	32.0000	40.0000	32.0000	24.0000	16.0000	8.0000
1	8.0000	16.0000	23.6075	31.3459	39.2151	31.6075	23.7384	15.8692	8.0000
2	8.0000	15.9936	23.2279	30.7068	38.4452	31.2151	23.4789	15.7384	7.9979
3	7.9999	15.9812	22.8606	30.0824	37.6900	30.8229	23.2214	15.6076	7.9937
4	7.9996	15.9631	22.5050	29.4724	36.9492	30.4312	22.9660	15.4769	7.9874
5	7.9990	15.9399	22.1606	28.8765	36.2228	30.0401	22.7125	15.3463	7.9793
6	7.9981	15.9118	21.8270	28.2945	35.5103	29.6500	22.4610	15.2158	7.9693
7	7.9967	15.8791	21.5037	27.7261	34.8117	29.2610	22.2112	15.0854	7.9575
8	7.9948	15.8422	21.1902	27.1709	34.1266	28.8733	21.9633	14.9553	7.9439
9	7.9924	15.8013	20.8861	26.6288	33.4548	28.4870	21.7172	14.8253	7.9287
10	7.9894	15.7568	20.5911	26.0995	32.7961	28.1024	21.4727	14.6956	7.9118

Exercises 15.2

7. (a) We identify  $c = 15/88 \approx 0.1705$ ,  $a = 20$ ,  $T = 10$ ,  $n = 10$ , and  $m = 10$ . Then  $h = 2$ ,  $k = 1$ , and  $\lambda = 15/352 \approx 0.0426$ .

TIME	X=2.00	X=4.00	X=6.00	X=8.00	X=10.00	X=12.00	X=14.00	X=16.00	X=18.00
0.00	30.0000	30.0000	30.0000	30.0000	30.0000	30.0000	30.0000	30.0000	30.0000
1.00	28.7733	29.9749	29.9995	30.0000	30.0000	30.0000	29.9995	29.9749	28.7733
2.00	27.6450	29.9037	29.9970	29.9999	30.0000	29.9999	29.9970	29.9037	27.6450
3.00	26.6051	29.7938	29.9911	29.9997	30.0000	29.9997	29.9911	29.7938	26.6051
4.00	25.6452	29.6517	29.9805	29.9991	29.9999	29.9991	29.9805	29.6517	25.6452
5.00	24.7573	29.4829	29.9643	29.9981	29.9998	29.9981	29.9643	29.4829	24.7573
6.00	23.9347	29.2922	29.9421	29.9963	29.9996	29.9963	29.9421	29.2922	23.9347
7.00	23.1711	29.0836	29.9134	29.9936	29.9992	29.9936	29.9134	29.0836	23.1711
8.00	22.4612	28.8606	29.8782	29.9898	29.9986	29.9898	29.8782	28.8606	22.4612
9.00	21.7999	28.6263	29.8362	29.9848	29.9977	29.9848	29.8362	28.6263	21.7999
10.00	21.1829	28.3831	29.7878	29.9782	29.9964	29.9782	29.7878	28.3831	21.1829

- (b) We identify  $c = 15/88 \approx 0.1705$ ,  $a = 50$ ,  $T = 10$ ,  $n = 10$ , and  $m = 10$ . Then  $h = 5$ ,  $k = 1$ , and  $\lambda = 3/440 \approx 0.0068$ .

TIME	X=5.00	X=10.00	X=15.00	X=20.00	X=25.00	X=30.00	X=35.00	X=40.00	X=45.00
0.00	30.0000	30.0000	30.0000	30.0000	30.0000	30.0000	30.0000	30.0000	30.0000
1.00	29.7968	29.9993	30.0000	30.0000	30.0000	30.0000	30.0000	29.9993	29.7968
2.00	29.5964	29.9973	30.0000	30.0000	30.0000	30.0000	30.0000	29.9973	29.5964
3.00	29.3987	29.9939	30.0000	30.0000	30.0000	30.0000	30.0000	29.9939	29.3987
4.00	29.2036	29.9893	29.9999	30.0000	30.0000	30.0000	29.9999	29.9893	29.2036
5.00	29.0112	29.9834	29.9998	30.0000	30.0000	30.0000	29.9998	29.9834	29.0112
6.00	28.8212	29.9762	29.9997	30.0000	30.0000	30.0000	29.9997	29.9762	28.8212
7.00	28.6339	29.9679	29.9995	30.0000	30.0000	30.0000	29.9995	29.9679	28.6339
8.00	28.4490	29.9585	29.9992	30.0000	30.0000	30.0000	29.9992	29.9585	28.4490
9.00	28.2665	29.9479	29.9989	30.0000	30.0000	30.0000	29.9989	29.9479	28.2665
10.00	28.0864	29.9363	29.9986	30.0000	30.0000	30.0000	29.9986	29.9363	28.0864

- (c) We identify  $c = 50/27 \approx 1.8519$ ,  $a = 20$ ,  $T = 10$ ,  $n = 10$ , and  $m = 10$ . Then  $h = 2$ ,  $k = 1$ , and  $\lambda = 25/54 \approx 0.4630$ .

TIME	X=2.00	X=4.00	X=6.00	X=8.00	X=10.00	X=12.00	X=14.00	X=16.00	X=18.00
0.00	18.0000	32.0000	42.0000	48.0000	50.0000	48.0000	42.0000	32.0000	18.0000
1.00	16.4489	30.1970	40.1561	46.1495	48.1486	46.1495	40.1561	30.1970	16.4489
2.00	15.3312	28.5348	38.3465	44.3067	46.3001	44.3067	38.3465	28.5348	15.3312
3.00	14.4216	27.0416	36.6031	42.4847	44.4619	42.4847	36.6031	27.0416	14.4216
4.00	13.6371	25.6867	34.9416	40.6988	42.6453	40.6988	34.9416	25.6867	13.6371
5.00	12.9378	24.4419	33.3628	38.9611	40.8634	38.9611	33.3628	24.4419	12.9378
6.00	12.3012	23.2863	31.8624	37.2794	39.1273	37.2794	31.8624	23.2863	12.3012
7.00	11.7137	22.2051	30.4350	35.6578	37.4446	35.6578	30.4350	22.2051	11.7137
8.00	11.1659	21.1877	29.0757	34.0984	35.8202	34.0984	29.0757	21.1877	11.1659
9.00	10.6517	20.2261	27.7799	32.6014	34.2567	32.6014	27.7799	20.2261	10.6517
10.00	10.1665	19.3143	26.5439	31.1662	32.7549	31.1662	26.5439	19.3143	10.1665

**Exercises 15.2**

- (d) We identify  $c = 260/159 \approx 1.6352$ ,  $a = 100$ ,  $T = 10$ ,  $n = 10$ , and  $m = 10$ . Then  $h = 10$ ,  $k = 1$ , and  $\lambda = 13/795 \approx 00164$ .

TIME	X=10.00	X=20.00	X=30.00	X=40.00	X=50.00	X=60.00	X=70.00	X=80.00	X=90.00
0.00	8.0000	16.0000	24.0000	32.0000	40.0000	32.0000	24.0000	16.0000	8.0000
1.00	8.0000	16.0000	24.0000	31.9979	39.7425	31.9979	24.0000	16.0000	8.0000
2.00	8.0000	16.0000	23.9999	31.9918	39.4932	31.9918	23.9999	16.0000	8.0000
3.00	8.0000	16.0000	23.9997	31.9820	39.2517	31.9820	23.9997	16.0000	8.0000
4.00	8.0000	16.0000	23.9993	31.9687	39.0176	31.9687	23.9993	16.0000	8.0000
5.00	8.0000	16.0000	23.9987	31.9520	38.7905	31.9520	23.9987	16.0000	8.0000
6.00	8.0000	15.9999	23.9978	31.9323	38.5701	31.9323	23.9978	15.9999	8.0000
7.00	8.0000	15.9999	23.9966	31.9097	38.3561	31.9097	23.9966	15.9999	8.0000
8.00	8.0000	15.9998	23.9951	31.8844	38.1483	31.8844	23.9951	15.9998	8.0000
9.00	8.0000	15.9997	23.9931	31.8566	37.9463	31.8566	23.9931	15.9997	8.0000
10.00	8.0000	15.9996	23.9908	31.8265	37.7499	31.8265	23.9908	15.9996	8.0000

8. (a) We identify  $c = 15/88 \approx 0.1705$ ,  $a = 20$ ,  $T = 10$ ,  $n = 10$ , and  $m = 10$ . Then  $h = 2$ ,  $k = 1$ , and  $\lambda = 15/352 \approx 0.0426$ .

TIME	X=2	X=4	X=6	X=8	X=10	X=12	X=14	X=16	X=18
0	30.0000	30.0000	30.0000	30.0000	30.0000	30.0000	30.0000	30.0000	30.0000
1	28.7216	30.0000	30.0000	30.0000	30.0000	30.0000	30.0000	30.0000	29.5739
2	27.5521	29.9455	30.0000	30.0000	30.0000	30.0000	30.0000	29.9818	29.1840
3	26.4800	29.8459	29.9977	30.0000	30.0000	30.0000	29.9992	29.9486	28.8267
4	25.4951	29.7089	29.9913	29.9999	30.0000	30.0000	29.9971	29.9030	28.4984
5	24.5882	29.5414	29.9796	29.9995	30.0000	29.9998	29.9932	29.8471	28.1961
6	23.7515	29.3490	29.9618	29.9987	30.0000	29.9996	29.9873	29.7830	27.9172
7	22.9779	29.1365	29.9373	29.9972	29.9999	29.9991	29.9791	29.7122	27.6593
8	22.2611	28.9082	29.9057	29.9948	29.9997	29.9982	29.9686	29.6361	27.4204
9	21.5958	28.6675	29.8670	29.9912	29.9995	29.9970	29.9557	29.5558	27.1986
10	20.9768	28.4172	29.8212	29.9862	29.9990	29.9954	29.9404	29.4724	26.9923

- (b) We identify  $c = 15/88 \approx 0.1705$ ,  $a = 50$ ,  $T = 10$ ,  $n = 10$ , and  $m = 10$ . Then  $h = 5$ ,  $k = 1$ , and  $\lambda = 3/440 \approx 0.0068$ .

TIME	X=5	X=10	X=15	X=20	X=25	X=30	X=35	X=40	X=45
0	30.0000	30.0000	30.0000	30.0000	30.0000	30.0000	30.0000	30.0000	30.0000
1	29.7955	30.0000	30.0000	30.0000	30.0000	30.0000	30.0000	30.0000	29.9318
2	29.5937	29.9986	30.0000	30.0000	30.0000	30.0000	30.0000	29.9995	29.8646
3	29.3947	29.9959	30.0000	30.0000	30.0000	30.0000	30.0000	29.9986	29.7982
4	29.1984	29.9918	30.0000	30.0000	30.0000	30.0000	30.0000	29.9973	29.7328
5	29.0047	29.9864	29.9999	30.0000	30.0000	30.0000	30.0000	29.9955	29.6682
6	28.8136	29.9798	29.9998	30.0000	30.0000	30.0000	29.9999	29.9933	29.6045
7	28.6251	29.9720	29.9997	30.0000	30.0000	30.0000	29.9999	29.9907	29.5417
8	28.4391	29.9630	29.9995	30.0000	30.0000	30.0000	29.9998	29.9877	29.4797
9	28.2556	29.9529	29.9992	30.0000	30.0000	30.0000	29.9997	29.9843	29.4185
10	28.0745	29.9416	29.9989	30.0000	30.0000	30.0000	29.9996	29.9805	29.3582



Exercises 15.2

- (c) We identify  $c = 50/27 \approx 1.8519$ ,  $a = 20$ ,  $T = 10$ ,  $n = 10$ , and  $m = 10$ . Then  $h = 2$ ,  $k = 1$ , and  $\lambda = 25/54 \approx 0.4630$ .

TIME	X=2	X=4	X=6	X=8	X=10	X=12	X=14	X=16	X=18
0	18.0000	32.0000	42.0000	48.0000	50.0000	48.0000	42.0000	32.0000	18.0000
1	16.1481	30.1481	40.1481	46.1481	48.1481	46.1481	40.1481	30.1481	16.1481
2	15.1536	28.2963	38.2963	44.2963	46.2963	44.2963	38.2963	28.2963	15.1536
3	14.2226	26.8414	36.4444	42.4444	44.4444	42.4444	36.4290	26.7631	14.2031
4	13.4801	25.4452	34.7764	40.5926	42.5926	41.5114	37.2019	32.2751	25.9054
5	12.7787	24.2258	33.1491	38.8258	41.1661	40.0168	36.9161	31.6071	26.1204
6	12.1622	23.0574	31.6460	37.2812	39.5506	39.1134	35.8938	31.5248	25.8270
7	11.5756	21.9895	30.2787	35.7230	38.2975	37.8252	35.3617	30.9096	25.7672
8	11.0378	21.0058	28.9616	34.3944	36.8869	36.9033	34.4411	30.5900	25.4779
9	10.5425	20.0742	27.7936	33.0332	35.7406	35.7558	33.7981	30.0062	25.3086
10	10.0746	19.2352	26.6455	31.8608	34.4942	34.8424	32.9489	29.5869	25.0257

- (d) We identify  $c = 260/159 \approx 1.6352$ ,  $a = 100$ ,  $T = 10$ ,  $n = 10$ , and  $m = 10$ . Then  $h = 10$ ,  $k = 1$ , and  $\lambda = 13/795 \approx 0.0164$ .

TIME	X=10	X=20	X=30	X=40	X=50	X=60	X=70	X=80	X=90
0	8.0000	16.0000	24.0000	32.0000	40.0000	32.0000	24.0000	16.0000	8.0000
1	8.0000	16.0000	23.6075	31.6730	39.2151	31.6075	23.7384	15.8692	8.0000
2	8.0000	15.9936	23.2279	31.3502	38.4505	31.2151	23.4789	15.7384	7.9979
3	7.9999	15.9812	22.8606	31.0318	37.7057	30.8230	23.2214	15.6076	7.9937
4	7.9996	15.9631	22.5050	30.7178	36.9800	30.4315	22.9660	15.4769	7.9874
5	7.9990	15.9399	22.1606	30.4082	36.2728	30.0410	22.7126	15.3463	7.9793
6	7.9981	15.9118	21.8270	30.1031	35.5838	29.6516	22.4610	15.2158	7.9693
7	7.9967	15.8791	21.5037	29.8026	34.9123	29.2638	22.2113	15.0854	7.9575
8	7.9948	15.8422	21.1902	29.5066	34.2579	28.8776	21.9634	14.9553	7.9439
9	7.9924	15.8013	20.8861	29.2152	33.6200	28.4934	21.7173	14.8253	7.9287
10	7.9894	15.7568	20.5911	28.9283	32.9982	28.1113	21.4730	14.6956	7.9118

9. (a) We identify  $c = 15/88 \approx 0.1705$ ,  $a = 20$ ,  $T = 10$ ,  $n = 10$ , and  $m = 10$ . Then  $h = 2$ ,  $k = 1$ , and  $\lambda = 15/352 \approx 0.0426$ .

TIME	X=2.00	X=4.00	X=6.00	X=8.00	X=10.00	X=12.00	X=14.00	X=16.00	X=18.00
0.00	30.0000	30.0000	30.0000	30.0000	30.0000	30.0000	30.0000	30.0000	30.0000
1.00	28.7733	29.9749	29.9995	30.0000	30.0000	30.0000	29.9998	29.9916	29.5911
2.00	27.6450	29.9037	29.9970	29.9999	30.0000	30.0000	29.9990	29.9679	29.2150
3.00	26.6051	29.7938	29.9911	29.9997	30.0000	29.9999	29.9970	29.9313	28.8684
4.00	25.6452	29.6517	29.9805	29.9991	30.0000	29.9997	29.9935	29.8839	28.5484
5.00	24.7573	29.4829	29.9643	29.9981	29.9999	29.9994	29.9881	29.8276	28.2524
6.00	23.9347	29.2922	29.9421	29.9963	29.9997	29.9988	29.9807	29.7641	27.9782
7.00	23.1711	29.0836	29.9134	29.9936	29.9995	29.9979	29.9711	29.6945	27.7237
8.00	22.4612	28.8606	29.8782	29.9899	29.9991	29.9966	29.9594	29.6202	27.4870
9.00	21.7999	28.6263	29.8362	29.9848	29.9985	29.9949	29.9454	29.5421	27.2666
10.00	21.1829	28.3831	29.7878	29.9783	29.9976	29.9927	29.9293	29.4610	27.0610

Exercises 15.2

- (b) We identify  $c = 15/88 \approx 0.1705$ ,  $a = 50$ ,  $T = 10$ ,  $n = 10$ , and  $m = 10$ . Then  $h = 5$ ,  $k = 1$ , and  $\lambda = 3/440 \approx 0.0068$ .

TIME	X=5.00	X=10.00	X=15.00	X=20.00	X=25.00	X=30.00	X=35.00	X=40.00	X=45.00
0.00	30.0000	30.0000	30.0000	30.0000	30.0000	30.0000	30.0000	30.0000	30.0000
1.00	29.7968	29.9993	30.0000	30.0000	30.0000	30.0000	30.0000	29.9998	29.9323
2.00	29.5964	29.9973	30.0000	30.0000	30.0000	30.0000	30.0000	29.9991	29.8655
3.00	29.3987	29.9939	30.0000	30.0000	30.0000	30.0000	30.0000	29.9980	29.7996
4.00	29.2036	29.9893	29.9999	30.0000	30.0000	30.0000	30.0000	29.9964	29.7345
5.00	29.0112	29.9834	29.9998	30.0000	30.0000	30.0000	29.9999	29.9945	29.6704
6.00	28.8212	29.9762	29.9997	30.0000	30.0000	30.0000	29.9999	29.9921	29.6071
7.00	28.6339	29.9679	29.9995	30.0000	30.0000	30.0000	29.9998	29.9893	29.5446
8.00	28.4490	29.9585	29.9992	30.0000	30.0000	30.0000	29.9997	29.9862	29.4830
9.00	28.2665	29.9479	29.9989	30.0000	30.0000	30.0000	29.9996	29.9827	29.4222
10.00	28.0864	29.9363	29.9986	30.0000	30.0000	30.0000	29.9995	29.9788	29.3621

- (c) We identify  $c = 50/27 \approx 1.8519$ ,  $a = 20$ ,  $T = 10$ ,  $n = 10$ , and  $m = 10$ . Then  $h = 2$ ,  $k = 1$ , and  $\lambda = 25/54 \approx 0.4630$ .

TIME	X=2.00	X=4.00	X=6.00	X=8.00	X=10.00	X=12.00	X=14.00	X=16.00	X=18.00
0.00	18.0000	32.0000	42.0000	48.0000	50.0000	48.0000	42.0000	32.0000	18.0000
1.00	16.4489	30.1970	40.1562	46.1502	48.1531	46.1773	40.3274	31.2520	22.9449
2.00	15.3312	28.5350	38.3477	44.3130	46.3327	44.4671	39.0872	31.5755	24.6930
3.00	14.4219	27.0429	36.6090	42.5113	44.5759	42.9362	38.1976	31.7478	25.4131
4.00	13.6381	25.6913	34.9606	40.7728	42.9127	41.5716	37.4340	31.7086	25.6986
5.00	12.9409	24.4545	33.4091	39.1182	41.3519	40.3240	36.7033	31.5136	25.7663
6.00	12.3088	23.3146	31.9546	37.5566	39.8880	39.1565	35.9745	31.2134	25.7128
7.00	11.7294	22.2589	30.5939	36.0884	38.5109	38.0470	35.2407	30.8434	25.5871
8.00	11.1946	21.2785	29.3217	34.7092	37.2109	36.9834	34.5032	30.4279	25.4167
9.00	10.6987	20.3660	28.1318	33.4130	35.9801	35.9591	33.7660	29.9836	25.2181
10.00	10.2377	19.5150	27.0178	32.1929	34.8117	34.9710	33.0338	29.5224	25.0019

- (d) We identify  $c = 260/159 \approx 1.6352$ ,  $a = 100$ ,  $T = 10$ ,  $n = 10$ , and  $m = 10$ . Then  $h = 10$ ,  $k = 1$ , and  $\lambda = 13/795 \approx 0.0164$ .

TIME	X=10.00	X=20.00	X=30.00	X=40.00	X=50.00	X=60.00	X=70.00	X=80.00	X=90.00
0.00	8.0000	16.0000	24.0000	32.0000	40.0000	32.0000	24.0000	16.0000	8.0000
1.00	8.0000	16.0000	24.0000	31.9979	39.7425	31.9979	24.0000	16.0026	8.3218
2.00	8.0000	16.0000	23.9999	31.9918	39.4932	31.9918	24.0000	16.0102	8.6333
3.00	8.0000	16.0000	23.9997	31.9820	39.2517	31.9820	24.0001	16.0225	8.9350
4.00	8.0000	16.0000	23.9993	31.9687	39.0176	31.9687	24.0002	16.0392	9.2272
5.00	8.0000	16.0000	23.9987	31.9520	38.7905	31.9521	24.0003	16.0599	9.5103
6.00	8.0000	15.9999	23.9978	31.9323	38.5701	31.9324	24.0005	16.0845	9.7846
7.00	8.0000	15.9999	23.9966	31.9097	38.3561	31.9098	24.0008	16.1126	10.0506
8.00	8.0000	15.9998	23.9951	31.8844	38.1483	31.8846	24.0012	16.1441	10.3084
9.00	8.0000	15.9997	23.9931	31.8566	37.9463	31.8569	24.0017	16.1786	10.5585
10.00	8.0000	15.9996	23.9908	31.8265	37.7499	31.8270	24.0023	16.2160	10.8012

10. (a) With  $n = 4$  we have  $h = 1/2$  so that  $\lambda = 1/100 = 0.01$ .

- (b) We observe that  $\alpha = 2(1 + 1/\lambda) = 202$  and  $\beta = 2(1 - 1/\lambda) = -198$ . The system of equations is

$$-u_{01} + \alpha u_{11} - u_{21} = u_{20} - \beta u_{10} + u_{00}$$

$$-u_{11} + \alpha u_{21} - u_{31} = u_{30} - \beta u_{20} + u_{10}$$

$$-u_{21} + \alpha u_{31} - u_{41} = u_{40} - \beta u_{30} + u_{20}.$$

Now  $u_{00} = u_{01} = u_{40} = u_{41} = 0$ , so the system is

$$\alpha u_{11} - u_{21} = u_{20} - \beta u_{10}$$

$$-u_{11} + \alpha u_{21} - u_{31} = u_{30} - \beta u_{20} + u_{10}$$

$$-u_{21} + \alpha u_{31} = -\beta u_{30} + u_{20}$$

or

$$202u_{11} - u_{21} = \sin \pi + 198 \sin \frac{\pi}{2} = 198$$

$$-u_{11} + 202u_{21} - u_{31} = \sin \frac{3\pi}{2} + 198 \sin \pi + \sin \frac{\pi}{2} = 0$$

$$-u_{21} + 202u_{31} = 198 \sin \frac{3\pi}{2} + \sin \pi = -198.$$

- (c) The solution of this system is  $u_{11} \approx 0.9802$ ,  $u_{21} = 0$ ,  $u_{31} \approx -0.9802$ . The corresponding entries in Table 15.4 in the text are 0.9768, 0, and  $-0.9768$ .

11. (a) The differential equation is  $k \frac{\partial^2 u}{\partial x^2} = \frac{\partial u}{\partial t}$  where  $k = K/\gamma\rho$ . If we let  $u(x, t) = v(x, t) + \psi(x)$ , then

$$\frac{\partial^2 u}{\partial x^2} = \frac{\partial^2 v}{\partial x^2} + \psi'' \quad \text{and} \quad \frac{\partial u}{\partial t} = \frac{\partial v}{\partial t}.$$

Substituting into the differential equation gives

$$k \frac{\partial^2 v}{\partial x^2} + k\psi'' = \frac{\partial v}{\partial t}.$$

Requiring  $k\psi'' = 0$  we have  $\psi(x) = c_1x + c_2$ . The boundary conditions become

$$u(0, t) = v(0, t) + \psi(0) = 20 \quad \text{and} \quad u(20, t) = v(20, t) + \psi(20) = 30.$$

Letting  $\psi(0) = 20$  and  $\psi(20) = 30$  we obtain the homogeneous boundary conditions in  $v$ :  $v(0, t) = v(20, t) = 0$ . Now  $\psi(0) = 20$  and  $\psi(20) = 30$  imply that  $c_1 = 1/2$  and  $c_2 = 20$ . The steady-state solution is  $\psi(x) = \frac{1}{2}x + 20$ .

### Exercises 15.2

- (b) To use the Crank-Nicholson method we identify  $c = 375/212 \approx 1.7689$ ,  $a = 20$ ,  $T = 400$ ,  $n = 5$ , and  $m = 40$ . Then  $h = 4$ ,  $k = 10$ , and  $\lambda = 1875/1696 \approx 1.1055$ .

TIME	X=4.00	X=8.00	X=12.00	X=16.00
0.00	50.0000	50.0000	50.0000	50.0000
10.00	32.7433	44.2679	45.4228	38.2971
20.00	29.9946	36.2354	38.3148	35.8160
30.00	26.9487	32.1409	34.0874	32.9644
40.00	25.2691	29.2562	31.2704	31.2580
50.00	24.1178	27.4348	29.4296	30.1207
60.00	23.3821	26.2339	28.2356	29.3810
70.00	22.8995	25.4560	27.4554	28.8998
80.00	22.5861	24.9481	26.9482	28.5859
90.00	22.3817	24.6176	26.6175	28.3817
100.00	22.2486	24.4022	26.4023	28.2486
110.00	22.1619	24.2620	26.2620	28.1619
120.00	22.1055	24.1707	26.1707	28.1055
130.00	22.0687	24.1112	26.1112	28.0687
140.00	22.0447	24.0724	26.0724	28.0447
150.00	22.0291	24.0472	26.0472	28.0291
160.00	22.0190	24.0307	26.0307	28.0190
170.00	22.0124	24.0200	26.0200	28.0124
180.00	22.0081	24.0130	26.0130	28.0081
190.00	22.0052	24.0085	26.0085	28.0052
200.00	22.0034	24.0055	26.0055	28.0034
210.00	22.0022	24.0036	26.0036	28.0022
220.00	22.0015	24.0023	26.0023	28.0015
230.00	22.0009	24.0015	26.0015	28.0009
240.00	22.0006	24.0010	26.0010	28.0006
250.00	22.0004	24.0007	26.0007	28.0004
260.00	22.0003	24.0004	26.0004	28.0003
270.00	22.0002	24.0003	26.0003	28.0002
280.00	22.0001	24.0002	26.0002	28.0001
290.00	22.0001	24.0001	26.0001	28.0001
300.00	22.0000	24.0001	26.0001	28.0000
310.00	22.0000	24.0001	26.0001	28.0000
320.00	22.0000	24.0000	26.0000	28.0000
330.00	22.0000	24.0000	26.0000	28.0000
340.00	22.0000	24.0000	26.0000	28.0000
350.00	22.0000	24.0000	26.0000	28.0000

We observe that the approximate steady-state temperatures agree exactly with the corresponding values of  $\psi(x)$ .

Exercises 15.3

12. We identify  $c = 1$ ,  $a = 1$ ,  $T = 1$ ,  $n = 5$ , and  $m = 20$ . Then  $h = 0.2$ ,  $k = 0.04$ , and  $\lambda = 1$ . The values below were obtained using *Excel*, which carries more than 12 significant digits. In order to see evidence of instability use  $0 \leq t \leq 2$ .

TIME	X=0.2	X=0.4	X=0.6	X=0.8	TIME	X=0.2	X=0.4	X=0.6	X=0.8
0.00	0.5878	0.9511	0.9511	0.5878	1.04	0.0000	0.0000	0.0000	0.0000
0.04	0.3633	0.5878	0.5878	0.3633	1.08	0.0000	0.0000	0.0000	0.0000
0.08	0.2245	0.3633	0.3633	0.2245	1.12	0.0000	0.0000	0.0000	0.0000
0.12	0.1388	0.2245	0.2245	0.1388	1.16	0.0000	0.0000	0.0000	0.0000
0.16	0.0858	0.1388	0.1388	0.0858	1.20	-0.0001	0.0001	-0.0001	0.0001
0.20	0.0530	0.0858	0.0858	0.0530	1.24	0.0001	-0.0002	0.0002	-0.0001
0.24	0.0328	0.0530	0.0530	0.0328	1.28	-0.0004	0.0006	-0.0006	0.0004
0.28	0.0202	0.0328	0.0328	0.0202	1.32	0.0010	-0.0015	0.0015	-0.0010
0.32	0.0125	0.0202	0.0202	0.0125	1.36	-0.0025	0.0040	-0.0040	0.0025
0.36	0.0077	0.0125	0.0125	0.0077	1.40	0.0065	-0.0106	0.0106	-0.0065
0.40	0.0048	0.0077	0.0077	0.0048	1.44	-0.0171	0.0277	-0.0277	0.0171
0.44	0.0030	0.0048	0.0048	0.0030	1.48	0.0448	-0.0724	0.0724	-0.0448
0.48	0.0018	0.0030	0.0030	0.0018	1.52	-0.1172	0.1897	-0.1897	0.1172
0.52	0.0011	0.0018	0.0018	0.0011	1.56	0.3069	-0.4965	0.4965	-0.3069
0.56	0.0007	0.0011	0.0011	0.0007	1.60	-0.8034	1.2999	-1.2999	0.8034
0.60	0.0004	0.0007	0.0007	0.0004	1.64	2.1033	-3.4032	3.4032	-2.1033
0.64	0.0003	0.0004	0.0004	0.0003	1.68	-5.5064	8.9096	-8.9096	5.5064
0.68	0.0002	0.0003	0.0003	0.0002	1.72	14.416	-23.326	23.326	-14.416
0.72	0.0001	0.0002	0.0002	0.0001	1.76	-37.742	61.067	-61.067	37.742
0.76	0.0001	0.0001	0.0001	0.0001	1.80	98.809	-159.88	159.88	-98.809
0.80	0.0000	0.0001	0.0001	0.0000	1.84	-258.68	418.56	-418.56	258.685
0.84	0.0000	0.0000	0.0000	0.0000	1.88	677.24	-1095.8	1095.8	-677.245
0.88	0.0000	0.0000	0.0000	0.0000	1.92	-1773.1	2868.9	-2868.9	1773.1
0.92	0.0000	0.0000	0.0000	0.0000	1.96	4641.9	-7510.8	7510.8	-4641.9
0.96	0.0000	0.0000	0.0000	0.0000	2.00	-12153	19663	-19663	12153
1.00	0.0000	0.0000	0.0000	0.0000					

Exercises 15.3

1. (a) Identifying  $h = 1/4$  and  $k = 1/10$  we see that  $\lambda = 2/5$ .

TIME	X=0.25	X=0.5	X=0.75
0.00	0.1875	0.2500	0.1875
0.10	0.1775	0.2400	0.1775
0.20	0.1491	0.2100	0.1491
0.30	0.1066	0.1605	0.1066
0.40	0.0556	0.0938	0.0556
0.50	0.0019	0.0148	0.0019
0.60	-0.0501	-0.0682	-0.0501
0.70	-0.0970	-0.1455	-0.0970
0.80	-0.1361	-0.2072	-0.1361
0.90	-0.1648	-0.2462	-0.1648
1.00	-0.1802	-0.2591	-0.1802

Exercises 15.3

(b) Identifying  $h = 2/5$  and  $k = 1/10$  we see that  $\lambda = 1/4$ .

TIME	X=0.4	X=0.8	X=1.2	X=1.6
0.00	0.0032	0.5273	0.5273	0.0032
0.10	0.0194	0.5109	0.5109	0.0194
0.20	0.0652	0.4638	0.4638	0.0652
0.30	0.1318	0.3918	0.3918	0.1318
0.40	0.2065	0.3035	0.3035	0.2065
0.50	0.2743	0.2092	0.2092	0.2743
0.60	0.3208	0.1190	0.1190	0.3208
0.70	0.3348	0.0413	0.0413	0.3348
0.80	0.3094	-0.0180	-0.0180	0.3094
0.90	0.2443	-0.0568	-0.0568	0.2443
1.00	0.1450	-0.0768	-0.0768	0.1450

(c) Identifying  $h = 1/10$  and  $k = 1/25$  we see that  $\lambda = 2\sqrt{2}/5$ .

TIME	X=0.1	X=0.2	X=0.3	X=0.4	X=0.5	X=0.6	X=0.7	X=0.8	X=0.9
0.00	0.0000	0.0000	0.0000	0.0000	0.0000	0.5000	0.5000	0.5000	0.5000
0.04	0.0000	0.0000	0.0000	0.0000	0.0800	0.4200	0.5000	0.5000	0.4200
0.08	0.0000	0.0000	0.0000	0.0256	0.2432	0.2568	0.4744	0.4744	0.2312
0.12	0.0000	0.0000	0.0082	0.1126	0.3411	0.1589	0.3792	0.3710	0.0462
0.16	0.0000	0.0026	0.0472	0.2394	0.3076	0.1898	0.2108	0.1663	-0.0496
0.20	0.0008	0.0187	0.1334	0.3264	0.2146	0.2651	0.0215	-0.0933	-0.0605
0.24	0.0071	0.0657	0.2447	0.3159	0.1735	0.2463	-0.1266	-0.3056	-0.0625
0.28	0.0299	0.1513	0.3215	0.2371	0.2013	0.0849	-0.2127	-0.3829	-0.1223
0.32	0.0819	0.2525	0.3168	0.1737	0.2033	-0.1345	-0.2580	-0.3223	-0.2264
0.36	0.1623	0.3197	0.2458	0.1657	0.0877	-0.2853	-0.2843	-0.2104	-0.2887
0.40	0.2412	0.3129	0.1727	0.1583	-0.1223	-0.3164	-0.2874	-0.1473	-0.2336
0.44	0.2657	0.2383	0.1399	0.0658	-0.3046	-0.2761	-0.2549	-0.1565	-0.0761
0.48	0.1965	0.1410	0.1149	-0.1216	-0.3593	-0.2381	-0.1977	-0.1715	0.0800
0.52	0.0466	0.0531	0.0225	-0.3093	-0.2992	-0.2260	-0.1451	-0.1144	0.1300
0.56	-0.1161	-0.0466	-0.1662	-0.3876	-0.2188	-0.2114	-0.1085	0.0111	0.0602
0.60	-0.2194	-0.2069	-0.3875	-0.3411	-0.1901	-0.1662	-0.0666	0.1140	-0.0446
0.64	-0.2485	-0.4290	-0.5362	-0.2611	-0.2021	-0.0969	0.0012	0.1084	-0.0843
0.68	-0.2559	-0.6276	-0.5625	-0.2503	-0.1993	-0.0298	0.0720	0.0068	-0.0354
0.72	-0.3003	-0.6865	-0.5097	-0.3230	-0.1585	0.0156	0.0893	-0.0874	0.0384
0.76	-0.3722	-0.5652	-0.4538	-0.4029	-0.1147	0.0289	0.0265	-0.0849	0.0596
0.80	-0.3867	-0.3464	-0.4172	-0.4068	-0.1172	-0.0046	-0.0712	-0.0005	0.0155
0.84	-0.2647	-0.1633	-0.3546	-0.3214	-0.1763	-0.0954	-0.1249	0.0665	-0.0386
0.88	-0.0254	-0.0738	-0.2202	-0.2002	-0.2559	-0.2215	-0.1079	0.0385	-0.0468
0.92	0.2064	-0.0157	-0.0325	-0.1032	-0.3067	-0.3223	-0.0804	-0.0636	-0.0127
0.96	0.3012	0.1081	0.1380	-0.0487	-0.2974	-0.3407	-0.1250	-0.1548	0.0092
1.00	0.2378	0.3032	0.2392	-0.0141	-0.2223	-0.2762	-0.2481	-0.1840	-0.0244

2. (a) In Section 12.4 the solution of the wave equation is shown to be

$$u(x, t) = \sum_{n=1}^{\infty} (A_n \cos n\pi t + B_n \sin n\pi t) \sin n\pi x$$

where

$$A_n = 2 \int_0^1 \sin \pi x \sin n\pi x \, dx = \begin{cases} 1, & n = 1 \\ 0, & n = 2, 3, 4, \dots \end{cases}$$

and

$$B_n = \frac{2}{n\pi} \int_0^1 0 \, dx = 0.$$

Thus  $u(x, t) = \cos \pi t \sin \pi x$ .

- (b) We have  $h = 1/4$ ,  $k = 0.5/5 = 0.1$  and  $\lambda = 0.4$ . Now  $u_{0,j} = u_{4,j} = 0$  or  $j = 0, 1, \dots, 5$ , and the initial values of  $u$  are  $u_{1,0} = u(1/4, 0) = \sin \pi/4 \approx 0.7071$ ,  $u_{2,0} = u(1/2, 0) = \sin \pi/2 = 1$ ,  $u_{3,0} = u(3/4, 0) = \sin 3\pi/4 \approx 0.7071$ . From equation (6) in the text we have

$$u_{i,1} = 0.8(u_{i+1,0} + u_{i-1,0}) + 0.84u_{i,0} + 0.1(0).$$

Then  $u_{1,1} \approx 0.6740$ ,  $u_{2,1} = 0.9531$ ,  $u_{3,1} = 0.6740$ . From equation (3) in the text we have for  $j = 1, 2, 3, \dots$

$$u_{i,j+1} = 0.16u_{i+1,j} + 2(0.84)u_{i,j} + 0.16u_{i-1,j} - u_{i,j-1}.$$

The results of the calculations are given in the table.

TIME	x=0.25	x=0.50	x=0.75
0.0	0.7071	1.0000	0.7071
0.1	0.6740	0.9531	0.6740
0.2	0.5777	0.8169	0.5777
0.3	0.4272	0.6042	0.4272
0.4	0.2367	0.3348	0.2367
0.5	0.0241	0.0340	0.0241

(c)

i, j	approx	exact	error
1, 1	0.6740	0.6725	0.0015
1, 2	0.5777	0.5721	0.0056
1, 3	0.4272	0.4156	0.0116
1, 4	0.2367	0.2185	0.0182
1, 5	0.0241	0.0000	0.0241
2, 1	0.9531	0.9511	0.0021
2, 2	0.8169	0.8090	0.0079
2, 3	0.6042	0.5878	0.0164
2, 4	0.3348	0.3090	0.0258
2, 5	0.0340	0.0000	0.0340
3, 1	0.6740	0.6725	0.0015
3, 2	0.5777	0.5721	0.0056
3, 3	0.4272	0.4156	0.0116
3, 4	0.2367	0.2185	0.0182
3, 5	0.0241	0.0000	0.0241

### Exercises 15.3

3. (a) Identifying  $h = 1/5$  and  $k = 0.5/10 = 0.05$  we see that  $\lambda = 0.25$ .

TIME	X=0.2	X=0.4	X=0.6	X=0.8
0.00	0.5878	0.9511	0.9511	0.5878
0.05	0.5808	0.9397	0.9397	0.5808
0.10	0.5599	0.9059	0.9059	0.5599
0.15	0.5256	0.8505	0.8505	0.5256
0.20	0.4788	0.7748	0.7748	0.4788
0.25	0.4206	0.6806	0.6806	0.4206
0.30	0.3524	0.5701	0.5701	0.3524
0.35	0.2757	0.4460	0.4460	0.2757
0.40	0.1924	0.3113	0.3113	0.1924
0.45	0.1046	0.1692	0.1692	0.1046
0.50	0.0142	0.0230	0.0230	0.0142

- (b) Identifying  $h = 1/5$  and  $k = 0.5/20 = 0.025$  we see that  $\lambda = 0.125$ .

TIME	X=0.2	X=0.4	X=0.6	X=0.8
0.00	0.5878	0.9511	0.9511	0.5878
0.03	0.5860	0.9482	0.9482	0.5860
0.05	0.5808	0.9397	0.9397	0.5808
0.08	0.5721	0.9256	0.9256	0.5721
0.10	0.5599	0.9060	0.9060	0.5599
0.13	0.5445	0.8809	0.8809	0.5445
0.15	0.5257	0.8507	0.8507	0.5257
0.18	0.5039	0.8153	0.8153	0.5039
0.20	0.4790	0.7750	0.7750	0.4790
0.23	0.4513	0.7302	0.7302	0.4513
0.25	0.4209	0.6810	0.6810	0.4209
0.28	0.3879	0.6277	0.6277	0.3879
0.30	0.3527	0.5706	0.5706	0.3527
0.33	0.3153	0.5102	0.5102	0.3153
0.35	0.2761	0.4467	0.4467	0.2761
0.38	0.2352	0.3806	0.3806	0.2352
0.40	0.1929	0.3122	0.3122	0.1929
0.43	0.1495	0.2419	0.2419	0.1495
0.45	0.1052	0.1701	0.1701	0.1052
0.48	0.0602	0.0974	0.0974	0.0602
0.50	0.0149	0.0241	0.0241	0.0149

4. We have  $\lambda = 1$ . The initial values of  $n$  are  $u_{1,0} = u(0.2, 0) = 0.16$ ,  $u_{2,0} = u(0.4) = 0.24$ ,  $u_{3,0} = 0.24$ , and  $u_{4,0} = 0.16$ . From equation (6) in the text we have

$$u_{i,1} = \frac{1}{2}(u_{i+1,0} + u_{i-1,0}) + 0u_{i,0} + k \cdot 0 = \frac{1}{2}(u_{i+1,0} + u_{i-1,0}).$$

Then, using  $u_{0,0} = u_{5,0} = 0$ , we find  $u_{1,1} = 0.12$ ,  $u_{2,1} = 0.2$ ,  $u_{3,1} = 0.2$ , and  $u_{4,1} = 0.12$ .



Exercises 15.3

5. We identify  $c = 24944.4$ ,  $k = 0.00020045$  seconds = 0.20045 milliseconds, and  $\lambda = 0.5$ . Time in the table is expressed in milliseconds.

TIME	X=10	X=20	X=30	X=40	X=50
0.00000	0.1000	0.2000	0.3000	0.2000	0.1000
0.20045	0.1000	0.2000	0.2750	0.2000	0.1000
0.40089	0.1000	0.1938	0.2125	0.1938	0.1000
0.60134	0.0984	0.1688	0.1406	0.1688	0.0984
0.80178	0.0898	0.1191	0.0828	0.1191	0.0898
1.00223	0.0661	0.0531	0.0432	0.0531	0.0661
1.20268	0.0226	-0.0121	0.0085	-0.0121	0.0226
1.40312	-0.0352	-0.0635	-0.0365	-0.0635	-0.0352
1.60357	-0.0913	-0.1011	-0.0950	-0.1011	-0.0913
1.80401	-0.1271	-0.1347	-0.1566	-0.1347	-0.1271
2.00446	-0.1329	-0.1719	-0.2072	-0.1719	-0.1329
2.20491	-0.1153	-0.2081	-0.2402	-0.2081	-0.1153
2.40535	-0.0920	-0.2292	-0.2571	-0.2292	-0.0920
2.60580	-0.0801	-0.2230	-0.2601	-0.2230	-0.0801
2.80624	-0.0838	-0.1903	-0.2445	-0.1903	-0.0838
3.00669	-0.0932	-0.1445	-0.2018	-0.1445	-0.0932
3.20713	-0.0921	-0.1003	-0.1305	-0.1003	-0.0921
3.40758	-0.0701	-0.0615	-0.0440	-0.0615	-0.0701
3.60803	-0.0284	-0.0205	0.0336	-0.0205	-0.0284
3.80847	0.0224	0.0321	0.0842	0.0321	0.0224
4.00892	0.0700	0.0953	0.1087	0.0953	0.0700
4.20936	0.1064	0.1555	0.1265	0.1555	0.1064
4.40981	0.1285	0.1962	0.1588	0.1962	0.1285
4.61026	0.1354	0.2106	0.2098	0.2106	0.1354
4.81070	0.1273	0.2060	0.2612	0.2060	0.1273
5.01115	0.1070	0.1955	0.2851	0.1955	0.1070
5.21159	0.0821	0.1853	0.2641	0.1853	0.0821
5.41204	0.0625	0.1689	0.2038	0.1689	0.0625
5.61249	0.0539	0.1347	0.1260	0.1347	0.0539
5.81293	0.0520	0.0781	0.0526	0.0781	0.0520
6.01338	0.0436	0.0086	-0.0080	0.0086	0.0436
6.21382	0.0156	-0.0564	-0.0604	-0.0564	0.0156
6.41427	-0.0343	-0.1043	-0.1107	-0.1043	-0.0343
6.61472	-0.0931	-0.1364	-0.1578	-0.1364	-0.0931
6.81516	-0.1395	-0.1630	-0.1942	-0.1630	-0.1395
7.01561	-0.1568	-0.1915	-0.2150	-0.1915	-0.1568
7.21605	-0.1436	-0.2173	-0.2240	-0.2173	-0.1436
7.41650	-0.1129	-0.2263	-0.2297	-0.2263	-0.1129
7.61695	-0.0824	-0.2078	-0.2336	-0.2078	-0.0824
7.81739	-0.0625	-0.1644	-0.2247	-0.1644	-0.0625
8.01784	-0.0526	-0.1106	-0.1856	-0.1106	-0.0526
8.21828	-0.0440	-0.0611	-0.1091	-0.0611	-0.0440
8.41873	-0.0287	-0.0192	-0.0085	-0.0192	-0.0287
8.61918	-0.0038	0.0229	0.0867	0.0229	-0.0038
8.81962	0.0287	0.0743	0.1500	0.0743	0.0287
9.02007	0.0654	0.1332	0.1755	0.1332	0.0654
9.22051	0.1027	0.1858	0.1799	0.1858	0.1027
9.42096	0.1352	0.2160	0.1872	0.2160	0.1352
9.62140	0.1540	0.2189	0.2089	0.2189	0.1540
9.82185	0.1506	0.2030	0.2356	0.2030	0.1506
10.02230	0.1226	0.1822	0.2461	0.1822	0.1226

6. We identify  $c = 24944.4$ ,  $k = 0.00010022$  seconds = 0.10022 milliseconds, and  $\lambda = 0.25$ . Time in

### Exercises 15.3

the table is expressed in milliseconds.

TIME	X=10	X=20	X=30	X=40	X=50
0.00000	0.2000	0.2667	0.2000	0.1333	0.0667
0.10022	0.1958	0.2625	0.2000	0.1333	0.0667
0.20045	0.1836	0.2503	0.1997	0.1333	0.0667
0.30067	0.1640	0.2307	0.1985	0.1333	0.0667
0.40089	0.1384	0.2050	0.1952	0.1332	0.0667
0.50111	0.1083	0.1744	0.1886	0.1328	0.0667
0.60134	0.0755	0.1407	0.1777	0.1318	0.0666
0.70156	0.0421	0.1052	0.1615	0.1295	0.0665
0.80178	0.0100	0.0692	0.1399	0.1253	0.0661
0.90201	-0.0190	0.0340	0.1129	0.1184	0.0654
1.00223	-0.0435	0.0004	0.0813	0.1077	0.0638
1.10245	-0.0626	-0.0309	0.0464	0.0927	0.0610
1.20268	-0.0758	-0.0593	0.0095	0.0728	0.0564
1.30290	-0.0832	-0.0845	-0.0278	0.0479	0.0493
1.40312	-0.0855	-0.1060	-0.0639	0.0184	0.0390
1.50334	-0.0837	-0.1237	-0.0974	-0.0150	0.0250
1.60357	-0.0792	-0.1371	-0.1275	-0.0511	0.0069
1.70379	-0.0734	-0.1464	-0.1533	-0.0882	-0.0152
1.80401	-0.0675	-0.1515	-0.1747	-0.1249	-0.0410
1.90424	-0.0627	-0.1528	-0.1915	-0.1595	-0.0694
2.00446	-0.0596	-0.1509	-0.2039	-0.1904	-0.0991
2.10468	-0.0585	-0.1467	-0.2122	-0.2165	-0.1283
2.20491	-0.0592	-0.1410	-0.2166	-0.2368	-0.1551
2.30513	-0.0614	-0.1349	-0.2175	-0.2507	-0.1772
2.40535	-0.0643	-0.1294	-0.2154	-0.2579	-0.1929
2.50557	-0.0672	-0.1251	-0.2105	-0.2585	-0.2005
2.60580	-0.0696	-0.1227	-0.2033	-0.2524	-0.1993
2.70602	-0.0709	-0.1219	-0.1942	-0.2399	-0.1889
2.80624	-0.0710	-0.1225	-0.1833	-0.2214	-0.1699
2.90647	-0.0699	-0.1236	-0.1711	-0.1972	-0.1435
3.00669	-0.0678	-0.1244	-0.1575	-0.1681	-0.1115
3.10691	-0.0649	-0.1237	-0.1425	-0.1348	-0.0761
3.20713	-0.0617	-0.1205	-0.1258	-0.0983	-0.0395
3.30736	-0.0583	-0.1139	-0.1071	-0.0598	-0.0042
3.40758	-0.0547	-0.1035	-0.0859	-0.0209	0.0279
3.50780	-0.0508	-0.0889	-0.0617	0.0171	0.0552
3.60803	-0.0460	-0.0702	-0.0343	0.0525	0.0767
3.70825	-0.0399	-0.0478	-0.0037	0.0840	0.0919
3.80847	-0.0318	-0.0221	0.0297	0.1106	0.1008
3.90870	-0.0211	0.0062	0.0648	0.1314	0.1041
4.00892	-0.0074	0.0365	0.1005	0.1464	0.1025
4.10914	0.0095	0.0680	0.1350	0.1558	0.0973
4.20936	0.0295	0.1000	0.1666	0.1602	0.0897
4.30959	0.0521	0.1318	0.1937	0.1606	0.0808
4.40981	0.0764	0.1625	0.2148	0.1581	0.0719
4.51003	0.1013	0.1911	0.2291	0.1538	0.0639
4.61026	0.1254	0.2164	0.2364	0.1485	0.0575
4.71048	0.1475	0.2373	0.2369	0.1431	0.0532
4.81070	0.1659	0.2526	0.2315	0.1379	0.0512
4.91093	0.1794	0.2611	0.2217	0.1331	0.0514
5.01115	0.1867	0.2620	0.2087	0.1288	0.0535

## Chapter 15 Review Exercises

1. Using the figure we obtain the system

$$u_{21} + 0 + 0 + 0 - 4u_{11} = 0$$

$$u_{31} + 0 + u_{11} + 0 - 4u_{21} = 0$$

$$50 + 0 + u_{21} + 0 - 4u_{31} = 0.$$

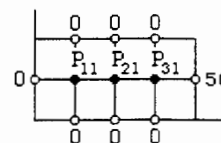

By Gauss-Elimination then,

$$\left[ \begin{array}{ccc|c} -4 & 1 & 0 & 0 \\ 1 & -4 & 1 & 0 \\ 0 & 1 & -4 & -50 \end{array} \right] \xrightarrow[\text{operations}]{\text{row}} \left[ \begin{array}{ccc|c} 1 & -4 & 1 & 0 \\ 0 & 1 & -4 & -50 \\ 0 & 0 & 1 & 13.3928 \end{array} \right].$$

The solution is  $u_{11} = 0.8929$ ,  $u_{21} = 3.5714$ ,  $u_{31} = 13.3928$ .

2. By symmetry we observe that  $u_{i,1} = u_{i,3}$  for  $i = 1, 2, \dots, 7$ . We then use Gauss-Seidel iteration with an initial guess of 7.5 for all variables to solve the system

$$u_{11} = 0.25u_{21} + 0.25u_{12}$$

$$u_{21} = 0.25u_{31} + 0.25u_{22} + 0.25u_{11}$$

$$u_{31} = 0.25u_{41} + 0.25u_{32} + 0.25u_{21}$$

$$u_{41} = 0.25u_{51} + 0.25u_{42} + 0.25u_{31}$$

$$u_{51} = 0.25u_{61} + 0.25u_{52} + 0.25u_{41}$$

$$u_{61} = 0.25u_{71} + 0.25u_{62} + 0.25u_{51}$$

$$u_{71} = 12.5 + 0.25u_{72} + 0.25u_{61}$$

$$u_{12} = 0.25u_{22} + 0.5u_{11}$$

$$u_{22} = 0.25u_{32} + 0.5u_{21} + 0.25u_{12}$$

$$u_{32} = 0.25u_{42} + 0.5u_{31} + 0.25u_{22}$$

$$u_{42} = 0.25u_{52} + 0.5u_{41} + 0.25u_{32}$$

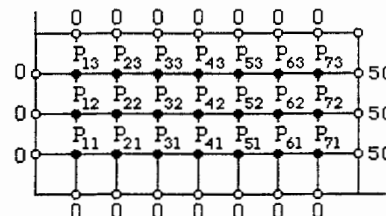

### Chapter 15 Review Exercises

$$u_{52} = 0.25u_{62} + 0.5u_{51} + 0.25u_{42}$$

$$u_{62} = 0.25u_{72} + 0.5u_{61} + 0.25u_{52}$$

$$u_{72} = 12.5 + 0.5u_{71} + 0.25u_{62}.$$

After 30 iterations we obtain  $u_{11} = u_{13} = 0.1765$ ,  $u_{21} = u_{23} = 0.4566$ ,  $u_{31} = u_{33} = 1.0051$ ,  $u_{41} = u_{43} = 2.1479$ ,  $u_{51} = u_{53} = 4.5766$ ,  $u_{61} = u_{63} = 9.8316$ ,  $u_{71} = u_{73} = 21.6051$ ,  $u_{12} = 0.2494$ ,  $u_{22} = 0.6447$ ,  $u_{32} = 1.4162$ ,  $u_{42} = 3.0097$ ,  $u_{52} = 6.3269$ ,  $u_{62} = 13.1447$ ,  $u_{72} = 26.5887$ .

3. (a)

TIME	X=0.0	X=0.2	X=0.4	X=0.6	X=0.8	X=1.0
0.00	0.0000	0.2000	0.4000	0.6000	0.8000	0.0000
0.01	0.0000	0.2000	0.4000	0.6000	0.5500	0.0000
0.02	0.0000	0.2000	0.4000	0.5375	0.4250	0.0000
0.03	0.0000	0.2000	0.3844	0.4750	0.3469	0.0000
0.04	0.0000	0.1961	0.3609	0.4203	0.2922	0.0000
0.05	0.0000	0.1883	0.3346	0.3734	0.2512	0.0000

(b)

TIME	X=0.0	X=0.2	X=0.4	X=0.6	X=0.8	X=1.0
0.00	0.0000	0.2000	0.4000	0.6000	0.8000	0.0000
0.01	0.0000	0.2000	0.4000	0.6000	0.8000	0.0000
0.02	0.0000	0.2000	0.4000	0.6000	0.5500	0.0000
0.03	0.0000	0.2000	0.4000	0.5375	0.4250	0.0000
0.04	0.0000	0.2000	0.3844	0.4750	0.3469	0.0000
0.05	0.0000	0.1961	0.3609	0.4203	0.2922	0.0000

(c) The table in part (b) is the same as the table in part (a) shifted downward one row.

# Appendix I

## Gamma Function

- (a)  $\Gamma(5) = \Gamma(4 + 1) = 4! = 24$   
(b)  $\Gamma(7) = \Gamma(6 + 1) = 6! = 720$   
(c) Using Example 1 in the text,

$$-2\sqrt{\pi} = \Gamma\left(-\frac{1}{2}\right) = \Gamma\left(-\frac{3}{2} + 1\right) = -\frac{3}{2}\Gamma\left(-\frac{3}{2}\right).$$

$$\text{Thus, } \Gamma(-3/2) = 4\sqrt{\pi}/3.$$

- (d) Using (c)

$$\frac{4\sqrt{\pi}}{3} = \Gamma\left(-\frac{3}{2}\right) = \Gamma\left(-\frac{5}{2} + 1\right) = -\frac{5}{2}\Gamma\left(-\frac{5}{2}\right).$$

$$\text{Thus } \Gamma(-5/2) = -8\sqrt{\pi}/15.$$

- If  $t = x^5$ , then  $dt = 5x^4 dx$  and  $x^5 dx = \frac{1}{5}t^{1/5} dt$ . Now

$$\begin{aligned}\int_0^{\infty} x^5 e^{-x^5} dx &= \int_0^{\infty} \frac{1}{5} t^{1/5} e^{-t} dt = \frac{1}{5} \int_0^{\infty} t^{1/5} e^{-t} dt \\ &= \frac{1}{5} \Gamma\left(\frac{6}{5}\right) = \frac{1}{5}(0.92) = 0.184.\end{aligned}$$

- If  $t = x^3$ , then  $dt = 3x^2 dx$  and  $x^4 dx = \frac{1}{3}t^{2/3} dt$ . Now

$$\begin{aligned}\int_0^{\infty} x^4 e^{-x^3} dx &= \int_0^{\infty} \frac{1}{3} t^{2/3} e^{-t} dt = \frac{1}{3} \int_0^{\infty} t^{2/3} e^{-t} dt \\ &= \frac{1}{3} \Gamma\left(\frac{5}{3}\right) = \frac{1}{3}(0.89) \approx 0.297.\end{aligned}$$

- If  $t = -\ln x = \ln \frac{1}{x}$  then  $dt = -\frac{1}{x} dx$ . Also  $e^t = \frac{1}{x}$ , so  $x = e^{-t}$  and  $dx = -x dt = -e^{-t} dt$ . Thus

$$\begin{aligned}\int_0^1 x^3 \left(\ln \frac{1}{x}\right)^3 dx &= \int_{\infty}^0 (e^{-t})^3 t^3 (-e^{-t}) dt \\ &= \int_0^{\infty} t^3 e^{-4t} dt \\ &= \int_0^{\infty} \left(\frac{1}{4}u\right)^3 e^{-u} \left(\frac{1}{4}du\right) \quad [u = 4t] \\ &= \frac{1}{256} \int_0^{\infty} u^3 e^{-u} du = \frac{1}{256} \Gamma(4) \\ &= \frac{1}{256} (3!) = \frac{3}{128}.\end{aligned}$$

## Gamma Function

5. Since  $e^{-t} \geq e^{-1}$  for  $0 \leq t \leq 1$ ,

$$\begin{aligned}\Gamma(x) &= \int_0^{\infty} t^{x-1} e^{-t} dt > \int_0^1 t^{x-1} e^{-t} dt \geq e^{-1} \int_0^1 t^{x-1} dt \\ &= \frac{1}{e} \left( \frac{1}{x} t^x \right) \Big|_0^1 = \frac{1}{ex}\end{aligned}$$

for  $x > 0$ . As  $x \rightarrow 0^+$ , we see that  $\Gamma(x) \rightarrow \infty$ .

6. For  $x > 0$

$$\Gamma(x+1) = \int_0^{\infty} t^x e^{-t} dt$$

$u = t^x$	$dv = e^{-t} dt$
$du = xt^{x-1} dt$	$v = -e^{-t}$

$$\begin{aligned}&= -t^x e^{-t} \Big|_0^{\infty} - \int_0^{\infty} xt^{x-1} (-e^{-t}) dt \\ &= x \int_0^{\infty} t^{x-1} e^{-t} dt = x\Gamma(x).\end{aligned}$$

## Appendix II

---

### Introduction to Matrices

---

1. (a)  $\mathbf{A} + \mathbf{B} = \begin{pmatrix} 4-2 & 5+6 \\ -6+8 & 9-10 \end{pmatrix} = \begin{pmatrix} 2 & 11 \\ 2 & -1 \end{pmatrix}$

(b)  $\mathbf{B} - \mathbf{A} = \begin{pmatrix} -2-4 & 6-5 \\ 8+6 & -10-9 \end{pmatrix} = \begin{pmatrix} -6 & 1 \\ 14 & -19 \end{pmatrix}$

(c)  $2\mathbf{A} + 3\mathbf{B} = \begin{pmatrix} 8 & 10 \\ -12 & 18 \end{pmatrix} + \begin{pmatrix} -6 & 18 \\ 24 & -30 \end{pmatrix} = \begin{pmatrix} 2 & 28 \\ 12 & -12 \end{pmatrix}$

2. (a)  $\mathbf{A} - \mathbf{B} = \begin{pmatrix} -2-3 & 0+1 \\ 4-0 & 1-2 \\ 7+4 & 3+2 \end{pmatrix} = \begin{pmatrix} -5 & 1 \\ 4 & -1 \\ 11 & 5 \end{pmatrix}$

(b)  $\mathbf{B} - \mathbf{A} = \begin{pmatrix} 3+2 & -1-0 \\ 0-4 & 2-1 \\ -4-7 & -2-3 \end{pmatrix} = \begin{pmatrix} 5 & -1 \\ -4 & 1 \\ -11 & -5 \end{pmatrix}$

$$(c) 2(\mathbf{A} + \mathbf{B}) = 2 \begin{pmatrix} 1 & -1 \\ 4 & 3 \\ 3 & 1 \end{pmatrix} = \begin{pmatrix} 2 & -2 \\ 8 & 6 \\ 6 & 2 \end{pmatrix}$$

$$3. (a) \mathbf{AB} = \begin{pmatrix} -2-9 & 12-6 \\ 5+12 & -30+8 \end{pmatrix} = \begin{pmatrix} -11 & 6 \\ 17 & -22 \end{pmatrix}$$

$$(b) \mathbf{BA} = \begin{pmatrix} -2-30 & 3+24 \\ 6-10 & -9+8 \end{pmatrix} = \begin{pmatrix} -32 & 27 \\ -4 & -1 \end{pmatrix}$$

$$(c) \mathbf{A}^2 = \begin{pmatrix} 4+15 & -6-12 \\ -10-20 & 15+16 \end{pmatrix} = \begin{pmatrix} 19 & -18 \\ -30 & 31 \end{pmatrix}$$

$$(d) \mathbf{B}^2 = \begin{pmatrix} 1+18 & -6+12 \\ -3+6 & 18+4 \end{pmatrix} = \begin{pmatrix} 19 & 6 \\ 3 & 22 \end{pmatrix}$$

$$4. (a) \mathbf{AB} = \begin{pmatrix} -4+4 & 6-12 & -3+8 \\ -20+10 & 30-30 & -15+20 \\ -32+12 & 48-36 & -24+24 \end{pmatrix} = \begin{pmatrix} 0 & -6 & 5 \\ -10 & 0 & 5 \\ -20 & 12 & 0 \end{pmatrix}$$

$$(b) \mathbf{BA} = \begin{pmatrix} -4+30-24 & -16+60-36 \\ 1-15+16 & 4-30+24 \end{pmatrix} = \begin{pmatrix} 2 & 8 \\ 2 & -2 \end{pmatrix}$$

$$5. (a) \mathbf{BC} = \begin{pmatrix} 9 & 24 \\ 3 & 8 \end{pmatrix}$$

$$(b) \mathbf{A}(\mathbf{BC}) = \begin{pmatrix} 1 & -2 \\ -2 & 4 \end{pmatrix} \begin{pmatrix} 9 & 24 \\ 3 & 8 \end{pmatrix} = \begin{pmatrix} 3 & 8 \\ -6 & -16 \end{pmatrix}$$

$$(c) \mathbf{C}(\mathbf{BA}) = \begin{pmatrix} 0 & 2 \\ 3 & 4 \end{pmatrix} \begin{pmatrix} 0 & 0 \\ 0 & 0 \end{pmatrix} = \begin{pmatrix} 0 & 0 \\ 0 & 0 \end{pmatrix}$$

$$(d) \mathbf{A}(\mathbf{B} + \mathbf{C}) = \begin{pmatrix} 1 & -2 \\ -2 & 4 \end{pmatrix} \begin{pmatrix} 6 & 5 \\ 5 & 5 \end{pmatrix} = \begin{pmatrix} -4 & -5 \\ 8 & 10 \end{pmatrix}$$

$$6. (a) \mathbf{AB} = (5 \quad -6 \quad 7) \begin{pmatrix} 3 \\ 4 \\ -1 \end{pmatrix} = (-16)$$

$$(b) \mathbf{BA} = \begin{pmatrix} 3 \\ 4 \\ -1 \end{pmatrix} (5 \quad -6 \quad 7) = \begin{pmatrix} 15 & -18 & 21 \\ 20 & -24 & 28 \\ -5 & 6 & -7 \end{pmatrix}$$

*Introduction to Matrices*

$$(c) (\mathbf{BA})\mathbf{C} = \begin{pmatrix} 15 & -18 & 21 \\ 20 & -24 & 28 \\ -5 & 6 & -7 \end{pmatrix} \begin{pmatrix} 1 & 2 & 4 \\ 0 & 1 & -1 \\ 3 & 2 & 1 \end{pmatrix} = \begin{pmatrix} 78 & 54 & 99 \\ 104 & 72 & 132 \\ -26 & -18 & -33 \end{pmatrix}$$

(d) Since  $\mathbf{AB}$  is  $1 \times 1$  and  $\mathbf{C}$  is  $3 \times 3$  the product  $(\mathbf{AB})\mathbf{C}$  is not defined.

$$7. (a) \mathbf{A}^T\mathbf{A} = (4 \ 8 \ -10) \begin{pmatrix} 4 \\ 8 \\ -10 \end{pmatrix} = (180)$$

$$(b) \mathbf{B}^T\mathbf{B} = \begin{pmatrix} 2 \\ 4 \\ 5 \end{pmatrix} (2 \ 4 \ 5) = \begin{pmatrix} 4 & 8 & 10 \\ 8 & 16 & 20 \\ 10 & 20 & 25 \end{pmatrix}$$

$$(c) \mathbf{A} + \mathbf{B}^T = \begin{pmatrix} 4 \\ 8 \\ -10 \end{pmatrix} + \begin{pmatrix} 2 \\ 4 \\ 5 \end{pmatrix} = \begin{pmatrix} 6 \\ 12 \\ -5 \end{pmatrix}$$

$$8. (a) \mathbf{A} + \mathbf{B}^T = \begin{pmatrix} 1 & 2 \\ 2 & 4 \end{pmatrix} + \begin{pmatrix} -2 & 5 \\ 3 & 7 \end{pmatrix} = \begin{pmatrix} -1 & 7 \\ 5 & 11 \end{pmatrix}$$

$$(b) 2\mathbf{A}^T - \mathbf{B}^T = \begin{pmatrix} 2 & 4 \\ 4 & 8 \end{pmatrix} - \begin{pmatrix} -2 & 5 \\ 3 & 7 \end{pmatrix} = \begin{pmatrix} 4 & -1 \\ 1 & 1 \end{pmatrix}$$

$$(c) \mathbf{A}^T(\mathbf{A} - \mathbf{B}) = \begin{pmatrix} 1 & 2 \\ 2 & 4 \end{pmatrix} \begin{pmatrix} 3 & -1 \\ -3 & -3 \end{pmatrix} = \begin{pmatrix} -3 & -7 \\ -6 & -14 \end{pmatrix}$$

$$9. (a) (\mathbf{AB})^T = \begin{pmatrix} 7 & 10 \\ 38 & 75 \end{pmatrix}^T = \begin{pmatrix} 7 & 38 \\ 10 & 75 \end{pmatrix}$$

$$(b) \mathbf{B}^T\mathbf{A}^T = \begin{pmatrix} 5 & -2 \\ 10 & -5 \end{pmatrix} \begin{pmatrix} 3 & 8 \\ 4 & 1 \end{pmatrix} = \begin{pmatrix} 7 & 38 \\ 10 & 75 \end{pmatrix}$$

$$10. (a) \mathbf{A}^T + \mathbf{B}^T = \begin{pmatrix} 5 & -4 \\ 9 & 6 \end{pmatrix} + \begin{pmatrix} -3 & -7 \\ 11 & 2 \end{pmatrix} = \begin{pmatrix} 2 & -11 \\ 20 & 8 \end{pmatrix}$$

$$(b) (\mathbf{A} + \mathbf{B})^T = \begin{pmatrix} 2 & 20 \\ -11 & 8 \end{pmatrix}^T = \begin{pmatrix} 2 & -11 \\ 20 & 8 \end{pmatrix}$$

$$11. \begin{pmatrix} -4 \\ 8 \end{pmatrix} - \begin{pmatrix} 4 \\ 16 \end{pmatrix} + \begin{pmatrix} -6 \\ 9 \end{pmatrix} = \begin{pmatrix} -14 \\ 1 \end{pmatrix}$$



$$12. \begin{pmatrix} 6t \\ 3t^2 \\ -3t \end{pmatrix} + \begin{pmatrix} -t+1 \\ -t^2+t \\ 3t-3 \end{pmatrix} - \begin{pmatrix} 6t \\ 8 \\ -10t \end{pmatrix} = \begin{pmatrix} -t+1 \\ 2t^2+t-8 \\ 10t-3 \end{pmatrix}$$

$$13. \begin{pmatrix} -19 \\ 18 \end{pmatrix} - \begin{pmatrix} 19 \\ 20 \end{pmatrix} = \begin{pmatrix} -38 \\ -2 \end{pmatrix}$$

$$14. \begin{pmatrix} -9t+3 \\ 13t-5 \\ -6t+4 \end{pmatrix} + \begin{pmatrix} -t \\ 1 \\ 4 \end{pmatrix} - \begin{pmatrix} 2 \\ 8 \\ -6 \end{pmatrix} = \begin{pmatrix} -10t+1 \\ 13t-12 \\ -6t+14 \end{pmatrix}$$

15. Since  $\det \mathbf{A} = 0$ ,  $\mathbf{A}$  is singular.

16. Since  $\det \mathbf{A} = 3$ ,  $\mathbf{A}$  is nonsingular.

$$\mathbf{A}^{-1} = \frac{1}{3} \begin{pmatrix} 4 & -5 \\ -1 & 2 \end{pmatrix}$$

17. Since  $\det \mathbf{A} = 4$ ,  $\mathbf{A}$  is nonsingular.

$$\mathbf{A}^{-1} = \frac{1}{4} \begin{pmatrix} -5 & -8 \\ 3 & 4 \end{pmatrix}$$

18. Since  $\det \mathbf{A} = -6$ ,  $\mathbf{A}$  is nonsingular.

$$\mathbf{A}^{-1} = -\frac{1}{6} \begin{pmatrix} 2 & -10 \\ -2 & 7 \end{pmatrix}$$

19. Since  $\det \mathbf{A} = 2$ ,  $\mathbf{A}$  is nonsingular. The cofactors are

$$A_{11} = 0 \quad A_{12} = 2 \quad A_{13} = -4$$

$$A_{21} = -1 \quad A_{22} = 2 \quad A_{23} = -3$$

$$A_{31} = 1 \quad A_{32} = -2 \quad A_{33} = 5.$$

Then

$$\mathbf{A}^{-1} = \frac{1}{2} \begin{pmatrix} 0 & 2 & -4 \\ -1 & 2 & -3 \\ 1 & -2 & 5 \end{pmatrix}^T = \frac{1}{2} \begin{pmatrix} 0 & -1 & 1 \\ 2 & 2 & -2 \\ -4 & -3 & 5 \end{pmatrix}.$$

20. Since  $\det \mathbf{A} = 27$ ,  $\mathbf{A}$  is nonsingular. The cofactors are

$$A_{11} = -1 \quad A_{12} = 4 \quad A_{13} = 22$$

$$A_{21} = 7 \quad A_{22} = -1 \quad A_{23} = -19$$

$$A_{31} = -1 \quad A_{32} = 4 \quad A_{33} = -5.$$

## Introduction to Matrices

Then

$$\mathbf{A}^{-1} = \frac{1}{27} \begin{pmatrix} -1 & 4 & 22 \\ 7 & -1 & -19 \\ -1 & 4 & -5 \end{pmatrix}^T = \frac{1}{27} \begin{pmatrix} -1 & 7 & -1 \\ 4 & -1 & 4 \\ 22 & -19 & -5 \end{pmatrix}.$$

21. Since  $\det \mathbf{A} = -9$ ,  $\mathbf{A}$  is nonsingular. The cofactors are

$$\begin{aligned} A_{11} &= -2 & A_{12} &= -13 & A_{13} &= 8 \\ A_{21} &= -2 & A_{22} &= 5 & A_{23} &= -1 \\ A_{31} &= -1 & A_{32} &= 7 & A_{33} &= -5. \end{aligned}$$

Then

$$\mathbf{A}^{-1} = -\frac{1}{9} \begin{pmatrix} -2 & -13 & 8 \\ -2 & 5 & -1 \\ -1 & 7 & -5 \end{pmatrix}^T = -\frac{1}{9} \begin{pmatrix} -2 & -2 & -1 \\ -13 & 5 & 7 \\ 8 & -1 & -5 \end{pmatrix}.$$

22. Since  $\det \mathbf{A} = 0$ ,  $\mathbf{A}$  is singular.

23. Since  $\det \mathbf{A}(t) = 2e^{3t} \neq 0$ ,  $\mathbf{A}$  is nonsingular.

$$\mathbf{A}^{-1} = \frac{1}{2} e^{-3t} \begin{pmatrix} 3e^{4t} & -e^{4t} \\ -4e^{-t} & 2e^{-t} \end{pmatrix}$$

24. Since  $\det \mathbf{A}(t) = 2e^{2t} \neq 0$ ,  $\mathbf{A}$  is nonsingular.

$$\mathbf{A}^{-1} = \frac{1}{2} e^{-2t} \begin{pmatrix} e^t \sin t & 2e^t \cos t \\ -e^t \cos t & 2e^t \sin t \end{pmatrix}$$

$$25. \frac{d\mathbf{X}}{dt} = \begin{pmatrix} -5e^{-t} \\ -2e^{-t} \\ 7e^{-t} \end{pmatrix}$$

$$26. \frac{d\mathbf{X}}{dt} = \begin{pmatrix} \cos 2t + 8 \sin 2t \\ -6 \cos 2t - 10 \sin 2t \end{pmatrix}$$

$$27. \mathbf{X} = \begin{pmatrix} 2e^{2t} + 8e^{-3t} \\ -2e^{2t} + 4e^{-3t} \end{pmatrix} \text{ so that } \frac{d\mathbf{X}}{dt} = \begin{pmatrix} 4e^{2t} - 24e^{-3t} \\ -4e^{2t} - 12e^{-3t} \end{pmatrix}.$$

$$28. \frac{d\mathbf{X}}{dt} = \begin{pmatrix} 10te^{2t} + 5e^{2t} \\ 3t \cos 3t + \sin 3t \end{pmatrix}$$

$$29. (a) \frac{d\mathbf{A}}{dt} = \begin{pmatrix} 4e^{4t} & -\pi \sin \pi t \\ 2 & 6t \end{pmatrix}$$

$$(b) \int_0^2 \mathbf{A}(t) dt = \begin{pmatrix} \frac{1}{4}e^{4t} & \frac{1}{\pi} \sin \pi t \\ t^2 & t^3 - t \end{pmatrix} \Big|_{t=0}^{t=2} = \begin{pmatrix} \frac{1}{4}e^8 - \frac{1}{4} & 0 \\ 4 & 6 \end{pmatrix}$$

$$(c) \int_0^t \mathbf{A}(s) ds = \begin{pmatrix} \frac{1}{4}e^{4s} & \frac{1}{\pi} \sin \pi s \\ s^2 & s^3 - s \end{pmatrix} \Big|_{s=0}^{s=t} = \begin{pmatrix} \frac{1}{4}e^{4t} - \frac{1}{4} & \frac{1}{\pi} \sin \pi t \\ t^2 & t^3 - t \end{pmatrix}$$

$$30. (a) \frac{d\mathbf{A}}{dt} = \begin{pmatrix} -2t/(t^2 + 1)^2 & 3 \\ 2t & 1 \end{pmatrix}$$

$$(b) \frac{d\mathbf{B}}{dt} = \begin{pmatrix} 6 & 0 \\ -1/t^2 & 4 \end{pmatrix}$$

$$(c) \int_0^1 \mathbf{A}(t) dt = \begin{pmatrix} \tan^{-1} t & \frac{3}{2}t^2 \\ \frac{1}{3}t^3 & \frac{1}{2}t^2 \end{pmatrix} \Big|_{t=0}^{t=1} = \begin{pmatrix} \frac{\pi}{4} & \frac{3}{2} \\ \frac{1}{3} & \frac{1}{2} \end{pmatrix}$$

$$(d) \int_1^2 \mathbf{B}(t) dt = \begin{pmatrix} 3t^2 & 2t \\ \ln t & 2t^2 \end{pmatrix} \Big|_{t=1}^{t=2} = \begin{pmatrix} 9 & 2 \\ \ln 2 & 6 \end{pmatrix}$$

$$(e) \mathbf{A}(t)\mathbf{B}(t) = \begin{pmatrix} 6t/(t^2 + 1) + 3 & 2/(t^2 + 1) + 12t^2 \\ 6t^3 + 1 & 2t^2 + 4t^2 \end{pmatrix}$$

$$(f) \frac{d}{dt} \mathbf{A}(t)\mathbf{B}(t) = \begin{pmatrix} (6 - 6t^2)/(t^2 + 1)^2 & -4t/(t^2 + 1)^2 + 24t \\ 18t^2 & 12t \end{pmatrix}$$

$$(g) \int_1^t \mathbf{A}(s)\mathbf{B}(s) ds = \begin{pmatrix} 6s/(s^2 + 1) + 3 & 2/(s^2 + 1) + 12s^2 \\ 6s^3 + 1 & 6s^2 \end{pmatrix} \Big|_{s=1}^{s=t} \\ = \begin{pmatrix} 3t + 3 \ln(t^2 + 1) - 3 - 3 \ln 2 & 4t^3 + 2 \tan^{-1} t - 4 - \pi/2 \\ (3/2)t^4 + t - (5/2) & 2t^3 - 2 \end{pmatrix}$$

$$31. \begin{pmatrix} 1 & 1 & -2 & | & 14 \\ 2 & -1 & 1 & | & 0 \\ 6 & 3 & 4 & | & 1 \end{pmatrix} \Rightarrow \begin{pmatrix} 1 & 1 & -2 & | & 14 \\ 0 & -3 & 5 & | & -28 \\ 0 & 6 & 1 & | & 1 \end{pmatrix} \Rightarrow \begin{pmatrix} 1 & 0 & -1/3 & | & 14/3 \\ 0 & 1 & -5/3 & | & 28/3 \\ 0 & 0 & 11 & | & -55 \end{pmatrix} \\ \Rightarrow \begin{pmatrix} 1 & 0 & 0 & | & 3 \\ 0 & 1 & 0 & | & 1 \\ 0 & 0 & 1 & | & -5 \end{pmatrix}$$

Thus  $x = 3$ ,  $y = 1$ , and  $z = -5$ .

*Introduction to Matrices*

$$32. \left( \begin{array}{ccc|c} 5 & -2 & 4 & 10 \\ 1 & 1 & 1 & 9 \\ 4 & -3 & 3 & 1 \end{array} \right) \Rightarrow \left( \begin{array}{ccc|c} 1 & 1 & 1 & 9 \\ 0 & -7 & -1 & -35 \\ 0 & -7 & -1 & -35 \end{array} \right) \Rightarrow \left( \begin{array}{ccc|c} 1 & 0 & 6/7 & 4 \\ 0 & 1 & 1/7 & 5 \\ 0 & 0 & 0 & 0 \end{array} \right)$$

Letting  $z = t$  we find  $y = 5 - \frac{1}{7}t$ , and  $x = 4 - \frac{6}{7}t$ .

$$33. \left( \begin{array}{ccc|c} 1 & -1 & -5 & 7 \\ 5 & 4 & -16 & -10 \\ 0 & 1 & 1 & -5 \end{array} \right) \Rightarrow \left( \begin{array}{ccc|c} 1 & -1 & -5 & 7 \\ 0 & 1 & 1 & -5 \\ 0 & 9 & 9 & -45 \end{array} \right) \Rightarrow \left( \begin{array}{ccc|c} 1 & 0 & -4 & 2 \\ 0 & 1 & 1 & -5 \\ 0 & 0 & 0 & 0 \end{array} \right)$$

Letting  $z = t$  we find  $y = -5 - t$ , and  $x = 2 + 4t$ .

$$34. \left( \begin{array}{ccc|c} 1 & 1 & -3 & 6 \\ 4 & 2 & -1 & 7 \\ 3 & 1 & 1 & 4 \end{array} \right) \Rightarrow \left( \begin{array}{ccc|c} 1 & 1 & -3 & 6 \\ 0 & -2 & 11 & -17 \\ 0 & -2 & 10 & -14 \end{array} \right) \Rightarrow \left( \begin{array}{ccc|c} 1 & 0 & 5/2 & -5/2 \\ 0 & 1 & -11/2 & 17/2 \\ 0 & 0 & -1 & 3 \end{array} \right)$$

$$\Rightarrow \left( \begin{array}{ccc|c} 1 & 0 & 0 & 5 \\ 0 & 1 & 0 & -8 \\ 0 & 0 & 1 & -3 \end{array} \right)$$

Thus  $x = 5$ ,  $y = -8$ , and  $z = -3$ .

$$35. \left( \begin{array}{ccc|c} 2 & 1 & 1 & 4 \\ 10 & -2 & 2 & -1 \\ 6 & -2 & 4 & 8 \end{array} \right) \Rightarrow \left( \begin{array}{ccc|c} 1 & 1/2 & 1/2 & 2 \\ 0 & -7 & -3 & -21 \\ 0 & -5 & 1 & 4 \end{array} \right) \Rightarrow \left( \begin{array}{ccc|c} 1 & 0 & 2/7 & 1/2 \\ 0 & 1 & 3/7 & 3 \\ 0 & 0 & 22/7 & 11 \end{array} \right)$$

$$\Rightarrow \left( \begin{array}{ccc|c} 1 & 0 & 0 & -1/2 \\ 0 & 1 & 0 & 3/2 \\ 0 & 0 & 1 & 7/2 \end{array} \right)$$

Thus  $x = -1/2$ ,  $y = 3/2$ , and  $z = 7/2$ .

$$36. \left( \begin{array}{ccc|c} 1 & 0 & 2 & 8 \\ 1 & 2 & -2 & 4 \\ 2 & 5 & -6 & 6 \end{array} \right) \Rightarrow \left( \begin{array}{ccc|c} 1 & 0 & 2 & 8 \\ 0 & 2 & -4 & -4 \\ 0 & 5 & -10 & -10 \end{array} \right) \Rightarrow \left( \begin{array}{ccc|c} 1 & 0 & 2 & 8 \\ 0 & 1 & -2 & -2 \\ 0 & 0 & 0 & 0 \end{array} \right)$$

Letting  $z = t$  we find  $y = -2 + 2t$ , and  $x = 8 - 2t$ .

$$\begin{aligned}
 37. \quad & \left( \begin{array}{cccc|c} 1 & 1 & -1 & -1 & -1 \\ 1 & 1 & 1 & 1 & 3 \\ 1 & -1 & 1 & -1 & 3 \\ 4 & 1 & -2 & 1 & 0 \end{array} \right) \Rightarrow \left( \begin{array}{cccc|c} 1 & 1 & -1 & -1 & -1 \\ 0 & 0 & 2 & 2 & 4 \\ 0 & -2 & 2 & 0 & 4 \\ 0 & -3 & 2 & 5 & 4 \end{array} \right) \Rightarrow \left( \begin{array}{cccc|c} 1 & 0 & 0 & -1 & 1 \\ 0 & 1 & -1 & 0 & -2 \\ 0 & 0 & 2 & 2 & 4 \\ 0 & 0 & -1 & 5 & -2 \end{array} \right) \\
 & \Rightarrow \left( \begin{array}{cccc|c} 1 & 0 & 0 & -1 & 1 \\ 0 & 1 & 0 & 1 & 0 \\ 0 & 0 & 1 & 1 & 2 \\ 0 & 0 & 0 & 6 & 0 \end{array} \right) \Rightarrow \left( \begin{array}{cccc|c} 1 & 0 & 0 & 0 & 1 \\ 0 & 1 & 0 & 0 & 0 \\ 0 & 0 & 1 & 0 & 2 \\ 0 & 0 & 0 & 1 & 0 \end{array} \right)
 \end{aligned}$$

Thus  $x_1 = 1$ ,  $x_2 = 0$ ,  $x_3 = 2$ , and  $x_4 = 0$ .

$$38. \quad \left( \begin{array}{ccc|c} 1 & 3 & 1 & 0 \\ 2 & 1 & 1 & 0 \\ 7 & 1 & 3 & 0 \end{array} \right) \Rightarrow \left( \begin{array}{ccc|c} 1 & 3 & 1 & 0 \\ 0 & -5 & -1 & 0 \\ 0 & -20 & -4 & 0 \end{array} \right) \Rightarrow \left( \begin{array}{ccc|c} 1 & 0 & 2/5 & 0 \\ 0 & 1 & 1/5 & 0 \\ 0 & 0 & 0 & 0 \end{array} \right)$$

Letting  $x_3 = t$ , we find  $x_2 = -\frac{1}{5}t$  and  $x_1 = -\frac{2}{5}t$ .

$$39. \quad \left( \begin{array}{ccc|c} 1 & 2 & 4 & 2 \\ 2 & 4 & 3 & 1 \\ 1 & 2 & -1 & 7 \end{array} \right) \Rightarrow \left( \begin{array}{ccc|c} 1 & 2 & 4 & 2 \\ 0 & 0 & -5 & -3 \\ 0 & 0 & -5 & 5 \end{array} \right) \Rightarrow \left( \begin{array}{ccc|c} 1 & 2 & 0 & -2/5 \\ 0 & 0 & 1 & 3/5 \\ 0 & 0 & 0 & 8 \end{array} \right)$$

There is no solution.

$$40. \quad \left( \begin{array}{cccc|c} 1 & 1 & -1 & 3 & 1 \\ 0 & 1 & -1 & -4 & 0 \\ 1 & 2 & -2 & -1 & 6 \\ 4 & 7 & -7 & 0 & 9 \end{array} \right) \Rightarrow \left( \begin{array}{cccc|c} 1 & 1 & -1 & 3 & 1 \\ 0 & 1 & -1 & -4 & 0 \\ 0 & 1 & -1 & -4 & 5 \\ 0 & 3 & -3 & -12 & 5 \end{array} \right) \Rightarrow \left( \begin{array}{cccc|c} 1 & 0 & 0 & 7 & 1 \\ 0 & 1 & -1 & -4 & 0 \\ 0 & 0 & 0 & 0 & 5 \\ 0 & 0 & 0 & 0 & 5 \end{array} \right)$$

There is no solution.

$$\begin{aligned}
 41. \quad & \left[ \begin{array}{ccc|ccc} 4 & 2 & 3 & 1 & 0 & 0 \\ 2 & 1 & 0 & 0 & 1 & 0 \\ -1 & -2 & 0 & 0 & 0 & 1 \end{array} \right] \xrightarrow{R_{13}} \left[ \begin{array}{ccc|ccc} -1 & -2 & 0 & 0 & 0 & 1 \\ 2 & 1 & 0 & 0 & 1 & 0 \\ 4 & 2 & 3 & 1 & 0 & 0 \end{array} \right] \\
 & \xrightarrow{\text{row operations}} \left[ \begin{array}{ccc|ccc} 1 & 0 & 0 & 0 & \frac{2}{3} & \frac{1}{3} \\ 0 & 1 & 0 & 0 & -\frac{1}{3} & -\frac{2}{3} \\ 0 & 0 & 1 & \frac{1}{3} & -\frac{2}{3} & 0 \end{array} \right]; \quad \mathbf{A}^{-1} = \begin{bmatrix} 0 & \frac{2}{3} & \frac{1}{3} \\ 0 & -\frac{1}{3} & -\frac{2}{3} \\ \frac{1}{3} & -\frac{2}{3} & 0 \end{bmatrix}
 \end{aligned}$$

Introduction to Matrices

$$42. \left[ \begin{array}{ccc|ccc} 2 & 4 & -2 & 1 & 0 & 0 \\ 4 & 2 & -2 & 0 & 1 & 0 \\ 8 & 10 & -6 & 0 & 0 & 1 \end{array} \right] \xrightarrow[\text{operations}]{\text{row}} \left[ \begin{array}{ccc|ccc} 1 & 2 & -1 & \frac{1}{2} & 0 & 0 \\ 0 & 1 & -\frac{1}{3} & \frac{1}{3} & -\frac{1}{6} & 0 \\ 0 & 0 & 0 & -2 & -1 & 1 \end{array} \right]; \mathbf{A} \text{ is singular.}$$

$$43. \left[ \begin{array}{ccc|ccc} -1 & 3 & 0 & 1 & 0 & 0 \\ 3 & -2 & 1 & 0 & 1 & 0 \\ 0 & 1 & 2 & 0 & 0 & 1 \end{array} \right] \xrightarrow[\text{operations}]{\text{row}} \left[ \begin{array}{ccc|ccc} 1 & -3 & 0 & -1 & 0 & 0 \\ 0 & 1 & 1 & 1 & 1 & 0 \\ 0 & 0 & 1 & -1 & -1 & 1 \end{array} \right]$$

$$\xrightarrow[\text{operations}]{\text{row}} \left[ \begin{array}{ccc|ccc} 1 & 0 & 0 & 5 & 6 & -3 \\ 0 & 1 & 0 & 2 & 2 & -1 \\ 0 & 0 & 1 & -1 & -1 & 1 \end{array} \right]; \mathbf{A}^{-1} = \begin{bmatrix} 5 & 6 & -3 \\ 2 & 2 & -1 \\ -1 & -1 & 1 \end{bmatrix}$$

$$44. \left[ \begin{array}{ccc|ccc} 1 & 2 & 3 & 1 & 0 & 0 \\ 0 & 1 & 4 & 0 & 1 & 0 \\ 0 & 0 & 8 & 0 & 0 & 1 \end{array} \right] \xrightarrow[\text{operations}]{\text{row}} \left[ \begin{array}{ccc|ccc} 1 & 0 & 0 & 1 & -2 & \frac{5}{8} \\ 0 & 1 & 0 & 0 & 1 & -\frac{1}{2} \\ 0 & 0 & 1 & 0 & 0 & \frac{1}{8} \end{array} \right]; \mathbf{A}^{-1} = \begin{bmatrix} 1 & -2 & \frac{5}{8} \\ 0 & 1 & -\frac{1}{2} \\ 0 & 0 & \frac{1}{8} \end{bmatrix}$$

$$45. \left[ \begin{array}{cccc|cccc} 1 & 2 & 3 & 1 & 1 & 0 & 0 & 0 \\ -1 & 0 & 2 & 1 & 0 & 1 & 0 & 0 \\ 2 & 1 & -3 & 0 & 0 & 0 & 1 & 0 \\ 1 & 1 & 2 & 1 & 0 & 0 & 0 & 1 \end{array} \right] \xrightarrow[\text{operations}]{\text{row}} \left[ \begin{array}{cccc|cccc} 1 & 2 & 3 & 1 & 1 & 0 & 0 & 0 \\ 0 & 1 & \frac{5}{2} & 1 & \frac{1}{2} & \frac{1}{2} & 0 & 0 \\ 0 & 0 & 1 & -\frac{2}{3} & \frac{1}{3} & -1 & -\frac{2}{3} & 0 \\ 0 & 0 & 0 & 1 & -\frac{1}{2} & 1 & \frac{1}{2} & \frac{1}{2} \end{array} \right]$$

$$\xrightarrow[\text{operations}]{\text{row}} \left[ \begin{array}{cccc|cccc} 1 & 0 & 0 & 0 & -\frac{1}{2} & -\frac{2}{3} & -\frac{1}{6} & \frac{7}{6} \\ 0 & 1 & 0 & 0 & 1 & \frac{1}{3} & \frac{1}{3} & -\frac{4}{3} \\ 0 & 0 & 1 & 0 & 0 & -\frac{1}{3} & -\frac{1}{3} & \frac{1}{3} \\ 0 & 0 & 0 & 1 & -\frac{1}{2} & 1 & \frac{1}{2} & \frac{1}{2} \end{array} \right]; \mathbf{A}^{-1} = \begin{bmatrix} -\frac{1}{2} & -\frac{2}{3} & -\frac{1}{6} & \frac{7}{6} \\ 1 & \frac{1}{3} & \frac{1}{3} & -\frac{4}{3} \\ 0 & -\frac{1}{3} & -\frac{1}{3} & \frac{1}{3} \\ -\frac{1}{2} & 1 & \frac{1}{2} & \frac{1}{2} \end{bmatrix}$$

$$46. \left[ \begin{array}{cccc|cccc} 1 & 0 & 0 & 0 & 1 & 0 & 0 & 0 \\ 0 & 0 & 1 & 0 & 0 & 1 & 0 & 0 \\ 0 & 0 & 0 & 1 & 0 & 0 & 1 & 0 \\ 0 & 1 & 0 & 0 & 0 & 0 & 0 & 1 \end{array} \right] \xrightarrow[\text{interchange}]{\text{row}} \left[ \begin{array}{cccc|cccc} 1 & 0 & 0 & 0 & 1 & 0 & 0 & 0 \\ 0 & 1 & 0 & 0 & 0 & 0 & 0 & 1 \\ 0 & 0 & 1 & 0 & 0 & 1 & 0 & 0 \\ 0 & 0 & 0 & 1 & 0 & 0 & 1 & 0 \end{array} \right]; \mathbf{A}^{-1} = \begin{bmatrix} 1 & 0 & 0 & 0 \\ 0 & 0 & 0 & 1 \\ 0 & 1 & 0 & 0 \\ 0 & 0 & 1 & 0 \end{bmatrix}$$

47. We solve

$$\det(\mathbf{A} - \lambda \mathbf{I}) = \begin{vmatrix} -1 - \lambda & 2 \\ -7 & 8 - \lambda \end{vmatrix} = (\lambda - 6)(\lambda - 1) = 0.$$

For  $\lambda_1 = 6$  we have

$$\left( \begin{array}{cc|c} -7 & 2 & 0 \\ -7 & 2 & 0 \end{array} \right) \Rightarrow \left( \begin{array}{cc|c} 1 & -2/7 & 0 \\ 0 & 0 & 0 \end{array} \right)$$

so that  $k_1 = \frac{2}{7}k_2$ . If  $k_2 = 7$  then

$$\mathbf{K}_1 = \begin{pmatrix} 2 \\ 7 \end{pmatrix}.$$

For  $\lambda_2 = 1$  we have

$$\left( \begin{array}{cc|c} -2 & 2 & 0 \\ -7 & 7 & 0 \end{array} \right) \Rightarrow \left( \begin{array}{cc|c} 1 & -1 & 0 \\ 0 & 0 & 0 \end{array} \right)$$

so that  $k_1 = k_2$ . If  $k_2 = 1$  then

$$\mathbf{K}_2 = \begin{pmatrix} 1 \\ 1 \end{pmatrix}.$$

48. We solve

$$\det(\mathbf{A} - \lambda\mathbf{I}) = \begin{vmatrix} 2 - \lambda & 1 \\ 2 & 1 - \lambda \end{vmatrix} = \lambda(\lambda - 3) = 0.$$

For  $\lambda_1 = 0$  we have

$$\left( \begin{array}{cc|c} 2 & 1 & 0 \\ 2 & 1 & 0 \end{array} \right) \Rightarrow \left( \begin{array}{cc|c} 1 & 1/2 & 0 \\ 0 & 0 & 0 \end{array} \right)$$

so that  $k_1 = -\frac{1}{2}k_2$ . If  $k_2 = 2$  then

$$\mathbf{K}_1 = \begin{pmatrix} -1 \\ 2 \end{pmatrix}.$$

For  $\lambda_2 = 3$  we have

$$\left( \begin{array}{cc|c} -1 & 1 & 0 \\ 2 & -2 & 0 \end{array} \right) \Rightarrow \left( \begin{array}{cc|c} 1 & -1 & 0 \\ 0 & 0 & 0 \end{array} \right)$$

so that  $k_1 = k_2$ . If  $k_2 = 1$  then

$$\mathbf{K}_2 = \begin{pmatrix} 1 \\ 1 \end{pmatrix}.$$

49. We solve

$$\det(\mathbf{A} - \lambda\mathbf{I}) = \begin{vmatrix} -8 - \lambda & -1 \\ 16 & -\lambda \end{vmatrix} = (\lambda + 4)^2 = 0.$$

For  $\lambda_1 = \lambda_2 = -4$  we have

$$\left( \begin{array}{cc|c} -4 & -1 & 0 \\ 16 & 4 & 0 \end{array} \right) \Rightarrow \left( \begin{array}{cc|c} 1 & 1/4 & 0 \\ 0 & 0 & 0 \end{array} \right)$$

so that  $k_1 = -\frac{1}{4}k_2$ . If  $k_2 = 4$  then

$$\mathbf{K}_1 = \begin{pmatrix} -1 \\ 4 \end{pmatrix}.$$

*Introduction to Matrices*

50. We solve

$$\det(\mathbf{A} - \lambda\mathbf{I}) = \begin{vmatrix} 1 - \lambda & 1 \\ 1/4 & 1 - \lambda \end{vmatrix} = (\lambda - 3/2)(\lambda - 1/2) = 0.$$

For  $\lambda_1 = 3/2$  we have

$$\left( \begin{array}{cc|c} -1/2 & 1 & 0 \\ 1/4 & -1/2 & 0 \end{array} \right) \Rightarrow \left( \begin{array}{cc|c} 1 & -2 & 0 \\ 0 & 0 & 0 \end{array} \right)$$

so that  $k_1 = 2k_2$ . If  $k_2 = 1$  then

$$\mathbf{K}_1 = \begin{pmatrix} 2 \\ 1 \end{pmatrix}.$$

If  $\lambda_2 = 1/2$  then

$$\left( \begin{array}{cc|c} 1/2 & 1 & 0 \\ 1/4 & 1/2 & 0 \end{array} \right) \Rightarrow \left( \begin{array}{cc|c} 1 & 2 & 0 \\ 0 & 0 & 0 \end{array} \right)$$

so that  $k_1 = -2k_2$ . If  $k_2 = 1$  then

$$\mathbf{K}_2 = \begin{pmatrix} -2 \\ 1 \end{pmatrix}.$$

51. We solve

$$\det(\mathbf{A} - \lambda\mathbf{I}) = \begin{vmatrix} 5 - \lambda & -1 & 0 \\ 0 & -5 - \lambda & 9 \\ 5 & -1 & -\lambda \end{vmatrix} = \begin{vmatrix} 4 - \lambda & -1 & 0 \\ 4 - \lambda & -5 - \lambda & 9 \\ 4 - \lambda & -1 & -\lambda \end{vmatrix} = \lambda(4 - \lambda)(\lambda + 4) = 0.$$

If  $\lambda_1 = 0$  then

$$\left( \begin{array}{ccc|c} 5 & -1 & 0 & 0 \\ 0 & -5 & 9 & 0 \\ 5 & -1 & 0 & 0 \end{array} \right) \Rightarrow \left( \begin{array}{ccc|c} 1 & 0 & -9/25 & 0 \\ 0 & 1 & -9/5 & 0 \\ 0 & 0 & 0 & 0 \end{array} \right)$$

so that  $k_1 = \frac{9}{25}k_3$  and  $k_2 = \frac{9}{5}k_3$ . If  $k_3 = 25$  then

$$\mathbf{K}_1 = \begin{pmatrix} 9 \\ 45 \\ 25 \end{pmatrix}.$$

If  $\lambda_2 = 4$  then

$$\left( \begin{array}{ccc|c} 1 & -1 & 0 & 0 \\ 0 & -9 & 9 & 0 \\ 5 & -1 & -4 & 0 \end{array} \right) \Rightarrow \left( \begin{array}{ccc|c} 1 & 0 & -1 & 0 \\ 0 & 1 & -1 & 0 \\ 0 & 0 & 0 & 0 \end{array} \right)$$

so that  $k_1 = k_3$  and  $k_2 = k_3$ . If  $k_3 = 1$  then

$$\mathbf{K}_2 = \begin{pmatrix} 1 \\ 1 \\ 1 \end{pmatrix}.$$



If  $\lambda_3 = -4$  then

$$\left(\begin{array}{ccc|c} 9 & -1 & 0 & 0 \\ 0 & -1 & 9 & 0 \\ 5 & -1 & 4 & 0 \end{array}\right) \Rightarrow \left(\begin{array}{ccc|c} 1 & 0 & -1 & 0 \\ 0 & 1 & -9 & 0 \\ 0 & 0 & 0 & 0 \end{array}\right)$$

so that  $k_1 = k_3$  and  $k_2 = 9k_3$ . If  $k_3 = 1$  then

$$\mathbf{K}_3 = \begin{pmatrix} 1 \\ 9 \\ 1 \end{pmatrix}.$$

52. We solve

$$\det(\mathbf{A} - \lambda\mathbf{I}) = \begin{vmatrix} 3 - \lambda & 0 & 0 \\ 0 & 2 - \lambda & 0 \\ 4 & 0 & 1 - \lambda \end{vmatrix} = (3 - \lambda)(2 - \lambda)(1 - \lambda) = 0.$$

If  $\lambda_1 = 1$  then

$$\left(\begin{array}{ccc|c} 2 & 0 & 0 & 0 \\ 0 & 1 & 0 & 0 \\ 4 & 0 & 0 & 0 \end{array}\right) \Rightarrow \left(\begin{array}{ccc|c} 1 & 0 & 0 & 0 \\ 0 & 1 & 0 & 0 \\ 0 & 0 & 0 & 0 \end{array}\right)$$

so that  $k_1 = 0$  and  $k_2 = 0$ . If  $k_3 = 1$  then

$$\mathbf{K}_1 = \begin{pmatrix} 0 \\ 0 \\ 1 \end{pmatrix}.$$

If  $\lambda_2 = 2$  then

$$\left(\begin{array}{ccc|c} 1 & 0 & 0 & 0 \\ 0 & 0 & 0 & 0 \\ 4 & 0 & -1 & 0 \end{array}\right) \Rightarrow \left(\begin{array}{ccc|c} 1 & 0 & 0 & 0 \\ 0 & 0 & 1 & 0 \\ 0 & 0 & 0 & 0 \end{array}\right)$$

so that  $k_1 = 0$  and  $k_3 = 0$ . If  $k_2 = 1$  then

$$\mathbf{K}_2 = \begin{pmatrix} 0 \\ 1 \\ 0 \end{pmatrix}.$$

If  $\lambda_3 = 3$  then

$$\left(\begin{array}{ccc|c} 0 & 0 & 0 & 0 \\ 0 & -1 & 0 & 0 \\ 4 & 0 & -2 & 0 \end{array}\right) \Rightarrow \left(\begin{array}{ccc|c} 1 & 0 & -1/2 & 0 \\ 0 & 1 & 0 & 0 \\ 0 & 0 & 0 & 0 \end{array}\right)$$

### Introduction to Matrices

so that  $k_1 = \frac{1}{2}k_3$  and  $k_2 = 0$ . If  $k_3 = 2$  then

$$\mathbf{K}_3 = \begin{pmatrix} 1 \\ 0 \\ 2 \end{pmatrix}.$$

53. We solve

$$\det(\mathbf{A} - \lambda\mathbf{I}) = \begin{vmatrix} -\lambda & 4 & 0 \\ -1 & -4 - \lambda & 0 \\ 0 & 0 & -2 - \lambda \end{vmatrix} = -(\lambda + 2)^3 = 0.$$

For  $\lambda_1 = \lambda_2 = \lambda_3 = -2$  we have

$$\left( \begin{array}{ccc|c} 2 & 4 & 0 & 0 \\ -1 & -2 & 0 & 0 \\ 0 & 0 & 0 & 0 \end{array} \right) \Rightarrow \left( \begin{array}{ccc|c} 1 & 2 & 0 & 0 \\ 0 & 0 & 0 & 0 \\ 0 & 0 & 0 & 0 \end{array} \right).$$

so that  $k_1 = -2k_2$ . If  $k_2 = 1$  and  $k_3 = 1$  then

$$\mathbf{K}_1 = \begin{pmatrix} -2 \\ 1 \\ 0 \end{pmatrix} \quad \text{and} \quad \mathbf{K}_2 = \begin{pmatrix} 0 \\ 0 \\ 1 \end{pmatrix}.$$

54. We solve

$$\det(\mathbf{A} - \lambda\mathbf{I}) = \begin{vmatrix} 1 - \lambda & 6 & 0 \\ 0 & 2 - \lambda & 1 \\ 0 & 1 & 2 - \lambda \end{vmatrix} = \begin{vmatrix} 1 - \lambda & 6 & 0 \\ 0 & 3 - \lambda & 3 - \lambda \\ 0 & 1 & 2 - \lambda \end{vmatrix} = (3 - \lambda)(1 - \lambda)^2 = 0.$$

For  $\lambda = 3$  we have

$$\left( \begin{array}{ccc|c} -2 & 6 & 0 & 0 \\ 0 & 0 & 0 & 0 \\ 0 & 1 & -1 & 0 \end{array} \right) \Rightarrow \left( \begin{array}{ccc|c} 1 & 0 & -3 & 0 \\ 0 & 1 & -1 & 0 \\ 0 & 0 & 0 & 0 \end{array} \right)$$

so that  $k_1 = 3k_3$  and  $k_2 = k_3$ . If  $k_3 = 1$  then

$$\mathbf{K}_1 = \begin{pmatrix} 3 \\ 1 \\ 1 \end{pmatrix}.$$

For  $\lambda_2 = \lambda_3 = 1$  we have

$$\left( \begin{array}{ccc|c} 0 & 6 & 0 & 0 \\ 0 & 1 & 1 & 0 \\ 0 & 1 & 1 & 0 \end{array} \right) \Rightarrow \left( \begin{array}{ccc|c} 0 & 1 & 0 & 0 \\ 0 & 0 & 1 & 0 \\ 0 & 0 & 0 & 0 \end{array} \right)$$

so that  $k_2 = 0$  and  $k_3 = 0$ . If  $k_1 = 1$  then

$$\mathbf{K}_2 = \begin{pmatrix} 1 \\ 0 \\ 0 \end{pmatrix}.$$

55. We solve

$$\det(\mathbf{A} - \lambda\mathbf{I}) = \begin{vmatrix} -1 - \lambda & 2 \\ -5 & 1 - \lambda \end{vmatrix} = \lambda^2 + 9 = (\lambda - 3i)(\lambda + 3i) = 0.$$

For  $\lambda_1 = 3i$  we have

$$\left( \begin{array}{cc|c} -1 - 3i & 2 & 0 \\ -5 & 1 - 3i & 0 \end{array} \right) \Rightarrow \left( \begin{array}{cc|c} 1 & -(1/5) + (3/5)i & 0 \\ 0 & 0 & 0 \end{array} \right)$$

so that  $k_1 = \left(\frac{1}{5} - \frac{3}{5}i\right)k_2$ . If  $k_2 = 5$  then

$$\mathbf{K}_1 = \begin{pmatrix} 1 - 3i \\ 5 \end{pmatrix}.$$

For  $\lambda_2 = -3i$  we have

$$\left( \begin{array}{cc|c} -1 + 3i & 2 & 0 \\ -5 & 1 + 3i & 0 \end{array} \right) \Rightarrow \left( \begin{array}{cc|c} 1 & -\frac{1}{5} - \frac{3}{5}i & 0 \\ 0 & 0 & 0 \end{array} \right)$$

so that  $k_1 = \left(\frac{1}{5} + \frac{3}{5}i\right)k_2$ . If  $k_2 = 5$  then

$$\mathbf{K}_2 = \begin{pmatrix} 1 + 3i \\ 5 \end{pmatrix}.$$

56. We solve

$$\begin{aligned} \det(\mathbf{A} - \lambda\mathbf{I}) &= \begin{vmatrix} 2 - \lambda & -1 & 0 \\ 5 & 2 - \lambda & 4 \\ 0 & 1 & 2 - \lambda \end{vmatrix} = -\lambda^3 + 6\lambda^2 - 13\lambda + 10 = (\lambda - 2)(-\lambda^2 + 4\lambda - 5) \\ &= (\lambda - 2)(\lambda - (2 + i))(\lambda - (2 - i)) = 0. \end{aligned}$$

For  $\lambda_1 = 2$  we have

$$\left( \begin{array}{ccc|c} 0 & -1 & 0 & 0 \\ 5 & 0 & 4 & 0 \\ 0 & 1 & 0 & 0 \end{array} \right) \Rightarrow \left( \begin{array}{ccc|c} 1 & 0 & 4/5 & 0 \\ 0 & 1 & 0 & 0 \\ 0 & 0 & 0 & 0 \end{array} \right)$$

so that  $k_1 = -\frac{4}{5}k_3$  and  $k_2 = 0$ . If  $k_3 = 5$  then

$$\mathbf{K}_1 = \begin{pmatrix} -4 \\ 0 \\ 5 \end{pmatrix}.$$

## Introduction to Matrices

For  $\lambda_2 = 2 + i$  we have

$$\left( \begin{array}{ccc|c} -i & -1 & 0 & 0 \\ 5 & -i & 4 & 0 \\ 0 & 1 & -i & 0 \end{array} \right) \Rightarrow \left( \begin{array}{ccc|c} 1 & -i & 0 & 0 \\ 0 & 1 & -i & 0 \\ 0 & 0 & 0 & 0 \end{array} \right)$$

so that  $k_1 = ik_2$  and  $k_2 = ik_3$ . If  $k_3 = i$  then

$$K_2 = \begin{pmatrix} -i \\ -1 \\ i \end{pmatrix}.$$

For  $\lambda_3 = 2 - i$  we have

$$\left( \begin{array}{ccc|c} i & -1 & 0 & 0 \\ 5 & i & 4 & 0 \\ 0 & 1 & i & 0 \end{array} \right) \Rightarrow \left( \begin{array}{ccc|c} 1 & i & 0 & 0 \\ 0 & 1 & i & 0 \\ 0 & 0 & 0 & 0 \end{array} \right)$$

so that  $k_1 = -ik_2$  and  $k_2 = -ik_3$ . If  $k_3 = i$  then

$$K_3 = \begin{pmatrix} -1 \\ 1 \\ i \end{pmatrix}.$$

57. Let

$$A = \begin{pmatrix} a_{11} & a_{12} \\ a_{21} & a_{22} \end{pmatrix}.$$

Then

$$\begin{aligned} \frac{d}{dt}[A(t)X(t)] &= \frac{d}{dt} \begin{pmatrix} a_1 & a_2 \\ a_3 & a_4 \end{pmatrix} \begin{pmatrix} x_1 \\ x_2 \end{pmatrix} = \frac{d}{dt} \begin{pmatrix} a_1x_1 + a_2x_2 \\ a_3x_1 + a_4x_2 \end{pmatrix} = \begin{pmatrix} a_1x_1' + a_1'x_1 + a_2x_2' + a_2'x_2 \\ a_3x_1' + a_3'x_1 + a_4x_2' + a_4'x_2 \end{pmatrix} \\ &= \begin{pmatrix} a_1 & a_2 \\ a_3 & a_4 \end{pmatrix} \begin{pmatrix} x_1' \\ x_2' \end{pmatrix} + \begin{pmatrix} a_1' & a_2' \\ a_3' & a_4' \end{pmatrix} \begin{pmatrix} x_1 \\ x_2 \end{pmatrix} = A(t)X'(t) + A'(t)X(t). \end{aligned}$$

58. Assume  $\det A \neq 0$  and  $AB = I$ , so that

$$\begin{pmatrix} a_{11} & a_{12} \\ a_{21} & a_{22} \end{pmatrix} \begin{pmatrix} b_{11} & b_{12} \\ b_{21} & b_{22} \end{pmatrix} = \begin{pmatrix} 1 & 0 \\ 0 & 1 \end{pmatrix}.$$

Then

$$\begin{aligned} a_{11}b_{11} + a_{12}b_{21} &= 1 & \text{and} & & a_{11}b_{12} + a_{12}b_{22} &= 0 \\ a_{21}b_{11} + a_{22}b_{21} &= 0 & & & a_{21}b_{12} + a_{22}b_{22} &= 1 \end{aligned}$$