

INDEX

10 Cornerstones.....2	dc-dc converters9, 10, 11	Kirchoff's current law2	root mean square 19
1-phase bipolar inverter11	decibel3	Kirchoff's voltage law.....2	rpm
3-phase inverter14	delta-wye transformer.....8	KVL2	induction motor..... 16
3-phase power and	dependent variable.....20	L inductance3	s slip..... 16
commutation.....7	derivatives19	L'Hôpital's rule.....20	S.S. capacitor principle 2
3-phase PWM inverter.....14	diode current.....8	LC tank circuit3	S.S. inductor principle.....2
3-phase rectifier7	distortion2	linear range.....12	series 20
3-phase Thévenin equivalent	duty cycle9	linearizing an equation20	single-phase bridge rectifier 6
.....8	\mathcal{E} electric field20	m_a amplitude modulation	slip 16
with α8	efficiency of induction motor	ratio12	slip frequency.....16
3-phase voltage and17	magnitude.....18	slip speed16
commutation.....7, 8	electric motors15	Maxwell's equations20	space-time18
air gap flux16	Euler's equation19	m_f frequency modulation	sphere20
amp3	even function.....4	ratio12	square wave
Ampere's law20	farad3	minimum inductance.....9	Fourier series 5
amplitude modulation ratio12	Faraday's law20	model	square wave inverter 11
area	Fourier series2, 4, 5	induction motor..... 15	starting torque 15
sphere20	square wave.....5	motor	step-down converter..... 10
average2	frequency domain20	induction motor..... 16	step-up converter..... 10
average value19	frequency modulation ratio12	newton.....3	synchronous pulse width
\mathcal{B} magnetic flux dens.20	frequency modulation ratio12	n_s synchronous speed16	modulation 12
binomial expansion.....20	f_{sl} slip frequency16	odd function4	synchronous speed16
binomial theorem.....20	full bridge converter.....11	overmodulation12	tank circuit 3
bipolar inverter12	Gauss' law20	parallel resistance3	temperature3
bridge rectifier6	general math18	PF power factor.....3	tesla3
buck converter10	generalized harmonics	3-phase rectifier9	THD2
buck-boost converter ...10, 11	1-phase13	phase18	Thévenin equivalent..... 7
C capacitance.....3	3-phase14	phase current8	3-phase..... 8
calculus19	graph paper.....21	phasor notation.....18	with α 8
capacitance3	graphing terminology20	plotting I_18	three-phase rectifier 7
capacitor2	\mathcal{H} magnetic field20	plotting i_A8	time domain20
CF crest factor2	half-wave rectifier5	plotting paper21	time-average.....18
commutation	harmonics	plotting V_18	time-averaged power.....18
3-phase power7	generalized, 1-phase.....13	plotting V_{dc}8	time-harmonic20
3-phase voltage7, 8	generalized, 3-phase.....14	power2	torque15
power.....6	henry3	electric motor.....15	constant.....17
voltage.....6	Hoft2	power and commutation.....6	starting15
commutation interval.....6	horsepower3	power factor3	trigonometric identities19
complex conjugate.....18	hyperbolic functions.....20	3-phase rectifier9	u commutation interval6
complex numbers18	I_18	pull out15	unibipolar inverter.....12
conjugate	i_A rectifier current8	pulse width modulation	units3
complex.....18	independent variable20	synchronous12	V_18
constant torque17	inductance3	pulse width modulation in	V_{dc}8
constant volts/Hz.....17	induction motor16	inverters.....12	v_i relationship.....2
converter	induction motor model15	PWM pulse width	volt3
buck.....10	inductor2	modulation12	voltage and commutation ...6
buck-boost.....10, 11	LC tank circuit3	PWM inverter	volts/Hz ratio.....17
Cúk.....11	integration19	3-phase.....14	volume
dc-dc.....9, 10, 11	inverter11, 14	rectifier	sphere.....20
step-down10	3-phase14	three-phase.....7	watt3
step-up.....10	bipolar11	rectifiers5	weber.....3
coulomb3	harmonic voltage.....13	resistance	wye-delta transformer 8
crest factor2	pulse width modulation12	in parallel3	ϕ_{ag} air gap flux16
Cúk converter11	\mathcal{J} current density20	resistor.....2	η efficiency of induction
\mathcal{D} electric flux dens.....20	joule3	rms2, 19	motor17
dB decibels3	KCL.....2	square wave19	ρ_v volume charge dens.20
dc.....2, 19	kelvin.....3	rms harmonic voltage in	ω_{sl} slip speed16
dc-ac inverters11, 14	Kimbark's equations7	inverters.....13	
	with α7		

10 CORNERSTONES OF POWER ELECTRONICS - Hoft

1. KVL

Kirchoff's Voltage Law. The sum of the changes in voltage around a circuit loop is equal to zero. This is true in both the instantaneous and average (integrate over one cycle) sense.

2. KCL

Kirchoff's Current Law. The current entering a node is equal to the current leaving the node. This is also true in both the instantaneous and average (integrate over one cycle) sense.

3. v i RESISTOR

The voltage to current relationship in a resistor.

$$v = ir$$

4. v i CAPACITOR

The voltage to current relationship in a capacitor.

$$i = C \frac{dv}{dt}$$

5. v i INDUCTOR

The voltage to current relationship in an inductor.

$$v = L \frac{di}{dt}$$

6. AVERAGE (DC) AND RMS

Average and dc will be synonymous in this class, but are not the same as rms.

$$v_{\text{avg}} = \frac{1}{T} \int_{t_0}^{t_0+T} v(t) dt$$

$$v_{\text{rms}} = \sqrt{\frac{1}{T} \int_{t_0}^{t_0+T} v^2(t) dt}$$

7. POWER

We are concerned with both instantaneous and average power. As with rms values, power is related to heating.

$$P_{\text{avg}} = \frac{1}{T} \int_{t_0}^{t_0+T} p(t) dt$$

$$p(t) = v(t) i(t)$$

$p(t)$ = instantaneous power [W]

8. S.S. INDUCTOR PRINCIPLE

Under steady state conditions, the average voltage across an inductor is zero.

9. S.S. CAPACITOR PRINCIPLE

Under steady state conditions, the average current through a capacitor is zero.

10. FOURIER SERIES

In the 1820s, Fourier came out with a 1-page paper on his Fourier series. A periodic function may be described as an infinite sum of sines and cosines.

$$v(t) = V_{\text{avg}} + \sum_{k=1}^{\infty} [a_k \cos(k\omega_0 t) + b_k \sin(k\omega_0 t)]$$

See p4.

DISTORTION [%]

Distortion is the degree to which a signal differs from its fundamental frequency.

$$\text{THD} = \frac{\text{RMS value of harmonics for } k > 1}{\text{RMS value of fundamental frequency } k = 1}$$

$$\begin{aligned} \% \text{THD} &= 100 \frac{V_{\text{dis}}}{V_{\text{rms1}}} \\ &= 100 \frac{\sqrt{V_{\text{rms}}^2 - V_{\text{rms1}}^2}}{V_{\text{rms1}}} \end{aligned}$$

Use the polar form of the Fourier Series, see p4.

V_{dis} = rms voltage distortion [V]

V_{rms1} = fundamental frequency rms voltage [V]

V_{rms} = rms voltage [V]

THD = Total Harmonic Distortion [V]

CREST FACTOR [no units]

The crest factor quantifies the *smoothness* of the waveform and is related to the weight of its impact on components. For DC and a square wave the crest factor is 1, for a sine wave, it is 1.414. A large crest factor means the wave is not as efficient at delivering energy.

$$\text{CF} = \frac{V_{\text{peak}}}{V_{\text{rms}}}$$

PF POWER FACTOR [no units]

The power factor is the ratio of true power (the power consumed, ignoring the reactive factor) to apparent power (the total power consumed). Also, the power factor is the cosine of the angle by which the current lags the voltage (assuming an inductive load).

$$\text{PF} = \cos(\theta_v - \theta_i)$$

DECIBELS [dB]

A log based unit of energy that makes it easier to describe exponential losses, etc. The decibel means 10 bels, a unit named after Bell Laboratories.

$$L = 20 \log \frac{\text{voltage or current}}{\text{reference voltage or current}}$$

$$L = 10 \log \frac{\text{power}}{\text{reference power}}$$

UNITS, electrical

$$I \text{ (current in amps)} = \frac{q}{s} = \frac{W}{V} = \frac{J}{V \cdot s} = \frac{N \cdot m}{V \cdot s} = \frac{V \cdot C}{s}$$

$$q \text{ (charge in coulombs)} = I \cdot s = V \cdot C = \frac{J}{V} = \frac{N \cdot m}{V} = \frac{W \cdot s}{V}$$

$$C \text{ (capacitance in farads)} = \frac{q}{V} = \frac{q^2}{J} = \frac{q^2}{N \cdot m} = \frac{J}{V^2} = \frac{I \cdot s}{V}$$

$$H \text{ (inductance in henrys)} = \frac{V \cdot s}{I} \quad (\text{note that } H \cdot F = s^2)$$

$$J \text{ (energy in joules)} = N \cdot m = V \cdot q = W \cdot s = I \cdot V \cdot s = C \cdot V^2 = \frac{q^2}{C}$$

$$N \text{ (force in newtons)} = \frac{J}{m} = \frac{q \cdot V}{m} = \frac{W \cdot s}{m} = \frac{kg \cdot m}{s^2}$$

$$T \text{ (magnetic flux density in teslas)} = \frac{Wb}{m^2} = \frac{V \cdot s}{m^2} = \frac{H \cdot I}{m^2}$$

V (electric potential in volts) =

$$\frac{W}{I} = \frac{J}{q} = \frac{J}{I \cdot s} = \frac{W \cdot s}{q} = \frac{N \cdot m}{q} = \frac{q}{C}$$

W (power in watts) =

$$\frac{J}{s} = \frac{N \cdot m}{s} = \frac{q \cdot V}{s} = V \cdot I = \frac{C \cdot V^2}{s} = \frac{1}{746} \text{ HP}$$

$$Wb \text{ (magnetic flux in webers)} = H \cdot I = V \cdot s = \frac{J}{I}$$

Temperature: [°C or K] 0°C = 273.15K

where s is seconds

C CAPACITANCE [F]

$$i(t) = I_f + (I_o - I_f)e^{-t/\tau}$$

$$v(t) = V_f + (V_o - V_f)e^{-t/\tau}$$

where $\tau = RC$

$$i_c(t) = C \frac{dv}{dt} \quad V_c(t) = \frac{1}{C} \int_0^t i d\tau + V_o$$

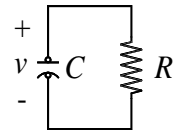

L INDUCTANCE [H]

$$i(t) = I_f + (I_o - I_f)e^{-t/\tau}$$

$$v(t) = V_f + (V_o - V_f)e^{-t/\tau}$$

where $\tau = L / R$

$$v_L(t) = L \frac{di}{dt} \quad I_L(t) = \frac{1}{L} \int_0^t v d\tau + I_o$$

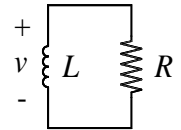

LC TANK CIRCUIT

Resonant frequency:

$$f = \frac{1}{2\pi\sqrt{LC}}$$

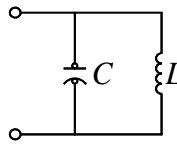

PARALLEL RESISTANCE

I never can remember the formula for two resistances in parallel. I just do it the hard way.

$$R_1 \parallel R_2 = \frac{R_1 R_2}{R_1 + R_2}$$

FOURIER SERIES

The Fourier Series is a method of describing a complex periodic function in terms of the frequencies and amplitudes of its fundamental and harmonic frequencies.

Let $f(t) = f(t+T) =$ any periodic signal

where $T = \frac{2\pi}{\omega} =$ the period.

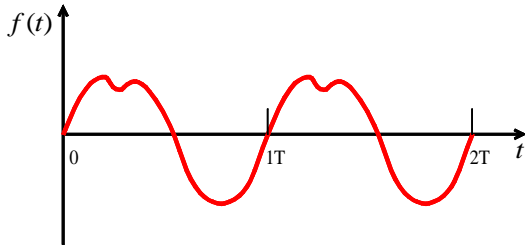

Then
$$f(t) = F_{\text{avg}} + \sum_{k=1}^{\infty} [a_k \cos(k\omega_0 t) + b_k \sin(k\omega_0 t)]$$

$\omega_0 =$ the fundamental frequency ($k=1$) in radians/sec.

$k\omega_0 =$ the harmonic frequencies ($k=2,3,4\dots$) in radians/sec.

$k =$ denotes the fundamental ($k=1$) or harmonic frequencies ($k=2,3,4\dots$), not the wave number or propagation constant

$F_{\text{avg}} =$ the average value of $f(t)$, or the DC offset

$$F_{\text{avg}} = \frac{1}{T} \int_{t_0}^{t_0+T} f(t) dt$$

$a_k =$ twice the average value of $f(t)\cos(k\omega_0 t)$

$$a_k = \frac{2}{T} \int_{t_0}^{t_0+T} f(t) \cos k\omega t dt$$

$b_k =$ twice the average value of $f(t)\sin(k\omega_0 t)$

$$b_k = \frac{2}{T} \int_{t_0}^{t_0+T} f(t) \sin k\omega t dt$$

$t_0 =$ an arbitrary time

FOURIER SERIES and Symmetry

When the function $f(t)$ is symmetric, certain shortcuts can be taken.

When $f(t)$ is an **even function**, i.e. $f(t)=f(-t)$, b_k is zero. The Fourier series becomes:

$$f(t) = F_{\text{avg}} + \sum_{k=1}^{\infty} [a_k \cos(k\omega_0 t)]$$

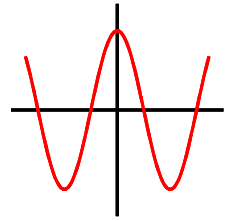

If there is also half-wave symmetry, then:

$$a_k = \frac{4}{T} \int_0^{T/2} f(t) \cos n\omega t dt$$

When $f(t)$ is an **odd function**, i.e. $f(t)=-f(-t)$, a_k is zero. The Fourier series becomes:

$$f(t) = F_{\text{avg}} + \sum_{k=1}^{\infty} [b_k \sin(k\omega_0 t)]$$

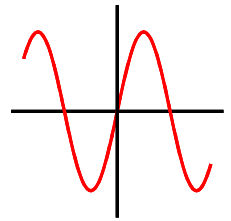

If there is also half-wave symmetry, then:

$$b_k = \frac{4}{T} \int_0^{T/2} f(t) \sin n\omega t dt$$

When $f(t)$ has **half-wave symmetry**, i.e. $f(t)=-f(t\pm T/2)$, there are only odd harmonics. $k=1, 3, 5, \dots$

$$a_k = \frac{4}{T} \int_{t_0}^{t_0+T/2} f(t) \cos n\omega t dt$$

$$b_k = \frac{4}{T} \int_{t_0}^{t_0+T/2} f(t) \sin n\omega t dt$$

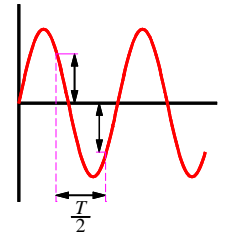

FOURIER SERIES, Polar Form

$$f(t) = F_{\text{avg}} + \sum_{k=1}^{\infty} [F_k \sin(k\omega_0 t + \delta_k)]$$

where

$$F_k = \sqrt{a_k^2 + b_k^2}, \quad \delta_k = \tan^{-1} \frac{-b_k}{a_k}$$

$$a_k = \frac{2}{T} \int_{t_0}^{t_0+T} f(t) \cos n\omega t dt$$

$$b_k = \frac{2}{T} \int_{t_0}^{t_0+T} f(t) \sin n\omega t dt$$

FOURIER SERIES OF A SQUARE WAVE

A 50% duty cycle square wave can be represented as an infinite sum of a fundamental sine wave and smaller odd harmonics.

$$\frac{4A}{\pi} \left[\sin(\omega_0 t) + \frac{1}{3} \sin(3\omega_0 t) + \frac{1}{5} \sin(5\omega_0 t) + \frac{1}{7} \sin(7\omega_0 t) + \dots \right]$$

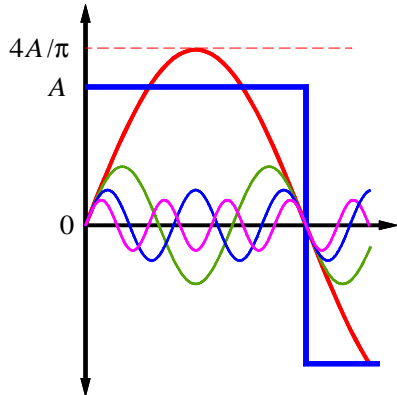

SINGLE-PHASE RECTIFIERS

HALF-WAVE RECTIFIER

As the supply voltage begins its positive sinusoidal excursion, the diode conducts and current begins to flow in the inductor. When the voltage crosses zero, the current continues to flow through the inductor for a short period due to its stored energy and the diode conducts until the inductor current flow has halted. This point is called *extinction* and occurs at the angle β , where $\pi < \beta < 2\pi$. At this time v_d , which has followed the supply voltage into the negative region, becomes zero (discontinuous). v_d and the inductor current remain at zero until the next cycle.

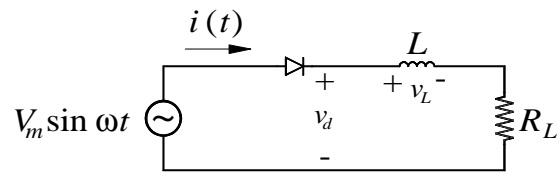

$$v_L = L \frac{di}{dt}$$

While current is flowing through the diode, there is zero voltage across the diode. When current flow stops at angle β , the voltage across the diode becomes negative (discontinuous). Since the average (dc) voltage at the source is zero and the average voltage across an inductor is zero, the average voltage across R_L is the negative of the average voltage across the diode.

$$V_{\text{diode}} = \frac{1}{2\pi} \int_{\beta}^{2\pi} V_m \sin \theta d\theta = -V_{R \text{ avg}}$$

The average voltage across R_L can also be expressed as the product of the average (short circuit) current and R_L . Under short circuit conditions, the average voltage can be found by integrating of a half-period.

$$V_{R \text{ avg}} = I_{\text{sc}} R_L \quad V_{R \text{ avg}} = \frac{1}{T} \int_0^{T/2} V_m \sin \omega t dt$$

Now there is enough information here to find β iteratively.

BRIDGE RECTIFIER, CONSTANT LOAD VOLTAGE

The current i_d begins to flow when the magnitude of the supply voltage exceeds V_d . The current peaks when the supply voltage magnitude returns to the level of V_d . As the supply voltage magnitude continues to fall, i_d rapidly returns to zero.

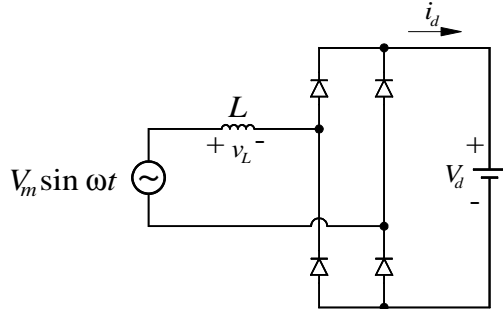

$$V_d = V_m \sin \theta_b$$

$$v_L = L \frac{di_d}{dt} = V_m \sin(\omega t) - V_d$$

$$0 = \int_{\theta_b}^{\theta_f} [V_m \sin(\omega t) - V_d] d(\omega t)$$

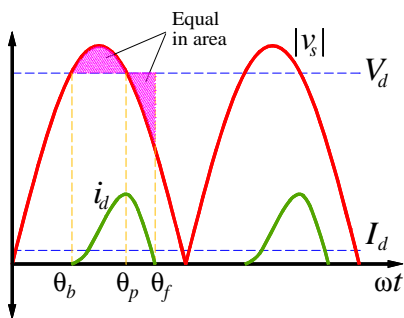

V_d = the voltage at the output [V]

V_m = the peak input voltage [V]

θ_b = the angle at which an increasing supply voltage waveform reaches V_d and current begins to flow in the inductor. [radians]

θ_p = the angle at which i_d peaks [radians] $\theta_p = \pi - \theta_b$

θ_f = the angle at which the current i_d returns to zero. [radians]

SINGLE-PHASE BRIDGE RECTIFIER

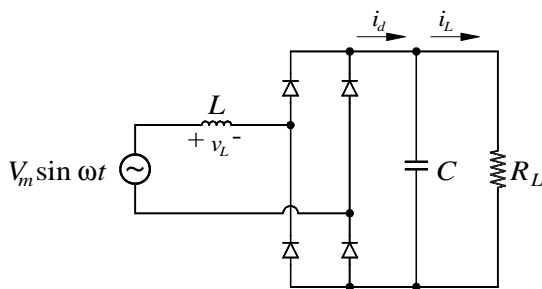

u COMMUTATION INTERVAL

Commutation is the transfer of the electrical source from one path to another. For bridge rectifiers, it refers to the period of time when diodes from two sources are on simultaneously, i.e. the delay interval associated with a reverse-biased diode turning off. The commutation interval is usually expressed as an angle u .

The commutation interval is associated with rectifier circuits having a constant current load (inductance dominates load) and a finite inductance L_s in the supply. The interval begins when the source voltage crosses zero going positive or when the thyristor gate is triggered.

$$\text{No trigger: } \cos u = 1 - \frac{2\omega L_s I_d}{V_m}$$

$$\text{With trigger: } \cos(\alpha + u) = \cos \alpha - \frac{2\omega L_s I_d}{V_m}$$

ω = the supply frequency [rad./sec.]

L_s = the supply inductance [H]

I_d = the (constant) load current [A]

V_m = the peak input voltage [V]

POWER AND COMMUTATION

In order to have power, the commutation interval must not be zero.

$$P_d = \frac{V_m^2}{2\omega L_s \pi} (1 - \cos^2 u)$$

ω = the supply frequency [rad./sec.]

L_s = the supply inductance [H]

I_d = the (constant) load current [A]

V_m = the peak input voltage [V]

VOLTAGE AND COMMUTATION

The average voltage output of a full wave bridge rectifier is

$$V_d = \frac{V_m}{\pi} (\cos u + 1)$$

ω = the supply frequency [rad./sec.]

L_s = the supply inductance [H]

I_d = the (constant) load current [A]

V_m = the peak input voltage [V]

THÈVENIN EQUIVALENT

The Thèvenin equivalent for a single-phase full wave bridge rectifier.

$$V_{TH} = \frac{2V_m}{\pi}$$

$$R_{TH} = \frac{2\omega L_s}{\pi}$$

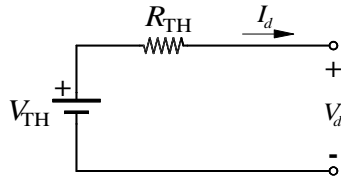

ω = the supply frequency [rad./sec.]

L_s = the supply inductance [H]

I_d = the (constant) load current [A]

V_m = the peak input voltage [V]

V_d = the average output voltage [V]

THREE-PHASE RECTIFIERS

THREE-PHASE RECTIFIER

This circuit is known as **3-phase, 6-pulse line commutated converter**. When the load is dominated by inductance, it is modeled as a current source (constant current) as shown below. If the load is capacitive, it is modeled as a voltage source.

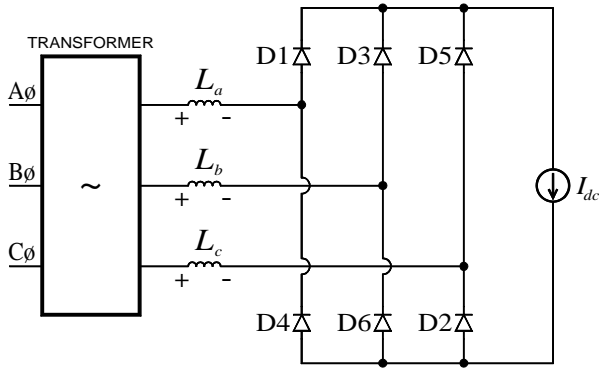

KIMBARK'S EQUATIONS

Kimbar's equations give the average current, voltage, and power of a 3-phase rectifier as a function of the commutation interval u .

$$1^{st}: I_{dc} = \frac{V_{LLp}}{2\omega L} (1 - \cos u)$$

$$2^{nd}: V_{dc} = \frac{3V_{LLp}}{2\pi} (1 + \cos u)$$

$$3^{rd}: P_{dc} = \frac{3V_{LLp}^2}{4\pi\omega L} (1 - \cos^2 u)$$

V_{LLp} = peak line-to-line voltage [V]

ω = the supply frequency [rad./sec.]

L = the load inductance [H]

u = the commutation interval [degrees]

KIMBARK'S EQUATIONS (with α)

When the trigger angle α is included, Kimbar's equations become:

$$1^{st}: I_{DC} = \frac{V_{LLp}}{2\omega L} [\cos \alpha - \cos(\alpha + u)]$$

$$2^{nd}: V_{dc} = \frac{3V_{LLp}}{2\pi} [\cos \alpha + \cos(\alpha + u)]$$

$$3^{rd}: P_{dc} = \frac{3V_{LLp}^2}{4\pi\omega L} [\cos^2 \alpha - \cos^2(\alpha + u)]$$

V_{LLp} = peak line-to-line voltage [V]

ω = the supply frequency [rad./sec.]

α = the angle ωt at which the thyristor is triggered [degrees]

L = the per phase inductance [H]

u = the commutation interval [degrees]

3-PHASE POWER AND COMMUTATION

In order to have power, the commutation interval must not be zero. In commercial systems, the commutation interval is typically 4 to 5 degrees but may be as high as 20° in special high-power converters. The theoretical maximum is $u = 60^\circ$.

3-PHASE VOLTAGE AND COMMUTATION

The average voltage output of a three-phase rectifier can be found by integrating over the first 60°. In the formula below, the limits of integration have been shifted to make the function fit the cosine function.

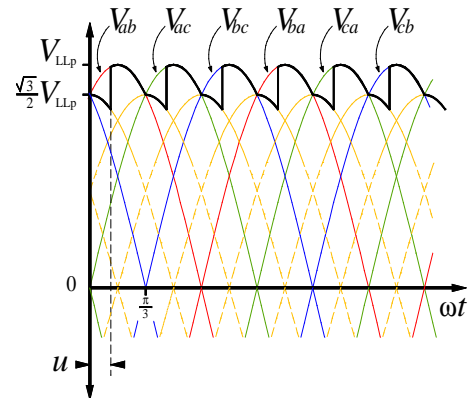

$$V_{dc} = \frac{1}{\pi/3} \left[\int_0^u \frac{\sqrt{3}}{2} V_{LLp} \cos \theta d\theta + \int_{u-\pi/6}^{\pi/6} V_{LLp} \cos \theta d\theta \right]$$

PLOTTING V_{dc} (constant current) WITH α

V_{dc} is periodic at 60° intervals. During the commutation interval (from α to $\alpha+u$), V_{dc} follows the $3/2 V_{bn}$ curve. This curve is centered between the V_{cb} and V_{ab} curves. For the remainder of its period, V_{dc} follows the V_{ab} curve. A graph sheet is provided on page 21 for practice.

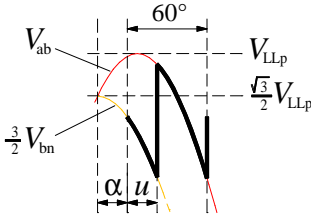

V_{LLp} = peak line-to-line voltage [V]
 α = the angle ωt at which the thyristor is triggered [degrees]

PLOTTING V_1 (constant current)

V_1 is the voltage across diode D1. V_1 is more complicated and is periodic at 360° intervals. Refer to the circuit entitled *Three-Phase Rectifier* on page 7. Plot V_{dc} first. While D1 is on, V_1 is zero. When D1 goes off, V_1 briefly follows V_{ab} then $-V_{dc}$. After that, it tracks V_{ac} and then repeats the cycle. A graph sheet is provided on page 21 for practice.

α to $120^\circ + \alpha + u$	V_1 is zero
$120^\circ + \alpha + u$ to $180^\circ + \alpha$	V_1 tracks V_{ab}
$180^\circ + \alpha$ to $300^\circ + \alpha + u$	V_1 is $-V_{dc}$
$300^\circ + \alpha + u$ to α	V_1 tracks V_{ac}

The 0° reference is 30° before V_{ab} peak voltage.

PLOTTING I_1 (constant current)

I_1 is the current through diode D1 of a 3-phase rectifier. I_1 is periodic at 360° intervals. A graph sheet is provided on page 21 for practice.

α to $\alpha + u$	I_1 rises from 0 to I_{1max}
$\alpha + u$ to $120^\circ + \alpha$	I_1 is constant
$120^\circ + \alpha$ to $120^\circ + \alpha + u$	I_1 falls to zero

The 0° reference angle is 30° before V_{ab} peak voltage.

The curvature of the rising and falling diode current plots is related to the trigger angle α .

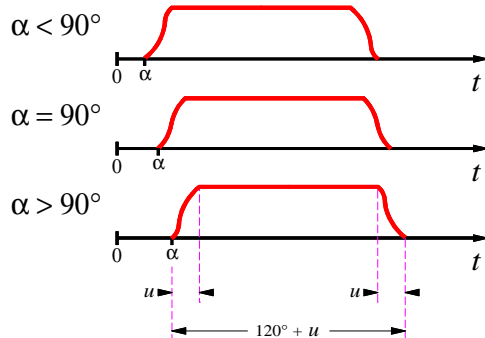

PLOTTING i_A (constant current)

i_A is the current through the A-phase supply of a 3-phase rectifier. i_A is periodic at 360° intervals. The plot of i_A consists of the plot of I_1 and the inverse plot of I_4 . A graph sheet is provided on page 21 for practice.

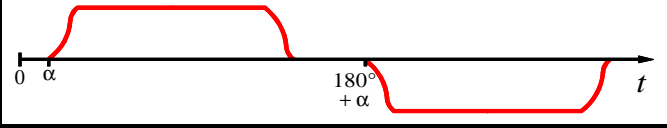

INFLUENCE OF TRANSFORMER TYPE ON i_A WAVEFORM

i_A is the current through the A-phase supply of a 3-phase rectifier.

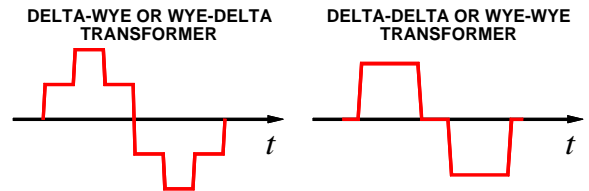

3-PHASE THÈVENIN EQUIVALENT

The Thèvenin equivalent for a 3-phase full wave bridge rectifier.

$$V_{TH} = \frac{3V_{LLp}}{\pi}$$

$$R_{TH} = \frac{3\omega L_s}{\pi}$$

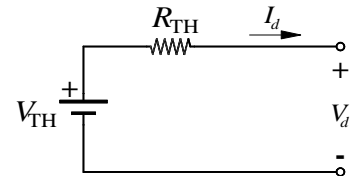

V_{LLp} = peak line-to-line voltage [V]
 ω = the supply frequency [rad./sec.]
 L_s = the supply inductance [H]
 I_d = the (constant) load current [A]
 V_d = the average output voltage [V]

3-PHASE THÈVENIN EQUIVALENT (with α)

The Thèvenin equivalent for a 3-phase full wave bridge rectifier.

$$V_{TH} = \frac{3V_{LLp}}{\pi} \cos \alpha$$

$$R_{TH} = \frac{3\omega L_s}{\pi}$$

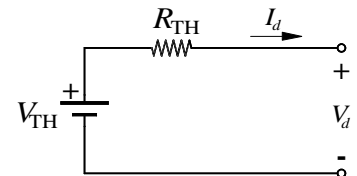

V_{LLp} = peak line-to-line voltage [V]
 ω = the supply frequency [rad./sec.]
 α = the angle ωt at which the thyristor is triggered [degrees]
 L_s = the supply inductance [H]
 I_d = the (constant) load current [A]
 V_d = the average output voltage [V]

PF POWER FACTOR IN A 3-PHASE RECTIFIER

$$PF = \frac{\overbrace{P_{avg}}^{\text{in all 3 phases}}}{3V_{LN rms} \underbrace{I_{L rms}}_{\text{current in each line}}}$$

The term $3/\pi$ below is the reduction in power factor due to the current I_d not being a sine wave.

$$PF = \frac{\sqrt{3}}{\pi\sqrt{2}} \frac{I_d}{I_{L rms}} [\cos \alpha + \cos(\alpha + u)]$$

$$= \frac{3}{\pi} \left[\frac{\cos \alpha + \cos(\alpha + u)}{2} \right]$$

DC-DC CONVERTERS

D DUTY CYCLE

The duty cycle is the fractional portion of the period T in which the inductor is charging. Practical values for D range from about 0.2 to 0.8. The plot below shows discontinuous operation; i.e. there is a period of time when the inductor is neither charging nor discharging.

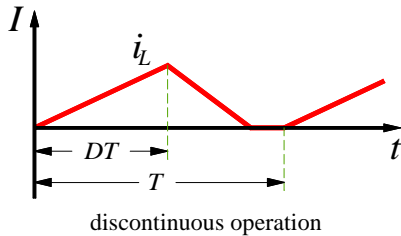

It is preferable that the converter operate in continuous mode in order to reduce ripple.

L MINIMUM INDUCTANCE REQUIREMENT

For continuous operation, the inductor should be sized so that under minimum current conditions it does not fully discharge before reaching the end of the period T .

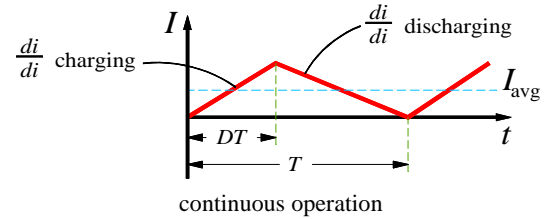

In the plot above, the inductor discharges fully just as the period ends. In this case, $2I_{avg}$ is the peak current. So the peak current is both the product of the charging slope and the charging interval as well as of the discharging slope (absolute) and discharging interval.

$$\frac{di_{chg.}}{dt} DT = \frac{di_{dischg.}}{dt} (1-D)T = 2I_{avg}$$

The values for di/dt are found by using Kirchoff's Voltage Law for both the "on" and "off" states.

STEP-DOWN CONVERTER

The step-down converter or **buck converter** can produce an output voltage as much as ~80% below the input voltage.

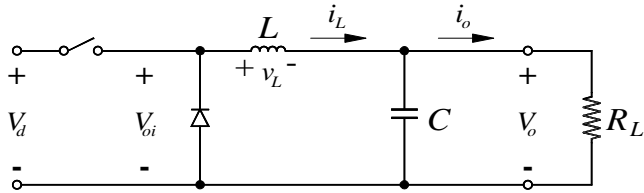

Duty Cycle: $D = \frac{V_o}{V_d}$

Minimum inductance: In choosing L , We want to avoid discontinuous operation. Select L_{min} using the minimum expected current I_L .

$$L_{min} = \frac{V_o}{2I_L}(1-D)T \quad \Delta I_L = \frac{V_d - V_o}{L}DT$$

Ripple voltage: When choosing C , we want $RC \gg T$. Another consideration is the ripple voltage. For continuous operation this is

$$\Delta V_o = \frac{V_o T^2 (1-D)}{8LC}$$

Minimum Capacitance: The expressions for finding the value of the filter capacitor are derived from the relation $\Delta V = \Delta Q/C$, where Q is current x time.

$$C = \frac{\Delta I_L T}{8\Delta V_o}$$

D = duty cycle [no units]

V_o = output voltage (average) [V]

ΔV_o = output ripple voltage (peak to peak) [V]

V_d = input voltage [V]

T = period $1/f$ [s]

L_{min} = minimum inductance for continuous operation [H]

ΔI_L = the difference between the maximum and minimum current in the inductor. For continuous operation, this is twice the average load current. [A]

L = inductance [H]

C = capacitance [F]

STEP-UP (BOOST) CONVERTER

The step-up converter produces an output voltage up to ~5X the input voltage.

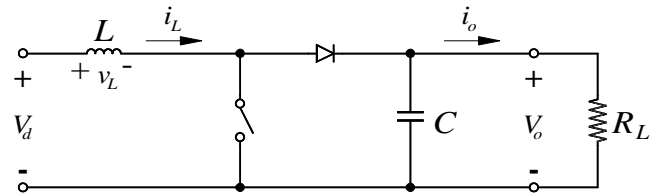

Duty Cycle: $D = \frac{V_o - V_d}{V_o}$

Minimum inductance: $L_{min} = \frac{TV_o}{2I_o}D(1-D)^2$

Ripple voltage: $\Delta V_o = \frac{V_o DT}{R_L C}$

Minimum capacitance: $C = \frac{V_{out} DT}{\Delta V_o R_L}$

BUCK-BOOST CONVERTER 1

The buck-boost converter provides a reversed polarity output and enables the output voltage to be above or below the input voltage.

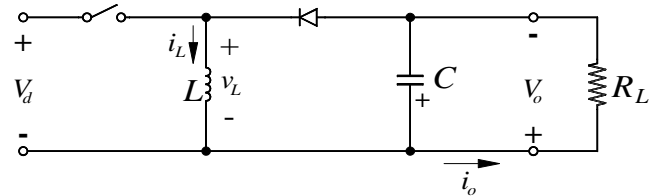

Duty Cycle: $D = \frac{V_o}{V_o + V_d}$

Minimum inductance:

$$L_{min} = \frac{TV_o}{2I_o}(1-D)^2 = \frac{TV_o}{2I_L}(1-D)$$

Ripple voltage: $\Delta V_o = \frac{V_o DT}{R_L C}$

V_d = supply voltage [V]

V_o = average output voltage [V]

I_L = average current through the inductor [A]

I_o = average output current [A]

BUCK-BOOST CONVERTER 2

This version was given to us by Dr. Grady.

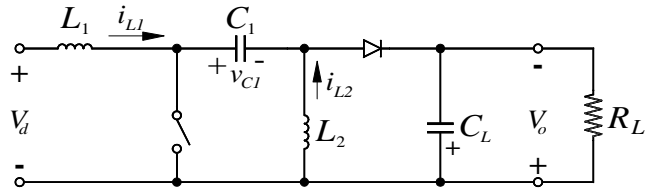

Duty Cycle: $D = \frac{V_o}{V_o + V_d}$, assuming $v_{c1} = V_d$

CÚK CONVERTER

The Cúk converter also provides a reversed polarity output. Capacitor C_1 is the primary storage device for transferring energy from input to output. The advantage of this circuit is its low input and output ripple currents; the disadvantage is the requirement of the large capacitor C_1 .

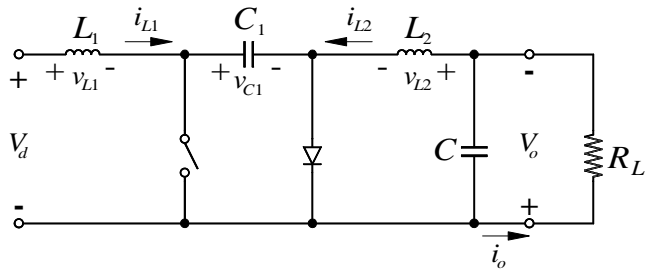

Duty Cycle: $D = \frac{V_o}{V_o + V_d}$

FULL BRIDGE CONVERTER

The full bridge converter has the additional capabilities of reverse current flow, e.g. a motor connected to the load could generate a current flow back to the source, and reversible output polarity.

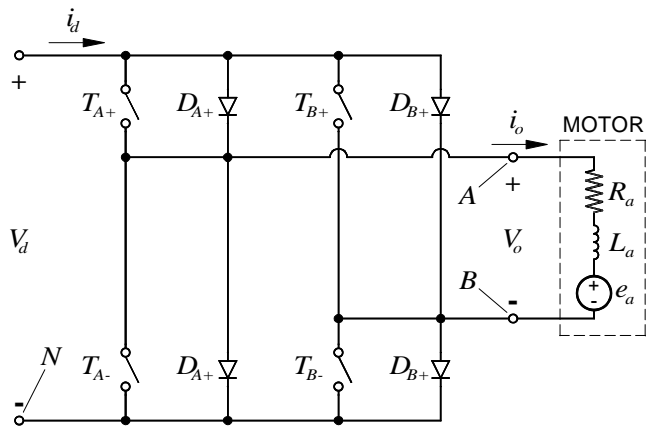

DC-AC INVERTERS

SINGLE-PHASE, FULL-BRIDGE, SQUARE-WAVE INVERTER

For a square-wave inverter operating an induction motor with inductance L :

Square wave function (Fourier series):

$$v(t) = \frac{4V_{dc}}{\pi} \left[\sin \omega_0 t + \frac{1}{3} \sin 3\omega_0 t + \frac{1}{5} \sin 5\omega_0 t + \dots \right]$$

Peak value, fundamental waveform: $v_{1rms} \sqrt{2} = \frac{4V_{dc}}{\pi}$

Ripple voltage: $v_{ripple}(t) = v_{o0} - v_{o1}(t)$

where $v_{o1} = \frac{4V_{dc}}{\pi} \sin \omega_0 t$ is the fundamental waveform

and v_{o0} is the square wave.

Ripple current: $i_{ripple}(t) = \frac{1}{L} \int_0^t v_{ripple}(\tau) d\tau$

$$i_{ripple\ peak} = \frac{1}{2} i_{ripple}(t), \text{ at } t = \frac{\pi}{\omega}$$

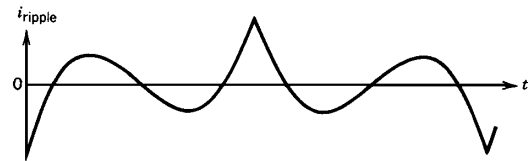
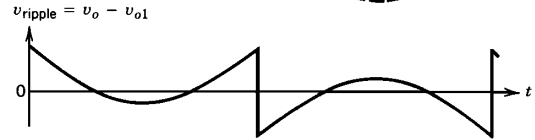
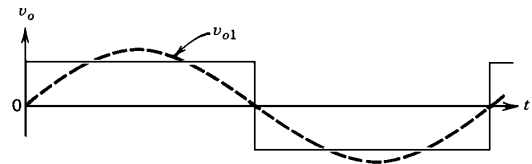

SINGLE-PHASE, PULSE WIDTH MODULATED, BIPOLAR INVERTER

This requires the introduction of two new terms, m_f and m_a . Refer to the next two boxes.

Peak value, fundamental waveform: $v_{1rms} \sqrt{2} = m_a V_{dc}$

k^{th} harmonic: $\frac{v_{1rms}}{m_a} (\text{value from table}) = v_{krms}$

using the table for Generalized Harmonics on page 13.

Ripple current: $i_{ripple\ peak} = \frac{v_{1rms} \sqrt{2}}{\omega_0 L} \sum_{k>1} \frac{v_{krms}}{k} ???$

m_f FREQUENCY MODULATION RATIO

The ratio of the switching frequency to the modulating control frequency in an inverter circuit.

$$m_f = \frac{f_s}{f_1}$$

When m_f is small ($m_f \leq 21$) it should be an odd integer in order to avoid subharmonics. In the figure below, $m_f = 15$. Note the symmetry of the triangle wave and control signal. This is called *synchronous pulse width modulation*.

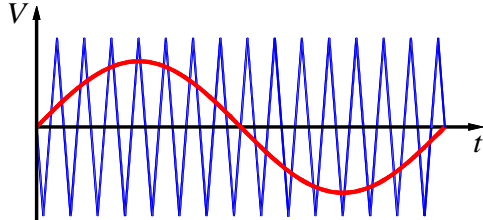

f_s = switching frequency [rad./s or Hz]

f_1 = control frequency or modulating frequency [rad./s or Hz]

m_a AMPLITUDE MODULATION RATIO

The ratio of the control signal amplitude to the triangle wave amplitude in an inverter circuit.

$$m_a = \frac{\hat{V}_{\text{control}}}{\hat{V}_{\text{tri}}}$$

When $m_a < 1$, the inverter is operating in the *linear range* as shown in the figure below. When in the linear range, the frequency harmonics are in the area of the switching frequency and its multiples. A drawback is that the maximum available amplitude of the fundamental frequency is limited due to the notches in the output waveform (see the next box).

When $m_a \geq 1$, the inverter is in *overmodulation*. This causes more side harmonics in the output waveform.

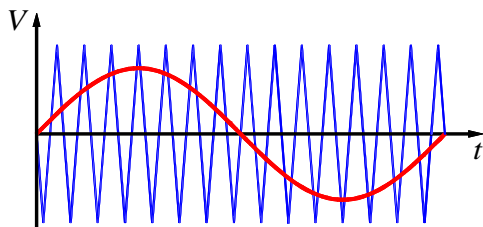

\hat{V}_{control} = peak amplitude of the control signal. The signal has a frequency of f_1 [V]

\hat{V}_{tri} = peak amplitude of the triangle wave [V]

PULSE WIDTH MODULATION IN BIPOLAR INVERTERS

The relationship between the triangle wave, the control waveform, and the output waveform for an inverter operating in the linear range is shown below. The square wave output can be produced using a comparator to compare the triangle wave with the sine wave.

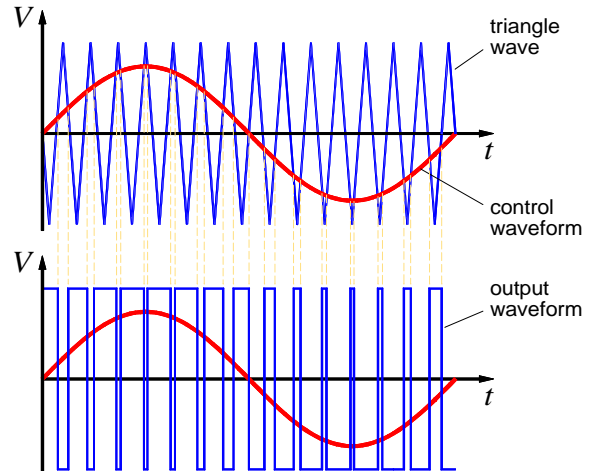

PULSE WIDTH MODULATION IN UNIPOLAR INVERTERS

The relationship between the triangle wave, the control waveform, and the output waveform for a unipolar inverter operating in the linear range is shown below. The square wave output can be produced using a comparator to compare the triangle wave with the sine wave.

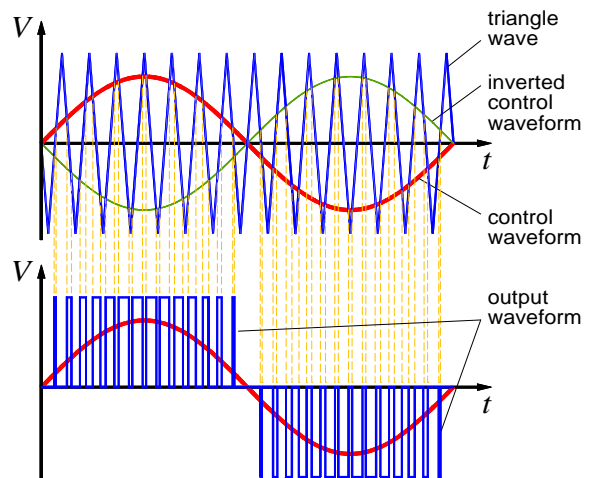

$v_{h \text{ rms}}$ RMS HARMONIC VOLTAGE

The magnitude of the fundamental frequency and major harmonics for single-phase PWM inverters may be calculated using the following formula and values from the Generalized Harmonics table in the next box. It is assumed that m_f is an odd integer greater than or equal to 9.

Half-bridge or one-leg, single-phase:

$$v_{h \text{ rms}} \sqrt{2} = \frac{1}{2} V_{\text{dc}} \underbrace{(\text{GH}_h)}_{\text{value from table}}$$

Full bridge, single-phase:

$$v_{h \text{ rms}} \sqrt{2} = V_{\text{dc}} \underbrace{(\text{GH}_h)}_{\text{value from table}} \text{ or}$$

$$v_{h \text{ rms}} = v_{1 \text{ rms}} \frac{(\text{GH}_h)}{(\text{GH}_{h=1})}$$

m_f = frequency modulation ratio, the ratio of the triangle wave frequency to the control waveform frequency [no units]

h = the harmonic (integer)

V_{dc} = dc supply voltage [V]

(GH_h) = value from the generalized harmonics table for the h^{th} harmonic

$(\text{GH}_{h=1})$ = value from the generalized harmonics table for the $h = 1$ (fundamental) harmonic. In the case of single-phase, this is the same as m_a .

GENERALIZED HARMONICS IN SINGLE-PHASE PWM INVERTERS

The values in the generalized harmonics table are the ratio of the peak-to-peak harmonic voltages to the dc voltage. It is assumed that m_f is an odd integer greater than or equal to 9. See previous box.

h	m_a :				
	0.2	0.4	0.6	0.8	1.0
1	0.2	0.4	0.6	0.8	1.0
m_f	1.242	1.15	1.006	0.818	0.601
$m_f \pm 2$	0.016	0.061	0.131	0.220	0.318
$m_f \pm 4$					0.018
$2m_f \pm 1$	0.190	0.326	0.370	0.314	0.181
$2m_f \pm 3$		0.024	0.071	0.139	0.212
$2m_f \pm 5$				0.013	0.033
$3m_f$	0.335	0.123	0.083	0.171	0.113
$3m_f \pm 2$	0.044	0.139	0.203	0.176	0.062
$3m_f \pm 4$		0.012	0.047	0.104	0.157
$3m_f \pm 6$				0.016	0.044
$4m_f \pm 1$	0.163	0.157	0.008	0.105	0.068
$4m_f \pm 3$	0.012	0.070	0.132	0.115	0.009
$4m_f \pm 5$			0.034	0.084	0.119
$4m_f \pm 7$				0.017	0.050

THREE-PHASE, SQUARE WAVE INVERTER

DC-AC voltage relationship:
$$v_{LL1 \text{ rms}} \frac{\sqrt{2}}{\sqrt{3}} = \frac{4V_{dc}}{2\pi}$$

Inverter voltage:

$$v_{AN} = \frac{4V_{dc}}{2\pi} \left[\sin \omega_0 t + \frac{1}{3} \sin 3\omega_0 t + \frac{1}{5} \sin 5\omega_0 t + \dots \right] + \underbrace{\frac{2}{2}}_{\text{dc offset}} V_{dc}$$

(The factor of 2 in the amplitude is due to the dc voltage being only positive.)

Motor neutral (fictional) to system neutral voltage:

$$v_{nN} = \frac{4V_{dc}}{2\pi} \left[\frac{1}{3} \sin 3\omega_0 t + \frac{1}{6} \sin 6\omega_0 t + \frac{1}{9} \sin 9\omega_0 t + \dots \right] + \underbrace{\frac{2}{2}}_{\text{dc offset}} V_{dc}$$

Voltage, system to motor neutral (fictional):

$$v_{An} = \frac{4V_{dc}}{2\pi} \left[\sin \omega_0 t + \frac{1}{5} \sin 5\omega_0 t + \frac{1}{7} \sin 7\omega_0 t + \dots \right]$$

Current, line-to-neutral:

$$i(t) = \frac{2V_{dc}}{\pi L} \int \left[\sin \omega_0 t + \frac{1}{5} \sin 5\omega_0 t + \frac{1}{7} \sin 7\omega_0 t + \dots \right] dt$$

$$= \frac{-2V_{dc}}{\pi \omega_0 L} \left[\cos \omega_0 t + \frac{1}{5^2} \cos 5\omega_0 t + \frac{1}{7^2} \cos 7\omega_0 t + \dots \right]$$

Ripple current, composed of the harmonics—all peak simultaneously:

$$i_{\text{ripple peak}} = \frac{2V_{dc}}{\pi \omega_0 L} \left[\frac{1}{5^2} + \frac{1}{7^2} + \frac{1}{11^2} + \dots \right]$$

This series can be created from other series:

$$1) 1 + \frac{1}{3^2} + \frac{1}{5^2} + \frac{1}{7^2} + \dots = \frac{\pi^2}{8}$$

$$2) \frac{1}{3^2} \left(1 + \frac{1}{3^2} + \frac{1}{5^2} + \frac{1}{7^2} + \dots \right) = \frac{1}{3^2} \left(\frac{\pi^2}{8} \right)$$

1) - 2) =

$$1 + \frac{1}{5^2} + \frac{1}{7^2} + \frac{1}{11^2} + \dots = \left(1 - \frac{1}{3^2} \right) \left(\frac{\pi^2}{8} \right) = \frac{\pi^2}{3^2}$$

so that $\frac{1}{5^2} + \frac{1}{7^2} + \frac{1}{11^2} + \dots = \frac{\pi^2}{9} - 1$

and
$$i_{\text{ripple peak}} = \frac{2V_{dc}}{\pi \omega_0 L} \left(\frac{\pi^2}{9} - 1 \right)$$

THREE-PHASE PWM INVERTER

The relationship between the fundamental of the line-to-line rms output voltage and the dc input voltage is

$$v_{LL1 \text{ rms}} \frac{\sqrt{2}}{\sqrt{3}} = \frac{1}{2} m_a V_{dc}$$

To find the rms values of the harmonic components

$$v_{h \text{ rms}} = \frac{v_{LL1 \text{ rms}} (GH_h)}{\sqrt{3} (GH_{h=1})}$$

$v_{LL1 \text{ rms}}$ = the line-to-line rms voltage of the fundamental harmonic [V]

m_a = amplitude modulation ratio, the ratio of the control waveform to the triangle wave [no units]

h = the harmonic (integer)

$v_{h \text{ rms}}$ = the rms voltage of the h^{th} harmonic [V]

(GH_h) = value from the generalized harmonics table for the h^{th} harmonic

$(GH_{h=1})$ = value from the generalized harmonics table for the $h = 1$ (fundamental) harmonic

GENERALIZED HARMONICS IN THREE PHASE PWM INVERTERS

The values in the generalized harmonics table are the ratio of the line-to-line harmonic voltages to the dc voltage. It is assumed that m_f is a large odd integer and a multiple of 3. See previous box.

h	m_a :				
	0.2	0.4	0.6	0.8	1.0
1	0.122	0.245	0.367	0.490	0.612
$m_f \pm 2$	0.010	0.037	0.080	0.135	0.195
$m_f \pm 4$				0.005	0.011
$2m_f \pm 1$	0.116	0.200	0.227	0.192	0.111
$2m_f \pm 5$				0.008	0.020
$3m_f \pm 2$	0.027	0.085	0.124	0.108	0.038
$3m_f \pm 4$		0.007	0.029	0.064	0.096
$4m_f \pm 1$	0.100	0.096	0.005	0.064	0.042
$4m_f \pm 5$			0.021	0.051	0.073
$4m_f \pm 7$				0.010	0.030

INDUCTION MOTORS

T TORQUE [N·m]

Torque.

$$T_{em} = \frac{3V_s^2 R_r}{s\omega_s \left[\left(R_s + \frac{R_r}{s} \right)^2 + (X_s + X_r)^2 \right]}$$

$$T_{em} = \frac{P_{em}}{\omega_r} \quad T_{em} = \frac{P_{ag}}{\omega_s}$$

For applications such as centrifugal pumps and fans, torque is proportional to the square of the motor speed by some constant of proportionality k_1 .

$$\text{Torque} \approx k_1 (\text{speed})^2$$

P_{em} = electromechanical power [W]

P_{ag} = air gap power, the power crossing the air gap [W]

ω_s = synchronous speed [rad./sec.]

ω_r = rotor speed [rad./sec.]

V_s = line-to-neutral supply voltage [V]

s = slip; the fractional amount of rotational speed lost due to rotor loading and other factors [rad./rad.]

f = rated frequency [Hz]

f_{sl} = slip frequency sf [Hz]

T_{start} STARTING TORQUE [N·m]

A higher torque may be desired for starting. This is accomplished by raising the frequency and increasing the rotor current I_r by an amount proportional to its value at 100% rated torque.

$$f_{start} = \frac{T_{start}}{T_{rated}} f_{sl\,rated} \quad f_{sl\,rated} = sf$$

$$\frac{T_{start}}{T_{rated}} = \frac{I_r}{I_{r\,rated}} \quad T_{start} = \frac{3V_s^2}{s\omega_s}$$

In the design of the induction motor, there is a tradeoff between starting torque (also called *pull out*) and motor efficiency. A higher rotor resistance produces a higher starting torque but hurts the efficiency.

P_{em} = electromechanical power [W]

P_{ag} = air gap power, the power crossing the air gap [W]

ω_s = synchronous speed [rad./sec.]

ω_r = rotor speed [rad./sec.]

V_s = line-to-neutral supply voltage [V]

s = slip; the fractional amount of rotational speed lost due to rotor loading and other factors [rad./rad.]

f = rated frequency [Hz]

f_{sl} = slip frequency sf [Hz]

P POWER [W]

The electromechanical power equals the air gap power minus the power lost in the rotor winding resistance.

$$P_{em} = P_{ag} - P_r = 3 \frac{f - f_{sl}}{f_{sl}} R_r I_r^2$$

$$P_{ag} = 3 \frac{f}{f_{sl}} R_r I_r^2 \quad P_r = 3 R_r I_r^2$$

For applications such as centrifugal pumps and fans, power is proportional to the cube of the motor speed by some constant of proportionality k_2 .

$$\text{Power} \approx k_2 (\text{speed})^3$$

INDUCTION MOTOR MODEL 1

The 3-phase induction motor consists of 3 stationary stator windings arranged 120° apart. The squirrel-cage rotor consists of a stack of insulated laminations with conducting bars inserted through it close to the circumference and electrically connected at the ends.

Per-phase Model

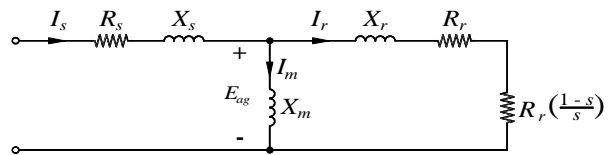

I_s = stator current [A]

R_s = stator resistance [Ω]

X_s = stator reactance [Ω]

I_r = rotor current [A]

R_r = rotor resistance [Ω]

X_r = rotor reactance [Ω]

I_m = magnetizing current [A]

X_m = magnetizing reactance [Ω]

INDUCTION MOTOR MODEL 2

The 3-phase induction motor may also be modeled with a Thèvenin equivalent.

Per-phase Model

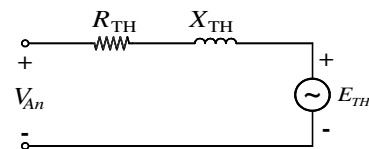

V_{An} = system to motor neutral (fictional) voltage [V]

R_{TH} = Thèvenin equivalent resistance [Ω]

X_{TH} = Thèvenin equivalent reactance [Ω]

E_{TH} = fundamental frequency back-EMF [V]

n_s SYNCHRONOUS SPEED [rpm]

The magnetic field within the motor (air gap flux ϕ_{ag}) rotates at a rate called the *synchronous speed* and is proportional to the frequency of the supply voltage. Under no-load conditions, the *squirrel cage rotor* turns at approximately this speed, and when loaded, at a somewhat slower speed.

$$n_s = 60 \times \frac{\omega_s}{2\pi} = \frac{120}{p} f$$

For example, the n_s of a 2-pole motor operating at 60 Hz is 3600 rpm, for a 4-pole motor, it's 1800 rpm.

n_s = synchronous speed [rpm]

ω_s = synchronous speed [rad./sec.]

f = frequency of the applied voltage [Hz]

p = number of poles in the motor [integer]

s SLIP [rad./rad.]

The difference between the synchronous speed and the rotor speed, normalized to be unitless. The slip can range from near 0 under no-load conditions to 1 at locked rotor. In other words, the slip is the fractional loss of rotation speed experienced by the rotor in relation to the speed of the rotating magnetic field. If the rotor is moving at $\frac{3}{4}$ the speed of the magnetic field, then the slip is $\frac{1}{4}$.

$$s = \frac{\omega_s - \omega_r}{\omega_s}$$

ω_{sl} **Slip Speed:** The difference between the synchronous speed and the rotor speed (unnormalized) is the *slip speed*.

$$\omega_{sl} = \omega_s - \omega_r$$

f_{sl} **Slip Frequency:** Induced voltages in the rotor will be at the *slip frequency*, proportional to the slip

$$f_{sl} = sf$$

ω_s = synchronous speed [rad./sec.]

ω_{sl} = slip speed [rad./sec.]

ω_r = rotor speed [rad./sec.]

f_{ag} AIR GAP FLUX [Wb]

The air gap flux is generated by the magnetizing current I_m and rotates in the air gap between the stator and rotor at the synchronous speed n_s .

$$N_s \phi_{ag} = L_m i_m \quad k_3 \phi_{ag} = \frac{E_{ag}}{f}$$

The ratio of voltage to hertz is generally kept constant in order to maintain the air gap flux constant under varying motor speeds. So the supply voltage and frequency are adjusted to keep E_{ag}/f constant. See the next box, CONSTANT VOLTZ/Hz OPERATION.

N_s = the equivalent number of turns per phase of the stator winding

L_m = magnetizing inductance [H]

i_m = magnetizing current [A]

k_3 = some constant

f = frequency of the applied voltage [Hz]

E_{ag} = air gap voltage, voltage across the magnetizing inductance L_m [V]

CONSTANT VOLTS/Hz OPERATION

For variable frequency motor drives, the air gap flux is generally maintained constant as described in the previous box. This type of operation results in the following properties:

The electromechanical torque is proportional to the slip frequency

$$T_{em} \propto f_{sl}$$

which implies that for **constant torque** operation, the slip is inversely proportional to the synchronous frequency

$$s \propto \frac{1}{f_s}$$

The magnetizing current remains constant

$$I_m = \text{constant}$$

The starting torque is inversely proportional to the synchronous speed

$$T_{start} \propto \frac{1}{\omega_s}$$

The maximum torque is a constant

$$T_{max} = \text{constant}$$

The change in torque with respect to the slip speed is a constant

$$\frac{\partial T_{mech}}{\partial \omega_{sl}} = \text{constant}$$

f_{sl} = slip frequency sf [Hz]

ω_s = synchronous speed [rad./sec.]

ω_{sl} = slip speed [rad./sec.]

T = torque [J/rad.]

s = slip [rad./rad.]

h EFFICIENCY

The efficiency is the power delivered divided by the power supplied.

$$\eta = \frac{P_{mech}}{P_{supplied}} = \frac{R_r \left(\frac{1-s}{s} \right)}{R_s + \frac{R_r}{s}} \bigg|_{s \rightarrow 0} \approx 1 - s$$

R_r = rotor resistance [Ω]

R_s = stator resistance [Ω]

s = slip [rad./rad.]

GENERAL MATHEMATICAL

x + jy COMPLEX NUMBERS

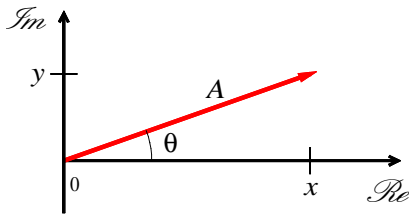

$$x + jy = Ae^{j\theta} = A \cos \theta + jA \sin \theta$$

$$\text{Re}\{x + jy\} = x = A \cos \theta$$

$$\text{Im}\{x + jy\} = y = A \sin \theta$$

$$\text{Magnitude}\{x + jy\} = A = \sqrt{x^2 + y^2}$$

$$\text{Phase}\{x + jy\} = \theta = \tan^{-1} \frac{y}{x}$$

$$j = e^{j\frac{\pi}{2}}$$

The magnitude of a complex number may be written as the absolute value.

$$\text{Magnitude}\{x + jy\} = |x + jy|$$

The square of the magnitude of a complex number is the product of the complex number and its **complex conjugate**. The **complex conjugate** is the expression formed by reversing the signs of the imaginary terms.

$$|x + jy|^2 = (x + jy)(x + jy)^* = (x + jy)(x - jy)$$

PHASOR NOTATION

When the excitation is sinusoidal and under steady-state conditions, we can express a partial derivative in phasor notation, by replacing $\frac{\partial}{\partial t}$ with $j\omega$. For

example, the Telegrapher's equation $\frac{\partial \mathcal{V}}{\partial z} = -L \frac{\partial \mathcal{I}}{\partial t}$

becomes $\frac{\partial V}{\partial z} = -Lj\omega I$. Note that $\mathcal{V}(z, t)$ and

$\mathcal{I}(z, t)$ are functions of position and time (space-time functions) and $V(z)$ and $I(z)$ are functions of position only.

Sine and cosine functions are converted to exponentials in the phasor domain.

Example:

$$\begin{aligned} \vec{\mathcal{E}}(\vec{r}, t) &= 2 \cos(\omega t + 3z) \hat{x} + 4 \sin(\omega t + 3z) \hat{y} \\ &= \text{Re}\{2e^{j3z} e^{j\omega t} \hat{x} + (-j)4e^{j3z} e^{j\omega t} \hat{y}\} \end{aligned}$$

$$\vec{E}(\vec{r}) = 2e^{j3z} \hat{x} - j4e^{j3z} \hat{y}$$

TIME-AVERAGE

When two functions are multiplied, they cannot be converted to the phasor domain and multiplied. Instead, we convert each function to the phasor domain and multiply one by the complex conjugate of the other and divide the result by two. The **complex conjugate** is the expression formed by reversing the signs of the imaginary terms.

For example, the function for power is:

$$P(t) = v(t)i(t) \text{ watts}$$

Time-averaged power is:

$$\langle P(t) \rangle = \frac{1}{T} \int_0^T v(t)i(t) dt \text{ watts}$$

For a single frequency:

$$\langle P(t) \rangle = \frac{1}{2} \text{Re}\{V I^*\} \text{ watts}$$

T = period [s]

V = voltage in the phasor domain [s]

I^* = complex conjugate of the phasor domain current [A]

RMS

rms stands for **root mean square**.

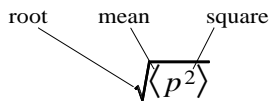

$$f(t)_{\text{rms}} = \sqrt{\langle f(t)^2 \rangle}$$

The plot below shows a sine wave and its rms value, along with the intermediate steps of squaring the sine function and taking the mean value of the square. Notice that for this type of function, the mean value of the square is $\frac{1}{2}$ the peak value of the square.

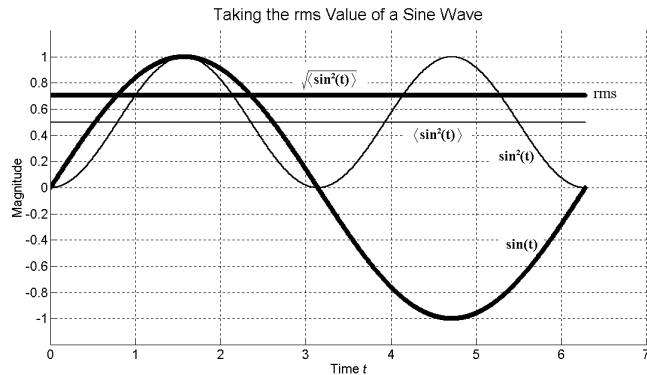

In an electrical circuit, rms terms are associated with heating or power. Given a voltage or current waveform, the rms value is obtained by 1) squaring the waveform, 2) finding the area under the waveform (integrating) over the length of one cycle, 3) dividing by the period, and 4) taking the square root of the result.

$$f(t)_{\text{rms}} = \sqrt{\frac{1}{T} \int_{t_0}^{t_0+T} f^2(t) dt}$$

The rms value differs from the **average** or **dc value** in that the dc value is the average of the original waveform and the rms value is the square root of the average of the square of the waveform.

RMS OF A SQUARE WAVE

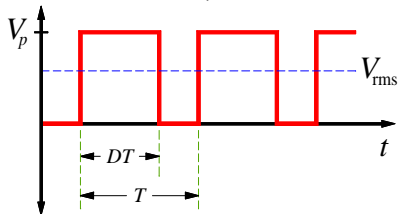

$$V_{\text{rms}} = V_p \sqrt{D}$$

EULER'S EQUATION

$$e^{j\phi} = \cos \phi + j \sin \phi$$

TRIGONOMETRIC IDENTITIES

$$e^{+j\theta} + e^{-j\theta} = 2 \cos \theta \quad e^{+j\theta} - e^{-j\theta} = j2 \sin \theta$$

$$e^{\pm j\theta} = \cos \theta \pm j \sin \theta$$

$$\frac{1}{2} \sin 2\theta = \sin \theta \cos \theta \quad \cos 2\theta = 1 - 2 \sin^2 \theta$$

$$\sin(a \pm b) = \sin a \cos b \pm \cos a \sin b$$

CALCULUS - DERIVATIVES

$$\frac{d}{dx} \frac{u}{v} = \frac{v \cdot u' - u \cdot v'}{v^2} \quad \frac{d}{dx} e^u = u' \cdot e^u$$

$$\frac{d}{dx} a^x = a^x \ln a \quad \frac{d}{dx} a^u = u' \cdot a^x \ln a$$

$$\frac{d}{dx} \ln x = \frac{1}{x} \quad \frac{d}{dx} \ln u = \frac{u'}{u}$$

$$\frac{d}{dx} \sin u = u' \cos u \quad \frac{d}{dx} \cos u = -u' \sin u$$

CALCULUS - INTEGRATION

$$\int dx = x + C \quad \int x^n dx = \frac{x^{n+1}}{n+1} + C$$

$$\int e^u dx = \frac{1}{u'} \cdot e^u + C \quad \int x e^x dx = (x-1)e^x + C$$

$$\int x e^{ax} dx = \frac{e^{ax}}{a^2} (ax-1) + C$$

$$\int \frac{1}{x} dx = \ln|x| + C \quad \int a^x dx = \frac{1}{\ln a} a^x + C$$

$$\int \sin u dx = -\frac{1}{u'} \cos u \quad \int \cos u dx = \frac{1}{u'} \sin u$$

$$\int \sin^2 u du = \frac{1}{2} u - \frac{1}{4} \sin 2u + C$$

$$\int \cos^2 u du = \frac{1}{2} u + \frac{1}{4} \sin 2u + C$$

Integration by parts: $\int u dv = uv - \int v du$

CALCULUS – L'HÔPITAL'S RULE

If the limit of $f(x)/g(x)$ as x approaches c produces the indeterminate form $0/0$, ∞/∞ , or $-\infty/\infty$, then the derivative of both numerator and denominator may be taken

$$\lim_{x \rightarrow c} \frac{f(x)}{g(x)} = \lim_{x \rightarrow c} \frac{f'(x)}{g'(x)}$$

provided the limit on the right exists or is infinite. The derivative may be taken repeatedly provided the numerator and denominator get the same treatment.

To convert a limit to a form on which L'Hôpital's Rule can be used, try algebraic manipulation or try setting y equal to the limit then take the natural log of both sides. The \ln can be placed to the right of \lim . This is manipulated into fractional form so L'Hôpital's Rule can be used, thus getting rid of the \ln . When this limit is found, this is actually the value of $\ln y$ where y is the value we are looking for.

Other indeterminate forms (which might be convertible) are 1^∞ , ∞^0 , 0^0 , $0 \cdot \infty$, and $\infty - \infty$. Note that $0^\infty = 0$

SERIES

$$\sqrt{1+x} \approx 1 + \frac{1}{2}x, \quad |x| \ll 1$$

$$\frac{1}{\sqrt{1+x}} \approx 1 - \frac{x}{2} + \frac{3x^2}{8} - \frac{5x^3}{16} + \frac{35x^4}{128} - \dots, \quad -\frac{1}{2} < x < \frac{1}{2}$$

$$\frac{1}{1-x^2} \approx 1 + x^2 + x^4 + x^6 + \dots, \quad -\frac{1}{2} < x < \frac{1}{2}$$

$$\frac{1}{(1-x)^2} \approx 1 + 2x + 3x^2 + 4x^3 + \dots, \quad -\frac{1}{2} < x < \frac{1}{2}$$

$$\frac{1}{1+x} \approx 1 - x + x^2 - x^3 + \dots, \quad -\frac{1}{2} < x < \frac{1}{2}$$

$$\frac{1}{1-x} \approx 1 + x + x^2 + x^3 + \dots, \quad -\frac{1}{2} < x < \frac{1}{2}$$

BINOMIAL THEOREM

Also called binomial expansion. When m is a positive integer, this is a finite series of $m+1$ terms. When m is not a positive integer, the series converges for $-1 < x < 1$.

$$(1+x)^m = 1 + mx + \frac{m(m-1)}{2!}x^2 + \dots + \frac{m(m-1)(m-2)\dots(m-n+1)}{n!}x^n + \dots$$

SPHERE

$$\text{Area} = \pi d^2 = 4\pi r^2 \quad \text{Volume} = \frac{1}{6} \pi d^3 = \frac{4}{3} \pi r^3$$

HYPERBOLIC FUNCTIONS

$$j \sin \theta = \sinh(j\theta)$$

$$j \cos \theta = \cosh(j\theta)$$

$$j \tan \theta = \tanh(j\theta)$$

LINEARIZING AN EQUATION

Small nonlinear terms are removed. Nonlinear terms include:

- variables raised to a power
- variables multiplied by other variables

Δ values are considered variables, e.g. Δt .

MAXWELL'S EQUATIONS

Maxwell's equations govern the principles of guiding and propagation of electromagnetic energy and provide the foundations of all electromagnetic phenomena and their applications. The time-harmonic expressions can be used only when the wave is sinusoidal.

	STANDARD FORM (Time Domain)	TIME-HARMONIC (Frequency Domain)
Faraday's Law	$\nabla \times \vec{\mathcal{E}} = -\frac{\partial \vec{\mathcal{B}}}{\partial t}$	$\nabla \times \vec{E} = -j\omega \vec{B}$
Ampere's Law*	$\nabla \times \vec{\mathcal{H}} = \vec{\mathcal{J}} + \frac{\partial \vec{\mathcal{D}}}{\partial t}$	$\nabla \times \vec{H} = j\omega \vec{D} + \vec{J}$
Gauss' Law	$\nabla \cdot \vec{\mathcal{D}} = \rho_v$	$\nabla \cdot \vec{D} = \rho_v$
no name law	$\nabla \cdot \vec{\mathcal{B}} = 0$	$\nabla \cdot \vec{B} = 0$

\mathcal{E} = electric field [V/m]

\mathcal{B} = magnetic flux density [Wb/m² or T] $\mathcal{B} = \mu_0 \mathcal{H}$

t = time [s]

\mathcal{D} = electric flux density [C/m²] $\mathcal{D} = \epsilon_0 \mathcal{E}$

ρ = volume charge density [C/m³]

\mathcal{H} = magnetic field intensity [A/m]

\mathcal{J} = current density [A/m²]

*Maxwell added the $\frac{\partial \vec{\mathcal{D}}}{\partial t}$ term to Ampere's Law.

GRAPHING TERMINOLOGY

With x being the horizontal axis and y the vertical, we have a graph of **y versus x** or **y as a function of x**. The x -axis represents the **independent variable** and the y -axis represents the **dependent variable**, so that when a graph is used to illustrate data, the data of regular interval (often this is time) is plotted on the x -axis and the corresponding data is dependent on those values and is plotted on the y -axis.

